

TERRA FLEX

PRODUCT INSTALLATION GUIDE

JK 2.5" Spring Lift

Part # 1251000-1251002
1351000-1351002
1352000-1352002



Important Notes: THIS INSTRUCTION IS FOR MULTIPLE PART NUMBERS. MAKE SURE THAT YOU LOOK AT THE APPROPRIATE PARTS LIST AND INSTRUCTION STEPS.

For part #1251000 & 1251002 go to page 2

For part #1351000 & 1351002 go to page 4

For part #1352000 & 1352002 go to page 6

Prior to beginning this or any installation read these instructions to familiarize yourself with the required steps and evaluate if you are experienced and capable to personally perform these modifications.

Refer to the parts list to ensure that all necessary components and hardware has been included. If any parts are missing please contact your local retailer for assistance.

Required Tools:

10, 14, 15, 16, 17, 18, 19, 21mm sockets and wrenches

7/16", 5/8", 3/4" sockets and wrenches

3/8" & 1/2" drive ratchets

3", 6", & 12" extensions

Ft-lbs torque wrench

Breaker bar

Large crescent wrench

Slip Joint pliers

Power hand drill

3/8" drill bit

Floor jack

Jack stands

Wheel chocks

Hammer

Center punch

Pry bars

Pliers

Tape measure

Safety glasses

Pencil or marker

TERAFLEX

PRODUCT INSTALLATION GUIDE

Part # 1351000- JK 4Door

Part # 1351002- JK 2Door

Lift kit 2.5" spring lift w/ NO SHOCKS



This component list is for the four door and two door JK. Make sure that you are looking at the right product list for your part number. We recommend using TeraFlex, Elka or Teraflex tuned FOX Shocks with this application. Check the shock length chart on page 8 if you would like to use another shock. DO NOT USE A SHOCK WITH A LONGER EXTENDED Length. This will cause damage to critical items such as brake lines and drive lines.

1351000-JK4

1351002-JK2

Lift Kit 2.5" w/ NO SHOCKS

Component item ID	Item Name	QTY
135100	JK 2.5" Lift kit spring box	
754500	Sway bar link	2
953800	Bumpstop JK front upper	2
1853100-JK4 1853050-JK2	Coil Spring Front JK 2.5"	2
1854100-JK4 1854050-JK2	Coil Spring Rear JK 2.5"	2
954776	2.5" Axle Trackbar braket	1
97732	U-bolt	1
600513	Spacer	1
954700	Bumpstop Kit	2
600276	Brake line drop braket rear	2
600270	Rear spring retainer	2
600271	Retainer nut tool	1
5012	Hardware	
85	Nut 3/8-16 flange	2
98	Bolt 3/8-16x1	2
123	3/8 lock washer	2
5018	Hardware	
76	Nut 1/4-28 nylock	2
77	Bolt 1/4-28x.75	2
458	1/4 washer	4
5019	Hardware	
38	5/16 washer	8
153	Bolt 5/16-18x1.25	4
632	Nut 5/16-18	4
5029	Hardware	
37	1/2 washer	4
214	Nut 1/2-13	1
215	Nut 1/2-20	2
242	Bolt 1/2-13x3.5	1

TERAFLEX

PRODUCT INSTALLATION GUIDE

Part # 1251000- JK 4Door

Part # 1251002- JK 2Door

Lift kit 2.5" spring lift WITH SHOCKS



This component list is for the four door and two door JK. Make sure that you are looking at the right product list for your part number.

1251000-JK4

1251002-JK2

Lift Kit 2.5" w/ SHOCKS

Component item ID	Item Name	QTY
135100	JK 2.5" Lift kit spring box	
754500	Sway bar link	2
953800	Bumpstop JK front upper	2
1853100-JK4 1853050-JK2	Coil Spring Front JK 2.5"	2
1854100-JK4 1854050-JK2	Coil Spring Rear JK 2.5"	2
954776	2.5" Axle Trackbar braket	1
97732	U-bolt	1
600513	Spacer	1
954700	Bumpstop Kit	2
600276	Brake line drop braket rear	2
600270	Rear spring retainer	2
600271	Retainer nut tool	1
553200	Front shock JK	2
554200	Rear Shock JK	2
5012	Hardware	
85	Nut 3/8-16 flange	2
98	Bolt 3/8-16x1	2
123	3/8 lock washer	2
5018	Hardware	
76	Nut 1/4-28 nylock	2
77	Bolt 1/4-28x.75	2
458	1/4 washer	4
5019	Hardware	
38	5/16 washer	8
153	Bolt 5/16-18x1.25	4
632	Nut 5/16-18	4
5029	Hardware	
37	1/2 washer	4
214	Nut 1/2-13	1
215	Nut 1/2-20	2
242	Bolt 1/2-13x3.5	1

TERAFLEX

PRODUCT INSTALLATION GUIDE

Part # 1352000- JK 4Door

Part # 1352002- JK 2Door

Lift kit 2.5” spring lift WITH SHOCK ADAPTERS



This component list is for the four door and two door JK. Make sure that you are looking at the right product list for your part number.

We recommend using TeraFlex, Elka or Teraflex tuned FOX Shocks with this application. Check the shock length chart on page 8 if you would like to use another shock. DO NOT USE A SHOCK WITH A LONGER EXTENDED Length. This will cause damage to critical items such as brake lines and drive lines.

1352000-JK4 1352002-JK2	Lift kit 2.5" spring lift W/ SHOCK ADAPTERS	
Component item ID	Item Name	Qty Per Assembly
7545 00	3"-4" JK sway bar link	2
953800	Bumpstop JK Front Upper	2
1853100-JK4 1853050-JK2	Coil Spring Front JK 2.5"	2
1854100-JK4 1854050-JK2	Coil Spring Rear JK 2.5"	2
1954105	Spacer Rear JK 1/2"	2
954202	Track bar drop bracket rear 2.5"	1
954700	Bumpstop kit	2
600276	Brake drop bracket Rear	2
600270	Rear spring retainer JK	2
600271	Retainer nut tool	1
102	Track bar bracket sleeve spacer	1
554801	Front shock JK	2
554802	Rear shock JK	2
319	Washer shock ext. 1.75x.675x1.25	2
553800	Front shock extension	2
5012	Nut and Bolt bag #1	
85	Nut 3/8"-16 Flange	2
98	Bolt 3/8"-16 x 1"	2
123	Lock washer 3/8"	2
5018	Nut and bolt bag #2	
76	Nut 1/4-28 nylock	2
77	Bolt 1/4-28 x .75	2
458	Flat washer 1/4	4
5019	Nut and bolt bag #3	
38	Flat washer 5/16	8
153	Bolt 5/16-18 x 1.25	4
632	Stover nut 5/16 x 18	4
5022	Nut and bolt bag #5	
38	Flat washer 5/16	4
84	Flat washer 3/8	8
152	Bolt 5/16-18 x 1"	2
158	Bolt 10mm 1.5 x 90mm	4
632	Stover nut 5/16 x 18	2
5114	Nut and bolt bag #6	
62	Bolt 9/16-18 x 3" long	1
83	Nut 3/8-16 stover lock nut	1
84	Flat washer 3/8	2
98	Bolt 3/8-16 x 1"	1
276	Stover nut 9/16-18	1
318	Flat washer 9/16	2

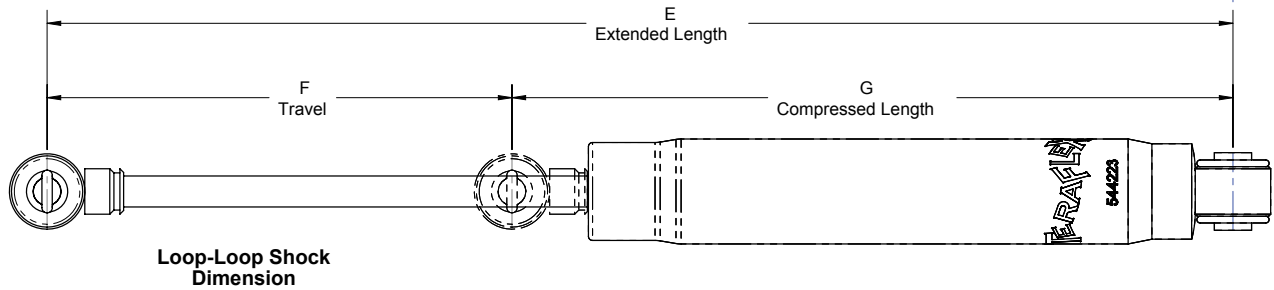
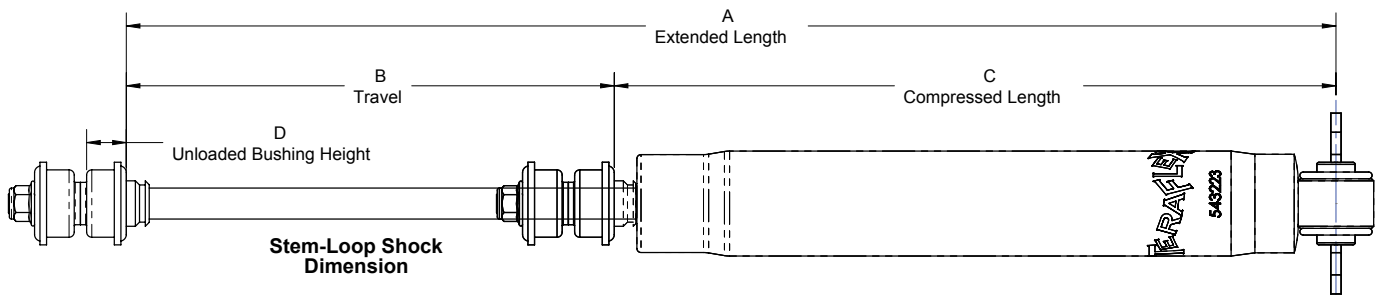

Shock Application Information					Front — Stem-Loop				Rear — Loop-Loop		
JK	Front Part Number	Rear Part Number	Vehicle Lift	Shock Manufacture	A	B	C	D	E	F	G
					Extended Length (in)	Travel (in)	Compressed Length (in)	Unloaded Bushing Height (in)	Extended Length (in)	Travel (in)	Compressed Length (in)
Wrangler 2007- Current	1553100	1554100	JK with 2.5" of Lift	TeraFlex	24.880	9.470	15.410	0.750	24.990	9.360	15.630
	1460125	1400125	JK with 2.5" of Lift	ELKA	24.800	9.409	15.389	0.850	25.000	9.530	15.470
	1553200	1554200	JK with 3-4" of Lift	TeraFlex	26.880	10.380	16.500	0.750	28.090	10.840	17.250
	1982820	1982819	JK with 2.5-4" of Lift	FOX	26.400	10.900	15.500	0.696	27.650	11.200	16.450

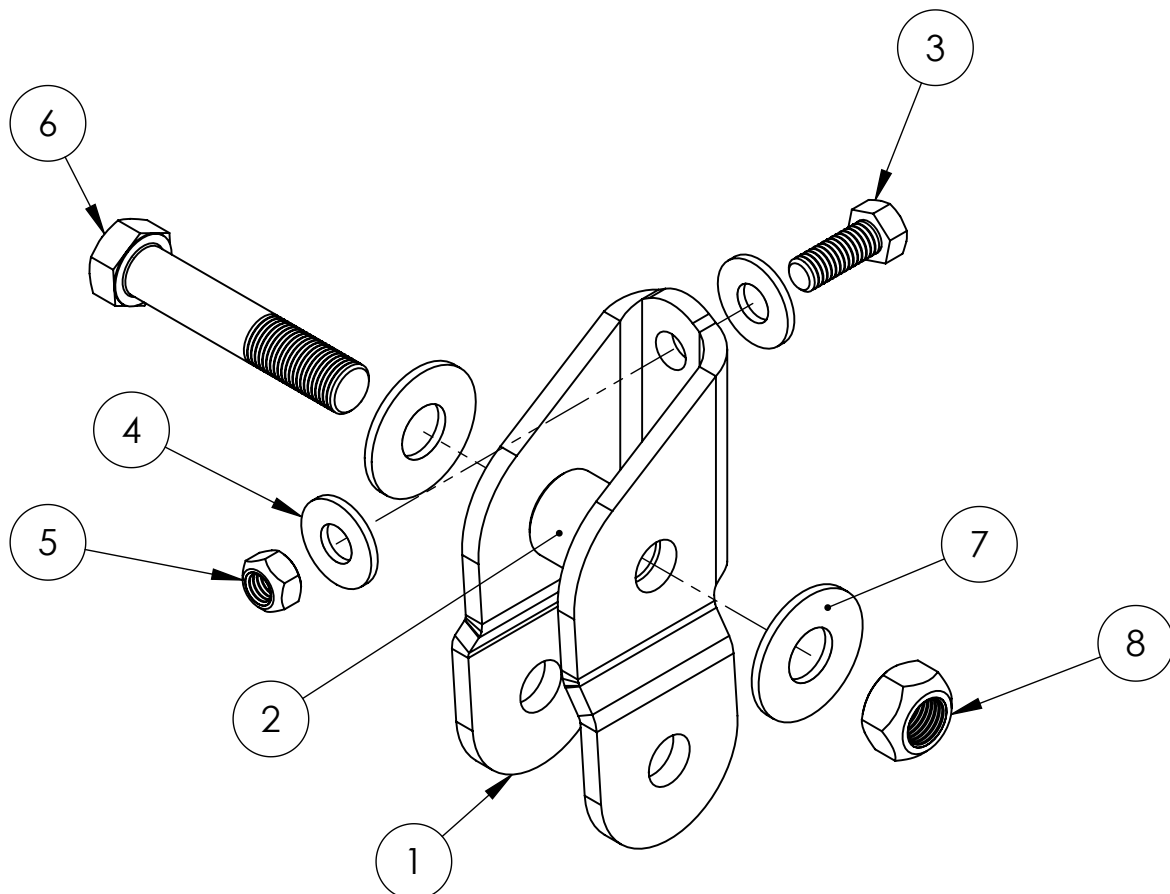

1954202
 JK REAR TRACKBAR BRACKET KIT FOR 2"-3" OF LIFT

Installation:

1. Remove track bar bolts using a 21mm socket, at both the front and rear axle and remove track bars.



2. Loosen all control arm bolts using a 21mm socket, DO NOT REMOVE ARMS OR BOLTS!
3. Lift the vehicle and support under the frame with jack stands. Make sure that the axle will drop far enough to remove and install the coil springs.
4. Remove the wheels.

Rear Installation:

5. Support the rear axle with a jack and slightly. Lift one or two inches so that it is easy to remove the bolts from the shocks and sway bar links. (If you remove the nut from the bolt prior to jacking up on the axle you can put slight pressure on the bolt with your hand while jacking the axle and see where it is easiest to remove the bolts.)
6. Remove shocks using an 18mm socket and wrench for the axle side bolt and a 16mm socket for frame side.



7. Remove sway bar links using an 18mm socket and wrench, make sure to put aside for use in the front of the vehicle.



8. Remove the clips that secure the ABS wiring harness to the upper control arm mount.

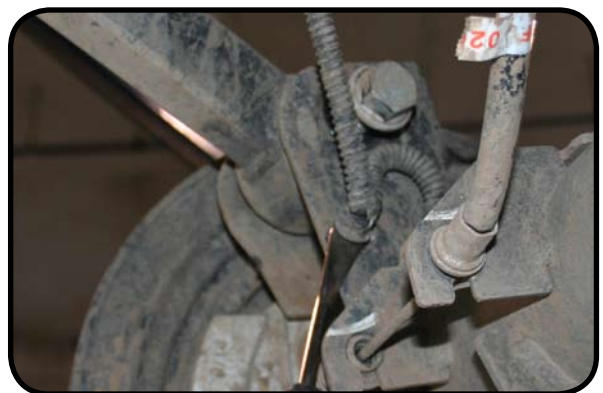

9. Disconnect the brake line bracket at the frame using a 10mm socket. **DO NOT DISCONNECT THE BRAKE LINES FROM THE CALIPERS.**

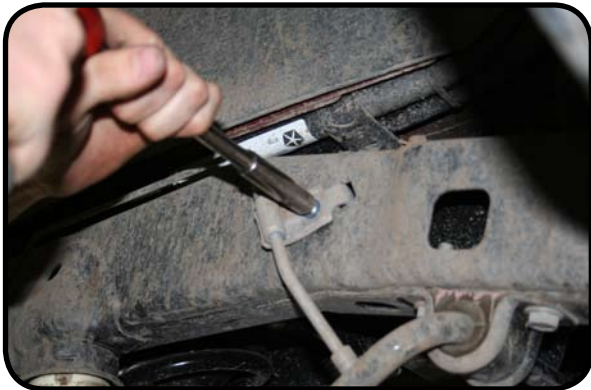

10. Remove and discard the bracket that holds the park brake cables to the body using a 10mm deep well socket.



11. Carefully lower the rear axle far enough to remove the rear springs. Be careful not to let the coils fall out as you lower the axle. Lower the axle far enough to install the new 2.5" springs in place. While lowering the axle make

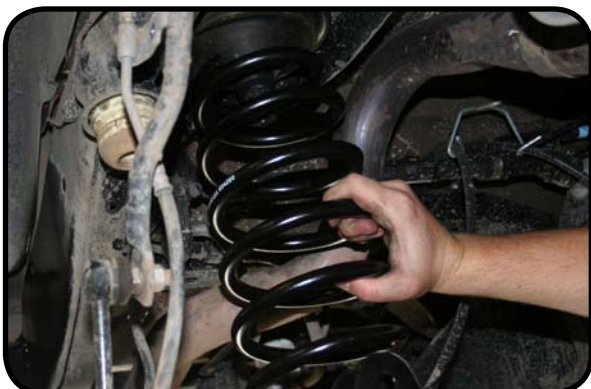

For Kits 1352000-1352002 w/ shock adapters do steps 12-13

12. Install new rear track bar drop bracket. Use the template in the instructions to mark and drill the 3/8" hole needed for proper installation.



13. Install your new track bar drop bracket using the 14mm bolt, washer, and nut. Place the sleeve provided inside the bracket to prevent crushing the bracket. Install track bar in the new bracket. Torque outside bolt to 45 ft-lbs and bolt with sleeve to 125 ft-lbs. Do not torque the track bar until the vehicle is on the ground. (In some cases the new bracket will not fit in the factory bracket. In this case use a pry bar or crescent wrench to spread the bracket so the new drop bracket aligns perfectly with the factory track bar hole. **DO NOT DRILL OUT HOLE TO MAKE FIT.** This can cause slop in the bracket and be heard as a popping sound.



For Kits 1251000-1251002, 1351000-1351002 with and without shocks do step 14.

14. Install the new rear track bar bracket by removing the lower control arm bolt. Place the bracket into place, reinstall the control arm bolt. Install the supplied bolt and sleeve into the factory track bar location. Using the supplied u-bolt and nuts install the u-bolt around the axle tube. Torque the u-bolt nuts to 85 ft-lbs and the supplied bolt to 75 ft-lbs.

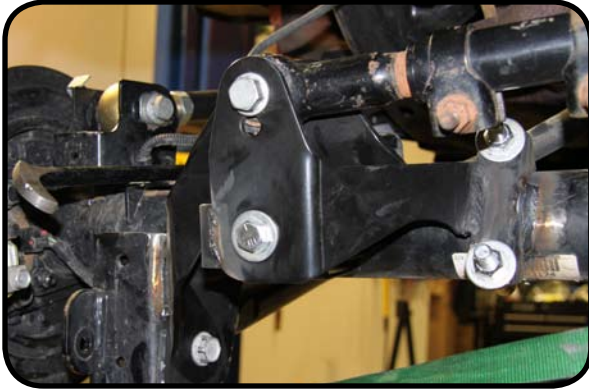

15. Install the factory isolator on the new spring. Install the rear springs.



16. Install the new rear coil spring retainers on the bottom end of the coil springs. First insert the flanged nut into the provided wrench tool, insert the bolt with the lock washer on top of the flat plate, into the rear lower spring retainer. Holding the flange nut in place using the provided wrench tool and begin tightening the bolt using a 1/2" socket or wrench. Remove wrench when finished.



17. Install new rear sway bar links on the outside of the sway bar and the outside of the axle bracket. Use the factory bolt on the axle side with the nut on the outside so excess threads will not interfere with the shock. Use the provided 1/2" x 20 nut and washer for the top side with the 12mm nut and washer on the inside to give the most possible room for tire clearance. Torque to 75 ft-lbs.



18. Install new rear bump stop spacer by placing the spacer on the axle pad lining up both holes with the overhang part of the pad facing forward. Use the provided 5/16" x 1 1/4" bolts with 5/16" washers and 5/16" nuts. Tighten with 1/2" wrenches.



19. Install shocks. If shock adapters are included in your kit, install shock adapters and shocks. Note: The shock adapters are different from left to right. Make sure you are installing the correct one. There are two 10mm X 90mm and one 5/16" X 1" bolts for each side. Use the 5/16 X 1" bolt to align the adapter in its proper location leave loose. Start one of the 10mm x 90mm bolts a few threads then slide shock bar pin around bolt and install the other bolt using a 16mm socket. Use a 1/2" wrench to tighten the small bolt. Torque the top shock bolts to 37 ft-lbs, and the bottom bolt to 56 ft-lbs.



20. Install rear brake line extensions provided in the kit. Bolt the bracket to the factory brake line bracket by removing the 10mm bolt and installing the bracket in that location with the bend of the bracket going flush with the frame. NOT STICKING OUT AWAY FROM THE FRAME. Torque to 14 ft-lbs. (If bracket gets installed the wrong way it will rub on your tires) Then use the supplied hardware to attach the factory bracket to the drop bracket by using 1/2" socket and wrench.



21. Remove jack from under axle.
22. Rear installation complete.

Front installation:

23. Place jack under the axle and slightly lift the front axle so you can easily remove factory hardware from shocks, sway bar links.
24. Remove the front shocks by using a 18mm wrench and socket at the axle side and a 16mm wrench for the frame side. (If the shock spins with the top nut you can use a 5/8 wrench to hold the shock just below the shock mount. Ratchet wrenches are best for the top nut)



25. Remove sway bar links using 18mm socket and wrench at the axle and 18mm socket and 20mm wrench at the sway bar. Lower the jack enough to remove the springs.



26. Remove front coil springs.
27. Remove the stock yellow bump stop with a pair of channel lock pliers. Using grease, lube the bump stop extension to install it into the spring tower. (You may need a piece of wood or equivalent to put in between the extension and the coil perch and jack up the axle to install extension. Do one side at a time.



28. Use grease to lube the yellow bump stop and install it into the extension.



29. Install new 2.5 inch coil springs. Do the drivers side first.



30. If your kit comes with the shock adapters install the front upper shock adapter by spinning it onto the factory shock using red thread locker . Then install the provided washer then the original rubber bushing with the big hole in it and use the other one on the upper side of the frame and install in the same order it was removed. Torque to 20 ft-lbs on the frame side and 56 ft-lbs on the axle side.



31. Install factory rear sway bar links in the front on the outside of the sway bar and inside of the axle mount. Torque to 75 ft-lbs.
32. Reinstall wheels, torque lug nuts to 95- 115 ft-lbs, Remove jack stands, lower the vehicle onto its own weight, and torque all the control arm bolts. Torque the uppers to 75 ft-lbs and the lowers to 125 ft-lbs.
33. Install the rear track bar. To align the rear track bar to the axle have someone push on the body of the jeep until the bolt hole lines up. Torque to 125 ft-lbs.
34. Install the front track bar. To align the front track bar have someone move the steering wheel until the bolt hole lines up. Torque to 125 ft-lbs.
35. To straighten the steering wheel, loosen the adjuster sleeve on the drag link by using 15mm sockets. Mark the position by making a line across the sleeve and the threads this line will indicate the original position. Looking from the drivers side rotate the adjuster sleeve counter clockwise 3/4 of a turn. This should get your steering wheel close to center. Every vehicle is different so test drive yours and determine if yours needs further adjustment. Once steering wheel is straight torque pinch clamp bolts to 45 ft-lbs.
36. Re-torque all fasteners after 300 miles.



TeraFlex Track Bar Bracket Template

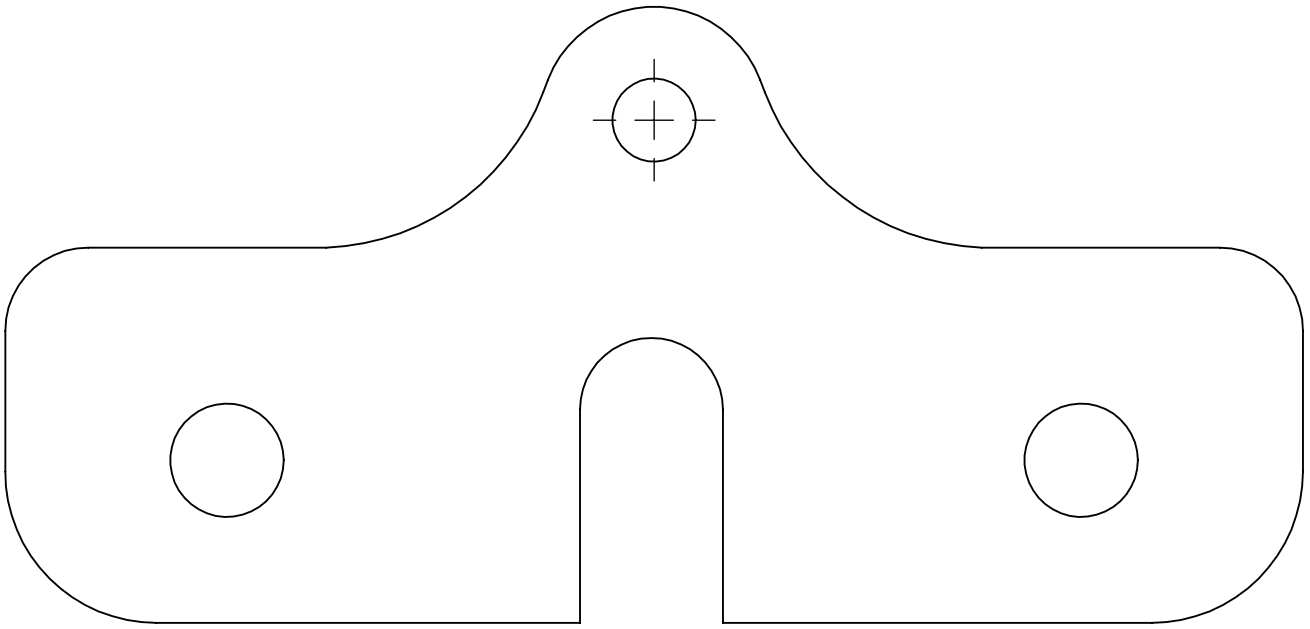

Cut this template out and bolt it on the outside of the factory track bar bracket. Use tape to ensure that the template does not move and center punch the top hole for the new TeraFlex track bar drop bracket.

