



## 2007-2018 Toyota Tundra 4.5 Inch & 6 Inch Lift Kits INSTALLATION INSTRUCTIONS

Engineered for 4WD models Only.

Fits 2007-2018 Toyota Tundra 4WD

**⚠️ NOTE:** Does Not Fit These Tundra Models –  
TRD Pro, Rock Warrior, Or XSP-X Models

**⚠️ NOTE:** Will NOT work on 2016 TRD Pro  
(Bilstein Piggyback Strut) Models



**🚫 CAUTION:** MAKE SURE YOU HAVE THE CORRECT LIFT FOR YOUR VEHICLE:

Double check the Year, Make, Model, Lift Height and KIT Part Numbers.

**⚠️ NOTE:** Prior to beginning the installation, OPEN the Boxes and CHECK the Included Components Compared to the Parts Breakdown. Check all parts and hardware in the box with the parts list below. Be sure you have all needed parts and know where they install.

IF you find a packaging error, contact SUPERLIFT directly. Do not contact the dealer where the system was originally purchased. You will need the control number from each box when calling; this number is located at the bottom of the part number label and to the right of the bar code.

- 1 SUPERLIFT Shocks & Mounting Hardware, Rear
- 2 Fab Lift Blocks, Rear
- 3 7/16" U-Bolts & Flange Nuts
- 4 9/16" U-Bolts, Hi-Nuts & Washers
- 5 E-Brake & Brake Line Brackets, Rear
- 6 Crossmember, Rear
- 7 Differential Bracket, DR.
- 8 Bump Stop Brackets, Front DR. & PA.
- 9 Strut Preload Spacer, Front DR. & PA.
- 10 Sway Bar Drop Brackets, Front DR & PA.
- 11 Belly Pan Bracket
- 12 Belly Pan
- 13 Strut Spacer, Front DR. & PA.
- 14 Knuckle, Front PA. Side
- 15 Knuckle, Front DR. Side
- 16 Crossmember, Front
- 17 Tie Rod End, PA. Side (Marked "L")
- 18 Tie Rod End, DR. Side (Marked "R")
- 19 Vacuum Tubes, 1/8" & 1/4" IDs
- 20 Brake Line Brackets, Front DR. & PA.
- 21 Carrier Bearing Spacers, Various Heights
- 22 Steering Stops

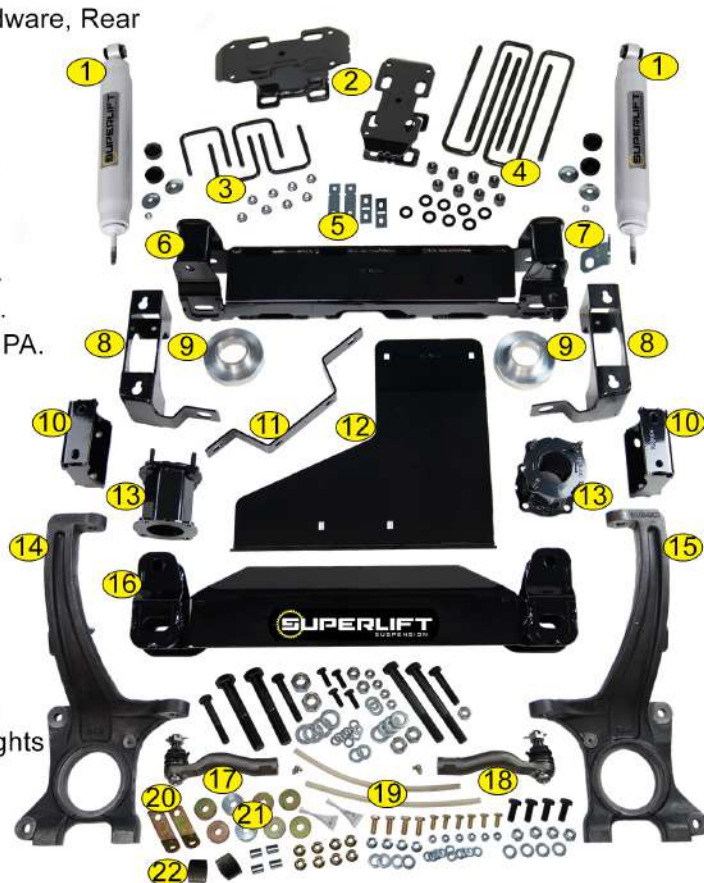

**NOTE:** K963 Does Not Include Strut Pre-Load Spacers, Front

## How to Read the Kit Breakdown Charts:

The 'K KIT BREAKDOWN' lists the Part Numbers, Quantities & Part Description of the Boxes that are included in the K KIT. The 'KIT BREAKDOWN' lists Part Numbers, Quantities & Part Description of the Individual Components & Hardware Bags that are included in Each Box. The 'HARDWARE BREAKDOWN' lists the Part Numbers, Quantities & Part Description of the Individual Components.

K KIT BREAKDOWN					
K962 6" Lift Kit			K963 4.5" Lift Kit		
Kit Part Number	Qty.	Part Description	Kit Part Number	Qty.	Part Description
8200	1	Kit Box, Knuckles	8200	1	Kit Box, Knuckles
8201	1	Kit Box, Front Crossmember, Bump Stops	8201	1	Kit Box, Front Crossmember, Bump Stops
8202	1	Kit Box, Rear Crossmember, Shocks	8202	1	Kit Box, Rear Crossmember, Shocks
8203	1	Kit Box, Sway Bar, Belly Pan, Tie Rod Ends	8203	1	Kit Box, Sway Bar, Belly Pan, Tie Rod Ends
8205	1	Kit Box, Strut & Preload Spacer, Rear Lift Block	8204	1	Kit Box, Strut Spacer, Rear Lift Block

KIT BREAKDOWN					
8200			8200		
Part Number	Qty.	Part Description	Part Number	Qty.	Part Description
66-01-8200	1	Steering Knuckle, Driver Side	66-01-8200	1	Steering Knuckle, Driver Side
66-02-8200	1	Steering Knuckle, Passenger Side	66-02-8200	1	Steering Knuckle, Passenger Side
77-8200	1	Hardware Bag	77-8200	1	Hardware Bag
8201			8201		
Part Number	Qty.	Part Description	Part Number	Qty.	Part Description
55-35-8200	1	Crossmember, Front	55-35-8200	1	Crossmember, Front
55-40-8200	1	Bump Stop, Driver Side	55-40-8200	1	Bump Stop, Driver Side
55-41-8200	1	Bump Stop, Passenger Side	55-41-8200	1	Bump Stop, Passenger Side
77-8201	1	Hardware Bag, Nuts & Bolts	77-8201	1	Hardware Bag, Nuts & Bolts
8202			8202		
Part Number	Qty.	Part Description	Part Number	Qty.	Part Description
55-36-8200	1	Crossmember, Rear	55-36-8200	1	Crossmember, Rear
55-37-8200	1	Differential Bracket, Rear	55-37-8200	1	Differential Bracket, Rear
01-85310	2	Shock Absorber, Rear	01-85310	2	Shock Absorber, Rear
77-8202	1	Hardware Bag, Nuts & Bolts	77-8202	1	Hardware Bag, Nuts & Bolts
77-8202A	1	Hardware Bag, Vacuum Hose	77-8202A	1	Hardware Bag, Vacuum Hose
77-80037	2	Hardware Bag, Bushings & Sleeves	77-80037	2	Hardware Bag, Bushings & Sleeves
141991	2	Hardware Bag, Washer Pack	141991	2	Hardware Bag, Washer Pack
77-60471	2	Hardware Bag, Stem Bushings	77-60471	2	Hardware Bag, Stem Bushings
8203			8203		
Part Number	Qty.	Part Description	Part Number	Qty.	Part Description
55-18-8200	2	Sway Bar Drop	55-18-8200	2	Sway Bar Drop
55-38-8200	1	Belly Pan	55-38-8200	1	Belly Pan
55-39-8200	1	Belly Pan Bracket	55-39-8200	1	Belly Pan Bracket
ES800314	1	Tie Rod End, Driver Side (marked "R")	ES800314	1	Tie Rod End, Driver Side (marked "R")
ES800313	1	Tie Rod End, Passenger Side (marked "L")	ES800313	1	Tie Rod End, Passenger Side (marked "L")
77-8203	1	Hardware Bag, Nuts and Bolts	77-8203	1	Hardware Bag, Nuts and Bolts
77-8203A	1	Hardware Bag, Carrier Bearing Spacers	77-8203A	1	Hardware Bag, Carrier Bearing Spacers
77-8203B	1	Hardware Bag, Brake Line Brackets	77-8203B	1	Hardware Bag, Brake Line Brackets
8205			8204		
Part Number	Qty.	Part Description	Part Number	Qty.	Part Description
55-42-8200	2	Strut Spacer	55-42-8200	2	Strut Spacer
55-17-8200	2	Strut Preload Spacer, 6" Kit	55-03-202	2	Lift Block, Rear 4" Kit
55-01-202	2	Lift Block, Rear 6" Kit	10462	4	9/16" x 2-1/2" x 10" U-Bolts, Square Bend
10502	4	9/16" x 2-1/2" x 12" U-Bolts, Square Bend	77-8204	1	Hardware Bag, Nuts
77-8204	1	Hardware Bag, Nuts	77-1509	1	Hardware Bag, 9/16" U-Bolt Nuts & Washers
77-1509	1	Hardware Bag, 9/16" U-Bolt Nuts & Washers			
77-1507	1	Hardware Bag, 7/16" U-Bolt Nuts & Washers			

**HARDWARE BAG BREAKDOWN**

Kit Part Number 77-8200			Kit Part Number 77-8203A		
Part Number	Qty.	Part Description	Part Number	Qty.	Part Description
F470L	2	Thread Locker	55-23-8200	2	Carrier Bearing Spacer, 0.1875" (3/16")
55-44-8200	4	14mm OD x 12mm ID Sleeve	55-24-8200	2	Carrier Bearing Spacer, 0.2500" (1/4")
55-32-8200	2	Steering Stop	55-25-8200	2	Carrier Bearing Spacer, 0.3750" (3/8")
			55-26-8200	2	Carrier Bearing Spacer, 0.5000" (1/2")
Kit Part Number 77-8201			Kit Part Number 77-8203B		
Part Number	Qty.	Part Description	Part Number	Qty.	Part Description
22mx2.5x140csg10.9	2	22mm x 140mm, 2.5 Pitch	55-19-8200	2	Brake Line Bracket, Front
22mfw	4	22mm Washer, Flat	55-21-8200	2	Emergency Brake, Rear
22mnn	2	22mm Nut, Nyloc	55-43-8200	2	Brake Bracket, Rear
14mx2.0x90csg10.9	2	14mm x 90mm, 2.0 Pitch			
14mfw	2	14mm Washer, Flat	Kit Part Number 77-8204		
14mnn	2	14mm Nut, Nyloc	Part Number	Qty.	Part Description
10mx1.25x30csg10.9	4	10mm x 30mm, 1.25 Pitch	10mfnn	8	10mm Nut, Flange
10mfw	8	10mm Washer, Flat			
10mnn	4	10mm Nut, Nyloc	Kit Part Number 77-80037		
Kit Part Number 77-8202			Part Number	Qty.	Part Description
18mx2.5x160cs	2	18mm x 160mm, 2.5 Pitch	24-5704	1	Sleeve, 0.75" OD x 0.50" ID x 1.5" Long
18mfw	4	18mm Washer, Flat	01-60418	1	Polyurethane Bushing, Eye
18mnn	2	18mm Nut, Nyloc	Kit Part Number 141991		
14mx2.0x70csg10.9	1	14mm x 70mm, 2.0 Pitch	Part Number	Qty.	Part Description
14mfw	2	14mm Washer, Flat		2	Shock Washer, Stem
14mnn	1	14mm Nut, Nyloc		1	Shock Nut, Stem
Kit Part Number 77-8202A			Kit Part Number 77-60471		
Part Number	Qty.	Part Description	Part Number	Qty.	Part Description
31-8200	1	1/4" Vacuum Hose	01-60471	2	Polyurethane Bushing, Stem
33-8200	1	1/8" Vacuum Hose	Kit Part Number 77-1509		
Kit Part Number 77-8203			Part Number	Qty.	Part Description
38x1c8cs	4	3/8" x 1" Bolt, Carriage	1511-b09	8	9/16" Nut, Hi U-Bolt
38c5fn	4	3/8" Nut, Flange	916cw	8	9/16" Washer, U-Bolt
516x34c8cs	6	5/16" x 3/4" Bolt, Coarse Thread	Kit Part Number 77-1507		
516sw	12	5/16" Washer, SAE	Part Number	Qty.	Part Description
516c5nn	6	5/16" Nut, Nyloc Coarse Thread	716x314x412ub	4	7/16" x 3-1/4" x 4-1/2" U-Bolt, Square
6mgf	2	6mm Grease Fitting, Threaded	716f8sfnn	8	7/16" Flange Nut, Fine Thread
12mx1.75x30csg10.9	4	12mm x 30mm, 1.75 Pitch			
12mfw	8	12mm Washer, Flat			
12mnn	4	12mm Nut, Nyloc			

Step	Part Number	Qty. PER Kit	Description	New Attaching Hardware	Qty. PER Bracket	Hardware Bag Number
18	55-35-8200	1	Crossmember, Front	22mm x 140mm, 2.5 Pitch	2	77-8201
				22mm Washer, Flat	4	
				22mm Nut, Nyloc	2	
				14mm x 90mm, 2.0 Pitch	2	
				14mm Washer, Flat	2	
				14mm Nut, Nyloc	2	
19	55-40-8200	1	Bump Stop, Driver Side	10mm x 30mm, 1.25 Pitch	2	77-8201
				10mm Washer, Flat	4	
				10mm Nut, Nyloc	2	
19	55-41-8200	1	Bump Stop, Passenger Side	10mm x 30mm, 1.25 Pitch	2	77-8201
				10mm Washer, Flat	4	
				10mm Nut, Nyloc	2	
20	55-39-8200	1	Belly Pan Bracket			

Step	Part Number	Qty. PER Kit	Description	New Attaching Hardware	Qty. PER Bracket	Hardware Bag Number
21	55-36-8200	1	Crossmember, Rear	18mm x 160mm, 2.5 Pitch	2	77-8202
				18mm Washer, Flat	4	
				18mm Nut, Nyloc	2	
21	55-37-8200	1	Differential Bracket, Rear	14mm x 70mm, 2.0 Pitch	1	77-8202
				14mm Washer, Flat	2	
				14mm Nut, Nyloc	1	
22	31-8200	1	1/4" Vacuum Hose			77-8202A
22	33-8200	1	1/8" Vacuum Hose			77-8202A
28	55-38-8200	1	Belly Pan	3/8" x 1" Bolt, Carriage	4	77-8203
				3/8" Nut, Flange	4	
29	55-42-8200	2	Strut Spacer, 4.5"	10mm Nut, Flange	4	77-8204
29	55-17-8200	2	Strut Preload Spacer, 6"			
30	66-01-8200	1	Steering Knuckle, Driver Side	Thread Locker	1	77-8200
				55-44-8200 - 14mm OD x 12mm ID sleeve	2	
				55-32-8200 - Steering Stop	1	
30	66-02-8200	1	Steering Knuckle, Passenger Side	Thread Locker	1	77-8200
				55-44-8200 - 14mm OD x 12mm ID Sleeve	2	
				55-32-8200 - Steering Stop	1	
31	55-19-8200	2	Brake Line Bracket, Front	5/16" x 3/4" Bolt, Coarse Thread	1	77-8203
				5/16" Washer, SAE	1	
				5/16" Nut, Nyloc Coarse Thread	1	
36	ES800314	1	Tie Rod, Driver Side (Marked "R")	6mm Grease Fitting, Threaded	1	77-8203
36	ES800313	1	Tie Rod, Passenger Side (Marked "L")	6mm Grease Fitting, Threaded	1	77-8203
37	55-18-8200	2	Sway Bar Drop	12mm x 30mm, 1.75 Pitch	2	77-8203
				12mm Washer, Flat	4	
				12mm Nut, Nyloc	2	
42	55-01-202	2	Lift Block, Rear 6" Kit	10502 - 9/16" x 2-1/2" x 12" U-Bolt, Square Bend	4	77-1509
				9/16" Nut, Hi U-Bolt	4	
				9/16" Washer, U-Bolt	4	
				7/16" x 3-1/4" x 4-1/2" U-Bolt, Square	2	77-1507
				7/16" Flange Nut, Fine Thread	4	
<b>OR</b>						
42	55-03-202	2	Lift Block, Rear 4.5" Kit	10462 - 9/16" x 2-1/2" x 10" U-Bolt, Square Bend		77-1509
				9/16" Nut, Hi U-Bolt	4	
				9/16" Washer, U-Bolt	4	
43	01-85310	2	Shock Absorber, Rear	24-5704 - 0.75" OD x 0.50" ID x 1.5" Long Sleeve	1	77-80037
				01-60418 - Polyurethane Bushing, Eye	1	
				141991 - Washer Pack	1	141991
				01-60471 - Polyurethane Bushing, Stem	2	77-60471
44	55-21-8200	2	Emergency Brake, Rear	5/16" x 3/4" Bolt, Coarse Thread	1	77-8203
				5/16" Washer, SAE	2	
				5/16" Nut, Nyloc Coarse Thread	1	
45	55-43-8200	2	Brake Bracket, Rear	5/16" x 3/4" Bolt, Coarse Thread	1	77-8203
				5/16" Washer, SAE	2	
				5/16" Nut, Nyloc Coarse Thread	1	
46	55-23-8200	2	Carrier Bearing Spacer, 0.1875"			77-8203A
	55-24-8200	2	Carrier Bearing Spacer, 0.2500"			
	55-25-8200	2	Carrier Bearing Spacer, 0.3750"			
	55-26-8200	2	Carrier Bearing Spacer, 0.5000"			

## 2007-2018 Toyota Tundra 4.5 Inch & 6 Inch Lift Kits INSTALLATION INSTRUCTIONS

**THANK YOU FOR CHOOSING  
SUPERLIFT FOR ALL  
YOUR SUSPENSION NEEDS!**



**Read And Understand All Instructions And Warnings  
Prior To Installation Of System AND Operation Of Vehicle.**

### **INTRODUCTION BEFORE INSTALLATION...**

Installation requires a professional mechanic. In addition to these instructions, professional knowledge of disassembly / reassembly procedures and post installation checks must be known.

PRIOR to beginning, inspect the vehicles steering, driveline, and brake systems, paying close attention to the suspension link arms and bushings, sway bars and bushings, tie rod ends, pitman arm, idler arm, ball joints and wheel bearings. Also check the steering sector-to-frame and all suspension-to-frame attaching points for stress cracks. The overall vehicle must be in excellent working condition; repair or replace all worn parts.

Read instructions several times before starting.

Read each step completely as you go.

**Be sure you have all needed parts and know where they install.**

### **⚠ NOTES:**

- Do NOT install this suspension system in conjunction with any other type of aftermarket or fabricated components to gain additional suspension height.
- Front end alignment is necessary.
- A foot-pound torque reading is given in parenthesis ( ) after each appropriate fastener.
- Tool and Wrench/Socket size is given in brackets { } after each appropriate step.
- Prior to drilling or cutting, check behind the surface being worked on for any wires, lines, or hoses that could be damaged. Prep all cutting surfaces by removing all debris and frame coatings.
- After drilling, file smooth any burrs and sharp edges.
- Prior to operating a torch or saw, protect any heat-sensitive components located in the immediate area by covering them with a water-saturated cloth. Most undercoating are flammable but can be extinguished using a water-filled spray bottle. Have a spray bottle and an ABC rated fire extinguisher on hand.
- Paint or undercoat all exposed metal surfaces.
- Prior to attaching components, be sure all mating surfaces are free of grit, grease, excessive undercoating, etc.
- Always wear safety glasses when using power tools.
- A factory service manual should be on hand for reference.

## BEFORE YOU DRIVE...

Check all fasteners for proper torque. Check to ensure for adequate clearance between all rotating, mobile, fixed, and heated members. Verify clearance between exhaust and brake lines, fuel lines, fuel tank, floor boards and wiring harness. Check steering components for clearance.

Test and inspect brake system. Perform steering sweep to ensure front brake hoses have adequate slack and do not contact any rotating, mobile or heated members. Inspect rear brake hoses at full extension for adequate slack. Failure to perform hose check/replacement may result in component failure.

Perform head light check and adjustment.

**⚠️ WARNING:** It is the ultimate buyer's responsibility to have all bolts / nuts checked for tightness after the first 100 miles and then every 1000 miles. The steering, suspension and driveline systems, plus wheel alignment should be inspected by a qualified professional mechanic at least every 3000 miles.

## TECH TIP / TIME SAVER...

- Some minor trimming will be required with certain wheel/ tire combination. This is normal with most aftermarket tire/wheel fitment on TUNDRA trucks. Trimming will normally include the bottom edge of the inner fender shrouds and/or lower corner of front bumper valance. As a rule of thumb, deeper backspacing and shorter/ narrower tires will reduce/eliminate trimming required.

## TIRES & WHEELS...

Larger rim and tire combinations may increase leverage on suspension, steering, and related components. When selecting combinations larger than OE, consider the additional stress you could be inducing on the OE and related components.

**⚠️ NOTE:** Stock \ Factory 18" Wheels Will NOT Fit back on the vehicle once this suspension system is installed. Aftermarket Wheels Require 5.00-5.50 Inch Back Spacing.

**⚠️ WARNING:** ANY larger or wider tire & wheel combination other than listed Will Require Vehicle Trimming.

4.5 Inch Lift Height - TIRE SIZE SPECIFICATIONS			
Tire Size	Wheel	Backspacing (INCH)	Offset (MM)
295/70 R18	18 x 9	5.00-5.50	0
295/60 R20	20 x 9	5.00-5.50	0
285/55 R22	22 x 9	5.00-5.50	0

Maximum BS/Offset Listed

6 Inch Lift Height - TIRE SIZE SPECIFICATIONS			
Tire Size	Wheel	Backspacing (INCH)	Offset (MM)
35x12.50 R18	18 x 9	5.00-5.50	0
35x12.50 R20	20 x 9	5.00-5.50	0
35x12.50 R22	22 x 9	5.00-5.50	0

Maximum BS/Offset Listed

## TOOLS & TECH...

This is a list of tools needed to install this lift kit. Double check the list to make sure that you have all the tools and equipment required to accomplish the complete install.

We have also included a

**Tech Tip** noted by this icon  **TECH TIP** to help if we have found a quicker or easier way to accomplish a task in the steps.

TOOLS				
Miscellaneous Tools		Wrenches / Socket Sizes		
Floor Jacks	Jack Stands	Standard	Metric	
Ball-Peen Hammer	Chisel	1/2"	8mm	22mm
Adjustable Pliers	Vice Grips	9/16"	10mm	24mm
Torque Wrench	Pry Bar	11/16"	12mm	27mm
Tube Straightener	Grease Gun	7/8"	14mm	32mm
Plastic Fastern Removal Tool			15mm	39mm 12pt.
Grinder with Cut Wheel			17mm	57mm
Wheel Hub Removal Tool			19mm	
Strut Compressor				5mm Allen

**NOTE:** Use the check-off box  found at each step to help you keep your place. Two  denotes that one check-off box is for the Driver Side (Left) and one is for the Passenger Side (Right). Unless otherwise noted, always start with the Driver Side.

## FRONT DISASSEMBLY

**NOTE:** Save ALL factory components and hardware for reuse, unless noted.

### PREPARE VEHICLE FOR FRONT...

- 1. Disconnect the battery.
- Chock rear tires and place transmission in neutral. Raise the front of vehicle with a jack and secure a jack stand beneath each frame rail. Ease the frame down onto the stands, place transmission in low gear for Manual Transmission or Park for Automatic. Remove the front wheels & tires. {Lug Nuts 22mm}

### REMOVE FACTORY BELLY PAN/SKID PLATE...

- 2. If equipped, remove the factory belly pan. (3) bolts at valance {10mm} (5) bolts at frame {12mm} The factory belly pan will not be retained.

### REMOVE SWAY BAR...

- 3. **[Illustration 3]**  
Disconnect the sway bar link from the lower control arm {19mm}  
Remove the sway bar mount from the frame {17mm}

**[Illustration 3]**

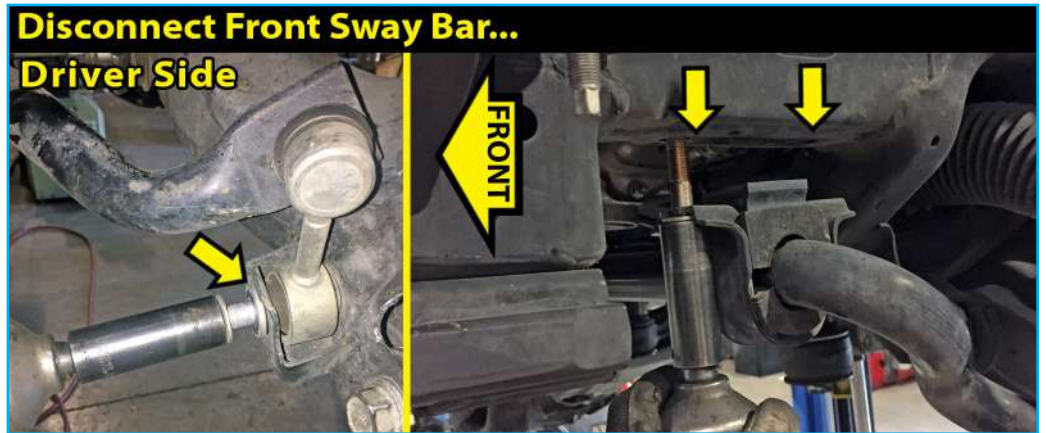

### DISCONNECT ABS & BRAKE LINES FROM KNUCKLE...

- 4. **[Illustration 4-A]**  
Disconnect ABS bracket from the top of the upper control arm {10mm}
- [Illustration 4-B]** Disconnect brake line bracket from the knuckle {12mm}
- [Illustration 4-C]** Disconnect ABS sensor plug from knuckle. {5mm Allen}
- [Illustration 4-D]** Remove the ABS bracket from the knuckle {12mm} Remove ABS clip from knuckle. {Plastic Fastener Removal Tool}

**[Illustration 4]**

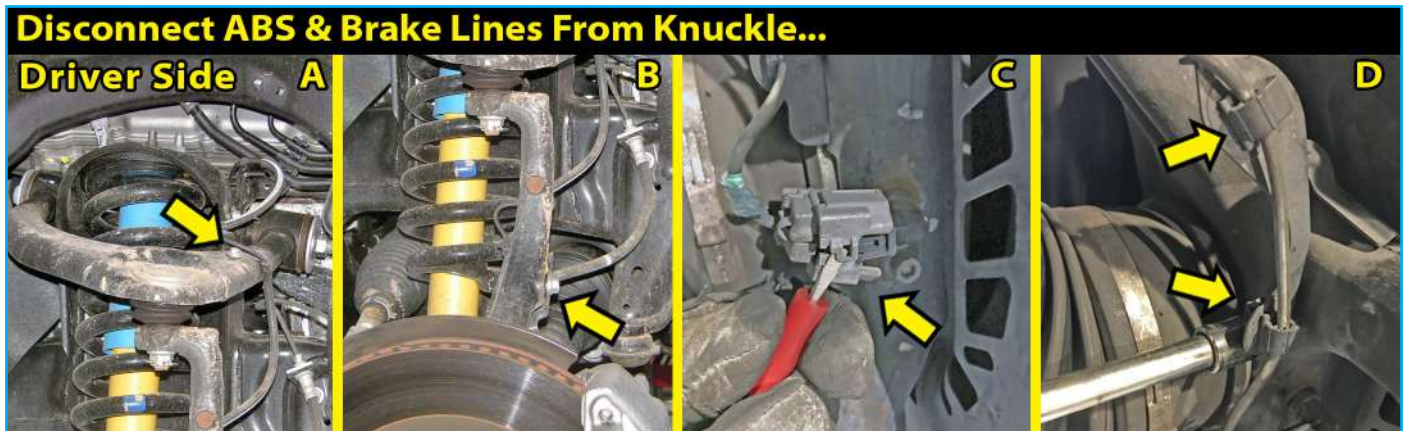

**DISCONNECT TIE ROD END...**

□□ 5. **[Illustration 5]** Remove the tie rod cotter pin & nut. {24mm}  
Reinstall the nut a couple of turns by hand.

Use a Tie Rod Puller to separate the tie rod from the knuckle.

**⚠ WARNING:** Be careful. Do not let the knuckle fall to the side abruptly. It could cause damage to the ABS wires or brake lines.

**🔧 TECH TIP** If you do not have a puller, you can use the method of striking the knuckle near the ball joint end to dislodge the knuckle. Strike the knuckle portion only.

Remove the tie rod nut and save for re-install.

**REMOVE BRAKE CALIPER & ROTOR...**

□□ 6. **[Illustration 6-A]** Remove the (2) brake caliper bolts {17mm or 19mm} and remove from the rotor and secure it away from the work area. Retain factory bolts.

Do not let calipers hang from brake lines. Using a bungee strap, wire hook or wire, safely secure the calipers to the frame to remove the tension from the brake lines and to add working room.

□□ **[Illustration 6-B]** Remove brake rotor.

**REMOVE AXLE NUT...**

□□ 7. **[Illustration 7-A]** Remove dust cap from hub center. {Flat screwdriver or small chisel}

**[Illustration 7-B]** Remove the cotter pin {pliers}, **[Illustration 7-C]** castle nut cover and **[Illustration 7-D]** axle nut {39mm 12pt} Retain factory hardware.

**[Illustration 7]**

**[Illustration 5]**



**[Illustration 6]**

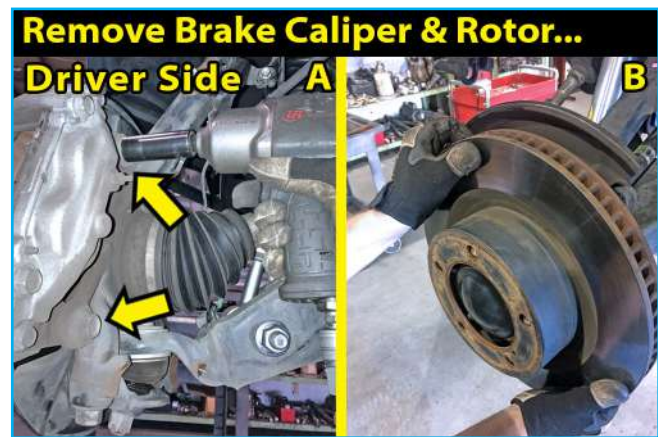

**Remove Dust Cover, Cotter Pin, Castle Nut Cover & Axle Nut...**

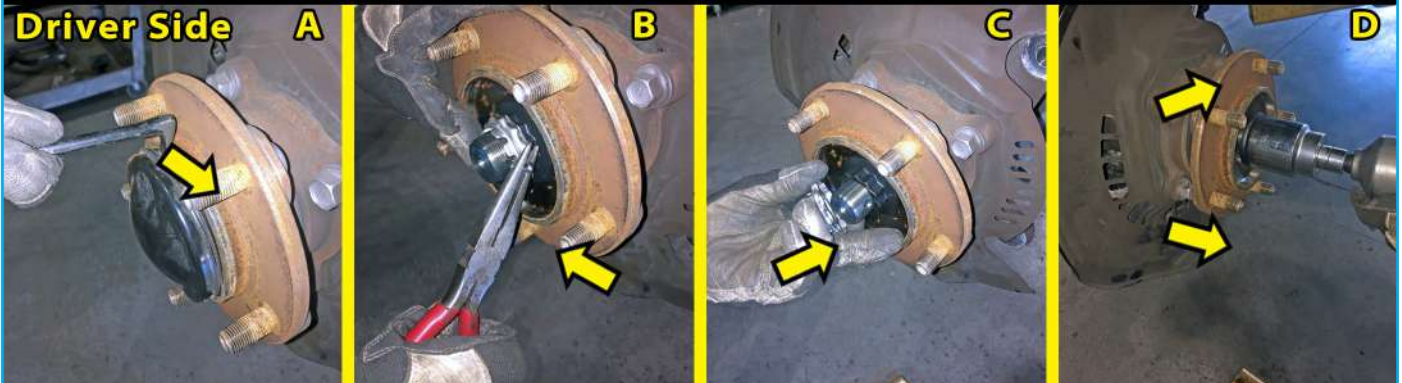

**DISCONNECT UPPER BALL JOINT FROM KNUCKLE...**

□□ 8. **[Illustration 8]** At the top of the knuckle, remove cotter pin and nut from upper ball joint. {19mm}

Using the appropriate puller tool, disconnect the ball joints from the knuckle.

**🔧 TECH TIP** If you do not have a puller tool you can use a hammer by very carefully striking the ball joint boss' of the knuckle; do not strike the ball joint.

Remove knuckle from vehicle.

**[Illustration 8]**



## DISCONNECT LOWER BALL JOINT BRACKET...

☐☐ 9. **[Illustration 9]** On the bottom of the knuckle, remove the (2) lower ball joint bracket bolts {22mm}  
**LOOSEN LOWER CONTROL ARM...**

☐☐ 10. **[Illustration 10]** Loosen, but do not remove the (2) lower control arm bolts from the factory front & rear crossmembers. {24mm}

**[Illustration 9]**



**[Illustration 10]**



## REMOVE LOWER STRUT BOLT...

☐☐ 11. Remove the lower strut bolt. {22mm} **⚠ NOTE:** Once you remove the lower strut bolt, the weight of the arm is going cause it to drop/swing down quickly.

Carefully let lower control arm swing away.

## REMOVE STRUT & LOWER CONTROL ARM...

☐☐ 12. **[Illustration 11-A]** Remove the (4) upper strut nuts. {14mm}

☐☐ **[Illustration 11-B]**

**⚠ NOTE:** Before you completely remove the strut, 'Mark' the Alignment of the Coil, Top Mount & Isolator. Also Mark DR. & PA. Side.

Remove the strut from the vehicle.

☐☐ **[Illustration 11-C]**

Remove the lower control arm from the vehicle.

**[Illustration 11]**

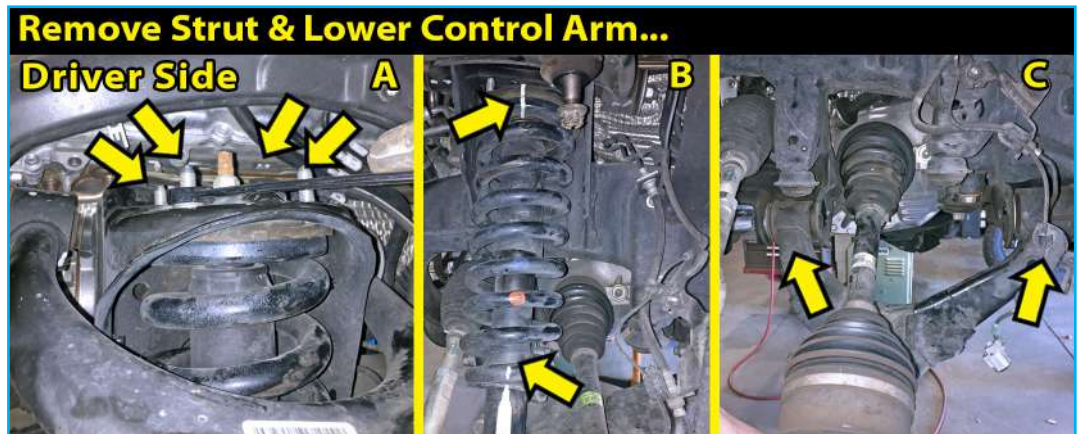

## MARK & DISCONNECT FRONT DRIVESHAFT...

☐ 13. **[Illustration 12-A]** Mark the orientation of the driveshaft for reference during reassembly.

☐ **[Illustration 12-B]** Remove the (4) bolts securing the driveshaft. {14mm} Disconnect the front driveshaft from differential. Retain factory hardware. Secure the driveshaft up and out of the way.

**[Illustration 12]**

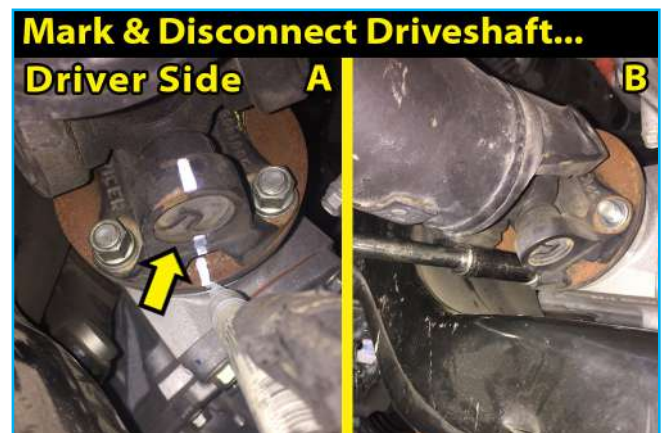

### DISCONNECT DIFFERENTIAL ACTUATOR PLUG...

□ 14. **[Illustration 13]** With the battery disconnected, carefully disconnect the actuator lug from differential; This plug is "locked" with plastic clips that must be moved to an "unlocked" position before removal. {flathead or pick tool}

Follow the cable up and remove cable from frame to gain adequate slack. {plastic fastener removal tool}

### REMOVE DIFFERENTIAL...

□ 15. **[Illustration 14-A]** Disconnect the two (2) vent hoses from the top of the differential.

**[Illustration 14-B]** On the Driver side at the rear crossmember & above the lower control arm mount, locate the rear differential mount. Remove the nut by accessing it through the rear crossmember. {19mm} Remove the two (2) bolts - one at the differential and one at the frame. {19mm} Retain differential mount and hardware.

Support the differential housing with a jack.

**[Illustration 14-C]** Locate the front differential mounts. Remove the two (2) mount bolts from the frame {19mm} **⚠ NOTE:** The front differential mounting brackets will remain attached to the differential.

Lower the jack and remove the differential from the vehicle.

### [Illustration 14]

#### Remove Differential...

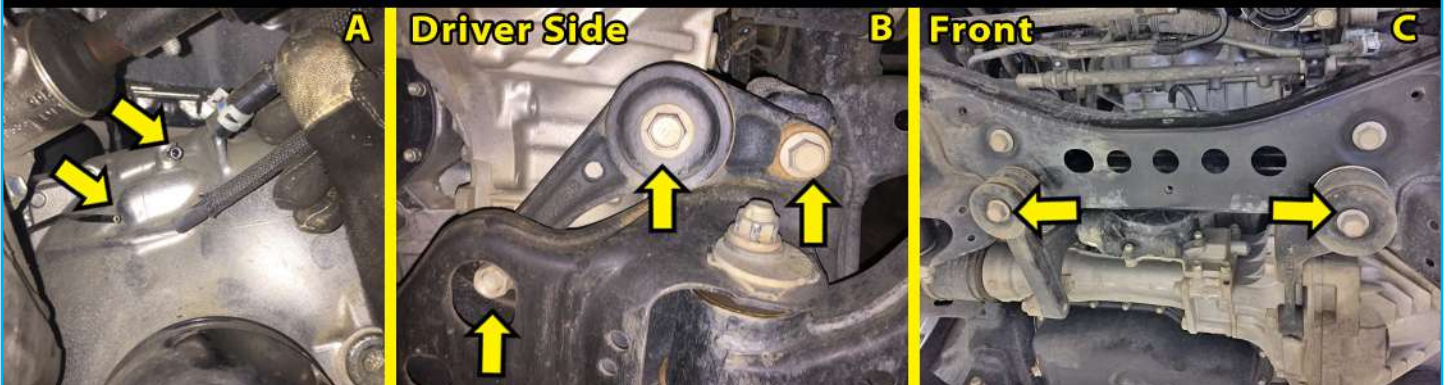

### TRIMMING THE FRAME...

□ 16. **[Illustration 15-A]** On the Driver side rear lower control arm mount, measure from the Inside of the Cam Plate over (toward the Passenger side) 1.25" and mark a line.

□ **[Illustration 15-B]** From the same Cam Plate, measure over 9.50" to the inside (toward the Passenger side) and mark a line.

### [Illustration 15]

#### Trimming the Frame...



### [Illustration 13]

#### Diff Actuator Plug...



☐ **[Illustration 15-C]** Mark each cut line all the way around the mount. Using a torch, plasma cutter, cutting wheel or similar tool, trim and remove the frame section.

☐☐ **[Illustration 15-D]**  
On some year models, the inside rear lower control arm mount has a metal tab inside. This tab needs to be clearanced to allow the new rear crossmember to seat properly. Trim the tab at the notch as shown.

☐ Once you are happy with the cuts, deburr all the edges with a grinder and apply a coat of paint or undercoating to prevent rust.

**[Illustration 15-D]**



**[Illustration 16]**

### TRIMMING THE FRONT LOWER CONTROL ARM MOUNTS...

☐☐ 17. **[Illustration 16]** On the front lower control arm mounts, use a grinder or cutting wheel to grind the outside tab on the rear alignment slot and the outside edge of the LCA pocket. (This will allow a flat mating surface for the new bump stop brackets.)

☐☐ Once you are happy with the cut, deburr the edges with a grinder and apply a coat of paint to prevent rusting.

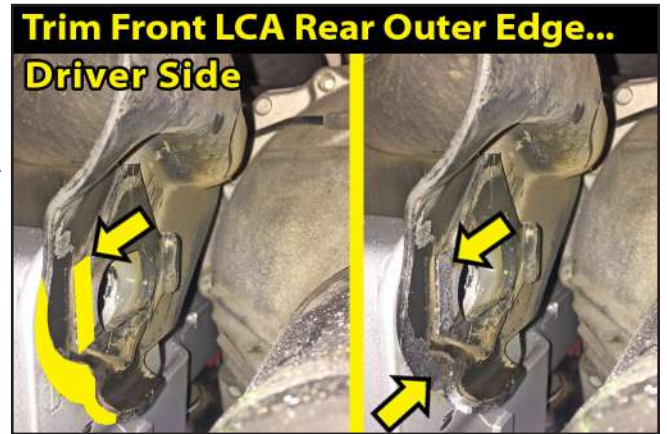

### FRONT ASSEMBLY FRONT CROSSMEMBER...

☐ 18. **[Illustration 17]** Locate the SUPERLIFT #55-35-8200 front crossmember.

Locate the SUPERLIFT hardware in Bag #77-8201. PER Bracket: (2) 22mm x 140mm, 2.5 Pitch, (4) 22mm Washer, Flat, (2) 22mm Nut, Nyloc

Install #55-35-8200 into the front lower control arm mounts. Place the (1) 22mm flat washer onto each 22mm x 140mm bolt. Bolts are installed from Front to Rear.

**⚠ NOTE:** Do Not install rear washer or nyloc nut at this time. Do not tighten at this time.

**🔧 TECH TIP** Install the new crossmember into the Passenger side first, then swing the crossmember up into the Driver side position.

**[Illustration 17]**



**FRONT BUMP STOPS...**

□□ 19. **[Illustration 18-A]** Remove the (2) factory front bump stops by unscrewing them from the frame mount {57mm or large adjustable pliers}

Locate the SUPERLIFT Bump Stop brackets #55-40-8200 Driver side & #55-41-8200 Passenger side. The bump stop brackets are side specific. The new bump stop brackets have a tab that goes toward the front of the vehicle and connects to the front crossmember bolt.

Locate the SUPERLIFT hardware in Bag #77-8201. PER Bracket: (2) 10mm x 30mm, 1.25 Pitch, (4) 10mm Washer, Flat, (2) 10mm Nut, Nyloc & (2) 22mm Washer, Flat plus (2) 22mm Nut, Nyloc.

□□ **[Illustration 18-B]** Install the factory bump stops onto the bumps top brackets with supplied 10mm washers and 10mm Nyloc nuts. {17mm}

□□ **[Illustration 18-B & 18-C]** Install the supplied 10mm x 1.25 x 30mm bolts up and through the bump stop brackets and into the factory bump stop locations. The bump stop bracket has slotted holes at the top so you can hang the bracket, then slide it forward to align the tab with the front crossmember bolt. {17mm}

□□ **[Illustration 18-D]** Install the 22mm flat washer and 22mm Nyloc nut onto the crossmember bolt. {32mm wrench / 32mm socket} Tighten all hardware.

**[Illustration 18]**

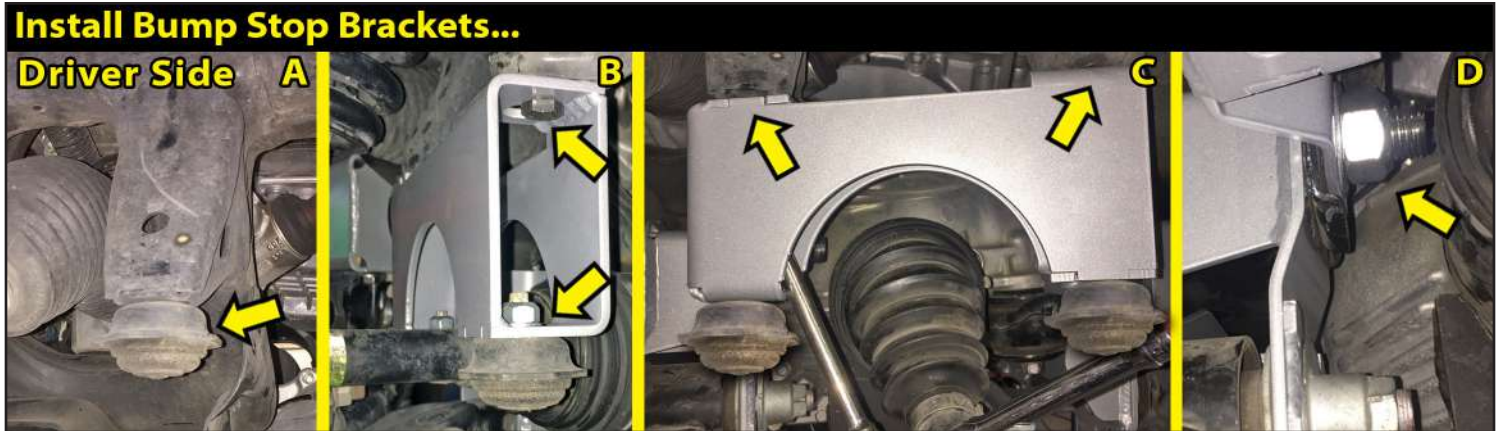

**FRONT DIFFERENTIAL MOUNTS...**

□ 20. **[Illustration 19]** Locate the #55-39-8200 belly pan bracket.

Locate the SUPERLIFT hardware in Bag #77-8201. PER Bracket: (2) 14mm Washer, Flat, (2) 14mm Nut, Nyloc

With differential supported by a jack, raise the differential into place.

Insert the #55-39-8200 belly pan bracket into place below the front crossmember and above the factory differential mounts. **⚠NOTE:** The bracket has the notch that goes to the Driver side.

Secure the two (2) front factory differential mounts to belly pan bracket and into the front crossmember maintaining the factory washer on the bolt head and using the supplied 14mm x 90mm bolts, washers and Nyloc nuts. {22mm}

**[Illustration 19]**



**REAR CROSSMEMBER...**

21. Locate the #55-36-8200 rear crossmember and the # 55-37-8200 rear differential bracket.

Locate the SUPERLIFT hardware in Bag #77-8202. PER Bracket: (2) 18mm x 160mm, 2.5 Pitch, (4) 18mm Washer, Flat, (2) 18mm Nut, Nyloc, (1) 14mm x 70mm, 2.0 Pitch, (2) 14mm Washer, Flat, (1) 14mm Nut, Nyloc.

□ **[Illustration 20-A]** Install #55-36-8200 into the rear lower control arm mounts. Place the (1) 18mm flat washer onto each 18mm x 140mm bolt. Bolts are installed from Rear to Front.

Install the new crossmember into the Passenger side first, then swing the crossmember up toward the Driver side position. Loosely install the factory rear differential bracket to the new crossmember using the factory nut.

**[Illustration 20-B]** Once Driver side bolt is in place; install the rear differential support bracket (55-37-8200) over the bolt, then install the 18mmn washer and Nyloc nut.

**[Illustration 20-C]** Install the supplied 14mm x 70mm bolt - Top Down - through the differential support bracket (55-37-8200), rear crossmember (55-36-8200) and differential mount with washers and Nyloc nut.

**[Illustration 20-D]** Apply thread locker onto factory rear differential bolt and loosely install into differential. {19mm}

**[Illustration 20]**



### DIFFERENTIAL VENT HOSES...

22. Locate the SUPERLIFT hardware in Bag #77-8202A. (1) #31-8200 1/4" vacuum hose & (1) #33-8200 1/8" vacuum hose.

**[Illustration 21]** On the inside of the Driver side frame rail, loosen the hose clamps and remove the (2) rubber vent hoses from the hard line attached to frame. {pliers}

Install new 1/8" hose #33-8200 onto differential vacuum line and attach to the differential.

Install new 1/4" hose #31-8200 onto differential vacuum line and attach to the differential.

### PLUG DIFFERENTIAL ACTUATOR...

23. **[Illustration 22]** Reconnect the differential actuator back into differential.

### FRONT DIFFERENTIAL MOUNTS...

24. **[Illustration 23]** Tighten and torque the two (2) front differential mount bolts {22mm} (90)

**[Illustration 21]**

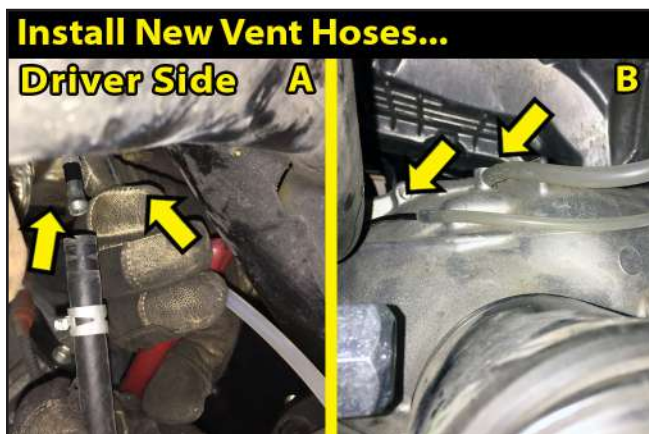

**[Illustration 22]**



**[Illustration 23]**



**LOWER CONTROL ARMS...**

□ 25. [Illustration 24] Locate the factory lower control arms. install the lower control arm using the factory hardware. The front bolt installs Front to Rear and the rear bolt installs Rear to Front (the same direction of the bolts in the crossmembers). Loosely tighten.

[Illustration 24]



**FRONT TIGHTENING SEQUENCE...**

26. Tightening and Torque Sequence.

□ [Illustration 25-A] Front Crossmember at frame {32mm} (250)

□ [Illustration 25-B] Rear Crossmember at frame {27mm} (250)

□ [Illustration 25-C] Rear differential bracket bolt (inside) at rear crossmember {19mm} (90)

□ [Illustration 25-B] Rear differential bracket bolt (outside) at rear crossmember {22mm} (90)

□ [Illustration 25-D] Apply thread locker to factory nut, then tighten rear differential mount accessed through rear crossmember {19mm} (90)

[Illustration 25]

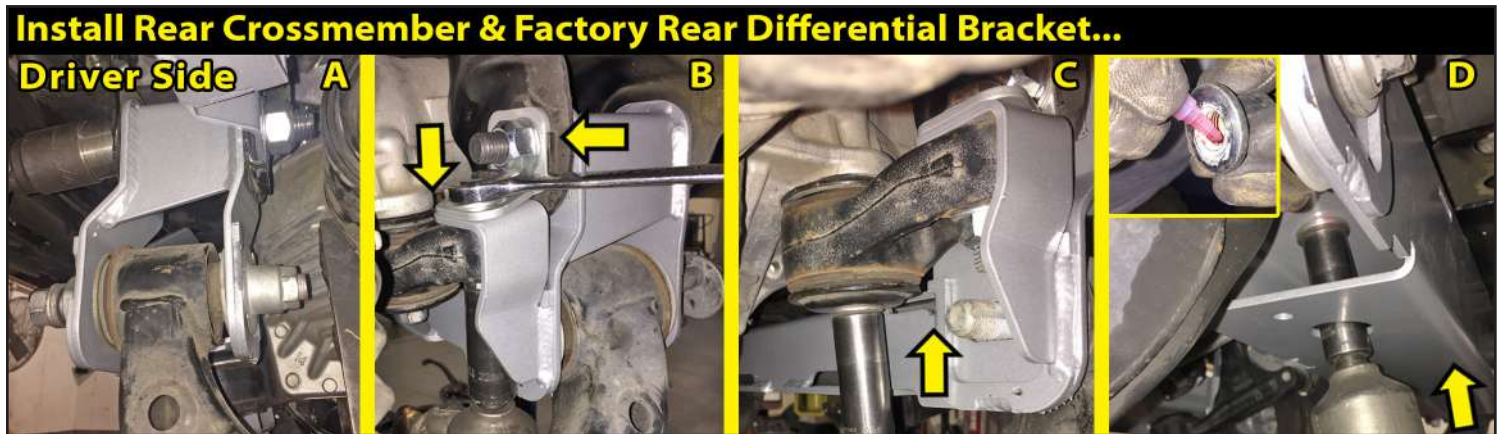

**FRONT DRIVESHAFT...**

□ 27. [Illustration 26] Apply thread locker to the four (4) driveshaft bolts, realign orientation marks and attach driveshaft {14mm} Check clearances around driveshaft flange and frame - trim frame if needed.

[Illustration 26]

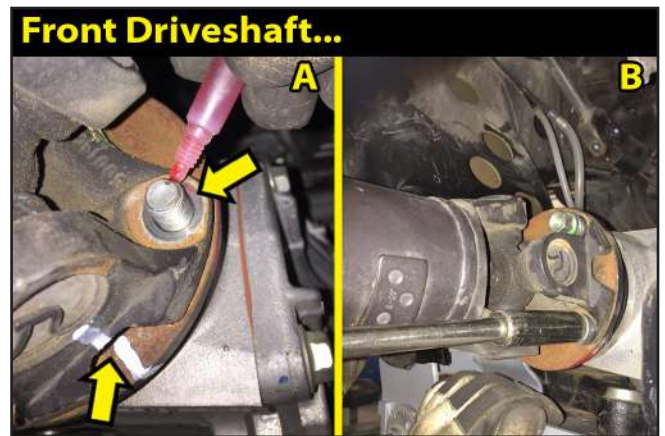

**BELLY PAN / SKID PLATE...**

□ 28. [Illustration 27] Locate the #55-38-8200 belly pan. Locate the SUPERLIFT hardware in Bag #77-8203. (4) 3/8" x 1" Bolt, Carriage & (4) 3/8" Nut, Flange. Install belly pan and secure using the four (4) 3/8" x 1" carriage bolts and 3/8" flange nuts. {9/16"}

[Illustration 27]



**STRUT SPACER ASSEMBLY...**

29. **NOTE:** IF you are installing the 4.5 Inch lift system, skip this step & proceed to Step 30.

Locate the SUPERLIFT #55-42-8200 4.5 inch strut spacer. In the 6 inch lift, also locate the #55-17-8200 preload strut spacer.

Locate the SUPERLIFT hardware in Bag #77-8204 PER Side: (4) 10mm Nut, Flange.

Using the appropriate compressor, compress the coil & remove the top strut nut [17mm]

Separate the upper strut plate from the coil.

**[Illustration 28-A]** 6 inch lifts only, place the factory rubber isolator onto the new strut preload spacer #55-17-8200.

**[Illustration 28-A]** 6 inch lifts only, insert new strut preload spacer #55-17-8200 onto coil.

**[Illustration 28-A]** Place factory strut top plate onto new spacer, place bushing and nut on strut shaft - tighten. {17mm}

30. **[Illustration 28-B]** Install new strut spacer #55-42-8200 and tighten using the (4) factory nuts. [14mm]

**NOTE:** #55-42-8200 has a Notch in top and bottom plate. This notch will point to the Outside of the vehicle on Each Side - Driver & Passenger. Remember to keep your Marks in line on the reassembly.

**[Illustration 28-C]** Insert strut assembly into the upper spring tower.

**[Illustration 28-D]** Using the supplied 10mm flange nuts, tighten the four (4) top bolts. {15mm}

Connect the lower strut mount to the lower control arm using the factory hardware. Hand tighten only.

**KNUCKLE ASSEMBLY...**

**[Illustration 28]**

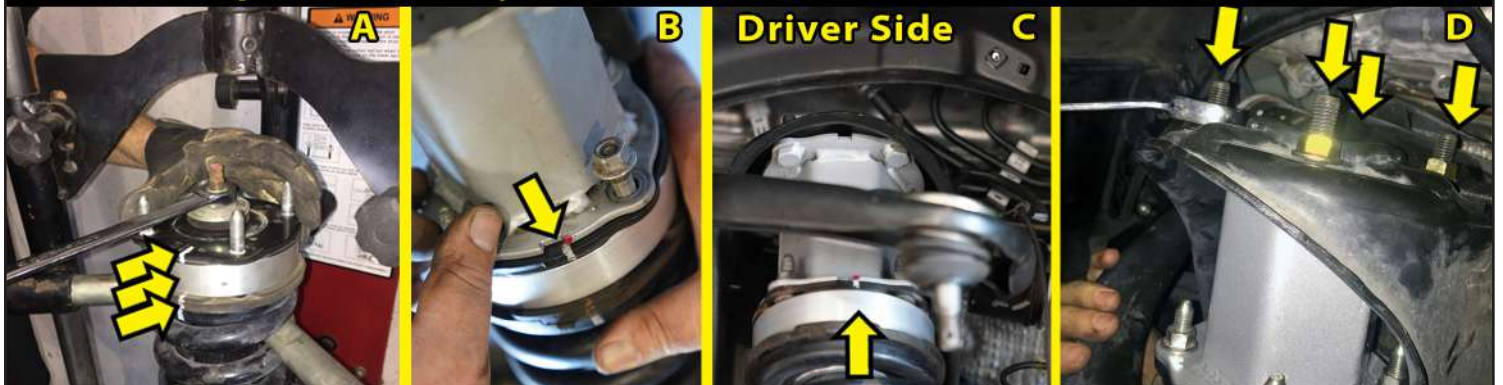
**Front Strut Spacer Assembly & Install...**

31. Locate the factory steering knuckles. Locate the SUPERLIFT Steering Knuckles. The knuckles are Specific Per Side: #66-01-8200 Driver side & #66-02-8200 Passenger side.

**TECH TIP** It is best to disassemble, then assemble one (1) side at a time to keep all the components in order. We start with the Driver side first.

**[Illustration 29-A]** Remove the ABS sensor mount from the factory knuckle. {5mm allen}

**[Illustration 29-B]** Remove the four hub bearing assembly bolts from the back side of the steering knuckle. {17mm} Remove the dust shield from the steering knuckle.

**[Illustration 29-C]** Remove the hub seal from the factory knuckle using the appropriate tool. Do not damage seal: Replace if damaged.

[Illustration 29]

**Front Knuckle Assembly...**



□□ [Illustration 29-D] Install the ABS sensor into the new knuckle with factory bolt. (5mm Allen)

□□ [Illustration 29-E] Apply thread locker to the factory hub bolts and install dust shield & hub assembly onto the new knuckle #66-01-8200 Driver side and #66-02-8200 Passenger side {17mm}

□□ [Illustration 29-F] Carefully install seal into new knuckle using the appropriate tool.

[Illustration 29]

**Front Knuckle Assembly...**

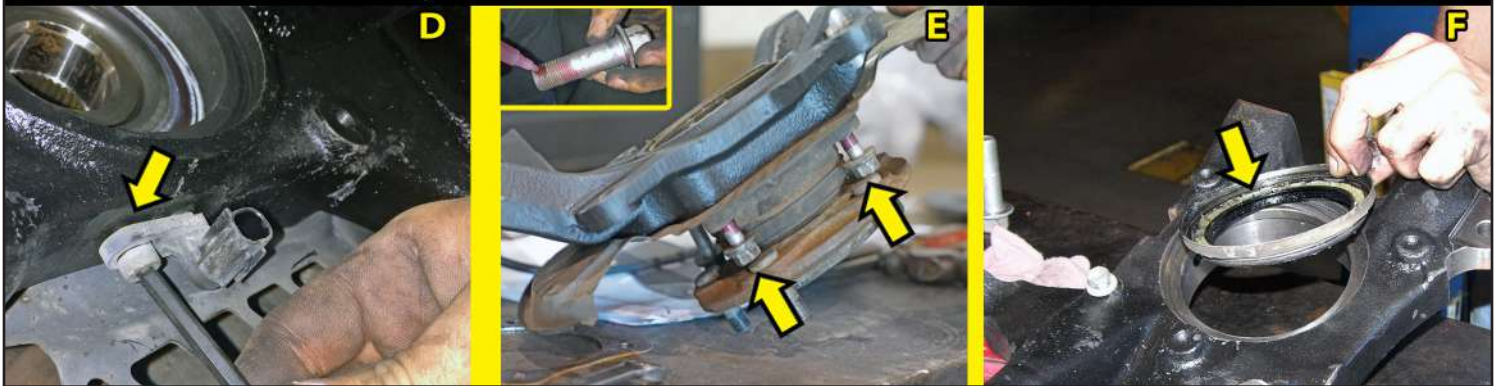

**NUCKLE INSTALL...**

□□ 32. [Illustration 30-A] Install new knuckle assembly onto the upper ball joint. Carefully slide the CV axle into the hub as you install knuckle.

□□ [Illustration 30-B] Apply thread locker onto the factory lower control arm bracket bolts and thread into new knuckle. Tighten {22mm}

□□ [Illustration 30-C] Tighten the upper ball joint {19mm} and install cotter pin.

[Illustration 30]

**Front Knuckle Install...**



### CV AXLE ATTACHMENT...

□□ 33. **[Illustration 31]** Install CV nut onto CV shaft and tighten. {39mm} Install castle cap and cotter pin. Install the dust cap by tapping edges into place. {rubber hammer}

**[Illustration 31]**

### CV Axle Nut, Castle Cap, Cotter Pin & Dust Cap...



### FRONT BRAKE LINE BRACKETS...

34. □□ **[Illustration 32-A]** Remove the factory brake line bracket from frame. {12mm}

Locate the SUPERLIFT hardware in Bag #77-8203B PER side: (1) #55-19-8200 brake line bracket, front.

Locate the SUPERLIFT hardware in Bag #77-8203 PER bracket: (1) 5/16" x 3/4" Bolt, Coarse Thread, (1) 5/16" Washer, SAE, & (1) 5/16" Nut, Nyloc Coarse Thread

□□ **[Illustration 32-B]** Install new brake line bracket #55-19-8200 onto frame in factory location using the factory hardware. The small bend goes toward the frame.

□□ **[Illustration 32-C]** Carefully reform the metal brake line to create enough slack so that the mounting foot for the bracket lines up with the bottom of the new bracket. **CAUTION:** Use extreme caution to avoid pinching or otherwise damaging the metal lines.

□□ **[Illustration 32-D]** Attach factory brake line bracket to new bracket using the supplied 5/16" x 3/4" bolt washer, and Nyloc nut {1/2"}

**[Illustration 32]**

### Front Brake Line Brackets...

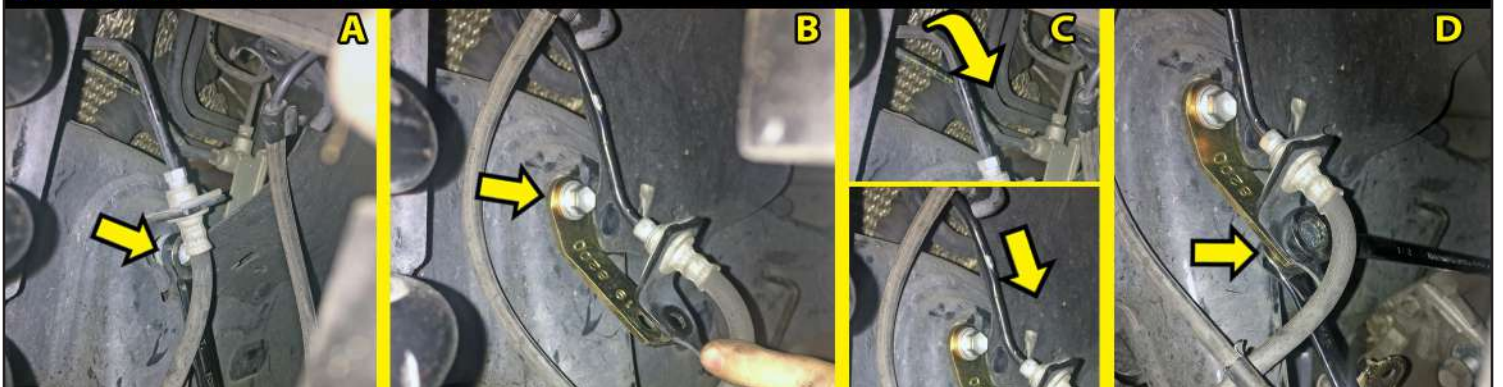

### BRAKE ROTOR & BRAKE CALIPERS...

35. **WARNING:** Toyota used two (2) different size brake caliper bolts between 2007-2018. From our research, the 2007-2015 Tundra models used 12mm bolts. 2016-2018 Tundra models used 14mm bolts. You need to check your brake caliper bolts to be sure of what you have on your truck. IF you have the 12mm bolts, SUPERLIFT has included four (4) 14mm OD x 12mm ID Sleeves: (2) for the Driver side & (2) for the Passenger side. Insert a sleeve onto each of your brake caliper bolts, then install your brake caliper as usual.

Locate the SUPERLIFT hardware bag #77-8200. PER side: (1) Thread Locker & (2) #55-44-8200 - 14mm OD x 12mm ID sleeve.

[Illustration 33]

**Brake Rotor & Brake Calipers...**

☐☐ [Illustration 33-A] Install rotor onto huds.

☐☐ [Illustration 33-B] Apply thread locker to the factory brake caliper bolts. **NOTE:** IF you have the 12mm brake caliper bolts, Insert the supplied sleeve into the knuckle BEFORE you install the caliper.

☐☐ [Illustration 33-C] Install brake caliper onto knuckle and tighten {17mm or 19mm}



**ABS & BRAKE LINE BRACKETS...**

36. **NOTE:** Reconnecting the ABS brackets to the new knuckle will require adjustment to the lines within the factory clips. **TECH TIP** (Spray a lubricant like WD40 onto the ABS line at the factory clip, this will allow you to slide the clip into the needed position).

☐☐ [Illustration 34-A] The ABS bracket that attaches to the knuckle above the hub will need the tab to be bent to be reattached. Bolt this ABS bracket to the knuckle using the factory bolt {12mm} Reconnect the ABS plug.

☐☐ [Illustration 34-B] Bolt the middle ABS/brake hose bracket to the knuckle using the factory bolt {12mm}

☐☐ [Illustration 34-C] The upper ABS bracket that attaches to the upper control arm will need to be bent up to allow for the ABS lines to be reattached. Attach bracket to the upper control arm using the factory bolt {10mm}

☐☐ [Illustration 34-D] Place ABS line in the upper bracket

[Illustration 34]

**Brake Rotor & Brake Calipers...**

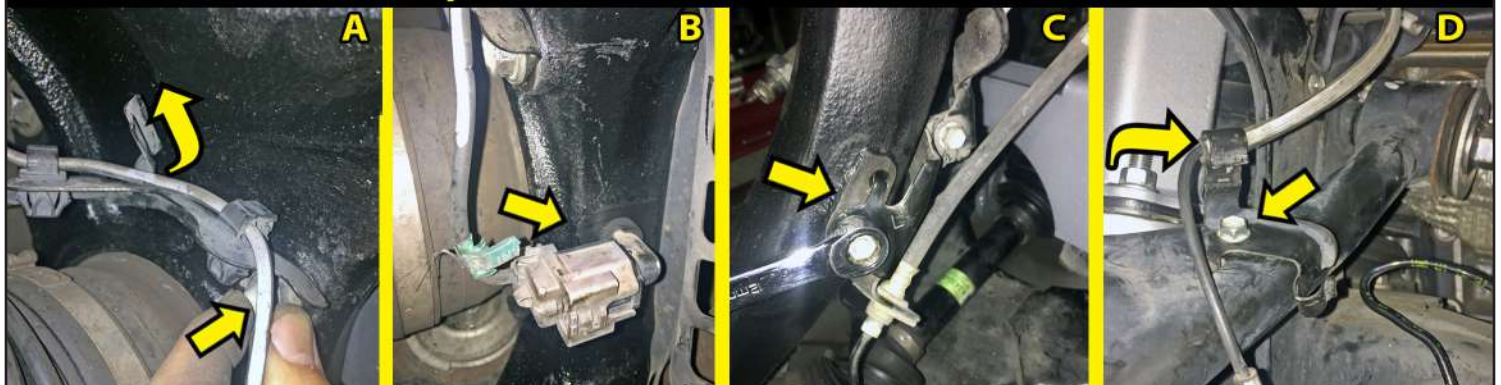

**STEERING STOPS...**

37. Locate the SUPERLIFT hardware in Bag #77-8200 PER side: (1) #55-32-8200 Steering Stop.

☐☐ [Illustration 35-A] Place the new steering stops (55-32-8200) on the lower ball joint bracket on the front steering stop.

☐☐ [Illustration 35-A] Weld 'Top & Bottom' of the steering stop to lower ball joint bracket.

☐☐ [Illustration 35-A] Clean and paint after welding.

[Illustration 35]

**Steering Stops...**



**TIE ROD ENDS...**

38. Locate the SUPERLIFT #ES800314 tie rod end (Driver side - Marked "R") and #ES800313 tie rod end (Passenger side - Marked "L").

Locate the SUPERLIFT hardware in Bag #77-8203 PER side: (1) 6mm Grease Fitting, Threaded.

Loosen the jamb nut on the tie rod end and remove the tie rod end from the vehicle. Leave jamb nut on tie rod. {30mm jam nut - 27mm tie rod}

**[Illustration 36-A]** Thread the jamb nut all the way up onto the tie rod. Measure from the threaded shaft end of the tie rod to 3/8" and Mark. Using the appropriate tool, cut the marked measurement on the tie rod.

 **TECH TIP** Remove the jamb nut from the opposite side where you are working. Thread the jamb nut onto the tie rod. Cut your Mark, then remove the extra jamb nut. This will help clear the threads of any debris.

**[Illustration 36-B]** Install the new tie rod end to the appropriate side onto the factory tie rod. #ES800314 Driver side - Marked "R" or #ES800313 Passenger side - Marked "L"

**[Illustration 36-C]** Attach the new tie rod end to the knuckle from the top side. Tighten nut & install cotter pin {24mm}

**[Illustration 36-D]** Tighten the jamb nut {30mm jam nut - 27mm tie rod}

**[Illustration 36-E]** Remove the plug from the top of the tie rod and install the new grease fitting {8mm plug - 7mm grease}

 **WARNING:** Note that the new tie rod ends Must Be Greased BEFORE vehicle is Driven.

 **NOTE:** Failure to add grease to the tie rod ends Will Void the Tie Rod Warranty.

**[Illustration 36-F]** Using a standard manual powered grease gun, attach hose coupler fitting to grease fitting. Press down squarely until you feel the 'snap' of the adapter grabbing the grease fitting.

Watch the dust boot and slowly give the grease gun a few good pumps until you see the boot begin to swell STOP as soon as you boot begins to swell. Detach the coupler from the grease fitting.

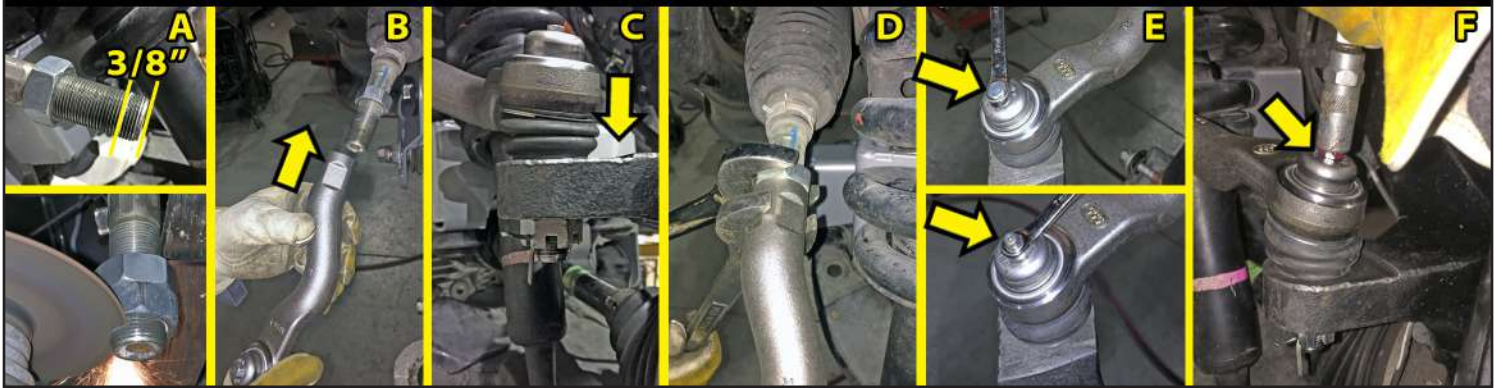
**[Illustration 36]****Tie Rod Ends...****SWAY BAR...**

39. Locate two (2) SUPERLIFT #55-18-8200 sway bar drop brackets. These are not side specific.

Locate the SUPERLIFT hardware in Bag #77-8203 PER bracket: (2) 12mm x 30mm, 1.75 Pitch, (4) 12mm Washer, Flat & (2) 12mm Nut, Nyloc

**[Illustration 37-A]** Install the new sway bar bracket #55-18-8200 onto the frame using the factory hardware at the top mount {17mm}  **NOTE:** The flat side of the bracket goes toward the outside of the vehicle.

**[Illustration 37-B]** Place the supplied 12mm x 30mm bolt, washers & nut into the forward most (front) position on the new sway bar bracket. Leave loose, but secure.

**[Illustration 37-C]** Slide the factory sway bar bracket notch hole over the front bolt, then pivot the bracket up into position to align the back mount.

**[Illustration 37-D]** Bolt the sway bar body to the sway bar brackets using the supplied 12mm x 30mm bolt, washers and nyloc. {19mm} Tighten. ( )

**[Illustration 37-E]** Install the factory sway bar links into the lower control arm factory position using the factory hardware. {19mm} Secure hardware, but snug tighten only.

**[Illustration 37]**

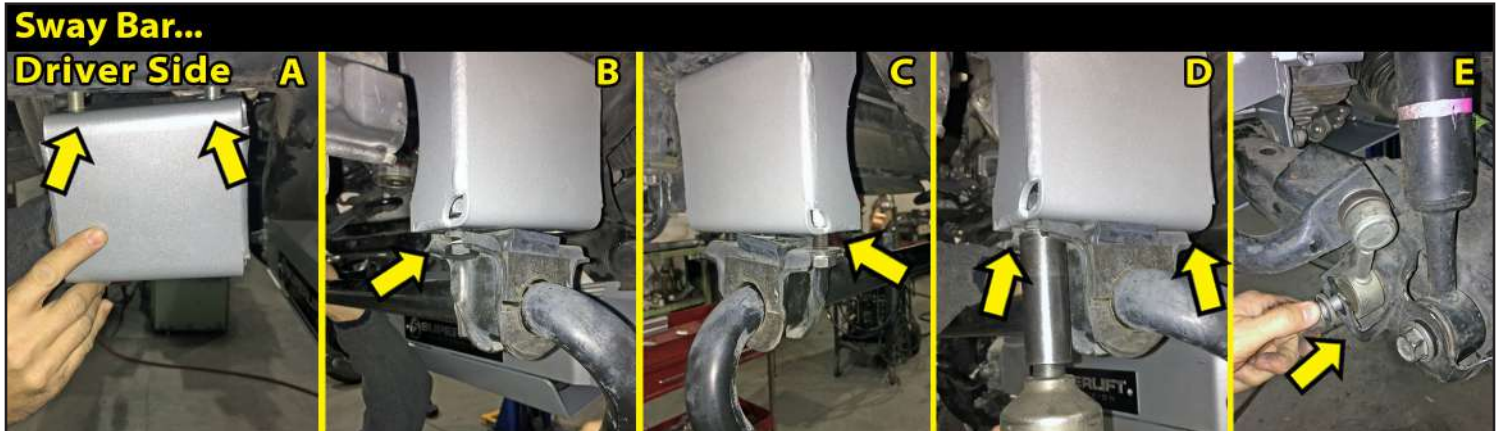

**FRONT TIGHTEN & TORQUE SEQUENCE...**

40. Now tighten and torque everything up... (All Except the upper control arms, lower control arm mounts, the lower strut mount & the sway bar links.) These will be tighten once the lift is complete and the vehicle is on the ground.

Double check all other components to be sure they are all tight & torqued.

**FRONT TIRES / WHEELS...**

41. **[Illustration 38]** Install the front tires & wheels. {Lug Nuts 22mm} (140) **⚠️WARNING:** When the tires / wheels are installed, always check for and remove any corrosion, dirt, or foreign material on the wheel mounting surface, or anything that contacts the wheel mounting surface (hub, rotor, etc.). Installing wheels without the proper metal-to-metal contact at the wheel mounting surfaces can cause the lug nuts to loosen and the wheel to come off while the vehicle is in motion.

Lower the vehicle to the ground.

**⚠️WARNING:** Retighten lug nuts at 500 miles after any wheel change, or anytime the lug nuts are loosened. Failure to do so could cause wheels to come off while vehicle is in motion.

Reconnect the battery.

**FRONT CLEARANCE CHECK...**

42. With the vehicle on the ground, cycle the steering lock-to-lock and check all components for proper operation and clearances. Pay special attention to the clearance between the tires / wheels and knuckles, brake hoses, wiring, etc.

Raise the vehicle back onto jack stands and secure as per **Step 1**. With the suspension 'hanging' at full extension travel, cycle the steering lock-to-lock and check all components for proper operation and clearances. Pay special attention to the clearance between the tires / wheels and knuckles, brake hoses, wiring, etc. Lower the vehicle to the floor.

**[Illustration 37]**

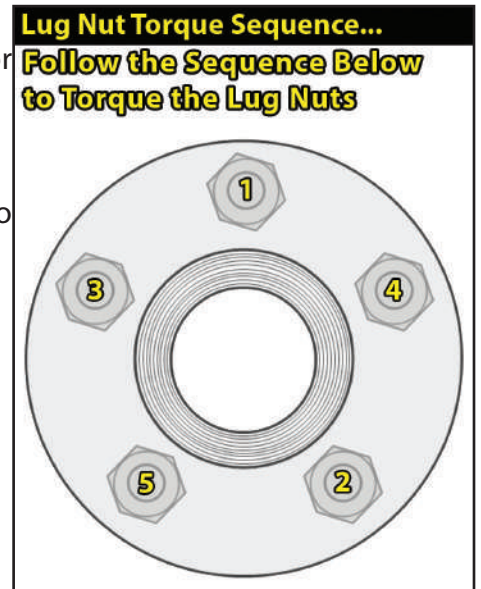

## REAR INSTALLATION

**NOTE:** Save ALL factory components and hardware for reuse, unless noted.

### 43. PREPARE VEHICLE FOR REAR...

Chock front tires and place transmission in neutral. Raise the rear of vehicle with a jack and secure a jack stand beneath each frame rail, just ahead of the front leaf spring hangers. Ease the frame down onto the stands, place transmission 'Park'. Remove the rear wheels & tires. {Lug Nuts 22mm}

Support the rear axle with a hydraulic jack. Leave plenty of room to lower the rear axle.

 **TECH TIP** Secure the axle at the drive shaft yoke with a ratchet strap. The strap acts as a safety precaution and it allows you to adjust/roll the axle as need to position axle rear blocks, u-bolts, etc.

## REAR DISASSEMBLY

### DISCONNECT REAR BRAKE BRACKETS...

44. **[Illustration 39-A]** Disconnect the brake hose bracket from the center section of the axle. {12mm}

**[Illustration 39-B]** Disconnect the brake hose tab brackets located on either side of the center brackets (left & right of the axle center section). {12mm}

**[Illustration 39-C]** Disconnect the ABS bracket from the Driver side of the axle {12mm}

**[Illustration 39-D]** Locate the e-brake bracket on the outside of the frame rail just behind the leaf spring front eye; on both the Drive & Passenger side, disconnect the emergency brake cable from the frame. {12mm}

### **[Illustration 39]**

### Disconnect Rear Brake Brackets...

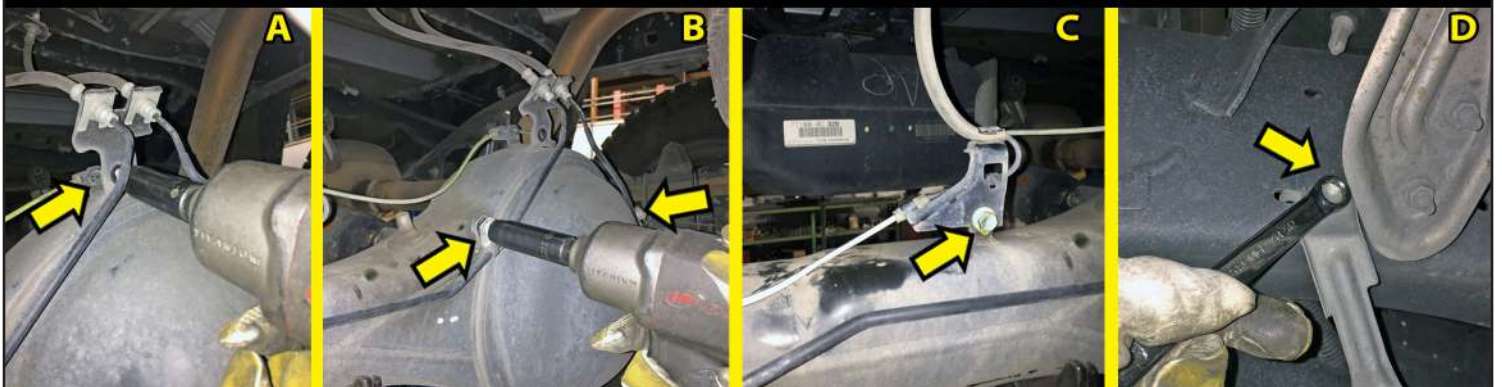

### REMOVE REAR SHOCKS...

45. **[Illustration 40-A]** Disconnect the shock from the lower mount at the axle. {17mm wrench / 17mm socket}

**[Illustration 40-B]** Disconnect the shock from the upper shock tower mount. {17mm socket}

Remove shocks. Retain lower shock mount hardware.

### REAR BLOCK KIT...

46.  **NOTE:** The u-bolt plates are Side Specific. The plates are noted on the bottom side LH and RH.

 **TECH TIP** We have found it easier to replace the blocks and u-bolts one (1) side at a time. Start on the Driver side.

**[Illustration 41-A]** Remove the u-bolts {19mm}

Clean spring pads of all debris.  **NOTE:** Fab blocks have an off-set pin and hole. **[Illustration 41-B]** Notches in block face plate goes toward Front.

For the 6 Inch, position the SUPERLIFT block #55-01-202 on top of the axle pad with the tall end facing rearward.

### **[Illustration 40]**



☐☐ For the 4.5 Inch lift, the block is flat. Position the SUPERLIFT block #55-03-202 on top of the axle pad. Using the floor jack(s), mate the springs to the blocks, be sure that the center bolt heads seat properly with the pin offset to the front and hole to the rear. Carefully lower axle enough to install new blocks. Make sure to not overextend any brake lines or ABS lines.

☐☐ **[Illustration 41-C]** Install the supplied 9/16" u-bolts. The SUPERLIFT #10502 for the 6 Inch. Install through the slotted holes in the fab block and factory u-bolt plate. For the 4.5 Inch, use the supplied #10462 with the flat fab blocks. Evenly torque the u-bolts using an "X" tightening sequence. (150) {7/8"}

☐☐ **[Illustration 41-D]** **⚠ NOTE:** On 6 Inch lifts, place (1) #55-03-200 shim between the leaf spring & top plate of the block: Front Side Only. **[Illustration 41-E]** Install the new SUPERLIFT 7/16" u-bolts (#716x314x412ub) over the leaf spring and through the new fab block. Securing with the supplied 7/16" flange nuts. 11/16"} Secure, but snug tighten only. 7/16" u-bolts will be tightened once truck is on the ground.

**[Illustration 41]**

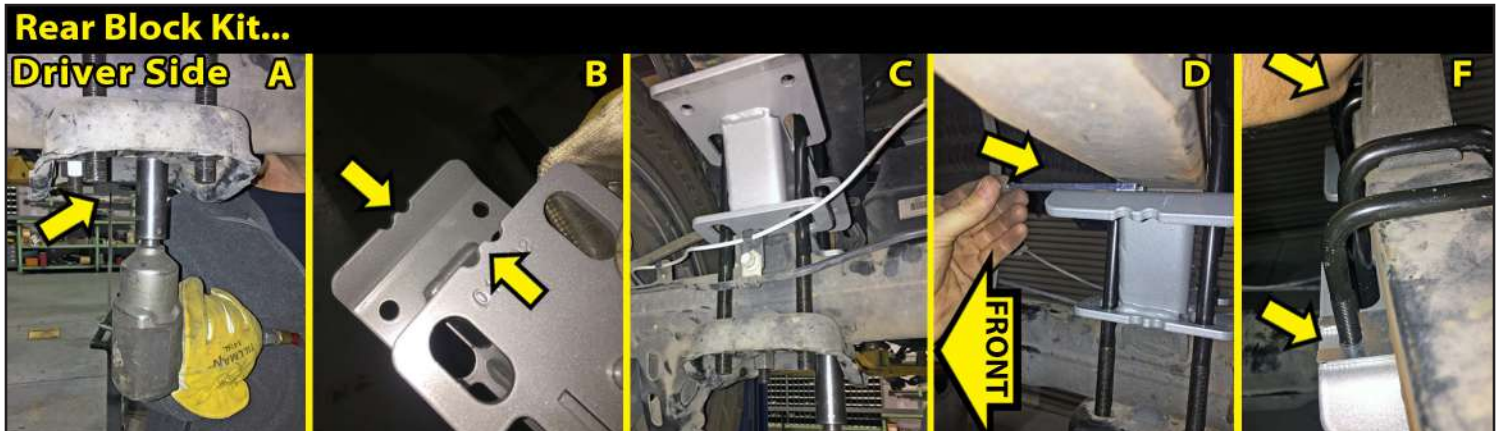

**REAR SHOCK INSTALL...**

☐47. Locate the SUPERLIFT (2) Shocks # 01-85310. Locate the hardware in Bag #77-80037. PER Side: (1) #01-60418 - 3/4" ID Bushing, (1) #24-5704 -0.75" OD x 0.50" ID x 1.5" Long Sleeve.

Locate the hardware in Bag #141991 Washer Pack.

Locate the hardware in Bag #77-60471. PER Side (2) # 01-60471 - Polyurethane Bushing, Stem.

☐☐ **[Illustration 42-A]** Lightly grease & install/press the #01-60418 - 3/4" ID bushing into the shock eye end.

☐☐ **[Illustration 42-B]** Lightly grease & install/press the #24-5704 -0.75" OD x 0.50" ID x 1.5" long sleeve into the shock eye end.

☐☐ **[Illustration 42-C]** Install the shock cylinder body end into the lower shock mount at the axle using the factory hardware. {17mm wrench / 17mm socket} (110)

☐☐ **[Illustration 42-D]** Attach the rod end of the shock to the upper mount at the frame using the supplied #141991 washer pack & #77-60471 stem bushings. {17mm} (110)

**[Illustration 42]**



**INSTALL EMERGENCY BRAKE BRACKETS...**

48. Locate the (2) SUPERLIFT brackets in Bag #77-8203B: #55-21-8200 Emergency Brake, Rear.

Locate the hardware in Bag #77-8203. PER Bracket: (1) 5/16" x 3/4" Bolt, Coarse Thread, (2) 5/16" Washer, SAE, & (1) 5/16" Nut, Nyloc Coarse Thread

**[Illustration 43]**

**[Illustration 43-A]** Locate the emergency brake line bracket that attaches to the axle toward the wheel.

**[Illustration 43-B]** Install (1) emergency brake line bracket #55-21-8200 onto the axle. On the Driver side, the bracket is installed with the 'Notched End' at the Bottom axle mount using the factory bolt at the axle. {12mm} Attach the emergency brake line to the Driver emergency brake bracket using the supplied 5/16" x 3/4" bolt, washers, and Nyloc {1/2"}

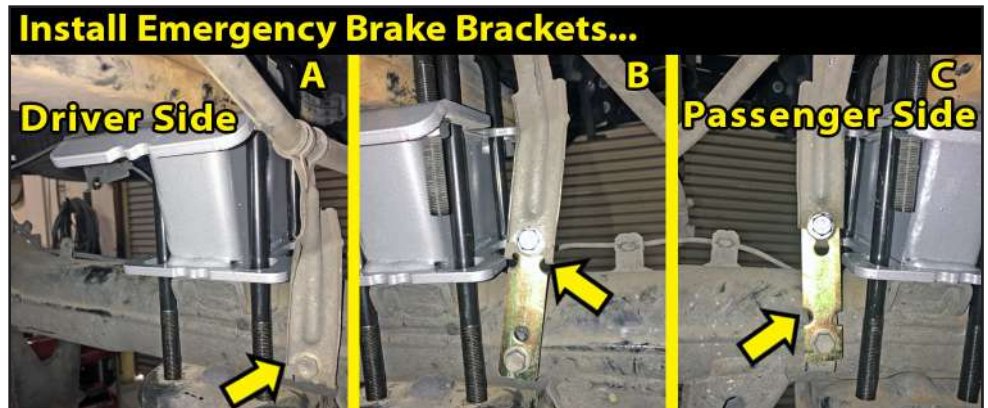

**[Illustration 43-C]** Install (1) emergency brake line bracket #55-21-8200 onto the axle. On the Passenger side, the bracket is installed with the 'Notched End' at the Top. Using the factory bolt, attach the bracket at the axle mount. {12mm} Attach the emergency brake line to the passenger emergency brake bracket using the supplied 5/16" x 3/4" bolt, washer, and Nyloc {1/2"}

**INSTALL REAR ABS & BRAKE BRACKETS...**

49. Locate the (2) SUPERLIFT brackets in Bag #77-8203B: #55-43-8200 Brake Bracket, Rear. Locate the hardware in Bag #77-8203. PER Bracket: (1) 5/16" x 3/4" Bolt, Coarse Thread, (2) 5/16" Washer, SAE, & (1) 5/16" Nut, Nyloc Coarse Thread

**[Illustration 44-A]** In front of and above the rear axle, locate the canister with the ABS lines bracket. Carefully bend the ABS bracket down to allow for more slack.

**[Illustration 44-B]** Install the new brake line bracket #55-43-8200 onto the center axle bracket using the factory bolt. {12mm} Attach the brake line bracket to the new bracket using the supplied 5/16" x 3/4" bolt, washers and Nyloc nut. {1/2"}

**[Illustration 44-C]** Install the new ABS line bracket #55-43-8200 onto the Driver axle bracket using the factory bolt. {12mm} Attach the ABS lines to the new bracket using the supplied 5/16" x 3/4" bolt, washers, and Nyloc nut. {1/2"}

**[Illustration 44-D]** Locate the (2) brake line bracket tabs located on either side of the center brackets (left & right of the axle center section). Rotate the tabs on the brake line 180 degrees, so that the tab attachment point is pointing downward and the brake line is above. Reattach in factory location using factory bolt {12mm}

**[Illustration 44]**

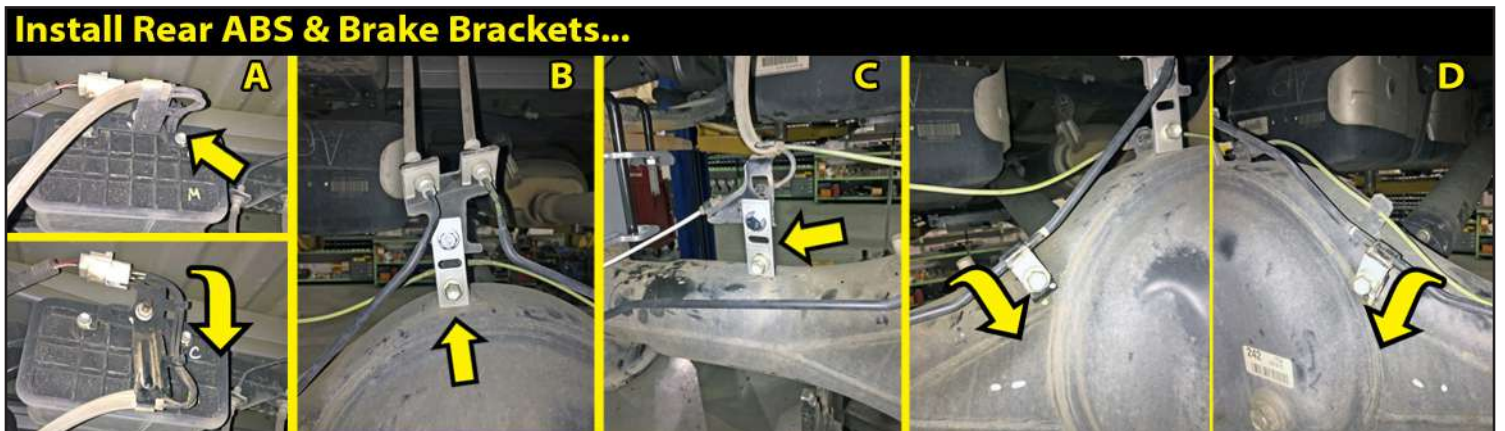

**REAR CARRIER BEARING DROP...**

50. Locate the hardware in Bag #77-8203. Includes two (2) of each size spacer:

- #55-23-8200 - Carrier Bearing Spacer, 0.1875"
- #55-24-8200 - Carrier Bearing Spacer, 0.2500"
- #55-25-8200 - Carrier Bearing Spacer, 0.3750"
- #55-26-8200 - Carrier Bearing Spacer, 0.5000"

**[Illustration 45-A]** Follow the rear driveshaft forward from the rear axle and locate the carrier bearing mount at the frame. Remove (1) of the factory bolts on the rear carrier bearing.

**[Illustration 45-B]** Place (1) #55-24-8200 - 1/2" spacer between the frame and the carrier bearing bracket. {14mm} Repeat the process on the other side of driveshaft. Tighten both bolts.

**[Illustration 45]**



**⚠ NOTE:** This is a starting point of adjustment for driveshaft vibration. If you have a vibration during acceleration, make adjustments by adding or removing spacers. Adjust as needed, but always make even adjustments to both sides.

**REAR TIRES / WHEELS...**

51. **[Illustration 46]** Install the rear tires & wheels. {Lug Nuts 22mm}

**⚠ WARNING:** When the tires / wheels are installed, always check for and remove any corrosion, dirt, or foreign material on the wheel mounting surface, or anything that contacts the wheel mounting surface (hub, rotor, etc.). Installing wheels without the proper metal-to-metal contact at the wheel mounting surfaces can cause the lug nuts to loosen and the wheel to come off while the vehicle is in motion.

Lower the vehicle to the ground.

**OVERALL TIGHTEN & TORQUE SEQUENCE...**

52. **[Illustration 47]** Tightening sequence... Bounce the front end to settle the suspension.

- Lower control arms with cams in the "neutral position" {24mm} (200)
- Sway bar links {19mm} (90)
- Strut lower bolt {22mm} (140)
- 7/16" u-bolts over the leaf spring on new fab block {11/16"} (45)
- Torque lug nuts on all four (4) wheels {22mm} (140)

**[Illustration 46]**

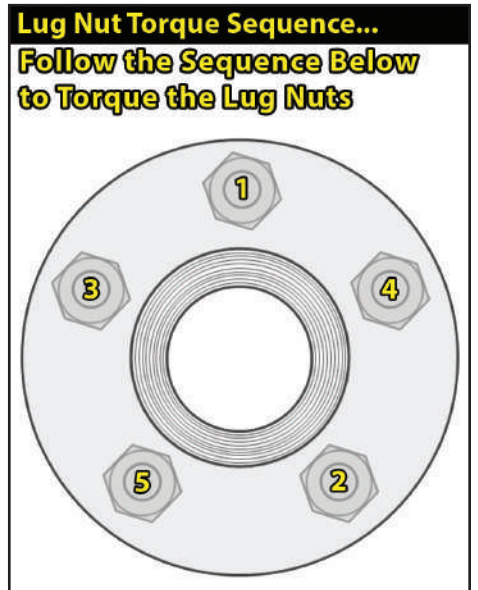

**[Illustration 47]**



## FINAL CHECKS

### CLEARANCE CHECK...

53. Check all hardware for proper torque specifications.

With the vehicle on the ground, check all components for proper operation and clearances. Pay special attention to the clearance between the tires / wheels, brake hoses, wiring, etc. Check tire/wheel clearance with the fenders/bumper as well as with the steering knuckle. **⚠️ NOTE:** Depending on your choice of tire size and wheel width, it is not uncommon to trim the lower plastic valance of the bumper and inner fender shroud slightly to add proper tire clearance while turning.

### WHEEL ALIGNMENT...

54. Realign vehicle to factory OEM specifications. It is necessary to have a proper and professional wheel alignment performed by a certified alignment technician. It is recommended that your vehicle alignment be checked after any off-road driving.

### HEADLIGHTS...

55. Re-adjust headlights to proper setting. In addition to your vehicle alignment, for your safety and others, it is necessary to check and adjust your vehicle head lamps for proper aim and alignment.

### FOUR WHEEL DRIVE...

56. Activate the four wheel drive system and check for proper engagement.

### SUPERLIFT WARNING DECAL...

57. Install the **WARNING TO DRIVER** decal on the inside of the windshield, sun visor or on the dash, within Driver's view.

## IMPORTANT MAINTENANCE INFORMATION

**⚠️ WARNING:** It is the ultimate buyer's responsibility to have all bolts / nuts checked for tightness after the first 100 miles and then every 1000 miles. The steering, suspension and driveline systems, plus wheel alignment should be inspected by a qualified professional mechanic at least every 3000 miles.

## LIMITED LIFETIME WARRANTY / WARNINGS

Your SUPERLIFT® product is covered by the Limited Warranty explained below that gives you specific legal rights. This limited warranty is the only warranty SUPERLIFT® makes in connection with your product purchase. SUPERLIFT® neither assumes nor authorizes any retailer or other person or entity to assume for it any other obligation or liability in connection with this product or limited warranty.

### SUPERLIFT, LLC, LIMITED LIFETIME WARRANTY

What is covered? Subject to the terms below, SUPERLIFT® will repair or replace its products found defective in materials or workmanship for so long as the original purchaser owns the vehicle on which the product was originally installed. Your warranter is SUPERLIFT, LLC, doing business as SUPERLIFT® Suspension Systems ("SUPERLIFT®").

What is not covered? Your SUPERLIFT® Limited Warranty does not cover products SUPERLIFT® determines to have been damaged by or subjected to:

- Alteration, modification or failure to maintain.
- Normal wear and tear (bushings, rod ends, etc.). Scratches or defects in product finishes (powder coating, plating, etc.).
- Damage to, or resulting from, the vehicle's electronic stability system, related components or other vehicle systems.
- Racing or other vehicle competitions or contests. Accidents, impact by rocks, trees, obstacles or other aspects of the environment.
- Theft, vandalism or other intentional damage.

**FORM#8200-07132018**

Remedy Limited to Repair or Replacement. The exclusive remedy provided hereunder shall, upon SUPERLIFT's inspection and at SUPERLIFT's option, be either repair or replacement of the product covered under this Limited Warranty. All removal, shipping and installation costs are customer's responsibility.

If a replacement part is needed before the SUPERLIFT® part in question can be returned, you must first purchase the replacement part. Then, if the part in question is deemed warrantable, you will be credited / refunded.

**OTHER LIMITATIONS - EXCLUSION OF DAMAGES - YOUR RIGHTS UNDER STATE LAW**

- Neither SUPERLIFT® nor your independent SUPERLIFT® dealer are responsible for any time loss, rental costs, or for any incidental, consequential or other damages you may have.
- This Limited Warranty gives you specific rights, and this is the only warranty SUPERLIFT® makes in connection with your product purchase. You may also have other rights that vary from state to state. For example, while all implied warranties are disclaimed herein, any implied warranty required by law is limited to the terms of our Limited Lifetime Warranty as described above. Some states do not allow limitations of how long an implied warranty lasts and / or do not allow the exclusion or limitation of incidental or consequential damages, so the limitations and exclusions herein may not apply to you. SUPERLIFT® neither assumes nor authorizes any retailer or other person or entity to assume for it any other obligation or liability in connection with this product or Limited Warranty.

**IMPORTANT PRODUCT USE AND SAFETY INFORMATION / WARNINGS**

**⚠ WARNING:** As a general rule, the taller a vehicle is, the easier it will roll over. Offset, as much as possible, what is lost in rollover resistance by increasing tire track width. In other words, go "wide" as you go "tall"; always use as wide a tire and wheel combination as feasible to enhance vehicle stability. We strongly recommend, because of rollover possibility, that the vehicle be equipped with a functional roll bar and cage system. Seat belts and shoulder harnesses should be worn at all times. Avoid situations where a side rollover may occur.

Generally, braking performance and capabilities are decreased when significantly larger / heavier tires and wheels are used. Take this into consideration while driving. Also, changing axle gear ratios or using tires that are taller or shorter than factory height will cause an erroneous speedometer reading. On vehicles equipped with an electronic speedometer, the speed signal impacts other important functions as well. Speedometer recalibration for both mechanical and electronic types is highly recommended.

Do not add, alter, or fabricate any factory or aftermarket parts to increase vehicle height over the intended height of the SUPERLIFT® product purchased. Mixing component brands is not recommended.