



SUPERLIFT[®]

S U S P E N S I O N

2007 - 2017 GM 1500 PICKUP 8" INSTALLATION INSTRUCTIONS



K Kit Breakdown					
Kit Part Number K899 - 4WD			Kit Part Number K897 - 2WD		
Component	Qty	Component Description	Component	Qty	Component Description
3570	1	knuckles , AL/SS OE UCA	3570	1	knuckles , Cast ST OE UCA
3585	1	crossmember, strut spacer, shocks	3585	1	crossmember, strut spacer, shocks
3584	1	crossmember, differential drops, axle spacers	3582	1	rear crossmember
3508	1	rear blocks	3508	1	rear blocks
OR			OR		
Kit Part Number K898 - 4WD			Kit Part Number K894 - 2WD		
Component	Qty	Component Description	Component	Qty	Component Description
3574	1	knuckles , Cast ST OE UCA	3574	1	knuckles , Cast ST OE UCA
3585	1	crossmember, strut spacer, shocks	3585	1	crossmember, strut spacer, shocks
3584	1	crossmember, differential drops, axle spacers	3582	1	rear crossmember
3508	1	rear blocks	3508	1	rear blocks

Kit Box Breakdown					
Kit Part Number 3570			Kit Part Number 3585		
Component	Qty	Component Description	Component	Qty	Component Description
66-01-3570	1	Knuckle, Dr Side 8" Chevy, AL OE LCA	01-85160	2	Shock Cylinder
66-02-3570	1	Knuckle, PA Side 8" Chevy, AL OE LCA	55-25-3570	1	Brkt, Front Crossmember
77-3491	1	Hardware Bag	55-07-3500	1	Brkt, Sway Bar Drop Driver
77-3570	1	Hardware Bag	55-08-3500	1	Brkt, Sway Bar Drop Passenger
OR			OR		
Kit Part Number 3574			Kit Part Number 3508		
Component	Qty	Component Description	Component	Qty	Component Description
66-41-3570	1	Knuckle, Dr Side 8" Chevy, MS OE LCA	77-3486	1	Hardware Bag
66-42-3570	1	Knuckle, PA Side 8" Chevy, MS OE LCA	77-3488A	1	Hardware Bag
77-3491	1	Hardware Bag	77-3500	1	Hardware Bag
Kit Part Number 3584			Kit Part Number 3582		
Component	Qty	Component Description	Component	Qty	Component Description
55-13-3570	1	Brkt, Differential Drop - DR Side	55-01-201	2	Rear Lift Block 8"
55-14-3570	1	Brkt, Differential Drop - PA Side	10552	4	U-Bolt, 9/16" X 2-1/2" X 16" Sq
55-16-3570	1	Brkt, Rear Crossmember	77-1509	1	9/16" Hi-Nut & Flat Washer Kit
55-19-3570	1	Brkt, Belly Pan - 4wd	77-1707	1	7/16" Ubolt and Hardware Bag
66-15-3330	2	Mach, Axle Spacer	Kit Part Number 3582		
77-3500-2	1	Hardware Bag	Component	Qty	Component Description
77-3584	1	Hardware Bag	55-16-3570	1	Brkt, Rear Crossmember
			77-3500-2	1	Hardware Bag

Hardware Bag Breakdown					
Kit Part Number 77-1509			Kit Part Number 77-3500		
Component	Qty	Component Description	Component	Qty	Component Description
1509	8	Hi-Nut, 9/16" Fine	13-3500	1	3/16" ID X 3/8" OD Tubing 8" Long, Vacuum
1559	8	9/16" U-Bolt Flat washer	16MDN	1	16mm x 1.5 Hex Die Nut
Kit Part Number 77-3486			Kit Part Number 77-3500-2		
Component	Qty	Component Description	Component	Qty	Component Description
14C5NN	2	Nyloc Nut, 1/4" Coarse	716F8SFN	6	Flange Nut, 7/16" Fine
14X1C5CS	2	Bolt, 1/4" X 3/4" Coarse	12-3492	2	sway bar link tube
38X1C5CS	2	3/8" x 1" bolt, coarse thread	38X12C5CS	2	Bolt, 3/8" X 12" coarse thread
38SW	4	3/8" sae washer	145098	3	washer hardware bag
38C5NN	2	3/8" nyloc nut	Kit Part Number 77-3570		
55-09-3492	2	Brkt, Frt Brake line Dr	Component	Qty	Component Description
Kit Part Number 77-3488A			58C8SN	2	Stover Nut, 5/8" Coarse
Component	Qty	Component Description	58SW	4	Flat Washer, 5/8" SAE
10MFW	8	Washer, 10mm Flat	58X512C5CS	2	Bolt, 5/8" X 5-1/2" Coarse
10MNN	4	Nyloc Nut, 10mm X 1.5	Kit Part Number 77-3584		
10MX1.5X25CS	4	Bolt, 10mm X 1.5 X 25mm	Component	Qty	Component Description
1112CT	2	Cable Tie, 11-1/2" Black	14MX2.0X50FB	2	14mm x 2.0 x 50mm flange head bolt
58C8SN	2	Stover Nut, 5/8" Coarse	12-3492	2	Sway Bar Link
58SW	4	Flat Washer, 5/8" SAE	38X12C5CS	2	Bolt, 3/8" x 12" Coarse
58X412C5CS	2	Bolt, 5/8" X 4-1/2" Coarse	145098	3	Bushing and Washer Pack
Kit Part Number 77-3491			Kit Part Number 77-1507		
Component	Qty	Component Description	Component	Qty	Component Description
516X1STB	2	Bolt, 5/16" X 1" Self Tapping	12X134C5CS	2	Bolt, 1/2" X 1-3/4" Coarse
F470L	1	Thread Locker #27105	16-9690	1	3/16" ID X 3/8" OD Tubing 4" Long, Vacuum
14MX2.0X50FB	4	Bolt, 14mm x 2.0 x 50mm Flange Head	17-9690	1	3/16" Vacuum Connector
Kit Part Number 77-1507			58C8SN	2	Stover Nut, 5/8" Coarse
Component	Qty	Component Description	58X134C5CS	1	Bolt, 5/8" x 1-3/4" Coarse
716X314X412UB	4	7/16" x 3-1/4" x 4-1/2" ubolt, square bend	58X212C5CB	1	Bolt, 5/8" x 2-1/2" Carriage, Coarse
716F8SFN	8	7/16" flange nut, fine thread	58SW	4	Flat Washer, 5/8" SAE
Kit Part Number 77-80033			1555	2	5/8" U-Bolt Flat washer
Component	Qty	Component Description	38X1C5CS	4	Bolt, 3/8" X 1" Coarse
01-60418	4	Poly Bush, 3/4" X 1.44" Sm. Hourglass Eye	38SW	8	Flat Washer, 3/8" SAE
34SW	4	Washer, 3/4" Flat Sae	38C5FN	4	Flange Nut, 3/8" Coarse
39-3480	4	Shock Sleeve, 0.750" OD x 0.563" ID x 1.68" L			

Step	Component	Qty.	Component Description	Qty.	New Attaching Hardware	Hardware Bag Number
19	55-14-3570	1	Brkt, Differential Drop - PA Side - 4wd	1	3/16" ID X 3/8" OD Tubing 4" Long, Vacuum	77-3584
				1	3/16" Vacuum Connector	
				1	Bolt, 5/8" x 1-3/4" Coarse	
				1	Bolt, 5/8" x 2-1/2" Carriage, Coarse	
				2	5/8" U-Bolt Flat washer	
				2	Nyloc Nut, 5/8" Coarse	
20	55-13-3570	1	Brkt, Differential Drop - DR Side - 4wd	2	Bolt, 1/2" X 1-3/4" Coarse	77-3584
				2	Bolt, 12mm X 1.75 X 30mm	
				2	Flat Washer, 1/2" SAE	
				2	Lock Washer, 12mm	
				2	Stover Nut, 1/2" Coarse	
22	55-25-3570	1	Brkt, Front Crossmember	2	Bolt, 5/8" X 4-1/2" Coarse	77-3488A
				4	Flat Washer, 5/8" SAE	
				2	Stover Nut, 5/8" Coarse	
23	55-16-3570	1	Brkt, Rear Crossmember	2	Bolt, 5/8" X 5-1/2" Coarse	77-3500-2
				4	Flat Washer, 5/8" SAE	
				2	Stover Nut, 5/8" Coarse	
26	55-19-3570	1	Brkt, Belly Pan - 4wd	4	Bolt, 3/8" X 1" Coarse	77-3584
				8	Flat Washer, 3/8" SAE	
				4	Flange Nut, 3/8" Coarse	
28	55-20-3570	2	Front Strut Spacer for 8" kit	3	Flange Nut, 7/16" Fine	77-3500
29	66-15-3330	2	Mach, Axle Spacer	6	Bolt, 10mm X 1.5 X 70mm	77-3584
				6	Washer, 10mm Flat	
30	66-01-3570	1	Knuckle, Dr Side 8" Chevy, AL OE LCA	1	Bolt, 5/16" X 1" Self Tapping	77-3491
				0.5	Thread Locker #27105	
	66-41-3570	1	Knuckle, Dr Side 8" Chevy, MS OE LCA	2	Bolt, 14mm x 2.0 x 50mm Flange Head	77-3570
30	66-02-3570	1	Knuckle, PA Side 8" Chevy, AL OE LCA	1	Bolt, 5/16" X 1" Self Tapping	77-3491
				0.5	Thread Locker #27105	
	66-42-3570	1	Knuckle, Dr Side 8" Chevy, MS OE LCA	2	Bolt, 14mm x 2.0 x 50mm Flange Head	77-3570
33	55-09-3492	2	Brkt, Frt Brake line	1	3/8" x 1" bolt, coarse thread	77-3486
				2	3/8" sae washer	
				1	3/8" nyloc nut	
				1	1/4" x 1" bolt, coarse thread	
				2	1/4" sae washer	
				1	1/4" nyloc nut	
39	55-07-3500	1	Brkt, Sway Bar Drop Driver	2	Bolt, 10mm X 1.5 X 25mm	77-3488A
				2	Nyloc Nut, 10mm X 1.5	
				4	Washer, 10mm Flat	
39	55-08-3500	1	Brkt, Sway Bar Drop Passenger	2	Bolt, 10mm X 1.5 X 25mm	77-3488A
				2	Nyloc Nut, 10mm X 1.5	
				4	Washer, 10mm Flat	
39	12-3492	2	sway bar link	1	3/8" x 12" bolt, coarse thread	77-3570
				2	145098 washer bag	
49	55-01-201	2	Rear Lift Block 8"	2	U-Bolt, 9/16" X 2-1/2" X 16" Sq	77-1509
				4	Hi-Nut, 9/16" Fine	
				4	9/16" U-Bolt Flat washer	
				2	7/16" x 3-1/4" x 4-1/2" ubolt, square bend	
4	7/16" flange nut, fine thread					
50	01-85160	2	Shock Cylinder	2	Poly Bush, 3/4" X 1.44" Sm. Hourglass Eye	77-80033
				2	Shock Sleeve, 0.750" OD x 0.563" ID x 1.68" L	
				2	Washer, 3/4" Flat Sae	



2007 - 2017 GM 1500 PICKUP 8'' INSTALLATION INSTRUCTIONS

THANK YOU FOR CHOOSING SUPERLIFT FOR ALL YOUR SUSPENSION NEEDS!!

INTRODUCTION

Installation requires a professional mechanic.

Prior to beginning, inspect the vehicles steering, driveline, and brake systems, paying close attention to the suspension link arms and bushings, sway bars and bushings, tie rod ends, pitman arm, ball joints and wheel bearings. Also check the steering sector-to-frame and all suspension-to-frame at-taching points for stress cracks. The overall vehicle must be in excellent working condition; repair or replace all worn parts.

Read instructions several times before starting. Be sure you have all needed parts and know where they install. Read each step completely as you go.

NOTES:

- Prior to beginning the installation, check all parts and hardware in the box with the parts list below. If you find a packaging error, contact Superlift directly. Do not contact the dealer where the system was originally purchased. You will need the control number from each box when calling; this number is located at the bottom of the part number label and to the right of the bar code.
- Do not fabricate any components to gain additional suspension height.
- Front end realignment is necessary.
- A foot-pound torque reading is given in parenthesis () after each appropriate fastener
- Tool and Wrench/Socket size is given in brackets { } after each appropriate step.
- Prior to drilling or cutting, check behind the surface being worked on for any wires, lines, or hoses that could be damaged. Prep all cutting surfaces by removing all debris and frame coatings.
- After drilling, file smooth any burrs and sharp edges.
- Prior to operating a torch or saw, protect any heat-sensitive components located in the immediate area by covering them with a water-saturated cloth. Most undercoating are flammable but can be extinguished using a water-filled spray bottle. Have a spray bottle and an ABC rated fire extinguisher on hand.
- Paint or undercoat all exposed metal surfaces.

- Prior to attaching components, be sure all mating surfaces are free of grit, grease, undercoating, etc.
- A factory service manual should be on hand for reference.
- Use the check-off box “☐” found at each step to help you keep your place. Two “☐☐” denotes that one check-off box is for the driver side and one is for the passenger side. Unless otherwise noted, always start with the driver side.

IMPORTANT TIRE / WHEEL and CLEARANCE DATA

Neither factory nor aftermarket 17” wheels will work with this lift system.

A 0.25” wheel spacer must be used if factory 18” or 20” wheels are used.

Maximum tire diameter and width for use on the factory 18” wheel (8.5” wide with 5.3” backspacing) is 34.0” x 10.50”.

Maximum tire diameter and width for use on the factory 20” wheel (9.0” wide with 6.0” backspacing) is 35.0” x 12.50”.

2007-2016 Models

Recommended 18” wheel dimensions are 8.0” - 8.5” wide with 4.5” - 5.0” backspacing.

Recommended tire for aftermarket 18” wheels is a 34.0” x 10.5”

Recommended 20” wheel dimensions are 8.0” - 9.5” wide with 4.5” - 5.75” backspacing.

Recommended tire for aftermarket 20” wheels is a 35.0” x 12.5”

2017 Models

Recommended 18” wheel dimensions are 8.0” - 8.5” wide with 4.5” or less backspacing.

Recommended tire for aftermarket 18” wheels is a 34.0” x 10.5”

Recommended 20” wheel dimensions are 8.0” - 9.5” wide with 4.5” or less backspacing.

Recommended tire for aftermarket 20” wheels is a 35.0” x 12.5”

	Tools	
	Misc.	Wrench / Socket Sizes
floor jack	Standard	Metric
jack stands	1/2"	8mm
hammer	9/16"	10mm
plastic fastern removal tool	7/8"	11mm
die grinder w/cut-off wheel	5/16" allen	13mm
torque wrench		15mm
9/32" drill bit		17mm
drill		18mm
screwdriver		21mm
adjustable pliers		22mm
vise grips		24mm
		35mm
		5mm allen
		T30 torx

FRONT DISASSEMBLY

NOTE: Save all factory components and hardware for reuse, unless noted.

1) PREPARE VEHICLE...

Chock rear tires and place transmission in neutral. Raise front of vehicle with a jack and secure a jack stand beneath each frame rail. Ease the frame down onto the stands and place transmission in park. Remove front tires. {Lug Nuts 22mm}

Disconnect the battery.

[Illustration 1] Remove any factory skid plates or belly pans that block access to front suspension components. {10mm, 15mm}

2) SWAY BAR BODY AND LINKS...

[Illustration 2] On each side, loosen and remove the bushings and hardware attaching the sway bar link to the lower control arm and the sway bar body. {15mm}

[Illustration 3] Note the orientation of the sway bar for reference during reassembly. Remove the bolts securing the sway bar to the frame and remove the bar. {10mm}

Illustration 1

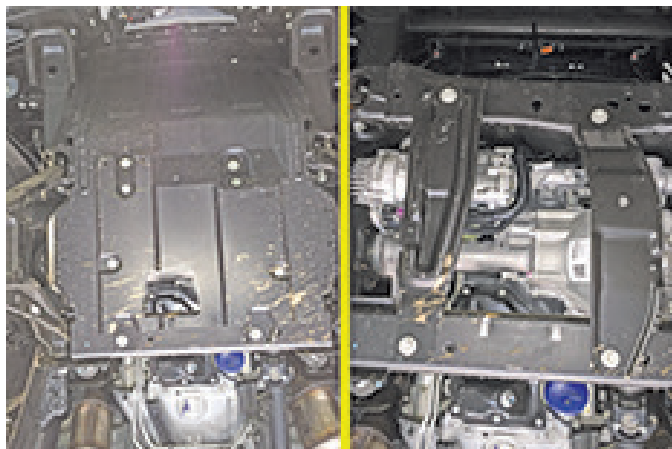


Illustration 2



Illustration 3



Perform steps 3 through 12 one side at a time.

3) STEERING TIE ROD END...

□□ [Illustration 4] Remove the nut from the tie rod end and using the appropriate puller tool, remove tie rod from knuckle. If you do not have a puller tool you can use a hammer, by very carefully striking the tie rod boss of the knuckle; do not strike the tie rod end. {21mm}

4) BRAKE LINE BRACKET AND ABS SENOR WIRE...

□□ [Illustration 5] Unclip the ABS lines from the brake line bracket on the upper control arm. {plastic fastener removal tool}

□□ [Illustration 6] Unclip the ABS lines from the brake line bracket located on the frame. {plastic fastener removal tool}

□□ [Illustration 7] Locate the brake line bracket on the steering knuckle and remove. {10mm}

□□ [Illustration 8] Unbolt the brake line bracket from the upper control arm. {10mm}

Illustration 4

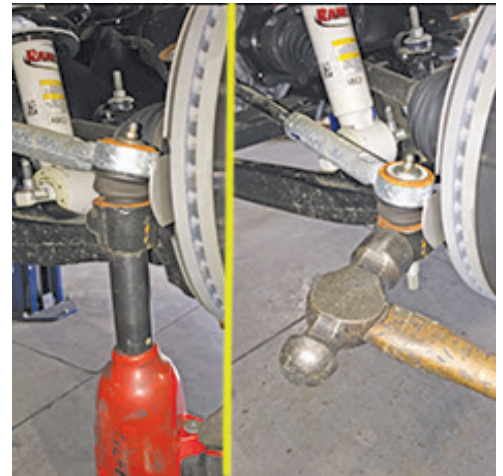


Illustration 5

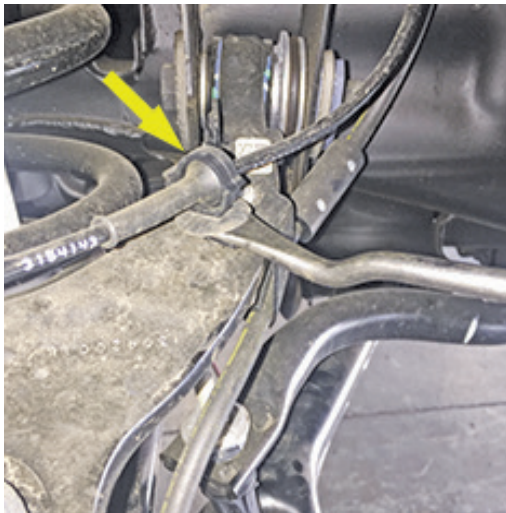


Illustration 6



Illustration 7



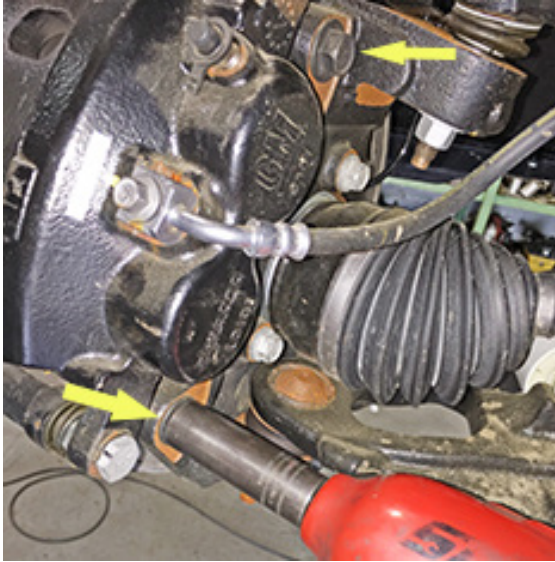
Illustration 8



5) BRAKE CALIPER...

□□ [Illustration 9] Unbolt the brake caliper and remove from the rotor and secure it away from the work area. NOTE: Do not let calipers hang from brake lines. {18mm}

□□ [Illustration 10] Remove the torx bolt retaining the rotor to the hub assembly, remove the brake rotor, and set it aside. {T30}

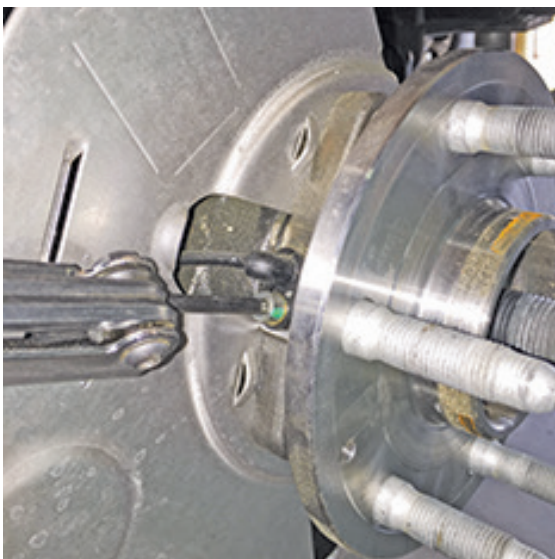
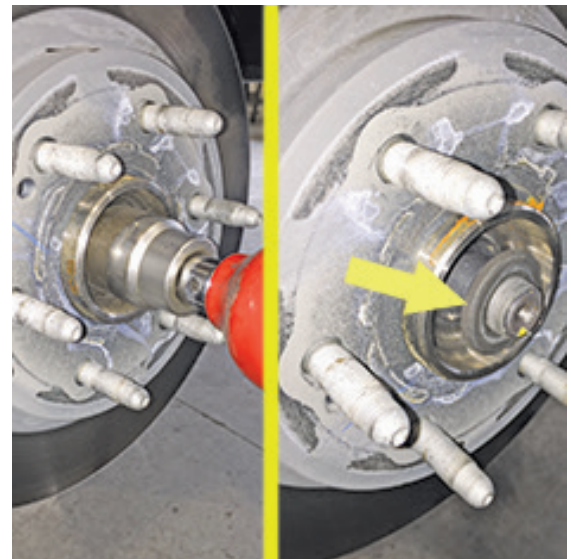
Illustration 9**Illustration 10****6) ABS SENSOR...**

□□ [Illustration 11] Unbolt and remove the ABS sensor from the hub assembly. {5mm allen}

7) CV AXLE SHAFT NUT...

NOTE: For 2WD systems, proceed to the next step.

□□ [Illustration 12] Remove the nut and washer securing the axle shaft to the hub assembly. {35mm}

Illustration 11**Illustration 12**

8) KNUCKLE...

□□ [Illustrations 13 & 14] Remove the nuts from the upper and lower ball joints, then using the appropriate puller tool, disconnect the ball joints from the knuckle. If you do not have a puller tool you can use a hammer by very carefully striking the ball joint boss' of the knuckle; do not strike the ball joints. Remove knuckle from vehicle. {upper ball joint 18mm, lower ball joint 24mm}

Illustration 13

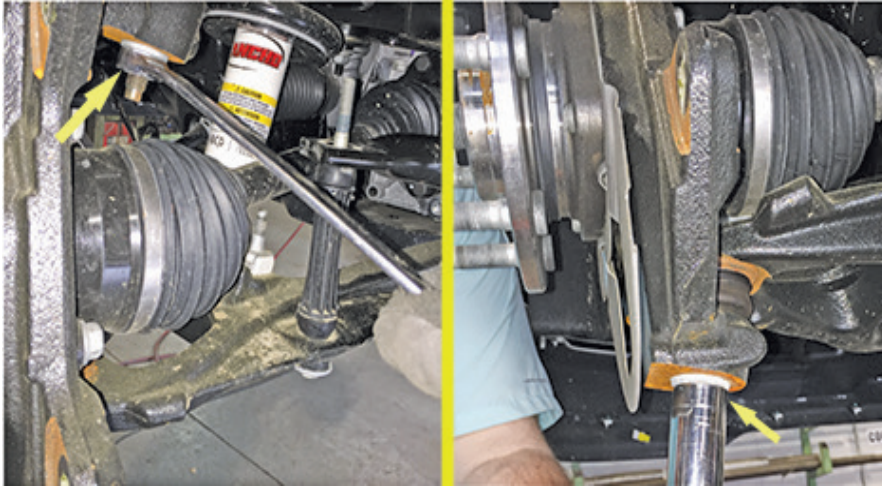


Illustration 14



9) LOWER CONTROL ARM...

□□ [Illustration 15] Loosen but do not remove the four lower control arm bolts (2 per side). {bolt 18mm, nut 24mm}

10) STRUT REMOVAL...

□□ [Illustration 16] Remove the two bolts securing the strut to the lower control arm; allow the lower control arm to hang, while you move to the upper strut mount. {15mm}

□□ [Illustration 17] Unclip the wire clips located on the top of the studs. {plastic fastener removal tool}

□□ [Illustration 18] Remove three nuts securing the strut to the frame then remove the strut. {18mm}

Illustration 15



Illustration 16



Illustration 17



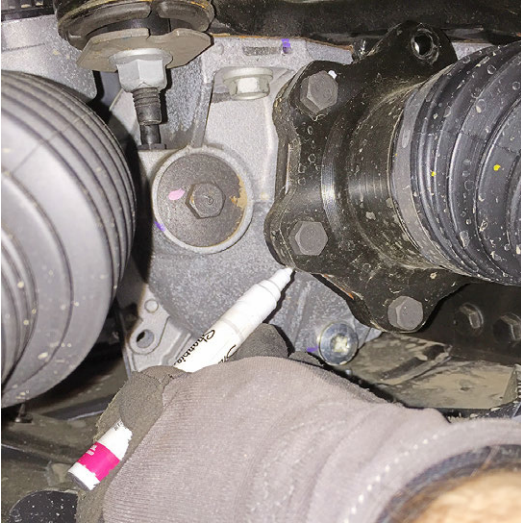
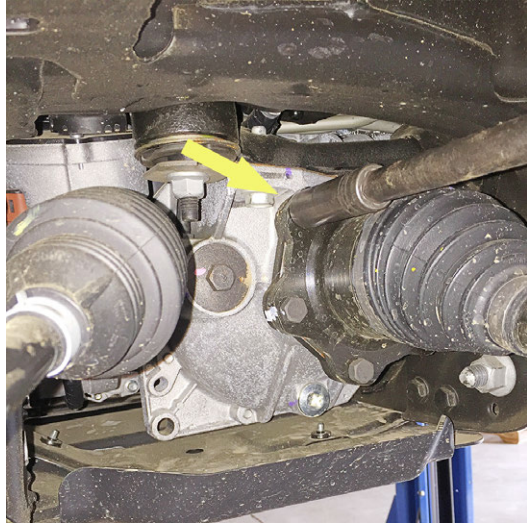
Illustration 18



11) AXLE SHAFT...

NOTE: For 2WD systems, proceed to the next step.

□□ [Illustration 19 & 20] Mark the location of the CV axle shafts (driver and passenger side) for later reference during reassembly. Remove the six bolts that attach the axle shaft to the CV flange on the differential. Remove the axle shaft from the vehicle and set aside.

Illustration 19**Illustration 20****12) LOWER CONTROL ARM...**

□□ [Illustration 21] Remove the lower control arm's bolts then remove the lower control arm.

Repeat steps 3 through 12 on the remaining side.

13) REAR CROSSMEMBER...

□ [Illustration 22] Remove the rear crossmember from the frame and discard. {18mm}

Illustration 21**Illustration 22**

14) DRIVESHAFT...

NOTE: For 2WD systems, proceed to step 18.

- [Illustration 23] Mark the orientation of the driveshaft for reference during reassembly. Remove the four bolts securing the driveshaft. Secure the driveshaft up and out of the way. {11mm}

Illustration 23



Illustration 24



15) RACK AND PINION STEERING...

NOTE: 2007-2013 Vehicles, proceed to step 16.

- [Illustration 24] Mark the orientation of the steering shaft and pinion shaft for later reference during reassembly.
- [Illustration 25 & 26] Remove the bolt securing the steering shaft to the pinion shaft, then remove the steering shaft from the pinion shaft. {11mm}
- [Illustration 27] With the battery disconnected, carefully unplug the bottom two plugs from the rack and pinion. These plugs are “locked” with plastic clips that must be moved to an “un-locked” position before removal. The wire loom is connected to the differential in several places, make sure these are un-clipped before removal of differential. {plastic fastener removal tool}

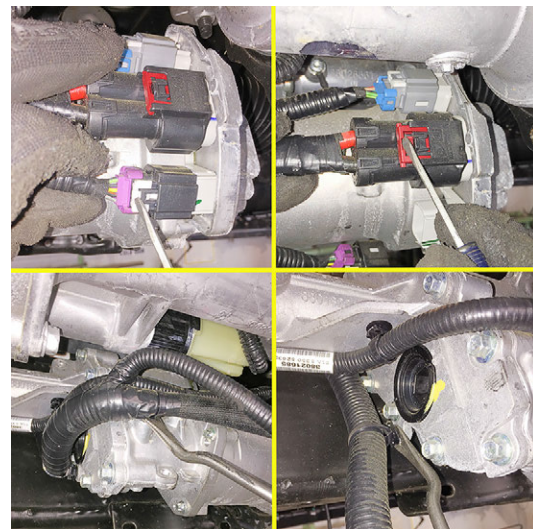
Illustration 25



Illustration 26



Illustration 27



- [Illustration 28] Support the rack and pinion with a jack. Remove the four bolts securing the rack and pinion to the frame, then carefully remove the rack and pinion from the vehicle. {driver side 24mm, passenger side 18mm}

Illustration 28

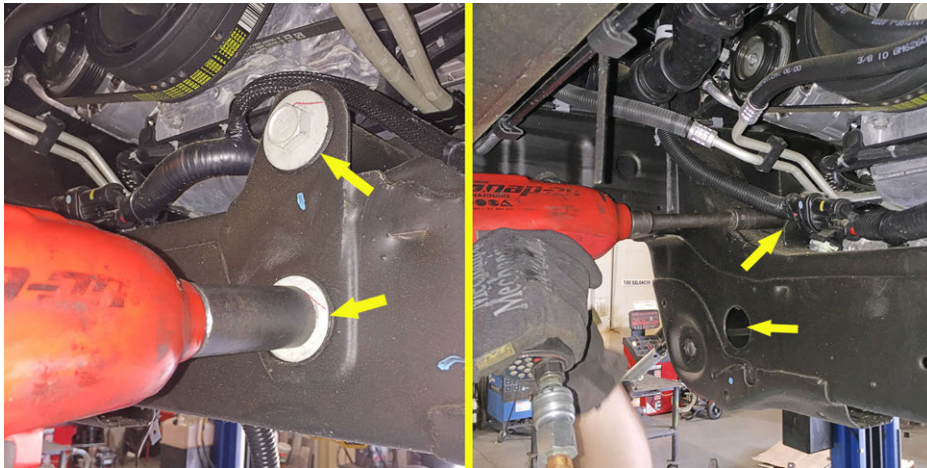


Illustration 29

16) DIFFERENTIAL REMOVAL...

- [Illustration 29] Remove the electrical plug, wire loom, and vent hose from the differential.

- Support the differential housing with a jack.

- [Illustration 30 & 31] Remove the two differential mounting bolts on the driver side, followed by the two nuts on the passenger side. Carefully lower the differential housing to the floor. {driver side 18mm, passenger side 21mm}

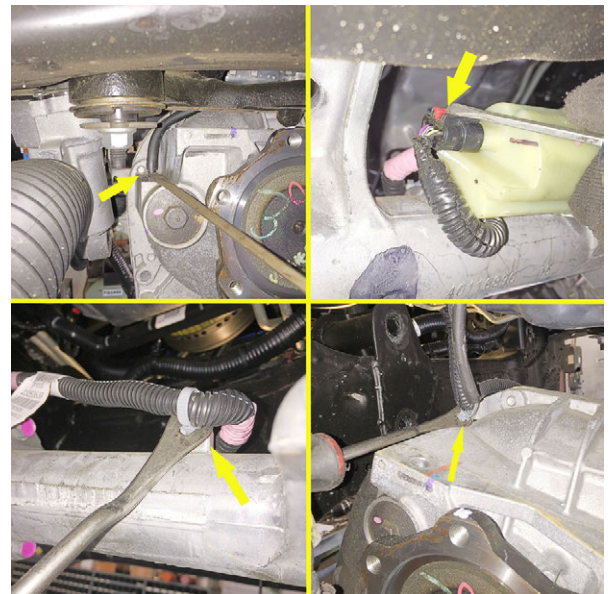


Illustration 30



Illustration 31



17) TRIMMING THE FRAME...

- [Illustration 34] On each side, trim the inside corners of the factory front lower control arm pockets enough to facilitate installing the (55-05-3492) front crossmember. It is only necessary to square off the radius present in the pockets. Test fit the “05” crossmember and trim accordingly.
- [Illustration 35] On the driver side lower control arm mount, measure over 0.556” from the edge of the lower control arm mount hole and mark. Mark the cut line all the way around the mount. Using a torch, plasma cutter, or similar tool, trim the driver side lower control arm bracket.
- [Illustration 36] On both the driver and passenger side, trim the front lip of the rear lower control arm mount.

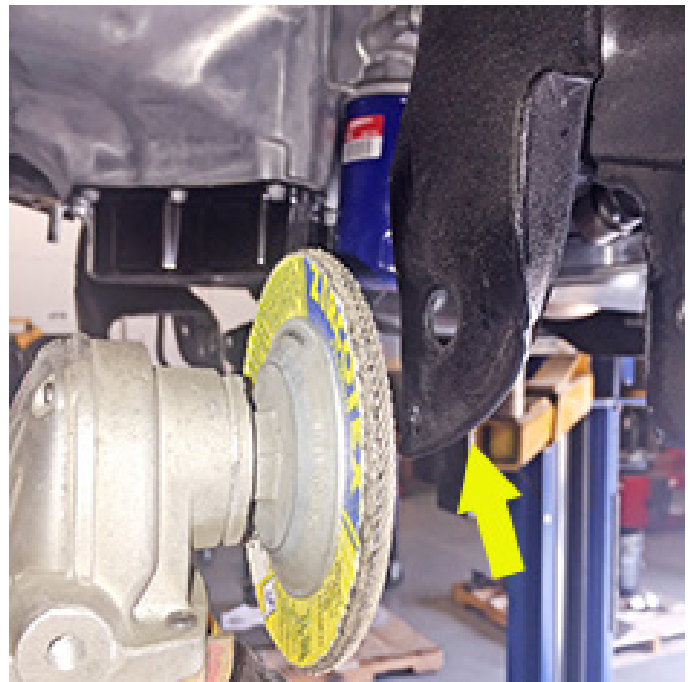
Illustration 34



Illustration 35



Illustration 36



FRONT ASSEMBLY

NOTE: For 2WD systems, proceed to step 24.

18) RACK AND PINION STEERING...

- [Illustration 37] Apply thread locker to the factory bolts and carefully reattach the rack and pinion to the frame reusing the four bolts; tighten. (driver side 321) (passenger side 232) {driver side 24mm, passenger side 18mm}
- Reroute the wire loom to the original locations and reattach to the connectors on the differential. Make sure to “lock” the clips.
- [Illustration 38] Realign the marks on the steering shaft and pinion shaft and attach using the factory hardware; tighten. (26) {11mm}

Illustration 37



Illustration 38

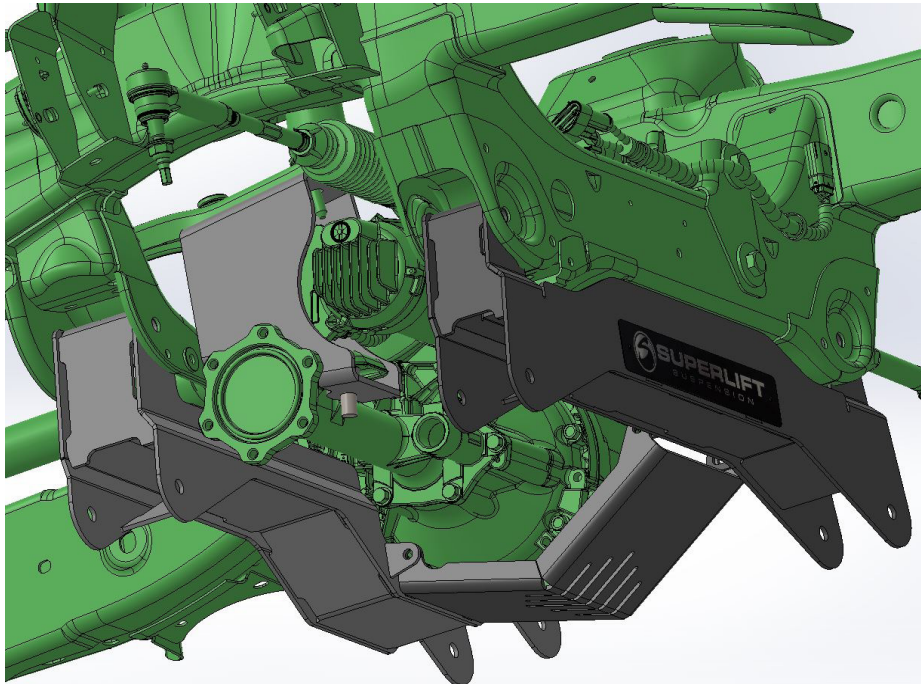


19) PASSENGER SIDE DIFFERENTIAL BRACKET...

- [Illustration 39] Looking at the passenger side differential bracket (55-14-3570) the “tall” end of the taper should be positioned forward (toward the front bumper), while the “short” end of the taper should be positioned rearward (toward the rear bumper). Attach the bracket to the factory passenger side differential mount using the factory hardware. Do not tighten at this time. {21mm}

20) DRIVER SIDE DIFFERENTIAL BRACKET...

- [Illustration 40] Note that the driver side differential bracket (55-13-3570) has a taper in it as well; position the bracket so that the tall end of the taper faces forward (to match the taper of the passenger side bracket). Also note there is a notch in the center of the bracket that accommodates a tab in the center of the factory differential mount. Attach the bracket to the factory mount using the factory bolts. Do not tighten at this time. {18mm}

Illustration 39**Illustration 40****21) DIFFERENTIAL INSTALL...**

□ [Illustration 41] Using a jack, raise the differential into position and line up the mounting holes with the new differential drop bracket. Attach the differential on the driver side using the supplied $1/2" \times 1-3/4"$ bolts, washers, and nuts. Do not tighten at this time. {3/4"}

□ [Illustration 42 & 43] Note that the differential will fit inside of the 55-14-3570 bracket on the front side. Attach the passenger side of the differential to the new differential bracket using the supplied $5/8" \times 2-1/2"$ carriage bolt in the front hole and $5/8" \times 1-3/4"$ bolt in the rear. Make sure to install the washer between the 55-14-3570 bracket and the bottom side of the front mounting hole on the differential as shown. Secure with the supplied nyloc nuts. Do not tighten at this time. {15/16"}

Illustration 41**Illustration 42**

Illustration 43

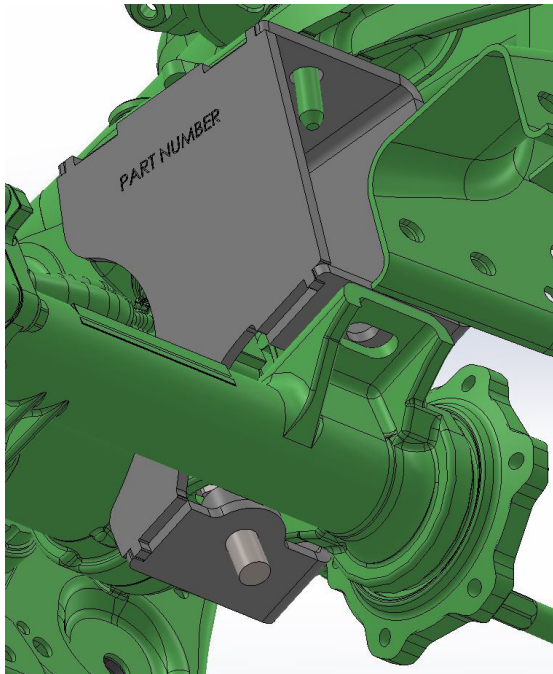
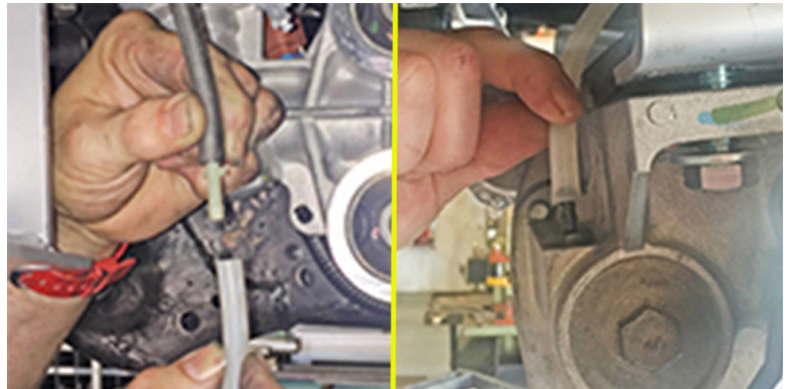


Illustration 44



- [Illustration 44] Reconnect the differential wiring. Attach the supplied vent hose extension to the factory vent hose and reconnect it to the differential.

22) FRONT CROSSMEMBER...

- [Illustration 45] Attach the front crossmember (55-25-3570) to the lower control arm frame mounts using the supplied 5/8" x 4-1/2" bolts, washers, and nyloc nuts. The bolts should be installed from the front. Note that the crossmember should be positioned so that the mounting tab for the differential skid plate points rearward. Do not tighten at this time. {15/16"}

Illustration 45



23) REAR CROSSMEMBER...

- [Illustration 46] Install the rear crossmember (55-16-3570) to the lower control arm mounts, making sure the rear differential bracket is installed correctly into the tabs on the rear crossmember. Secure to the frame using the supplied 5/8" x 5-1/2" bolts, washers, and nyloc nuts. The bolts should be installed from the front. Do not tighten at this time. {15/16"}

NOTE: 2WD systems, proceed to next step.

24) LOWER CONTROL ARMS...

- [Illustration 47] Attach the lower control arm to the front and rear crossmembers using the factory hardware. The bolts should be installed from the front. Snug, but do not tighten the hardware at this time. {bolt 18mm, nut 24mm}

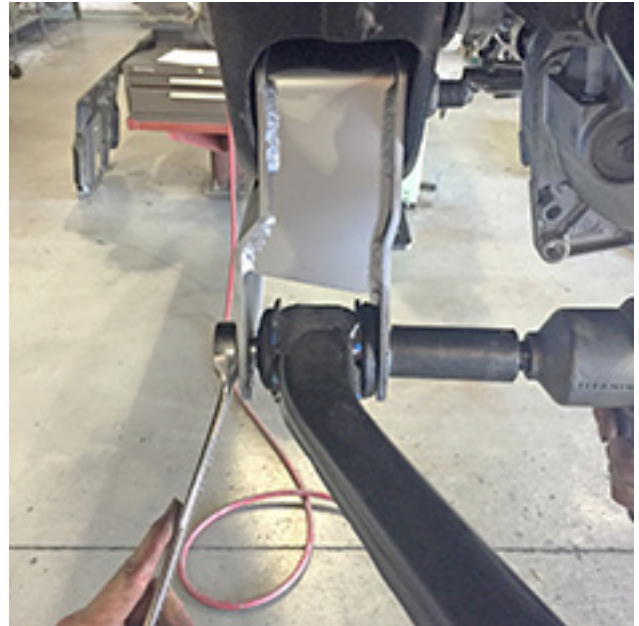
Illustration 46



25) TIGHTEN THESE FASTENERS...

Tighten the following hardware in this order. Refer back to the illustrations listed if needed.

- [Illustration 40] Factory bolts on driver side frame to differential bracket (87) {18mm}
- [Illustration 41] Factory nuts on the passenger side frame to differential bracket (75) {21mm}
- [Illustration 41] 1/2" hardware driver side differential to differential bracket (76) {3/4"}
- [Illustration 42] 5/8" hardware passenger side differential to differential bracket (150) {15/16"}
- [Illustration 45] 5/8" hardware front crossmember to frame. (150) {15/16"}
- [Illustration 46] 5/8" hardware rear crossmember to frame. (150) {15/16"}

Illustration 47**26) BELLY PAN...**

NOTE: For 2WD systems, proceed to the next step.

- [Illustration 48] Attach the belly pan (#55-19-3570) to the mounting tabs on the front and rear crossmembers using the supplied 3/8" x 1" bolts, washers (at head and nut), and flange nuts. Tighten (30).

27) DRIVESHAFT...

NOTE: For 2WD systems, proceed to the next step.

- [Illustration 49] Apply thread locker to the factory hardware, then line up the front driveshaft with the differential yoke according to the marks made during removal and secure using the factory hardware. Tighten (19) {11mm}

NOTE: If installing King Coilovers by Superlift; install using separate instructions included in the King kit box then move to step 30.

28) STRUT SPACER...

- [Illustration 50] Attach the new strut spacer (55-20-3570), with the notches facing the outside of the vehicle, to the top of the strut assembly using the factory hardware and tighten the factory nuts. (37) {18mm}
- [Illustration 51] Slide the strut assembly through the upper control arm and locate the upper end of the assembly into the frame mount properly. Secure the upper end of the

Illustration 48**Illustration 49**

assembly using the supplied 10mm flange nuts. Do not tighten at this time. {15mm}

□□ [Illustration 52] Attach the lower end of the strut to the lower control arm using the factory hardware and tighten. (37) {15mm}

□□ [Illustration 53] Tighten the top strut 10mm nuts. (37) {15mm}

Illustration 50



Illustration 51



Illustration 52



Illustration 53



29) AXLE SHAFT SPACER...

NOTE: For 2WD systems, proceed to the next step.

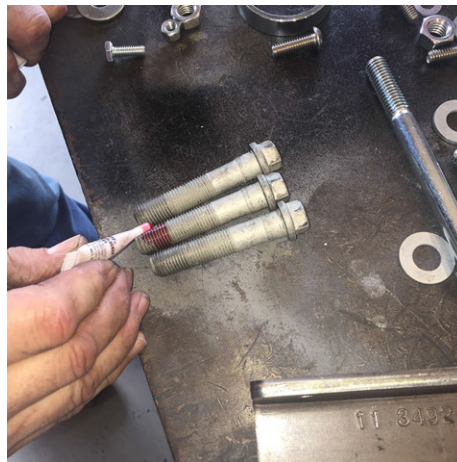
□□ [Illustration 54 & 55] Position an axle shaft spacer (66-15-3330) between the flange on the axle shaft and the flange on the differential and secure using the supplied 10mm x 70mm bolts and flat washers. Put thread locker on the bolts before installing. Tighten (58) {17mm}

Illustration 54**Illustration 55****30) KNUCKLE ASSEMBLY...**

NOTE: Perform these steps on one knuckle at a time.

□□ [Illustration 56] Note the orientation of the dust shield and wheel bearing assembly prior to removal. Remove the three bolts securing the wheel bearing assembly to the factory knuckle.

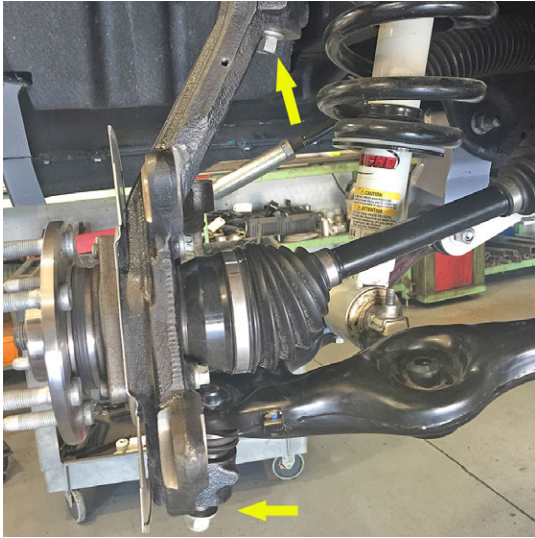
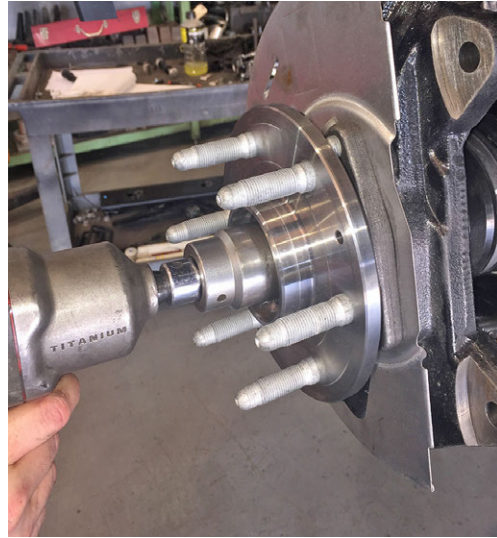
□□ [Illustration 57 & 58] Install the new knuckle (66-01-3570 or 66-41-3570 driver side; 66-02-3570 or 66-42-3570 passenger side) onto the factory bearing assembly and dust shield using the factory hardware. Be sure the orientation of the dust shield and bearing assembly matches original. Use the supplied thread locker on the three factory fasteners. Tighten (151) {15mm}

Illustration 56**Illustration 57****Illustration 58****31) KNUCKLE INSTALLATION...**

□□ [Illustration 59] Install the knuckle assembly on the lower ball joint while sliding the CV shaft into the new knuckle. Connect the upper ball joint to the knuckle and secure using the factory nuts. Tighten the lower nut (94) and the upper nut (37) {upper ball joint 18mm, lower ball joint 24mm}

32) AXLE SHAFT...

□□ [Illustration 60] Secure the axle shaft to the knuckle with the factory nut and tighten. (148-165) {35mm}

Illustration 59**Illustration 60****33) BRAKE LINE BRACKET...**

- [Illustration 61] Remove the factory brake line bracket from the frame located on the rearward side of the upper control arm mount. {13mm}
- [Illustration 62] Attach the brake line relocation bracket (55-09-3492) to the factory brake line location on the frame. Secure using the factory hardware in the factory hole and use the supplied 3/8" x 3/4" bolt, washer, and nyloc nut in the lower hole and tighten. (factory bolt: 76 in-lb; 3/8" bolt 30) {13mm, 9/16"}
- [Illustration 63] Fasten the factory brake line bracket to the new bracket using the supplied 1/4" x 3/4" bolt, washer, and nyloc nut. (8) {1/2"}
- [Illustration 64] **CAUTION: DO NOT DAMAGE BRAKE HOSE.** Use a pair of vise grips and adjustable pliers to pry open the factory brake line bracket, that attached the hose to the top of the control arm, free from the brake hose. Clamp the vise grips so they are gripping the edge and the back side of the radius, as shown. Then using the adjustable pliers, pry the bracket free. {vise grips, adjustable pliers}

Illustration 61**Illustration 62**

Illustration 63**Illustration 64****34) ABS WIRING...**

□□ [Illustration 65] Route the ABS wiring down from the frame on top of the upper control arm to the knuckle. Then down on the inside of the knuckle to the front side and over the tie rod end to the hub assembly.

□□ [Illustration 66 & 67] Attach the ABS sensor to the knuckle. If necessary, use a pry bar to pry the dust shield out of the way to install the ABS sensor into the hub assembly. Secure the ABS sensor to the hub assembly using the factory hardware. (1) (5mm allen)

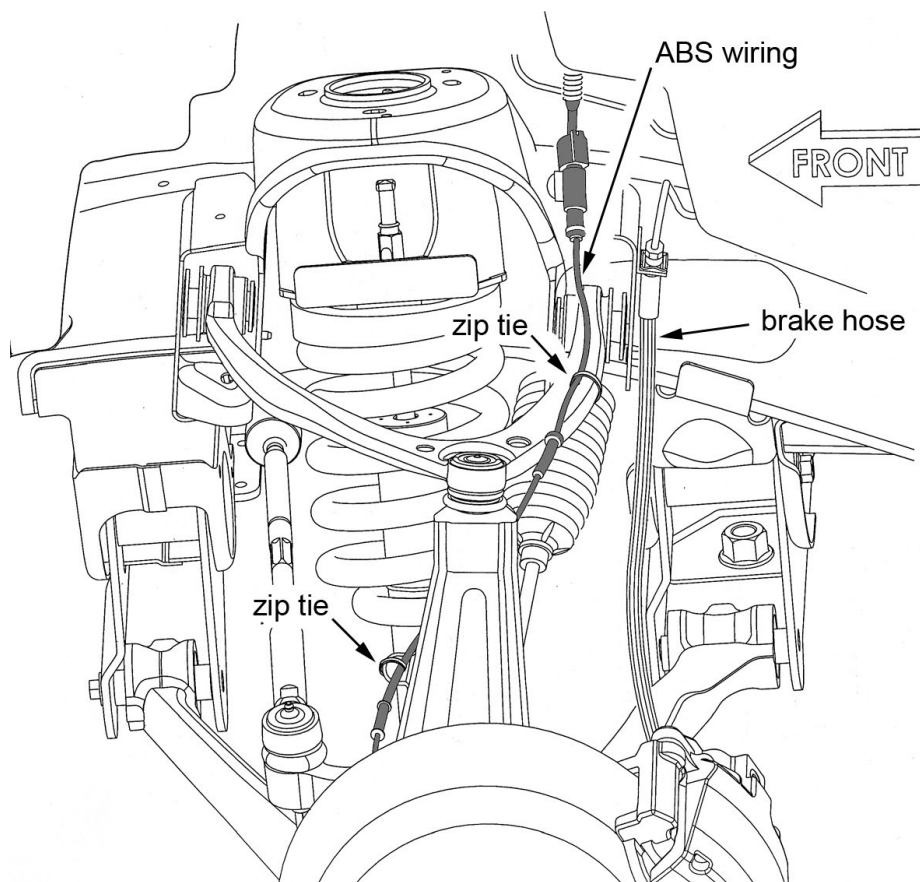
Illustration 65

Illustration 66



Illustration 67



35) BRAKE ROTOR...

□□ [Illustration 68] Install the brake rotor and secure it using the factory Torx bolt and tighten. (106 in-lb) {T30}

36) BRAKE CALIPER...

□□ [Illustration 69 & 70] **NOTE!!! 2016 AND UP MODELS.....** If equipped with stamped steel control arms and steel knuckle use the newly supplied 14MM caliper bolt. All other configurations use the factory bolts!! Attach the caliper bracket assembly to the knuckle. Apply the supplied thread-locking compound to the bolts before installing and tighten. (129) {18mm}

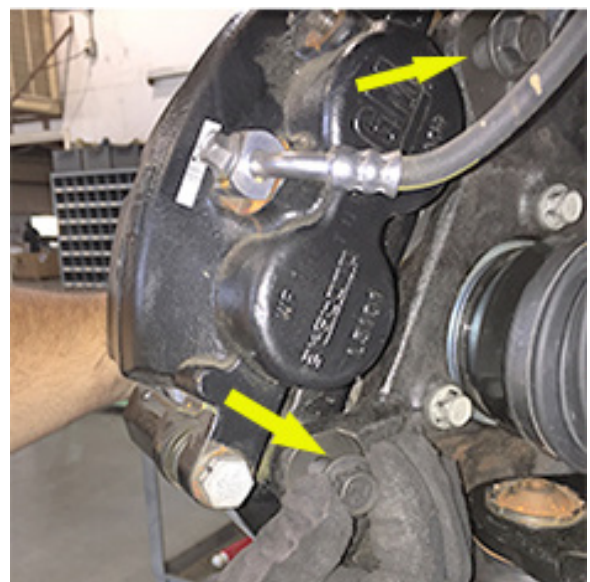
Illustration 68



Illustration 69

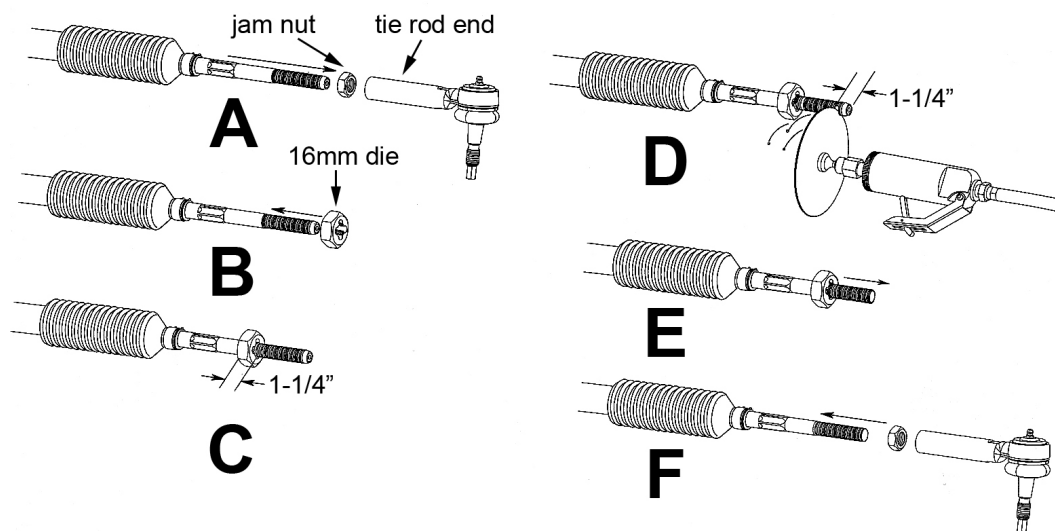


Illustration 70



37) TRIMMING STEERING TIE ROD END...

- [Illustration 71] Loosen the jam nut for the tie rod end. Remove the end and jam nut; set these parts aside.
- [Illustration 71] Thread the supplied 16mm x 1.5 die nut on to the tie rod until it reaches the end of the factory threads.
- [Illustration 71] Apply some cutting lubricant to the tie rod (male end) and die. Using a 16mm wrench on the flats present in the tie rod, hold the tie rod steady and use the die nut to cut an additional 1-1/4" of threads on the tie rod. Do not remove the die at this time.
- [Illustration 71] Using a cut-off wheel or similar tool, cut 1-1/4" off of the end of the factory tie rod (male end). Use a thread file or die grinder to clean up any burrs caused by the cutting.
- [Illustration 71] Unscrew the die nut from the tie rod, using it to "chase" the threads on the end of the tie rod where it was cut. The die should thread smoothly on and off the end of the rod.
- [Illustration 71] Reinstall the factory jam nut, followed by the tie rod end. Final toe adjustments will take place once the suspension installation is complete. Snug the jam nut for now.

Illustration 71**38) STEERING TIE ROD END...**

- [Illustration 72] Attach the tie rod end to the knuckle; tighten. (44) {21mm}

39) SWAY BAR BRACKETS...

- [Illustration 73] Attach the sway bar drop brackets (55-07-3500 driver's side; 55-08-3500 passenger's side) to the factory sway bar mounts on the frame using the supplied 10mm x 30mm bolts and flat washers. Note that the flat side of the bracket should face the outside of the vehicle and the sway bar body is shifted rearward. Do not tighten at this time.
- [Illustration 73] Attach the anti-sway bar body to the new drop brackets using the factory bolts supplied and 10mm stover nuts. Do not tighten at this time.

□□ Tighten the upper hardware followed by the lower. (50)
 {upper 17mm; lower bolt 10mm, nut 17mm}

□□ [Illustration 74] Locate the new 3/8" x 12" bolts, the new sway bar link tube (12-3492) and washer packs (145098). Place a supplied washer over the bolt followed by a factory bushing and insert from the bottom, through the lower control arm. Place another factory bushing and supplied washer on the bolt followed by the new sway bar link tube (12-3492), then a supplied washer and bushing. Push bolt through the sway bar body, then top off with the last factory bushing, factory washer, and supplied 3/8" nut. Tighten until the bushings swell slightly.

Illustration 72



Illustration 73



Illustration 74



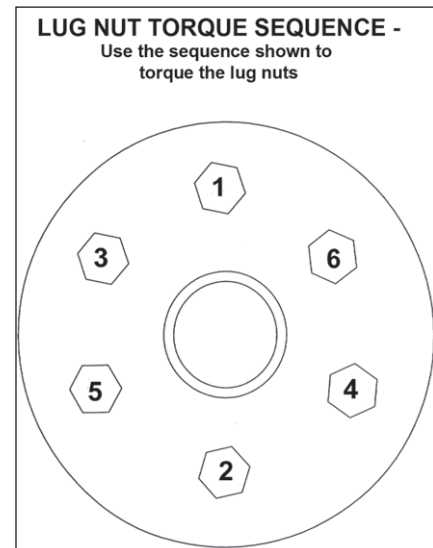
40) TIRES / WHEELS...

□ [Illustration 75] Tighten the lug nuts (140) in the sequence shown.

WARNING: When the tires / wheels are installed, always check for and remove any corrosion, dirt, or foreign material on the wheel mounting surface, or anything that contacts the wheel mounting surface (hub, rotor, etc.). Installing wheels without the proper metal-to-metal contact at the wheel mounting surfaces can cause the lug nuts to loosen and the wheel to come off while the vehicle is in motion.

WARNING: Retighten lug nuts at 500 miles after any wheel change, or anytime the lug nuts are loosened. Failure to do so could cause wheels to come off while vehicle is in motion.

Illustration 75



41) CLEARANCE CHECK...

With the vehicle still on jack stands, and the suspension “hanging” at full extension travel, cycle steering lock-to-lock and check all components for proper operation and clearances. Pay special attention to the clearance between the tires / wheels and brake hoses, wiring, etc.

Lower vehicle to the floor.

42) LOWER CONTROL ARM...

Tighten the lower control arm bolts. (129) {15/16”}

43) BATTERY...

Reconnect battery.

REAR ASSEMBLY**44) PREPARE VEHICLE...**

Chock the front tires. Position a jack beneath the center of the rear axle of the vehicle. Raise rear of vehicle and place jack stands under the frame rails, a few inches in front of the rear springs’ front hangers. Ease the jack down until the frame is resting on the stands. Keep a slight load on the jack. Remove the rear tires.

45) EMERGENCY BRAKE CABLE...

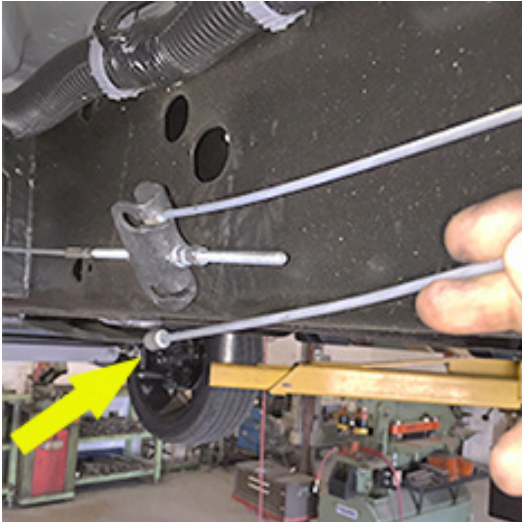
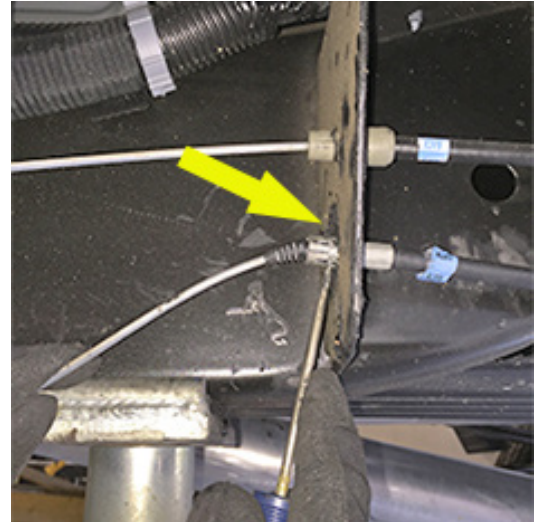
[Illustration 76] Note the location of the brake cables within each hanger. Remove the emergency brake cable hangers from the frame. {13mm}

[Illustration 77] Unbolt the clamp on the driver side lower shock mount that secures the driver side emergency brake cable to the axle. {13mm}

[Illustration 78] Remove the clamp from the emergency brake cable; discard. {adjustable pliers}

Illustration 76**Illustration 77****Illustration 78**

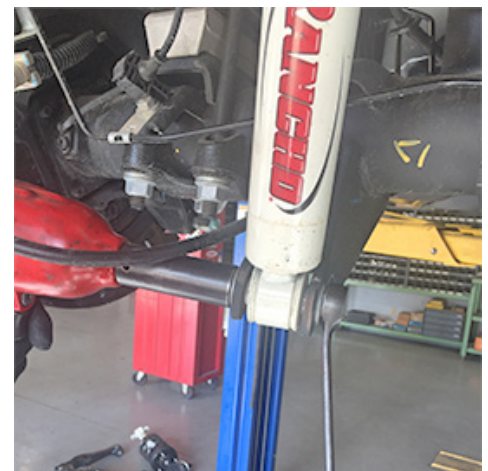
- [Illustration 79 & 80] Disconnect the driver side emergency brake cable from brake adjuster at the frame. Collapse the prongs retaining the emergency brake cable in frame bracket and remove. Route the cable over the axle tube, then re-attach it to the frame mount and the adjuster. {vise grips, screw-driver}

Illustration 79**Illustration 80****46) ABS WIRING...**

- [Illustration 81 & 82] Unclip the plastic clips retaining the ABS wiring from the top and inside of the frame rail, as well as the clip on the axle. {plastic fastener removal tool}

47) SHOCK ABSORBERS...

- [Illustration 83] Remove the shock absorbers. Discard. {21mm}

Illustration 81**Illustration 82****Illustration 83****48) BRAKE LINE BRACKET...**

- [Illustration 84] Unbolt the rear brake hose bracket from the top of the driver side frame rail. This bracket secures the connection between the metal brake lines and rubber hoses at the frame. {13mm}
- [Illustration 85] Carefully reform the metal lines so that the mounting foot for the bracket lines up, with the bottom of the frame rail, directly below its original attachment point. Use extreme caution to avoid pinching or otherwise damaging the lines. Using the bracket as a template, mark the location of

the new mounting holes to be drilled in the bottom of the frame.

- Move the brake lines out of harm's way and drill at the marked locations using a 9/32" bit. {drill, 9/32" drill bit}
- [Illustration 86] Line up the bracket with the drilled holes and install the supplied 5/16" x 1" self-tapping bolts. Tighten. (10) {7/16"}

Illustration 84

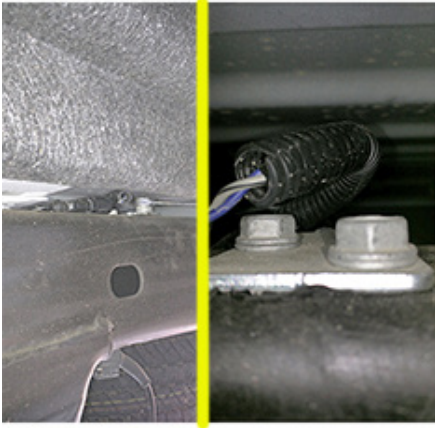


Illustration 85



Illustration 86



49) INSTALLING BLOCKS...

- [Illustration 87] Remove ubolts and then lower the axle several inches away from springs; discard the ubolts, factory blocks, and hardware. {21mm}
- [Illustration 88] Clean spring pads of all debris. Position the Superlift block (55-01-201) on top of the axle pad with the tall end facing rearward, then using the floor jack(s), mate the springs to the blocks, be sure that the center bolt heads seat properly. Install the new Superlift 9/16" ubolts and factory ubolt plate. Evenly torque the ubolts using an "X" tightening sequence. (150) {7/8"}
- [Illustration 89] Install the new Superlift 7/16" ubolts (716x314x412ub) over the leaf spring and through the new block securing with the supplied 7/16" flange nuts. (70) {5/8"}

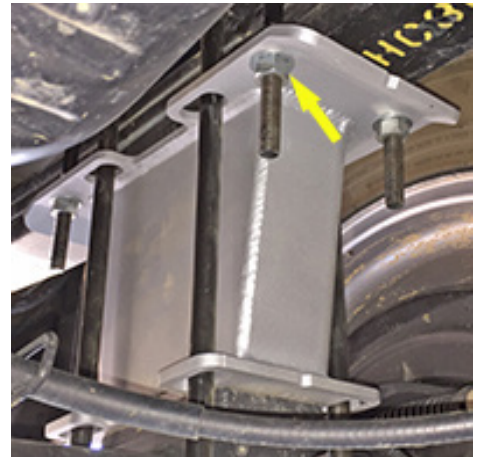
Illustration 87



Illustration 88



Illustration 89



50) SHOCK ABSORBERS...

[Illustration 90] Install the rear shock absorbers; Superide shocks must be installed with the cylinder body mounted at the axle. Position a supplied 3/4" SAE washer at the top and bottom of the shock on the inside of the bracket and tighten the upper and lower bolts. (76) {21mm}

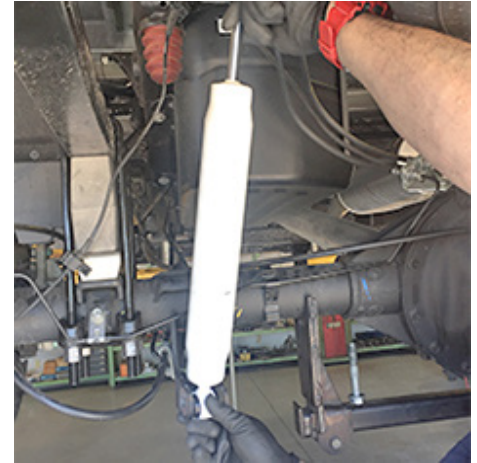
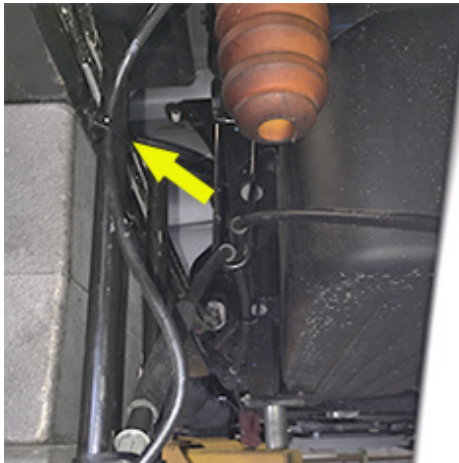
51) ABS WIRING...

[Illustration 91] Reattach the ABS wire to the axle and pull the ABS wire up from the axle along the rear ubolt and secure it to a ubolt using the supplied cable tie

[Illustration 92] Using supplied cable tie, secure the ABS wire to the bump stop mount.

52) EMERGENCY BRAKE CABLE...

[Illustration 93] Secure the emergency brake cable to the ubolt at the axle using the supplied cable tie.

Illustration 90**Illustration 91****Illustration 92****Illustration 93****53) TIRES / WHEELS...**

[Illustration 75] Reinstall tires and wheels. Tighten the lug nuts in the sequence shown. (151) {21mm}

WARNING: When the tires / wheels are installed, always check for and remove any corrosion, dirt, or foreign material on the wheel mounting surface, or anything that contacts the wheel mounting surface (hub, rotor, etc.). Installing wheels without the proper metal-to-metal contact at the wheel mounting surfaces can cause the lug nuts to loosen and the wheel to come off while the vehicle is in motion.

WARNING: Retighten lug nuts at 500 miles after any wheel change, or anytime the lug nuts are loosened. Failure to do so could cause wheels to come off while vehicle is in motion.

Lower vehicle to the floor.

54) ALIGNMENT...

Realign vehicle to factory specifications.

55) CLEARANCE CHECK...

With the vehicle on the ground, check all components for proper operation and clearances. Pay special attention to the clearance between the tires / wheels, brake hoses, wiring, etc.

56) FOUR WHEEL DRIVE...

Activate the four wheel drive system and check for proper engagement.

57) HEADLIGHTS...

Re-adjust headlights to proper setting.

58) SUPERLIFT WARNING DECAL...

Install the WARNING TO DRIVER decal on the inside of the windshield, or on the dash, within driver's view. Refer to the "NOTICE TO DEALER AND VEHICLE OWNER" section below.

59) SUPERLIFT BADGES...

This kit is packaged with a Superlift badge. Prior to installation, use the supplied alcohol pad to eliminate all soap and or other non-adhering residues that may impair adhesion, thoroughly clean the entire area of placement.

The adhesive on our badges is pressure sensitive and must be applied using pressure on all areas of the graphic. Like any PSA (pressure sensitive adhesive), it can take up to 72 hours for the adhesive to fully cure. Once the badge is in place do not peel it up, this will diminish the adhesive properties and could result in damaging the badge itself.

To keep your Superlift badge in "like new" appearance keep the badge free/clear of solvents and chemicals that could cause the adhesive to dry or dissolve. This includes gasoline, diesel fuel, paint thinner, and alcohol. Soap and water is all that is needed for cleaning. Degreasers can be used sparingly and hand whipped/applied if needed, although not suggested.

Important Maintenance Information

It is the ultimate buyer's responsibility to have all bolts / nuts checked for tightness after the first 100 miles and then every 1000 miles. The steering, suspension and driveline systems, plus wheel alignment should be inspected by a qualified professional mechanic at least every 3000 miles.

Limited Lifetime Warranty / Warnings

Your Superlift® product is covered by the Limited Warranty explained below that gives you specific legal rights. This limited warranty is the only warranty Superlift® makes in connection with your product purchase. Superlift® neither assumes nor authorizes any retailer or other person or entity to assume for it any other obligation or liability in connection with this product or limited warranty.

Superlift, LLC, Limited Lifetime Warranty

What is covered? Subject to the terms below, Superlift® will repair or replace its products found defective in materials or workmanship for so long as the original purchaser owns the vehicle on which the product was originally installed. Your warrantor is Superlift, LLC, doing business as Superlift® Suspension Systems ("Superlift®").

What is not covered? Your Superlift® Limited Warranty does not cover products Superlift® determines to have been damaged by or subjected to:

- Alteration, modification or failure to maintain.
- Normal wear and tear (bushings, rod ends, etc.). Scratches or defects in product finishes (powder coating, plating, etc.).
- Damage to, or resulting from, the vehicle's electronic stability system, related components or other vehicle systems.
- Racing or other vehicle competitions or contests. Accidents, impact by rocks, trees, obstacles or other aspects of the environment.
- Theft, vandalism or other intentional damage.

Remedy Limited to Repair or Replacement. The exclusive remedy provided hereunder shall, upon Superlift's inspection and at Superlift's option, be either repair or replacement of the product covered under this Limited Warranty. Customers requesting warranty consideration should contact Superlift® by phone to obtain a Returned Goods Authorization number. All removal, shipping and installation costs are customer's responsibility.

If a replacement part is needed before the Superlift® part in question can be returned, you must first purchase the replacement part. Then, if the part in question is deemed warrantable, you will be credited / refunded.

Other Limitations - Exclusion of Damages - Your Rights Under State Law

- Neither Superlift® nor your independent Superlift® dealer are responsible for any time loss, rental costs, or for any incidental, consequential or other damages you may have.
- This Limited Warranty gives you specific rights, and this is the only warranty Superlift® makes in connection with your product purchase. You may also have other rights that vary from state to state. For example, while all implied warranties are disclaimed herein, any implied warranty required by law is limited to the terms of our Limited Lifetime Warranty as described above. Some states do not allow limitations of how long an implied warranty lasts and / or do not allow the exclusion or limitation of incidental or consequential damages, so the limitations and exclusions herein may not apply to you. Superlift® neither assumes nor authorizes any retailer or other person or entity to assume for it any other obligation or liability in connection with this product or Limited Warranty.

Superlift, LLC, Satisfaction Guarantee

We want you to purchase our product with confidence and be 100% satisfied with the end result. If you have any legitimate issue, and Superlift® cannot rectify it to your satisfaction, Superlift® will take back the Superlift® brand product and refund the customer 100% of the product purchase price.

The details:

- Offer valid to the original retail consumer for six months after product purchase.

- May require a Superlift® dealer's participation in order to assist in "troubleshooting" the issue.
- Any costs related to labor, freight, incidental or consequential are not refunded.
- Refund will not exceed Superlift's® published retail price.

Important Product Use and Safety Information / Warnings

As a general rule, the taller a vehicle is, the easier it will roll over. Offset, as much as possible, what is lost in rollover resistance by increasing tire track width. In other words, go "wide" as you go "tall"; always use as wide a tire and wheel combination as feasible to enhance vehicle stability. We strongly recommend, because of rollover possibility, that the vehicle be equipped with a functional roll bar and cage system. Seat belts and shoulder harnesses should be worn at all times. Avoid situations where a side rollover may occur.

Generally, braking performance and capabilities are decreased when significantly larger / heavier tires and wheels are used. Take this into consideration while driving. Also, changing axle gear ratios or using tires that are taller or shorter than factory height will cause an erroneous speedometer reading. On vehicles equipped with an electronic speedometer, the speed signal impacts other important functions as well. Speedometer recalibration for both mechanical and electronic types is highly recommended.

Do not add, alter, or fabricate any factory or aftermarket parts to increase vehicle height over the intended height of the Superlift® product purchased. Mixing component brands is not recommended.