

Powered By Innovation... Guided By Integrity



***PROFESSIONAL
AIR CONDITIONING***

9/01/19

... Trusted By Professionals Worldwide

TRAINING VEHICLE

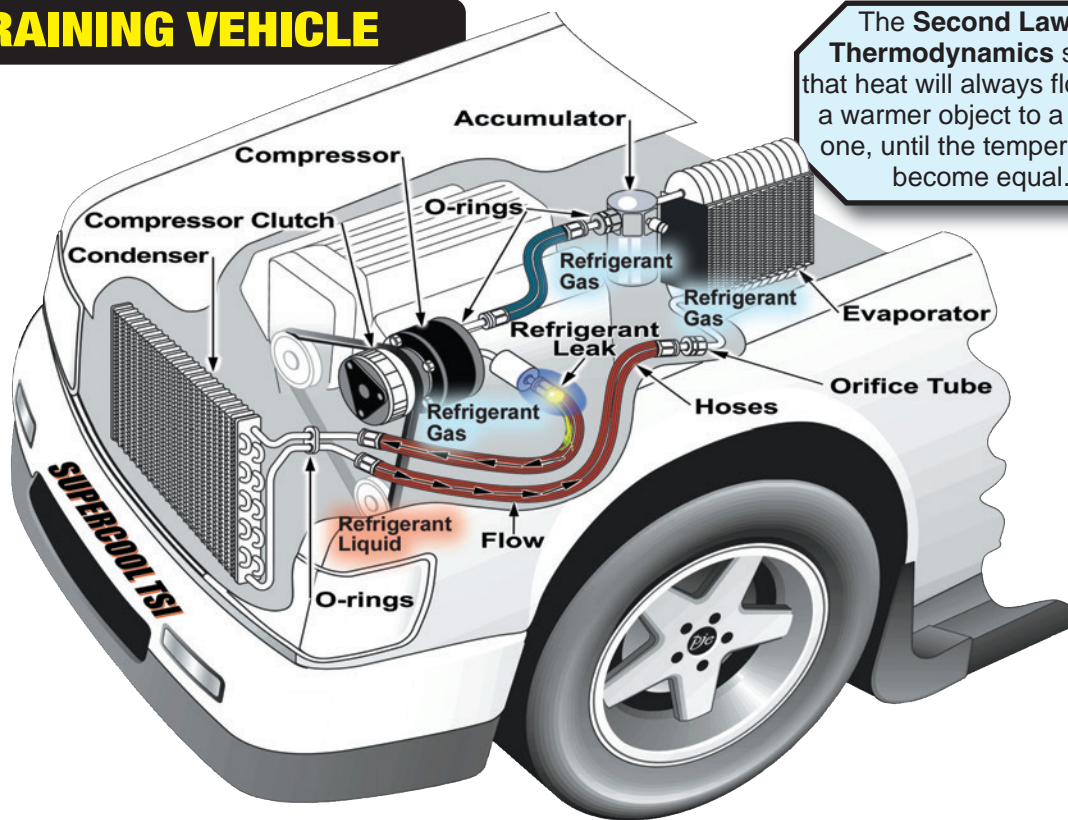

The **Second Law of Thermodynamics** states that heat will always flow from a warmer object to a cooler one, until the temperatures become equal.

INDEX

R134a REFRIGERANT — Page 3	AC TOOLS — Page 29
1234yf REFRIGERANT — Page 7	HOSE REPAIR — Page 43
LUBRICANTS — Page 10	CYCLING SWITCHES — Page 45
LEAK STOP — Page 13	MAINTENANCE KITS & O-RINGS — Page 51
U/V DYES & LEAK DETECTION — Page 15	SEALS, WASHERS, GASKETS — Page 84
FLUSH, FILTERS & FLUSH TOOLS — Page 23	TRAINING — Page 90
ODOR CONTROL — Page 27	PART NUMBER INDEX — Page 95

ISO 9001
BUREAU VERITAS
 Certification



ISO 9001 CERTIFIED FOR THE DESIGN, MANUFACTURE,
 PACKAGING AND DISTRIBUTION OF CHEMICALS
 AND SYNTHETIC LUBRICANTS FOR AUTOMOTIVE
 AND INDUSTRIAL MARKETS

R134a REFRIGERANT

R134a Refrigerant with Additives

SUPERCOOL - TRUSTED BY PROFESSIONALS

R134a REFRIGERANT



MEETS AHRI 700 AND SAE J2276 PURITY STANDARDS

- Replaces lost refrigerant in your A/C system
- Contains 12 oz. R134a Refrigerant charge
- Compatible with POE, PAG and PAO lubricants

Part # 49363 R134a Refrigerant Charge 12oz.

Refrigerant cans packaged after January 1, 2018 must be equipped with self sealing valves.

R134a WITH PERFORMANCE BOOSTER & LEAK SEALER

- Contains 10 oz. R134a refrigerant and 2 oz. synthetic lubricant with performance enhancer & leak sealer
- Cleans system & provides colder air
- Improves heat transfer & increases system efficiency

Part # 40292 R134a with Performance Enhancer & Leak Sealer 12oz.

R134a WITH LEAK STOP

- Contains 10 oz. R134a refrigerant & 2 oz. synthetic lubricant with system safe leak sealer
- Anti-wear additives reduce friction & extend compressor life
- Compatible with all lubricants

Part # 24049 R134a with Leak Stop 12oz.



EXTENDED MILEAGE R134a W/LEAK SEALER

- Contains 10 oz. R134a refrigerant and 2 oz. synthetic lubricant with system safe leak sealer
- Contains advanced extended mileage additives
- Reduces wear & extends A/C system life
- Cleans system and provides colder air

Part # 40308 High Mileage R134a with Leak Sealer 12oz.



R134a WITH UV LEAK DETECTION + LEAK SEALER

- Contains 10 oz. R134a refrigerant & 2 oz. synthetic lubricant with UV leak detection dye and system safe leak sealer
- UV dye pinpoints AC system leaks
- Leak sealer stops small leaks in rubber gaskets, hoses and O-rings.
- Anti-wear additives reduce friction & extend compressor life
- Compatible with all lubricants

Part # 40315 R134a with UV Dye + Leak Sealer 12oz.

PIERCING VALVE CHARGING HOSE

- Screw on can tap hose design
- 12" hose and aluminum quick connect low side coupler
- Use with Speedy Charge, Leak Stop, Oil Charges, Performance Enhancer, and 12 oz. cans of R134a
- 90° Low side quick coupler

Part # 41275 R134a Charging Hose & Gauge



PIERCING VALVE CHARGING HOSE

- Screw on can tap hose design
- 24" hose and brass quick connect low side coupler
- Use with Speedy Charge, Leak Stop, Oil Charges, Performance Enhancer, and 12 oz. cans of R134a

Part # 38619 R134a Can Tap, Hose & Gauge



Packaged with SELF SEALING VALVE!



19 oz. R134a Plus and Charging Hose with Pressure Gauge in Retail Box

R134a PLUS WITH CHARGING HOSE AND GAUGE FOR SELF SEALING CANS

- Synthetic additive package provides maximum cooling performance
- R134a refrigerant charge
- Synthetic lubricant charge
- Performance enhancer provides cold air faster
- System safe leak sealer stops small leaks in rubber hoses, gaskets and O-rings
- U/V leak detection dye to help detect leaks
- Anti-wear additives reduce wear and extend compressor life
- 12" charging hose with pressure gauge and aluminum quick connect low side coupler
- Use with all new self sealing refrigerant cans
- 90° Low side quick coupler

Part # 52486B Refrigerant Plus 19 oz. with R134a Charging Hose & Gauge

Part # 52486 Refrigerant Plus 19 oz. Refill

SELF SEALING VALVE CHARGING HOSE

SCREW ON CAN TAP HOSE DESIGN WITH GAUGE FOR SELF SEALING CANS

- 12" hose and aluminum quick connect low side coupler
- Use with Speedy Charge, Leak Stop, Oil Charges, Performance Enhancer, and 12 oz. cans of R134a
- 90° Low side quick coupler

Part # 51229 R134a Charging Hose & Gauge



SELF SEALING VALVE CAN TAP & HOSE

SCREW ON CAN TAP HOSE DESIGN FOR SELF SEALING REFRIGERANT CANS

- Screw on can tap hose design
- 9" hose and aluminum quick connect low side coupler
- Use with Speedy Charge, Leak Stop, Oil Charges, Performance Enhancer, and 12 oz. cans of R134a
- Available in clamshell pack or bulk

Part # 51205 R-134a Can Tap & Hose

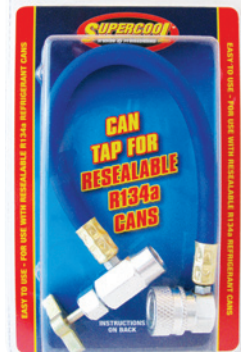

BRASS R134a PIERCING VALVE CAN TAP WITH HOSE

- Screw on can tap hose design
- 9" hose and brass quick connect low side coupler
- Use with Speedy Charge, Leak Stop, Oil Charges, Performance Enhancer, and 12 oz. cans of R134a
- Available in clamshell pack or bulk

Part # 401 R-134a Can Tap & Hose



R134a PIERCING VALVE CAN TAP WITH HOSE

- Screw on can tap hose design
- 9" hose and quick connect low side coupler
- Use with Speedy Charge, Leak Stop, Oil Charges, Performance Enhancer, and 12 oz. cans of R134a

Part # 401P R-134a Can Tap & Hose



SELF SEALING VALVE R134a CAN TAP

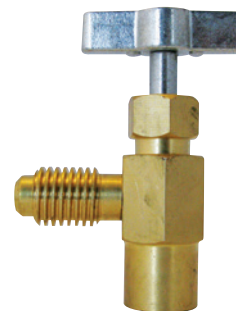

- Brass dispensing valve for self-sealing R134a refrigerant cans with 1/2" ACME RH fitting

Part # 53834 R134a SELF SEAL CAN TAP

Part # 402 R134a PIERCING CAN TAP

AEROSOLS

R134a Oil Charges

SUPERCOOL - TRUSTED BY PROFESSIONALS

SPEEDY CHARGE

- Extreme performance for high mileage vehicles
- Quick and easy A/C system charge
- 11 oz. R134a refrigerant, 3 oz. of lubricant, leak sealer and U/V dye charge
- Leak sealer helps stop air conditioning leaks on rubber hoses, gaskets, seals and ALL types of O-rings including HNBR, Nitrile and Neoprene

Part # 9473 Speedy Charge 14oz.
(Add to system with Part # 401, 41275 and 38619)



R134a OIL CHARGES + UV DYE



- Quick & easy way to add oil charge to R134a A/C systems
 - Single application can
 - Includes O-ring conditioner, proprietary anti-wear and anti-oxidant additives
 - Includes UV dye to pinpoint leaks
- | | |
|-------------|--|
| Part # 7295 | 46 VIS. PAG Oil Charge + U/V Dye 4 oz. |
| Part # 7554 | 100 VIS. PAG Oil Charge + U/V Dye 4 oz. |
| Part # 7561 | 150 VIS. PAG Oil Charge + U/V Dye 4 oz. |
| Part # E115 | Universal Ester Oil Charge + U/V Dye 4 oz. |

R134a LEAK STOP

- Does not contain polymers. Will not harm or clog A/C system components, reclamation or recovery machines.
- 1 can treats 1 vehicle
- Installs easily using an R134a Can Tap (Part # 401)
- Compatible with PAG, ester & mineral oils

Part # STOPA Seal Leak Stop with UV Leak Detection Dye 4 oz.

Part # 24087 Seal Leak Stop with RED leak Detection Dye 3 oz.

Part # ST27 Total AC Leak Stop with UV Leak Detection Dye 4 oz.

- Stops small leaks in evaporators, condensers, hoses, gaskets & seals



R134a PLUS WITH APPLICATOR

Easy to use!



- Synthetic additive package provides maximum cooling performance
- R134a refrigerant charge
- Synthetic lubricant charge
- Performance enhancer provides colder air faster
- System safe leak sealer stops small leaks in rubber hoses, gaskets and O-rings
- U/V leak detection dye
- Anti-wear additives reduce wear and extend compressor life

Part # 24261 Refrigerant Plus 14 oz.

Part # 24278 Refrigerant Plus 19 oz.



PAG OIL CHARGES WITH PERFORMANCE BOOSTER

Available in
46,100 and 150
Viscosity

- Adds 2 oz. of PAG oil with performance booster to lubricate and protect compressors and 1 oz. R134a refrigerant
- Performance booster improves heat transfer & increases system efficiency
- Includes O-ring conditioner and proprietary anti-wear & anti-oxidant additives

Part # 41107 PAG 46 With Performance Booster

Part # 41121 PAG 100 With Performance Booster

Part # 41145 PAG 150 With Performance Booster

R134a OIL CHARGE

- Quick & easy way to add oil charge to R134a A/C systems
- Single application can
- Includes O-ring conditioner, Proprietary anti-wear and anti-oxidant additives
- Available in Universal PAG Oil or Ester

Part # 16310 Universal R134a
PAG Oil Charge 3 oz.

Part # 16600 Universal R134a Ester Oil Charge 3 oz.



COMPRESSOR QUIET

- Lubricates A/C system and quiets compressor
- Prevents acid formation and reduces corrosion
- Contains U/V dye for easy leak detection

Part # 62874
Compressor Quiet
2 oz. (60 ml)

Part # 63659
Compressor Quiet
Aerosol 4 oz. (114 g)



PERFORMANCE ENHANCER

- Compatible with R134a and HFO-1234yf air conditioning systems
- Will not harm A/C system or components
- Compatible with PAG, ester & mineral oils
- Reduces vent temperature 3° to 9°
- Reduces friction and increases system efficiency
- Reduces compressor wear

Part # 16129 Performance Enhancer Aerosol 4 oz. (Single application)

Part # 33812 Performance Enhancer + U/V Dye 1 oz. (30mL)

Part # 13791 Performance Enhancer Self-Measure Bottle 8 oz. (236.6mL)

Part # 27156 Performance Enhancer Syringe with installation hose 2 oz. (60 ml)

Part # 37391 Performance Enhancer Syringe 2 oz. (60 ml)

- Performance Enhancer with Total Leak Stop, stops small leaks in evaporators, condensers, rubber hoses gaskets and O-rings

Part # 27187 Total Leak Stop Syringe & Performance Enhancer with installation hose 2 oz. (60 ml)

Part # 37414 Total Leak Stop Syringe & Performance Enhancer without installation hose 2 oz. (60 ml)

**REDUCES VENT TEMPERATURE
3° to 9°**



HOW SUPERCOOL PERFORMANCE ENHANCER WORKS: Supercool Performance Enhancer contains cleaners which help to slowly dissolve lacquer and sludge coating the walls of the air conditioning system. Lacquer and sludge not collected in the desiccant bag solubilizes into the compressor oil without causing harm. Improved heat transfer together with friction modifiers in Supercool Performance Enhancer reduces vent temperature and helps the compressor run cooler, quieter and more efficiently.



HFO1234yf REFRIGERANT

The Next Generation Refrigerant!

OPTIMAL BENEFITS:

- Provides cost effective, CO2 credits for US EPA Greenhouse Gas regulations
- Low GWP, zero ODP refrigerant which meets EU F-gas regulation
- Thermally stable under extreme use conditions
- Similar operating conditions as R-134a
- Comparable energy efficiency and capacity compared to R-134a
- Cost-effective, near drop-in replacement for R-134a

Part # 1302 Honeywell 1234yf Refrigerant, 8 oz. Service Can / 4 per case

Part # HFO-1234yf-10 Dupont 1234yf Refrigerant 10 lb. Cylinder



HFO-1234yf CHARGING HOSE

**SCREW ON CAN TAP HOSE
DESIGNED FOR SELF SEALING
HFO1234yf REFRIGERANT CANS**

- Easy to read gauge
- Use with self sealing 12 oz. cans of HFO1234yf
- 90° Low side quick coupler

Part # 53742 HFO1234yf Charging Hose & Gauge

Part # 52059 HFO1234yf Can Tap



HFO-1234yf UNIVERSAL 68 LUBRICANT

- Multi-Grade oil Compatible with A/C systems using HFO-1234yf or R-134a refrigerant.
- Safe for hybrid & electric compressors.
- Complete additive package

Part # 48663-32 Universal 68 Without Dye 32 oz.

Part # 48663-32D Universal 68 + UV Dye 32 oz.



HYBRID/ELECTRIC HFO1234yf POE OIL

- Meets OEM performance specs
- Equivalent replacement for: SANDEN SE-10Y, HONDA 38899-RMX-A01, 38899-RCJ-A01, RL85HM (38899-RLV-A01), 38899-50Z-G01 & 38899-50Z-G03, DENSO ND-OIL 14
- Synthetic lubricant formulated for hybrid & electric compressors using HFO1234yf refrigerant
- High dielectric protection formula

Part # 64861 Hybrid/Electric POE Oil 4 oz.



HFO-1234yf PAG-H LUBRICANT

- Synthetic lubricant specially formulated for A/C systems using HFO-1234yf refrigerant
- Advanced high performance PAG lubricant provides excellent resistance to moisture.
- Contains conditioners, inhibitors & anti-wear agents
- Provides excellent lubricity and compressor protection



PAG WITHOUT UV DYE

Part # 27262 PAG 46-H WITHOUT DYE 8 oz.
Part # 42432 PAG 46-H WITHOUT DYE 32 oz.

Part # 38589 PAG 100-H WITHOUT DYE 8 oz.
Part # 42449 PAG 100-H WITHOUT DYE 32 oz.

PAG WITH UV DYE

Part # 27262D PAG 46-H + U/V DYE 8 oz.
Part # 42432D PAG 46-H + U/V DYE 32 oz.

Part # 38589D PAG 100-H + U/V DYE 8 oz.
Part # 42449D PAG 100-H + U/V DYE 32 oz.



A/C FLASH FLUSH



Our Fastest Evaporating Flush!

- Leaves no residue
- Effective cleaner
- Quickly penetrates and removes oil & other contaminants
- Non-corrosive
- Extremely flammable

Part # 22762 Flash Flush Quart

Part # 22779 Flash Flush Gallon

A/C FAST FLUSH



- Very effective cleaner
- Removes old oil & other contaminants
- Compatible with R134a, HFO-1234yf & R12 A/C lubricants
- NON-Flammable, NON-Hazardous
- Biodegradable and environmentally friendly

Part # FFQ Fast Flush Quart

Part # FFG Fast Flush Gallon

FLOW CONTROL FLUSH GUN

Compressed Air Hose Adaptor Included



- Attach to shop air for maximum pressure & effectiveness
- Flush cylinder can be pressurized for use without airhose attached
- Ideal for removing contaminants, moisture, and acid from A/C systems using R134a, HFO-1234yf and R12 refrigerants
- Detailed instructions included

Part # 27361 Flow Control Flush Gun in box
Supersedes Part# 24-1497

Part # FLGN Replacement Flush Nozzle

TOTAL LEAK STOP + U/V DYE



- Stops small leaks in evaporators, condensers, hoses, gaskets, seals & O-rings
- Does not contain polymers. Will not harm or clog A/C system components or equipment.
- Treats 1 vehicle

Part # 39241-YF Total Leak Stop with U/V Dye 1oz. (28.5 g)

Part # 39241B-YF Total Leak Stop with U/V Dye 1oz. (28.5 g) in retail box

Part # ST22 Total Leak Stop + U/V Dye 2 oz. bottle
Installs easily using an oil injector

U/V SUPER DYE



**TESTED!
APPROVED!
CERTIFIED!**

- SAE Certified for HFO-1234yf A/C Systems
- Safe for hybrid and electric A/C systems
- Detectable when exposed to any U/V light
- Compatible with PAG, ester & mineral oils
- Does not contain solvents, will not harm A/C systems or recovery equipment
- Contains anti-wear agents, friction modifiers and anti-oxidants which enhance system efficiency and extend compressor life
- 1/4 oz. (7.5 ml) per vehicle

Part # 24056 Super Dye self-measure bottle 16 oz. (473 ml)

Part # 22816 Super Dye self-measure bottle 8 oz. (237 ml)

Part # 33003 Super Dye round bottle 1 oz. (29.5 ml)

HFO-1234yf ALUMINUM MANIFOLD GAUGE SETS

- Designed specifically for use with HFO-1234yf refrigerant
- Includes 72" hoses -- red, blue, yellow and lock-on service couplers in plastic case
- Scales in PSI and BAR measurements
- Large sight glass for visual inspections
- Auxiliary vacuum line access port



Part # 37520-PC HFO-1234yf Aluminum Manifold Gauge Set

- Designed specifically for use with HFO-1234yf refrigerant
- Includes 72" high pressure red, blue, yellow hoses with 800 PSI WP & 4000 PSI BP
- Lock-on service couplers
- Vibration free gauges scale in PSI and BAR measurements
- Large sight glass for visual inspections
- Auxiliary vacuum line access port

Premium Heavy Duty



Part # 62362 Premium HFO-1234yf Aluminum Manifold Gauge Set

HFO-1234yf CAN TAP



- Brass dispensing valve for self-sealing HFO-1234yf cans with 1/2" ACME LH fitting
 - Left hand thread
- Part # 52059
HFO-1234yf can tap

HFO-1234yf SERVICE COUPLERS

Part # 26890
Low Side Coupler



Part # 26906
High Side Coupler



Part # 50130
1234yf Tank Adapter
1/2" Acme Male Right Hand Thread x 1/2" Acme Female Left Hand Thread



Part # 48007
1/2" ACME
1234yf Vacuum Pump Adapter



HYBRID/ELECTRIC COMPRESSOR OIL

- Compatible with R134a and 1234yf systems
- Synthetic lubricant specially formulated for hybrid & electric air conditioning compressors
- High dielectric protection formula has excellent "resistivity" to potential electrical current leakage in high voltage hybrid & electric A/C systems
- Contains conditioners, inhibitors & anti-wear agents



Part # 24940
Hybrid A/C Compressor Oil 7 oz.

HYBRID/ELECTRIC HFO1234yf POE OIL

- Meets OEM performance specs
- Equivalent replacement for-SANDEN SE-10Y, HONDA 38899-RMX-A01, 38899-RCJ-A01, RL85HM (38899-RLV-A01), 38899-50Z-G01 & 38899-50Z-G03, DENSO ND-OIL 14
- Synthetic lubricant formulated for hybrid & electric compressors using HFO1234yf refrigerant
- High dielectric protection formula



Part # 64861
Hybrid/Electric POE Oil 4 oz.

**HYBRID & ELECTRIC VEHICLES...
THE WAVE OF THE FUTURE**
Be Ready with Supercool!

HAND-TURN DYE/OIL INJECTOR



1234yf Quick Connect Coupler

- Does not require a Manifold Gauge to use on low side of pressurized systems
- For introducing from 1/4oz. (7.5ml) up to 2oz. (60ml) of U/V Dye, Lubricants and Leak Stop (ST22) to a closed A/C system without adding refrigerant
- Quick connect style for HFO-1234yf systems

Part # 43460 HFO-1234yf Hand Turn Injector



PAG OIL

#1 Seller!

- Meets OEM performance specifications
- High performance synthetic PAG for R134a systems provides excellent resistance to moisture
- Anti-Wear Agents and Friction Modifiers enhance compressor & A/C system efficiency while reducing compressor wear rates which extends compressor life
- Anti-Oxidants protect system against formation of sludge and other deposits which can shorten compressor life and reduce system efficiency



PAG + U/V DYE

Part # P46-8D	PAG 46 + U/V DYE	8 oz.
Part # P46-32D	PAG 46 + U/V DYE	32 oz.
Part # P46-128D	PAG 46 + U/V DYE	Gallon
Part # P100-8D	PAG 100 + U/V DYE	8 oz.
Part # P100-32D	PAG 100 + U/V DYE	32 oz.
Part # P100-128D	PAG 100 + U/V DYE	Gallon
Part # P150-8D	PAG 150 + U/V DYE	8 oz.
Part # P150-32D	PAG 150 + U/V DYE	32 oz.
Part # P150-128D	PAG 150 + U/V DYE	Gallon

PAG WITHOUT U/V DYE

Part # P46-8	PAG 46 W/O DYE	8 oz.
Part # P46-32	PAG 46 W/O DYE	32 oz.
Part # P46-128	PAG 46 W/O DYE	Gallon
Part # P100-8	PAG 100 W/O DYE	8 oz.
Part # P100-32	PAG 100 W/O DYE	32 oz.
Part # P100-128	PAG 100 W/O DYE	Gallon
Part # P150-8	PAG 150 W/O DYE	8 oz.
Part # P150-32	PAG 150 W/O DYE	32 oz.
Part # P150-128	PAG 150 W/O DYE	Gallon

UNIVERSAL PAG BLUE



- Advanced high performance synthetic PAG provides excellent resistance to moisture
- Specially formulated for aftermarket air conditioning systems using R134a refrigerant
- Contains conditioners, inhibitors and anti-wear agents for excellent lubricity and compressor protection, helps reduce compressor wear
- Meets OEM performance specifications

Part # PB8
High Performance PAG-Blue 8 oz.

Part # PB32
High Performance PAG-Blue 32 oz.
with measuring indicators

UNIVERSAL PAG + U/V DYE

- Blended with U/V dye to detect leaks
- Advanced high performance synthetic PAG provides excellent resistance to moisture
- Specially formulated for aftermarket air conditioning systems using R134a refrigerant
- Contains conditioners, inhibitors and anti-wear agents for excellent lubricity and compressor protection, helps reduce compressor wear
- Meets OEM performance specifications

Part # 27880
Universal PAG + UV Dye 8 oz.

Part # 27897
Universal PAG + UV Dye 32 oz.
with measuring indicators



PAG OIL + PERFORMANCE ENHANCER



- Meets OEM performance specifications
- Premium, Synthetic Polyalkylene Glycol (PAG) oil plus additives for R134a air conditioning systems.
- Performance enhancer improves heat transfer & increases system efficiency reducing vent temperature.
- High performance PAG lubricant provides excellent lubricity.
- Helps reduce compressor wear. Contains conditioners, inhibitors & anti-wear agents for added compressor protection.
- Specially formulated for aftermarket air conditioning systems using R134a refrigerant.



PAG + PE AND U/V DYE

Part # P46-8DPE	PAG 46 + U/V DYE	8 oz.
Part # P46-32DPE	PAG 46 + U/V DYE	32 oz.
Part # P100-8DPE	PAG 100 + U/V DYE	8 oz.
Part # P100-32DPE	PAG 100 + U/V DYE	32 oz.
Part # P150-8DPE	PAG 150 + U/V DYE	8 oz.
Part # P150-32DPE	PAG 150 + U/V DYE	32 oz.

PAG + PE WITHOUT U/V DYE

Part # P46-8PE	PAG 46 W/O DYE	8 oz.
Part # P46-32PE	PAG 46 W/O DYE	32 oz.
Part # P100-8PE	PAG 100 W/O DYE	8 oz.
Part # P100-32PE	PAG 100 W/O DYE	32 oz.
Part # P150-8PE	PAG 150 W/O DYE	8 oz.
Part # P150-32PE	PAG 150 W/O DYE	32 oz.

ESTER OIL + PERFORMANCE ENHANCER

ESTER + PE AND U/V DYE

Part # E8-PE	Ester + UV Dye 8 oz.
Part # E32-PE	Ester + UV Dye 32 oz.

ESTER + PE (W/OUT U/V DYE)

Part # E7-PE	Ester 8 oz.
Part # E31-PE	Ester 32 oz.

- Performance enhancer improves heat transfer & increases system efficiency reducing vent temperature.
- High Performance Ester lubricant provides excellent lubricity and compressor protection.
- Specially formulated for aftermarket air conditioning systems using R134a and R12 refrigerant.
- Compatible with PAG and Mineral Oils.
- Helps reduce compressor wear. Contains conditioners, inhibitors & anti-wear agents for added compressor protection.



#1 Seller!

ESTER & PAO OIL

UNIVERSAL LUBRICANTS



ESTER + U/V DYE

- Part # E8 Ester + UV Dye 8 oz.
- Part # E32 Ester + UV Dye 32 oz. with Measuring Indicators
- Part # E128 Ester + UV Dye Gallon (not pictured)

ESTER (WITHOUT U/V DYE)

- Part # E7 Ester 8 oz.
- Part # E31 Ester 32 oz. with Measuring Indicators
- Part # E127 Ester Gallon (not Pictured)

- Synthetic ester lubricant provides excellent lubricity and compressor protection
- Includes additives to prevent acid formation and corrosion
- Includes O-ring conditioner, anti-wear & anti-oxidant additives
- Compatible with PAG and mineral oils
- Compatible with R134a and R12 refrigerant



PAO 68

- Part # 25145 PAO 68 + U/V Dye 32 oz.
- Part # 25411 PAO 68 32 oz.

- Premium synthetic universal compressor oil
- Non-hygroscopic, does not absorb moisture
- For car, truck & agricultural A/C systems
- Compatible with POE A/C lubricants
- Not compatible with PAG lubricants
- Can be used with R134a, R12, R22, R401b, R401c, R404a, R404c, R407c, R409a, R409b, R413a, R500, R507a

MINERAL OIL



- Super premium mineral oil
- For use in A/C systems using R12 refrigerant
- 525 SAE Viscosity

Part # MO-500-GM
Premium Mineral Oil 32 oz.

Part # MO-500-GM-128P
Premium Mineral Oil 128 oz.

TOTAL LEAK STOP

Leak Stop + U/V Dye

SUPERCool - TRUSTED BY PROFESSIONALS



HFC FREE TOTAL LEAK STOP + U/V DYE

PATENTED BOV DELIVERY SYSTEM

- Stops small leaks in METAL & RUBBER components including evaporators, condensers, hoses, gaskets, seals & O-rings
- Does not contain polymers. Will not harm or clog AC system components, reclamation or recovery equipment
- Will not clog orifice tubes or expansion devices
- Lubricates system and helps extend system life
- 1 can treats 1 vehicle
- Patented technology HFC-FREE aerosol
- Compatible with R134a, HFO1234yf and R-12 systems
- Safe for hybrid and electric compressors

R134a TOTAL LEAK STOP + U/V DYE

Part # 39241 Total Leak Stop with U/V Dye 1oz. (28.5 g)

Part # 39241B Total Leak Stop with U/V Dye 1oz. (28.5 g) in retail box

HFO-1234yf TOTAL LEAK STOP + U/V DYE

Part # 39241-YF Total Leak Stop with U/V Dye 1oz. (28.5 g)

Part # 39241B-YF Total Leak Stop with U/V Dye 1oz. (28.5 g) in retail box

HFC FREE TOTAL LEAK STOP + U/V DYE

- Stops small leaks in evaporators, condensers, hoses, gaskets and seals
- Does not contain polymers. Will not harm or clog AC system components, reclamation or recovery machines.
- 1 can treats 1 vehicle
- Patented technology HFC-FREE aerosol
- US Patent No. 8,047,009, foreign patents pending.

Part # 22878 Total Leak Stop HFC FREE Aerosol can with hose 2 oz. (For R134a systems)



PATENTED DELIVERY SYSTEM

FOR METAL & RUBBER COMPONENTS

TOTAL LEAK STOP + U/V DYE

- Stops small leaks in evaporators, condensers, hoses, gaskets & seals
- Does not contain polymers. Will not harm or clog A/C system components or equipment.
- 1 can or bottle treats 1 vehicle
- ST22 installs easily using an oil injector
- ST27 installs easily using an R134a Can Tap (Part # 401)

Part # ST22 Total Leak Stop + U/V Dye 2 oz. bottle (For R134a, HFO-1234yf & R12 systems)

Part # ST27 Total Leak Stop + U/V Dye 4 oz. Aerosol Can

(For R134a systems only)

FOR METAL & RUBBER COMPONENTS



SUPERCool LEAK STOPS DO NOT CONTAIN POLYMERS

Supercool Leak Stops are specifically formulated without polymers. This is important because polymers react with air and moisture in the A/C system to form a solid epoxy-like seal at the site of the leak. Unfortunately polymeric leak stops can also react with air and moisture in A/C systems and recovery equipment far from the site of a leak. This has the potential to cause undesirable, costly and catastrophic blockage in critical components such as the orifice tube in an A/C system or the solenoids in A/C recovery equipment.

A/C "RED" TOTAL LEAK STOP

- Compatible with HFO-1234yf, R134a and hybrid A/C systems
- Stops small leaks in evaporator, condenser, hoses, O-rings and gaskets
- Lubricates system and helps prevent leaks
- Compatible with PAG, ester and mineral oils
- 2 ounces treats 1 vehicle
- Does not contain polymers. Will not harm A/C system components, compressor seals or bearings, will not harm or contaminate reclamation/recovery machines

Part # 48267 Total Leak Stop 2 oz. bottle (60 ml)

Part # 33911 Total Leak Stop self-measure bottle 8 oz. (240 ml)



R134a A/C SEAL LEAK STOP + U/V DYE

- Does not contain polymers. Will not harm A/C system components, compressor seals or bearings, will not harm or contaminate reclamation/recovery machines
- Stops refrigerant leaks on rubber hoses, gaskets, seals and ALL types of O-rings including HNBR, Nitrile and Neoprene.
- Contains 2 oz. of R134a refrigerant
- Compatible with PAG, ester and mineral oils
- 4 ounce can treats 1 vehicle
- Charges into air conditioning system with standard R134a can tap

RUBBER ONLY COMPONENTS

Part # STOPA Seal Leak Stop with U/V Leak Detection Dye 4 oz.

Part # 24087 Seal Leak Stop with RED Leak Detection Dye 3 oz.



A/C SEAL LEAK STOP CONCENTRATE

- Does not contain polymers. Will not harm A/C system components, compressor seals or bearings, will not harm or contaminate reclamation/recovery machines
- Specially formulated to stop refrigerant leaks on rubber hoses, gaskets, seals and ALL types of O-rings including HNBR, Nitrile and Neoprene
- Use 1/4 ounce per vehicle
- Compatible with R134a and R12 refrigerants
- Compatible with PAG, ester, and mineral oils

Part # STOP Seal Leak Stop Concentrate Treats up to 16 vehicles 4 oz.

Part # ST8 Seal Leak Stop Concentrate Self-Measure bottle treats up to 32 vehicles 8 oz. (237 ml)



LEAK STOP IDENTIFICATION LABEL

- Multi-use label notes presence of leak stop in A/C or other engine systems.

Part # SLAB-10 10 labels per bag

Part # SLAB-500 500 label roll

This System Contains Leak Sealant

Sealant Used

Date Installed / /

TESTED! APPROVED! CERTIFIED!

U/V Leak Detection
Super Dye

**SAE
CERTIFIED**
J2297
Standards

- SAE Certified for R134a and HFO-1234yf A/C Systems
- Safe for hybrid and electric A/C systems
- Detectable when exposed to any U/V light
- Compatible with PAG, ester, and mineral oils
- Does not contain solvents!
- Will not harm A/C systems or recovery equipment
- Anti-Wear Agents and friction modifiers enhance compressor and A/C system efficiency while reducing compressor wear rates which extends compressor life
- Anti-Oxidants protect system against formation of sludge and other deposits which can shorten compressor life and reduce system efficiency
- 1/4 oz. (7.5 ml) per vehicle



COMPATIBLE
HFO-1234yf
COMPATIBLE

TREATS
8 VEHICLES
TREATS

- Part # 22816 Super Dye self-measure bottle 8 oz. (237 ml)
- Part # 24056 Super Dye self-measure bottle 16 oz. (473 ml)
- Part # 24445 Super Dye self-measure bottle 32 oz. (946 ml)
- Part # 24452 Super Dye squeeze tip bottle 8 oz. (237 ml)
- Part # 33430 Super Dye squeeze tip bottle 32 oz. (946 ml)
- Part # 33003 Super Dye round bottle 1 oz. (29.5 ml)
- Part # 33003CS Super Dye 1 oz. (29.5ml) round bottle in clamshell
- Part # 27132 Super Dye Syringe with installation hose 2 oz. (60 ml)
- Part # 34697 Super Dye Syringe without installation hose 2 oz. (60 ml)
- Part # 27972 Super Dye 1/4 oz. (7.5 ml) Syringe 6-pack 2 oz.
- Part # 27125 12-pack, 1/4 oz. (7.5 ml) Yellow Super Dye Syringes
- Part # 27606 12-pack, 1/4 oz. (7.5 ml) Yellow Super Dye Syringes with Quick Connect Installation Hose
- Part # 26203 Quick Connect Installation Hose





GREEN U/V LEAK DETECTION DYE CONCENTRATE

- Effective in R134a, R1234yf, R12 & hybrid and electric A/C systems
- Detectable when exposed to U/V light
- Compatible with PAG, ester, and mineral oils
- Does not contain solvents!
- Will not harm A/C systems or recovery equipment
- 1/4 oz. (7.5 ml) per vehicle

- Part # 9497 Green U/V Dye 1 oz. (29.5 ml)
- Part # D4 Green U/V Dye 4 oz. (118 ml.)
- Part # D8 Green U/V Dye self-measure bottle 8 oz. (237 ml)
- Part # 7400 Green U/V Dye with squeeze tip 8 oz. (237 ml.)
- Part # D16 Green U/V Dye self-measure bottle 16 oz. (473 ml)
- Part # D32 Green U/V Dye bottle with squeeze tip 32 oz. (946 ml)

UNIVERSAL AC DYE SAFE FOR HYBRID & ELECTRIC VEHICLES

SINGLE APPLICATION U/V DYE

Part # D1-12 Green U/V Dye 1/4 oz. single application tube 12 pack clamshell



DYE SERVICE LABELS

- Multi-use label warns of dye in A/C or other engine systems

Part # 3754 10-pack dye labels

Part # 8186 500 label roll

THIS SYSTEM CONTAINS LEAK DETECTION DYE. INSPECT THE SYSTEM WITH AN ULTRAVIOLET LAMP. THE LEAK SOURCE WILL FLUORESCENCE (GLOW) BRIGHTLY WHEN EXPOSED TO UV LIGHT.

<input type="checkbox"/> A/C DYE	<input type="checkbox"/> ENGINE OIL DYE
<input type="checkbox"/> COOLANT DYE	<input type="checkbox"/> OTHER _____
DATE INSTALLED	____ / ____ / ____
LOCATION OF SERVICE	_____

LEAK DETECTION

U/V Dye

SUPERCOOL - TRUSTED BY PROFESSIONALS

U/V LEAK DETECTION DYE

- Effective in R134a, R1234yf, R12 & hybrid and electric A/C systems
- Detectable when exposed to U/V light
- Compatible with PAG, ester, and mineral oils
- Does not contain solvents

Part # 9497	Green U/V Dye 1 oz. (29.5ml)
Part # 9497CS	Green U/V Dye 1 oz. (29.5ml) Clamshell pack
Part # D8	Green U/V Dye self-measure bottle 8 oz. (237 ml)
Part # 3754	Bag of 10 Dye Service Labels



MULTI-PURPOSE TOTAL DYE

- Use with motor oil, hydraulic fluid, power steering fluid, brake fluid, diesel fuel, gasoline & transmission fluids
- Mix 1/4 ounce per quart of fluid
- Most effective in clean diesel and engine oils
- Detectable when exposed to U/V light

Part # 16525	Total Dye 1 oz. (29.5 ml) (Single Application)
Part # 16525CS	Total Dye 1 oz. (29.5ml) Clamshell pack
Part # TD8	Total Dye 8 oz. (237 ml) Self-Measure Bottle
Part # 3754	Bag of 10 Dye Service Labels



RADIATOR COOLANT U/V DYE

- Professional U/V leak detector dye
- Helps to quickly find cooling system leaks
- Detectable with any U/V light
- Use 1 ounce per vehicle

Part # 16532	Radiator Dye 1 oz. (29.5 ml) (Single Application)
Part # 16532CS	Radiator Dye 1 oz. (29.5ml) Clamshell pack
Part # RD8	Radiator Dye 8 oz. (237 ml) Self-Measure Bottle
Part # 3754	Bag of 10 Dye Service Labels



U/V LEAK DETECTION DYE

CONVENIENT SQUEEZE TIP BOTTLES

- Safe for R134a, HFO-1234yf, hybrid and electric A/C systems
- Detectable when exposed to U/V light
- Compatible with PAG, ester, and mineral oils
- Does not contain solvents
- Easy to use squeeze tip bottles
- Great for refilling all types of dye cartridges

Part # 24452 SAE Yellow U/V Dye with squeeze tip 8 oz. (237 ml.)

Part # 7400 Green U/V Dye with Squeeze Tip 8 oz. (237 ml)



ULTRAVIOLET LEAK DETECTION KITS



- Part #24414**
- Powerful 12-volt, 50-watt leak detection lamp with long, heavy gauge power cord
 - U/V dye 8 oz. (treats 32 vehicles)
 - Hand turn dye & oil injector
 - U/V enhancing glasses
 - **BONUS** 2 oz. Total A/C Leak Stop



- Part #24360**
- Contains U/V Light, D4, U/V Glasses & **BONUS** 2 oz. Total A/C Leak Stop

- Part #24025**
- Contains U/V Light, D8, TD8, Hand Turn Dye Injector, U/V Glasses & **BONUS** 2 oz. Total A/C Leak Stop

U/V LEAK DETECTION LAMPS

U/V LEAK DETECTION LIGHT WITH GLASSES

HIGH POWERED, LED U/V LIGHT

- Illuminates fluorescent dyes brilliantly
- High intensity beam makes even small leaks visible and is bright enough to be used in low light as well as daylight and brightly lit areas
- LED has extra long life and produces an intense UV light
- Uses 3 AAA batteries included
- Anodized aluminum, rugged construction
- Nylon wrist lanyard



FLUORESCENCE ENHANCING GLASSES

- Makes leaks easy to spot
- Works with all fluorescent dyes
- Safety rated, laser engraved with DIN EN 166 CE
- Designed with super luminescence so leaks are easier to spot

Part # 27408 High Powered U/V Leak Detection Light with Glasses in clamshell

Part # 26807 High Powered U/V Leak Detection Light with Glasses in white box

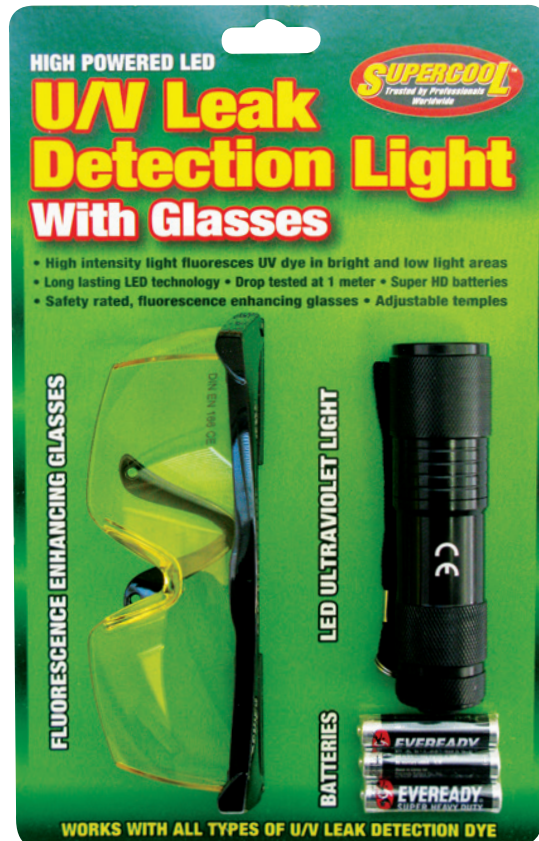

9 LED U/V LIGHT W/GLASSES

- Fluoresces all common U/V dyes
- Includes 3 AAA 1.5 V batteries
- Yellow glasses help to enhance ultraviolet dye

Part # 9336 U/V Enhancing Glasses

Part # 24353 9 LED U/V Inspection Light



Part # 24353



Part # 9336

U/V LEAK DETECTION LAMPS

LED U/V LEAK DETECTION LIGHT

HIGH POWERED, LED U/V LIGHT

- Provides 3-modes of operation
HIGH BEAM LOW BEAM STROBE
- 3 AAA Heavy duty batteries included
- Illuminates fluorescent dyes brilliantly
- High intensity beam makes even small leaks visible and is bright enough to be used in low light as well as daylight and brightly lit areas
- LED has extra long life and produces an intense UV light
- Anodized aluminum, rugged construction
- Nylon wrist lanyard
- Drop tested at 1 meter
- On/off/mode push-button switch

Part # 52974 High Powered LED
U/V Leak Detection Light in clamshell

**WORKS WITH ALL TYPES OF
U/V LEAK DETECTION DYE**



EXTENDABLE U/V POCKET LIGHT

- Perfect for close-up leak inspections of automotive systems containing U/V Dye
- Light duty medium intensity U/V LED
- Rated for over 50,000 hours of use
- Pocket sized, extendable
- Includes adjustable service mirror for hard to see areas
- 9 LED UV Lamp uses only 3 AAA batteries

Part # 7301 U/V Pocket Light

Part # 7370 Battery 3 Pack

Part # 7387 Replacement bulb for pocket light



Part # 7301

R134a & HF01234yf U/V DYE SYRINGES

- SAE Certified for R134a & HF01234yf AC Systems
- Safe for hybrid and electric A/C systems
- Detectable when exposed to any U/V light
- Compatible with PAG, PAO, ester, and mineral oils
- Does not contain solvents!
- Will not harm A/C systems or recovery equipment
- Anti-Wear Agents and friction modifiers enhance compressor and A/C system efficiency while reducing compressor wear rates which extends compressor life
- Anti-Oxidants protect system against formation of sludge and other deposits which can shorten compressor life and reduce system efficiency
- 1/4 oz. (7.5 ml) per vehicle

Part # 27132 Super Dye Syringe with applicator hose 2 oz. (60 ml)

Part # 34697 Super Dye Syringe without applicator hose 2 oz. (60 ml)

Part # 27972 6-pack, 1/4 oz. (7.5 ml) Yellow Super Dye Syringes

Part # 26203 R134a Quick Connect Installation Hose

Part # 64731 HF01234yf Quick Connect Installation Hose

Part # QC134 Quick Connect Syringe Applicator

QC134



BULK PACKS IN WHITE BOXES

Part # 27125 12-pack, 1/4 oz. (7.5 ml) Yellow Super Dye Syringes
TREATS 12 VEHICLES, Case pack of 12

Part # 27606 12-pack, 1/4 oz. (7.5 ml) Yellow Super Dye Syringes
with Quick Connect Installation Hose
TREATS 12 VEHICLES, Case pack of 12

Part # 62935 8-pack, 2 oz. (60 ml) Yellow Super Dye Syringes
TREATS 64 VEHICLES, Case pack of 12



PERFORMANCE ENHANCER A/C BOOSTER

- Compatible with all R134a air conditioning systems
- Will not harm A/C system or components
- Compatible with PAG, ester, hybrid, electric, PAO and mineral oils
- Contains U/V Dye charge
- Reduces vent temperature 3° to 9°
- Reduces friction
- Increases system efficiency
- Reduces compressor wear
- 1 oz. (30 ml) per vehicle

Part # 27156 Performance Enhancer Syringe with installation hose 2 oz. (60 ml)

Part # 37391 Performance Enhancer Syringe without installation hose 2 oz. (60 ml)



BULK PACK - Part # 62904 8-pack, 2 oz. (60 ml) Performance Enhancer
Syringes TREATS 16 VEHICLES, Case pack of 12



R134a HF01234yf LEAK STOP SYRINGES

A/C TOTAL LEAK STOP

- Stops small leaks in evaporators, condensers, rubber hoses, gaskets & O-rings
- Contains U/V Dye for leak detection
- Does not contain polymers. Will not harm or clog A/C system components, reclamation or recovery machines.
- 1 oz. (30 ml) per vehicle

Part # 27200 Total Leak Stop Syringe with installation hose 2 oz. (60 ml)

Part # 37414 Total Leak Stop Syringe without installation hose 2 oz. (60 ml)

A/C TOTAL LEAK STOP WITH PERFORMANCE ENHANCER

- Stops small leaks in evaporators, condensers, rubber hoses, gaskets & O-rings
- Contains performance enhancer which improves heat transfer, increases system efficiency and reduces vent temperature
- Does not contain polymers. Will not harm or clog A/C system components, reclamation or recovery machines
- 1 syringe treats 1 vehicle

Part # 27187 Total Leak Stop Syringe & Performance Enhancer with installation hose 2 oz. (60 ml)

Part # 37124 Total Leak Stop Syringe & Performance Enhancer without installation hose 2 oz. (60 ml)

BULK PACKS IN WHITE BOXES

Part # 62911 8-pack, 2 oz. (60 ml) Total Leak Stop with UV Dye Syringes TREATS 16 VEHICLES, Case pack of 12

Part # 62928 8-pack, 2 oz. (60 ml) Total Leak Stop + Performance Enhancer Syringes TREATS 8 VEHICLES, Case pack of 12

A/C SEAL LEAK STOP

- A/C Seal Leak Stop in convenient to use 1/4 oz. (7.5 ml) single use syringes
- Stops small leaks in rubber hoses, gaskets, seals & O-rings
- Each syringe treats one vehicle
- Allows easier, quicker and cleaner filling of any type injector
- Product does not come in contact with moisture in air
- Allow precision measurement of product
- Use with Supercool part #26203 quick connect or #15290 dye/oil injector installation hose which allows adding products directly to charged A/C systems

Part # 27989 6-pack, 1/4 oz. (7.5 ml) Seal leak stop syringes

Part # 26203 Quick Connect Installation Hose



BULK PACKS IN WHITE BOXES

Part # 27170 12-pack, 1/4 oz. (7.5 ml) Seal leak stop syringes

Part # 27590 12-pack, 1/4 oz. (7.5 ml) Seal leak stop syringes with installation hose

POWER JET AEROSOL A/C FLUSH

- Ready to use high pressure A/C flush
- Excellent cleaner, fast evaporating
- Safe for all air conditioning systems
- Removes oil, debris & other contaminants from air conditioning system components
- Constant pressure until can is empty
- Quick drying under vacuum

**Powerful
Fast Evaporating
Easy To Use!**



Part # 27637 Power Jet Aerosol A/C Flush Kit,
Includes Hose, Nozzle, Depressor Valve
and Flushing Agent, 444 ml (15 oz.)

Part # 27392 Power Jet Aerosol A/C Flush
Replacement Can, 444 ml (15 oz.)

Part # 27491 Power Jet Flush
Hose Set

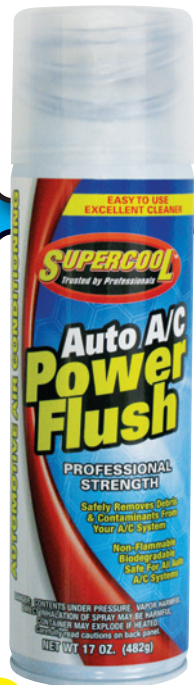

A/C POWER FLUSH AEROSOL

- Convenient and easy to use
- Extremely effective and FAST evaporating
- Removes old oil & contaminants
- Compatible with R134a, HFO-1234yf and R12 A/C lubricants
- No need for a separate flush kit or canister
- Includes convenient installation hose
- Requires shop air to effectively blow through and clean components
- Non-flammable, biodegradable & environmentally friendly
- Compatible with all PAG, ester and mineral oil.
- Safe for hybrid vehicles

Part # 28184 17 oz. Power Flush with hose

Part # 38596 17 oz. Power Flush with cone applicator



A/C FLASH FLUSH



OUR FASTEST EVAPORATING FLUSH

- Leaves no residue
- Effective cleaner
- Quickly penetrates and removes oil and other contaminants from A/C components
- Non-corrosive
- Extremely flammable

Part # 22762 Flash Flush Quart

Part # 22779 Flash Flush Gallon



A/C FAST FLUSH

- Very effective cleaner
- Removes old oil & other contaminants
- Compatible with R134a, HFO-1234yf & R12 A/C lubricants
- NON-Flammable, NON-Hazardous
- Biodegradable & environmentally friendly

Part # FFQ Fast Flush Quart

Part # FFG Fast Flush Gallon

PREMIUM QUALITY A/C FLUSH

- Compatible with R134a, HFO-1234yf & R12 A/C lubricants
- NON-Flammable, NON-Hazardous
- Biodegradable & environmentally friendly



A/C EXTRA FLUSH

- FAST evaporating
- Extremely effective cleaner
- Removes old oil and other contaminants
- Has pleasant "citrus" odor

Part # EFQ Extra Flush Quart

Part # EFG Extra Flush Gallon

A/C EXTRA FLUSH II

- Extremely effective cleaner
- Removes polymeric stop leak agents, old oil and other contaminants
- Micron-thin coating remains on internal system Components to provide protection against Future harmful stop leak polymers

Part # EFQ2 Extra Flush II Quart

Part # EFG2 Extra Flush II Gallon



FLOW CONTROL FLUSH GUN

- **Compressed Air Hose Adaptor Included**
- Attach to shop air for maximum pressure & effectiveness
- Flush cylinder can be pressurized for use without airhose attached
- Ideal for removing contaminants, moisture, and acid from air conditioning systems using R134a, HFO-1234yf and R12 refrigerants
- Detailed instructions included

Part # 27361 Flow Control Flush Gun in box
Supersedes Part# 24-1497

Part # FLGN High Flow Replacement Flush Nozzle

FLUSH HOSE

- Quick connect head adjusts to any size outlet, no grommets required
- Connect to outlet of component being flushed, drop end of hose into bucket to keep both vehicle and shop clean during flushing

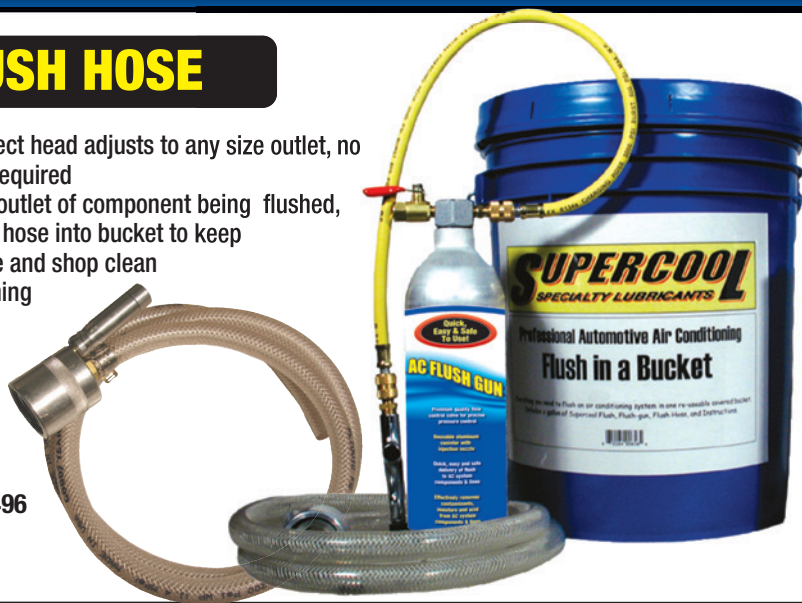

FLUSH IN A BUCKET

- Flow control flush gun
- Quick connect waste fluid drain hose
- Reusable and sealable bucket with instructions

Part # FB2
A/C Flush Kit in a Bucket

Part # 24 -1496

RECYCLE GUARD SEALANT, DYE & LUBRICANT SEPARATOR

- Filters out sealants, dye & lubricant
- Prevents damage to A/C service equipment
- Keeps refrigerant supply clean
- Protects recovery oil separators
- Traps oil sludge
- Works on all A/C service equipment
- Maintains closed loop refrigerant flush capability
- Easy cleanout contaminant drain



Part # 72100 Recycle Guard Filter

Part # 12503 Yellow R-134a Refrigerant Hose 36"

UNIVERSAL HIGH SIDE IN-LINE FILTER **REDUCE COMPRESSOR COMEBACKS!**

- OEM recommended and approved
- Protect against costly repeat compressor failure
- Single kit fits 5/16", 3/8", and 1/2" lines
- Captures residual debris in A/C system
- Holds any size orifice tube with included installation clip
- Quick and easy leak free installation requiring only 4" of straight refrigerant line
- Can be used as line splice or repair device for damaged orifice tube holders
- Tapered sealing sleeve provides 10 times the sealing area of older filter designs
- Shorter filter length, with 3 times the capacity -- reduces pressure and flow restrictions
- Provides a reliable solution to reduce comebacks on compressor replacements -- especially on rear A/C Systems

Part # 13128

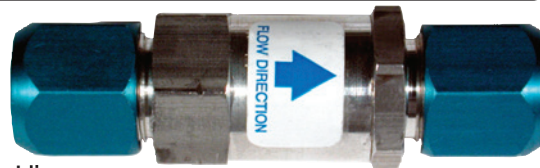

OEM TESTED & APPROVED!

CAPTURE & HOLD DAMAGING A/C SYSTEM DEBRIS WITHOUT DIMINISHING PERFORMANCE

The receiver/drier, accumulator/drier, orifice tube, and thermostatic expansion valve were never designed to act like major systems filters. After a catastrophic compressor failure the Part # 13128 Universal High Side In-line Filter Kit provides a low cost insurance policy against further system damage.

COMPRESSOR GUARD TOOLS



OEM APPROVED AND RECOMMENDED

- 20 sizes to fit most domestic and import compressors
- OEM approved and recommended
- Screens are matched to suction port size, not compressor model
- New screens have size printed on screen lip for easier identification
- Easy to install into the suction line manifold without cutting hose or removing muffler assembly from vehicle
- Protects replacement compressor from suction hose/muffler debris

Part # 14118 20 Screen Compressor Guard & Installation Kit (with tools)

Screen Refills Available in 5 Pack Bags:

Part No.	Screen Size	Fits ID Range
67518	0.395 (10.03 mm)	.384 to .392
67520	0.404 (10.26 mm)	.393 to .401
67522	0.436 (11.07 mm)	.425 to .433
67524	0.463 (11.76 mm)	.452 to .460
67502	0.471 (11.96 mm)	.460 to .468
67526	0.492 (12.50 mm)	.481 to .489
67528	0.500 (12.70 mm)	.489 to .497
67504	0.510 (12.95 mm)	.499 to .507
67506	0.521 (13.23 mm)	.510 to .518
67508	0.531 (13.49 mm)	.520 to .528

Part No.	Screen Size	Fits ID Range
67510	0.538 (13.67 mm)	.527 to .535
67512	0.552 (14.02 mm)	.541 to .549
67536	0.561 (14.25 mm)	.550 to .558
67538	0.579 (14.70 mm)	.568 to .576
67530	0.588 (14.93 mm)	.577 to .585
67514	0.595 (15.11 mm)	.584 to .592
67532	0.600 (15.24 mm)	.589 to .597
67516	0.618 (15.70 mm)	.607 to .615
67540	0.649 (16.48 mm)	.638 to .646
67534	0.821 (20.85 mm)	.811 to .819

SCABC-25 Compressor Guard Warning Labels, bag of 25

MINI TUBE CUTTER

- Designed to fit in tight areas
- For aluminum, copper & soft tubes

Part # 15597

Mini Tube Cutter -- 3 to 16mm (1/8" to 5/8" O.D)

Part # 15603

Tube Cutter Replacement Cutting Wheels

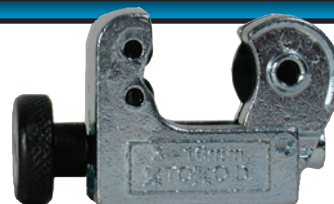

ODOR BUSTER AUTO FOGGER

- Specially formulated to handle problems associated with moisture accumulation and odors in automotive air conditioning systems
- Quick and easy to use (15 minute procedure)
- Odor Buster Auto Fogger™ does not cover-up odors, it eliminates them at the source
- Eliminates odors caused by mold, mildew, pets, tobacco smoke & more
- Ideal for all automotive A/C systems
- New Car, Florida Breeze and Vanilla scents

Part # 26296 Odor Buster Fogger Florida Breeze 3 oz. (85g)

Part # 27002 Odor Buster Fogger New Car Scent 3 oz. (85g)

Part # 28061 Odor Buster Fogger Vanilla Scent 3 oz. (85g)

Part # 26913 Pre-pack display with 12, 3 oz. cans

Pre-pack contains 4 Florida Breeze,
4 New Car and 4 Vanilla Scent cans

QUICK & EASY
Provides a
Fresher Smelling
Vehicle in
15 Minutes



Quick & Easy!

ODOR ELIMINATOR & AIR PURIFIER

- Quickly eliminates odors caused by tobacco smoke, animals, decay, mold, mildew, fungus and more
- Refreshing scent helps to neutralize odors
- Great for eliminating odors in vehicles, home or office
- Use as needed to quickly eliminate odors

Part # 9503 Odor Eliminator and Air Purifier 10 oz.

EVAPORATOR CLEANER AND DEODORIZER



**NEW IMPROVED
SPRAY HOSE!**

- Foaming cleanser eliminates stale odors fast
- Includes improved spray hose
- Safe for all mobile and stationary A/C evaporators
- Fast acting, long lasting odor control formula
- One can provides multiple treatments

Part # 6984 17 oz. (581g)

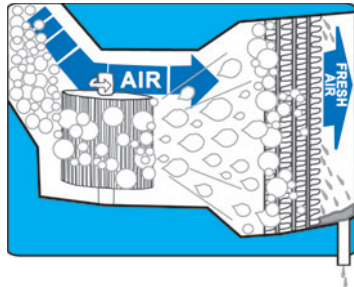

Easy To Use!
Insert hose into A/C drip line or access via evaporator plenum box as illustrated below

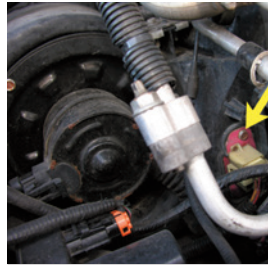

Remove Screw

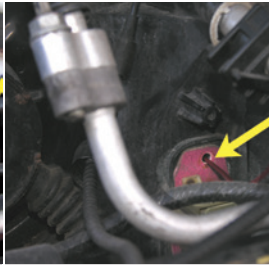

Insert Hose



Spray with A/C on low



Replace Screw

WARRANTY SEAL™

**PREVENT TAMPERING
REDUCE WARRANTY CLAIMS
EFFECTIVE FOR PAN MARKING**



**ROHS
Certified**

**GREAT FOR
QUICK LUBE CENTERS &
TRANSMISSION SHOPS**

- Highly visible mark provides warranty protection against tampering
- Mark will be broken if parts are tampered with or become loose due to vibration
- Effective on drain plugs, nuts, bolts, fasteners and assemblies
- Excellent adhesion to all metal and other surfaces, dries fast
- High temperature resistant

Part# 12848
Part# 64779
Part# 12886
Part# 64892

Yellow Marker 1.8 oz.
Yellow Marker (12-pack)
Red Marker 1.8 oz.
Red Marker (12-pack)

Part# 12855
Part# 64908
Part# 12978
Part# 64915

Blue Marker 1.8 oz.
Blue Marker (12 pack)
White Marker 1.8 oz.
White Marker (12-pack)



CONTROL VALVE TESTER

Nitrogen/Hydrogen Leak Detection

SUPERCOOL - TRUSTED BY PROFESSIONALS

A/C COMPRESSOR CONTROL VALVE TESTER

**OEM
Approved
Tool!**

- Verifies proper valve function
- Help eliminate compressor misdiagnosis
- Adjustable tester output
- Quick diagnosis reduces repair time
- Powers from vehicle battery with heavy duty battery clips and cable
- Reverse battery connection protection
- Long cables for easier access to valve and battery
- 2 Year warranty

SPECIFICATIONS

Battery Cable Length 4 ft.
Valve Cable Length 6 ft.
Power Requirement 12VDC
Removable Connector GX16
Adapter Connectors Dual Function
Tester Output Variable

**TESTS ELECTRONIC CONTROL VALVES
IN VARIABLE DISPLACEMENT
MOBILE A/C COMPRESSORS**

Part# 64714 A/C Compressor Control Valve Tester



**Helps Eliminate
Compressor
Misdiagnosis**

NITROGEN/HYDROGEN TRACER GAS LEAK DETECTOR

- Detects environmentally safe 5% hydrogen in 95% nitrogen tracer gas
- Heated sensor technology
- Ultra sensitive to H2 tracer gas
- Long life sensor with 2 year warranty
- Unique numeric leak size indicator
- Automatic calibration
- Flashing probe LED near sensor
- Audio mute mode
- 3 Sensitivity levels
- CE certified
- Complies with Article 6, Paragraph 3 of EU Directive 2006/40/EC



Part# D640 Nitrogen/Hydrogen Tracer Gas Leak Detector

REFRIGERANT GAS LEAK DETECTORS WITH HEATED SENSOR TECHNOLOGY

DUAL MODE REFRIGERANT GAS LEAK DETECTOR WITH 3 LED U/V LIGHT

- Has two detection modes, a solid electrolyte gas sensor and a patented U/V dye detection system
- 3 LED U/V Light 395-415 nm wavelength for optimum air conditioning dye fluorescence US Patent 7,145,649
- No U/V enhancement eye glasses needed
- Detects all CFC, HFC, HCFC Refrigerants including blends
- Detects R134a and HFO-1234yf leaks as small as 0.05 oz. per year, R22 leaks as small as 0.025 oz. per year
- Unique digital alarm with numeric leak size indicator
- Meets SAE J-2791 and EN 14624 Standards
- Automatic Calibration and reset to ambient levels
- 3 adjustable sensitivity levels
- True mechanical pump
- Low battery indicator
- CE Certified
- Mute feature
- 7 segment digital display (1 to 9)
- Visual LED leak alarm near sensor
- Two year warranty on Detector, including sensor
- Carrying case included
- Made in USA

Part # D440A-UV Dual Mode Refrigerant Leak Detector with 3 LED U/V Light in case

3 LED U/V LIGHT BUILT IN



DETECTS LEAKS AS SMALL AS 0.05 OZ. PER YEAR

Very Effective For Finding Small Leaks!

HEATED SENSOR LEAK DETECTOR

DETECTS LEAKS AS SMALL AS 0.05 OZ. PER YEAR

- Detects all CFC, HFC, HCFC refrigerants and blends
- Meets SAE J-2791 and EN 14624 Standards
- Detects R134a and HFO-1234yf leaks as small as 0.05 oz. per year
- Compact and flexible heated sensor technology
- Sensitivity level adjustable
- Includes digital leak size indicator, audio leak alarm and low battery indicator
- Very effective for finding small leaks

Part # D440A Refrigerant Leak Detector in white box

Part # D440A-C Refrigerant Leak Detector in plastic case

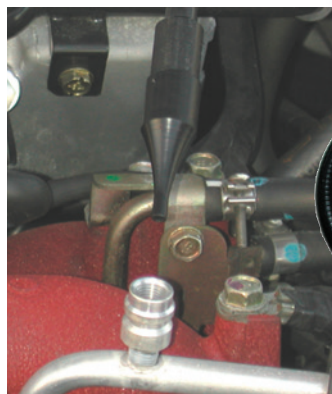

COOLTEST A/C DIAGNOSTIC TOOL

COOLTEST 711 DIGITAL FAULT DETECTOR FOR VEHICLE A/C SYSTEMS

- Saves time in troubleshooting vehicle A/C systems
- Simple to use, does not require extensive training
- Working pressure -30/450 PSI
- Accurate to +/- 1 PSI
- Working temperature 60°C
- Displays both low and high pressure reading
- Maximum pressure 1000 PSI

ACCURATELY DIAGNOSES THE FOLLOWING CONDITIONS:

WITH COMPRESSOR OFF

- Refrigerant leakage
- Lack of refrigerant in system

WITH COMPRESSOR RUNNING

- Low compression or no compression
- Clogged expansion valve
- Electric cooling fan not working
- Refrigerant overcharge
- Condenser panel dirty
- Clogged receiver drier
- Low system pressure

Easy to use!



Part # 27750 Cooltest 711 A/C Diagnostic Tool in sturdy case
1 Year Warranty

VALTEST COMPRESSOR DIAGNOSTIC TOOL

VALTEST 371 A/C COMPRESSOR DIAGNOSTIC TOOL

- Designed to diagnose failing A/C systems with electronically controlled compressors.
- Performs a quick, easy to understand analysis of the compressors operation, the strength of the Electronic Control Unit signal, & the functionality of the valve by determining whether there is a short-circuit or open-circuit and whether the failure is in the ECU or the compressor.
- Makes it possible to effectively diagnose the new generation of electronically controlled A/C compressors.
- A must have tool for the A/C Technician.

A must have tool for the A/C Technician



Part # 28221 Valtest 371 Diagnostic Tool in sturdy case
1 Year Warranty

Part # 37568 Valtest 371 Connector Cable Accessories



BATTERY, CHARGING & STARTING SYSTEM DIAGNOSTIC TESTER

PROVIDES FAST, PRECISE AND RELIABLE MEASUREMENT RESULTS BETWEEN 100 AND 1700 CCA

- Patented conductance technology
- Tests all 12V lead acid batteries including AGM and Gel batteries from 100 to 1700 CCA's
- Displays battery condition as % of available capacity
- GOOD, MARGINAL OR REPLACE status for easy decision making
- Battery state of charge displayed
- Bad cell detected and displayed
- Tests 12V and 24V starter and charging systems including starter draw, alternator and regulator output (loaded/unloaded) and diode ripple.
- Voltage range 5V to 39.9V
- Volts displayed in real time (volt meter)
- Large, easy to view color graphic LCD with messages displayed
- Reverse polarity protection
- Loose connection detection



Part# 64687 Battery, Charging and Starting System Diagnostic Tester

HEAVY DUTY ELECTRONIC BATTERY TESTER

TESTS ALL 12 AND 24 VOLT BATTERIES FROM 100 TO 1700 CCA INCLUDING AGM AND GELL BATTERIES

- Patented circuitry, uses conductance technology
- Tests auto, truck and marine batteries
- Displays battery condition as % of available capacity
- No need to input battery size or rating
- Tests all flooded acid batteries including Gel and AGM
- Bad cells detected and displayed
- Tests 12V, 24V, 36V starting and charging systems
- Heavy duty 4 ft. cables
- Multi-colored bar graph displays battery condition
- Reverse polarity protection
- Low voltage indicator when battery needs charging



Part# 22700 12V/24V Heavy Duty Electronic Battery Tester

MANIFOLD GAUGES

Sets & Hoses

SUPERCOOL - TRUSTED BY PROFESSIONALS

R134a ALUMINUM GAUGE

- R134a Aluminum Gauge Set includes 72" hoses -- red, blue, yellow and service couplers
- Scales in PSI and BAR measurements
- Sight glass for visual inspections
- Auxiliary vacuum line access port

Part # 2211B Aluminum Gauge set with 72" hoses and value priced couplers

Part # 61921 Aluminum Gauge set in case with 72" hoses and **PREMIUM COUPLERS**



Part # 2211B



Part # 61921

R134a BRASS GAUGES

- R134a Brass Gauge Set includes 72" hoses -- red, blue, yellow and service couplers
- Scales in PSI and BAR measurements

Part # 66 Brass Gauge Set with 72" hoses and value priced couplers

Part # 22809 Brass Gauge Set with 72" hoses and **PREMIUM COUPLERS**

Part # 38282 Brass Gauge Set with sight glass, 72" hoses and value priced couplers

Part # 38602 Brass Gauge Set with sight glass, 72" hoses and **PREMIUM COUPLERS**



Part # 66



Part # 38282

HFO-1234yf ALUMINUM GAUGES

- Designed specifically for use with HFO-1234yf refrigerant
- Aluminum Gauge Set includes 72" hoses -- red, blue, yellow and lock-on service couplers
- Scales in PSI and BAR measurements
- Large sight glass for visual inspections
- Auxiliary vacuum line access port
- Lock-on service couplers



Part # 37520-PC R1234yf Aluminum Manifold Gauge Set

Part # 62363 Premium HFO-1234yf Aluminum Manifold Gauge Set



Part # 37520-PC



Part # 62363

10 FOOT RED & BLUE HOSES

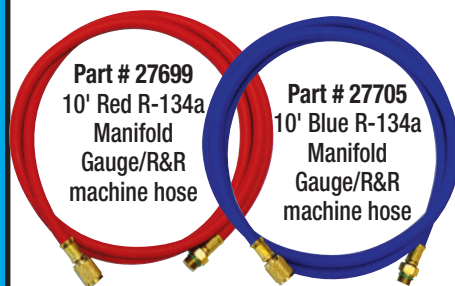

Part # 27699
10' Red R-134a
Manifold
Gauge/R&R
machine hose

Part # 27705
10' Blue R-134a
Manifold
Gauge/R&R
machine hose

Part # 27729 Set 10' Red & 10' Blue R-134a Manifold Gauge/R&R machine Hose

REPLACEMENT R134a 72" HOSE SET

- Includes one each Red, Blue and Yellow Hose

Part # 1767



ANTI-BLOWBACK VALVE FOR R134a HOSES

- Straight hose end valve for containment of refrigerant

R134a HOSE CONNECTOR



- 1/2" ACME male x 14mm x 1.5 female

Part # 13425



HFO-1234yf SERVICE COUPLERS



Part # 26890
HFO-1234yf
Low Side
Coupler
For LS port size 14mm
outside diameter



Part # 26906
HFO-1234yf
High Side
Coupler
For HS port size 17mm
outside diameter



R-134a SERVICE COUPLERS

MADE IN USA

NOW AVAILABLE!

Part # 34412
Manual "Pro-type"
L/S R134a
Snap-On
Quick Coupler



Part # 34413
Manual "Pro-type"
H/S R134a
Snap-On
Quick Coupler

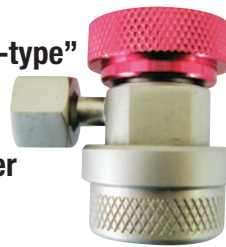

Part # 24946
Extended H/S Coupler

- 14mm x 1.5 High side service port extender for recessed high side R134a service port locations on BMW, Volvo & Mercedes
- Manual Open and Close
- Designed not to vent



Part # 6005
90° H/S
R134a
Quick Coupler

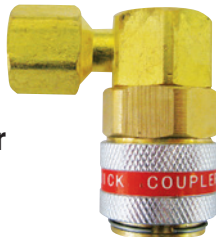

Part # 6009
90° L/S R134a
Conversion
Quick Coupler



Part # 6011
L/S R134a
Conversion
Quick Coupler



Part # 6006
90° L/S
R134a
Quick Coupler



Part # 6010
90° H/S R134a
Conversion
Quick Coupler



Part # 6012
H/S R134a
Conversion
Quick Coupler



Part # 6013
R134a tank to R12
Manifold
Conversion
Coupler

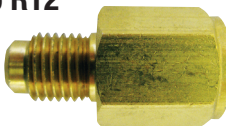

Part # 6018
R134a Coupler to R12
Hose Adapter

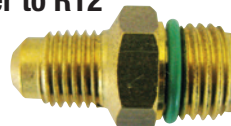

Part # 13425
• 1/2" ACME
male x 14mm
x 1.5 female

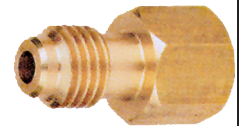

R12 TO R134a MANIFOLD COUPLER CONVERSION KITS

Straight R12 to R134a
Coupler
Conversion Kit

Part # 6014
contains:
1) 6011, 1) 6012, 1) 6013

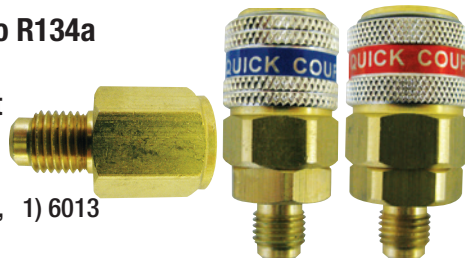

90° R12 to R134a
Coupler
Conversion Kit

Part # 6015
contains:
1) 6009, 1) 6010, 1) 6013



SELF SEALING VALVE CAN TAP & HOSE

SCREW ON CAN TAP HOSE DESIGN FOR SELF SEALING REFRIGERANT CANS

- Screw on can tap hose design
- 9" hose and aluminum quick connect low side coupler
- Use with Speedy Charge, Leak Stop, Oil Charges, Performance Enhancer, and 12 oz. cans of R134a
- Available in clamshell pack or bulk

Part # 51205 R-134a Can Tap & Hose



SELF SEALING VALVE CHARGING HOSE

SCREW ON CAN TAP HOSE DESIGN WITH GAUGE FOR SELF SEALING CANS

- 12" hose and aluminum quick connect low side coupler
- Use with Speedy Charge, Leak Stop, Oil Charges, Performance Enhancer, and 12 oz. cans of R134a
- 90° Low side quick coupler

Part # 51229 R134a Charging Hose & Gauge

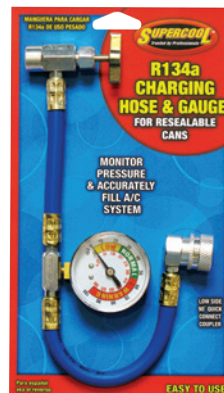

See Page 7 for HF01234yf Can Taps

PIERCING VALVE CAN TAP & HOSE

- Screw on can tap hose design
- Has 9" hose and quick connect low side coupler
- Use with Speedy Charge, Leak Stop, Oil Charges, Performance Enhancer and cans of R134a
- Available in clamshell pack or bulk

Part # 401 R-134a Can Tap & Hose with Brass Couplers



PIERCING VALVE CHARGING HOSE

- Screw on can tap hose design
- 12" hose and aluminum quick connect low side coupler
- Use with Speedy Charge, Leak Stop, Oil Charges, Performance Enhancer, and 12 oz. cans of R134a
- 90° Low side quick coupler

Part # 41275 R134a Charging Hose & Gauge

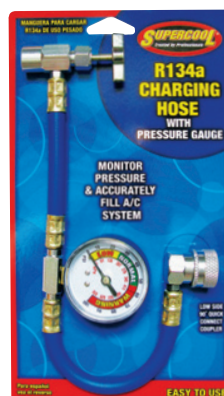

HAND-TURN DYE/OIL INJECTOR FOR R134a & R12



- Does not require a Manifold Gauge to use on low side of pressurized systems
- Use for introducing from 1/4oz. (7.5ml) up to 2oz. (60ml) of U/V Dye, Lubricants & Leak Stop (ST22) to a closed A/C system without adding refrigerant
- Quick connect style for R134a systems (also for use on R12 systems)

Part # 15290 R-134a / R-12 Hand Turn Injector

DYE/OIL INJECTOR FOR R134a & R12



- For use with manifold gauge sets • 2 oz. capacity
- Great for introducing U/V Dye, Lubricants and Leak Stop (ST22) to a closed A/C system
- Use in-line on pressurized systems • Quick connect style

Part # 2375 R134a / R12 Dye/Oil Injector

Part # 13548-10 Hand-Turn Dye/oil injector Replacement Seal for screw-top

3-IN-1 "SWINGING GATE" SIDE CAN TAP

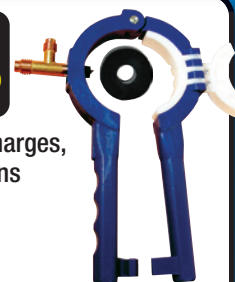

- Use for R134a, Leak Stop, Oil Charges, R12 & alternative refrigerant cans
- No more lost can sizers -- they are attached to can tap
- Pierces & locks can in one step

Part # 15320 3-in-1 Side Can Tap

Part # 110-10 Replacement Can Tap Gasket

SCREW ON R134a CAN TAPS

- Great for using small cans with manifold gauge set!
- Use with Speedy Charge, Leak Stop, Oil Charges, Performance Enhancer and cans of R134a
- All metal construction for durability and long life

Part # 402 Piercing Valve R134a Can Tap

CAN TAP FOR SELF-SEALING CANS
Part # 53834 R134a can tap for self-sealing cans



DIGITAL LASER SIGHTED THERMOMETERS

NON-CONTACT TEMPERATURE MEASUREMENT

- Easy to operate - just point, shoot and read temperature
- Temperature range: -36.4°F to 689°F -38°C to 365°C
- Selectable °F OR °C
- Laser sight technology
- Bright backlit LED display
- Fast response time
- 2 AA Batteries included
- Ergonomic pistol grip
- Auto power off



Part # 38534

- Pocket-sized!
- Easy to operate -- just point, shoot & read temperature
- Temperature range: -22°F to 518°F (-50°C to 550°C)
- Auto data hold and auto power off
- 6:1 Distance to spot ratio
- Backlit LCD display
- Low battery indication
- Professional grade and construction
- Includes 2 "AAA" batteries



Part # 13517

ANALOG POCKET THERMOMETER

- 1" Dial Size
- 0 to 220°F scale
- Includes holder and clip



Part # 4420

FAHRENHEIT/ CELSIUS DUAL SCALE THERMOMETER

- 1-3/4" Dial Size
- Dual Scale 0 to 225°F / -5 to 110°C
- Includes holder and clip



Part # 9428

180° SWIVEL HEAD DIGITAL THERMOMETER

- Simply insert into vent while system is running for an instant temperature reading
- -4 to 248°F -20 to 120°C
- Stainless steel temperature probe
- Includes protective cover & clip
- Auto shut off



Part # 17805



SINGLE STAGE VACUUM PUMPS

- The higher the CFM the quicker the vacuum
- The lower the microns, the deeper the vacuum
- The deeper the vacuum, the dryer the system

2.5 CFM, 150 MICRON, SINGLE STAGE

- 1/2" ACME and 1/4" SAE suction ports
 - 115V/60Hz, 1/4 HP
- Part # 18406

3.5 CFM, 150 MICRON, SINGLE STAGE

- 1/2" ACME and 1/4" SAE suction ports
 - 115V/60Hz, 1/4 HP
- Part # 18413

5.5 CFM, 150 MICRON, SINGLE STAGE

- 1/2" ACME and 1/4" SAE suction ports
 - 110V/60Hz, 1/4 HP
- Part # 18420

REFRIGERANT HANDLING GLOVES

- Yellow PVC coated jersey lining
- Provides hand protection while working with refrigerants

Part # 22854



VACUUM PUMP TEE

Part # T101

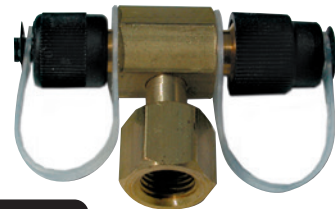

1234yf VACUUM PUMP ADAPTER

1/2" ACME
Part # 48007





DUAL STAGE VACUUM PUMPS

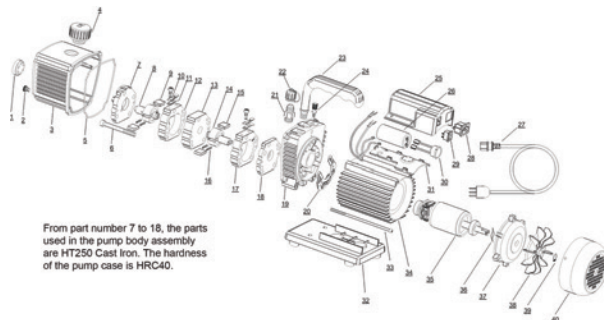

From part number 7 to 18, the parts used in the pump body assembly are HT250 Cast Iron. The hardness of the pump case is HRC40.

"Supercool Quality" vacuum pumps are made with a body material of HT250 Cast Iron and a case hardness of HRC40. What this means is that after 2 years of use you can still expect the same level of vacuum strength from a Supercool vacuum pump as the day you bought it.

1.80 CFM, 25 MICRON, DUAL STAGE

- 1/4 Hp dual stage pump dries A/C systems fast
- 115V/60Hz
- 1/2" ACME and 1/4" SAE suction ports

Part # 13661

2.75 CFM, 25 MICRON, DUAL STAGE

- 3/10 Hp dual stage pump dries A/C systems fast
- 110V/60Hz
- 1/2" ACME and 1/4" SAE suction ports

Part # 13654

5.50 CFM, 25 MICRON, DUAL STAGE

- 1/2 Hp dual stage pump dries A/C systems fast
- 110V/60Hz
- 1/2" ACME and 1/4" SAE suction ports

Part # 13647

DIGITAL VACUUM GAUGE



- Combined thermocouple sensor technology with advanced electronics for precise readings
- Precision instrumentation to sense deep vacuum range
- Measurement Range: 0-30psi
- Accuracy: 1%, 0.01kPa least resolution
- Ambient Temp.: -20 °C ~ 80 °C
- Ambient Moisture: 5%-95%
- Permanent Stability: 1%

Part # 44313 Digital Vacuum Gauge

Atmospheric Pressure measures around 759,968 microns.
 The closer one gets to 0 microns the deeper the vacuum one can achieve. A 15 micron vacuum pump is more efficient at removing moisture from an A/C system than a 100 micron vacuum pump is. The quicker the pressure in the A/C system can be dropped under vacuum, the quicker water can change its state from liquid to vapor. It is this water vapor which the vacuum pump removes to dehydrate an A/C system before a technician will recharge the system with refrigerant.

- The higher the CFM the quicker the vacuum
- The lower the microns, the deeper the vacuum
- The deeper the vacuum, the dryer the system

VACUUM PUMP OIL



UNIVERSAL STANDARD VACUUM PUMP OIL

- Non-misting formulation
- Compatible with most vacuum pump brands
- Contains conditioners, inhibitors & anti wear agents for lubricity & wear protection

Part # 48441 8-oz.

Part # 37476 Quart

Part # 43286 Gallon

68 VISCOSITY SYNTHETIC VACUUM PUMP OIL

- Synthetic Oil Improves performance and extends life of vacuum pumps
- Non-misting formulation
- Provides Low Volatility & high resistance to oxidation
- Compatible with most vacuum pump brands

Part # V32 Quart

Part # V128 Gallon

46 VISCOSITY SYNTHETIC VACUUM PUMP OIL

- Universal synthetic formula, compatible with most vacuum pump brands
- Non-misting formulation
- Contains conditioners, inhibitors & anti wear agents for lubricity & wear protection

Part # 33713 Quart

Part # 43279 Gallon



VACUUM PUMP & GAUGE KIT



KIT CONTAINS:

3.5 CFM, 150 MICRON, SINGLE STAGE VACUUM PUMP

- 1/2" ACME and 1/4" SAE suction ports
- 115V/60Hz, 1/4 HP

R134a ALUMINUM MANIFOLD GAUGE WITH HOSES

- R134a Aluminum Gauge Set includes 72" hoses -- red, blue, yellow and service couplers
- Scales in PSI and BAR measurements
- Sight glass for visual inspections
- Auxillary vacuum line access port

90° H/S R134a Quick Coupler

90° L/S R134a Quick Coupler

BONUS FREE BOTTLE TOTAL LEAK STOP + UV DYE

FOR METAL & RUBBER COMPONENTS

- Stops small leaks in evaporators, condensers, hoses, gaskets & seals
- Does not contain polymers. Will not harm or clog A/C system components or equipment.
- 1 two ounce bottle treats 1 vehicle
- ST22 installs easily using an oil injector



Part # 44986

Vacuum Pump & Manifold Gauge Kit

Supercool Gold Vacuum Pump Oil is hydro processed resulting in an extremely pure, highly refined, non-detergent oil. Blended from high-grade lubricants, Supercool Gold performs at the deepest vacuum with its high viscosity index & stability assuring adequate lubrication at high and low pressures.



21cSt VISCOSITY GOLD VACUUM PUMP OIL

- 21 cSt Mineral oil based vacuum pump oil helps extend the life of vacuum pumps.
- Advanced high performance formula provides low volatility and high resistance to oxidation.
- Non-misting formulation.
- Compatible with most vacuum pump brands.
- Contains conditioners, inhibitors and anti-wear agents for excellent lubricity and pump protection.
- Helps reduce vacuum pump wear.

Part # 50125 Quart



AUTOMOTIVE COOLING SYSTEM TOOLS

RADIATOR / COOLING SYSTEM PRESSURE TESTER

Part # 7363

COMPRESSOR TURNER TOOL

- Spreads lubricant to prevent compressor damage at start-up
- Helps free new compressors seized by sticky protective coatings
- Threads into clutch hub & fits most hex-less clutch hubs (Harrison R, H, or V series)
- Allows technician to rotate compressor by hand or can be turned with a 19mm wrench
- Usable in tight spaces

Part # 67700



A/C CLUTCH HUB TOOL KIT

Part # 91269



Compressor Make	Remover	Installer
Delphi / Harrison A6 / R4 SAE DA6 / V5, HR6 / R4	3800A 3800B	3800A 3800B
Chrysler C171, Ford FS6, Hitachi MJ, Tecumseh HR980, Nippondenso 6P/10P	3800C	3800C
Zexel (Diesel Kiki) Sanden SD5 & 7	3800D 3800E	

BLOCK TESTER

- Find internal combustion leaks quickly and easily
- Sturdy blow-molded plastic carry case
- For use on gasoline engines only, not recommended for diesel
- Instructions included

Part # 27675
Block Tester



A/C CLUTCH REPAIR TOOLS



Clutch Plate Remover Services: Harrison/GM A-6 & R4, New Style Nippondenso, Ford, Chrysler

Part # 3700A



Clutch Plate Installer Services: Harrison/GM DA-6, HR-6, V5, A-6, R4; New Style Nippondenso, Ford, Chrysler, A590, C171, FS-6 and York / Tecumseh HR980

Part # 3700D

HEAVY DUTY ELECTRONIC BATTERY TESTER



**EASY TO USE...
INSTANT RESULTS**

**TESTS ALL 12 AND
24 VOLT BATTERIES
FROM 100 TO 1700 CCA
INCLUDING AGM
AND GELL BATTERIES**

- Patented circuitry, uses conductance technology
- Tests auto, truck and marine batteries
- Displays battery condition as % of available capacity
- No need to input battery size or rating
- Tests all flooded acid batteries including Gel and AGM
- Bad cells detected and displayed
- Tests 12V, 24V, 36V starting and charging systems
- Heavy duty 4 ft. cables
- Multi-colored bar graph displays battery condition
- Reverse polarity protection
- Low voltage indicator when battery needs charging

Part# 22700 12V/24V Heavy Duty Electronic Battery Tester

INSULATING TAPES

PRESTITE TACKY TAR-CORK TAPE

- Wrap around the expansion valve to protect it from heat in the engine compartment

Part # 9404 2"W X 30'L

FOAM INSULATION TAPE

- Helps prevent pipe "sweating" and condensation drip

Part # 13104 30 Feet per roll -- 1/8" x 2"



GRADUATED MEASURING CUP

- Plastic measuring cup with 8 ounce scale
- Measure the exact amount of oil for the system being serviced

Part # M782 Measuring cup

Part # DD Dye Dropper (1 ml. scale)
Packed 10 per bag

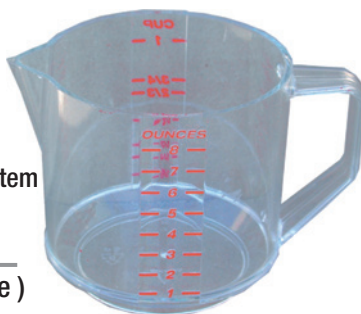

CONDENSER FIN COMB AND STRAIGHTENER

- Cleans and straightens radiator, condenser, and evaporator fins -- six sided head for 6, 8, 10, 12, 14 and 15 fin per inch applications

Part # 9925

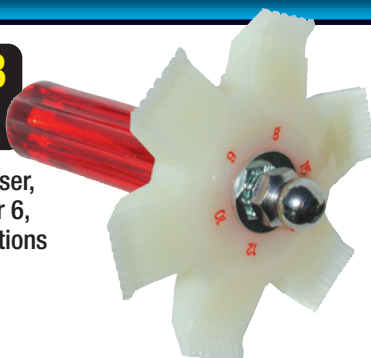

NU TOOL AIR TOOL LIFE EXTENDER

- Keeps air tools operating at maximum efficiency
- Cleans and lubricates air tools
- Protects air tools from rust, corrosion, and extends air tool life
- Frees up clogged parts by removing gums and gels
- Returns old air tools to "like-new" condition

Part # NT-4 4 oz. bottle



AIR CONDITIONING HOSE REPAIR

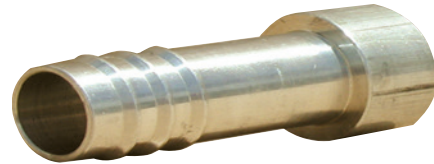

STEEL FERRULES FOR A/C HOSE REPAIR

- Available in sizes #: 6, 8, 10 & 12.
- Standard size, tempered, zinc plated.
- Compatible with most A/C hose crimpers & standard barrier hose.
- Packed five pieces per bag.

Part # F6-5	#6 size
Part # F10-5	#10 size
Part # F8-5	#8 size
Part # F12-5	#12 size

BARBS FOR A/C HOSE REPAIR

- **Aluminum** Sizes: # 6, 8, 10, 12.
- Packed five pieces per bag.

Part # AB6-5	3/8" #6 size Aluminum Barb Outer
Part # AB8-5	1/2" #8 size Aluminum Barb Outer
Part # AB10-5	5/8" #10 size Aluminum Barb Outer
Part # AB12-5	3/4" #12 size Aluminum Barb Outer

- **Steel** Sizes: # 6, 8, 10, 12.
- Packed five pieces per bag.

Part # SB6-5	3/8" #6 size Steel Barb Outer
Part # SB8-5	1/2" #8 size Steel Barb Outer
Part # SB10-5	5/8" #10 size Steel Barb Outer
Part # SB12-5	3/4" #12 size Steel Barb Outer

90° BEADLOCK FEMALE FLARE



Part # 42-206	3/8" 90° Assembly #6 size (Beadlock)
Part # 42-208	1/2" 90° Assembly #8 size (Beadlock)
Part # 42-210	5/8" 90° Assembly #10 size (Beadlock)
Part # 42-212	3/4" 90° Assembly #12 size (Beadlock)

STRAIGHT BEADLOCK FEMALE FLARE



Part # 42-106	3/8" Straight Assembly #6 size (Beadlock)
Part # 42-108	1/2" Straight Assembly #8 size (Beadlock)
Part # 42-110	5/8" Straight Assembly #10 size (Beadlock)
Part # 42-112	3/4" Straight Assembly #12 size (Beadlock)

AIR CONDITIONING HOSE CLAMPS

Part # 11012	#10 to #12 Size, Inside Diameter 1/2 - 5/8"
Part # 11068	#6 to #8 Size, Inside Diameter 5/16 - 13/32"



HEAVY DUTY HOSE CUTTER

- Cuts hose 1/2" to 1-5/8" in diameter
Part # 21758 (old Part # VF32)



Note: Not for use with barrier hose.

A/C HOSE REPAIR ASSORTMENT

Part # ACHR

Includes:

- | | |
|-----------|-----------------------------------|
| 4) AB6-5 | 3/8" Aluminum Barb Outer #6 size |
| 4) AB8-5 | 3/8" Aluminum Barb Outer #8 size |
| 4) AB10-5 | 3/8" Aluminum Barb Outer #10 size |
| 4) AB12-5 | 3/8" Aluminum Barb Outer #12 size |

- | | |
|-----------|--------------------------------|
| 4) SB6-5 | 3/8" Steel Barb Outer #6 size |
| 4) SB8-5 | 1/2" Steel Barb Outer #8 size |
| 4) SB10-5 | 5/8" Steel Barb Outer #10 size |
| 4) SB12-5 | 3/4" Steel Barb Outer #12 size |

- | | | | |
|----------|-----------------|-----------|------------------|
| 10) F6-5 | #6 size Ferrule | 10) F10-5 | #10 size Ferrule |
| 10) F8-5 | #8 size Ferrule | 10) F12-5 | #12 size Ferrule |



A/C 90° & STRAIGHT FERRULE, BARB & NUT ASSEMBLY ASSORTMENT

Part # 9900 Includes:

- | | |
|-----------|--|
| 3) 42-206 | 3/8" 90° Assembly #6 size (Beadlock) |
| 3) 42-208 | 1/2" 90° Assembly #8 size (Beadlock) |
| 3) 42-210 | 5/8" 90° Assembly #10 size (Beadlock) |
| 3) 42-212 | 3/4" 90° Assembly #12 size (Beadlock) |
| 3) 42-106 | 3/8" Straight Assembly #6 size (Beadlock) |
| 3) 42-108 | 1/2" Straight Assembly #8 size (Beadlock) |
| 3) 42-110 | 5/8" Straight Assembly #10 size (Beadlock) |
| 3) 42-112 | 3/4" Straight Assembly #12 size (Beadlock) |



GOODYEAR A/C BARRIER HOSE

- Nylon co-polymer barrier in a synthetic rubber inner tube.
- Extremely flexible hose with increased strength.
- Can be coupled using standard fittings for SAE J2064-A2 and SAE J51-A2 applications.
- Exceeds all criteria of SAE J51 and other OEM requirements.
- Compatible with R12, R134a and Ternary Blends as well as the new second generation of refrigerants now on the market.

Part # GYBH6 #6 size

Part # GYBH8 #8 size

Part # GYBH10 #10 size

Part # GYBH12 #12 size

**Available in:
25 Ft., 50 Ft. and Reels**



COMPRESSOR CLUTCH CYCLING SWITCHES



Part # 20959
Cycling Pressure Switch
Connector Terminal Type: Spade
Sensor Type: Switch, Clutch Cycling



Part # 20966
Cycling Pressure Switch
Connector/Terminal Type: Pin
Automotive Switch Use: Clutch Cycling
Weatherproof Sealed
DODGE 1994-1999
JEEP 1997-1998



Part # 20973
Cycling Pressure Switch
Connector/Terminal Type: Spade
Automotive Switch Use: Compressor
Weatherproof Sealed
FORD 1980-1993
LINCOLN 1980-1993
MAZDA 1991-1994
MERCURY 1980-1993
MERKUR 1985-1987
NISSAN/DATSUN 1993-1993



Part # 20980
Cycling Pressure Switch
Connector/Terminal Type: Pin
Automotive Switch Use: Clutch Cycling
Weatherproof Sealed
FORD 1995-2008
LINCOLN 1995-2002
MAZDA 1997-1999
MERCURY 1995-2007
NISSAN/DATSUN 1998-1999



Part # 20997
Cycling Pressure Switch
Connector/Terminal Type: Pin
Automotive Switch Use: Clutch Cycling
Weatherproof Sealed
FORD 1996-2010
LINCOLN 1997-2008
MERCURY 1996-2007



Part # 21000
Cycling Pressure Switch
Terminal Type: Spade
Automotive Switch Use: Compressor
Weatherproof Sealed
ALFA ROMEO 1988-1993
AUDI 1980-1995
BUICK 1977-1993
CADILLAC 1980-1993
CHEVROLET 1976-1993
GMC 1973-1993
OLDSMOBILE 1977-1993
PONTIAC 1976-1993
VOLVO 1983-1993



Part # 21017
Cycling Pressure Switch
Connector/Terminal Type: Pin
Automotive Switch Use: Clutch Cycling
Weatherproof Sealed
BUICK 1990-1993
CHEVROLET 1989-1993
GMC 1989-1993
OLDSMOBILE 1992-1993
PONTIAC 1992-1993



Part # 21024
Cycling Pressure Switch
Connector/Terminal Type: Pin
Automotive Switch Use: Clutch Cycling
Switch Weatherproof Sealed: Yes
BUICK 1994-1996
OLDSMOBILE 1993-1995
PONTIAC 1994-1995



Part # 21048
Cycling Pressure Switch
Connector/Terminal Type: Pin
Automotive Switch Use: Clutch Cycling
Weatherproof Sealed
PONTIAC 1990-1995

COMPRESSOR CLUTCH CYCLING SWITCHES



Part # 26148
High Cut-Out Pressure Switch
 Activation Pressure: 255
 Automotive Electrical Terminal Type: Spade
CADILLAC 1999-2002
CHEVROLET 1994-2002
GMC 1994-2002



Part # 26388
Harness Connector
 Pigtail - GM Low Pressure Switch Connector
 Terminal Gender: Female
 Automotive Electrical Terminal Type: Pin
 Pigtail Wire Gauges: 16
 Number Of Wires: 2
BUICK 1985-1993
CADILLAC 1987-1988
CHEVROLET 1986-1995
OLDSMOBILE 1985-1995
PONTIAC 1986-1995



Part # 26395
Harness Connector
 Pigtail - 2 Blade Low Pressure Cut-Out Switches
 Terminal Gender: Female
 Automotive Electrical Terminal Type: Spade
 Pigtail Wire Gauges: 16
 Number Of Wires: 2
AUDI 1978-1995
BUICK 1976-1996
CADILLAC 1977-1996
CHEVROLET 1973-1999
CHRYSLER 1970-1995
DODGE 1969-2002
GMC 1973-1999
HONDA 1973-1987
JEEP 1982-1995
LEXUS 1990-1991
MERCEDES - BENZ 1969-1995
OLDSMOBILE 1976-2001
PLYMOUTH 1965-2000
PONTIAC 1975-1993
TOYOTA 1969-1993
VOLVO 1983-1993



Part # 26401
Cycling Pressure Switch
 Activation Pressure: 28
 Deactivation Pressure: 451
 Automotive Electrical Terminal Type: Spade
LEXUS 1994-1999
MITSUBISHI 1999-2003
TOYOTA 1993-2009



Part # 26432
Binary Pressure Switch
 Activation Pressure: 28
 Deactivation Pressure: 423
 Automotive Electrical Terminal Type: Spade
ACURA 1996-1997
HONDA 1994-1997
ISUZU 1993-1997



Part # 26418
Trinary Pressure Switch
 Activation Pressure: 29
 Deactivation Pressure: 455
 Automotive Electrical Terminal Type: Spade
ACURA 2001-2008



Part # 26425
Binary Pressure Switch
 Activation Pressure: 28
 Deactivation Pressure: 454
 Automotive Electrical Terminal Type: Spade
ACURA 1991-2006
HONDA 1993-2002



Part # 26449
Trinary Pressure Switch
 Activation Pressure: 29
 Deactivation Pressure: 384
 Automotive Electrical Terminal Type: Spade
TOYOTA 1990-2003



Part # 26456
Binary Pressure Switch
 Activation Pressure: 28
 Deactivation Pressure: 451
 Automotive Electrical Terminal Type: Spade
ACURA 1992-1994
HONDA 1990-1993
ISUZU 1999-2003

COMPRESSOR CLUTCH CYCLING SWITCHES



Part # 26463
Compressor Mounted High Cut-Out Pressure Switch
 Compressor Mounted Switch - GM/Harrison - High Pressure Cut-Off (Blue - Replaces Red, Tan & Dark Orange)
 Switching Pressure: 430
BUICK 1985-2003
CADILLAC 1986-2003
CHEVROLET 1985-2004
GMC 1985-2003
OLDSMOBILE 1985-2003
PONTIAC 1985-2004



Part # 26494
Low Cut-Out Pressure Switch
 Compressor Mounted Switch - GM/Harrison - High Side Low Pressure Cut-Off (Brown - Replaces Green & Blue)
 Switching Pressure: 35
BUICK 1985-2003
CADILLAC 1986-2003
CHEVROLET 1985-2004
GMC 1985-2003
OLDSMOBILE 1985-2003
PONTIAC 1985-2004



Part # 26470
Binary Pressure Switch
 Activation Pressure: 450
 Deactivation Pressure: 250
 Automotive Electrical Terminal Type: Spade
FORD 1994-2002
LINCOLN 1994-2000
MERCURY 1994-2000



Part # 26500
Trinary Pressure Switch
 Activation Pressure: 17
 Deactivation Pressure: 455
 Automotive Electrical Terminal Type: Spade
AUDI 1999-2000
VOLKSWAGEN 1990-2003



Part # 26524
High Cut-Out Pressure Switch
 Activation Pressure: 435
 Attached Lead Wires: No
 Deactivation Pressure: 290
 Automotive Electrical Terminal Type: Pin
FORD 1993-2008
LINCOLN 1994-2006
MAZDA 1997-2006
MERCURY 1994-2006



Part # 26487
Cooling Fan Pressure Switch
 Compressor Mounted Switch - GM/Harrison - Condenser Fan Pressure (Purple - Replaces Red)
 Switching Pressure: 210
BUICK 1985-2003
CADILLAC 1986-2003
CHEVROLET 1986-2004
GMC 1994-1994
OLDSMOBILE 1985-2003
PONTIAC 1985-2004



Part # 26517
Trinary Pressure Switch
 Activation Pressure: 24
 Deactivation Pressure: 413
 Automotive Electrical Terminal Type: Spade
INFINITI 1997-2002
NISSAN/DATSUN 1997-2004



Part # 26531
Cooling Fan Pressure Switch
 Package Contents: Compressor Mounted Switch - GM/Harrison - Cooling Fan (Grey)
 Switching Pressure: 240
BUICK 1986-2003
CADILLAC 1986-2003
CHEVROLET 1986-2004
GMC 1994-1994
OLDSMOBILE 1985-2004
PONTIAC 1982-2005

COMPRESSOR CLUTCH CYCLING SWITCHES



Part # 26548
Low Cut-Out Pressure Switch
 Package Contents: Compressor Mounted Switch - GM/Harrison - High Side Low Pressure Cut-Off (Black - Replaces Yellow)
 Switching Pressure: 45
BUICK 1986-2003
CADILLAC 1986-2003
CHEVROLET 1985-2005
GMC 1985-2005
OLDSMOBILE 1985-2004
PONTIAC 1982-2005



Part # 26579
Cycling Pressure Switch
 Connector/Terminal Type: Pin
 Automotive Switch Use: Clutch Cycling
 Weatherproof Sealed
BUICK 2004-2007
CADILLAC 1999-2007
CHEVROLET 1996-2010
GMC 1994-2009
OLDSMOBILE 2002-2004



Part # 26609
Low Cut-Out Pressure Switch
 Activation Pressure: 25
 Deactivation Pressure: 9
 Automotive Electrical Terminal Type: Spade
DODGE 1998-2003



Part # 26555
Trinary Pressure Switch
 Activation Pressure: 18
 Deactivation Pressure: 455
 Automotive Electrical Terminal Type: Spade
VOLKSWAGEN 1992-2003



Part # 26586
High Cut-Out Pressure Switch
 Activation Pressure: 430
 Deactivation Pressure: 200
 Automotive Electrical Terminal Type: Spade
AUDI 1994-1998
CADILLAC 1994-2002



Part # 26616
Pressure Transducer
 Connector/Terminal Type: Spade
 Sensor Type: Pressure Transducer
DODGE 2001-2007
JEEP 2002-2004

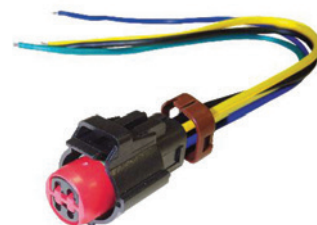

Part # 26562
Harness Connector
 Pigtail - Ford Switches
 Terminal Gender: Female
 Automotive Electrical Terminal Type: Pin
 Pigtail Wire Gauges: 16
 Number Of Wires: 4
FORD 1993-2008
LINCOLN 1994-2006
MAZDA 1997-2006
MERCURY 1994-2006



Part # 26593
Cycling Pressure Switch
 Connector/Terminal Type: Pin
 Automotive Switch Use: Clutch Cycling
 Weatherproof Sealed
DODGE 1998-2002



Part # 26623
Pressure Transducer
 Connector/Terminal Type: Spade
 Sensor Type: Pressure Transducer
DODGE 2001-2007

COMPRESSOR CLUTCH CYCLING SWITCHES



Part # 26630
 High Cut-Out Pressure Switch
 Activation Pressure: 485
 Deactivation Pressure: 270
 Automotive Electrical Terminal Type: Pin
 FORD 1998-2008 MAZDA 1998-2006
 MERCURY 1998-2006



Part # 26647
 High Cut-Out Pressure Switch
 Activation Pressure: 435
 Deactivation Pressure: 290
 Automotive Electrical Terminal Type: Pin



Part # 26654
 High Cut-Out Pressure Switch
 Activation Pressure: 485
 Deactivation Pressure: 335
 Automotive Electrical Terminal Type: Pin
 FORD 1997-2006 LINCOLN 1998-2005



Part # 26661
 Binary Pressure Switch
 Activation Pressure: 460
 Deactivation Pressure: 235
 Automotive Electrical Terminal Type: Spade
 FORD 1999-2008 LINCOLN 2001-2002
 MAZDA 2001-2006 MERCURY 2000-2007



Part # 26678
 Binary Pressure Switch
 Activation Pressure: 450
 Deactivation Pressure: 265
 Automotive Electrical Terminal Type: Spade
 FORD 2000-2008
 MERCURY 1999-2008



Part # 26685
 Pressure Transducer
 Connector/Terminal Type: Spade
 Sensor Type: Pressure Transducer
 FORD 1999-2011 LINCOLN 1998-2011
 MAZDA 2003-2006 MERCURY 1992-2011



Part # 26692
 Pressure Transducer
 Connector/Terminal Type: Spade
 Sensor Type: Pressure Transducer
 AUDI 2000-2011
 VOLKSWAGEN 1992-2010



Part # 26708
 Pressure Transducer
 Connector/Terminal Type: Spade
 Sensor Type: Pressure Transducer
 MW 1995-2010
 MINI 2002-2010



Part # 26715
 Harness Connector
 Pigtail - Toyota Oval 4 Pin
 Denso Trinary Switches
 Terminal Gender: Female
 Automotive Electrical Terminal Type: Pin
 Pigtail Wire Gauges: 16 Number Of Wires: 4
 ACURA 1988-2008 HONDA 1999-2002
 ISUZU 1991-2003 LEXUS 1990-2003
 MAZDA 1994-2009 MITSUBISHI 1991-1998
 TOYOTA 1987-2009



Part # 26722
 Pressure Transducer
 Connector/Terminal Type: Spade
 Sensor Type: Pressure Transducer
 BUICK 2003-2010 CADILLAC 2003-2010
 CHEVROLET 1996-2010 FORD 2006-2011
 GMC 2003-2009 LINCOLN 2006-2008
 OLDSMOBILE 2002-2004 PONTIAC 2002-2009



Part # 26739
 Low Cut-Out Pressure Switch
 Connector/Terminal Type: Pin
 Automotive Switch Use: Clutch Cycling
 Weatherproof Sealed
 FORD 2002-2008 MERCURY 2002-2005

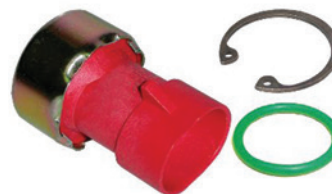

Part # 26746
 Compressor Mounted High
 Cut-Out Pressure Switch
 GM Denso 10S - High Pressure Cut-Off
 (Red - Replaces Purple and Orange)
 Switching Pressure: 470
 CADILLAC 2002-2007 CHEVROLET 1999-2009
 GMC 1999-2009

COMPRESSOR CLUTCH CYCLING SWITCHES



Part # 26753
 Pressure Transducer
 Connector/Terminal Type: Spade
 Sensor Type: Pressure Transducer
 BUICK 1991-2005 CADILLAC 1994-2002
 CHEVROLET 1993-2009 GMC 1996-2009
 OLDSMOBILE 1994-2004 PONTIAC 1993-2007



Part # 26760
 High Cut-Out Pressure Switch
 Compressor Mounted Switch -
 Chrysler/Denso 10S - High
 Pressure Cut-Off (Green)
 Switching Pressure: 460
 CHRYSLER 1994-2010 DODGE 1994-2007
 PLYMOUTH 1994-2001



Part # 26777
 Compressor Mounted Low
 Cut-Out Pressure Switch
 Connector/Terminal Type: Spade
 Automotive Switch Use: Compressor
 Weatherproof Sealed
 FORD 2006-2008 LINCOLN 2006-2007
 MERCURY 2006-2008



Part # 26784
 Pressure Transducer
 Connector/Terminal Type: Spade
 Sensor Type: Transducer
 ACURA 2005-2011
 HONDA 2006-2009



Part # 26814
 High Cut-Out Pressure Switch
 Activation Pressure: 425
 Attached Lead Wires: No
 Deactivation Pressure: 275
 Automotive Electrical Terminal Type: Spade
 DODGE 1998-2002 JEEP 1997-2004



Part # 26838
 Pressure Transducer
 Connector/Terminal Type: Spade
 Sensor Type: Pressure Transducer
 NISSAN/DATSUN 2000-2009



Part # 26845
 Cycling Pressure Switch
 Connector/Terminal Type: Pin
 Automotive Switch Use: Clutch Cycling
 Weatherproof Sealed
 FORD 2002-2008



Part # 26852
 High Low Cut-Out Pressure Switch
 Activation Pressure: 320
 Deactivation Pressure: 400
 Automotive Electrical Terminal Type: Spade
 NISSAN/DATSUN 1995-2008



Part # 120321
 Cycling Pressure Switch
 Connector/Terminal Type: Spade
 Automotive Switch Use: Compressor
 Weatherproof Sealed
 BUICK 1994-1996
 CADILLAC 1994-1996
 CHEVROLET 1993-1999
 GMC 1993-1999



Part # 120322
 Cycling Pressure Switch
 Connector/Terminal Type: Spade
 Automotive Switch Use: Clutch Cycling
 Weatherproof Sealed

FORD 1993-1999
 JEEP 1993-1998
 LINCOLN 1993-1998
 MAZDA 1994-1996
 MERCURY 1993-1998
 NISSAN/DATSUN 1993-1997

AIR CONDITIONING ORGANIZERS

A2016 A/C MAINTENANCE ASSORTMENT

- Refillable A/C parts system loaded with 150+ SKUs of over 800 service parts
- US, Asian and European vehicle coverage
- O-Rings, valves, service caps, seals, washers orifice tubes, gaskets and more
- FULL O-ring coverage!
- Heavy-duty portable cabinet comes with handle & snap-lock cover
- Custom designed & labeled assortments are available to fill your specific needs

Part # A2016
 Designed for Vehicle
 Coverage 2019-2000

REFILL POSTER
 available showing
 complete line of refills.



REFILL BOXES FOR A/C ORGANIZER A2016

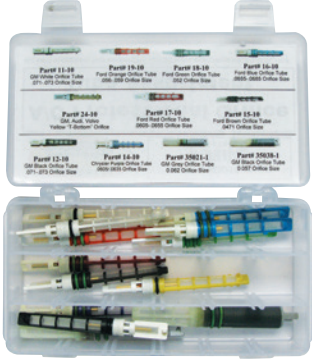

BOX 1

Part # A2016-Box 1
Professional Orifice
Tube Assortment



BOX 2

Part # A2016-Box 2
Professional O-Ring &
Spring Assortment



BOX 3

Part # A2016-Box 3
Professional Cap &
Fittings Assortment



BOX 4

Part # A2016-Box 4
Professional Valve
Core Assortment



BOX 5

Part # A2016-Box 5
Professional O-Ring
Assortment

BOX 6

Part # A2016-Box 6
Professional O-Ring
Assortment

BOX 7

Part # A2016-Box 7
Professional O-Ring
Assortment

BOX 8

Part # A2016-Box 8
Professional Gasket
& Washer Assortment

AIR CONDITIONING ORGANIZERS

A2005 A/C MAINTENANCE ASSORTMENT



- Refillable A/C parts system loaded with 100+ SKUs of over 700 service parts
- Domestic, Asian and European vehicle coverage
- R134a service caps, valves, primary seals, slim line & sealing washers, '07-'00 Chrysler gaskets
- FULL O-ring coverage!
- Heavy-duty portable cabinet comes with handle & snap-lock cover
- Custom designed & labeled assortments are available to fill your specific needs



REFILL POSTER
available showing
complete line of refills.

Part # A2005
Designed for Vehicle
Coverage 2019-2000

REFILL ASSORTMENT POSTER

- Colorful 24 inch x 36 inch poster showing our complete line of refills available for our various A/C maintenance assortments.
- Complete refill coverage for the following kits:

A2016	
A2205	13722
A2005 HD	1729
A1900	1712
OR 350	1729



Part # 27644

AIR CONDITIONING ORGANIZERS



A2005HD A/C MAINTENANCE ASSORTMENT

- Refillable A/C parts system loaded with 100+ SKUs of over 700 service parts
- R134a primary seals, retrofit ports, valves, caps, slim line, orifice tubes, washers, gaskets, & more
- FULL O-ring coverage!
- Heavy-duty portable cabinet comes with handle & snap-lock cover

REFILL POSTER
available showing complete line of refills.



Part # A2005HD
Designed for Heavy Duty Vehicle Coverage 2019-1993

A2007 EUROPEAN A/C MAINTENANCE ASSORTMENT



- Refillable A/C parts system loaded with 100+ SKUs of over 700 service parts
- Designed specifically for coverage of vehicles in U.K. and Europe
- R134a service caps, valves, primary seals, slim line & sealing washers
- FULL O-ring coverage! Includes double seals for Citroen, Fiat, Peugeot, Renault, Alfa Romeo, Iveco, and Lancia
- Custom designed & labeled assortments are available to fill your specific needs

Part # A2007
Designed for Vehicle Coverage 2019-2000

O-RING ASSORTMENTS

RETAIL PACKAGE O-RING ASSORTMENTS

Part # 17706 12 Piece Box

- 3 Each of 4 popular O-Rings
- Fit domestic & import vehicles













Part # 17707 24 Piece Box

- 8 SKUs of popular HNBR AS568 standard O-ring sizes
- Fit domestic & import vehicles















SPECIAL SEALS... HNBR

ILLUSTRATED
ACTUAL SIZE

					
Part # 16389 #6 Double O-ring Fiat OEM #10551983	Part # 16396 #8 Double O-ring Fiat OEM #10552083	Part # 16402 #10 Double O-ring Fiat OEM #10552183	Part # 16419 #6 Double O-ring Peugeot OEM #6460P0	Part # 16464 8mm #6 Molded Seal	Part # 16471 11mm #8 Molded Seal
Citroen, Fiat, Peugeot, Renault, Alfa Romeo, Iveco, Lancia					
					
Part # 16433 11mm #8 Double O-ring -- Renault	Part # 16440 13mm #10 Double O-ring -- Renault	Part # 16457 16mm #12 Double O-ring -- Renault	Part # 16426 #8 Double O-ring Peugeot OEM #6460P1	Part # 16488 14mm #10 Molded Seal	Part # 16495 17mm #12 Molded Seal

DOUBLE AND TUBE O-RING ASSORTMENT



















- Assortment contains hard to find seals for:
Alfa Romeo
Citroen
Fiat
Iveco
Lancia
Peugeot and Renault vehicles
Part # 18239

			
Part # 16389 #6 Double O-ring Fiat OEM #10551983	Part # 16396 #8 Double O-ring Fiat OEM #10552083	Part # 16402 #10 Double O-ring Fiat OEM #10552183	Part # 16419 #6 Double O-ring Peugeot OEM #6460P0
			
Part # 16426 #8 Double O-ring Peugeot OEM #6460P1	Part # 16433 11mm #8 Double O-ring Renault	Part # 16440 13mm #10 Double O-ring Renault	Part # 16457 16mm #12 Double O-ring Renault
			
Part # 16464 8mm #6 Molded Seal Citroen, Fiat, Peugeot, Renault, Alfa Romeo, Iveco, Lancia	Part # 16471 11mm #8 Molded Seal Citroen, Fiat, Peugeot, Renault, Alfa Romeo, Iveco, Lancia	Part # 16488 14mm #10 Molded Seal Citroen, Fiat, Peugeot, Renault, Alfa Romeo, Iveco, Lancia	Part # 16495 17mm #12 Molded Seal Citroen, Fiat, Peugeot, Renault, Alfa Romeo, Iveco, Lancia

ALL ASSORTMENTS REFILLABLE

OEM SPECIFIC A/C ASSORTMENTS

ALFA ROMEO SERVICE ASSORTMENT

 Part # 568-008-10 GM Capillary Tube	 Part # 568-010-10 Nissan hose fitting & O-ring Nissan, Nissan 5047 sensor, Diesel Kia DK518H at plug	 Part # 568-011-10 #8 Hose Fitting, Nissan #10 hose fitting/dryer, Hyundai #5 springlock	 Part # 568-012-10 Toyota pressure switch, Mitsubishi FX105V compressor control valve (inner), #8 compression fitting	 Part # 568-013-10 #8 Hose Fitting, Volvo #8 hose fitting, Mazda #8 springlock fitting, GM V5 control valve, Nissan #12 (20MM) hose fitting	 Part # 568-015-10 #10 Hose Fitting, Ford #10 tube & non-metric springlock fitting, Toyota suction line
 Part # 568-017-10 #10 Hose Fitting, Nissan 19MM evaporator suction	 Part # M2106-10 GM Hose Fitting, Nissan/Cadillac, Capri/PC, Ford/Over/Condenser, Evap. O-Ring	 Part # M208-10 Metric O-Ring Tube, 19MM Hose Fitting	 Part # 568-105-10 Chrysler, GM, Import (Acura, Toyota, Mazda)	 Part # 568-113-10 #12 Capri/PC, GM ADR14, Sanyo S0708/709 compressor shaft seal head, Mitsubishi FX80 suction port	 Part # 568-115-10 #12 Capri/PC, GM ADR14, Sanyo S0708/709 compressor shaft seal head, Mitsubishi FX80 suction port
 Part # 568-116-10 Ford F16 nut (short), Nissan, GM, V5, subaltern/charge port, Mitsubishi FX80 to seal tube	 Part # 568-211-10 GM A5, GM, V16, V5 service valve, Ford FX15/F510 serv. valve	 Part # 672-10 Standard Valve Core	 Part # 618B-10 1/4" R-12 Service Port Cap	 Part # 623-10 13 MM LS Aeroquip Cap	 Part # 624-10 16 MM HS Aeroquip Cap













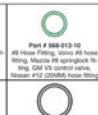

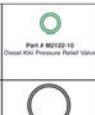



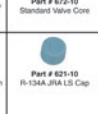
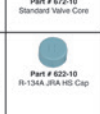

Part # 7035 includes:

- | | | |
|-------------|-------------|----------|
| 10) 568-008 | 10) M2106 | 10) 672 |
| 10) 568-010 | 10) M2108 | 10) 618B |
| 10) 568-011 | 10) 568-105 | 6) 623 |
| 10) 568-012 | 10) 568-113 | 6) 624 |
| 10) 568-013 | 10) 568-114 | |
| 10) 568-015 | 10) 568-116 | |
| 10) 568-017 | 10) 568-211 | |

AUDI/VOLKSWAGEN SERVICE ASSORTMENT

Part # 7042 includes:





- | | | |
|-------------|-------------|---------|
| 10) 568-008 | 10) M2110 | 10) 672 |
| 10) 568-011 | 10) M2136 | 6) 618B |
| 10) 568-013 | 10) M2125 | 10) 674 |
| 10) 568-015 | 10) M2138 | 4) 621 |
| 10) 568-017 | 10) M2141 | 4) 622 |
| 10) M2122 | 10) 568-119 | 4) 614 |
| 10) M2109 | 10) 568-211 | 4) 615 |

 Part # 568-008-10 GM Capillary Tube	 Part # 568-011-10 #8 Hose Fitting, Nissan #10 hose fitting/dryer, Hyundai #5 springlock	 Part # 568-013-10 #8 Hose Fitting, Volvo #8 hose fitting, Mazda #8 springlock fitting, GM V5 control valve, Nissan #12 (20MM) hose fitting	 Part # 568-015-10 #10 Hose Fitting, Ford #10 tube & non-metric springlock fitting, Toyota suction line	 Part # 568-017-10 #10 Hose Fitting, Nissan 19MM evaporator suction	 Diesel KIA Pressure Relief Valve
 Part # M2109-10 Metric Low Pressure Switch, Pressure Relief Valve, Lower Control Valve	 Part # M2110-10 Metric Hose Fitting, 19MM Hose Fitting	 Part # M2136-10 GM #12 (20MM) Spring Valve, 19MM Hose Fitting	 Part # M2138-10 GM Service #12 O-Ring	 Part # M2141-10 Metric 1/4" R-12 Service Port Fitting, Evaporator Connector	 Part # M2141-10 1/4" R-12 Service Port Cap, Rubber Seal
 Part # 568-119-10 Sanyo S0708/709 Shaft Seal Seal, Chrysler RV2 Dis. Muffler	 Part # 568-211-10 GM A5, GM, V16, V5 service valve, Ford FX15/F510 serv. valve	 Part # 672-10 Standard Valve Core	 Part # 672-10 Standard Valve Core	 Part # 618B-10 1/4" R-12 Service Port Cap	 Part # 618B-10 1/4" R-12 Service Port Cap
 Part # 674-10 JVA Upstream Refrigeration Accessory High Flow	 Part # 674-10 JVA Upstream Refrigeration Accessory High Flow	 Part # 621-10 R-134A, JVA HS Cap	 Part # 622-10 R-134A, JVA HS Cap	 Part # 614-10 R-134A Blue Low Side Cap	 Part # 615-10 R-134A Red High Side Cap

BMW SERVICE ASSORTMENT

Part # 7059 includes:

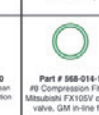
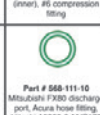
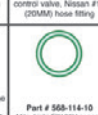











- | | | |
|-------------|-------------|-------------|
| 4) 568-3106 | 10) 568-012 | 10) 568-114 |
| 4) M2153 | 10) 568-013 | 10) 568-119 |
| 6) 618B | 10) 568-015 | 10) 672 |
| 6) 623 | 10) 568-017 | |
| 6) 624 | 10) M2130 | |
| 10) 568-902 | 10) 568-110 | |
| 10) 568-011 | 10) 568-111 | |

 Part # 568-3106-10 Toyota, Nippondenso suction/Discharge Manifold, hoses (NOT ACTUAL SIZE)	 Part # M2153 Nippondenso 10PA15C Manifold Gasket (NOT ACTUAL SIZE)	 Part # 618B-10 1/4" R-12 Service Port Cap	 Part # 623-10 13 MM LS Aeroquip Cap	 Part # 624-10 16 MM HS Aeroquip Cap	 Part # 568-902-10 19MM Hose Fitting Seal, Filter On/Exp. Valve O-Ring
 Part # 568-011-10 #8 Hose Fitting, Nissan #10 hose fitting/dryer, Hyundai #5 springlock	 Part # 568-012-10 Toyota pressure switch, Mitsubishi FX105V compressor control valve (inner), #8 compression fitting	 Part # 568-013-10 #8 Hose Fitting, Volvo #8 hose fitting, Mazda #8 springlock fitting, GM V5 control valve, Nissan #12 (20MM) hose fitting	 Part # 568-015-10 #10 Hose Fitting, Ford #10 tube & non-metric springlock fitting, Toyota suction line	 Part # 568-017-10 #10 Hose Fitting, Nissan 19MM evaporator suction	 Part # 568-016-10 #10 Compression Fitting, Mitsubishi FX105V control valve, GM in-line filter
 Part # 568-110-10 #8 GM capillary, Chrysler EC17 large control valve (outer)	 Part # 568-111-10 Mitsubishi FX80 discharge port, Acura hose fitting, Mazda A5000 & M21370 service valve	 Part # 568-114-10 Mitsubishi FX105V sensor, Kohler 1505/150R shaft seal head	 Part # 116-10 Sanyo S0708, S0709 Shaft Seal Seal, Chrysler RV2 Dis. Muffler	 Part # 672-10 Standard Valve Core	 Part # 672-10 Standard Valve Core

CITROEN/PEUGOT ASSORTMENT

Part # 7066 includes:

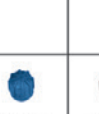
- | | |
|-------------|-------------|
| 10) 568-008 | 10) 672 |
| 10) 568-011 | 5) 679 |
| 10) 568-013 | 10) 568-211 |
| 10) 568-015 | 10) 618 |
| 10) 568-017 | 6) 623 |
| 10) M2109 | 6) 624 |

 Part # 568-008-10 GM Capillary Tube	 Part # 568-011-10 #8 Hose Fitting, Nissan #10 hose fitting/dryer, Hyundai #5 springlock	 Part # 568-013-10 #8 Hose Fitting, Volvo #8 hose fitting, Mazda #8 springlock fitting, GM V5 control valve, Nissan #12 (20MM) hose fitting	 Part # 568-015-10 #10 Hose Fitting, Ford #10 tube & non-metric springlock fitting, Toyota suction line	 Part # 568-017-10 #12 Hose Fitting, Nissan 19MM evaporator suction	 Metric Low Pressure Switch, Pressure Relief Valve, Lower Control Valve
 Part # 672-10 Standard Valve Core	 Part # 679-10 R-134a Plug-in / Volvo High Flow Valve Core	 Part # 568-211-10 GM A5, GM, V16, V5 service valve, Ford FX15/F510 serv. valve	 Part # 618B-10 1/4" R-12 Service Port Cap	 Part # 623-10 13 MM LS Aeroquip Cap	 Part # 624-10 16 MM HS Aeroquip Cap

ALL ASSORTMENTS REFILLABLE

OEM SPECIFIC A/C ASSORTMENTS

CHRYSLER/JEEP METAL GASKET 42 PIECE ASSORTMENT

Part # 286 Includes:

- | | | | |
|-------------|--------|--------|--------|
| 3) 568-012N | 3) 422 | 3) 429 | 3) 448 |
| 6) 568-211N | 3) 426 | 6) 430 | 6) 449 |
| 3) 420 | 6) 428 | | |



CHRYSLER/JEEP SERVICE ASSORTMENT

Part # 7080 includes:

- | | | |
|-------------|-------------|--------------|
| 2) 568-3106 | 10) M2113 | 10) M2125 |
| 2) 568-212 | 2) OR60-8 | 10) 568-2024 |
| 2) 568-208 | 4) 620B | 5) 672 |
| 10) 568-011 | 5) M2117 | 4) 618B |
| 5) 568-012 | 10) 568-008 | 2) 623 |
| 10) 568-013 | 10) M2123 | 2) 624 |
| 5) 568-014 | 2) OR60-10 | 2) 614 |
| 10) 568-015 | 10) 568-105 | 2) 615 |
| 10) 568-017 | 10) M2124 | |

Part # 568-006-10 Chrysler Expansion Block Valve Expansion Valve, Block Fitting	Part # 568-3106-10 Hippocrene Sun-Cin, Marland Gasket with actuator, 6202	Part # 568-213-10 Chrysler block and separator, Line	Part # 568-011-10 #8 Hose Fitting, Nissan #12 hose fitting/air dryer, Hyundai #5 springplug	Part # 568-013-10 #8 Compression Fitting	Part # 568-015-10 #8 Hose Fitting, Volvo #8 hose fitting, Mazda #8 springplug fit- ing, GM #10 control valve, Nissan #12 (2004) hose fitting
Part # 568-014-10 #8 Compression Fitting, Mitsubishi FX100V control valve, GM inline filter	Part # 568-015-10 #10 Hose Fitting, Ford #10 hose & in-hornet springplug fitting, Toyota suction line	Part # 568-017-10 #12 Hose Fitting, Nissan 1984 evaporator suction	Part # M2113-10 Block Fitting/compressor, Hatch- Comp, Marland, 1/2" Metric Conduit, 11MM Hose Fitting	Part # OR60-8-10 #8 Garter Spring	Part # M2117-10 Block Fitting/compressor, Hatch- Comp, Marland, 1/2" Metric Conduit, 11MM Hose Fitting
Part # 568-009-10 GM Capillary Tube	Part # M2123-10 Ford #10 Metric Springplug, Nissan/Genie 10P/20E	Part # OR60-10-10 #10 Garter Spring	Part # 568-105-10 Chrysler, GM Inlet (Acton, Toyota, Mazda)	Part # M2124-10 Hippocrene 10P8 Suction, Emp, 13MM Hose Fitting, Nissan 0247 M2123, Cadillac A850-8535	Part # M2125-10 GM Special FX10 Fitting O-ring
Part # 568-002-10 Nissan auto/recharge, 35MM Hose Fitting, Chrysler metric, Springplug Kit O-ring	Part # 672-10 Standard Valve Core	Part # 620B-10 3/16" R-12 Service Plug Cap	Part # 618B-10 1/4" R-12 Service Plug Cap	Part # 623-10 13MM LS Aeroquip Cap	Part # 614-10 R-134a Blue Low Side Cap
		Part # 615-10 1/4" R-12 Service Plug Cap		Part # 615-10 R-134a Red High Side Cap	

FIAT SERVICE ASSORTMENT

Part # 7097 includes:

- | | | |
|-------------|-------------|-------------|
| 10) 568-008 | 10) 568-114 | 10) 568-114 |
| 10) 568-011 | 10) 568-115 | 10) M2122 |
| 10) 568-012 | 10) 568-116 | 10) M2123 |
| 10) 568-013 | 10) 568-117 | 10) 672 |
| 10) 568-015 | 10) M2102 | 10) 618B |
| 10) 568-017 | 10) M2106 | 5) 614 |
| | | 5) 615 |

Part # 568-006-10 GM Capillary Tube	Part # 568-011-10 #8 Hose Fitting, Nissan #10 hose fitting/air dryer, Hyundai #5 springplug	Part # 568-013-10 Toyota pressure switch, Mitsubishi FX100V compressor control valve (inner), #8 compression fitting	Part # 568-015-10 #8 Hose Fitting, Volvo #8 hose fitting, Mazda #8 springplug fitting, GM #5 control valve, Nissan #12 (2004) hose fitting	Part # 568-017-10 #10 Hose Fitting, Ford #10 hose & in-hornet springplug fitting, Toyota suction line	Part # M2113-10 #12 Hose Fitting, Nissan 1984 evaporator suction
Part # 568-114-10 Mitsubishi FX100V sensor, Kia/Genie 10P/20E	Part # 568-115-10 Datsun/Kia/Genie/DK3/D3 discharge port	Part # 568-116-10 Ford F800 coil discharge, Nissan, ICEP comp, Nissan, GM, Mitsubishi FX100V seal cover	Part # 568-117-10 Ford block coil valve, Datsun/Kia/DK3/D3 compressor suction service valve	Part # M2122-10 #8 Hose Fitting, Nissan/Cadillac, Cadillac, Nissan/Cadillac, Cadillac, Ford/Genie/Genie Emp, O-ring	Part # M2106-10 #8 Hose Fitting, Nissan/Cadillac, Cadillac, Ford/Genie/Genie Emp, O-ring
Part # M2123-10 Datsun/Kia Pressure Relief Valve	Part # M2122-10 Ford #10 Metric Springplug, Hippocrene 10P/20E, Compressor Inlet Marland O-Ring	Part # 672-10 Standard Valve Core	Part # 618B-10 1/4" R-12 Service Plug Cap	Part # 614-10 R-134a Blue Low Side Cap	Part # 615-10 R-134a Red High Side Cap



FORD SPRING & O-RING HNBR GREEN RUBBER 120 PIECE ASST.

Part # OR866 Includes:

- | | | | |
|-------------|-------------|-------------|------------|
| 10) 568-008 | 10) 568-015 | 5) OR60-6 | 5) 568-211 |
| 10) 568-010 | 10) 568-017 | 5) OR60-8 | |
| 10) 568-011 | 5) 568-111 | 5) OR60-10 | |
| 10) 568-012 | 5) 568-116 | 5) OR60-12 | |
| 10) 568-013 | 5) 568-118 | 10) 568-014 | |

ALL ASSORTMENTS REFILLABLE

OEM SPECIFIC A/C ASSORTMENTS

FORD SPRING LOCK COUPLING ASSORTMENT

Part # OR60 Includes:

- 10) 568-011
- 10) 568-013
- 10) 568-015
- 10) 568-017
- 5) OR60-6
- 5) OR60-8
- 5) OR60-10
- 5) OR60-12



FORD METRIC SPRING LOCK COUPLING ASST

Part # 10059 Includes:

- 10) M2115
- 10) M2113
- 10) M2123
- 10) M2145
- 5) OR60-6
- 5) OR60-8
- 5) OR60-10
- 5) OR60-12



FORD UNIVERSAL SERVICE ASSORTMENT

Part # 7103 includes:

- 10) 568-008
- 10) 568-010
- 10) 568-011
- 10) 568-012
- 10) 568-013
- 10) 568-015
- 10) 568-017
- 10) M2106
- 10) M2122
- 10) 568-211
- 10) M2113
- 10) M2115
- 10) 568-2109
- 10) M2123
- 10) M2135
- 10) 568-110
- 10) 568-903
- 10) 568-910
- 10) 568-2024
- 6) 623
- 6) 624
- 10) 618B
- 10) 672
- 10) 674
- 6) 621
- 6) 622
- 10) OR60-6
- 10) OR60-8
- 10) OR60-10
- 10) OR60-12
- 10) 568-105
- 10) 568-106
- 10) OV116

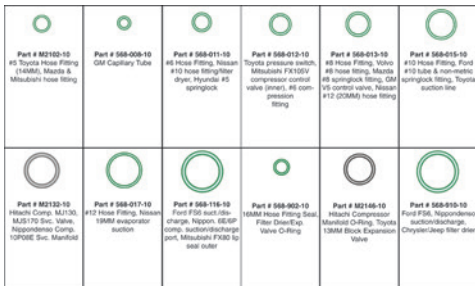
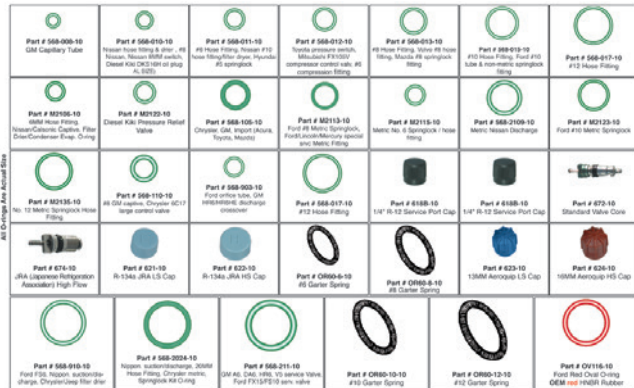

GEO ASSORTMENT

Part # 7110 includes:

- 10) M2102
- 10) 568-008
- 10) 568-011
- 10) 568-012
- 10) 568-013
- 10) 568-015
- 10) 568-015N
- 10) 568-017
- 10) 568-116
- 10) 568-902
- 10) M2147
- 10) 568-910

GM UNIVERSAL SERVICE ASSORTMENT

Part # 13494 includes:

- 10) 568-008
- 10) 568-011
- 10) 568-012
- 10) 568-013
- 10) 568-015
- 10) 568-906
- 10) 568-017
- 10) 568-108
- 10) 568-110
- 10) 568-112
- 10) 568-113
- 2) 889
- 2) 889
- 2) 889
- 10) 568-115
- 10) 568-118
- 10) 568-211
- 10) 568-212
- 10) M2148
- 2) 9213
- 2) 887
- 2) 9220
- 2) 9237
- 2) 890
- 2) 888
- 1) 9206

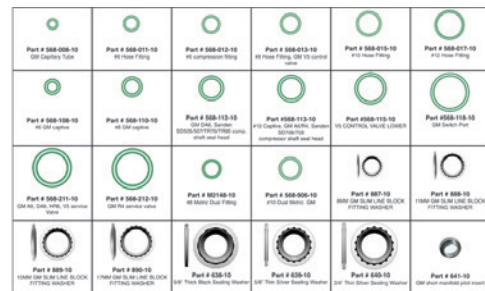

ALL ASSORTMENTS REFILLABLE

OEM SPECIFIC A/C ASSORTMENTS



GM SERVICE ASSORTMENT

Part # OR173 Includes:

- | | | |
|-------------|-------------|-------------|
| 10) 614 | 10) 568-013 | 5) 568-118 |
| 8) 615 | 10) 568-014 | 5) 568-211 |
| 5) 638 | 10) 568-015 | 5) 568-212 |
| 5) 639 | 10) 568-016 | 10) 568-903 |
| 5) 640 | 10) 568-017 | 5) 568-905 |
| 10) 672 | 10) 568-108 | 5) M2121 |
| 10) 568-011 | 10) 568-110 | 5) M2125 |
| 5) 568-113 | 5) 0V211 | |

HONDA/ACURA SERVICE ASSORTMENT

Part # 7127 includes:

- | | | |
|-------------|-------------|-------------|
| 10) M2102 | 10) 568-015 | 10) M2147 |
| 10) 568-008 | 10) 568-017 | 10) 568-910 |
| 10) M2103 | 10) 568-111 | 2) 672 |
| 10) 568-011 | 10) 568-114 | 2) 674 |
| 10) M2117 | 10) 568-115 | 2) 621 |
| 10) 568-012 | 10) 568-116 | 2) 622 |
| 10) 568-013 | 10) 568-117 | 2) 623 |
| 10) M2126 | 10) 568-901 | 2) 624 |
| 2) 568-3106 | | |

 Part # 568-008-10 1/8 Toyota Hose Filling (1408), Mazda & Mitsubishi hose filling.	 Part # 568-008-10 GM Capillary Tube	 Part # M2103-10 GM orifice tube, Acura, Toyota T100 liquid line, Mazda hose filling.	 Part # 568-011-10 1/8 Hose Filling, Nissan 1/8 hose filter/dryer, Hyundai 1/8 springlock.	 Part # M2117-10 Block Filling/Compressor Condens. 15MM Hose Filling.	 Part # 568-011-10 Toyota pressure switch, Mitsubishi F10101 cond., control valve, 4/5 compressor filling.
 Part # 568-015-10 1/8 hose filling, Volvo 1/8 hose filling, Mazda 1/8 springlock fitting, GM 1/8 control valve, Nissan 1/8 (20046) hose filling.	 Part # M2126-10 S/S Metric O-Ring	 Part # 568-015-10 1/8 Hose Filling, Ford 1/8 tube & non-metric springlock fitting, Toyota suction line.	 Part # 568-017-10 1/8 Hose Filling, Nissan 15MM evaporator suction.	 Part # 568-111-10 Mitsubishi F300 discharge port, Acura hose filling, Honda ACCORD & BLS170 80/100 valve.	 Part # 568-114-10 Mitsubishi F300 sensor, Kellen 150L/130R shaft seal head.
 Part # 568-115-10 Diesel KIA SH DK31303 discharge port.	 Part # 568-116-10 Nissan KE57 compressor rechargement port, Mitsubishi FX30 top seal roller.	 Part # 568-117-10 Diesel KIA DK31303 discharge port.	 Part # 568-901-10 1/8 Nissan hose fitting, valve, GM V88 Steel Line, Nissan 6848 STV valve.	 Part # M2147-10 Honda Compressor Standard O-Ring, Toyota 15MM Block Equipped Valve.	 Part # 568-910-10 Ford F30, Nissan, subcompact, Kellen 150L/130R shaft seal head.
 Part # 672-10 Standard Valve Core	 Part # 674-10 JVA Licorice Refrigeration Association High Flow	 Part # 621-10 R-134a JVA Low Side Cap	 Part # 622-10 R-134a JVA High Side Cap	 Part # 623-10 15MM 1/8 Annapop Cap	 Part # 568-016-10 Toyota, Nissan/condens. Suction/Discharge Manifold Gasket

HYUNDAI SERVICE ASSORTMENT

Part # 7134 includes:

- | | | |
|-------------|-------------|------------|
| 10) 568-008 | 10) 568-017 | 5) OR60-10 |
| 10) M2122 | 10) M2140 | 5) OR60-12 |
| 10) 568-011 | 10) M2143 | 2) 672 |
| 10) 568-012 | 10) 568-114 | 2) 674 |
| 10) 568-013 | 10) 568-115 | 2) 614 |
| 10) M2123 | 10) 568-116 | 2) 615 |
| 10) 568-015 | 10) 568-211 | 2) 621 |
| 10) M2135 | 10) 568-903 | 2) 622 |

 Part # 568-008-10 GM Capillary Tube	 Part # M2122-10 Diesel KIA Pressure Relief Valve	 Part # 568-011-10 1/8 Hose Filling, Nissan 1/8 hose filter/dryer, Hyundai 1/8 springlock.	 Part # 568-015-10 Toyota pressure switch, Mitsubishi FX301 comp. control valve, 4/5 compressor filling.	 Part # 568-015-10 1/8 Hose Filling, Nissan 1/8 springlock fitting, Nissan F10 (20046) hose filling.	 Part # M2103-10 1/8 Hose Filling, Nissan 1/8 hose filter/dryer, Hyundai 1/8 springlock.
 Part # 568-015-10 1/8 Hose Filling, Ford 1/8 tube & non-metric springlock fitting, Toyota suction line.	 Part # M2135-10 No. 12 Metric Springlock Hose Filling	 Part # 568-017-10 1/8 Hose Filling, Nissan 15MM evaporator suction.	 Part # M2140-10 Diesel KIA Cha. Part, Carbon Vt Housing, Carbon Seal Head	 Part # M2143-10 Diesel KIA CH Compressor Suction, Diesel KIA Compressor Suction Port	 Part # 568-114-10 Mitsubishi F300 sensor, Kellen 150L/130R shaft seal head.
 Part # 568-115-10 Diesel KIA SH DK31303 discharge port.	 Part # 568-116-10 Nissan KE57 compressor rechargement port, Mitsubishi FX30 top seal roller.	 Part # 568-211-10 GM AK 134a 1/8, V3 service valve, Ford FX15F310 seal, valve.	 Part # 568-903-10 Part orifice tube, GM H0424804E discharge compressor.	 Part # OR60-10-10 F10 Garter Spring	 Part # OR60-12-10 F10 Garter Spring
 Part # 672-10 Standard Valve Core	 Part # 674-10 JVA Licorice Refrigeration Association High Flow	 Part # 614-10 R-134a Blue Low Side Cap	 Part # 615-10 R-134a Red High Side Cap	 Part # 621-10 R-134a JVA Low Side Cap	 Part # 622-10 R-134a JVA High Side Cap

ALL ASSORTMENTS REFILLABLE

OEM SPECIFIC A/C ASSORTMENTS

ISUZU SERVICE ASSORTMENT

Part # 7141 includes:

- | | | |
|-------------|-------------|--------|
| 10) M2102 | 10) M2140 | 2) 640 |
| 10) 568-008 | 10) M2143 | 2) 641 |
| 10) M2103 | 10) 568-115 | 2) 672 |
| 10) 568-011 | 10) 568-117 | 2) 674 |
| 10) 568-012 | 10) 568-212 | 2) 614 |
| 10) 568-013 | 10) 568-902 | 2) 615 |
| 10) 568-015 | 2) 638 | 2) 621 |
| 10) 568-017 | 2) 639 | 2) 622 |

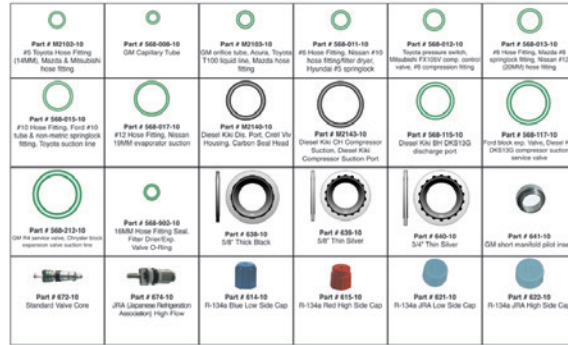

JAGUAR SERVICE ASSORTMENT

Part # 7158 includes:

- | | | |
|-------------|-------------|---------|
| 10) 568-008 | 10) 568-114 | 6) 618B |
| 10) 568-010 | 10) 568-211 | 10) 672 |
| 10) 568-016 | 10) M2106 | 4) 614 |
| 10) 568-011 | 10) 568-903 | 4) 615 |
| 10) 568-012 | 10) 568-105 | |
| 10) 568-013 | 10) M2119 | |
| 10) 568-015 | 10) M2124 | |
| 10) 568-017 | 10) 568-212 | |

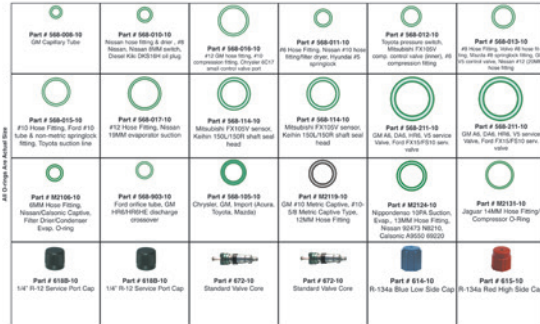

MAZDA SERVICE ASSORTMENT

Part # 7165 includes:

- | | | |
|-------------|-------------|------------|
| 10) M2102 | 4) 568-114 | 2) OR60-12 |
| 10) 568-011 | 4) 568-115 | 2) 672 |
| 10) M2103 | 4) 568-116 | 2) 674 |
| 10) M2122 | 4) 568-117 | 2) 614 |
| 10) 568-013 | 10) 568-211 | 2) 615 |
| 10) 568-008 | 10) 568-902 | 2) 621 |
| 5) M2113 | 10) 568-903 | 2) 622 |
| 5) M2115 | 4) 568-910 | |
| 5) M2123 | 2) OR60-6 | |
| 10) 568-015 | 2) OR60-8 | |
| 10) 568-017 | 2) OR60-10 | |

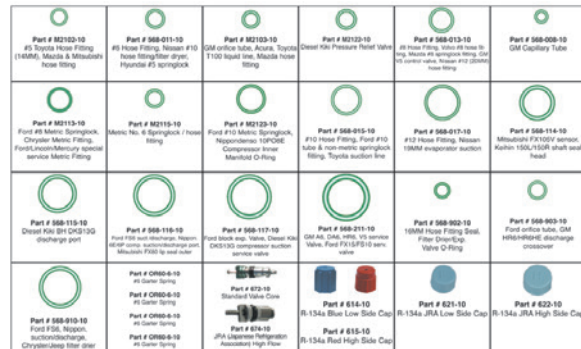

ALL ASSORTMENTS REFILLABLE

OEM SPECIFIC A/C ASSORTMENTS

MERCEDES SERVICE ASSORTMENT

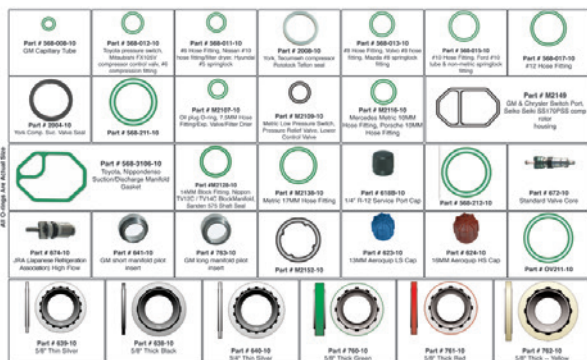

Part # 7172 includes:

- | | | |
|-------------|-------------|-------------|
| 10) 568-008 | 2) 762 | 10) M2128 |
| 10) 568-012 | 4) 763 | 10) M2138 |
| 10) 568-211 | 2) 568-3106 | 10) 568-116 |
| 10) 2008 | 2) M2149 | 10) 0V211 |
| 10) 2004 | 10) 568-011 | 10) 568-212 |
| 4) 638 | 10) 568-013 | 10) M2152 |
| 4) 639 | 10) 568-015 | 6) 623 |
| 4) 640 | 10) 568-017 | 6) 624 |
| 4) 641 | 10) M2107 | 10) 618B |
| 2) 760 | 10) M2109 | 10) 672 |
| 2) 761 | 10) M2116 | |

MITSUBISHI SERVICE ASSORTMENT

Part # 7189 includes:

- | | | |
|-------------|-------------|------------|
| 2) M2150 | 10) 568-015 | 2) 614 |
| 2) M2151 | 10) 568-016 | 2) 621 |
| 10) M2102 | 10) 568-017 | 4) 568-114 |
| 10) 568-010 | 4) 568-111 | 4) 568-116 |
| 10) 568-008 | 4) 568-113 | 4) OR60-10 |
| 10) 568-011 | 10) 568-902 | 2) 674 |
| 10) 568-012 | 4) 568-211 | 2) 615 |
| 10) 568-013 | 4) M2123 | 2) 622 |
| 10) 568-014 | 2) 672 | |

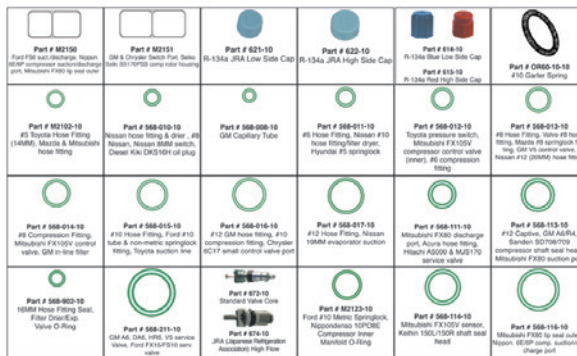

NISSAN/CALSONIC SERVICE ASSORTMENT

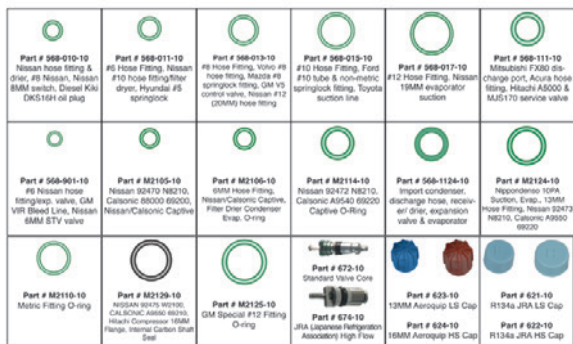

Part # 7196 includes:

- | | | |
|------------|-------------|--------|
| 5) 568-010 | 5) M2106 | 4) 674 |
| 5) 568-011 | 5) M2114 | 2) 621 |
| 5) 568-013 | 5) 568-1124 | 2) 622 |
| 5) 568-015 | 5) M2124 | 2) 623 |
| 5) 568-017 | 5) M2110 | 2) 624 |
| 5) 568-111 | 5) M2129 | |
| 5) 568-901 | 5) M2125 | |
| 5) M2105 | 4) 672 | |

ALL ASSORTMENTS REFILLABLE

OEM SPECIFIC A/C ASSORTMENTS

OPEL/VAUXHALL SERVICE ASSORTMENT

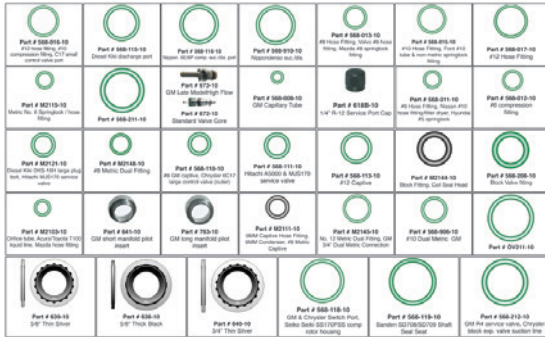

Part # 7202 includes:

- | | | | |
|-------------|-------------|-------------|-------------|
| 10) 568-016 | 4) 614 | 10) 568-017 | 10) 568-906 |
| 10) 568-115 | 4) 615 | 10) 568-110 | |
| 10) 568-116 | 4) 641 | 10) 568-111 | |
| 10) 568-118 | 4) 763 | 10) 568-113 | |
| 10) 568-119 | 4) 638 | 10) M2144 | |
| 10) 568-211 | 4) 639 | 10) 568-208 | |
| 10) OV211 | 4) 640 | 10) M2103 | |
| 10) 568-212 | 10) 568-008 | 10) M2111 | |
| 10) 568-910 | 10) 568-011 | 10) M2115 | |
| 4) 673 | 10) 568-012 | 10) M2148 | |
| 10) 672 | 10) 568-013 | 10) M2121 | |
| 6) 618B | 10) 568-015 | 10) M2145 | |

PORSCHE SERVICE ASSORTMENT

Part # 7219 includes:

- | | | |
|-------------|--------------|----------|
| 10) 568-008 | 10) M2102 | 10) 672 |
| 10) 568-010 | 10) M2107 | 10) 618B |
| 10) 568-011 | 10) M2112 | 4) 2008 |
| 10) 568-013 | 10) M2116 | 4) 2004 |
| 10) 568-015 | 10) M2128 | |
| 10) 568-017 | 10) M2138 | |
| 10) 568-116 | 10) 568-2024 | |



RENAULT SERVICE ASSORTMENT

Part # 7226 includes:

- | | | |
|-------------|-------------|--------|
| 10) 568-008 | 10) 568-115 | 5) 615 |
| 10) 568-010 | 10) 568-116 | 5) 678 |
| 10) 568-011 | 10) 568-901 | |
| 10) 568-012 | 10) 568-902 | |
| 10) 568-013 | 10) M2102 | |
| 10) 568-015 | 10) 672 | |
| 10) 568-017 | 5) 618B | |
| 10) 568-114 | 5) 614 | |

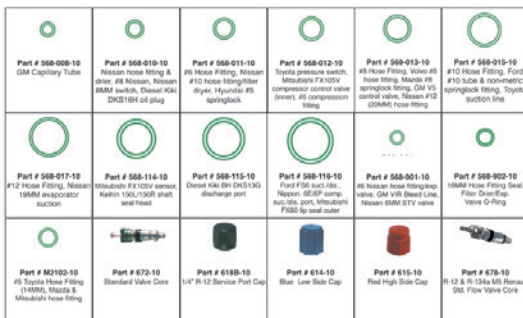

ALL ASSORTMENTS REFILLABLE

OEM SPECIFIC A/C ASSORTMENTS

ROVER SERVICE ASSORTMENT

Part # 7233 includes:

- | | | |
|-------------|--------------|-------------|
| 10) 568-008 | 10) M2103 | 10) 568-901 |
| 10) 568-010 | 10) M2106 | 10) 568-211 |
| 10) 568-011 | 10) M2111 | 6) 618B |
| 10) 568-012 | 10) 568-105 | 10) 672 |
| 10) 568-013 | 10) 568-1124 | |
| 10) 568-015 | 10) M2124 | |
| 10) 568-017 | 4) M2130 | |

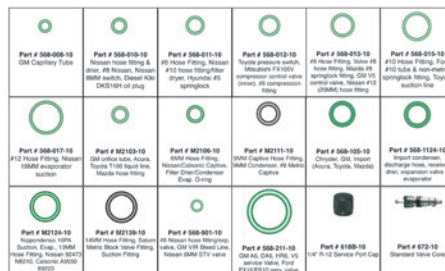

SUBARU/SUZUKI SERVICE ASSORTMENT

Part # 7240 includes:

- | | | |
|-------------|-------------|--------|
| 10) M2102 | 2) 2004 | 2) 614 |
| 10) 568-008 | 2) 2008 | 2) 615 |
| 10) 568-010 | 4) 568-111 | 2) 623 |
| 10) 568-011 | 10) 568-902 | 2) 624 |
| 10) 568-013 | 4) M2129 | 2) 621 |
| 10) 568-015 | 10) M2133 | 2) 622 |
| 10) 568-017 | 2) 674 | 2) 672 |

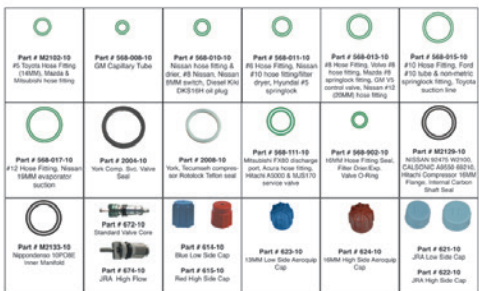

TOYOTA/LEXUS SERVICE ASSORTMENT

Part # 7257 includes:

- | | | |
|-------------|------------|--------|
| 2) 568-3106 | 5) 568-015 | 2) 674 |
| 5) M2102 | 4) 568-114 | 2) 614 |
| 5) 568-008 | 4) 568-116 | 2) 615 |
| 5) M2103 | 4) M2133 | 2) 621 |
| 5) 568-011 | 5) 568-017 | 2) 622 |
| 4) M2117 | 4) 568-211 | |
| 5) 568-013 | 4) M2147 | |
| 4) M2130 | 2) 672 | |

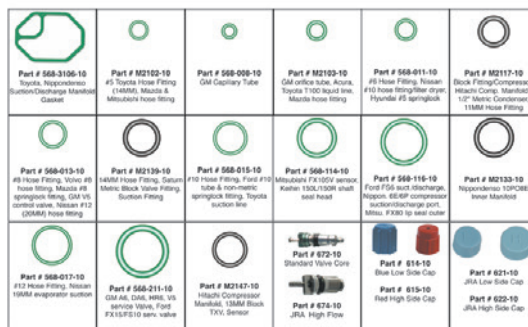

VOLVO/SAAB SERVICE ASSORTMENT

Part # 7264 includes:

- | | | |
|-------------|-------------|-------------|
| 10) 568-008 | 10) 568-110 | 6) 618B |
| 10) M2118 | 10) 568-118 | 10) 672 |
| 10) M2120 | 10) M2144 | 10) 568-211 |
| 10) M2127 | 10) M2104 | 2) 679 |
| 10) 568-014 | 10) M2109 | 6) 623 |
| 10) M2134 | 10) M2137 | 6) 624 |
| 10) M2139 | 10) M2142 | |

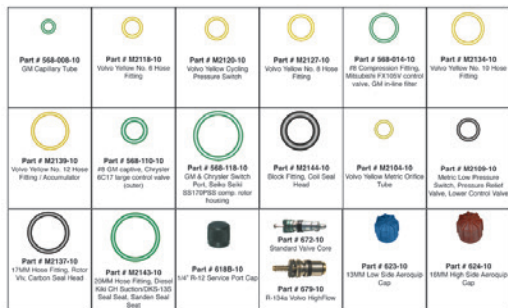

ALL ASSORTMENTS REFILLABLE

A/C MAINTENANCE ASSORTMENTS



DELUXE HNBR RUBBER 350 PIECE O-RING ASSORTMENT

568-901-10 Nissan RX17 4800cc, Columbia AR150 4900cc, Rover A12 5000cc, Alfa Romeo 4000 cc, Honda CRX 1500 cc, Opel Corsa 1500 cc, Opel Astra 1600 cc, Opel Vectra 1600 cc, Opel Omega 1600 cc, Opel Astra 1600 cc, Opel Vectra 1600 cc, Opel Omega 1600 cc.	568-008-10 Nissan RX17 4800cc, Columbia AR150 4900cc, Rover A12 5000cc, Alfa Romeo 4000 cc, Honda CRX 1500 cc, Opel Corsa 1500 cc, Opel Astra 1600 cc, Opel Vectra 1600 cc, Opel Omega 1600 cc.	568-001-10 Nissan RX17 4800cc, Columbia AR150 4900cc, Rover A12 5000cc, Alfa Romeo 4000 cc, Honda CRX 1500 cc, Opel Corsa 1500 cc, Opel Astra 1600 cc, Opel Vectra 1600 cc, Opel Omega 1600 cc.	M2102-10 Nissan RX17 4800cc, Columbia AR150 4900cc, Rover A12 5000cc, Alfa Romeo 4000 cc, Honda CRX 1500 cc, Opel Corsa 1500 cc, Opel Astra 1600 cc, Opel Vectra 1600 cc, Opel Omega 1600 cc.	M2103-10 Nissan RX17 4800cc, Columbia AR150 4900cc, Rover A12 5000cc, Alfa Romeo 4000 cc, Honda CRX 1500 cc, Opel Corsa 1500 cc, Opel Astra 1600 cc, Opel Vectra 1600 cc, Opel Omega 1600 cc.	568-903-10 Nissan RX17 4800cc, Columbia AR150 4900cc, Rover A12 5000cc, Alfa Romeo 4000 cc, Honda CRX 1500 cc, Opel Corsa 1500 cc, Opel Astra 1600 cc, Opel Vectra 1600 cc, Opel Omega 1600 cc.
568-011-10 Nissan RX17 4800cc, Columbia AR150 4900cc, Rover A12 5000cc, Alfa Romeo 4000 cc, Honda CRX 1500 cc, Opel Corsa 1500 cc, Opel Astra 1600 cc, Opel Vectra 1600 cc, Opel Omega 1600 cc.	M2122-10 Nissan RX17 4800cc, Columbia AR150 4900cc, Rover A12 5000cc, Alfa Romeo 4000 cc, Honda CRX 1500 cc, Opel Corsa 1500 cc, Opel Astra 1600 cc, Opel Vectra 1600 cc, Opel Omega 1600 cc.	568-012-10 Nissan RX17 4800cc, Columbia AR150 4900cc, Rover A12 5000cc, Alfa Romeo 4000 cc, Honda CRX 1500 cc, Opel Corsa 1500 cc, Opel Astra 1600 cc, Opel Vectra 1600 cc, Opel Omega 1600 cc.	568-110-10 Nissan RX17 4800cc, Columbia AR150 4900cc, Rover A12 5000cc, Alfa Romeo 4000 cc, Honda CRX 1500 cc, Opel Corsa 1500 cc, Opel Astra 1600 cc, Opel Vectra 1600 cc, Opel Omega 1600 cc.	568-905-10 Nissan RX17 4800cc, Columbia AR150 4900cc, Rover A12 5000cc, Alfa Romeo 4000 cc, Honda CRX 1500 cc, Opel Corsa 1500 cc, Opel Astra 1600 cc, Opel Vectra 1600 cc, Opel Omega 1600 cc.	M2121-10 Nissan RX17 4800cc, Columbia AR150 4900cc, Rover A12 5000cc, Alfa Romeo 4000 cc, Honda CRX 1500 cc, Opel Corsa 1500 cc, Opel Astra 1600 cc, Opel Vectra 1600 cc, Opel Omega 1600 cc.
568-111-10 Nissan RX17 4800cc, Columbia AR150 4900cc, Rover A12 5000cc, Alfa Romeo 4000 cc, Honda CRX 1500 cc, Opel Corsa 1500 cc, Opel Astra 1600 cc, Opel Vectra 1600 cc, Opel Omega 1600 cc.	568-906-10 Nissan RX17 4800cc, Columbia AR150 4900cc, Rover A12 5000cc, Alfa Romeo 4000 cc, Honda CRX 1500 cc, Opel Corsa 1500 cc, Opel Astra 1600 cc, Opel Vectra 1600 cc, Opel Omega 1600 cc.	568-013-10 Nissan RX17 4800cc, Columbia AR150 4900cc, Rover A12 5000cc, Alfa Romeo 4000 cc, Honda CRX 1500 cc, Opel Corsa 1500 cc, Opel Astra 1600 cc, Opel Vectra 1600 cc, Opel Omega 1600 cc.	M2110-10 Nissan RX17 4800cc, Columbia AR150 4900cc, Rover A12 5000cc, Alfa Romeo 4000 cc, Honda CRX 1500 cc, Opel Corsa 1500 cc, Opel Astra 1600 cc, Opel Vectra 1600 cc, Opel Omega 1600 cc.	568-015-10 Nissan RX17 4800cc, Columbia AR150 4900cc, Rover A12 5000cc, Alfa Romeo 4000 cc, Honda CRX 1500 cc, Opel Corsa 1500 cc, Opel Astra 1600 cc, Opel Vectra 1600 cc, Opel Omega 1600 cc.	M2125-10 Nissan RX17 4800cc, Columbia AR150 4900cc, Rover A12 5000cc, Alfa Romeo 4000 cc, Honda CRX 1500 cc, Opel Corsa 1500 cc, Opel Astra 1600 cc, Opel Vectra 1600 cc, Opel Omega 1600 cc.
568-113-10 Nissan RX17 4800cc, Columbia AR150 4900cc, Rover A12 5000cc, Alfa Romeo 4000 cc, Honda CRX 1500 cc, Opel Corsa 1500 cc, Opel Astra 1600 cc, Opel Vectra 1600 cc, Opel Omega 1600 cc.	568-014-10 Nissan RX17 4800cc, Columbia AR150 4900cc, Rover A12 5000cc, Alfa Romeo 4000 cc, Honda CRX 1500 cc, Opel Corsa 1500 cc, Opel Astra 1600 cc, Opel Vectra 1600 cc, Opel Omega 1600 cc.	568-114-10 Nissan RX17 4800cc, Columbia AR150 4900cc, Rover A12 5000cc, Alfa Romeo 4000 cc, Honda CRX 1500 cc, Opel Corsa 1500 cc, Opel Astra 1600 cc, Opel Vectra 1600 cc, Opel Omega 1600 cc.	M2170-10 Nissan RX17 4800cc, Columbia AR150 4900cc, Rover A12 5000cc, Alfa Romeo 4000 cc, Honda CRX 1500 cc, Opel Corsa 1500 cc, Opel Astra 1600 cc, Opel Vectra 1600 cc, Opel Omega 1600 cc.	568-015-10 Nissan RX17 4800cc, Columbia AR150 4900cc, Rover A12 5000cc, Alfa Romeo 4000 cc, Honda CRX 1500 cc, Opel Corsa 1500 cc, Opel Astra 1600 cc, Opel Vectra 1600 cc, Opel Omega 1600 cc.	M2125-10 Nissan RX17 4800cc, Columbia AR150 4900cc, Rover A12 5000cc, Alfa Romeo 4000 cc, Honda CRX 1500 cc, Opel Corsa 1500 cc, Opel Astra 1600 cc, Opel Vectra 1600 cc, Opel Omega 1600 cc.
568-113-10 Nissan RX17 4800cc, Columbia AR150 4900cc, Rover A12 5000cc, Alfa Romeo 4000 cc, Honda CRX 1500 cc, Opel Corsa 1500 cc, Opel Astra 1600 cc, Opel Vectra 1600 cc, Opel Omega 1600 cc.	568-016-10 Nissan RX17 4800cc, Columbia AR150 4900cc, Rover A12 5000cc, Alfa Romeo 4000 cc, Honda CRX 1500 cc, Opel Corsa 1500 cc, Opel Astra 1600 cc, Opel Vectra 1600 cc, Opel Omega 1600 cc.	568-114-10 Nissan RX17 4800cc, Columbia AR150 4900cc, Rover A12 5000cc, Alfa Romeo 4000 cc, Honda CRX 1500 cc, Opel Corsa 1500 cc, Opel Astra 1600 cc, Opel Vectra 1600 cc, Opel Omega 1600 cc.	568-017-10 Nissan RX17 4800cc, Columbia AR150 4900cc, Rover A12 5000cc, Alfa Romeo 4000 cc, Honda CRX 1500 cc, Opel Corsa 1500 cc, Opel Astra 1600 cc, Opel Vectra 1600 cc, Opel Omega 1600 cc.	568-115-10 Nissan RX17 4800cc, Columbia AR150 4900cc, Rover A12 5000cc, Alfa Romeo 4000 cc, Honda CRX 1500 cc, Opel Corsa 1500 cc, Opel Astra 1600 cc, Opel Vectra 1600 cc, Opel Omega 1600 cc.	M2170-10 Nissan RX17 4800cc, Columbia AR150 4900cc, Rover A12 5000cc, Alfa Romeo 4000 cc, Honda CRX 1500 cc, Opel Corsa 1500 cc, Opel Astra 1600 cc, Opel Vectra 1600 cc, Opel Omega 1600 cc.
CV21B Chrysler 198cc, 200cc, 215cc, 230cc, 240cc, 250cc, 260cc, 270cc, 280cc, 290cc, 300cc, 310cc, 320cc, 330cc, 340cc, 350cc, 360cc, 370cc, 380cc, 390cc, 400cc.	CV116-10 Chrysler 198cc, 200cc, 215cc, 230cc, 240cc, 250cc, 260cc, 270cc, 280cc, 290cc, 300cc, 310cc, 320cc, 330cc, 340cc, 350cc, 360cc, 370cc, 380cc, 390cc, 400cc.	568-116-10 Nissan RX17 4800cc, Columbia AR150 4900cc, Rover A12 5000cc, Alfa Romeo 4000 cc, Honda CRX 1500 cc, Opel Corsa 1500 cc, Opel Astra 1600 cc, Opel Vectra 1600 cc, Opel Omega 1600 cc.	568-020-10 Nissan RX17 4800cc, Columbia AR150 4900cc, Rover A12 5000cc, Alfa Romeo 4000 cc, Honda CRX 1500 cc, Opel Corsa 1500 cc, Opel Astra 1600 cc, Opel Vectra 1600 cc, Opel Omega 1600 cc.	568-118-10 Nissan RX17 4800cc, Columbia AR150 4900cc, Rover A12 5000cc, Alfa Romeo 4000 cc, Honda CRX 1500 cc, Opel Corsa 1500 cc, Opel Astra 1600 cc, Opel Vectra 1600 cc, Opel Omega 1600 cc.	568-210-10 Nissan RX17 4800cc, Columbia AR150 4900cc, Rover A12 5000cc, Alfa Romeo 4000 cc, Honda CRX 1500 cc, Opel Corsa 1500 cc, Opel Astra 1600 cc, Opel Vectra 1600 cc, Opel Omega 1600 cc.

Part # OR350 includes:

34 of our most popular O-ring sizes:

- | | | |
|-------------|-------------|--------------|
| 5) 568-901 | 10) 568-008 | 10) 568-010 |
| 10) M2102 | 10) M2103 | 10) 568-108 |
| 10) 568-903 | 20) 568-011 | 5) M2122 |
| 10) 568-012 | 10) 568-110 | 20) 568-905 |
| 20) 568-013 | 10) M2121 | 10) 568-111 |
| 10) 568-906 | 10) 568-014 | 5) M2110 |
| 20) 568-015 | 10) M2125 | 10) 568-2109 |
| 10) 568-113 | 10) 568-016 | 5) 568-114 |
| 20) 568-017 | 5) 568-115 | 5) 568-212 |
| 10) OV211 | 10) OV116 | 10) 568-116 |
| 5) 568-020 | 5) 568-118 | 10) 568-211 |
| 10) 568-018 | | |

REFILL POSTER
available showing complete line of refills.

REFILLS AVAILABLE IN 25 PACKS

DELUXE METRIC HNBR GREEN RUBBER O-RING ASSORTMENT

Part # OR429 Includes:

- | | |
|-------------|--------------|
| 20) 568-901 | 20) 568-010 |
| 10) M2102 | 10) 568-012 |
| 10) 568-110 | 20) M2122 |
| 10) M2121 | 20) M2110 |
| 10) 568-111 | 10) 568-2109 |
| 10) 568-115 | 15) 568-116 |
| 15) 568-910 | |



METRIC HNBR GREEN RUBBER O-RING ASSORTMENT

Part # OR701 Includes:

- | | | |
|-------------|-------------|------------|
| 10) M21-008 | 10) M21-012 | 5) M21-111 |
| 10) M21-010 | 10) M21-013 | 5) M21-211 |
| 10) M21-011 | 10) M21-015 | |

REFILL POSTER
available showing complete line of refills.

REFILLS AVAILABLE IN 25 PACKS

ALL ASSORTMENTS REFILLABLE

A/C MAINTENANCE ASSORTMENTS

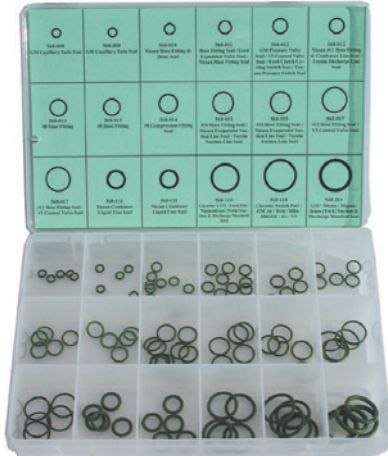

HNBR GREEN RUBBER 105 PIECE O-RING ASSORTMENT

Part # OR105 includes:

- | | |
|-------------|-------------|
| 10) 568-008 | 10) 568-015 |
| 10) 568-010 | 10) 568-017 |
| 10) 568-011 | 10) 568-111 |
| 10) 568-012 | 5) 568-116 |
| 10) 568-013 | 5) 568-118 |
| 10) 568-014 | 5) 568-211 |

TOP 12 HNBR GREEN RUBBER 200 PIECE O-RING ASSORTMENT

Part # OR200 includes:

- | | |
|-------------|-------------|
| 25) 568-008 | 20) 568-015 |
| 25) 568-010 | 20) 568-017 |
| 25) 568-011 | 5) 568-111 |
| 25) 568-012 | 5) 568-116 |
| 20) 568-013 | 5) 568-118 |
| 20) 568-014 | 5) 568-211 |



NEOPRENE RUBBER 105 PIECE O-RING ASSORTMENT

- For use with ALL refrigerant blends
- Neoprene O-rings are generally not affected by exposure to R22, while seals made from NBR Nitrile and HNBR rubber can be damaged when exposed to R22.

Part # BOR105 includes:

- | | |
|--------------|--------------|
| 10) 568-008N | 10) 568-015N |
| 10) 568-010N | 10) 568-017N |
| 10) 568-011N | 10) 568-111N |
| 10) 568-012N | 5) 568-116N |
| 10) 568-013N | 5) 568-118N |
| 10) 568-014N | 5) 568-211N |



A/C MAINTENANCE ASSORTMENTS



UNIVERSAL TRUCK / OTR FARM VEHICLE SERVICE ASSORTMENT (REFILLABLE)

 Part # 568-008-10 GM Capillary Tube	 Part # 568-011-10 #8 Hose Fitting, Nissan #10 hose to triple-line drive, Hyundai #5 springlock	 Part # 568-010-10 Toyota pressure switch, Mitsubishi P1000, comp. control valve (inner), #8 compression fitting	 Part # 568-013-10 #8 Hose Fitting, hose #8 hose to #10 springlock fitting, hose #10 springlock valve, Nissan #10 drilled tube fitting	 Part # 568-015-10 #10 Hose Fitting, Ford #10 tube only, Mazda #8 springlock fitting, & non-metric springlock fitting, Toyota suction hose	 Part # 568-017-10 #12 Hose Fitting, Nissan 1800r springlock system
 Part # M2100-10 #5 Swivel Hose Fitting (1/8"OD), Mazda & Mitsubishi hose fitting	 Part # 568-901-10 #8 Nissan Hose Fitting/OD valve, GM #10 Bleed Line, Nissan 1800r STV valve	 Part # 568-902-10 15MM Hose Fitting Seal, Filter O-Ring Cap, Valve O-Ring	 Part # 568-116-10 Ford #10 seal, Dodge, Nissan, GM #8 spring lock, 1/8" OD Mitsubishi #10 seal valve	 Part # 568-903-10 Ford orifice tube, GM H900-910-01, charge O25000F	 Part # 568-211-10 GM #8, GM #10, 1/8" service Valve, Ford #10 #10 seal valve
 Part # M2100-10 GM orifice tube, Acurel, Toyota 1100 liquid line, Mazda hose fitting	 Part # M2100-10 GM orifice tube, Acurel, Toyota 1100 liquid line, Mazda hose fitting	 Part # 672-10 Standard Valve Core	 Part # 672-10 Standard Valve Core	 Part # 679-10 R-134a Plug-in / Valve High Flow Valve Core	 Part # 674-10 JRA Liquefied Refrigerant Accessories High Flow
 Part # 676-10 Brenn Low Side	 Part # 677-10 10mm High Side	 Part # 623-10 13MM Aurocap LS Cap	 Part # 624-10 16MM Aurocap HS Cap	 Part # 616-10 R-134a Blue Low Side Cap	 Part # 615-10 R-134a Red High Side Cap

Part # 7073 includes:

- | | | |
|-------------|-------------|--------|
| 10) 568-008 | 10) 568-902 | 2) 677 |
| 10) 568-011 | 10) 568-116 | 2) 674 |
| 10) 568-012 | 10) 568-903 | 2) 623 |
| 10) 568-013 | 6) 568-211 | 2) 624 |
| 10) 568-015 | 10) M2103 | 2) 614 |
| 10) 568-017 | 10) 672 | 2) 615 |
| 10) M2102 | 5) 679 | |
| 10) 568-901 | 2) 676 | |

SPRINGLOCK O-RING 40 PIECE ASSORTMENT

Used for springlock fittings in domestic and import vehicles.

Part # OR2000 includes:

- 10) 568-011 -- #6 Springlock Fitting O-ring
- 10) 568-013 -- #8 Springlock Fitting O-ring
- 10) 568-015 -- #10 Springlock Fitting O-ring
- 10) 568-017 -- #12 Springlock Fitting O-ring

O-RING PACKS FOR INDIVIDUAL VEHICLES





















Application Specific -- contain required o-rings, washers, garter springs and gaskets for vehicle service and maintenance

- Part # 4391 GM O-Ring Pack
- Part # 4392 GM O-Ring & Compressor Washer Pack
- Part # 4393 Ford Garter Spring & O-Ring Pack
- Part # 4394 Chrysler Metal Gasket & O-Ring Pack
- Part # 4395 Asian Vehicle O-Ring Pack
- Part # 4396 Asian Vehicle Garter Spring & O-Ring Pack
- Part # 4397 European Vehicle O-Ring Pack

















O-RINGS ILLUSTRATED ACTUAL SIZE

O-RINGS... GREEN HNBR

 <p>Part # 568-901-10 #6 Nissan hose fitting/exp. valve, GM VIR Bleed Line, Nissan 6MM STV valve</p>	 <p>Part # 568-008-10 GM Capillary Tube</p>	 <p>Part # 568-902-10 Oil drain bolt o-ring, 16mm metric filter/drier fitting O-ring, EXP Valve O-ring</p>	 <p>Part # 568-010-10 Nissan hose fitting & drier, #8 Nissan, Nissan 8MM switch, Diesel Kiki DKS16H oil plug</p>
 <p>Part # M2102-10 #5 Toyota Hose Fitting (14MM), Mazda & Mitsubishi hose fitting</p>	 <p>Part # M2105-10 Nissan 92470 N8210, Calsonic 88000 69200, Nissan/Calsonic Captive</p>	 <p>Part # M2106-10 6MM Hose Fitting, Nissan/Calsonic Captive, Filter Drier/Condenser Evap. O-ring</p>	 <p>Part # M2103-10 GM orifice tube, Acura, Toyota T100 liquid line, Mazda hose fitting</p>
 <p>Part # 568-108-10 #6 GM captive, Ford combi valve evap. manifold oil bleed line, Ford block exp. valve</p>	 <p>Part # M2115-10 Metric No. 6 Springlock / hose fitting</p>	 <p>Part # 568-903-10 Ford orifice tube, GM HR6/HR6HE discharge crossover</p>	 <p>Part # 568-011-10 #6 Hose Fitting, Nissan #10 hose fitting/filter dryer, Hyundai #5 springlock</p>
 <p>Part # M2107-10 Oil plug O-ring, 7.5MM Hose Fitting/Exp. Valve/Filter Drier O-Ring</p>	 <p>Part # M2122-10 Diesel Kiki Pressure Relief Valve</p>	 <p>Part # 568-012-10 Toyota pressure switch, Mitsubishi FX105V compressor control valve (inner), #6 compression fitting</p>	 <p>Part # 568-904-10 GM Cycling Switches</p>
 <p>Part # M2112-10 9MM Hose Fitting / Drier O-Ring</p>	 <p>Part # M2148-10 #8 Metric Dual Fitting</p>	 <p>Part # M2113-10 Metric No. 8 Springlock, Chrysler Metric Fitting, Ford/Lincoln/Mercury special service Metric Fitting</p>	 <p>Part # 568-009-10 GM #8 - 1/2" metric captured</p>

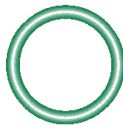
O-RINGS ILLUSTRATED ACTUAL SIZE

O-RINGS... GREEN HNBR

 <p>Part # 568-110-10 #8 GM captive, Chrysler 6C17 large control valve (outer)</p>	 <p>Part # 568-905-10 GM 1/2" Dual Metric Fitting O-ring</p>	 <p>Part # 568-013-10 #8 Hose Fitting, Volvo #8 hose fitting, Mazda #8 springlock fitting, GM V5 control valve, Nissan #12 (20MM) hose fitting</p>	 <p>Part # M2116-10 Mercedes Metric 10MM Hose Fitting, Porsche 10MM Hose Fitting</p>
 <p>Part # M2121-10 Diesel Kiki DKS-16H large plug bolt, Hitachi MJS170 service valve, Mazda hose fitting</p>	 <p>Part # M2114-10 Nissan 92472 N8210, Calsonic A9540 69220 Captive O-Ring</p>	 <p>Part # 568-111-10 Mitsubishi FX80 discharge port, Acura hose fitting, Hitachi A5000 & MJS170 service valve</p>	 <p>Part # 568-105-10 Chrysler, GM, Import (Acura, Toyota, Mazda)</p>
 <p>Part # 568-1124-10 Import condenser, discharge hose, receiver/ drier, expansion valve & evaporator</p>	 <p>Part # 568-906-10 #10 Dual Metric GM</p>	 <p>Part # 568-014-10 #8 Compression Fitting, Mitsubishi FX105V control valve, GM in-line filter</p>	 <p>Part # M2110-10 Metric Fitting O-ring</p>
 <p>Part # M2123-10 Metric No. 10 Springlock, Nippondenso 10PO8E Compressor Inner Manifold O-Ring</p>	 <p>Part # 568-015-10 #10 Hose Fitting, Ford #10 tube & non-metric springlock fitting, Toyota suction line</p>	 <p>Part # 568-125-10 #10 (5/8") Ford Peanut fittings, GM #10 (5/8") metric captured</p>	<p>By applying enough heat, an object can be forced to change its state, from a solid to a liquid to a gas. The same is true in reverse: by removing enough heat, an object can be forced to change states from a gas to a liquid to a solid.</p>

NYLON O-RING PICK













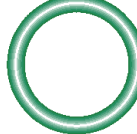
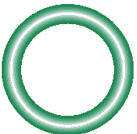

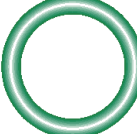

Part # 9411

- Will not scratch metal surfaces which can cause refrigerant leaks

O-RINGS ILLUSTRATED ACTUAL SIZE

O-RINGS... GREEN HNBR

 <p>Part # M2128-10 14MM Block Fitting, Nippon. TV12C / TV14C Block Manifold, Sanden 575 Shaft Seal O-Ring</p>	 <p>Part # M2145-10 No. 12 Metric Dual Fitting, GM 3/4" Dual Metric Connection</p>	 <p>Part # 568-016-10 #12 GM hose fitting, #10 compression fitting, Chrysler 6C17 small control valve port</p>	 <p>Part # 568-2109-10 Metric Nissan Discharge</p>
 <p>Part # 568-112-10 GM DA6, Sanden SD505/507/TR70/TR90 compressor shaft seal head</p>	 <p>Part # M2124-10 Nippondenso 10PA Suction, Evap., 13MM Hose Fitting, Nissan 92473 N8210, Calsonic A9550 69220</p>	 <p>Part # 568-113-10 #12 Captive, GM A6/R4, Sanden SD708/709 compressor shaft seal head, Mitsubishi FX80 suction port</p>	 <p>Part # M2135-10 Metric No. 12 Springlock Hose Fitting</p>
 <p>Part # M2125-10 GM Special #12 Fitting O-ring</p>	 <p>Part # 568-114-10 Mitsubishi FX105V sensor, Keihin 150L/150R shaft seal head</p>	 <p>Part # 568-017-10 #12 Hose Fitting, Nissan 19MM evaporator suction</p>	 <p>Part # M2138-10 Metric 17MM Hose Fitting / Evaporator, Connection</p>
 <p>Part # 568-115-10 Diesel Kiki BH DKS13G discharge port</p>	 <p>Part # 568-018-10 #12 compression fitting, Chrysler 6C17 large control valve port</p>	 <p>Part # 568-019-10 Audi - VW, Seiko Seiki SS170PSS internal rotor</p>	 <p>Part # 568-208-10 Chrysler Expansion Block Valve (Liquid) Hose, Block Fitting</p>

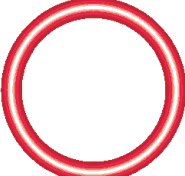

Part # OV116-10
Ford Red Oval O-ring
OEM red HNBR Rubber

**ALL O-RINGS AVAILABLE
IN BULK PACKS OF 1000**

O-RINGS ILLUSTRATED ACTUAL SIZE

O-RINGS... GREEN HNBR

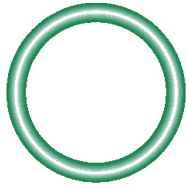

Part # 568-116-10
Ford FS6 suct./discharge, Nippon.
6E/6P compressor
suction/discharge port, Mitsubishi
FX80 lip seal outer

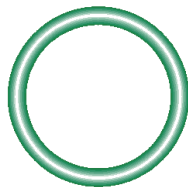

Part # 568-910-10
Ford FS6, Nippon.
suction/discharge,
Chrysler/Jeep filter drier

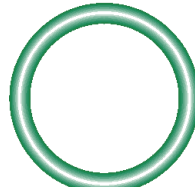

Part # 568-117-10
Ford block exp. Valve, Diesel Kiki
DKS13G compressor suction
service valve

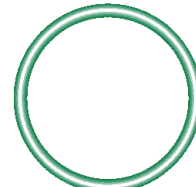

Part # 568-020-10
Ford Expansion Valve, Ford STV
combi. valve



Part # 568-2024-10
Nippon. suction/discharge,
20MM Hose Fitting, Chrysler
metric, Springlock Kit O-ring

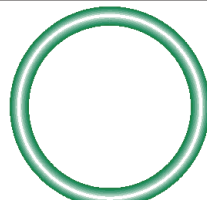

Part # 568-118-10
GM & Chrysler Switch Port,
Seiko Seiki SS170PSS comp
rotor housing

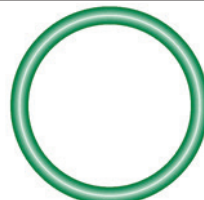

Part # M2142-10
20MM Hose Fitting, Diesel
Kiki CH Suction/DKS-13S Seal
Seat, Sanden Seal Seat

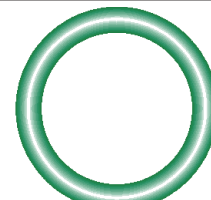

Part # 568-211-10
GM A6, DA6, HR6, V5 service
Valve, Ford FX15/FS10 serv.
valve

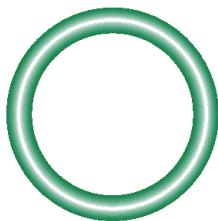

Part # 568-212-10
GM R4 service valve, Chrysler
block expansion valve suction line

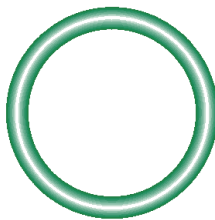

Part # OV211-10
GM Oval O-ring



Part # 568-119-10
Sanden SD708, SD709 Shaft
Seal Seat, Chrysler RV2 Dis.
Muffler

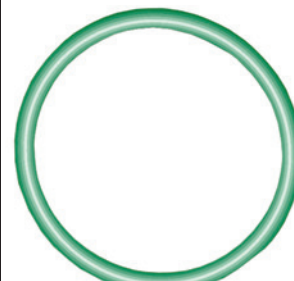

Part # 13548-10
Nihon NVR front rotor body
o-ring (late model)

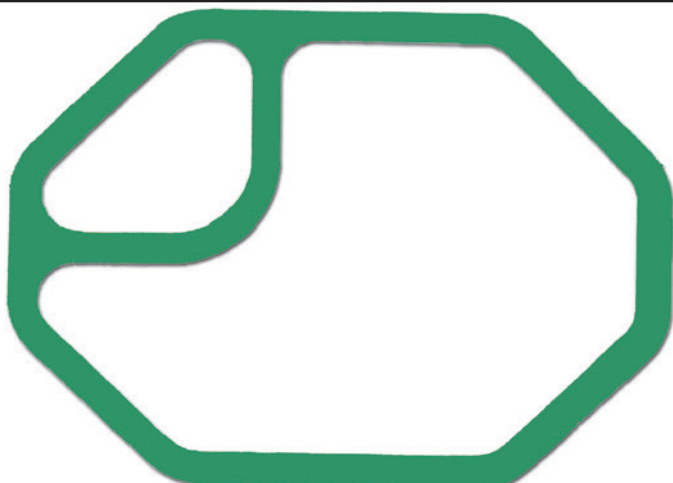





















Part # 568-3106-1
Toyota, Nippondenso
Suction/Discharge
Manifold Gasket

Also available in
Black Neoprene
Part # 568-3106N-1

The most common cause of fitting leaks is improper O-ring installation. Before O-rings are installed they should always be lubricated. Check the fittings before reinstalling them. A damaged or cracked fitting, or even one with a small scratch across the O-ring groove can cause leaks.















O-RINGS ILLUSTRATED ACTUAL SIZE

O-RINGS... BLACK NEOPRENE

 <p>Part # 568-008N-10 GM Capillary Tubelvelve</p>	 <p>Part # 568-010N-10 Nissan hose fitting & drier , #8 Nissan, Nissan 8MM switch, Diesel Kiki DKS16H oil plug</p>	 <p>Part # M2108-10 Metric Orifice Tube, 7MM Hose Fitting</p>	 <p>Part # 568-011N-10 #6 Hose Fitting, Nissan #10 hose fitting/filter dryer, Hyundai #5 springlock</p>
 <p>Part # 568-012N-10 Toyota pressure switch, Mitsubishi FX105V compressor control valve (inner), #6 compression fitting</p>	 <p>Part # 568-013N-10 #8 Hose Fitting, Volvo #8 hose fitting, Mazda #8 springlock fitting, GM V5 control valve, Nissan #12 (20MM) hose fitting</p>	 <p>Part # 568-014N-10 #8 Compression Fitting, Mitsubishi FX105V control valve, GM in-line filter</p>	 <p>Part # 568-015N-10 #10 Hose Fitting, Ford #10 tube & non-metric springlock fitting, Toyota suction line</p>
 <p>Part # 568-017N-10 #12 Hose Fitting, Nissan 19MM evaporator suction</p>	 <p>Part # 568-108N-10 #6 GM captive, Ford combi valve evap. manifold oil bleed line, Ford block exp. valve</p>	 <p>Part # 568-110N-10 #8 GM captive, Chrysler 6C17 large control valve (outer)</p>	 <p>Part # 568-111N-10 Mitsubishi FX80 discharge port, Acura hose fitting, Hitachi A5000 & MJS170 service valve</p>
 <p>Part # 568-112N-10 GM DA6, Sanden SD505/507/TR70/TR90 comp. shaft seal head</p>	 <p>Part # 568-113N-10 #12 Captive, GM A6/R4, Sanden SD708/709 compressor shaft seal head, Mitsubishi FX80 suction port</p>	 <p>Part # 568-115N-10 Diesel Kiki BH DKS13G discharge port</p>	 <p>Part # 568-116N-10 Ford FS6 suct./discharge, Nippon. 6E/6P compressor suction/discharge port, Mitsubishi FX80 lip seal outer</p>
 <p>Part # 568-118N-10 GM & Chrysler Switch Port, Seiko Seiki SS170PSS comp rotor housing</p>	 <p>Part # 568-211N-10 GM A6, DA6, HR6, V5 service Valve, Ford FX15/FS10 serv. valve</p>	 <p>Part # OV211N-10 GM Oval O-ring</p>	 <p>Part # 568-212N-10 GM R4 service valve, Chrysler block expansion valve suction line</p>

O-RINGS ILLUSTRATED ACTUAL SIZE

O-RINGS... BLACK NEOPRENE

 <p>Part # M2109-10 Metric Low Pressure Switch, Pressure Relief Valve, Lower Control Valve</p>	 <p>Part # M2111-10 9MM Captive Hose Fitting, 9MM Condenser, #8 Metric Captive</p>	 <p>Part # M2119-10 GM #10 Metric Captive, #10- 5/8 Metric Captive Type, 12MM Hose Fitting</p>	<div style="border: 1px solid black; padding: 5px;"> <p>“Great Quality ... Great Selection!”</p> <p>Supercool/TSI continues to expand its selection of products. Take a look at the complete program we offer !”</p> </div>
 <p>Part # M2126-10 5/8" Metric O-Ring</p>	 <p>Part # M2147-10 Hitachi Compressor Manifold, 13MM Block TXV, Sensor</p>	 <p>Part # M2130-10 14MM Hose Fitting, Saturn Metric Block Valve Fitting, Suction Fitting</p>	 <p>Part # M2129-10 NISSAN 92475 W2100, CALSONIC A9550 69210, Hitachi Comp. 16MM Flange, Internal Carbon Shaft Seal</p>
 <p>Part # M2133-10 Nippondenso 10P08E Inner Manifold</p>	 <p>Part # M2136-10 GM #12- 3/4 High Stretch Metric, 16MM Hose Fitting</p>	 <p>Part # M2137-10 17MM Hose Fitting, Rotor Vlv, Carbon Seal Head</p>	 <p>Part # M2140-10 Diesel Kiki Dis. Port, Cntrl Vlv Housing, Carbon Seal Head</p>
 <p>Part # M2141-10 Inner Rotor, Audi/VW Valve O-ring, Rotor Manifold</p>	 <p>Part # M2143-10 Diesel Kiki CH Compressor Suction, Diesel Kiki Compressor Suction Port</p>	 <p>Part # M2144-10 Block Fitting, Coil Seal Head</p>	 <p>Part # M2152-10 Ford FS6 suct./discharge, Nippon. 6E/6P compressor suction/discharge port, Mitsubishi FX80 lip seal outer</p>

Elastomer (Seal) Compatibility Defined:

The ability of a lubricant to remain in contact with an elastomer without significantly affecting the chemical and physical properties of either. Immersion tests at elevated temperatures are commonly used to evaluate compatibility. Changes in volume and hardness are most often determined in lubricant laboratories; rubber laboratories usually run additional tests, such as tensile strength and elongation.

MOLDED SEALS... BLACK NEOPRENE

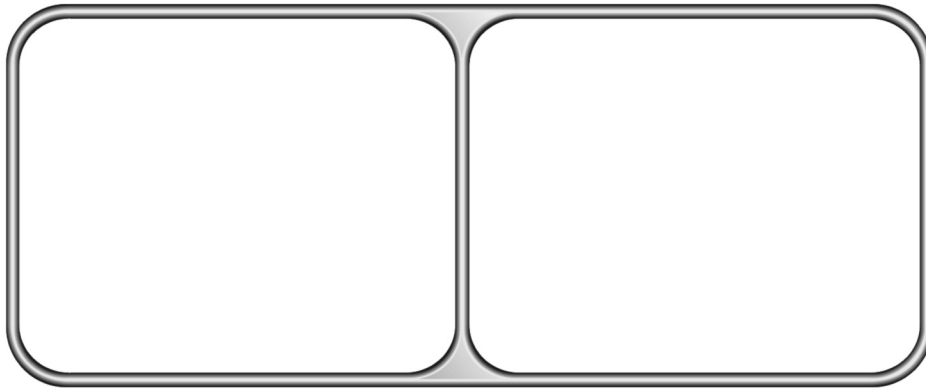

Part # M2151-10
Mitsubishi MSC105CVS Manifold Seal

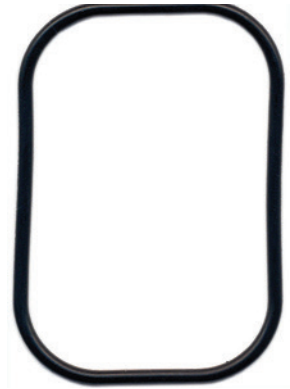

Part # 14507-10
Nippondenso TV Manifold Seal

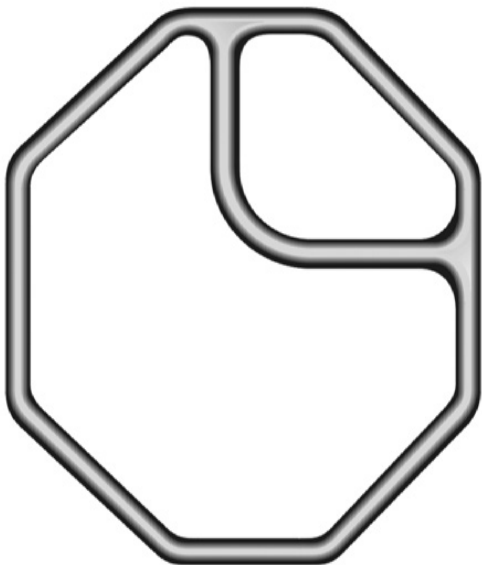

Part #M2153-10
Nippondenso 10PA15C Manifold Gasket
Not Supplied By Dealer

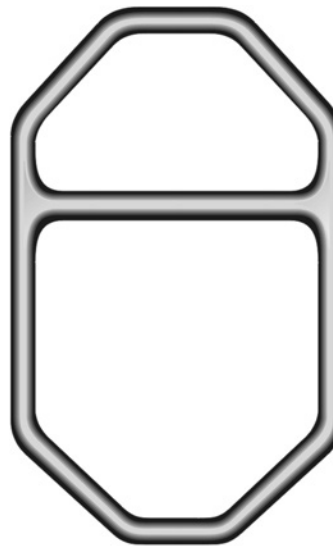

Part # M2149-10
GM & Chrysler Switch Port,
Seiko Seiki SS170PSS comp rotor housing



Part #14514-10
Matsushita NL
Manifold Molded Seal

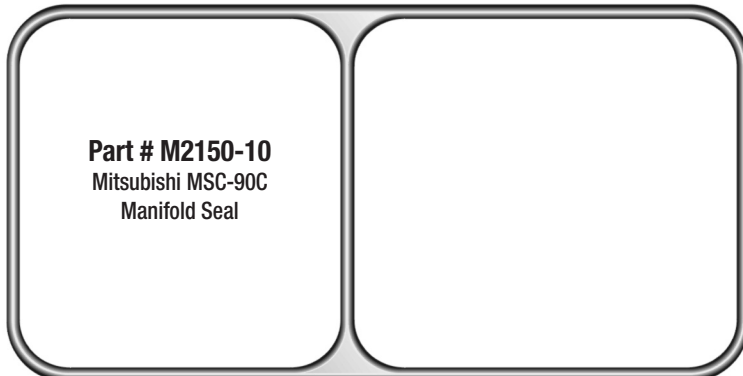













Part # M2150-10
Mitsubishi MSC-90C
Manifold Seal

- Neoprene O-rings may be used with All refrigerant blends.
- Neoprene O-rings are generally not affected by exposure to R22.
- Seals made from HNBR or Nitrile rubber can be damaged when exposed to R22, thus are not recommended for use in other than R134a and R12 systems.
- HNBR = Hydrogenated Acrylonitrile-Butadiene Rubber

O-RINGS ILLUSTRATED ACTUAL SIZE

VOLVO

O-RINGS HNBR

 <p>Part # 13296-10 Volvo 3522587</p>	 <p>Part # M2104-10 Volvo Metric Orifice Tube 3537797</p>	 <p>Part # M2118-10 Volvo No. 6 Hose Fitting 3522588, 3537499</p>	 <p>Part # 13418-10 Volvo 3537201</p>	 <p>Part # M2120-10 Volvo Cycling Pressure Switch</p>
 <p>Part # M2134-10 Volvo No. 10 Hose Fitting</p>	 <p>Part # 13357-10 Volvo 3545628</p>	 <p>Part # M2127-10 Volvo No. 8 Hose Fitting 3537503</p>	 <p>Part #13326-10 Volvo 3545416</p>	
 <p>Part #13371-10 Volvo 1324181</p>	 <p>Part # M2139-10 Volvo No. 12 Hose Fitting / Accumulator</p>	 <p>Part # 13463-10 Volvo 6847526</p>	 <p>Part # 13487-10 Volvo 3537508, 3522592</p>	

COMPRESSOR O-RING 24 PIECE ASSORTMENT

- Used for sealing hoses to the back of compressors
- For Chrysler, Ford and GM vehicles.

Part # OR128 includes:
12) OV116 12) 568-211



SILICONE O-RING LUBRICANT

- Extends O-ring life
- Resists wash-away & moisture
- Withstands high temperatures
- 1000 cSt viscosity lubricant
- Easy to apply, comes in convenient 4 oz. squeeze tip bottle

Part # 26029



O-RING LUBRICANT













- Lubricates O-rings for easier installation
- Helps prevent leaks resulting from Pinched O-rings
- Easy to apply light weight oil comes in convenient 4 oz. squeeze tip bottle

Part # E40

O-RINGS ILLUSTRATED ACTUAL SIZE

AUDI / VW

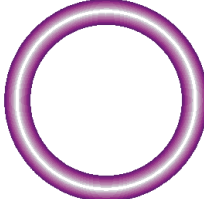











O-RINGS HNBR

 Part # 13302-10 Audi/VW 803-260-749, 803-260-749A, 8A0-260-749AK Ford Europe/UK 95VW-19E715-EA, 391302-S100	 Part # 13432-10 Ford Europe/UK 95VW-19E715-A A Audi/VW 7M0-820-749B	 Part # 13401-10 Audi/VW 8A0-260-749AF	 Part # 13364-10 Ford Europe/UK W702645
 Part # 13319-10 Audi/VW 8A0-260-749AJ, 7M0-820-749C Ford Europe Ford UK 19E715-BA	 Part # 13333-10 Audi/VW 8A0-260-749AH Ford Europe/UK 19E715	 Part # 13456-10 Audi/VW 1H0-820-749H	 Part # 13340-10 Audi/VW 803-260-749C Ford Europe/UK 19E715-DA
 Part # 13470-10 Audi/VW 1J0-820-749B	 Part # 13449-10 Audi/VW 1J0-820-749A	 Part # 13395-10 Audi/VW 701-820-749G	 Part # 13388-10 Audi/VW 400-260-749A

EUROPEAN

DOUBLE AND TUBE O-RINGS

ILLUSTRATED
ACTUAL SIZE

 Part # 16389 #6 Double O-ring Fiat OEM #10551983	 Part # 16396 #8 Double O-ring Fiat OEM #10552083	 Part # 16402 #10 Double O-ring Fiat OEM #10552183	 Part # 16419 #6 Double O-ring Peugeot OEM #6460P0	 Part # 16464 8mm #6 Molded Seal	 Part # 16471 11mm #8 Molded Seal
Citroen, Fiat, Peugeot, Renault, Alfa Romeo, Iveco, Lancia					
 Cross Section Part # 16433 11mm #8 Double O-ring -- Renault	 Cross Section Part # 16440 13mm #10 Double O-ring -- Renault	 Cross Section Part # 16457 16mm #12 Double O-ring -- Renault	 Part # 16426 #8 Double O-ring Peugeot OEM #6460P1	 Part # 16488 14mm #10 Molded Seal	 Part # 16495 17mm #12 Molded Seal

ORIFICE TUBES - ALSO AVAILABLE IN FIVE PACKS



Part # 6-10 10 pc. Pack
Part # 6-1 Single Pack
 Orifice Size: 0.067
 Color: Blue, T-Top • Make: GM



Part # 8-10 10 pc. Pack
Part # 8-1 Single Pack
 Orifice Size: 0.057
 Color: Orange, T-Top • Make: GM



Part # 11-10 10 pc. Pack
Part # 11-1 Single Pack
 Orifice Size: 0.071-0.073
 Color: White or Natural
 Make: AUDI, GM
 Optional VOV Part # V2002



Part # 12-10 10 pc. Pack
Part # 12-1 Single Pack
 Orifice Size: 0.071-0.073
 Color: Black, T-Top • Make: GM
 Optional VOV Part # V2004



Part # 13-10 10 pc. Pack
Part # 13-1 Single Pack
 Orifice Size: 0.062
 Color: Yellow, T-Top • Make: GM



Part # 14-10 10 pc. Pack
Part # 14-1 Single Pack
 Orifice Size: 0.0605-0.0635
 Color: Purple, T-Top
 Make: CHRYSLER, DODGE, JEEP
 Optional VOV Part # V2004



Part # 15-10 10 pc. Pack
Part # 15-1 Single Pack
 Orifice Size: 0.0471+0.01
 Color: Brown • Make: FORD
 Optional VOV Part # V2002



Part # 16-10 10 pc. Pack
Part # 16-1 Single Pack
 Orifice Size: 0.0655-0.0685
 Color: Blue
 Make: FORD, NISSAN, LINCOLN,
 MERCURY, MERKUR
 Optional VOV Part # V200



Part # 17-10 10 pc. Pack
Part # 17-1 Single Pack
 Orifice Size: 0.0605-0.0655
 Color: Red
 Make: FORD, AUDI, LINCOLN,
 MAZDA, MERCURY
 Optional VOV Part # V2002



Part # 18-10 10 pc. Pack
Part # 18-1 Single Pack
 Orifice Size: 0.052 • Color: Green
 Make: FORD, MAZDA, MERCURY



Part # 19-10 10 pc. Pack
Part # 19-1 Single Pack
 Orifice Size: 0.056-0.059
 Color: Orange
 Make: FORD, HYUNDAI, LINCOLN,
 MERCURY
 Optional VOV Part # V2002



Part # 20-10 10 pc. Pack
Part # 20-1 Single Pack
 Orifice Size: 0.072
 Color: Gray and White
 for vehicles with evaporator
 mounted orifice tubes
 Make: AUDI, VOLKSWAGEN
 Optional VOV Part # V2002



Part # 21-10 10 pc. Pack
Part # 21-1 Single Pack
 Orifice Size: 0.072
 Color: Black • Make: Ford

Variable Opening Valve (VOV) "The Hercules of Orifice Tubes"

- Reduce vent temp. 5° - 12°F
- Reduce emissions & improve city fuel economy
- Improve the performance of factory R-134a and retrofitted systems
- Reduce compressor load & extend compressor life



Part # V2002
 Standard Duty VOV is an optional replacement for Blue (Part #16-10), White (Part #11-10), Orange (Part #19-10), Brown (Part #15-10) and Yellow (Part #24-10) Orifice Tubes.



Part # V2003
 Extreme Duty (for climates of 105°F or greater) VOV is an optional replacement for Blue (Part #16-10) and Purple (Part #14-10) Orifice Tubes.



Part # V2004
 Standard Duty (for use in vehicles where orifice tube is located near condenser outlet) VOV is an optional replacement for Black (Part #12-10), White (Part #11-10), Orange (Part #19-10), Brown (Part #15-10) and Yellow (Part #24-10) Orifice Tubes.



Part # 35014
 Color: Black/White
 Make: GM, JEEP



Part # 35229
 Color: Black/White
 Make: AUDI, FORD, GM
 CHRYSLER, VOLVO



Part # 24-10 10 pc. Pack
Part # 24-1 Single Pack
 Orifice Size: 0.062
 Color: Yellow T-Bottom
 for vehicles with evaporator
 mounted orifice tubes
 Make: AUDI, GM, VOLVO
 Optional VOV Part # V2002



Part # 26-10 10 pc. Pack
Part # 26-1 Single Pack
 Orifice Size: 0.057
 Color: Orange, T-Top
 Make: Chrysler



Part # 38-10 10 pc. Pack
Part # 38-1 Single Pack
 Orifice Size: 0.057
 Color: Orange • Make: AUDI



Part # 35021-10 10 pc. Pack
Part # 35021 Single Pack
 Orifice Size: 0.062
 Color: Grey Porous
 Make: GM



Part # 35038-10 10 pc. Pack
Part # 35038 Single Pack
 Orifice Size: 0.057
 Color: Black Porous
 Make: GM

REFILLABLE ORIFICE TUBE ASSORTMENTS



ORIFICE TUBE 15 PIECE ASSORTMENT

Part # 1712

- 6) 11-10 White Orifice Tubes
- 3) 12-10 Black "T-Bottom" Orifice Tubes
- 2) 16-10 Blue Orifice Tubes
- 2) 17-10 Red Orifice Tubes
- 2) 19-10 Orange Orifice Tubes

ORIFICE TUBE 36 PIECE MASTER ASSORTMENT

Part # 61648 Master Assortment
(Expanded coverage over Part# 1729))

- 1) 6-10 Blue "T-Top" Orifice Tube
- 1) 8-10 Orange "T-Top" Orifice Tube
- 5) 11-10 White "T-Bottom" Orifice Tubes
- 4) 12-10 Black "T-Top" Orifice Tubes
- 3) 13-10 Yellow "T-Top" Orifice Tubes
- 1) 14-10 Purple "T-Top" Orifice Tubes
- 1) 15-10 Brown Orifice Tubes
- 3) 16-10 Blue Orifice Tubes
- 4) 17-10 Red Orifice Tubes
- 1) 18-10 Green Orifice Tubes
- 4) 19-10 Orange Orifice Tubes
- 1) 20-10 Gray Orifice Tube
- 2) 21-10 Black Orifice Tubes
- 1) 24-10 Yellow "T-Bottom" Orifice Tube
- 1) 26-10 Orange "T-Top" Orifice Tube
- 1) 38-10 Orange "T-Bottom" Orifice Tube
- 1) 35038 Black Orifice Tube
- 1) 35021 Grey Orifice Tube



REFILL POSTER
available showing complete line of refills.

26 PIECE ORRIFICE TUBE ASSORTMENT
Part # 1729 (covers most vehicles)

DELUXE ORIFICE TUBE SERVICE KIT

Part # 92311

- 5 piece universal kit includes: Auger Point Shaft, Nut & Arbor, GM Puller, Extension, and Orifice Tube Puller
- Removes and installs any style orifice tube
- Comes in custom molded box



SPRING LOCK COUPLINGS & TOOLS



Part # OR60-6-10
#6 Garter Spring



Part # OR60-8-10
#8 Garter Spring



Part # OR60-10-10
#10 Garter Spring



Part # OR60-12-10
#12 Garter Spring



Part # 59651
A/C Spring
Lock Coupling Release Tool
#6 (3/8")



Part # 59652
A/C Spring
Lock Coupling Release Tool
#8 (1/2")



Part # 59653
A/C Spring
Lock Coupling Release Tool
#10 (5/8")



Part # 59654
A/C Spring
Lock Coupling Release Tool
#12 (3/4")



Part # 16866
A/C Spring Lock Clamp
#6 (3/8")



Part # 16868
A/C Spring Lock Clamp
#8 (1/2")



Part # 16870
A/C Spring Lock Clamp
#10 (5/8")



Part # 16872
A/C Spring Lock Clamp
#12 (3/4")

SPRING LOCK TOOL ASSORTMENT

9 Piece Set Includes:

- A/C spring lock tools 3/8", 1/2", 5/8", and 3/4"
- Fuel line spring lock tools 3/8" and 1/2"
- Fuel line quick disconnect tools 5/16" and 3/8"
- Transmission cooler & fuel line disconnect tool

Part # 1219



AC VALVE CORE ASSORTMENT (REFILLABLE)

Part # 2680 (Includes valve core remover)

- | | | |
|---------|--------|--------|
| 22) 672 | 5) 676 | 1) DC |
| 3) 673 | 5) 677 | 1) 674 |

FOR R134a & R12



Part # 672-10
Standard Valve Core



Part # 673-10
GM Late Model
High Flow



Part # 674-10
JRA (Japanese Refrigeration
Association)
High Flow



Part # 675-10
R-134a Hyundai-Kia JRA
Valve Core



Part # 676-10
8mm Low Side



Part # 677-10
10mm High Side



Part # 678-10
R-12 & R-134a M5 Renault Std.
Flow Valve Core



Part # 679-10
R-134a Peugeot / Volvo High Flow
Valve Core



Part # 680-10
OEM Standard Valve Core
Audi, BMW, Mercedes, VW

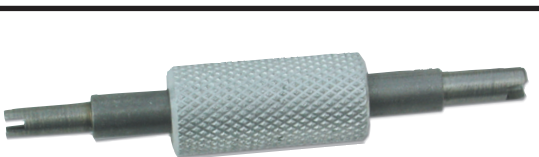

- Part # DC**
- Universal valve core remover
 - Removes and installs all valve cores



- Part # 25879**
- Remove and Install replacement valve cores while system is charged without losing refrigerant charge
 - Fits standard and larger valve cores
 - Services both R134a and R12 High and Low side service ports

A/C CAP & VALVE CORE ASSORTMENT (REFILLABLE)



Part # 611-10
Low Side Blue R-134a 15 mm
Fitting Service Port Cap, 10mm x 1.25

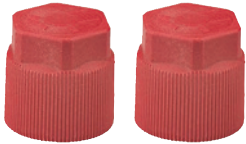

Part # 612-10
High Side Red R-134a 17 mm
Fitting Service Port Cap,
10mm x 1.25

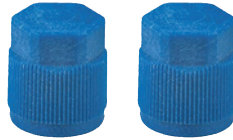

Part # 613-10
Low Side Blue R-134a 15 mm
Fitting Service Port Cap, 9mm x 1



Part # 616-10
High Side Black R-134a 17 mm
Fitting Service Port Cap,
10mm x .75



Part # 619-10
1/2" ACME Replacement Service
Cap for cylinders, equipment, etc.



UNIVERSAL 76 PIECE ASSORTMENT Part # 61655 Includes:

- | | | |
|---------|---------|--------|
| 10) 672 | 5) 673 | 5) 674 |
| 5) 675 | 5) 676 | 4) 621 |
| 5) 677 | 2) 678 | 3) 679 |
| 4) 614 | 4) 615 | 4) 621 |
| 4) 622 | 4) 623 | 4) 624 |
| 4) 618B | 4) 620B | |

Supersedes Part # 13722

REFILL POSTER
available showing complete line of refills.



Part # 618B-10
1/4" R-12 Service Port Cap
Part # 620B-10
3/16" R-12 Service Port Cap

NOTICE: RETROFITTED TO R134a

R134a Refrigerant Amount: _____ lbs. _____ ozs.
Date: _____ Oil Type _____ Amount: _____ ozs.

Dealer Name: _____
Address: _____
City: _____ State: _____ Zip: _____

Sky-blue Mylar R-134a Retrofit Label
Part # 687-10 10 piece pack
Part # 687-1000 1000 piece roll

R134a OCTAGON SERVICE PORT SOCKETS

Part # SS30

- 1/4" Drive for octagon R-134a port adapters
- Removes 602, 603, 604, 606, 608, and 610 service ports
- Includes both low & high side sockets



Part # 614-10
R-134a Blue Low Side Cap
Part # 615-10
R-134a Red High Side Cap



Part # 621-10
JRA Low Side cap
Part # 622-10
JRA High Side cap



Part # 623-10
13MM Aeroquip LS cap
Part # 624-10
16MM Aeroquip HS cap

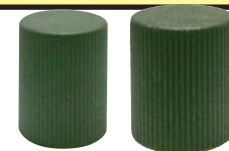

Part # 25442-10
R134a Service Port Cap, Eaton
SSV Low Side M8 x1.0, Black
Part # 25435-10
R134a Service Port Cap Eaton SSV
High Side M10x 0.75, Black

RETROFIT ADAPTERS - ALUMINUM, STEEL & BRASS

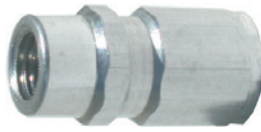

Part # 602-5
Bag of five

R-134a **Aluminum** Straight Low Side Retrofit Adapter (1/4" Flare 7/16" SAE) **With Cap**
Note: Does not contain a valve core only a valve depressor.



Part # 603-5
Bag of five

R-134a **Aluminum** Straight High Side Retrofit Adapter (3/16" Flare 3/8" SAE) **With Cap**



Part # 604-5
Bag of five

R-134a **Aluminum** Straight High Side Retrofit Adapter (1/4" Flare 7/16" SAE) **With Cap**

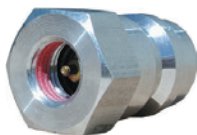

Part # 602S-5
Bag of five

R-134a **Steel** With Valve and Cap Straight Low Side Retrofit Adapter (1/4" Flare 7/16" SAE)



Part # 603S-5
Bag of five

R-134a **Steel** With Valve and Cap Straight High Side Retrofit Adapter (3/16" Flare 3/8" SAE)



Part # 604S-5
Bag of five

R-134a **Steel** With Valve and Cap Straight High Side Retrofit Adapter (1/4" Flare 7/16" SAE)

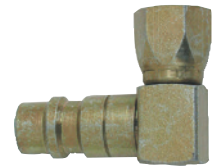

90° Steel Adapters
Include Valve and Cap
Bag of five

Low Side 1/4" **PN: 60290S-5**
High Side 3/16" **PN: 60390S-5**
High Side 1/4" **PN: 60490S-5**

GM RETROFIT KIT



Part # 7653
GM R12 to R134a Retrofit Kit
Includes high and low side R12 to R134a retrofit fittings, valve cores, mylar retrofit warning label, R12 block-off cap and instructions. Retrofits most GM vehicles.

NON-GM RETROFIT KIT



Part # 7646
Non-GM R12 to R134a Retrofit Kit
Includes high and low side R12 to R134a retrofit fittings, valve cores, mylar retrofit warning label, R12 block-off cap and instructions. Retrofits most Non-GM vehicles.

SERVICE PORT REPAIR KIT



Part # 44955
Service Port Repair Kit
For replacing leaking valve cores or tightening valve cores that have become loose. Includes valve core tool, popular replacement valve cores, and low & high side valve caps.

SINGLE APPLICATION RETROFIT KITS

SINGLE APPLICATION 97% COVERAGE RETROFIT KIT

Part # KEB3 Each kit contains:

- 1) 602 1) 603 1) 604
- 1) 8 oz. Ester Oil + U/V Dye
- 1) Retrofit Label and instructions clamshell packed

Part # 6240 - GM '82 & UP

Part # 6242 - FORD '80 & UP

Part # 6243 - CHRYSLER '78 & UP

Part # 6244 - AUDI-FORD-JEEP-MERCEDES-PORSCHE-VOLKSWAGON-VOLVO

Part # 6245 - FORD / MAZDA / NISSAN

Part # 6246 - AUDI-CHRYSLER-FORD-GM-ISUZU-JAGUAR-MERCEDES-VOLVO

Part # 6247 - HONDA/ACURA 76 & UP

Part # 6248 - TOYOTA 73 & UP

Part # 6254 - GM KIT

Part # 6255 - 95% COVERAGE KIT-- Most Vehicles

Part # 6257 - 95% COVERAGE KIT-- Most Vehicles

- Everything necessary to do a complete retrofit in one package
- Except where noted kits contain: adapters, oil, retrofit labels, O-rings, washers, springs and gaskets



MULTI-VEHICLE RETROFIT ASSORTMENTS

Part # 10RA 10 Vehicle Retrofit Assortment

Part # 20RA 20 Vehicle Retrofit Assortment, same as 10RA, but double the quantity

Part # STEEL-10RA 10 Vehicle retrofit assortment with steel high and low side adapters (does not include separate valve cores or 606's)

GM/HARRISON V5 COMPRESSOR CONTROL VALVE

- Without screen for OEM and retrofit R-134a applications
- 3% to 6% better cooling potential when used

Part # 38846



OEM R134a UNIVERSAL SERVICE PORT & CAP ASSORTMENT (REFILLABLE)

Part # 13692 Includes:

- 2) 13258-5 Low side M13 x 1 thread R134a Primary Seal
- 2) 623-10 Blue Low side Cap
- 2) 13265-5 High side M15 x 1 thread R134a Primary Seal
- 2) 624-10 Red High side Cap
- 2) 608-5 Low side M10 x 1.5 thread R134a Primary Seal
- 2) 614-10 Blue Low side Cap
- 2) 610-5 High side M12 x 1.5 thread R134a Primary Seal
- 2) 615-10 Red High side Cap

FACTORY OEM R134a SERVICE PORTS ARE A MAJOR SOURCE OF LEAKS

OEM R-134a (608, 610 and Aeroquip style high and low side) primary seals are a major source of R134a refrigerant leaks due to their use of EPDM rubber ball valves that wear-out over time and leak refrigerant. Always make sure to use and securely tighten the caps with these types of service ports when you replace them.



Factory OE Style R134a Low Side Primary Seal Fitting with female threads for Ford

Use to replace factory installed R134a low side fitting when leaking. M10 x 1.25 thread, uses 614-10 cap. Install or remove with Part # SS30

Part # 608-5 Aluminum, bag of 5

Part # 608-1 Aluminum, single pack



Factory OE Style R134a High Side Primary Seal Fitting for Chrysler, Ford, and GM

Use to replace the factory installed R134a high side fitting when leaking. M12 x 1.5 thread, uses 615-10 cap. Install or remove with Part # SS30

Part # 610-5 Aluminum, bag of 5

Part # 610-1 Aluminum, single pack



Aeroquip OE Style R134a Low Side Service Port

M13 x 1 thread -- takes 623-10 cap used on Ford, Chrysler and Jeep vehicles

Part # 13258-5 Aluminum, bag of 5

Part # 13258-1 Aluminum, single pack

Part # 13272-5 Steel, bag of 5

Part # 13272-1 Steel, single pack



Aeroquip OE Style R134a High Side Service Port

M15 x 1 thread -- takes 624-10 cap used on Ford, Chrysler and Jeep vehicles

Part # 13265-5 Aluminum, bag of 5

Part # 13265-1 Aluminum, single pack

Part # 13289-5 Steel, bag of 5

Part # 13289-1 Steel, single pack

NOW AVAILABLE!

WASHERS



Part # 25251

Ford Compressor Suction Sealing Washer & O-Ring
Crossover: FJC-4389



Part # 25244

Ford Compressor Discharge Sealing Washer & O-Ring
Crossover: FJC-4388



Part # 25343

Chrysler Slim Line 11mm Sealing Washer Red
Crossover: 4S-24237
Chrysler OE 5140443AA

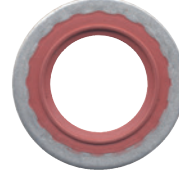

Part # 25329

Chrysler Slim Line 13mm Sealing Washer Red
Crossover: 4S-24232
Chrysler OE 5096243AA

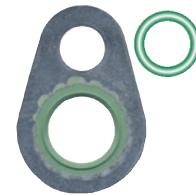

Part # 25237

Chrysler Compressor Suction Sealing Washer & O-Ring
FJC-4385

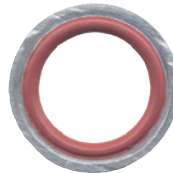

Part # 25312

Chrysler Slim Line 15mm Sealing Washer Red
Crossover: 4S-24230
Chrysler OE 5103427AA



Part # 25190

Hook Sealing Washer Sanden Suction Port
Crossover: 4S-24067, FJC-4054



Part # 25183

Hook Sealing Washer Sanden Discharge Port
Crossover: 4S-24066, FJC-4053

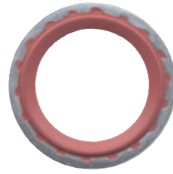

Part # 25336

Chrysler Slim Line 17mm Sealing Washer Red
Crossover: 4S-24233
Chrysler OE 5140444AA

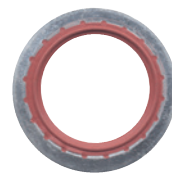

Part # 25527

Chrysler Slim Line 20mm Sealing Washer Red
Crossover: 4S-24239
Chrysler OE 5096242AA

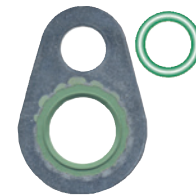

Part # 25220

Chrysler Compressor Discharge Sealing Washer & O-Ring
FJC-4384

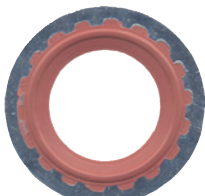

Part # 25381

Stat-O-Seal #12 Red Compressor Suction/Discharge
4S-24238
Freightliner OE 23-13205-000



Part # 25350

Stat-O-Seal #6 Red
4S-24240
Freightliner OE 23-13201-000

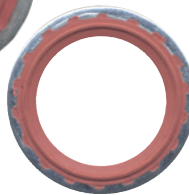

Part # 25398

Stat-O-Seal #12 Red Evaporator
4S -- 24234
Freightliner OE 23-13204-000

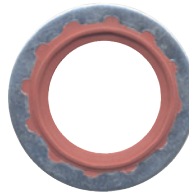

Part # 25367

Stat-O-Seal #8 Red Condenser TXV
4S-24236
Freightliner OE 23-13202-000

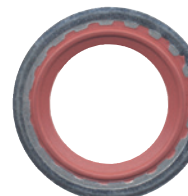

Part # 25374

Stat-O-Seal #10 Red Evaporator
4S-24231
Freightliner OE 23-13203-000



Part # 25213

Navistar Truck Discharge Sealing Washer & O-Ring
FJC-4382



Part # 25473

Tear Drop Sealing Washer
8.93mm 4S-24242
IHC OE 3543881-C1



Part # 25480

Tear Drop Sealing Washer
10.24mm
4S-24243



Part # 25497

Freightliner #6 Slim Line Seal
4S-24246 Freightliner OE
ABPN83 312076



Part # 25503

Freightliner #8 Slim Line Seal
4S-24245 Freightliner OE
ABPN83 312060



Part # 25510

Freightliner #10 Slim Line Seal
4S-24244 Freightliner OE
ABPN83 312092

HEAVY DUTY TRUCK SEALING WASHER KIT



FREIGHTLINER / HEAVY DUTY TRUCK SEALING WASHERS

Kit contains 5 each of the following part numbers:

- 25350 #6 Stato Seal ID 8.15 mm, Thick 1.9 mm ABP/N83-312366
- 25367 #8 Stato Seal ID 11.23 mm, Thick 1.9 mm ABP/N83-312368
- 25374 #10 Evap Stato ID 14.22 mm, Thick 1.9 mm ABP-N83-312200
- 25398 #12 Stato Seal ID 17.27 mm, Thick 1.9 mm 23-13204-000
- 25381 #12 Compr. ID 15.37 mm, Thick 1.9 mm ABP/N83-312372
- 25497 #6 Slim Line ID 8.15 mm, Thick 1.8 mm ABP/N83-312076
- 25503 #8 Slim Line ID 11.34 mm, Thick 1.8 mm ABP/N83-312060
- 25510 #10 Slim Line ID 13.86 mm, Thick 1.8 mm ABP/N83-312092

Part # 61983

COMPRESSOR WASHERS

Part # 9206 GM
Sealing Washer Kit
Contains 1) 639 and 1) 640
DELCO: 15-2723

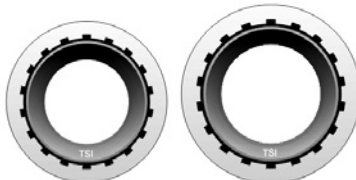

Part # 9213 GM
Sealing Washer Kit
Contains 2) 638 and 2) 641
DELCO: 15-2721



Part # 9220 GM
Sealing Washer Kit
Contains 2) 639
DELCO: 15-2722

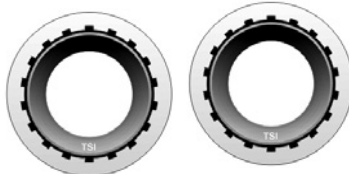

Part # 9237 GM
Sealing Washer Kit
Contains 2) 638
DELCO: 15-2720

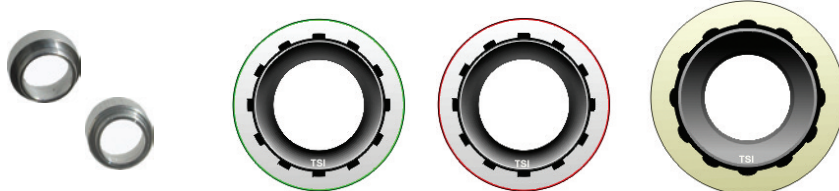

Part # 9251 GM
Sealing Washer Kit Contains:
1) 641 1) 763
1) 760 1) 761
1) 762
GM: 2724887

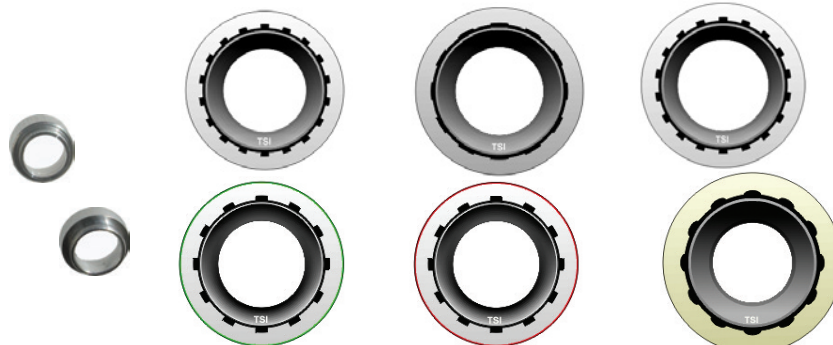

Part # 9510 GM
Sealing Washer Kit
Contains:
1) 641 1) 763
1) 638 1) 639
1) 640 1) 760
1) 761 1) 762

STANDARD SEALING
WASHERS TO INSTALL MOST
GM COMPRESSORS

COMPRESSOR WASHERS & "SLIM LINE" WASHERS

"Slim Line" Sealing Washer Assortment (20 pieces)

Part # 13708

- 5) 887 5) 889
- 5) 888 5) 890



Master Sealing Washer Assortment (48 pieces)

Part # 13715

- 4) 638 4) 640 4) 761 4) 641
- 4) 887 4) 889 4) 639 4) 760
- 4) 762 4) 763 4) 888 4) 890



GM COMPRESSOR SEALING WASHER ASSORTMENTS (REFILLABLE)

Top 3 GM Sealing Washer Assortment (24 pieces)

Part # GM294

- 6) 638 6) 639
- 6) 640 6) 641

GM Sealing Washer Assortment (24 pieces)

Part # GM501

- 4) 638 4) 639 4) 640
- 4) 760 4) 761 4) 762

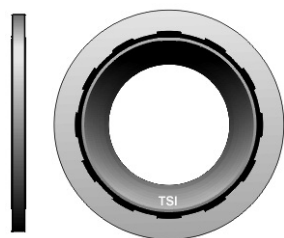

Part # 638-10
5/8" Thick Black

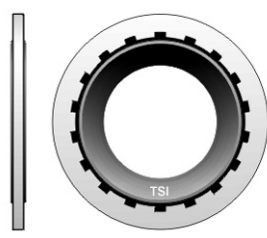

Part # 639-10
5/8" Thin Silver

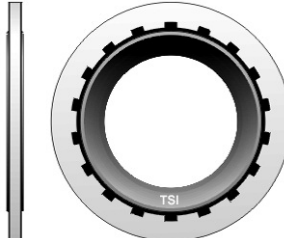

Part # 640-10
3/4" Thin Silver

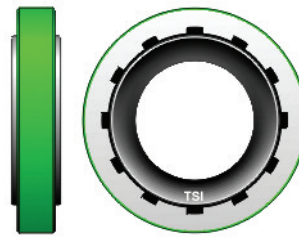

Part # 760-10
5/8" Thick Green

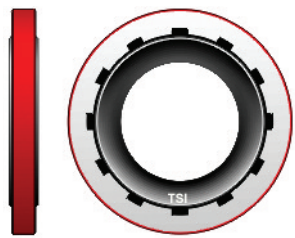

Part # 761-10
5/8" Thick Red

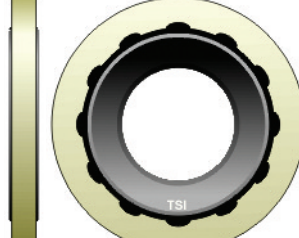

Part # 762-10
5/8" Thick -- Yellow



Part # 510-S-10
A6 / R4 Compressor Locknut



Part # 641-10
GM short manifold pilot insert



Part # 514-10
FS6 / C171 Compressor Clutch Nut



Part # 763-10
GM long manifold pilot insert



Part # 887-10
8mm GM Block Fitting
"Slim Line"



Part # 888-10
11mm GM Block Fitting
"Slim Line"



Part # 889-10
15mm GM Block Fitting
"Slim Line"



Part # 890-10
17mm GM Block Fitting
"Slim Line"

METAL GASKETS



Part # 15153-10
Chrysler / Nippondenso 10S Discharge Port



Part # 15160-10
Chrysler / Nippondenso 10S Suction Port



Part # 15177-10
Chrysler 5/8" KJ Hose Fitting



Part # 15184-10
Chrysler 3/8" LX Drier / Liquid Line



Part # 420F-10
Foamet® Style
for better leak prevention



Part # 426F-10
Foamet® Style
for better leak prevention



Part # 414-10
RV2 Suction Port



Part # 418-10
RV2 Discharge Port



Part # 420-10
Manifold to Expansion Valve



Part # 422-10
Condenser Manifold



Part # 426-10
Expansion Valve to Evaporator

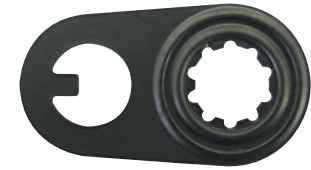

Part # 428-10
Drier Block Bolt (.437)



Part # 429-10
6C17 Suction Port



Part # 430-10
A590 / C171 Suction / Discharge Port



Part # 448-10
Suction Line



Part # 449-10
6C17 Discharge Port



Part # 464-10
Drier Block Bolt (.377)

"Great Quality ... Great Selection!"

Supercool/TSI continues to expand its selection of products. Recently new items have been added. Be sure to take a look at the complete program we offer!"

METAL GASKETS

Keys and Shims



















SUPERCOOL - TRUSTED BY PROFESSIONALS

CHRYSLER METAL GASKET 42 PIECE ASSORTMENT (REFILLABLE)

Part # 286 includes:

- | | | | |
|------------|--------|--------|--------|
| 3) 568-012 | 3) 422 | 3) 429 | 3) 448 |
| 6) 568-211 | 3) 426 | 6) 430 | 6) 449 |
| 3) 420 | 6) 428 | | |



A/C Systems are divided into a High side and a Low side In an orifice tube system the high side begins at the compressor, continues through the condenser, and ends at the orifice tube. The low side begins where the high side ended -- at the orifice tube. From there it continues through the evaporator, through the accumulator, and again ends at the compressor.

PROFESSIONAL AND RETAIL



Dimensions

36" Long x 24" Wide x 48" High

**Retail
Program?
WE HAVE IT!**

**Professional
Program?
WE HAVE IT!**

**Need A Combination of the two?
WE HAVE IT!**

Quality Products...Great Service!

**CAN BE
MODIFIED TO FIT
YOUR NEEDS!**

PLANOGRAM PROGRAMS



Option A
3 Foot End Cap / 3 Foot In-Line



Option B



Option C



Option D

SALES KIT

MUST HAVE TOOL FOR THE EFFECTIVE SALESMAN!



- Convenient kit, proven to increase sales!
- Perfect for one-on-one customer presentations -- allows salesman to show actual samples of some of our Top Selling Products

INCLUDES A2005 A/C MAINTENANCE ASSORTMENT

- O-rings
- Adapters
- Gaskets
- Washers
- & More

- 1) A2005 -- A/C Maintenance Assortment
- 1) E32 -- Ester Oil with U/V Dye Quart
- 1) P100-32D -- PAG 100 with U/V Dye Quart
- 1) FFQ -- Fast Flush Qt.
- 1) 22779 -- Flash Flush Gallon
- 1) 27408 -- High Powered LED U/V Light in Clamshell
- 1) 52486 -- R134a Plus 19 oz with Application Hose in Box
- 1) 39241 -- HFC Free Total Leak Stop with Patented Delivery System
- 1) 6984 -- Evaporator Odor Eliminator with Application Hose 17 oz
- 1) PB8 -- PAG Blue Universal Synthetic R134a Lubricant
- 1) 27002 -- Odor Buster Auto Fogger / New Car Scent
- 1) 22816 -- SAE Certified U/V Dye for A/C Systems in 8 oz Bottle
- 1) P46-8 -- PAG 46 R134a Lubricant 8 oz
- 1) 24940 -- Premium Hybrid A/C Compressor Oil 7 oz
- 1) 27262 -- HFO-1234yf PAG 46 Lubricant 8 oz
- 1) STOPA -- Seal Leak Stop with U/V Dye 4 oz
- 1) E115 -- R134a Oil Charge with U/V Dye 4 oz
- 1) 26203 -- Syringe Application Hose in Clamshell
- 1) 1/4 oz U/V Dye Syringe
- 1) 1/4 oz Seal Leak Stop Syringe
- 5) Catalogs (current version)
- 2) 27644 -- Oring Refill Poster (see page 48 for poster)



Part # 7592-18

Kit Dimensions 19.5"L x 17"W x 12.75"H

"OFFICIAL" MACS SHOW SUPERCOOL T-SHIRTS

TAKE A RIDE ON THE COOL SIDE!



RED, WHITE AND COOL



CATCH THE COOL



XTREME COOL



WE'LL KEEP YOU COOL



THE NEXT GENERATION



NOT JUST COOL



AMERICA'S COOLEST



COOL CARS



MY OTHER CAR!



PART #	PAGE #	PART #	PAGE #	PART #	PAGE #	PART #	PAGE #
AB6-5	----- 43	E115	----- 5	M2122-10	----- 68	OR429	----- 65
AB8-5	----- 43	E127	----- 12	M2123-10	----- 69	OR701	----- 65
AB10-5	----- 43	E128	----- 12	M2124-10	----- 70	OR866	----- 58
AB12-5	----- 43	FB2	----- 25	M2125-10	----- 70	OR2000	----- 67
ACHR	----- 44	FFG	----- 8	M2126-10	----- 73	OV116-10	----- 70
A2005	----- 53	FFG	----- 24	M2127-10	----- 75	OV211-10	----- 71
A2005HD	----- 54	FFQ	----- 8	M2128-10	----- 70	OV211N-10	----- 72
A2007	----- 54	FFQ	----- 24	M2129-10	----- 73	PB8	----- 10
A2016	----- 51	FLGN	----- 8	M2130-10	----- 73	PB32	----- 10
A2016-Box 1	----- 52	FLGN	----- 25	M2133-10	----- 73	P46-8	----- 10
A2016-Box 2	----- 52	F6-5	----- 43	M2134-10	----- 75	P46-8D	----- 10
A2016-Box 3	----- 52	F8-5	----- 43	M2135-10	----- 70	P46-8DPE	----- 11
A2016-Box 4	----- 52	F10-5	----- 43	M2136-10	----- 73	P46-8PE	----- 11
A2016-Box 5	----- 52	F12-5	----- 43	M2137-10	----- 73	P46-32	----- 10
A2016-Box 6	----- 52	GM294	----- 87	M2138-10	----- 70	P46-32D	----- 10
A2016-Box 7	----- 52	GM501	----- 87	M2139-10	----- 75	P46-32DPE	----- 11
A2016-Box 8	----- 52	GYBH6	----- 44	M2140-10	----- 73	P46-32PE	----- 11
BOR105	----- 66	GYBH8	----- 44	M2141-10	----- 73	P46-128	----- 10
DC	----- 80	GYBH10	----- 44	M2142-10	----- 71	P46-128D	----- 10
DD	----- 42	GYBH12	----- 44	M2143-10	----- 73	P100-8	----- 10
D1-12	----- 16	HFO-1234yf-10	----- 7	M2144-10	----- 73	P100-8D	----- 10
D4	----- 16	KEB3	----- 83	M2145-10	----- 70	P100-8DPE	----- 11
D8	----- 16, 17	M782	----- 42	M2147-10	----- 73	P100-8PE	----- 11
D16	----- 16	M2102-10	----- 68	M2148-10	----- 68	P100-32	----- 10
D32	----- 16	M2103-10	----- 68	M2149-10	----- 74	P100-32D	----- 10
D440A	----- 30	M2104-10	----- 75	M2150-10	----- 74	P100-32DPE	----- 11
D440A-C	----- 30	M2105-10	----- 68	M2151-10	----- 74	P100-32PE	----- 11
D440A-UV	----- 30	M2106-10	----- 68	M2152-10	----- 73	P100-128	----- 10
D640	----- 29	M2107-10	----- 68	M2153-10	----- 74	P100-128D	----- 10
EFG	----- 24	M2108-10	----- 72	MO-500-GM	----- 12	P150-8	----- 10
EFG2	----- 24	M2109-10	----- 73	MO-500-GM-128P	----- 12	P150-8D	----- 10
EFQ	----- 24	M2110-10	----- 69	NT-4	----- 42	P150-8DPE	----- 11
EFQ2	----- 24	M2111-10	----- 73	OR60	----- 59	P150-8PE	----- 11
E7	----- 12	M2112-10	----- 68	OR60-6-10	----- 79	P150-32	----- 10
E7-PE	----- 11	M2113-10	----- 68	OR60-8-10	----- 79	P150-32D	----- 10
E8	----- 12	M2114-10	----- 69	OR60-10-10	----- 79	P150-32DPE	----- 11
E8-DPE	----- 11	M2115-10	----- 68	OR60-12-10	----- 79	P150-32PE	----- 11
E31	----- 12	M2116-10	----- 69	OR105	----- 66	P150-128	----- 10
E31-PE	----- 11	M2118-10	----- 75	OR128	----- 75	P150-128D	----- 10
E32	----- 12	M2119-10	----- 73	OR173	----- 60	QC134	----- 21
E32-DPE	----- 11	M2120-10	----- 75	OR200	----- 66	RD8	----- 17
E40	----- 75	M2121-10	----- 69	OR350	----- 65	SB6-5	----- 43

PART #	PAGE #	PART #	PAGE #	PART #	PAGE #	PART #	PAGE #
SB8-5	----- 43	19-10	----- 77	568-008-10	----- 68	568-125-10	----- 69
SB12-5	----- 43	20-1	----- 77	568-008N-10	----- 72	568-2024-10	----- 71
SCABC-25	----- 26	20-10	----- 77	568-009-10	----- 68	568-208-10	----- 70
SLAB-10	----- 14	20RA	----- 83	568-010-10	----- 68	568-2109-10	----- 70
SLAB-500	----- 14	21-1	----- 77	568-010N-10	----- 72	568-211-10	----- 71
SS30	----- 81	21-10	----- 77	568-011-10	----- 68	568-211N-10	----- 72
ST8	----- 14	24-1	----- 77	568-011N-10	----- 72	568-212-10	----- 71
ST22	----- 8, 13	24-10	----- 77	568-012-10	----- 68	568-212N-10	----- 72
ST27	----- 5, 13	24-1496	----- 25	568-012N-10	----- 72	568-3106-1	----- 71
STEEL-10RA	----- 83	26-1	----- 77	568-013-10	----- 69	568-3106N-1	----- 71
STOP	----- 14	26-10	----- 77	568-013N-10	----- 72	568-901-10	----- 68
STOPA	----- 5, 14	38-1	----- 77	568-014-10	----- 69	568-902-10	----- 68
T101	----- 37	38-10	----- 77	568-014N-10	----- 72	568-903-10	----- 68
TD8	----- 17	42-106	----- 43	568-015-10	----- 69	568-904-10	----- 68
VF32	----- 43	42-108	----- 43	568-015N-10	----- 72	568-905-10	----- 69
V32	----- 39	42-110	----- 43	568-016-10	----- 70	568-906-10	----- 69
V128	----- 39	42-112	----- 43	568-017-10	----- 70	568-910-10	----- 71
V2002	----- 77	42-206	----- 43	568-017N-10	----- 72	602-5	----- 82
V2003	----- 77	42-208	----- 43	568-018-10	----- 70	602S-5	----- 82
V2004	----- 77	42-210	----- 43	568-019-10	----- 70	603-5	----- 82
6-1	----- 77	42-212	----- 43	568-020-10	----- 71	603S-5	----- 82
6-10	----- 77	66	----- 33	568-105-10	----- 69	604-5	----- 82
8-1	----- 77	110-10	----- 35	568-108-10	----- 68	604S-5	----- 82
8-10	----- 77	286	----- 58, 89	568-108N-10	----- 72	608-1	----- 84
10RA	----- 83	401	----- 4, 35	568-110-10	----- 69	608-5	----- 84
11-1	----- 77	402	----- 4, 35	568-110N-10	----- 72	610-1	----- 84
11-10	----- 77	401P	----- 4	568-111-10	----- 69	610-5	----- 84
12-1	----- 77	414-10	----- 88	568-111N-10	----- 72	611-10	----- 81
12-10	----- 77	418-10	----- 88	568-112-10	----- 70	612-10	----- 81
13-1	----- 77	420-10	----- 88	568-1124-10	----- 69	613-10	----- 81
13-10	----- 77	420F-10	----- 88	568-112N-10	----- 72	614-10	----- 81
14-1	----- 77	422-10	----- 88	568-113-10	----- 70	615-10	----- 81
14-10	----- 77	426-10	----- 88	568-113N-10	----- 72	616-10	----- 81
15-1	----- 77	426F-10	----- 88	568-114-10	----- 70	618B-10	----- 81
15-10	----- 77	428-10	----- 88	568-115-10	----- 70	619-10	----- 81
16-1	----- 77	429-10	----- 88	568-115N-10	----- 72	620B-10	----- 81
16-10	----- 77	430-10	----- 88	568-116-10	----- 71	621-10	----- 81
17-1	----- 77	448-10	----- 88	568-116N-10	----- 72	622-10	----- 81
17-10	----- 77	449-10	----- 88	568-117-10	----- 71	623-10	----- 81
18-1	----- 77	464-10	----- 88	568-118-10	----- 71	624-10	----- 81
18-10	----- 77	510-S-10	----- 87	568-118N-10	----- 72	638-10	----- 87
19-1	----- 77	514-10	----- 87	568-119-10	----- 71	639-10	----- 87

INDEX

TSI Part Number

SUPERCOOL - TRUSTED BY PROFESSIONALS

PART #	PAGE #	PART #	PAGE #	PART #	PAGE #	PART #	PAGE #
640-10	----- 87	2014-10	----- 89	7059	----- 57	9404	----- 42
641-10	----- 87	2015-10	----- 89	7066	----- 57	9411	----- 69
672-10	----- 80	2016-10	----- 89	7073	----- 67	9428	----- 36
673-10	----- 80	2017-10	----- 89	7080	----- 58	9473	----- 5
674-10	----- 80	2018-10	----- 89	7097	----- 58	9497	----- 16, 17
675-10	----- 80	2019-10	----- 89	7103	----- 59	9497CS	----- 17
676-10	----- 80	2211B	----- 33	7110	----- 59	9503	----- 27
677-10	----- 80	3700A	----- 41	7127	----- 60	9510	----- 86
678-10	----- 80	3700D	----- 41	7134	----- 60	9900	----- 44
679-10	----- 80	4391	----- 67	7141	----- 61	9925	----- 42
680-10	----- 80	4392	----- 67	7158	----- 61	9947	----- 90
687-10	----- 81	4393	----- 67	7165	----- 61	10059	----- 59
687-1000	----- 81	4394	----- 67	7172	----- 62	11012	----- 43
760-10	----- 87	4395	----- 67	7189	----- 62	11068	----- 43
761-10	----- 87	4396	----- 67	7196	----- 62	12503	----- 25
762-10	----- 87	4397	----- 67	7202	----- 63	12848	----- 28
763-10	----- 87	4420	----- 36	7219	----- 63	12855	----- 28
887-10	----- 87	6005	----- 34	7226	----- 63	12886	----- 28
888-10	----- 87	6006	----- 34	7233	----- 64	12978	----- 28
889-10	----- 87	6009	----- 34	7240	----- 64	13051	----- 32
890-10	----- 87	6010	----- 34	7257	----- 64	13057	----- 32
1219	----- 79	6011	----- 34	7264	----- 64	13104	----- 42
1302	----- 7	6012	----- 34	7295	----- 5	13128	----- 26
1712	----- 78	6013	----- 34	7301	----- 20	13258-1	----- 84
1729	----- 78	6014	----- 34	7363	----- 41	13258-5	----- 84
1767	----- 33	6015	----- 34	7370	----- 20	13265-1	----- 84
2375	----- 35	6018	----- 34	7387	----- 20	13265-5	----- 84
2680	----- 80	6240	----- 83	7400	----- 16	13272-1	----- 84
3754	----- 16, 17	6242	----- 83	7400	----- 18	13272-5	----- 84
2001-10	----- 89	6243	----- 83	7554	----- 5	13289-1	----- 84
2002-10	----- 89	6244	----- 83	7561	----- 5	13289-5	----- 84
2003-10	----- 89	6245	----- 83	7592-18	----- 93	13296-10	----- 75
2004-10	----- 89	6246	----- 83	7646	----- 82	13302-10	----- 76
2005-10	----- 89	6247	----- 83	7653	----- 82	13319-10	----- 76
2006-10	----- 89	6248	----- 83	8186	----- 16	13326-10	----- 75
2008-10	----- 89	6254	----- 83	9206	----- 86	13333-10	----- 76
2009-10	----- 89	6255	----- 83	9213	----- 86	13340-10	----- 76
2010-10	----- 89	6257	----- 83	9220	----- 86	13357-10	----- 75
2011-10	----- 89	6984	----- 28	9237	----- 86	13364-10	----- 76
2012-10	----- 89	7035	----- 57	9251	----- 86	13371-10	----- 75
2013-10	----- 89	7042	----- 57	9336	----- 19	13388-10	----- 76

PART #	PAGE #	PART #	PART #	PAGE #	PAGE #	PART #	PAGE #
13395-10	76	16402	55, 76	22793	33	25497	85
13401-10	76	16419	55, 76	22809	33	25503	85
13418-10	75	16426	55, 76	22816	8, 15	25510	85
13425	33, 34	16433	55, 76	22854	37	25527	85
13432-10	76	16440	55, 76	22878	13	25879	80
13449-10	76	16457	55, 76	24025	18	26029	75
13456-10	76	16464	55, 76	24049	3	26148	46
13463-10	75	16471	55, 76	24056	8, 15	26203	15, 21
13470-10	76	16488	55, 76	24087	5, 14	26296	27
13487-10	75	16495	55, 76	24261	5	26388	46
13494	59	16525	17	24278	5	26395	46
13517	36	16525CS	17	24353	19	26401	46
13548-10	35	16532	17	24360	18	26418	46
13630	90	16532CS	17	24414	18	26425	46
13647	38	16600	6	24445	15	26432	46
13654	38	16866	79	24452	15, 18	26449	46
13661	38	16868	79	24940	9	26456	46
13692	84	16870	79	24946	34	26463	47
13708	87	16872	79	25145	12	26470	47
13715	87	17690	56	25183	85	26487	47
13722	81	17706	55	25190	85	26494	47
13791	6	17707	55	25213	85	26500	47
14118	26	17805	36	25220	85	26517	47
14330	56	18239	55	25237	85	26524	47
14347	56	18406	37	25244	85	26531	47
14507-10	74	18413	37	25251	85	26548	48
14514-10	74	18420	37	25251	85	26555	48
15153-10	88	20959	45	25312	85	26562	48
15160-10	88	20966	45	25329	85	26579	48
15177-10	88	20973	45	25336	85	26586	48
15184-10	88	20980	45	25343	85	26593	48
15290	35	20997	45	25350	85	26609	48
15320	35	21000	45	25367	85	26616	48
15597	26	21014	45	25374	85	26623	48
15603	26	21017	45	25381	85	26630	49
15702	56	21048	45	25398	85	26647	49
15924	90	21758	43	25411	12	26654	49
16129	6	22663	33	25435-10	81	26661	49
16310	6	22700	32, 42	25442-10	81	26678	49
16389	55, 76	22762	8, 24	25473	85	26685	49
16396	55, 76	22779	8, 24	25480	85	26692	49

PART #	PAGE #	PART #	PAGE #	PART #	PAGE #	PART #	PAGE #
26708	----- 49	27972	----- 15, 21	41145	----- 6	62911	----- 22
26715	----- 49	28061	----- 27	41275	----- 3, 35	62928	----- 22
26722	----- 49	28184	----- 23	42432	----- 7	62935	----- 21
26739	----- 49	28221	----- 31	42449	----- 7	63659	----- 6
26746	----- 49	33003	----- 8, 15	42432D	----- 7	64687	----- 32
26753	----- 50	33003CS	----- 15	42449D	----- 7	64714	----- 29
26760	----- 50	33430	----- 15	43279	----- 39	64731	----- 21
26777	----- 50	33713	----- 39	43286	----- 39	64779	----- 28
26784	----- 50	33812	----- 6	43460	----- 9	64861	----- 7,9
26807	----- 19	33911	----- 14	44313	----- 38	64892	----- 28
26814	----- 50	34412	----- 32, 34	44955	----- 82	64908	----- 28
26838	----- 50	34413	----- 34	44986	----- 40	64915	----- 28
26845	----- 50	34697	----- 15, 21	48007	----- 9, 37	67502	----- 26
26852	----- 50	35014	----- 77	48267	----- 14	67504	----- 26
26890	----- 9, 34	35021-1	----- 77	48441	----- 39	67506	----- 26
26906	----- 9, 34	35021-10	----- 77	48663-32	----- 7	67508	----- 26
26913	----- 27	35038-1	----- 77	48663-32D	----- 7	67510	----- 26
27002	----- 27	35038-10	----- 77	49006	----- 32	67512	----- 26
27125	----- 15, 21	35229	----- 77	49363	----- 3	67514	----- 26
27132	----- 15, 21	37124	----- 22	50125	----- 40	67516	----- 26
27156	----- 6, 21	37391	----- 6, 21	50130	----- 9	67518	----- 26
27170	----- 22	37414	----- 6, 22	51205	----- 4	67520	----- 26
27187	----- 6, 22	37476	----- 39	51229	----- 4	67522	----- 26
27200	----- 22	37520-PC	----- 9, 33	52059	----- 9	67524	----- 26
27262	----- 7	37568	----- 31	52486	----- 4	67526	----- 26
27262D	----- 7	38282	----- 33	52486B	----- 4	67528	----- 26
27361	----- 8, 25	38534	----- 36	52974	----- 20	67530	----- 26
27392	----- 23	38589	----- 7	53742	----- 7	67532	----- 26
27408	----- 19	38589D	----- 7	53834	----- 4, 35	67534	----- 26
27491	----- 23	38596	----- 23	59651	----- 79	67536	----- 26
27590	----- 22	38602	----- 33	59652	----- 79	67538	----- 26
27606	----- 15, 21	38619	----- 3	59653	----- 79	67540	----- 26
27637	----- 23	38846	----- 83	59654	----- 79	67700	----- 41
27644	----- 53, 90	39241	----- 13	60290S-5	----- 82	72100	----- 25
27675	----- 41	39241-YF	----- 8, 13	60390S-5	----- 82	91269	----- 41
27699	----- 33	39241B	----- 13	60490S-5	----- 82	92311	----- 78
27705	----- 33	39241B-YF	----- 8, 13	61648	----- 78	120321	----- 50
27729	----- 33	40292	----- 3	61655	----- 81	120322	----- 50
27750	----- 31	40308	----- 3	61983	----- 86		
27879	----- 22	40315	----- 3	62362	----- 9, 33		
27880	----- 10	41107	----- 6	62874	----- 6		
27897	----- 10	41121	----- 6	62904	----- 21		