

Dashpaq

IN-CABIN CONTROLLER



USER MANUAL

Table of Contents

4	Read Me
4	Safety Warning & Caution
5	Safety Guidelines
6	At a Glance
6	Physical Overview - The Display
7	Accessories
8	Button Icons
8	Common Terms
9	Navigating Menus
10	Getting Started
10	Download the Fusion Update Software
11	Using the Fusion Update Software
12	Cable Installation
12	Windshield Mount Installation
13	Installing the Display
14	Display Set Up
14	OEM Selection Menu
15	Changing the Default Background Image
16	Configuring the Home Screens
18	Individual Gauge Setup
20	Download and Install MyStyle Software
21	Adding Custom Background Images
22	Settings
22	Accessory Settings - Turbo Cool Down Setup
23	Vehicle Settings - Tire Size
24	Alert Settings
25	Sound Duration - Alerts
25	Backlight Autodim
26	Background Color
27	Menu Time out
27	Units
27	Factory Reset
28	Performance Tuning
28	Basic Vehicle Programming
30	Custom Vehicle Programming
32	Power Levels Explained
33	Custom Options Explained
34	Diagnostics
34	Read DTCs
35	Clear DTCs
35	Clear On Start
36	Manual DPF Regeneration
37	DPF Regeneration Explained
38	Injector Balance Rates
39	Transmission Relearn

40	Performance Testing
40	0-60 & Quarter Mile
41	Horsepower
42	Data Logging
42	Data Logging Explained
43	Retrieving Data Using MyStyle
44	Records
44	Records Explained
45	Help
45	Help Menu Explained
46	Maintenance Manager
46	Turn on Maintenance Manager
47	Entering the Odometer Value
48	Setting the Alert Threshold
49	Customizing Maintenance Items
50	Mileage Coach
50	Mileage Coach Set Up
52	Appendix
52	Service Center and Compatibility Cautions
52	Cold Air Intake (CAI) Kits
53	Mechanical Modifications
53	Forced Induction (Turbochargers or Superchargers)
54	Commonly Used Acronyms
55	Trouble Shooting Guide
56	OEM EGT Locations - Diesel Trucks Only
57	CARB/EPA Compliance

Read Me

Safety Warning & Caution

Throughout this User Manual you will see important messages regarding your safety or the protection of your vehicle. These messages are designated by the words WARNING, CAUTION, or NOTICE.

WARNING

A WARNING indicates a hazardous situation which, if not avoided, will result in death or serious injury.

CAUTION

A CAUTION indicates a hazardous situation which, if not avoided, could result in minor or moderate injury.

NOTICE

A NOTICE indicates a condition that could cause damage to the product or your vehicle.

The Superchips Product you have purchased is a high-performance product. As such, it does present some risks of which you should be fully aware. Do not use this product until you have carefully read the following safety information and the Owner Agreement.

NOTE: After the display has been installed, a warning screen will appear (3) different times.

 WARNING: Misuse of this device could lead to a serious accident. Do not use to break legal speed limits. Before installing, read and comply with all information in the User Guide. Do you agree?

If you agree with the agreement, select Yes to continue.

Safety Guidelines



Before using device, read and understand the user manual, including these additional safety instructions. Failure to do so could result in DEATH or SERIOUS INJURY.

- Do not exceed legal speed limits on public roadways. Violating traffic laws is dangerous and could result in injury or vehicle damage or both.
- Use any enhanced speed capabilities of this product only in closed circuit, legally sanctioned racing environments expressly for this purpose. Violating traffic laws is dangerous and could result in injury or vehicle damage or both.
- Do not operate the device while driving. Distracted driving could result in traffic accidents, death or serious injury, and/or damage to your vehicle.
- Always perform all adjustments or changes while stopped. Changing a setting while driving can interfere with your attention to roadway conditions and could result in injury or vehicle damage or both.
- Do not stack products. “Stacking” performance-enhancing devices or other improper installation can cause power train failure on the road. Other products may have features incompatible with your Superchips device. Follow all installation and operating instructions.
- Some modifications may affect other parts of your vehicle. For example, if you remove/adjust the speed limiter in your vehicle, be sure your tires and other components are rated for the increased speeds they will have to withstand. Not doing so can lead to loss of vehicle control. Modify the speed limiter only for use in closed circuit, legally sanctioned racing environments, not for use on public roadways.

At a Glance

Physical Overview - The Display

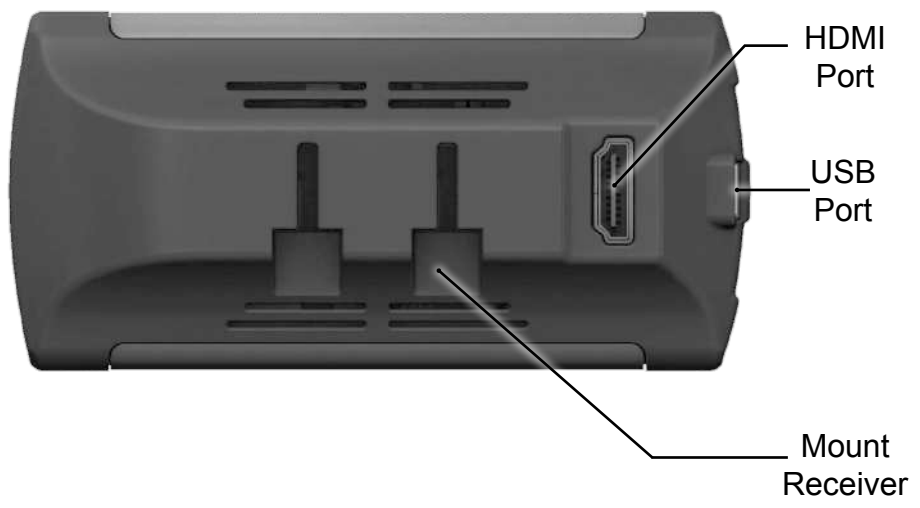
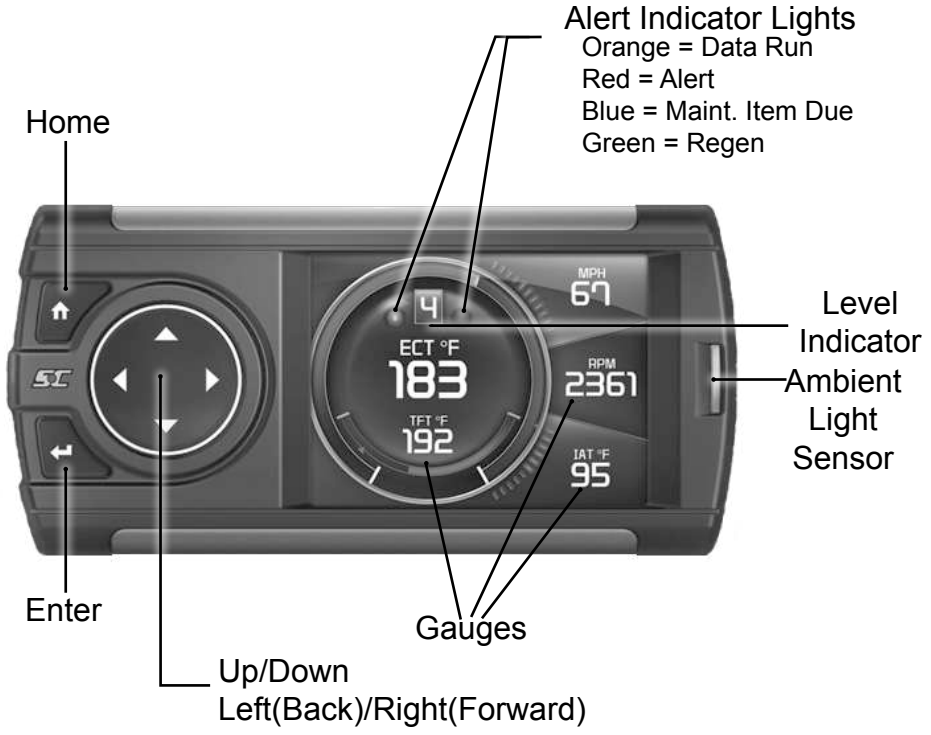

Accessories

Windshield Mount

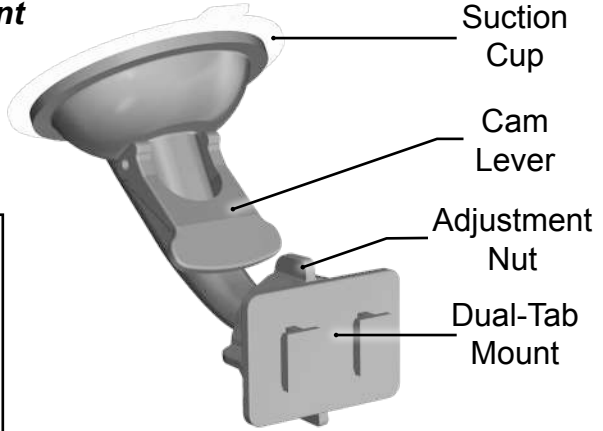

Alcohol Wipe



OBDII to HDMI cable

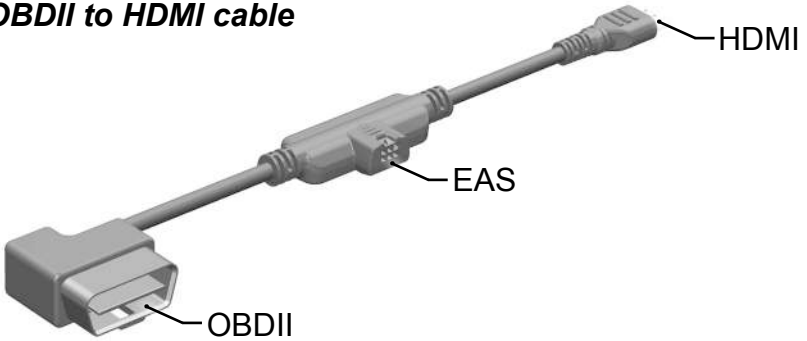







Mini USB Cable



Zip-Ties



Button Icons

Icon		What it does
	Home	Gauge Screens - Enters Main Menu Menus - Brings you back to the home screen
	Enter	Gauge Screens - Highlights PID locations Menus - Selects menu options & closes text boxes
	Up	Gauge Screens - PID location navigation Menus - Scrolling up
	Down	Gauge Screens - PID location navigation Menus - Scrolling down
	Left	Gauge Screens - PID location navigation Menus - Back to previous menu or option
	Right	Gauge Screens - PID location navigation Menus - Brings you to next menu

Common Terms

Term	What it is
PID - <u>P</u> arameter <u>I</u> Ds	Data taken from a vehicle & viewed in a gauge
DPF - <u>D</u> iesel <u>P</u> articulate <u>F</u> ilter	Required on new diesels to filter out soot
EAS - <u>E</u> xpandable <u>A</u> ccessory <u>S</u> ystem	Allows you to connect aftermarket sensors and other devices such as turbo timers
ECM - <u>E</u> ngine <u>C</u> ontrol <u>M</u> odule	(aka ECU) A computer that controls various sensors and engine components
TCM - <u>T</u> ransmission <u>C</u> ontrol <u>M</u> odule	(aka TCU) A computer that controls automatic transmissions
PCM - <u>P</u> ower <u>C</u> ontrol <u>M</u> odule	(aka PCU) Combines and provides power for the ECM and TCM

Navigating Menu

STEP 1 - Enter the Main Menu by pressing the Home button.

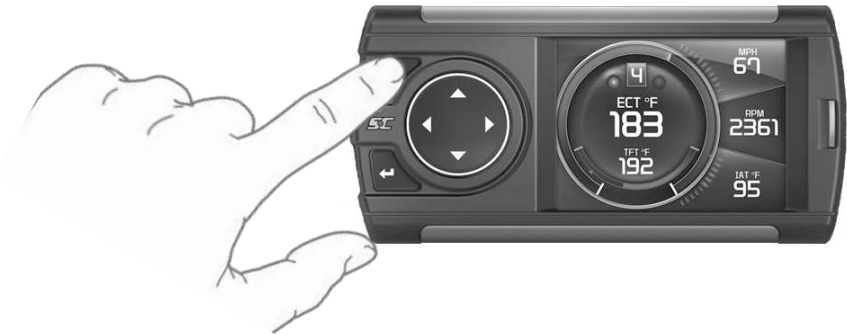

STEP 2 - Use the Up/Down arrows to scroll through the menu items.

STEP 3 - Press the Enter button to select a sub menu.



STEP 4 - Press the left arrow to return to the previous screen.

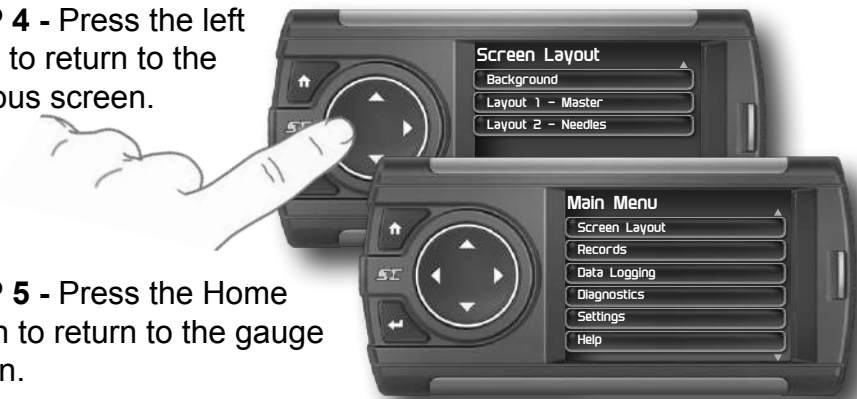

STEP 5 - Press the Home button to return to the gauge screen.

Getting Started

Download the Fusion Update Software

A computer with internet access is required:

STEP 1 - Go to **website**

STEP 2 - Click the **UPDATES** tab, then **DOWNLOAD**.

STEP 3 - Open the **FusionClientSetup.exe** file, then click **Run**.

STEP 4 - Click **Next** to begin.

STEP 5 - Choose a folder location, then click **Next** to continue.

STEP 6 - Click **Next** to confirm the installation.

STEP 7 - Click the **OK** button if during the installation, the following message appears:

“These drivers are not Windows Logo or WHQL verified. If you are asked, please choose to install them anyway.”

STEP 8 - Click **Close** to exit once the installation is complete.

STEP 9 - Double click the **Fusion Icon** on your desktop.

STEP 10 - Click on the **Create a New User** option.

STEP 11 - Fill in the required information and click **Save**.

An e-mail containing your fusion password will be sent to the e-mail you used in the form. Use this password to login into Fusion. (NOTE: The password is case sensitive)

STEP 12 - Double click the **Fusion Icon** on your desktop.

STEP 13 - Plug the display into the computer using the USB cable.

STEP 14 - *If asked, choose “Yes, this time only”, then click Next.*

STEP 15 - *Select Install the software automatically then Next.*

STEP 16 - If you're asked to “Continue Anyway” or “STOP installation” click **Continue Anyway** then click **Next** to complete the hardware wizard.

Using the Fusion Update Software

A computer with internet access is required:

STEP 1 - Double click the **Fusion Icon** on your desktop.

STEP 2 - When asked, plug the display into the computer using the supplied USB cable.



STEP 3a - If an update is available, click **YES** to continue.

DO NOT unplug the display from the computer during an update.

STEP 3b - If an update is not available, click the **OK** button.

STEP 4 - Once the update is complete, click **Close**.

Cable Installation

STEP 1 - Locate the On Board Diagnostics II (OBDII) port.
(This connector is typically found directly below the driver side dash console.)

STEP 2 - Plug the OBDII connector into the vehicle port.

STEP 3 - Route the HDMI end up the driver side dash.
(On most vehicles, the side panel may be removed to expose the underside of the dash for easier routing. Leave exposed until after the display is installed.)

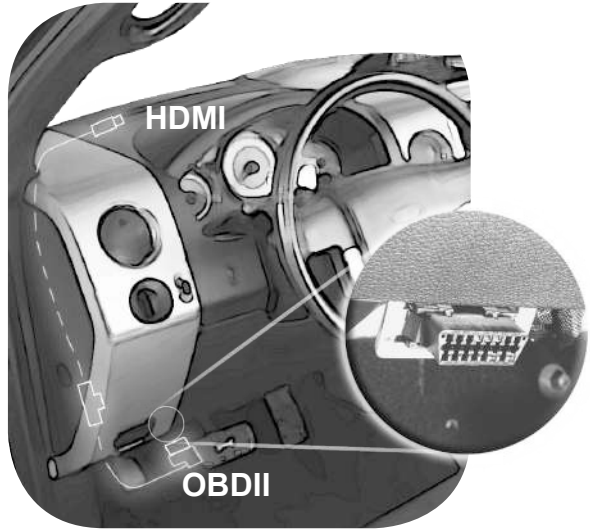

Windshield Mount Installation

STEP 1 - Use the Alcohol Wipe to liberally clean the windshield in the area you plan to place the suction cup. Allow the glass to fully dry.

STEP 2 - Firmly press and hold the suction mount against the glass.

STEP 3 - Rotate the Cam Lever towards the glass to create the suction.

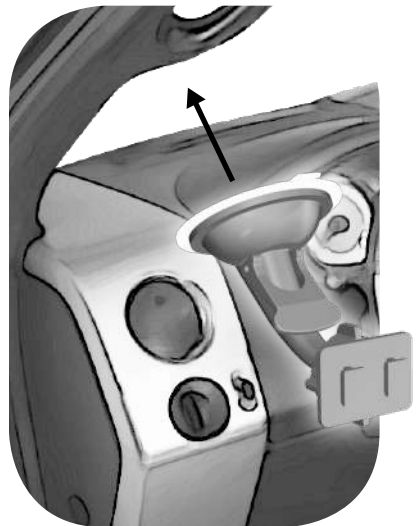

Installing the Display

STEP 1 - Plug the HDMI connector into the HDMI receptacle located on the back side of the display.

STEP 2 - Align the Dual Tabs on the Mount with the mount receiver on the back side of the display, then slide it into place.

STEP 3 - Adjust the viewing angle using the adjustment nut on the mount's swivel head.

STEP 4 - Pull any extra cable back behind the pillar and dash. (Re-install any panels removed during the Cable Installation.)

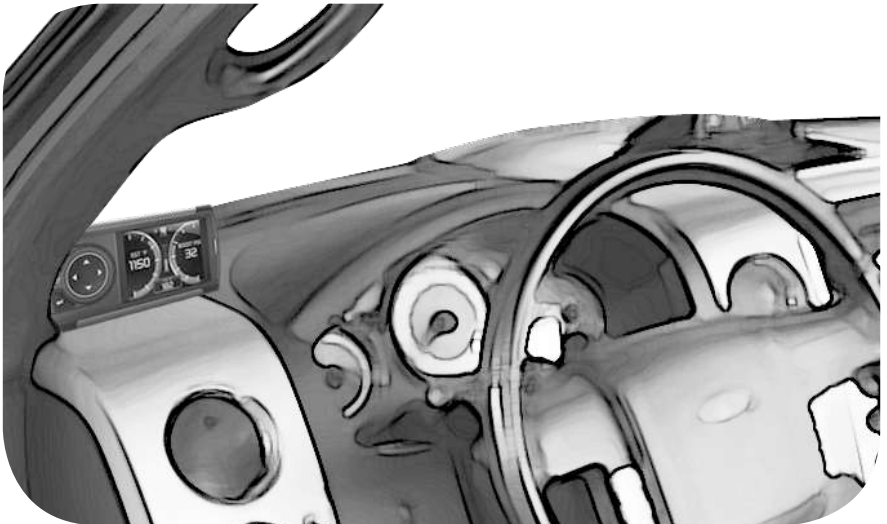

Display Set Up

OEM Selection Menu

Once the installation is complete, and you first plug the device into the OBDII port, the OEM selection menu will appear.

STEP 1 - Turn the vehicle to the ON or RUN key position.

STEP 2 - Select one of the available options that applies:



Ford
Chrysler/Dodge
GM/Chevy
Import
EAS 12V Power Kit

STEP 3 - Follow the on screen instructions. The Main Gauge screen will appear.



Changing the Default Background Image

STEP 1 - While viewing the gauge screen, press the Home button.



STEP 2 - On the Main Menu, select the Screen Layout option.



STEP 3 - Select the Background option.



STEP 4 - Use the Left/Right buttons to scroll through the available background images.



Refer to the "Adding Custom Background Images" section of this manual for information on how to add your own images to the display.

Configuring the Home Screens

STEP 1 - While viewing the gauge screen, press the Home button.



STEP 2 - On the Main Menu, select the Screen Layout option.



STEP 3 - Select either of the Layout options.



STEP 4 - Use the Up/Down buttons to scroll through the available screen layouts. Press Enter to select an option.



Layout Options

Master Gauge



Retro Gauge



Digital Gauges



Needle Gauges



STEP 5 - Once you have highlighted a screen layout, press the Home button to return to the main gauge screen.

STEP 6 - While on the main gauge screen, press the Left or Right arrows to change between screen Layouts 1 and 2.



Individual Gauge Setup

STEP 1 - While viewing a gauge layout screen, press the Enter button. A gauge location will be highlighted.



STEP 2 - Use the arrow buttons to highlight the gauge location that you would like to modify.

STEP 3 - Highlight the Select New PID option. Then press Enter.

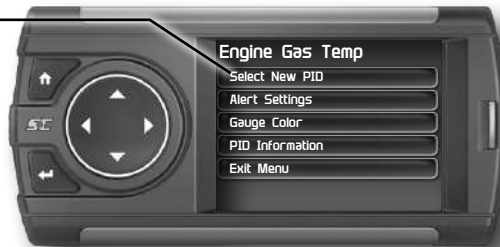

STEP 4 - Use the Up/Down arrow buttons to highlight a new PID, then press Enter.



STEP 5 - Select each of the remaining options to further customize your gauge.

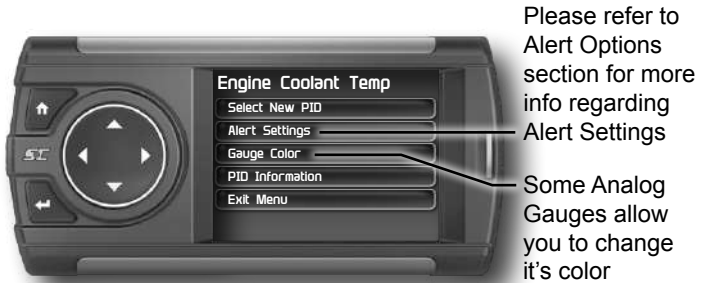

STEP 6 - Return to the main gauge screen. The new PID will be displayed along with any customized options you may have changed.



Download and Install MyStyle Software

MyStyle is software that allows you to customize your display background image and manage your EAS devices.

A computer with internet access is required:

STEP 1 - Go to **website**

STEP 2 - Click the **UPDATES** tab, then Mystyle **DOWNLOAD**.



STEP 3 - Open the **MyStyleSetup.exe** file, then click **Run**.

STEP 4 - Click **Next** to begin.

STEP 5 - Choose a folder location, then click **Next** to continue.

STEP 6 - Click **Next** to confirm the installation.



STEP 7 - Click the **OK** button if during the installation, the following message appears:

"These drivers are not Windows Logo or WHQL verified. If you are asked, please choose to install them anyway."

STEP 8 - Click **Close** to exit once the installation is complete.

Adding Custom Background Images

This section describes how to add personalized photos or pictures to your display using a computer.

STEP 1 - Double-click the MyStyle  icon on your desktop.

STEP 2 - Connect the display using the supplied USB cable.
When a display is plugged in, an image of the display will appear with a 9 digit number.

STEP 3 - Click the image of your display. 

STEP 4 - Choose to Customize the Display. 

STEP 5 - Select an Image to replace. 

STEP 6 - Select the Open Image button. 

STEP 7 - Use the available tools to size and align your image. 

STEP 8 - Click the Save Background button to save your progress. This will also save the new background image to you display. 

Settings

Accessory Settings - Turbo Cool Down Setup

This feature is only available and listed if an EAS Turbo Timer has been installed. The Turbo Cool Down feature allows the engine to continue running (after the key is in the off position) until one of four conditions have been met:

1. If the EGT value falls below the target set point.
2. The time set expires.
3. Pressing either the brake or gas pedal.
4. Pressing a button on the Dashpaq.

STEP 1 - Press the Home button to enter the Main Menu

STEP 2 - Use the Up/Down arrow buttons to scroll down to the Settings option.

STEP 3 - Press Enter.

STEP 4 - Next, select Accessory Settings from the Settings menu.



STEP 5 - Select Turbo Cool Down Setup.

STEP 6 - Choose one of the available options.

! WARNING: Do not use this feature in an enclosed area.



Select this option if you would like the turbo timer feature to use a pre-determined EGT value.

Select this option if you would like the turbo timer feature to use a pre-determined time setting (seconds).

This option will disable the turbo timer feature and take you back to the previous menu.

NOTE: 2007-09 Dodge trucks can be turned off using the key's panic button. 2010 Dodge trucks can be turned off if the lock and panic buttons are pressed at the same time.

Vehicle Settings - Tire Size

The display is capable of re-calibrating the vehicle's speedometer and the MPH PID. In order for this to happen, you will need to enter a tire size.

STEP 1 - Press the Home button to enter the Main Menu

STEP 2 - Use the Up/Down arrow buttons to scroll down to the Settings option.

STEP 3 - Press Enter.

STEP 4 - Select Vehicle Settings, then select the Tire Size option.



STEP 5 - Select the size option that best fits your application:
Stock Size = Stock Tires
Modified Size = Non-Stock Tires

STEP 6 - Choose the tire format that best fits your application.
(NOTE: You must enter the Stock Size as well if a modified Size is being entered)

English = Height(XX) / width(XX.X) / wheel size (RXX)

P-Metric = Width(XXX) / aspect ratio(XX) / diameter (RXX)

Circumference = The outer circumference of the tire (mm)

Height = The height of the tire (from ground to top of tire)

Return to Stock = Erases any tire info you have entered, and returns the tire size to the original default setting.

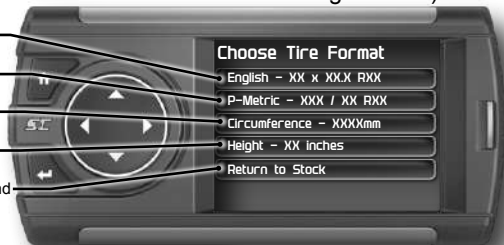

STEP 6 - Use the arrow buttons to highlight a number, then press enter to select it. When done select Done or press Enter.



OR



Alert Settings

STEP 1 - Press the Home button to enter the Main Menu.

STEP 2 - Use the Up/Down arrow buttons to scroll down to the Settings option.

STEP 3 - Press Enter

STEP 4 - Select Alert Settings from the list.



STEP 5 - Select a PID from the list.

STEP 6 - Make your adjustments.

In the example below, battery voltage is being modified.

Turn On or Off the alert system for all PIDs.

Turn On or Off this specific PID's alerts.

Turn On or Off the alert sound for this PID only.

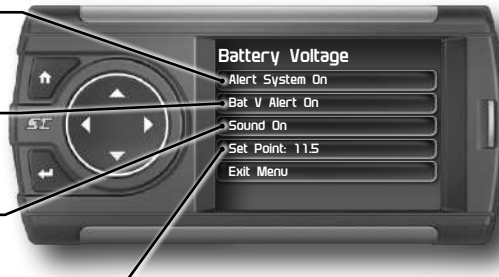

This is the point at which you want the alert to be triggered for this PID.

The example above shows 11.5 as the value. If the display detects a battery voltage of 11.5 volts or less, the alert will be triggered.

During an alert:

- 1) One of these lights will light up red and have an A inside it.
- 2) An alert message will be displayed
- 3) The gauge will flash red



Sound Duration - Alerts

STEP 1 - Press the Home button to enter the Main Menu.

STEP 2 - Use the Up/Down arrow buttons to scroll down to the Settings option.

STEP 3 - Press Enter

STEP 4 - Select Sound Duration from the list.

STEP 5 - Adjust the time (in seconds) to the length of time an alert should sound.

STEP 6 - Press Enter



Backlight Autodim

Each display is equipped with a light sensor that detects how much light is entering the vehicle cab. During the day, the display will be at its maximum brightness. As it gets darker outside, the display will automatically dim according to the amount of sunlight. If the value is kept at 99%, the display will be as dim as possible. If the value is set to 50%, the display will only be half as dim at night.

STEP 1 - Press the Home button to enter the Main Menu.

STEP 2 - Use the Up/Down arrow buttons to scroll down to the Settings option.

STEP 3 - Press Enter

STEP 4 - Select Backlight Autodim from the list.

STEP 5 - Adjust the percent value.

STEP 6 - Press Enter.

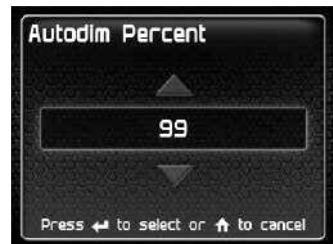

Background Color

STEP 1 - Press the Home button to enter the Main Menu.

STEP 2 - Use the Up/Down arrow buttons to scroll down to the Settings option.

STEP 3 - Press Enter

STEP 4 - Select Background Color from the list.



STEP 5 - Use the Up/Down arrow buttons to toggle between the options on the Color Mixer screen. Use the Left/Right arrow buttons to adjust their values.

STEP 6 - Make your adjustments.

The viewing window allows you to see the changes you are making real time



Red Values
Green Values
Blue Values
Opacity Value: If this value is above 80%, you may no longer see the background

Use the Color selector to quickly choose default colors, or a mixed color you have saved previously



Menu Time out

This feature prevents the display from staying on for excess amounts of time. Once the time runs out, the display will return to the main gauge screen, then shut off.

STEP 1 - Press the Home button to enter the Main Menu.

STEP 2 - Use the Up/Down arrow buttons to scroll down to the Settings option.

STEP 3 - Press Enter

STEP 4 - Select Menu Timeout from the list.

STEP 5 - Adjust the time (in seconds).

STEP 6 - Press Enter.



Units

Changing the unit option allows you to view PIDs in either Metric or English. Vehicle Speed, for example, may be viewed as either MPH or KPH. Temperature PIDs such as Engine Coolant Temperature may be viewed as either Fahrenheit or Celsius, etc.

CAUTION: *If you set up your display while the units are in English, and then switch to Metric, the values will remain the same, and not be converted.*

Factory Reset

This feature will return the display to the factory default settings. All records and input data will be deleted and not recoverable.

STEP 1 - Press the Home button to enter the Main Menu.

STEP 2 - Use the Up/Down arrow buttons to scroll down to the Settings option.

STEP 3 - Press Enter

STEP 4 - Select Factory Reset from the list. Press Enter.

Performance Tuning

Basic Vehicle Programming

NOTE: Not all levels shown below are available on every vehicle make and/or model.

The Dashpaq comes ready with power levels that can be used to easily program the vehicle's Power Control Module (PCM). This section explains how to tune a vehicle using the standard level options.

CAUTION: *Programming requires that the vehicle be parked and not moving. As such, make sure to park away from traffic or areas where the vehicle may impede access or exit. Programming will take several minutes and the vehicle can't be started during this process.*

STEP 1 - Press the Home button to enter the Main Menu.



STEP 2 - Use the Up/Down arrow buttons to scroll down to the Performance Tuning option.

STEP 3 - Press Enter.

STEP 4 - Select one of the available tuning levels.



⚠ WARNING: *Do Not combine or "Stack" chips (modules) to gain more horsepower. The chips could be incompatible and result in power-train failure or create dangerous conditions leading to a serious or fatal accident.*

STEP 5 - Press Enter to continue.

STEP 6 - When asked if you would like to create a custom program, press NO.

NOTE: After selecting NO, the Dashpaq will begin to save the stock files. These files are used to return your vehicle back to it's stock settings.



STEP 7 - When asked, follow the Key-ON / Key-OFF instructions.

(NOTE: After the programming is complete, you will be taken back to the Levels screen. At the top it will say: "Current Lvl - the tune you picked")

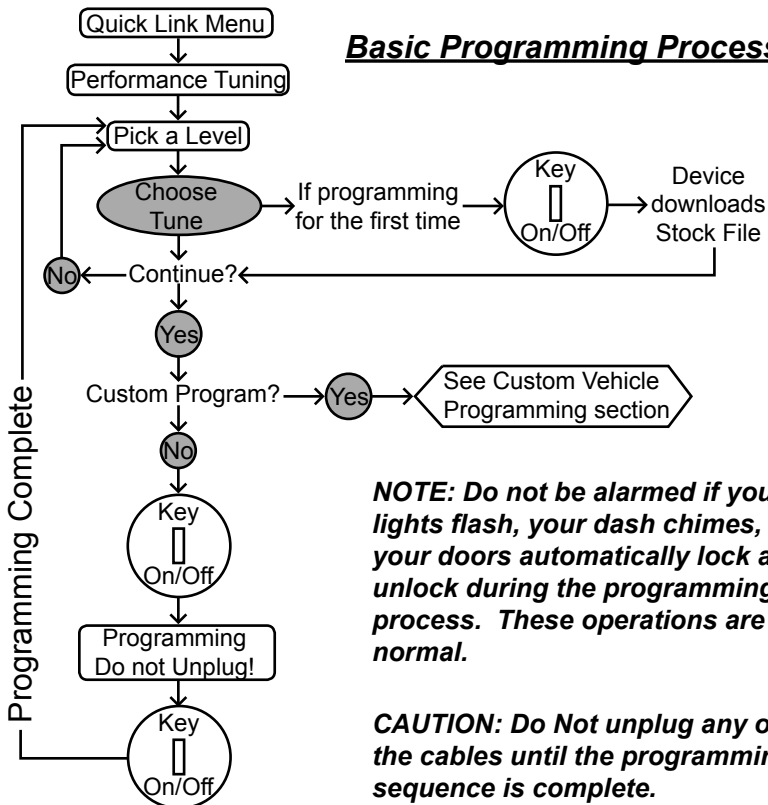

NOTE: Do not be alarmed if your lights flash, your dash chimes, or your doors automatically lock and unlock during the programming process. These operations are normal.

CAUTION: Do Not unplug any of the cables until the programming sequence is complete.

Custom Vehicle Programming

The Dashpaq comes ready with power levels that can be used to easily program the vehicle's Power Control Module (PCM). This section explains how to modify custom options within each power level.

CAUTION: *Programming requires that the vehicle be parked and not moving. As such, make sure to park away from traffic or areas where the vehicle may impede access or exit. Programming will take several minutes and the vehicle can't be started during this process.*

STEP 1 - Press the Home button to enter the Main Menu.



STEP 2 - Use the Up/Down arrow buttons to scroll down to the Performance Tuning option.

STEP 3 - Press Enter.

STEP 4 - Select one of the available tuning levels.



STEP 5 - Press Enter to Continue.

⚠ WARNING: *Do Not combine or "Stack" chips (modules) to gain more horsepower. The chips could be incompatible and result in power-train failure or create dangerous conditions leading to a serious or fatal accident.*

STEP 6 - When asked if you would like to create a custom program, press Yes.

STEP 7 - Scroll through the available options, modify them accordingly, then press Enter.



STEP 8 - Select Continue Programming.

STEP 9 - When asked, follow the Key-ON / Key-OFF instructions.

(NOTE: After the programming is complete, you will be taken back to the Levels screen. At the top it will say: "Current Lvl - the tune you picked") Levels screen. At the top it will say: "Current Lvl - the tune you picked")

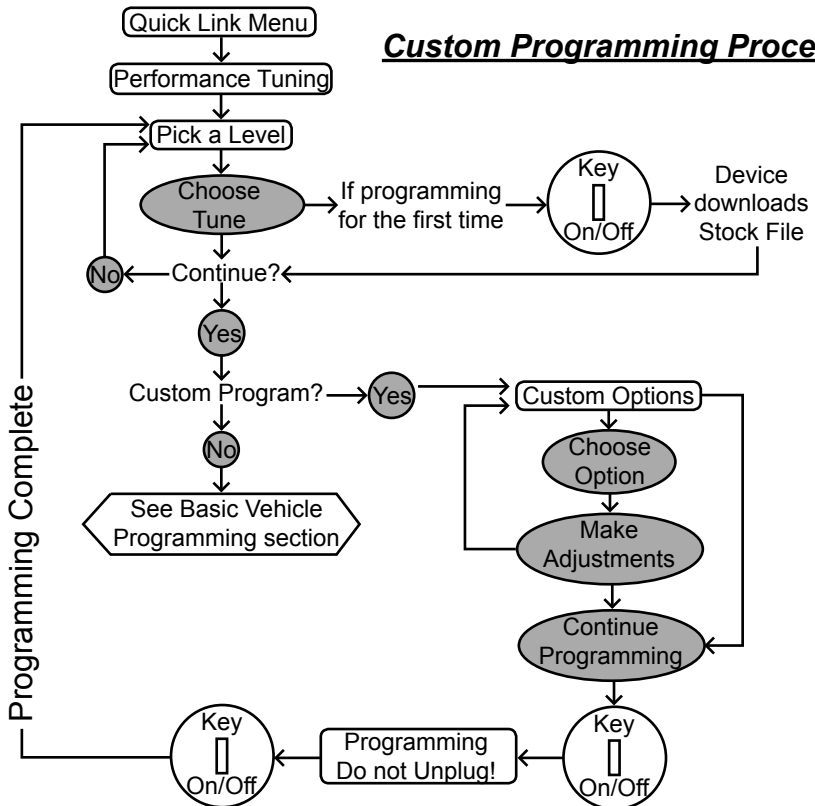

Power Levels Explained

NOTE: Not all levels shown below are available on every vehicle make and/or model.

The Dashpaq device typically comes ready with (4) power levels. These levels are tuned specifically for different driving situations. This section describes each level and how it should be used.

▲WARNING: *Performance and Extreme levels are not intended for and should not be used for towing. Do not exceed your vehicle's max Gross Vehicle Weight Rating (GVWR) as outlined in the vehicle's owner's manual. Doing so may result in loss of vehicle control and cause bodily injury.*

TRANS ONLY - The trans only level affects and makes changes to the transmission only. It will provide firmer transmission shifts which may help increase transmission life.

ECONOMY - The economy level is the lowest power level. It has been specifically tuned for optimum fuel economy. We recommend using this level for daily driving.

TOWING - The towing level is designed for towing. The tuning created for this level provides power when it is needed most while pulling a load.

PERFORMANCE - The performance level is a high power level. The fuel injection and timing is adjusted to semi-aggressively extract power gains from the vehicle without sacrificing drive-ability or durability.

EXTREME - This is the highest setting for an Dashpaq. The fuel injection and timing is adjusted to aggressively extract high performance from your vehicle without sacrificing driveability or durability.

Custom Options Explained

After choosing a power level you will be given the option to adjust a custom option. This means that within each programming level you can adjust specific vehicle functions.

USE CURRENT SETTINGS - This option will use the previously selected/modified options.

RESET ALL VALUES - This options will restore all of the settings back to the factory default settings.

TIRE SIZE - This options will allow you to select a new tire size if you've changed the factory tires.

GEAR RATIO - This option will allow you to select a new gear ratio if you've changed the factory gears.

SPEED LIMITER - This option will allow you to adjust the factory speed limiter higher or lower.

▲WARNING: *Removal/adjustment of the factory speed limiter is intended for use at a closed circuit, legally sanctioned racing environment. If you drive on public roads after removal or adjustment of the speed limiter, you must still obey all driving laws, including adhering to posted speed limits. To drive at racing speeds on public roads seriously endangers you, your passengers, and others nearby. Also it is your responsibility to ensure your tires and other vehicle components are rated to travel at increased speeds. Driving at high speeds with inadequate tires or other components can lead to serious or fatal injury.*

Caution: *Removing/adjusting the speed limiter for purposes inconsistent with the products's intended function violates the product's intended use and will invalidate the product's warranty. Superchips is not responsible for, or liable for the consequences of improper product use.*

Diagnostics

Read DTCs

When your PCM detects a problem with your vehicle it sets a trouble code, and most times a “Check Engine” light on your dash is activated. These codes can be retrieved and used to help diagnose specific issues.

STEP 1 - Press the Home button to enter the Main Menu.



STEP 2 - Use the Up/Down arrow buttons to scroll down to the Diagnostics option.

STEP 3 - Press Enter.

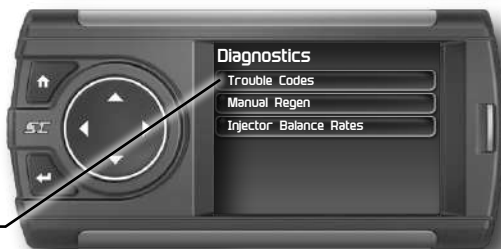

STEP 4 - Select Trouble Codes. Press Enter.

STEP 5 - Select Read DTCs. Press Enter.



STEP 6 - If a code is listed, select the code to see a brief explanation of the issue.

If a code is shown, write down the information given. You can use this code number to research the particular issue. The internet is a good resource for looking up most codes.



Clear DTCs

This feature allows you to clear most DTCs. This will erase any codes currently set. If the codes come back we recommend you see a qualified mechanic who can accurately diagnose and repair the problem.

STEP 1 - Press the Home button to enter the Main Menu.

STEP 2 - Use the Up/Down arrow buttons to scroll down to the Diagnostics option. Press Enter.

STEP 3 - Select Trouble Codes. Press Enter.

STEP 4 - Select Clear DTCs. Press Enter.



Clear On Start

This feature is not available on all products.

In some instances, DTCs may need to be cleared every time the truck starts or the truck will go into “limp” mode.

NOTE: *Fords and Chevy's are able to clear codes while the truck is running. Dodge Trucks however may require you to clear only when the key is on and the engine is not running.*

STEP 1 - Press the Home button to enter the Main Menu.

STEP 2 - Use the Up/Down arrow buttons to scroll down to the Diagnostics option. Press Enter.

STEP 3 - Select Trouble Codes. Press Enter.

STEP 4 - Select Clear On Start. Press Enter to toggle between Yes and No.

Manual DPF Regeneration

Available only on specific Diesel Trucks

Manual regeneration allows you to manually clear out the Diesel Particulate Filter (DPF). Completing a manual regeneration cycle will clear the soot mass in the filter, and lower exhaust back pressure to improve exhaust flow.

STEP 1 - Press the Home button to enter the Main Menu.



STEP 2 - Use the Up/Down arrow buttons to scroll down to the Diagnostics option.

STEP 3 - Press Enter.



STEP 4 - Select Manual Regen. Press Enter.

STEP 5 - Press Enter to continue with the regen.

NOTE: When manually initiating a regeneration cycle, some vehicles will require a drive cycle (i.e. you have to drive the vehicle some distance) while others may allow you to initiate a Service Regeneration where you can leave the vehicle parked and the engine running. If the latter is the case, be sure to use the following guidelines.

- 1. Park the vehicle outdoors and keep people, other vehicles, and combustible materials away from it.*
- 2. Do not leave the vehicle unattended.*
- 3. Do not connect any shop exhaust hoses or vents to the tail pipe.*

DPF Regeneration Explained

CAUTION: Exhaust temperatures may be greater than 300C (572 F) during service regeneration.

CAUTION: Due to the elevated temperatures during this procedure, open the hood and keep the front of the vehicle away from anything impeding air flow to the radiator.

DPF REGENERATION

If you own a newer diesel powered vehicle, your vehicle is equipped with a diesel particulate filter (DPF). This filter is used in conjunction with a diesel oxidation catalyst. Together they work to reduce the amount of soot and emissions emitted from the tailpipe. As soot builds up in the DPF it will begin restricting flow. The soot that gathers is automatically purged in one of two ways: Passive Regeneration & Active Regeneration. Both methods occur automatically and require no action on your part. During either of these regeneration methods, you may notice an increase or change in the exhaust noise & increased Exhaust Gas Temperature (EGT).

PASSIVE REGENERATION

Passive regeneration occurs when the exhaust gas temperature (EGT) reaches an appropriate level in order to oxidize or burn soot to clean the DPF. This method can happen as a result of normal engine operating conditions, typically when the engine reaches an (EGT) high enough to burn off the soot (i.e. heavy towing, high load conditions, etc). If EGTs do not get hot enough to cause passive regeneration, your truck's engine-control system automatically initiates an active regeneration.

ACTIVE REGENERATION

During active regeneration, the truck computer cleans the DPF by raising the exhaust temp to a point where the soot is burned away. This is accomplished through various engine actions which raise the EGTs in the oxidation catalyst/DPF system to a level where the soot is burned off. After the soot is burned off, the EGTs and back pressure (restriction) fall back to normal levels. In order to help you know the status of DPF Regeneration, the device will show in the alerts section of the drop down menu anytime active regeneration is happening.

Injector Balance Rates

Available only on specific GM/Chevy Trucks

Injector Balance Rates are used to determine if all injectors are operating within the correct tolerances. If you are experiencing a misfire, knock, excessive smoke, or rough running conditions with no DTCs, this option can help identify faulty injectors. The balance rates are the fuel adjustments for each individual cylinder based on the variations in engine crankshaft speed. These will change depending on if the transmission is in Neutral or Drive. Injectors that read outside of the +/- 4.0 in park/neutral or +/- 6.0 in drive may be faulty.

STEP 1 - Press the Home button to enter the Main Menu.



STEP 2 - Use the Up/Down arrow buttons to scroll down to the Diagnostics option.

STEP 3 - Press Enter.

STEP 4 - Select Injector Balance Rates.



STEP 5 - Press Enter to continue.

STEP 5 - Watch each injector value while in Park/Neutral, and then while in Drive.

STEP 6 - Press the Enter button to return to the gauge screen.



If you suspect a faulty injector, we recommend consulting a professional diesel mechanic who can verify the issue and also perform a cylinder power balance test to further diagnose.

Transmission Relearn

For 2001-2013 GM diesel trucks only

The vehicles listed above are equipped with transmissions that “learn” while you drive. Sometimes when these vehicles are programmed with an aggressive tune, the transmissions act differently. This feature forces the transmission to relearn and accommodate the new tune.

STEP 1 - Press the Home button to enter the Main Menu.

STEP 2 - Scroll down to the Diagnostics option. Press Enter.

STEP 3 - Scroll through the list and select Trans Relearn.

STEP 4 - When asked, select Yes to continue.

STEP 5 - Drive the vehicle as you normally would.
The transmission will relearn as you drive.

NOTE: After the relearn commands are sent there might be some clunks, bumps, and/or short flares, especially during the 3-4 shift (3rd gear to 4th gear). This is normal. Completion of this feature will require a minimum of 3 upshifts at a steady throttle angle.

Performance Testing

0-60 & Quarter Mile

WARNING

Follow all traffic laws when conducting performance testing. Failure to obey traffic laws could result in traffic accidents, serious injury or death, and/or damage to the vehicle.

Performance tests can be helpful for measuring performance gains after vehicle modifications have been made. The results recorded during these test will likely differ from what you'll see on a drag-strip or other racing venues. Incorrect speedometer calibration, data sample rate, and tire slippage can cause miscalculations in the displayed results.

STEP 1 - Press the Home button to enter the Main Menu.



STEP 2 - Use the Up/Down arrow buttons to scroll down to the Performance Testing option.

STEP 3 - Press Enter.

STEP 4 - Select either the 0-60 or Quarter Mile option.



STEP 5 - Bring the vehicle to a complete stop.

STEP 6 - Use the drag strip style light tree on the left of the screen to know when to begin accelerating. Once you have reached 60 mph (or a quarter mile), the test will show as completed.



STEP 7 - Press any button to exit the test.

Horsepower

NOTE: Before using the Horsepower test, the vehicle weight (aka curb weight) must be entered first. The curb weight is the total weight of a vehicle with standard equipment, all necessary operating consumables (e.g., motor oil, coolant), a full tank of fuel, with no passengers or cargo.

STEP 1 - Press the Home button to enter the Main Menu.



STEP 2 - Use the Up/Down arrow buttons to scroll down to the Settings option.

STEP 3 - Press Enter.

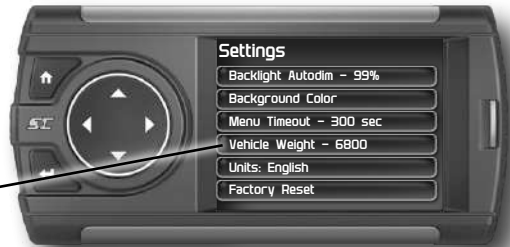

STEP 4 - Scroll down and select the Vehicle Weight option.

STEP 5 - Use the Up/Down buttons to enter the correct weight. Press Enter.



STEP 6 - Press the back button to return to the main menu. Select the Performance Tests option. Press Enter.

STEP 7 - Select the Horsepower option. Bring the vehicle to a complete stop.

STEP 8 - Follow the on-screen instructions. Press any button to stop the test.

Data Logging

Data Logging Explained

The data logging feature allows you to record all of the available PID data on your display. This information can be retrieved and viewed using the MyStyle software package.

NOTE: *The display also runs background tasks which are also recorded. This information can be ignored.*

STEP 1 - Press the Home button to enter the Main Menu.



STEP 2 - Use the Up/Down arrow buttons to scroll down to the Data Logging option. Press Enter.

STEP 3 - Select one of the (5) Data Run options. This will turn the run On or Off.



NOTE: *Only one run can be turned on at a time.*

STEP 4 - Select the Home button to return to the main gauge screen. The display is now in recording mode.

STEP 5 - Once you have recorded for a specific amount of time, return to the Data Logging menu and turn Off the run.

NOTE: *The maximum amount of Data Logging time depends on how many items you are logging at once. This may be anywhere from 15 to 20 minutes total. Once the limit is reached, the Data Logging feature will be automatically shut off.*

NOTE: *If you turn the same Data Run back On, the previous data will be erased and a new recording session will begin. If the indicator light is red, there is currently a recorded file associated with that run.*

Retrieving Data Using MyStyle

This section describes how to retrieve the data recorded during a Data Logging recording session. If you have not yet installed MyStyle refer to the Display Set Up section of this manual.

STEP 1 - Double-click the MyStyle  icon on your desktop.

STEP 2 - Connect the display using the supplied USB cable. *When a display is plugged in, an image of the display will appear with a 9 digit number.*



STEP 3 - Click the image of your display.

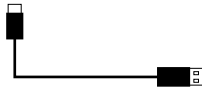

STEP 4 - Select Data Logs.



STEP 5 - Click the Save File As button and save the file.

STEP 6 - Locate the saved file on your computer and open it. The file will be saved as a .CSV file and can be opened using Microsoft Excel or similar.

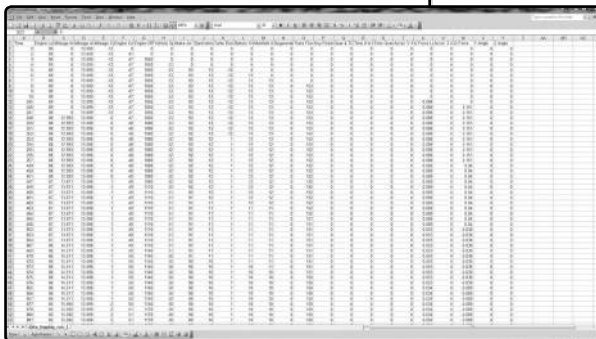

Records

Records Explained

Records contain certain parameters for later review. This is useful after completing a performance test on the drag strip, at a sled pull, or when you are trying to trouble shoot a particular issue.

STEP 1 - Press the Home button to enter the Main Menu.



STEP 2 - Use the Up/Down arrow buttons to scroll down to the Records option. Press Enter.

STEP 3 - Scroll through the list to view all records.



STEP 4 - While an individual record is highlighted, you can clear it by pressing the Enter button.

STEP 5 - If you want to clear all records at the same time, highlight the Clear All option and press the Enter button.

Help

Help Menu Explained

The Help Menu contains useful information about your display, and the vehicle it is currently plugged into. It also contains Superchips contact information and Technical Support tools.

STEP 1 - Press the Home button to enter the Main Menu.

STEP 2 - Use the Up/Down arrow buttons to scroll down to the Help option. Press Enter.



STEP 3 - Select the option that best describes your need:

Product Info (Display)

- Version
- Application Version
- Calibration Version
- Firmware (BC) Version
- FPGA Version
- MSP430 Version
- Serial Number (used to identify your display in the software update process and during Technical Support calls)

Product Info (EAS)

If you have an EAS device installed on your vehicle and plugged into your display, another Product Info screen will be available. It will list your EAS device's Firmware Version as well as its serial number.

Vehicle Info

Displays important information about your vehicle that is used by technical support to trouble shoot issues.

Contact Info

Shows our website, company address, the technical support email address, and the technical support phone number.

Tech Support Tools

This menu should only be used when requested by Superchips Technical Support personnel.

Maintenance Manager

Turn on Maintenance Manager

The Maintenance Manager calculates the odometer value of your vehicle using the vehicle speed and time. Since this option is not going to always match your real dash odometer reading, you will need to periodically update the Maintenance Manager's odometer value. We will automatically adjust it based on the changes you make to the Maintenance Manager.

STEP 1 - Press the Home button to enter the Main Menu.

STEP 2 - Use the Up/Down arrow buttons to scroll down to the Maintenance Manager option.

STEP 3 - Press Enter.

STEP 4 - Press the Enter button to turn on the Maintenance Manager.

(Press Enter to toggle the feature On and Off.)



Entering the Odometer Value

STEP 1 - Press the Home button to enter the Main Menu.



STEP 2 - Use the Up/Down arrow buttons to scroll down to the Maintenance Manager option.

STEP 3 - Press Enter.

STEP 4 - Use the Up/Down arrow buttons to scroll down to the Odometer option.



STEP 5 - Press Enter.

STEP 6 - Use the arrow buttons to highlight each number, then press Enter to select it.



STEP 7 - Once the correct Odometer value has been entered, highlight the Done button and press Enter.

Setting the Alert Threshold

The alert threshold is the number of miles you would like to be alerted before a specific maintenance item is due. In the example below, you would be alerted 100 miles before the actual mileage it is due.

STEP 1 - Press the Home button to enter the Main Menu.



STEP 2 - Use the Up/Down arrow buttons to scroll down to the Maintenance Manager option.

STEP 3 - Press Enter.

STEP 4 - Use the Up/Down arrows to highlight the Alert Threshold option.



STEP 5 - Press Enter.

STEP 6 - Use the Up/Down arrow buttons to adjust the threshold value.

STEP 7 - Press the Enter button to save the value and return to the Maintenance Manager screen.



Customizing Maintenance Items

Once the odometer has been updated, you may begin to modify each of the specific maintenance items.

STEP 1 - While in the Maintenance Manager menu, select the Maintenance Items option. Press Enter.



STEP 2 - Scroll through and select an item from the list.



Enter the interval (in miles) in which you would like the item to alert you. In this example, you will be Alerted every 3000 miles to change your Air Filter.



Turning On an alert means the item is now being managed

Press the Service Performed button each time the item is serviced. This will reset the mileage for the Next Service.

NOTE: Refer to your vehicle user manual to determine what interval is recommended for each Maintenance Item.

Based on the Odometer value you previously input, and the Interval value above, the Service Mileage that will read on the vehicle odometer at the time of required service will be calculated and displayed.

Mileage Coach

Mileage Coach Set Up

The Mileage Coach feature provides useful tips and tools that help you learn ways to improve your fuel mileage.

STEP 1 - Press the Home button to enter the Main Menu.

STEP 2 - Use the Up/Down arrow buttons to scroll down to the Mileage Coach option.

STEP 3 - Press Enter.



The Clear Fuel Average option clears the calculated average displayed in the Mileage Average PID.

The Last Fuel Economy option allows you to enter your actual Fuel Economy value. This value is important and should be calculated and entered regularly. This can be manually calculated by dividing the distance travelled by how much fuel you have used ($\text{Distance}/\text{Fuel} = \text{Fuel Economy}$). Some vehicles have their own Fuel Economy average that is displayed in cab and may be used instead of a manual calculation.



The Trip Odometer is used to calculate the Trip Cost and Fuel Average.

The Mileage Cost is a calculated average based on how many miles you have traveled and the Fuel Price you entered.

The Trip Cost is calculated from the Fuel Price and the Trip Odometer values.

There are two ways to display the Mileage Coach PID:

Show Difference

Displays the difference between Instantaneous and Average fuel mileage.

Show Values

Displays as: Instantaneous | Average.



The Fuel Price is used to calculate your Mileage and Trip Costs.

Mileage Driving Tips are intended to give you general information regarding driving habits or anything that will help maximize your fuel economy and overall driving experience.

STEP 4 - Refer to the Individual Gauge Set Up section of this manual to display one or both Mileage Coach PIDs on the main gauge screen.

Mileage Average displays the calculated average MPG or L/100km and is updated continuously while driving. The average is calculated only when the PID is being displayed on the main Gauge Screen. This value will typically change more during start/stop driving, and less on the highway.

Mileage Instantaneous - shows a conscientious driver how to vary the pressure on the gas pedal to save fuel every second. The value is displayed in either MPG or L/100km.

Mileage Coach - takes the Average and Instantaneous values mentioned above and creates a visual tool to help maximize your fuel economy. This PID is best viewed using one of the Analog Gauge locations.

Service Center and Compatibility Cautions

CAUTION: RETURN YOUR VEHICLE TO STOCK BEFORE TAKING IT TO A SERVICE CENTER. All Superchips modules and programmers are built to operate with OEM calibrations. If you take your vehicle to a service center they may, by your request or otherwise, update your vehicle's calibrations. If this happens and your vehicle has not been returned to stock your device will no longer be capable of programming your vehicle. Therefore it is important that you return your vehicle to stock before taking it in for service. Superchips updates its active products (i.e. those currently being manufactured) to work effectively with updated OEM calibrations. However, this process can take some time as Superchips is not always made aware of calibration changes made by the OEM. In the case of discontinued products, Superchips cannot ensure that your unit will work effectively if you take your vehicle to a dealership and you are given, by your request or otherwise, a new calibration.

CAUTION: If you have used another tuner/programmer on your vehicle, you will need to program the vehicle back to stock and remove the device before using the Superchips product. Failure to return to stock may result in PCM failure or engine damage. Programming your vehicle may expose existing defects in the vehicle's PCM that could disable your vehicle. It is advised that you do not program your vehicle in remote locations in case of vehicle failure.

CAUTION: The Dashpaq programmer was developed on a stock vehicle with no aftermarket bolt-on parts; as such, the performance changes implemented by the Dashpaq may not be compatible with certain aftermarket power add-ons. See below for a brief explanation of how the Dashpaq tuning may be affected by certain aftermarket devices.

Cold Air Intake (CAI) Kits

Most modern-day vehicles use a Mass Air Flow (MAF) sensor. The MAF sensor is generally located in the intake tube close to the factory air box. MAF sensors play a key role in determining the amount of fuel an engine needs at any given throttle position. MAF sensors are precisely calibrated for the factory intake systems; changes in intake tube diameter, sensor placement, or filter flow characteristics can adversely affect the reading from the MAF sensor. Most of the CAI kits on the market change intake tube diameter, sensor placement, or filter restriction. These changes may cause

the sensor to command leaner fuel conditions. Most of the CAI kits on the market are developed on stock vehicles, where a leaner fuel curve may be acceptable. Due to the fact that the evolution already alters the vehicle's fueling strategies, CAI kits that create a leaner condition used in conjunction with the Dashpaq may cause the vehicle to run excessively lean. Excessively lean conditions can cause pre-ignition which can lead to detonation, a condition that could potentially damage an engine. There are currently a large number of CAI kits on the market. These kits are designed to improve air flow and temperature. Some of these kits may be compatible with the Dashpaq programmer; however others may cause a lean condition when used in conjunction with the Dashpaq tuning.

Mechanical Modifications

Mechanical modifications such as headers, upgraded camshafts, displacement changes, cylinder head improvements etc. will change the airflow characteristics of an internal combustion engine. The Dashpaq is not tailored to take advantage of these modifications, for the best results we recommend vehicle specific custom tuning.

Forced Induction (Turbochargers or Superchargers)

Turbochargers and Superchargers drastically change the dynamics/performance of the engine, and its fueling/timing needs. Additional hard parts and custom tuning are required to run a forced induction system on an engine that was originally designed as a Naturally Aspirated (NA) engine. The Dashpaq does not support the addition of an aftermarket forced induction kit.

Commonly Used Acronyms

ACT = Air Charge Temp	IVS = Idle Validation Switch (Diesel)
ACV = Air Control Sensor	KAM = Keep Alive Memory
AOD = Automatic Overdrive Transmission	KOEO = Key On Engine Off
APP = Accelerator Pedal Position	KOER = Key On Engine Running
BAT = Battery Voltage	KS = Knock Sensor
BCM = Body Control Module	LOAD = Engine Load
BOO = Brake On/Off Switch	LOS = Limited Operation Strategy
BP = Barometric Pressure Sensor	LPD = Line Pressure Desired
CCD = Computer Controlled Dwell	LUS = Lock-up Solenoid
CCO = Converter Clutch Override	MAF = Mass Airflow
CDR = Crankcase Depression Regulator	MAFV = Mass Airflow Sensor Voltage
CEL = Check Engine Light	MAP = Manifold Absolute Pressure
CFI = Central Fuel Injection	MAT = Manifold Air Temp
CHT = Cylinder Head Temperature	MCU = Microprocessor Control Unit
CID = Cylinder Identification Sensor	MIL = Malfunction Indicator Light
CKP = Crank Position Sensor	MPH = Miles Per Hour
CMP = Cam Position Sensor	OHC = Over Head Camshaft
CPS = Crankshaft Position Sensor	OSS = Output Shaft Speed
CS = Color Screen	PCM = Powertrain Control Module
CTS= Color Touch Screen	PFE = Pressure Feedback EGR Sensor
DPF = Diesel Particulate Filter	PIP = Profile Ignition Pickup
DTC = Diagnostic Trouble Codes	PSPS = Power Steering Pressure Switch
EAS= (Edge)Expandable Accessory System	RPM = Revolutions Per Minute
ECA = Electronic Control Assembly	SES = Service Engine Soon
ECM = Electronic Control Module	SIL = Shift Indicator Light
ECT = Engine Coolant Temp	SPARK = Spark Advance/Retard
EDF = Electric Drive Fan Relay	SPOUT = Spark Output Signal
EDIS = Electronic Distributor	STAR = Self Test Automatic Readout
EGO = Exhaust Gas Oxygen Sensor	TAPS = Throttle Angle Position Sensor
EGR = Exhaust Gas Recirculation	TCM = Transmission Control Module
EGRC = EGR Control Solenoid	TFI = Thick Film Ignition System
EOT = Engine Oil Temperature	TFT = Transmission Fluid Temperature
EVP = EGR Position Sensor	TGS = Top Gear Switch
EVR = EGR Valve Regulator	TPS = Throttle Position Sensor
FDM = Fuel Delivery Module	TQC = Torque Control
FPM = Fuel Pump Monitor	TSS = Turbine Shaft Speed
FRP = Fuel Rail Pressure	TTS = Transmission Temperature Switch
HEGO = Heated Exhaust Gas Sensor	VAF = Vane Air Flow Sensor
IAT = Intake Air Temperature	VAT = Vane Air Temperature
ICM = Integrated Controller Module	VCT = Variable Cam Timing
IDM = Ignition Driver Module	VSS = Vehicle Speed Sensor
ISC = Idle Speed Control	WAC = WOT A/C Cut-off Switch
ITS = Idle Tracking Switch	WOT = Wide Open Throttle

Trouble Shooting Guide

SYMPTOM	POSSIBLE CAUSE	SOLUTION
Display beeps for two seconds	The unit is too hot due to direct sunlight	Once cooled, the display will turn on
No display when the key is "on"	The screen has not yet been activated	Touch the screen or start the vehicle
Fusion drivers will not install correctly	The drivers were not successfully installed	Manually install the drivers
Camera picture is frozen	Bad connections	Double check your fuse and connections
Display beeps quickly	Possible device malfunction	Update the device using Fusion software
Unit will not power on after vehicle is started or after screen or buttons are pressed	Typically this issue is caused by a blown OBDii/Cigarette Lighter Fuse	Replace fuse and test unit again
On Star®: Unable to receive monthly On Star® e-mail reports	Having the display plugged into your OBDii port may disturb On Star while gathering information for their reports.	Unfortunately, there is no real solution for this issue. You could try and call On Star to see when they gather their reports, and unplug your device during that time. This may or may not work for you.
Vehicle does not start after programming	The calibration may not have written properly	Select "Return to Stock" from the programming menu. Then program back to stock. Next, start the vehicle. If the problem continues, contact customer support.
Error 16 when programming	There was a communication error	Try to program the level again
<p>Dashpaq Programming Errors:</p> <ol style="list-style-type: none"> 1. Your device gest stuck on the "Uploading Boatloader" screen 2. An error is displayed: "ERROR-we could not upload the bootloader to the vehicle..." 3. If you are constantly asked to make sure your key is on. 4. Error displayed after you device shows blank gauges and says that it is loading. The error will be displayed as " Cannot communicate with vehicle, ensure the key is in the on position..." 	<p>Sometimes programming can be disrupted by installed aftermarket devices that are tapped into the trucks communication lines (J1850). These may include but are not limited to aftermarket radios, chime boxes, remote starters, etc.</p> <p>Also, any power consuming devices should not be plugged into the cigarette adapter during the programming process. Fluctuations in power may disrupt the programming process.</p>	<p>The following solutions are good first steps to getting around these programming errors. If these steps do not solve your problem, please contact customer support.</p> <p>FUSES: (CAUTION: Always turn the key off while unplugging fuses).</p> <ol style="list-style-type: none"> 1. Remove fuses connecting radio, radio amplifier, satellite radio, remote starter, or any other aftermarket device you have installed on your vehicle. <p>POWER:</p> <ol style="list-style-type: none"> 1. Close all doors during programming. 2. Do not operate electrical accessories (radio, windows, wipers, etc.) 3. Remove any devices plugged into the cigarette lighter or any other auxiliary power port.

OEM EGT Locations - Diesel Trucks Only

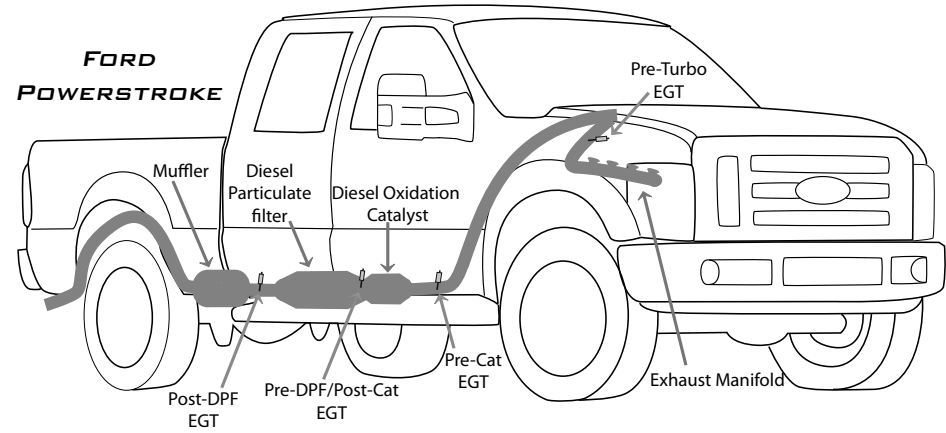
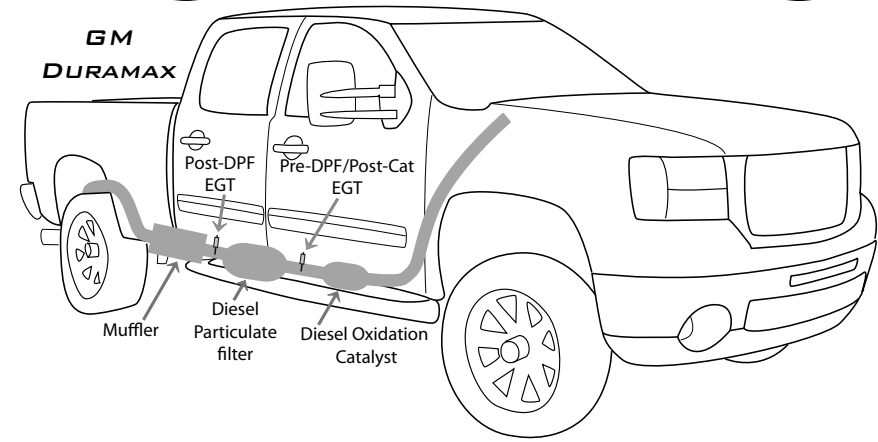
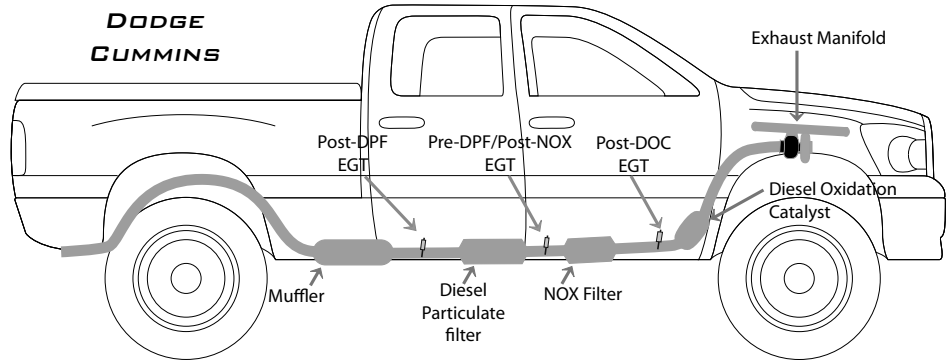

CARB/EPA Compliance

If a “CARB E.O.” sticker is included with your device, your product meets the emissions compliance requirements of the California Air Resources Board and Federal Environmental Protection Agency and is legal for sale and use on pollution-controlled vehicles operated on public streets and highways.

The device must be installed and operated according to the instructions provided in this manual. The sticker can either be applied somewhere on the vehicle (e.g., the inside end of driver’s door) or simply stored in your glove box. The purpose of this sticker is to inform anyone who may have questions regarding the use of your Superchips product and how it affects emissions. For example, it would be something to show an emissions technician if questioned when taking your vehicle in for an emissions check to let him/her know the product is CARB emissions compliant.

