

# SUNEX<sup>HD</sup>

**GUARANTEED TO PERFORM**

**66037JPK**  
**CAPACITY: 3.5 TON**  
**SERVICE JACK WITH**  
**6 TON JACK STANDS (PAIR)**

**ANUAL**

**CONTENTS:**

Page 1 Specifications  
 2 Warning Information (Service Jack)  
 3 Warning Information (Jack Stands)  
 4 Setup Instructions and Operating Instructions  
 5 Preventative Maintenance, Inspection, Proper Storage, Troubleshooting, and Owner/User Responsibility  
 6 Hydraulic Jack Maintenance Guide and Regular Maintenance  
 7 Warranty Information  
 8 Exploded View Drawing and Replacement Parts (Service Jack and Stands)  
 9 Exploded View Drawing and Replacement Parts (Power Unit)



**66037 Rev. A**



**1006 Rev. B**

**SERVICE JACK SPECIFICATIONS**

<b>66037 Rev. A</b>	
Capacity.....	3.5 Ton
Low Height.....	4"
High Height.....	19.5"
Overall Length.....	30.6"
Overall Width.....	14.3"
Handle Length.....	50"
Shipping Weight.....	109 lbs.

**JACK STAND SPECIFICATIONS**

<b>1006 Rev. B</b>	
Capacity.....	6 Ton
Low Height.....	15.75"
High Height.....	24"
Overall Length.....	10.375" x 11.5"
Shipping Weight.....	32.5 lbs.

**Complies with ASME PASE-2014 Safety Standard**

## WARNING INFORMATION - FLOOR SERVICE JACK



This is the safety alert symbol. It is used to alert you to potential personal injury hazards. Obey all safety messages that follow this symbol to avoid possible injury or death.

### ⚠️ WARNING

WARNING: Indicates a hazardous situation which, if not avoided, could result in death or serious injury.



### IMPORTANT: READ THESE INSTRUCTIONS BEFORE OPERATING

BEFORE USING THIS DEVICE, READ THIS MANUAL COMPLETELY AND THOROUGHLY, UNDERSTAND ITS OPERATING PROCEDURES, SAFETY WARNINGS AND MAINTENANCE REQUIREMENTS.

It is the responsibility of the owner to make sure all personnel read this manual prior to using the device. It is also the responsibility of the device owner to keep this manual intact and in a convenient location for all to see and read. If the manual or product labels are lost or not legible, contact Sunex for replacements. If the operator is not fluent in English, the product and safety instructions shall be read to and discussed with the operator in the operator's native language by the purchaser/owner or his designee, making sure that the operator comprehends its contents.



## THE NATURE OF HAZARDOUS SITUATIONS

### ⚠️ WARNING

The use of portable automotive lifting devices is subject to certain hazards that cannot be prevented by mechanical means, but only by the exercise of intelligence, care, and common sense. It is therefore essential to have owners and personnel involved in the use and operation of the equipment who are careful, competent, trained, and qualified in the safe operation of the equipment and its proper use. Examples of hazards are dropping, tipping or slipping of loads caused primarily by improperly securing loads, overloading, off-centered loads, use on other than hard level surfaces, and using equipment for a purpose for which it was not designed.

## METHODS TO AVOID HAZARDOUS SITUATIONS

### ⚠️ WARNING

-  Read, study, understand and follow all instructions before operating this device.
- Inspect the jack before each use. Do not use jack if damaged, altered, modified, in poor condition, leaking hydraulic fluid, or unstable due to loose or missing components. Make corrections before using.
- Lift only on areas of the vehicle as specified by the vehicle manufacturer.
-  Wear eye protection that meets ANSI Z87.1 and OSHA standards (users and bystanders).
- Do not use jack beyond its rated capacity. Do not shock Load.
-  **This is a lifting device only. Immediately after lifting, support the vehicle with jack stands capable of sustaining the load before working on the vehicle.**
- Use only on a hard level surface free from obstructions so the jack is free to reposition itself during lifting and lowering operations.
- Center load on saddle. Be sure setup is stable before working on vehicle.
- Do not move or dolly the vehicle while on the jack.
- Do not use any materials that may serve as risers, spacers or extenders between the stock lifting saddle and the load.
- Do not use any adapters that replace the stock lifting saddle unless approved or supplied by the jack manufacturer.
- Do not use (or modify) this product for any other purpose than that for which it was designed without consulting the manufacturer's authorized representative.
- Always lower the jack slowly and carefully.
- This product may contain one or more chemicals known to the State of California to cause cancer and birth defects or other reproductive harm. *Wash hands thoroughly after handling.*
- Handling the brass parts of this product will expose you to lead, a chemical known to the State of California to cause birth defects and other reproductive harm. *Wash hands after handling.*
- Failure to heed these warnings may result in serious or fatal personal injury and/or property damage.

## CONSEQUENCES OF NOT AVOIDING HAZARDOUS SITUATIONS

### ⚠️ WARNING

Failure to read this manual completely and thoroughly, failure to understand its OPERATING INSTRUCTIONS, SAFETY WARNINGS, MAINTENANCE INSTRUCTIONS and comply with them, and failure to comply with the METHODS TO AVOID HAZARDOUS SITUATIONS could cause accidents resulting in serious or fatal personal injury and/or property damage.

## WARNING INFORMATION - JACK STANDS



This is the safety alert symbol. It is used to alert you to potential personal injury hazards. Obey all safety messages that follow this symbol to avoid possible injury or death.

### WARNING

WARNING: Indicates a hazardous situation which, if not avoided, could result in death or serious injury.



### IMPORTANT: READ THESE INSTRUCTIONS BEFORE OPERATING

BEFORE USING THIS DEVICE, READ THIS MANUAL COMPLETELY AND THOROUGHLY, UNDERSTAND ITS OPERATING PROCEDURES, SAFETY WARNINGS AND MAINTENANCE REQUIREMENTS.

It is the responsibility of the owner to make sure all personnel read this manual prior to using the device. It is also the responsibility of the device owner to keep this manual intact and in a convenient location for all to see and read. If the manual or product labels are lost or not legible, contact Sunex for replacements. If the operator is not fluent in English, the product and safety instructions shall be read to and discussed with the operator in the operator's native language by the purchaser/owner or his designee, making sure that the operator comprehends its contents.





## THE NATURE OF HAZARDOUS SITUATIONS

### WARNING

The use of portable automotive lifting devices is subject to certain hazards that cannot be prevented by mechanical means, but only by the exercise of intelligence, care, and common sense. It is therefore essential to have owners and personnel involved in the use and operation of the equipment who are careful, competent, trained, and qualified in the safe operation of the equipment and its proper use. Examples of hazards are dropping, tipping or slipping of loads caused primarily by improperly securing loads, overloading, off-centered loads, use on other than hard level surfaces, and using equipment for a purpose for which it was not designed.

## METHODS TO AVOID HAZARDOUS SITUATIONS

### WARNING

-  • Read, study, understand and follow all instructions before operating this device.
-  • Inspect the jack stands before each use. Do not use jack stands if damaged, altered, modified, in poor condition, or unstable due to loose or missing components. Make corrections before using.
-  • Wear eye protection that meets ANSI Z87.1 and OSHA standards (users and bystanders).
-  • Do not use jack stands beyond the pair's rated capacity. Do not shock Load.
-  • **Do not crawl under the vehicle while lifting vehicle or placing or removing the jack stands.**
- Use as a matched pair only.
- Maximum load capacity per matched pair shall not exceed the rated capacity of the individual stand.
- Use only on a hard level surface capable of supporting the load.
- Stands are to be used in matched pairs to support one end of a vehicle only. Do not simultaneously support both ends or one side of a vehicle.
- Apply the emergency brake and put the gear shift lever in park or in gear if a manual shift transmission, and chock the tires that will not be lifted off the ground.
- Ensure both stands are set at same height and locking pawls are fully engaging the support column's teeth.
- Consult the vehicle manufacturer for the proper frame support locations.
- Center load on saddle. Do not use saddle lugs to support the load.
- Check the stands for solid contact with the ground and vehicle. Make sure the stands' locking pawls are fully engaging the support columns' teeth.
- Do not use (or modify) this product for any other purpose than that for which it was designed without consulting the manufacturer's authorized representative.
- This product may contain one or more chemicals known to the State of California to cause cancer and birth defects or other reproductive harm. *Wash hands thoroughly after handling.*
- Handling the brass parts of this product will expose you to lead, a chemical known to the State of California to cause birth defects and other reproductive harm. *Wash hands after handling.*
- Failure to heed these warnings may result in serious or fatal personal injury and/or property damage.

## CONSEQUENCES OF NOT AVOIDING HAZARDOUS SITUATIONS

### WARNING

Failure to read this manual completely and thoroughly, failure to understand its OPERATING INSTRUCTIONS, SAFETY WARNINGS, MAINTENANCE INSTRUCTIONS and comply with them, and failure to comply with the METHODS TO AVOID HAZARDOUS SITUATIONS could cause accidents resulting in serious or fatal personal injury and/or property damage.

## OWNER'S MANUAL

### JACK STAND ASSEMBLY INSTRUCTIONS

1. Install the support column in the stand where the support column teeth are facing toward the stand's locking pawl.
2. Raise the stand's locking handle to allow the column to go to its lowest position.
3. In order to prevent removal of the support column from the stand, use a hammer and flat end punch to hammer the jack's tab in toward the column but not touching the column. Some stands are equipped with a bolt instead of a tab. In this case the bolt can be threaded in toward the column until the bolt bottoms out.

### JACK SETUP

#### PLEASE REFER TO THE EXPLODED VIEW DRAWING IN THIS MANUAL IN ORDER TO IDENTIFY PARTS.

1. Depress the spring button at the bottom of the upper handle half (#13) and insert it in the lower handle half (#15) until the spring button engages the hole in the lower handle half.
2. Remove the handle set screw (#17) from the handle yoke (#18). Install the assembled handle into the handle yoke (#18) making sure the bottom of the handle engages the release valve u-joint (#19).
3. Install the handle set screw (#17) in the handle yoke (#18) and tighten the screw to secure the handle in the yoke.
4. Air may become trapped in the hydraulic system during shipping and handling. Trapped air will affect the pumping performance of the jack. If this occurs, follow the air purging procedure below:
  - a) Remove the four screws that secure the cover plate (#22) to the jack frame (#4) so the oil fill screw (#21 - page 9) can be removed from the hydraulic power unit reservoir tube (#38 - page 9).
  - b) With the lift arm (#27) in its down position, look inside the oil fill screw hole. You should be able to see the top of the power unit's cylinder (#29 - page 9). The hydraulic fluid level should be no higher than the top of the cylinder. Correct the fluid level if it is not at the proper height.
  - c) Pump the jack against a load that is at least 500 lbs. (225 Kgs). After the load is raised, slightly turn the pump handle in a counterclockwise rotation so the load is very slowly lowered. While the lift arm is lowering, quickly pump the handle 5 or 6 full incremental pump strokes. After pumping, lower the lift arm to its full rest position.
  - d) Install the oil fill screw (#21 - page 9). Rotate the handle in a clockwise rotation until tight and pump the lift arm to maximum height. Repeat steps "a" through "d" until all of the air has been purged from the system.
  - e) Install the cover plate (#22) with the four screws.

### OPERATING INSTRUCTIONS



This is the safety alert symbol used for the OPERATING INSTRUCTIONS section of this manual to alert you to potential personal injury hazards. Obey all instructions to avoid possible injury or death.

**IMPORTANT:** Before attempting to raise any vehicle, check vehicle service manual for recommended lifting surfaces.

#### JACK STAND OPERATION:

1. Make sure the work floor is clean and free of debris and obstacles.
2. Chock the vehicle's tires that will not be lifted. Make sure the emergency brake is on and the vehicle's transmission is either in the park mode or gear if a manual transmission.
3. Raise the vehicle to a safe working height and make sure the jack and vehicle setup are stable before positioning the jack stands. **DO NOT CRAWL UNDER THE VEHICLE TO POSITION OR REMOVE STANDS.**
4. Position the jack stands right below the areas of the vehicle support points as specified by the vehicle manufacturer.
5. Lift the support columns as close to the vehicle as possible without the saddles on the columns coming in contact with the vehicle. Make sure the support columns' teeth are engaged with the locking pawls.

#### JACK OPERATION:

1. **To raise load:** Turn the handle in a clockwise direction until tight. Position the jack under the load. Proceed to pump the handle in order to raise the lift arm to the load. As the saddle at the end of the lift arm gets closer to the load, reposition the jack so the saddle will contact the load firmly and the load is centered on the saddle. Make sure the saddle is correctly positioned. Raise the load to the desired work height. Place jack stands of appropriate capacity at the vehicle manufacturers's recommended support areas that provide stable support for the raised vehicle. **DO NOT CRAWL UNDER VEHICLE WHILE LIFTING VEHICLE OR PLACING OR REMOVING THE JACK STANDS!** Once jack stands are positioned and stand columns raised to the proper height, turn the jack handle VERY SLOWLY. Lower the load to rest on the jack stands. Inspect the relationship between the jack stands and load to make sure the setup is stable and safe. If the setup is not stable or safe, follow the preceding steps until corrected.
2. **To lower load:** Follow the procedures mentioned in "To raise load" section of the OPERATING INSTRUCTIONS in order to raise the load off the jack stands. Once the load has cleared the jack stands, remove the stands from under the load and away from the work area. Turn handle very slowly in a counterclockwise direction until the load is completely lowered to the ground. Once the jack's lifting saddle has cleared the load, remove the jack from under the load. **CAUTION:** Keep hands and feet away from the hinge mechanism of the jack. **DO NOT CRAWL UNDER VEHICLE WHILE LIFTING VEHICLE OR PLACING OR REMOVING THE JACK STANDS!**

## OWNER'S MANUAL

### PREVENTATIVE MAINTENANCE



This is the safety alert symbol used for the PREVENTATIVE MAINTENANCE section of this manual to alert you to potential personal injury hazards. Obey all instructions to avoid possible injury or death.

1. Always store the jack and jack stands in a well protected area where they will not be exposed to inclement weather, corrosive vapors, abrasive dust, or any other harmful elements. The jack and jack stands must be cleaned of water, snow, sand, grit, oil, grease or other foreign matter before using.
2. The jack must be lubricated periodically in order to prevent premature wearing of parts. A general purpose grease must be applied to all zerk grease fittings, caster wheels, front axle, lift arm, handle base pivot bolts, release mechanism and all other bearing surfaces. Worn parts resulting from inadequate or no lubrication are not eligible for warranty consideration. See page 6 for lubrication instructions.
3. It should not be necessary to refill or top off the reservoir with hydraulic fluid unless there is an external leak. An external leak requires immediate repair which must be performed in a dirt-free environment by an authorized service center.

**IMPORTANT:** In order to prevent seal damage and jack failure, never use alcohol, hydraulic brake fluid or transmission oil in the jack. Use Chevron Hydraulic Oil AW ISO 32 or its equivalent Unocal Unax AW 150.

4. Every jack and jack stand owner is responsible for keeping the jack labels clean and readable. Use a mild soap solution to wash external surfaces of the jack but not any moving hydraulic components.
5. Inspect the jack and jack stands before each use. Do not use the jack and jack stands if any component is cracked, broken, bent, shows sign of damage or leaks hydraulic fluid. Do not use the jack if it has loose or missing hardware or components, or is modified in any way. Take corrective action before using the jack again.
6. Any hydraulic repairs within the warranty period must be performed by an authorized service center.

### INSPECTION

Visual inspection should be made before each use of the jack and stands, checking for leaking hydraulic fluid and damaged, loose or missing parts. Jack and stands must be inspected by a manufacturer's repair facility immediately if subjected to an abnormal load or shock. Any jack or stands which appear to be damaged in any way, are found to be badly worn, or operate abnormally **MUST BE REMOVED FROM SERVICE** until necessary repairs are made by a manufacturer's authorized repair facility. It is recommended that an annual inspection of the jack and stands be made by a manufacturer's authorized repair facility and that any defective parts, decals or warning labels be replaced with manufacturer's specified parts. A list of authorized repair facilities is available from the manufacturer.

### PROPER STORAGE

It is recommended that the jack and jack stands be stored in a dry location with all wheels and stand legs touching the ground on a relatively level surface.

### TROUBLESHOOTING

Important: Service jacks are self-contained devices used for lifting, but not sustaining, a partial vehicular load. In accordance with ASME-PASE Load Sustaining Test: "A load not less than the rated capacity...shall not lower more than 1/8" (3.18mm) in the first minute, nor a total of .1875" (4.76mm) in 10 minutes." Lowering within this range is considered normal operation and is NOT a warrantable defect.

PROBLEM	ACTION
1. Unit will not lift rated load.	Purge air from hydraulic system by following procedure under SETUP.
2. Unit will not sustain rated load or feels "spongy" under rated load.	Purge air from hydraulic system as above.
3. Unit will not lift to full height.	Purge air from hydraulic system as above.
4. Handle tends to raise up while the unit is under rated load.	Pump the handle rapidly several times to push oil past ball valves in power unit.
5. Unit still does not operate.	Contact Sunex authorized hydraulic service center.

### OWNER/USER RESPONSIBILITY

The owner and/or user must have an understanding of the manufacturer's operating instructions and warnings before using this jack. Personnel involved in the use and operation of equipment shall be careful, competent, trained, and qualified in the safe operation of the equipment and its proper use when servicing motor vehicles and their components. Warning information should be emphasized and understood. If the operator is not fluent in English, the manufacturer's instructions and warning shall be read to and discussed with the operator in the operator's native language by the purchaser/owner, making sure that the operator comprehends its contents. Owner and/or user must study and maintain for future reference the manufacturers' instructions. Owner and/or user is responsible for keeping all warning labels and instruction manuals legible and intact. Replacement labels and literature are available from the manufacturer.

# SUNEXHD<sup>®</sup>

**GUARANTEED TO PERFORM**

**66037JPK**  
**CAPACITY: 3.5 TON**  
**SERVICE JACK WITH**  
**6 TON JACK STANDS (PAIR)**

## LIMITED WARRANTY

### HYDRAULIC JACK MAINTENANCE GUIDE

**IMPORTANT:** Service jacks are designed for lifting purposes only; always support raised load with jack stands.

#### REGULAR MAINTENANCE

- MONTHLY or as necessary (depending on usage)
  1. Using a grease gun, add grease to grease fitting in the lift arm pivot shaft.  
(Use a multi-purpose NLGI type grease only.)
  2. Lubricate all linkages and pivot points.  
(Use white lithium spray grease only.)
  3. Remove handle; lubricate handle receptacle and handle end.  
(Use white lithium spray grease only.)
  4. Lubricate both rear casters, bearing and both front wheels.  
(Use white lithium spray grease only.)
  5. Tighten all accessible hardware.

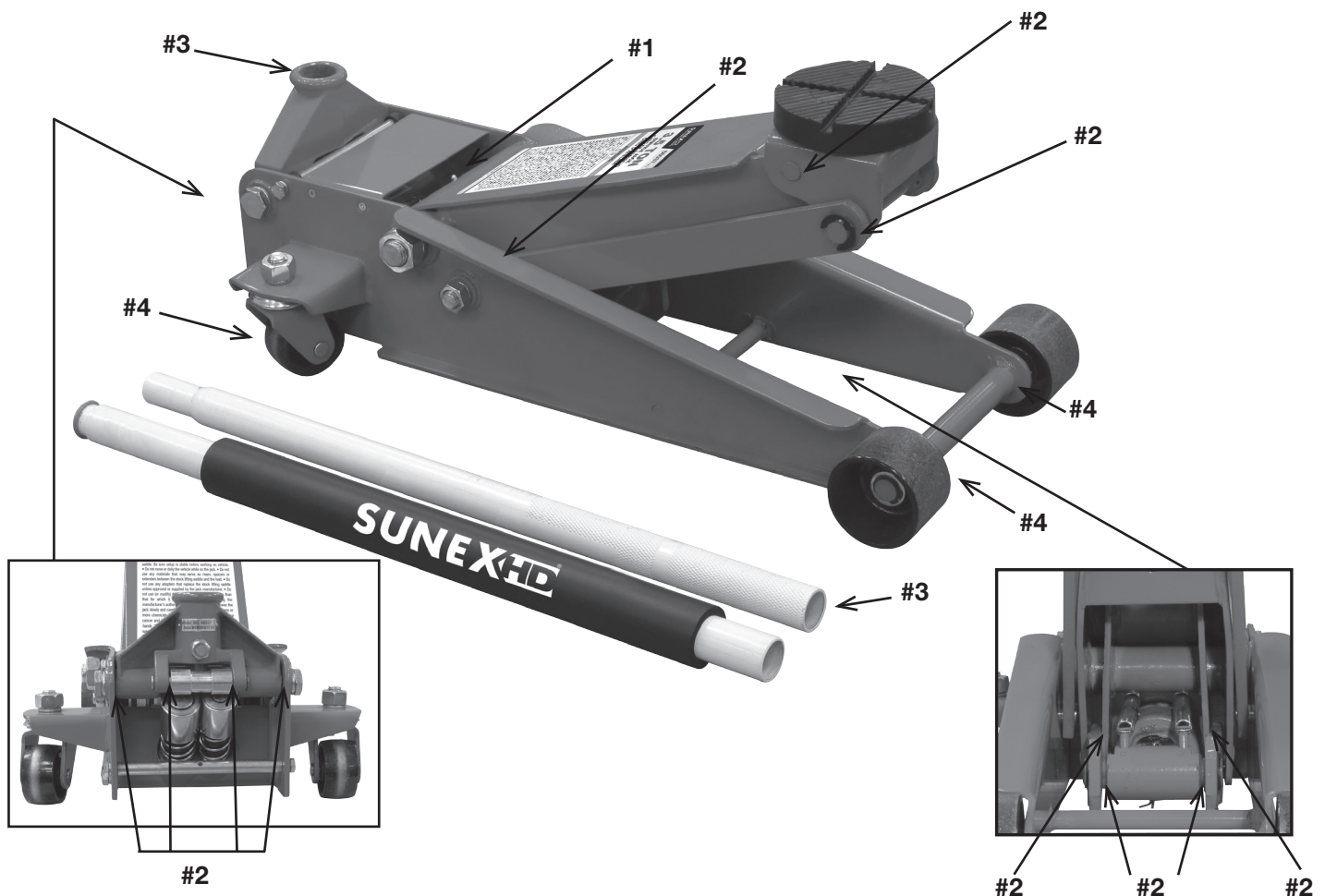

Discover other car jacks on our website.