

MANUAL

CONTENTS:

Page 1 Specifications
 2 Warning Information
 3 Setup and Operating Instructions
 4 Preventative Maintenance and Troubleshooting
 5 4404 Exploded View Drawing and Parts List
 6 Warranty Information



4404 - SPECIFICATIONS

Capacity.....	4 ton
Power Lift.....	7.1"
Closed Height.....	7.6"
Raised Height.....	14.7"
Base Size.....	4.3" x 4"
Shipping Weight.....	7.5 lbs

Complies with ASME PASE/2014 Safety Standard

WARNING INFORMATION



This is the safety alert symbol. It is used to alert you to potential personal injury hazards. Obey all safety messages that follow this symbol to avoid possible injury or death.

⚠️ AVERTISSEMENT

WARNING: Indicates a hazardous situation which, if not avoided, could result in death or serious injury.

IMPORTANT: READ THESE INSTRUCTIONS BEFORE OPERATING

BEFORE USING THIS DEVICE, READ THIS MANUAL COMPLETELY AND THOROUGHLY, UNDERSTAND ITS OPERATING PROCEDURES, SAFETY WARNINGS AND MAINTENANCE REQUIREMENTS.

It is the responsibility of the owner to make sure all personnel read this manual prior to using the device. It is also the responsibility of the device owner to keep this manual intact and in a convenient location for all to see and read. If the manual or product labels are lost or not legible, contact Sunex for replacements. If the operator is not fluent in English, the product and safety instructions shall be read to and discussed with the operator in the operator's native language by the purchaser/owner or his designee, making sure that the operator comprehends its contents.

THE NATURE OF HAZARDOUS SITUATIONS

⚠️ AVERTISSEMENT

The use of portable automotive lifting devices is subject to certain hazards that cannot be prevented by mechanical means, but only by the exercise of intelligence, care, and common sense. It is therefore essential to have owners and personnel involved in the use and operation of the equipment who are careful, competent, trained, and qualified in the safe operation of the equipment and its proper use. Examples of hazards are dropping, tipping or slipping of loads caused primarily by improperly securing loads, overloading, off-centered loads, use on other than hard level surfaces, and using equipment for a purpose for which it was not designed.

METHODS TO AVOID HAZARDOUS SITUATIONS

⚠️ AVERTISSEMENT



- Read, study, understand and follow all instructions before operating this device.

- Inspect the jack before each use. Do not use jack if damaged, altered, modified, in poor condition, leaking hydraulic fluid, or unstable due to loose or missing components. Make corrections before using.



- Lift only at points of the vehicle as specified by the vehicle manufacturer.

- User and bystanders must wear eye protection that meets ANSI Z87.1 and OSHA standards.

- Do not exceed rated capacity.



- No persons should be under vehicle when jack is in use.

- **This is a lifting device only. Immediately after lifting, support the vehicle with appropriate means.**

- No alterations shall be made to this product.

- Use only on a hard level surface.

- Always lower the jack slowly and carefully.

- Do not use saddle adaptors or saddle extenders between the stock lifting saddle and the load.

- Center load on saddle. Be sure setup is stable before working on vehicle.

- This product may contain one or more chemicals known to the State of California to cause cancer and birth defects or other reproductive harm. *Wash hands thoroughly after handling.*

- Failure to heed these warnings may result in serious or fatal personal injury and/or property damage.

CONSEQUENCES OF NOT AVOIDING HAZARDOUS SITUATIONS

⚠️ WARNING

Failure to read this manual completely and thoroughly, failure to understand its OPERATING INSTRUCTIONS, SAFETY WARNINGS, MAINTENANCE INSTRUCTIONS and comply with them, and failure to comply with the METHODS TO AVOID HAZARDOUS SITUATIONS could cause accidents resulting in serious or fatal personal injury and/or property damage.

OWNER'S MANUAL

SETUP INSTRUCTIONS



This is the safety alert symbol used for the ASSEMBLY section of this manual to alert you to potential personal injury hazards. Obey all instructions to avoid possible injury or death.

1. Refer to the exploded view parts drawing in this manual to identify parts mentioned in this setup procedure.
2. The three piece handle can be slip fit together to form a complete handle length. Loosely slipping the pieces together will enable you to disconnect them at a later time for storage.
3. Sometimes air gets trapped in the hydraulic system during shipping and/or handling.

PURGING AIR FROM THE HYDRAULIC SYSTEM

- a. Attach the end of the handle to the jack's release valve and turn the handle in a counterclockwise direction two full revolutions.
- b. Install the handle in the pump handle receiver and pump the jack about 15 incremental pump strokes.
- c. Attach the end of the handle on the release valve again and turn the handle in a clockwise direction until tight.
- d. Proceed to pump the handle until the ram raises to maximum height.
- e. Repeat steps "a" through "d" until all air is purged from the system.

OPERATING INSTRUCTIONS



This is the safety alert symbol used for the OPERATING INSTRUCTIONS section of this manual to alert you to potential personal injury hazards. Obey all instructions to avoid possible injury or death.

IMPORTANT: Before attempting to raise any vehicle, check vehicle service manual for recommended lifting surfaces.

1. Become familiar with the identification and function of the operating jack components. The ram is the shaft that comes out of the jack when you activate the pump piston.
2. Chock the vehicle's tires that will not be lifted off the ground prior to lifting the vehicle and if available, apply the emergency brake or any other method of braking.
3. Position the jack at the designated lift point. Estimate the required ram travel to raise the vehicle to the desired height.
4. Turn the release valve in a clockwise direction until tight.
5. With the jack in the lowered position, place the jack under the vehicle, but do not put your body under the vehicle.
IMPORTANT: Use the vehicle manufacturer's recommended lifting procedures and lifting points before lifting loads.
6. Once the jack is in place, activate the pump until the top of the ram comes close to the designated lift point. Make sure the designated lift point is flat, parallel to the ground and free from grease, any kind of lubricant, and debris. Proceed with pumping the jack in order to lift the vehicle to the desired height. During lifting, inspect the position of the jack in relation to the ground and the ram in relationship to the load to prevent any unstable conditions from developing. If conditions look like they are becoming unstable, slowly lower the load and make appropriate setup corrections after the load is fully lowered.
7. When the vehicle or load is lifted to its desired height, immediately place safety support stands (jack stands) in their designated locations and adjust the stands' support columns up as close to the designated vehicle support points as possible. Although jack stands are individually rated, they are to be used in a matched pair to support one end of the vehicle only. Stands are not to be used to simultaneously support both ends or one side of a vehicle. Slowly and carefully turn the release knob in a counterclockwise direction to gently lower the vehicle onto the safety support stands (jack stands). Make sure the vehicle is safely supported by the safety support stands' (jack stands) saddles and not the locating lugs of the saddles. Inspect the relationship of the safety support stands (jack stands) with the ground and the safety support stand (jack stand) columns and saddles with the vehicle to prevent any unstable conditions. If conditions look unstable, close the jack's release valve and pump the jack to raise the vehicle off the safety support stands (jack stands). Make the appropriate setup changes, and slowly and carefully lower the vehicle onto the safety support stand saddles.
8. After the work is done, close the release valve and pump the jack until it is high enough to remove the vehicle or load from the safety support stand saddles. Be sure load is stable. If it is not, lower load back onto safety support stands. Make appropriate setup corrections and repeat the step again. Remove the safety support stands from under the vehicle, being very careful not to move the vehicle.
9. Turn the release valve in a counterclockwise direction very slowly and carefully to lower the vehicle or load down to the ground.

PREVENTATIVE MAINTENANCE



This is the safety alert symbol used for the PREVENTATIVE MAINTENANCE section of this manual to alert you to potential personal injury hazards. Obey all instructions to avoid possible injury or death.

IMPORTANT: Any jack found to be defective as a result of worn parts due to lack of lubrication, or hydraulic system contaminated with water, rust and/or foreign materials is not eligible for warranty consideration.

1. Always store the jack in a well protected area where it will not be exposed to inclement weather, corrosive vapors, abrasive dust, or any other harmful elements. The jack must be cleaned of water, snow, sand, grit, oil, grease or other foreign matter before using.
2. The jack must be lubricated periodically in order to prevent premature wearing of parts. A general purpose grease must be applied to all pivot points with exception to hydraulic components. Do not lubricate any portion of the lift saddle and make sure the saddle is free from grease, any kind of lubricant, or debris before using the jack.
3. It should not be necessary to refill or top off the reservoir with hydraulic fluid unless there is an external leak. An external leak requires immediate repair which must be performed in a dirt-free environment by qualified hydraulic repair personnel who are familiar with this equipment. Authorized Service Centers are recommended. **IMPORTANT:** In order to prevent seal damage and jack failure, never use alcohol, hydraulic brake fluid, or transmission oil in the jack. Use hydraulic jack oil.
4. Every jack owner is responsible for keeping the jack label clean and readable. Use a mild soap solution to wash external surfaces of the jack but not any moving hydraulic components.
5. Do not attempt to make any hydraulic repairs unless you are a qualified hydraulic repair person that is familiar with this equipment.

TROUBLESHOOTING

PROBLEM	ACTION
1. Unit will not lift rated load.	Purge air from hydraulic system by following procedure under SETUP.
2. Unit will not sustain rated load or feels "spongy" under rated load.	Purge air from hydraulic system as above.
3. Unit will not lift to full height.	Purge air from hydraulic system as above.
4. Handle tends to raise up while the unit is under rated load.	Pump the handle rapidly several times to push oil past ball valves in power unit.
5. Unit still does not operate.	Contact Sunex authorized hydraulic service center.

4404 PARTS DRAWING AND PARTS LIST

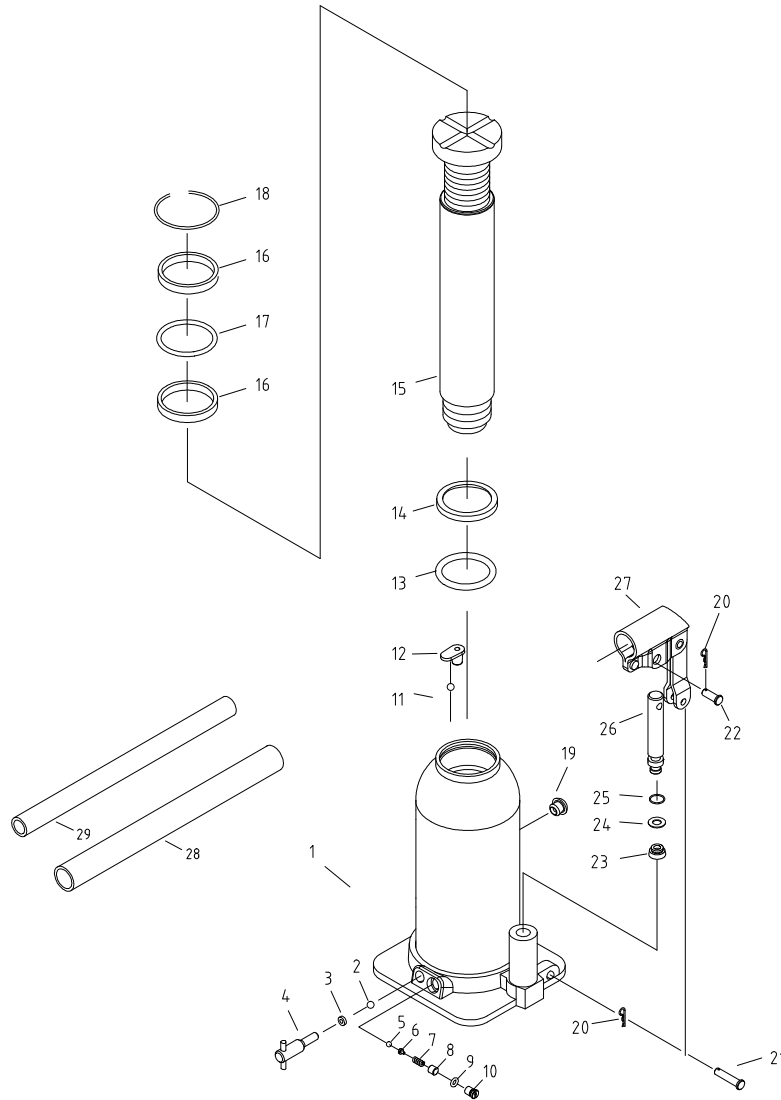

Ref No.	Part No.	Description	Qty	Ref No.	Part No.	Description	Qty
1		Main Cylinder Base	1	18	**	Retaining Ring	1
2	*	Check Ball	1	19	*	Fill Plug	1
3	*	O-Ring	1	20		Clip (incl. w/#27)	2
4	RS440404	Release Valve	1	21		Long Linkage Pin	1
5	*	Check Ball	1	22		Short Linkage Pin (incl. w/#27)	1
6	*	Ball Seat	1	23	*	Dust Cover	1
7	*	Overload Spring	1	24	*	Backup Ring	1
8	*	Adjustment Screw	1	25	*	O-Ring	1
9	*	O-Ring	1	26	RS440426	Pump Plunger	1
10		Cover Screw	1	27	RS440427	Handle Socket (incl. #20 & #22)	1
11	*	Check Ball	1	28	RS440428	Front Handle	1
12	*	Ball Retainer	1	29	RS440429	Rear Handle	1
13	*	O-Ring	1				
14	*	Backup Ring	1				
15	RS440415	Ram	1				
16	**	Cylinder Bearing	2				
17	*	O-Ring	1				

* Available in repair kit RS4404RK
 ** Available in hardware kit RS4404HK
 Product Label Kit RS4404PLK
 Only items identified by part number are available separately.