



***For ALL Your Air Suspension Needs!!!***

**1989-2008**

***Mercury Grand Marquis  
Ford Crown Victoria  
Lincoln Town Car***

**40F-15-R  
Rear Air Spring**





**For ALL Your Air Suspension Needs!!!**

**WARNING:**

**BEFORE YOU BEGIN THE REMOVAL OR INSTALLATION, READ ALL INSTRUCTIONS THOROUGHLY! THE WARRANTY WILL BE VOID IF INSTRUCTIONS ARE NOT FOLLOWED EXACTLY. DO NOT WORK UNDER CAR UNDER A VEHICLE SUPPORTED BY A JACK. ALWAYS SUPPORT THE VEHICLE ON SAFETY STANDS.**

**Removal and Installation**

**Removal**

**WARNING:**

- \* **Do not remove an air spring under any circumstances when there is pressure in the air spring. Do not remove any components supporting an air spring without either exhausting the air or providing support for the air spring to prevent vehicle damage or personal injury.**
  - \* **Disconnecting an air line that is connected to the air compressor can cause personal injury or damage to components as high pressure air is vented uncontrolled.**
- 1. WARNING:**
- \* **Do not attempt to install or inflate any rear air spring that has become unfolded to prevent vehicle damage or personal injury.**
  - \* **Failure to observe the following procedures may result in a sudden failure of the air spring or suspension system.**
  - \* **Any rear spring which is unfolded must be refolded prior to being installed in a vehicle.**
  - \* **The air spring refolding procedure should only be used for an air spring which has never supported the vehicle's weight while in the improperly folded position.**
  - \* **Improperly folded air springs found on vehicles during pre-delivery inspection or after use must be replaced.**
  - \* **Do not attempt to inflate any air spring which has been collapsed while uninflated from the rebound hanging position to the jounce stop.**
  - \* **When installing a new air spring, care must be taken not to apply a load to the suspension until springs have been inflated using the air spring fill procedure.**
  - \* **After inflating an air spring in the hanging position, it must be inspected for proper shape.**



**For ALL Your Air Suspension Needs!!!**

**Note: The vehicle must be positioned on a suitable lifting device prior to deflating the air suspension system.**

**Vent the air suspension system. Refer to Ride Height Adjustments.**

- 2. WARNING: Before performing maintenance on any air suspension components, disconnect the power to the system by turning off the air suspension switch located on the LH side of the luggage compartment to prevent vehicle damage or personal injury.**

**Turn the air suspension switch off.**

- 3. Raise and support the vehicle.**

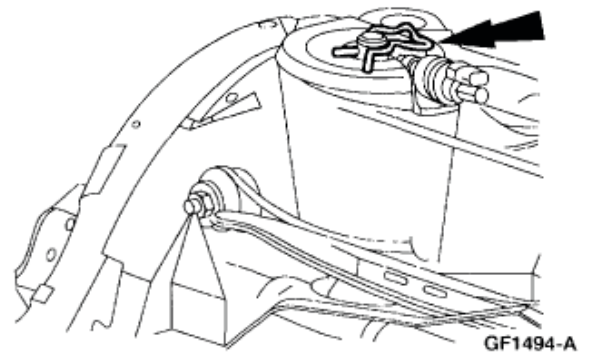

- 4. Remove the rear air spring retainer.**

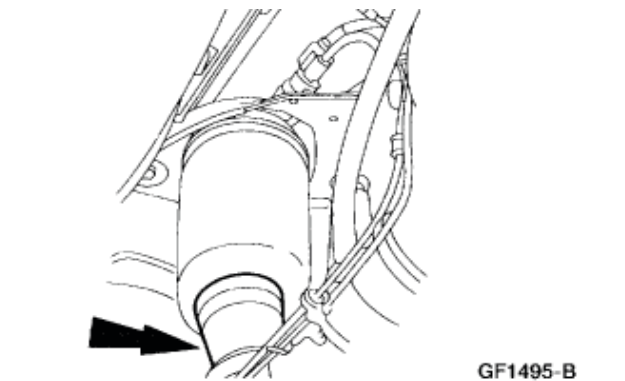

- 5. Lift the bottom of the air spring off the rear axle**

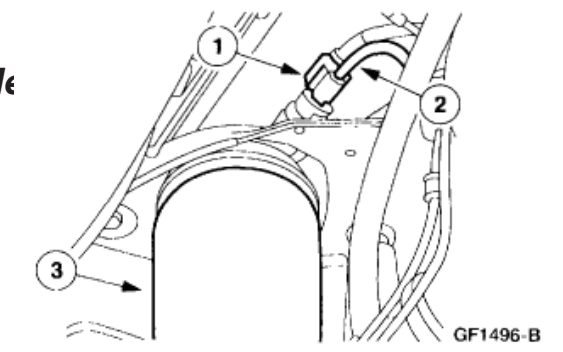



**For ALL Your Air Suspension Needs!!!**

- 6. Remove the air spring.**
- 1. Disconnect the electrical connector.**
- 2. (compress the quick connect locking ring and pull out the air line.)**
- 3. Remove the air spring.**

Check on the bottom of your new air spring if this clip is missing remove it from the old air spring with a flat head screwdriver and install on the new one.

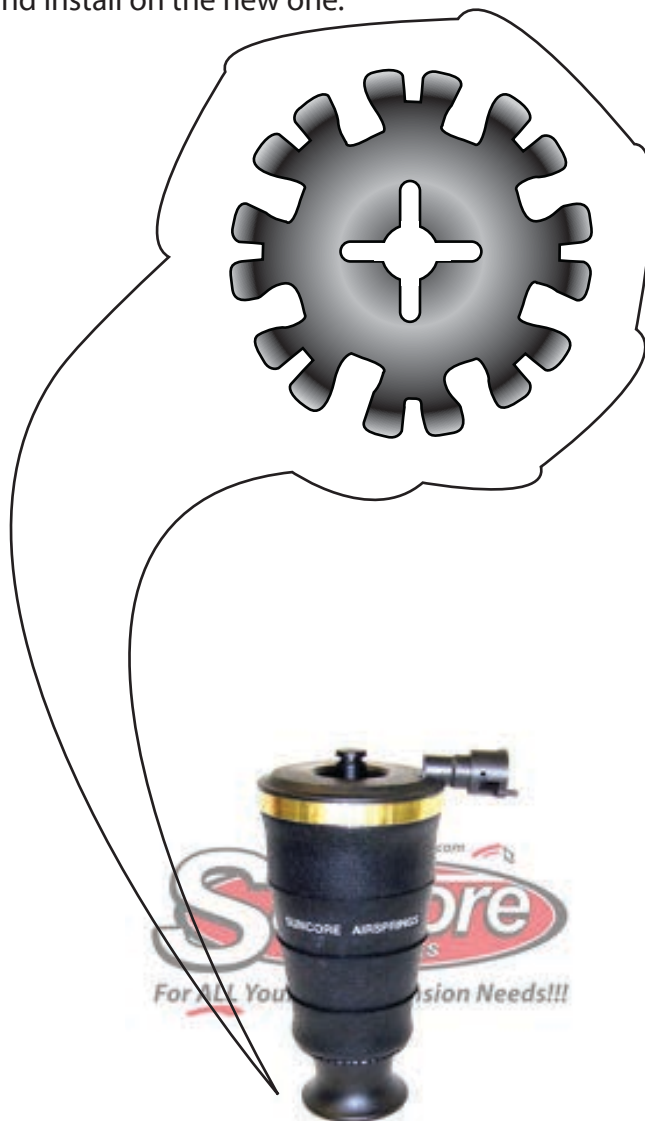



**For ALL Your Air Suspension Needs!!!**

### **Installation**

- 1. CAUTION: To avoid damage to the air spring, do not allow suspension to compress before the spring is inflated.**

**Note: When installing the air lines, make sure the white air line is fully inserted into the fitting for correct installation.**

### **Install the air spring.**

- 1. Position the air spring assembly in**
- 2. Install the spring retainer clip.**

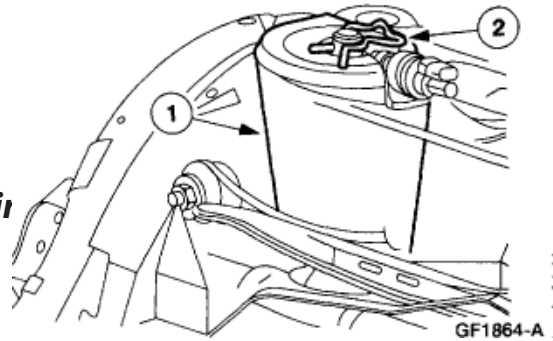

- 2. Seat the bottom of the air spring**

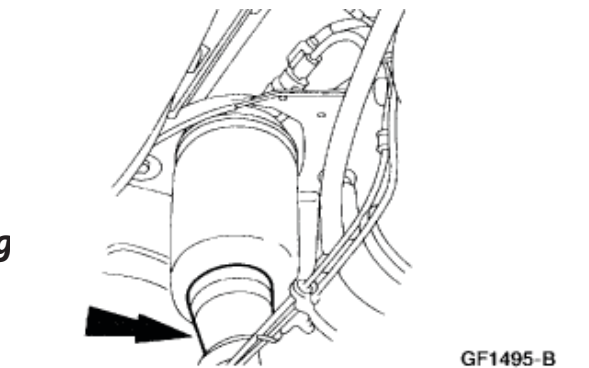

3. Note: When installing the air lines, make sure the white air line is fully inserted into the fitting for correct installation.

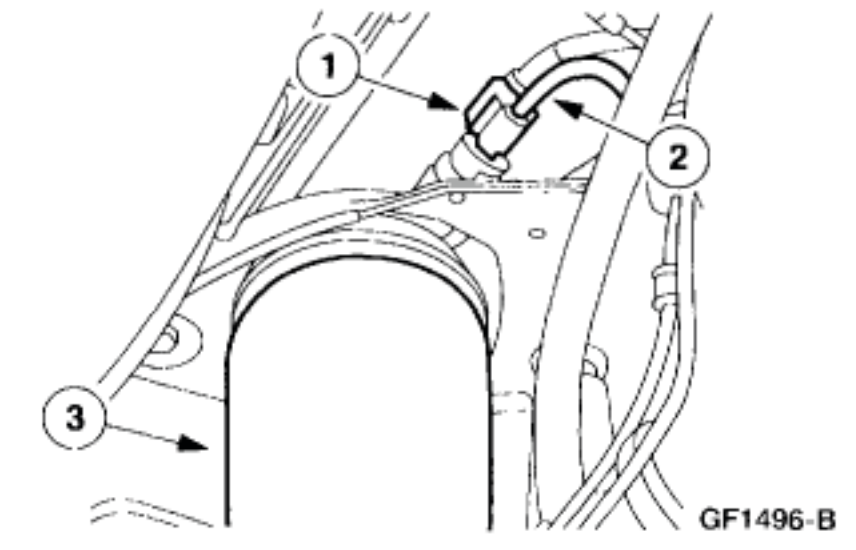

Connect the air spring solenoid valve.

1. Connect the electrical connector.
2. Connect the air line.
3. Make sure air spring is in the proper shape.
4. Refill the air springs.