

STEMCO®



STEMCO KAISER™ STEERING COMPONENTS CATALOG



STEMCO®
A Higher Standard of Performance.™

Making the Roadways Safer® an EnPro Industries company

STEMCO SUSPENSION PRODUCTS™

At STEMCO® we engineer advanced commercial vehicle solutions and create exceptional customer experiences in our passion to make the roadways safer. STEMCO Kaiser is a product line of STEMCO, and manufacturers superior quality solutions for the commercial vehicle industry. STEMCO Kaiser has the industry's most extensive offering of steering knuckle king pin kits, spring pins and bushings for leaf springs and shackles; as well as pre-sized, hardened sleeves to repair worn axle eyes.

STEMCO Kaiser™ King Pin Kits

Kits contain all necessary components to complete a king pin repair. STEMCO Kaiser king pin kits offer three kit options to meet all customer needs.

Qwik Kit® – No need to ream, ease of installation, and 300% better lubrication with extreme long life. Qwik Kit is the original grease grooved King Pin and spiral steel bushing design. Always use the STEMCO Kaiser Qwik Kit.

Plus Kit® - Pre-sized bronze bushing kit, which allows for the lowest total repair cost in the market. Less down time and labor costs due to the bushing's no ream feature. Insist on Plus Kits the no ream bronze bushing product that does not compromise quality.

Econo Kit™ - Top quality bronze bushings and quality king pins allow for a customizable individual fit, are competitively priced and offers consistent components in every kit.

STEMCO Kaiser Spring Pins and Bushings

Features include grease grooved spring pins and bushing assemblies with sealed bushing technology to keep grease in and dirt out. When used together, the grooved pin and sealed bushing assemblies will provide up to three times the life compared to the OE spring pins and bushings. This combination offers; easier greasing and ease of installation when used with our unique install tools.

BSP™ – Spring Pins - STEMCO Kaiser spring pins can be used with any bushing. The only grease grooved pin in the industry creating more grease capacity.

BSA™ – Bushings – STEMCO Kaiser Qwik Kit spiral steel bushing with sealed bushing technology provides ease of installation and the longest life possible.

BSL - Bushings – STEMCO Kaiser **LUBRAflex®** bushing with hardened wire insert with sealed bushing technology for better lubrication concentration and exceptional life.

BSG – Bushings - Generic bronze bushing of highest quality bronze that are available for quality repair.

STEMCO Kaiser APE Sleeves

Axle bore issues are a common problem when doing a king pin repair and fixing the problem is essential.

STEMCO Kaiser APE sleeves are easy to install and harder than the axle bore to provide extended life. APE sleeves also have the lock pin slots pre-cut for a trouble free installation.

What Makes Our Products Different?

STEMCO Kaiser has been an industry institution for over 45 years and is known as the premier provider of “no ream” King Pin and Spring Pin solutions. STEMCO Kaiser has a history of providing real world solutions to some of the industry's biggest problems. The Qwik Kit king pin kit has successfully provided four times the life of traditional king pin kits when used in the after-market. STEMCO Kaiser also offers an industry best technical training and support team, as well as live in shop training sessions.

STEMCO KAISER King Pin Kits, Spring Pins, Bushings, and Axle Sleeves are proudly made in the USA and outperform, outlast and are simpler to install than other products on the market.



A Higher Standard of Performance.™

CONTENTS ALPHABETICAL BY MAKE

King Pin Section

Alliance Axle	4
Chevrolet	4-5
Clark	5
Dodge	6
Eagle	6
Eaton	6
Ford	6-9
Freightliner	9
FWD	9
GMC	9-11
Hendrickson	11
Hino	11
IMT / Ingersoll	11
International / Navistar	12-14
Isuzu	14-15
Kenworth	15
KGI	15
Kimble Mixer	15
Link	15
Mack	15-16
MAN	16
MCI	16
Mc Nelius MTM	16
Mitsubishi	16
New Flyer	16
Peterbilt	16
Ridewell	16
Rockwell / Meritor	16-18
Spicer / Dana / Eaton	18-21
Sterling	21
Volvo	21
Watson & Chalin	21
White / Westport	22
Workhorse	22

Bus Section

Bluebird	23
Ford	23
Gillig	23
GMC Coach	23
International / Navistar	24
MAN	24
MCI	24
Neoplan	24
New Flyer	24
Rockwell / Meritor	24-25
Thomas	25
King Pin Dimensions Interchange	26

King Pin Support Products Section

Manufacturers Spindle Bore & Axle Bore Dimensions	27
King Pin Service Tools	27

Front Spring Pins and Bushing Section

Advance Mixer	28
Bluebird	28
Crane Carrier	28
Ford	28
Freightliner	28
Gillig	28
HME	28
International / Navistar	28-29
Kenworth	29
KME	29
Mack	29
Oshkosh	29-30
Pierce	30
Peterbilt	30
Rosenbauer	30
Sterling	31
Sutphen Fire Chassis	31
Thomas	31

Volvo / GMC	31
Western Star	31
White	31
Spring Research Institute Identification	31
Special Pin Applications	31

Rear Spring Pins and Bushing Section

Bluebird	32
Ford	32
Freightliner	32
Hendrickson	32
International / Navistar	32
Mack	32
Spring Service Tools	32

Interchange Section

King Pin Interchange	33-44
Bearing Interchange	44
Spring Pin Interchange	45
Shim Pack Cross Reference	46
Tie Rod End Interchange to QWIKTIE™ Assembly	62-69

Component Parts Section

Qwik Kit®	47-52
Plus Kit®	53-56
Econo Kit™	57-60

WARRANTY:

STEMCO warrants the parts contained in STEMCO Kaiser Products to be free from defects in material and workmanship, under normal use and maintenance for a period of one year. This warranty shall be limited to replacing or allowing credit for the parts contained in the STEMCO Kaiser products providing that notice of defects and proof is promptly given. This warranty does not apply to damage or to defects in any parts contained in the STEMCO Kaiser products caused by misuse, neglect, accident, incorrect installation, alteration, or repair. THIS WARRANTY, AND THE MANUFACTURER'S OBLIGATION HEREUNDER IS IN LIEU OF ALL OTHER WARRANTIES, EXPRESS, IMPLIED OR STATUTORY, INCLUDING ANY WARRANTIES OF MERCHANTABILITY OR OF FITNESS FOR A PARTICULAR PURPOSE. THE FOREGOING EXPRESSES ALL OF STEMCO KAISER PRODUCTS' OBLIGATIONS AND LIABILITIES WITH RESPECT TO THE QUALITY OF ITEMS FURNISHED BY IT, AND IT SHALL UNDER NO CIRCUMSTANCES BE LIABLE FOR CONSEQUENTIAL, INDIRECT, OR SPECIAL LOSSES OR DAMAGES OR LOST PROFITS.

WARRANTY CLAIMS:

- The following procedure shall apply to all warranty claims:
- The end user must return all parts for which it intends to make a warranty claim to the authorized STEMCO Kaiser Distributor who sold it the parts in question, along with a properly filled out Warranty Claim Form.
 - End users can obtain a Warranty Claim Form by contacting their authorized STEMCO Kaiser Distributor, who may obtain such form from STEMCO Kaiser's Warranty department.
 - After obtaining a completed Warranty Claim Form from the end user, the STEMCO Kaiser Distributor must return to STEMCO Kaiser the following: (i) the parts in question, (ii) the completed Warranty Claim Form and (iii) a complete written history of the parts in question, including information concerning the vehicle from which the parts were removed.
 - Items deemed by STEMCO Kaiser to be defective under the terms of STEMCO Kaiser's warranty will be replaced. All claims will receive a service analysis report.

DISCLAIMER NOTICE:

The use of a manufacturer's name, product number and part description in this catalog is intended to assist our customers in identifying replacement parts. Names referenced in this catalog may be trademarks or trade names of their respective manufacturers or suppliers and are not intended to show affiliation between STEMCO and the owners of those names.

Every effort has been made to insure the accuracy of the information shown in this catalog. However, STEMCO assumes no liability for any errors or omissions in the information provided.

To Order More Catalogs, Call and Request Part #01-577-0002

Model	Axle	Year	OEM No.	Pin Type	OEM Spec	Owik Kit No. ¹	Plus Kit No. ²	Econo Kit No.	Lip Seal/ Bushing Driver Installation Tool	Axle Sleeve Used With APE	APE Cutter Kit Used
-------	------	------	---------	----------	----------	---------------------------	---------------------------	---------------	--	---------------------------	---------------------

ALLIANCE AXLE

	AF-6.0-2, AF-8.0-2		P6073300219KZ P6073300319KZ	B	1.771 x 8.06	K80A				ST70-30	
	AF-10.0-3, AF-12.0-3, AF-13.0-3, AF-13.3-3, AF-14.7-3		P6073300019KZ P6073300119KZ	B	1.771 x 9.23	K120A				ST70-30	
	AF-16.0-5, AF-18.0-3, AF-20.3-3		P6073300419KZ P6073300519KZ	B	2.125 x 9.75	K160A				ST70-31	

CHEVROLET

¼ & 1 Ton P20, P30		1960-1964	3854744	A	1.109 x 6.34	K51G	70.051.07	50.051.07		ST70-14	
		1964-1967	3858389 3927942	A	1.109 x 6.34	K51G	70.051.07	50.051.07		ST70-14	
	5000#	1986 to date	15522020 15584763	A	1.179 x 6.35	K56G	70.056.07	50.056.07		ST70-4	91.056.07 84.056.07
C30HD - Heavy Duty Pickup			15665666 88911968 88911987	A	1.179 x 6.35	K56G	70.056.07	50.056.07		ST70-4	91.056.07 84.056.07
1 ½ Ton - C40, P40	5000# (F-050)	1964-1975	3858389 3927942	A	1.109 x 6.34	K51G	70.051.07	50.051.07		ST70-14	
	5000# (F-050)	1975-1990	722166	A	1.179 x 6.35	K55G	70.055.07	50.055.07		ST70-4	91.056.07 84.056.07
	7000# (F-070)	1963-1984	3927943 8885857	A	1.249 x 7.87	K70G	70.070.07	50.070.07		ST70-1	
1 ½ Ton & 2 Ton - C50, D50, L50, M50, N50, P50, S50, T50, C5D, O50	5000# (F-050)	1963-1975	3829410 3927942	A	1.109 x 6.34	K51G	70.051.07	50.051.07		ST70-14	
	5000# (F-050)	1975-1990	722166	A	1.179 x 6.35	K55G	70.055.07	50.055.07		ST70-4	91.056.07 84.056.07
	7000# (F-070)	1965-1975	3838390 3927943	A	1.249 x 7.87	K70G	70.070.07	50.070.07		ST70-1	
	9000# (F-090)	1963-1972	2321013 2431372 8885021	E	1.434 x 8.75	K95G ¹²	70.095.07 ¹²	50.095.07 ¹²		ST70-9	
	11000# (F-110)	1965-1970	2264897	E	1.609 x 9.75	K125G ¹²	70.125.07 ¹²	50.125.07 ¹²		ST70-5	
	12000# (F-120)	1966-1973	2264897	E	1.609 x 9.75	K125G ¹²	70.125.07 ¹²	50.125.07 ¹²		ST70-5	
	12000# (F-120D)	1975-1990	8885621	B	1.745 x 9.37	K121G ⁷	70.121.07 ⁷	50.121.07 ⁷		ST70-11	
2 Ton - A60, B60, C60, D60, L60, M60, N60, P60, O60, S60, T60, V60, X60, Y60	5000#	1963-1975	3858389 3927942	A	1.109 x 6.34	K51G	70.051.07	50.051.07		ST70-14	
	5000#	1975-1990	722166	A	1.179 x 6.35	K55G	70.055.07	50.055.07		ST70-4	91.056.07 84.056.07
	7000# (F-070) Some 6000#	1963-	3838390 3927943	A	1.249 x 7.87	K70G	70.070.07	50.070.07		ST70-1	
	9000# (F-090) Some 8100#	1965-	2321013 2431372 8885021	E	1.434 x 8.75	K95G ¹²	70.095.07 ¹²	50.095.07 ¹²		ST70-9	
	11000# (F-110)	1965-1975	2264897	E	1.609 x 9.75	K125G ¹²	70.125.07 ¹²	50.125.07 ¹²		ST70-5	
	12000# (F-120)	1966-1975	2264897	E	1.609 x 9.75	K125G ¹²	70.125.07 ¹²	50.125.07 ¹²		ST70-5	
	12000# (F-120D)	1975-1990	8885621	B	1.745 x 9.37	K121G ⁷	70.121.07 ⁷	50.121.07 ⁷		ST70-11	
Top Kick - C-Series	6000# (FN9)		88936084	A	1.234 x 6.78	K60R				ST70-3	

PIN TYPE CHART:		C - SAME SIDE LOCK FLATS		G - STEP THREADED	
	A - SINGLE LOCK FLAT		E - TAPERED THREADED		H - NO LOCK FLATS
	B - DOUBLE LOCK FLAT		F - TAPERED		J - SINGLE STEP

1. STEMCO Kaiser Owik Kit® feature patented spiral steel bushings. 2. STEMCO Kaiser Plus Kit® feature pre-sized steel back bronze bushings. 3. Kit has composite bushings. 4. Modify spindles to receive end plates. 5. Bolt on cap. 6. Threaded cap. 7. Length of STEMCO Kaiser pin is 9 3/4". 8. STEMCO Kaiser pin is longer than OEM. 9. Torque Spec. for king pin nut 230 ft/lbs. 10. Torque Spec. for king pin nut is 300 ft/lbs. 11. Torque Spec. for king pin nut is 406 ft/lbs. 12. Torque Spec. for king pin nut is 350/475 ft/lbs. 13. Includes end caps. 14. Torque Spec. for knuckle attachment bolts is 170-200 ft/lbs. 15. Kit uses special removal tool ST90-1.

Steering Knuckle King Pin Kits

Model	Axle	Year	OEM No.	Pin Type	OEM Spec	Qwik Kit No. ¹	Plus Kit No. ²	Econo Kit No.	Lip Seal/ Bushings Driver Installation Tool	Axle Sleeve Used With APE	APE Cutter Kit Used
-------	------	------	---------	----------	----------	---------------------------	---------------------------	---------------	--	---------------------------------	------------------------

CHEVROLET

Top Kick - C - Series	7000# (FM7)		88936119	B	1.499 x 7.15	K70R	70.070.18	50.070.18	ST70-28		
	8000# (FM8)		88936011	B	1.499 x 7.50	K80R	70.080.18	50.080.18	ST70-28		
	10000# (FM6)			B	1.794 x 10.40	K120R	70.120.18	50.120.18	ST70-7		
	8100# (FL1)	1990 to date	12540328 15619560	G	1.614 x 8.00	K80G ¹¹					
	9000# 11000# (FL2) 12000# (FS7)	1990 to date	12540329 15619561	G	1.889 x 9.20	K110G ¹¹					
Top Kick - T - Series	14000# (FH0) 14500# (FL3) 14600# (FSD)	1990 to date	12540330 15619562	G	1.889 x 9.62	K120G ¹¹					
	EFA18F3 16000#		12541348 3927942	A	1.872 x 9.96	K180E	70.180.05	50.180.05	ST70-23	91.180.05	84.147.05
2 ½ Ton - C70, C7D, H70, J70, R70, S70, S7T, T70, W70	7000# (F-070)	1963 to date	3838390 3927943	A	1.249 x 7.87	K70G	70.070.07	50.070.07	ST70-1		
	9000# (F-090)	1962 to date	2321013 2431372 8885021	E	1.434 x 8.75	K95G ¹²	70.095.07 ¹²	50.095.07 ¹²	ST70-9		
	11000# (F-110)	1962-1975	2264897	E	1.609 x 9.75	K125G ¹²	70.125.07 ¹²	50.125.07 ¹²	ST70-5		
	12000# (F-120)	1966-1975	2264897	E	1.609 x 9.75	K125G ¹²	70.125.07 ¹²	50.125.07 ¹²	ST70-5		
	12000# (F-120D)	1975 to date	8885621	B	1.745 x 9.37	K121G ⁷	70.121.07 ⁷	50.121.07 ⁷	ST70-11		
	FF-932 13200#		15510849	B	1.794 x 10.39	K931L	70.931.12	50.931.12	ST70-7	92.961.12	84.122.05
	FG-943 14600#			B	1.794 x 10.39	KG931R	77.931.18	57.931.18	ST70-7	92.931.18	84.122.05
18000# (FL-901)	1971 to date	2452865	B	1.999 x 10.90	KH901L	78.901.12	58.901.12	ST70-12			
2 ½ & 3 Ton - A80, C80, E80, H80, J80, L80, M80, N80, Q80	7000# (F-070)	1963 to date	3838390 3927943	A	1.249 x 7.87	K70G	70.070.07	50.070.07	ST70-1		
	9000# (F-090)	1962 to date	2321013 2431372 8885021	E	1.434 x 8.75	K95G ¹²	70.095.07 ¹²	50.095.07 ¹²	ST70-9		
	11000# (F-110)	1962-1975	2264897	E	1.609 x 9.75	K125G ¹²	70.125.07 ¹²	50.125.07 ¹²	ST70-5		
	12000# (F-120)	1966-1975	2264897	E	1.609 x 9.75	K125G ¹²	70.125.07 ¹²	50.125.07 ¹²	ST70-5		
	12000# (F-120D)	1975 to date	8885621	B	1.745 x 9.37	K121G ⁷	70.121.07 ⁷	50.121.07 ⁷	ST70-11		
	18000# (FL-901)	1971 to date	2452865	B	1.999 x 10.90	KH901L	78.901.12	58.901.12	ST70-12		
3 ½ Ton - D90, F90, H90, J90, M90, T90, W90	9000# (F-090)	1970 to date	2321013 2431372 8885021	E	1.434 x 8.75	K95G ¹²	70.095.07 ¹²	50.095.07 ¹²	ST70-9		
	12000# (F-120)	1970-1975	2264897	E	1.609 x 9.75	K125G ¹²	70.125.07 ¹²	50.125.07 ¹²	ST70-5		
	12000# (FE-900)	1970-1975	2264897	E	1.609 x 9.75	K125G ¹²	70.125.07 ¹²	50.125.07 ¹²	ST70-5		
	12000# (F-120D)	1975 to date	8885621	B	1.745 x 9.37	K121G	70.121.07	50.121.07	ST70-11		
	18000# (FL-901)	1970 to date	2452865	B	1.999 x 10.90	KH901L	78.901.12	58.901.12	ST70-12		
	16000# (FL-931)	1973-1978	2036352	B	1.999 x 11.21	KH931L	78.931.12	58.931.12	ST70-12	92.931.12	84.931.12

CLARK (Industrial Axles)

F-553 Air Start/ Gen. Carts				A	1.234 x 7.62	K98I	70.098.09	50.098.09	ST70-10		
--------------------------------	--	--	--	---	--------------	------	-----------	-----------	---------	--	--

For all Qwik Kit® - BUSHING "T" HANDLE WRENCHES



Tool No.	Description
ST-100-1	Short "T" Handle Wrench
ST-100-2	Long "T" Handle Wrench
100M1-1	Replacement head
Above Wrenches will fit the bushings in most kits.	
The Following kits do not use wrenches: K80A, K120A, K120N, K150KG, K160A, K700T, K60U, 50.121.08	

Tool No.	Description
ST-100-3	Short "T" Handle Wrench
ST-100-4	Long "T" Handle Wrench
100M1-2	Replacement head
Above Wrenches will fit the bushings in the following kits:	
K50F, K71F, K72F, K80G, K110G, K120G, K122V, K146E, K147E, K180E, K68Z, K69Z	

Model	Axle	Year	OEM No.	Pin Type	OEM Spec	Owik Kit No. ¹	Plus Kit No. ²	Econo Kit No.	Lip Seal/ Bushing Driver Installation Tool	Axle Sleeve Used With APE	APE Cutter Kit Used
-------	------	------	---------	----------	----------	---------------------------	---------------------------	---------------	--	---------------------------	---------------------

DODGE

2 Ton - C500, D500, M500, R500, S500, PC500, PD500	7000#	1957-1973	1843208	B	1.234 x 7.43	K70D	70.070.04	50.070.04	ST70-10		
2 ½ Ton - C600, D600, L600, S600, PC600, PD600, C700, CT700, D700, L700, S700	7000#	1957-1973	1843208	B	1.234 x 7.43	K70D	70.070.04	50.070.04	ST70-10		
	7000#	1960-1973	1843208	B	1.234 x 7.43	K70D	70.070.04	50.070.04	ST70-10		
	9000#	1960-1973	1818726	B	1.433 x 8.50	KD901R	74.901.18	54.901.18	ST70-9		
	11000#	1960-1968	1643174	E	1.609 x 9.75	K125G ¹²	70.125.07 ¹²	50.125.07 ¹²	ST70-5		
3 Ton - C800, CN800, CNT800, D800, NCT800, C850	7000#	1960-1973	1843208	B	1.234 x 7.43	K70D	70.070.04	50.070.04	ST70-10		
	9000#	1960 to date	1818726	B	1.433 x 8.50	KD901R	74.901.18	54.901.18	ST70-9		
	11000#	1960-1968	1643174	E	1.609 x 9.75	K125G ¹²	70.125.07 ¹²	50.125.07 ¹²	ST70-5		
	12000#	1969-1977	2808618	B	1.794 x 9.12	K901L	70.901.12	50.901.12	ST70-7		
4 Ton - C900, CN900, CT900, CNT900, NC900, NCT900, VL900, VLT900	7000#	1960-1973	1843208	B	1.234 x 7.43	K70D	70.070.04	50.070.04	ST70-10		
	9000#	1960 to date	1818726	B	1.433 x 8.50	KD901R	74.901.18	54.901.18	ST70-9		
	11000#	1960-1968	1643174	E	1.609 x 9.75	K125G ¹²	70.125.07 ¹²	50.125.07 ¹²	ST70-5		
	12000#	1969-1973	2808618	B	1.794 x 9.12	K901L	70.901.12	50.901.12	ST70-7		
	16000#	1974 to date		B	1.999 x 11.04	KH901L	78.901.12	58.901.12	ST70-12		
5 Ton - C1000, CT1000, DN1000, DNT1000, LN1000, LNT1000	7000#	1970-1973	1843208	B	1.234 x 7.43	K70D	70.070.04	50.070.04	ST70-10		
	9000#	1960 to date	1818726	B	1.433 x 8.50	KD901R	74.901.18	54.901.18	ST70-9		
	11000#	1960-1968	1643174	E	1.609 x 9.75	K125G ¹²	70.125.07 ¹²	50.125.07 ¹²	ST70-5		
	12000#	1969-1973	2808618	B	1.794 x 9.12	K901L	70.901.12	50.901.12	ST70-7		
	16000#	1974 to date		B	1.999 x 11.04	KH901L	78.901.12	58.901.12	ST70-12		

EAGLE

05	12000#		123	E	1.609 x 9.75	K125G ¹²	70.125.07 ¹²	50.125.07 ¹²	ST70-5		
----	--------	--	-----	---	--------------	---------------------	-------------------------	-------------------------	--------	--	--

EATON (See Spicer / Dana / Eaton)

FORD

E100, E250, E350		1975 to date	D5UZ-3111B D5UZ-3111D E0TZ-3111A	A	1.054 x 6.68	KE350F	75.350.06	55.350.06	ST70-15		
½ Ton (Twin-I-Beam)	2600# Manual Brakes	1975 to date	D5TZ-3111B	A	1.054 x 6.68	KE350F	75.350.06	55.350.06	ST70-15		
¾ Ton (Twin-I-Beam) F250 Conventional 2 wheel drive		1980-1986	E0TZ-3111A	A	1.054 x 6.68	KE350F	75.350.06	55.350.06	ST70-15		
1 Ton (Twin-I-Beam) F350 Conventional 2 wheel drive		1980-1986	E0TZ-3111A	A	1.054 x 6.68	KE350F	75.350.06	55.350.06	ST70-15		
F450 Super Duty		1988-1998	E8TZ-3111A	A	1.300 x 7.26	K71F	70.071.06	50.071.06	ST70-17		
1 ½ Ton B500, F500, LN500, N500, C500, P500	4700# - 5000#	1963 to date	C3TZ-3111A D2TZ-3111D	A	1.231 x 7.54	K50F ⁴	70.053.06	50.053.06	ST70-3		

PIN TYPE CHART:		C - SAME SIDE LOCK FLATS		G - STEP THREADED	
	A - SINGLE LOCK FLAT		E - TAPERED THREADED		H - NO LOCK FLATS
	B - DOUBLE LOCK FLAT		F - TAPERED		J - SINGLE STEP

1. STEMCO Kaiser Owik Kit® feature patented spiral steel bushings. 2. STEMCO Kaiser Plus Kit® feature pre-sized steel back bronze bushings. 3. Kit has composite bushings. 4. Modify spindles to receive end plates. 5. Bolt on cap. 6. Threaded cap. 7. Length of STEMCO Kaiser pin is 9 3/4". 8. STEMCO Kaiser pin is longer than OEM. 9. Torque Spec. for king pin nut 230 ft/lbs. 10. Torque Spec. for king pin nut is 300 ft/lbs. 11. Torque Spec. for king pin nut is 406 ft/lbs. 12. Torque Spec. for king pin nut is 350/475 ft/lbs. 13. Includes end caps. 14. Torque Spec. for knuckle attachment bolts is 170-200 ft/lbs. 15. Kit uses special removal tool ST90-1.

Steering Knuckle King Pin Kits

FORD

Model	Axle	Year	OEM No.	Pin Type	OEM Spec	Qwik Kit No. ¹	Plus Kit No. ²	Econo Kit No.	Lip Seal/Bushing Driver Installation Tool	Axle Sleeve Used With APE	APE Cutter Kit Used
-------	------	------	---------	----------	----------	---------------------------	---------------------------	---------------	---	---------------------------	---------------------

FORD

1 ½ Ton C500, P500 C550, P600	4700# - 5000#	1978-1979	C3TZ-3111A	A	1.231 x 7.54	K50F ⁴	70.053.06	50.053.06	ST70-3		
	6000#	1970-1973	C7TZ-3111A	A	1.230 x 8.90	K70F ⁴	70.073.06	50.073.06	ST70-3		
	7000#	1961-1969	B7TZ-3111B C2TZ-3111B	B	1.234 x 7.43	K70D	70.070.04	50.070.04	ST70-10		
	7000#	1970-1988	C7TZ-3111A	A	1.230 x 8.90	K70F ⁴	70.073.06	50.073.06	ST70-3		
2 Ton - B600, C600, F600, LN600, N600	5000# - 5500#	1963 to date	C3TZ-3111A D2TZ-3111D	A	1.231 x 7.85	K50F ⁴	70.053.06	50.053.06	ST70-3		
	6000#	1967-1988	C7TZ-3111A	A	1.230 x 8.90	K70F ⁴	70.073.06	50.073.06	ST70-3		
	6000# - 7000#	1967-1974	C7TZ-3111A	A	1.230 x 8.90	K70F ⁴	70.073.06	50.073.06	ST70-3		
	7000#	1961-1966	B7TZ-3111B C2TZ-3111B	B	1.234 x 7.43	K70D	70.070.04	50.070.04	ST70-10		
	7000# Hydraulic Brakes	1967-1988	C7TZ-3111A	A	1.230 x 8.90	K70F ⁴	70.073.06	50.073.06	ST70-3		
	7000-9000# Air Brakes	1975-1988	D6TZ-3111A	B	1.430 x 8.25	K75F ⁵	70.075.06 ⁵	50.075.06 ⁵	ST70-9		
	7000-9000# Air Brakes	1989-2003	E9HZ-3111C	B	1.430 x 8.25	K76F ⁶	70.076.06 ⁶	50.076.06 ⁶	ST70-9		
14600#	1995-1998	F5HZ-3111A	B	1.810 x 10.54	K146F			ST70-33			
2 ½ Ton - B700, C700, F700, LN700, N700, T700, B750, C750, F750, LN750, N750, T750	5000-5500#	1963 to date	C3TZ-3111A D2TZ-3111D	A	1.231 x 7.85	K50F ⁴	70.053.06	50.053.06	ST70-3		
	6000#	1967-1988	C7TZ-3111A	A	1.230 x 8.90	K70F ⁴	70.073.06	50.073.06	ST70-3		
	6000# - 7000#	1990 to date	E8HZ-3111A F1HZ-3111A	B	1.300 x 7.75	K72F	70.072.06	50.072.06	ST70-17		
	7000#	1957-1966	C7TZ-3111A	A	1.230 x 8.90	K70F ⁴	70.073.06	50.073.06	ST70-3		
	7000#		C2TZ-3111B	B	1.234 x 7.43	K70D	70.070.04	50.070.04	ST70-10		
	7000# Hydraulic Brakes	1967-1988	C7TZ-3111A	A	1.230 x 8.90	K70F ⁴	70.073.06	50.073.06	ST70-3		
	7000# Air Brakes	1989-2003	E9HZ-3111C	B	1.430 x 8.25	K76F ⁶	70.076.06 ⁶	50.076.06 ⁶	ST70-9		
	7000-9000# Air Brakes After Series No. 40001	1975-1988	D6TZ-3111A	B	1.430 x 8.25	K75F ⁵	70.075.06 ⁵	50.075.06 ⁵	ST70-9		
	9000# Hydraulic Brakes	1960-1983	D1HZ-3111A C2TZ-3111G	B	1.433 x 8.50	KD901R	74.901.18	54.901.18	ST70-9		
	9000# Air Brakes	1975-1988	D6HZ-3111B D6HZ-3111D	B	1.606 x 9.07	K95F ⁵	70.095.06 ⁵	50.095.06 ⁵	ST70-13		
	9000# Air Brakes	1989 to date	E9HZ-3111B	B	1.606 x 9.07	K96F ⁶	70.096.06 ⁶	50.096.06 ⁶	ST70-13		
	C.P.S. 11000#	1960-1973	D0HZ-3111C	B	1.606 x 8.81	K970R	70.970.18	50.970.18	ST70-13		
	C.P.S. 12000#	1960-1973	D0HZ-3111C	B	1.606 x 8.81	K970R	70.970.18	50.970.18	ST70-13		
	12000# Conventional	1960-1969	C3TZ-3111B D1HZ-3111B	B	1.794 x 9.12	K901L	70.901.12	50.901.12	ST70-7		
	14600#	1995-1998	F5HZ-3111A	B	1.810 x 10.54	K146F			ST70-33		
800-850-880 Series	6000#	1970-1988	C7TZ-3111A	A	1.230 x 8.90	K70F ⁴	70.073.06	50.073.06	ST70-3		
	7000#	1957-1969	B7TZ-3111B C2TZ-3111B	B	1.234 x 7.43	K70D	70.070.04	50.070.04	ST70-10		
	7000# Hydraulic Brakes	1970-1988	C7TZ-3111A	A	1.230 x 8.90	K70F ⁴	70.073.06	50.073.06	ST70-3		

For all Qwik Kit® - BUSHING "T" HANDLE WRENCHES



Tool No.	Description
ST-100-1	Short "T" Handle Wrench
ST-100-2	Long "T" Handle Wrench
100M1-1	Replacement head
Above Wrenches will fit the bushings in most kits.	
The Following kits do not use wrenches: K80A, K120A, K120N, K150KG, K160A, K700T, K60U, 50.121.08	

Tool No.	Description
ST-100-3	Short "T" Handle Wrench
ST-100-4	Long "T" Handle Wrench
100M1-2	Replacement head
Above Wrenches will fit the bushings in the following kits:	
K50F, K71F, K72F, K80G, K110G, K120G, K122V, K146E, K147E, K180E, K68Z, K69Z	

Model	Axle	Year	OEM No.	Pin Type	OEM Spec	Owik Kit No. ¹	Plus Kit No. ²	Econo Kit No.	Lip Seal/ Bushing Driver Installation Tool	Axle Sleeve Used With APE	APE Cutter Kit Used
-------	------	------	---------	----------	----------	---------------------------	---------------------------	---------------	--	---------------------------	---------------------

FORD

800-850-880 Series	7000-9000# Air Brakes After Series No. 40, 001	1975-1988	D6TZ-3111A	B	1.430 x 8.25	K75F ⁵	70.075.06 ⁵	50.075.06 ⁵	ST70-9			
	7000# Air Brakes	1989 to date	E9HZ-3111C	B	1.430 x 8.25	K76F ⁶	70.076.06 ⁶	50.076.06 ⁶	ST70-9			
	9000# Hydraulic Brakes	1957-1983	D1HZ-3111A C2TZ-3111G	B	1.433 x 8.50	KD901R	74.901.18	54.901.18	ST70-9			
	9000# Air Brakes	1975-1988	D6HZ-3111B D6HZ-3111D	B	1.606 x 9.07	K95F ⁵	70.095.06 ⁵	50.095.06 ⁵	ST70-13			
	9000# Air Brakes	1989 to date	E9HZ-3111B	B	1.606 x 9.07	K96F ⁶	70.096.06 ⁶	50.096.06 ⁶	ST70-13			
	11000# Conventional	1957-1963	B7TZ-3111C	E	1.609 x 9.75	K125G ¹²	70.125.07 ¹²	50.125.07 ¹²	ST70-5			
	C.P.S. 11000#	1964-1970	D0HZ-3111C	B	1.606 x 8.81	K970R	70.970.18	50.970.18	ST70-13			
	12000# Conventional	1960-1988	C3TZ-3111B D1HZ-3111B	B	1.794 x 9.12	K901L	70.901.12	50.901.12	ST70-7			
	C.P.S. 12000# Hydraulic Brakes	1960-1970	D0HZ-3111C	B	1.606 x 8.81	K970R	70.970.18	50.970.18	ST70-13			
	12000# Conventional	1975-1988	D6HZ-3111A	B	1.794 x 10.07	K941F ⁵	70.941.06 ⁵	50.941.06 ⁵	ST70-7	92.942.06	84.122.05	
	12000# Conventional	1989 to date		B	1.794 x 10.07	K942F ⁶	70.942.06 ⁶	50.942.06 ⁶	ST70-7	92.942.06	84.122.05	
	14600#	1995-1998	F5HZ-3111A	B	1.810 x 10.54	K146F			ST70-33			
	16000# Air Brakes	1970-1974	D0HZ-3111E	B	1.999 x 11.04	KH901L	78.901.12	58.901.12	ST70-12			
	16000# Air Brakes	1975 to date	D5HZ-3111C	B	1.999 x 11.21	KH931F	78.931.06	58.931.06	ST70-12	92.931.12	84.931.12	
	18000# Hydraulic Brakes	1960-1974	D0HZ-3111E	B	1.999 x 11.04	KH901L	78.901.12	58.901.12	ST70-12			
	18000# Air Brakes	1975 to date	D5HZ-3111C	B	1.999 x 11.21	KH931F	78.931.06	58.931.06	ST70-12	92.931.12	84.931.12	
	20000#	1970-1974	D0HZ-3111E	B	1.999 x 11.04	KH901L	78.901.12	58.901.12	ST70-12			
	20000#	1975 to date	D5HZ-3111C	B	1.999 x 11.21	KH931F	78.931.06	58.931.06	ST70-12	92.931.12	84.931.12	
	900-950 Series	7000#	1960-1969	B7TZ-3111B C2TZ-3111B	B	1.234 x 7.43	K70D	70.070.04	50.070.04	ST70-4		
		7000# Hydraulic Brakes	1970-1988	C7TZ-3111A	A	1.230 x 8.90	K70F ⁴	70.073.06	50.073.06	ST70-3		
7000# 9000-10000# After Series No. 40, 001		1975-1988	D6TZ-3111A	B	1.430 x 8.25	K75F ⁵	70.075.06 ⁵	50.075.06 ⁵	ST70-9			
7000# Air Brakes		1989 to date	E9HZ-3111C	B	1.430 x 8.25	K76F ⁶	70.076.06 ⁶	50.076.06 ⁶	ST70-9			
9000# Hydraulic Brakes		1957-1983	D1HZ-3111A C2TZ-3111G	B	1.433 x 8.50	KD901R	74.901.18	54.901.18	ST70-9			
9000# Air Brakes		1975-1988	D6HZ-3111B D6HZ-3111D	B	1.606 x 9.07	K95F ⁵	70.095.06 ⁵	50.095.06 ⁵	ST70-13			
9000# Air Brakes		1989 to date	E9HZ-3111B	B	1.606 x 9.07	K96F ⁶	70.096.06 ⁶	50.096.06 ⁶	ST70-13			

PIN TYPE CHART:		C - SAME SIDE LOCK FLATS		G - STEP THREADED	
	A - SINGLE LOCK FLAT		E - TAPERED THREADED		H - NO LOCK FLATS
	B - DOUBLE LOCK FLAT		F - TAPERED		J - SINGLE STEP

1. STEMCO Kaiser Owik Kit® feature patented spiral steel bushings. 2. STEMCO Kaiser Plus Kit® feature pre-sized steel back bronze bushings. 3. Kit has composite bushings. 4. Modify spindles to receive end plates. 5. Bolt on cap. 6. Threaded cap. 7. Length of STEMCO Kaiser pin is 9 3/4". 8. STEMCO Kaiser pin is longer than OEM. 9. Torque Spec. for king pin nut is 300 ft/lbs. 10. Torque Spec. for king pin nut is 300 ft/lbs. 11. Torque Spec. for king pin nut is 406 ft/lbs. 12. Torque Spec. for king pin nut is 350/475 ft/lbs. 13. Includes end caps. 14. Torque Spec. for knuckle attachment bolts is 170-200 ft/lbs. 15. Kit uses special removal tool ST90-1.

Steering Knuckle King Pin Kits

Model	Axle	Year	OEM No.	Pin Type	OEM Spec	Qwik Kit No. ¹	Plus Kit No. ²	Econo Kit No.	Lip Seal/ Bushing Driver Installation Tool	Axle Sleeve Used With APE	APE Cutter Kit Used
-------	------	------	---------	----------	----------	---------------------------	---------------------------	---------------	--	---------------------------	---------------------

FORD

900-950 Series	11000# Conventional	1957-1963	B7TZ-3111C	E	1.609 x 9.75	K125G ¹²	70.125.07 ¹²	50.125.07 ¹²	ST70-5		
	C.P.S. 11000#	1964-1970	D0HZ-3111C	B	1.606 x 8.81	K970R	70.970.18	50.970.18	ST70-13		
	12000# Conventional Hydraulic Brakes	1960-1988	C3TZ-3111B D1HZ-3111B	B	1.794 x 9 .12	K901L	70.901.12	50.901.12	ST70-7		
	C.P.S. 12000#	1960-1973	D0HZ-3111C	B	1.606 x 8.81	K970R	70.970.18	50.970.18	ST70-13		
	12000# Conventional	1975-1988	D6HZ-3111A	B	1.794 x 10.07	K941F ⁵	70.941.06 ⁵	50.941.06 ⁵	ST70-7	92.942.06	84.122.05
	12000# Conventional	1989 to date	E9HZ-3111A F0HZ-3111A	B	1.794 x 10.07	K942F ⁶	70.942.06 ⁶	50.942.06 ⁶	ST70-7	92.942.06	84.122.05
	12000# ALUMINUM	1978-1988	D8HZ-3111A	B	1.794 x 10.07	K941FA ⁵			ST70-7		
	12000# ALUMINUM	1989-	F6HZ-3111BB	B	1.794 x 10.07	K942FA ⁶			ST70-7		
	14600#	1995-1998	F5HZ-3111A	B	1.810 x 10.54	K146F			ST70-33		
	16000# Air Brakes	1970-1974	D0HZ-3111E	B	1.999 x 11.04	KH901L	78.901.12	58.901.12	ST70-12		
	16000# Air Brakes	1975 to date	D5HZ-3111C	B	1.999 x 11.21	KH931F	78.931.06	58.931.06	ST70-12	92.931.12	84.931.12
	18000# Hydraulic Brakes	1960-1974	D0HZ-3111E	B	1.999 x 11.04	KH901L	78.901.12	58.901.12	ST70-12		
	18000# Air Brakes	1975 to date	D5HZ-3111C	B	1.999 x 11.21	KH931F	78.931.06	58.931.06	ST70-12	92.931.12	84.931.12
	20000#	1970-1974	D0HZ-3111E	B	1.999 x 11.04	KH901L	78.901.12	58.901.12	ST70-12		
20000#	1975 to date	D5HZ-3111C	B	1.999 x 11.21	KH931F	78.931.06	58.931.06	ST70-12	92.931.12	84.931.12	

FREIGHTLINER (See Rockwell / Meritor, Spicer / Dana / Eaton)

FWD (See Rockwell / Meritor, Spicer / Dana / Eaton)

GMC

P1500		1960-1965	3927942	A	1.109 x 6.34	K51G	70.051.07	50.051.07	ST70-14		
G1500		1966-1967	3854744	A	1.109 x 6.34	K51G	70.051.07	50.051.07	ST70-14		
P2500		1960-1965	3927942	A	1.109 x 6.34	K51G	70.051.07	50.051.07	ST70-14		
		1966-1967	3854744	A	1.109 x 6.34	K51G	70.051.07	50.051.07	ST70-14		
C3500 - Heavy Duty Pickup		1991-	15665666	A	1.179 x 6.35	K56G	70.056.07	50.056.07	ST70-4	91.056.07	84.056.07
3500 Series - Conventional	5000# (F-050)	1963-1966	3927942	A	1.109 x 6.34	K51G	70.051.07	50.051.07	ST70-14		
P3500	5000# (F-050)	1965-1967	3854744	A	1.109 x 6.34	K51G	70.051.07	50.051.07	ST70-14		
	5000#	1986 to date	15522020 88911968 88911987	A	1.179 x 6.35	K56G	70.056.07	50.056.07	ST70-4	91.056.07	84.056.07
4000 Series	5000# (F-050, F-055)	1963-1966	3927942	A	1.109 x 6.34	K51G	70.051.07	50.051.07	ST70-14		
	7000# (F-070)	1963-1966	3838390 3927943	A	1.249 x 7.87	K70G	70.070.07	50.070.07	ST70-1		
4500 Series	5000# (F-055)	1967-1970	3927942	A	1.109 x 6.34	K51G	70.051.07	50.051.07	ST70-14		

For all Qwik Kit® - BUSHING "T" HANDLE WRENCHES



Tool No.	Description
ST-100-1	Short "T" Handle Wrench
ST-100-2	Long "T" Handle Wrench
100M1-1	Replacement head
Above Wrenches will fit the bushings in most kits.	
The Following kits do not use wrenches: K80A, K120A, K120N, K150KG, K160A, K700T, K60U, 50.121.08	

Tool No.	Description
ST-100-3	Short "T" Handle Wrench
ST-100-4	Long "T" Handle Wrench
100M1-2	Replacement head
Above Wrenches will fit the bushings in the following kits:	
K50F, K71F, K72F, K80G, K110G, K120G, K122V, K146E, K147E, K180E, K68Z, K69Z	

Model	Axle	Year	OEM No.	Pin Type	OEM Spec	Owik Kit No. ¹	Plus Kit No. ²	Econo Kit No.	Lip Seal/ Bushing Driver Installation Tool	Axle Sleeve Used With APE	APE Cutter Kit Used
-------	------	------	---------	----------	----------	---------------------------	---------------------------	---------------	--	---------------------------	---------------------

GMC

5000 Series - B5000, DW5000, W5000	5000# (F-050)	1967-1972	3854744	A	1.109 x 6.34	K51G	70.051.07	50.051.07	ST70-14		
All other 5000 Series	5000# (F-050, F-055)	1967-1970	3927942	A	1.109 x 6.34	K51G	70.051.07	50.051.07	ST70-14		
	7000# (F-070)	1963-1966	3838390 3927943	A	1.249 x 7.87	K70G	70.070.07	50.070.07	ST70-1		
All other 5500 Series	5000# (F-050)	1966-1970	3927942	A	1.109 x 6.34	K51G	70.051.07	50.051.07	ST70-14		
	5000# (F-050)	1966-1972	3854744	A	1.109 x 6.34	K51G	70.051.07	50.051.07	ST70-14		
	5000# (F-055)	1975-1990	722166	A	1.179 x 6.35	K55G	70.055.07	50.055.07	ST70-4	91.056.07	84.056.07
	7000# (F-070)	1963 to date	3838390 3927943	A	1.249 x 7.87	K70G	70.070.07	50.070.07	ST70-1		
KODIAK - C Series	9000# (F-090)	1970 to date	2321013 8885021	E	1.434 x 8.75	K95G ¹²	70.095.07 ¹²	50.095.07 ¹²	ST70-9		
	7000# (FM7)		88936119	B	1.499 x 7.15	K70R	70.070.18	50.070.18	ST70-28		
	8000# (FM8)		88936011	B	1.499 x 7.50	K80R	70.080.18	50.080.18	ST70-28		
	10000# (FM6)			B	1.794 x 10.40	K120R	70.120.18	50.120.18	ST70-7		
	8100# (FL1)		12540328 1561960	G	1.614 x 8.00	K80G ¹¹					
	9000# 11000# (FL2) 12000# (FS7)		12540329 1561961	G	1.889 x 9.20	K110G ¹¹					
	14000# (FH0) 14500# (FL3) 14600# (FSD)	1990 to date	12540330 1561962	G	1.889 x 9.62	K120G ¹¹					
	16000# (FH4)		88936136	B	1.999 x 11.21	K181R	70.181.18	50.181.18	ST70-12	92.931.12	84.931.12
EFA18F3 16000#		12541348	A	1.872 x 9.96	K180E	70.180.05	50.180.05	ST70-23	91.180.08	84.147.05	
6000 Series	5000# (F-050, F-055)	1973-1975	3927942	A	1.109 x 6.34	K51G	70.051.07	50.051.07	ST70-14		
	5000# (F-050, F-055)	1975-1990	722166	A	1.179 x 6.36	K55G	70.055.07	50.055.07	ST70-4	91.056.07	84.056.07
	7000# (F-070)	1973 to date	3838390 3927943	A	1.249 x 7.87	K70G	70.070.07	50.070.07	ST70-1		
	9000# (F-090)	1960 to date	2321013 8885021	E	1.434 x 8.75	K95G ¹²	70.095.07 ¹²	50.095.07 ¹²	ST70-9		
	11000# (F-110) 12000# (F-120)	1960 to date	2264897	E	1.609 x 9.75	K125G ¹²	70.125.07 ¹²	50.125.07 ¹²	ST70-5		
6500 Series	7000# (F-070)	1963 to date	3838390 3927943	A	1.249 x 7.87	K70G	70.070.07	50.070.07	ST70-1		
	9000# (F-090)	1960 to date	2321013 8885021	E	1.434 x 8.75	K95G ¹²	70.095.07 ¹²	50.095.07 ¹²	ST70-9		
	11000# (F-110)	1960-1975	2264897	E	1.609 x 9.75	K125G ¹²	70.125.07 ¹²	50.125.07 ¹²	ST70-5		
	12000# (F-120)	1963-1975	2264897	E	1.609 x 9.75	K125G ¹²	70.125.07 ¹²	50.125.07 ¹²	ST70-5		
	12000# (F-120D)	1975 to date	8885621	B	1.745 x 9.37	K121G ⁷	70.121.07 ⁷	50.121.07 ⁷	ST70-11		
7000 Series	9000# (F-090)	1960-1966	2321013 8885021	E	1.434 x 8.75	K95G ¹²	70.095.07 ¹²	50.095.07 ¹²	ST70-9		
	11000# (F-110)	1960-1966	2264897	E	1.609 x 9.75	K125G ¹²	70.125.07 ¹²	50.125.07 ¹²	ST70-5		
7500 Series	7000# (F-070)	1966 to date	3838390 3927943	A	1.249 x 7.87	K70G	70.070.07	50.070.07	ST70-1		

PIN TYPE CHART:		C - SAME SIDE LOCK FLATS		G - STEP THREADED	
	A - SINGLE LOCK FLAT		E - TAPERED THREADED		H - NO LOCK FLATS
	B - DOUBLE LOCK FLAT		F - TAPERED		J - SINGLE STEP

1. STEMCO Kaiser Owik Kit® feature patented spiral steel bushings. 2. STEMCO Kaiser Plus Kit® feature pre-sized steel back bronze bushings. 3. Kit has composite bushings. 4. Modify spindles to receive end plates. 5. Bolt on cap. 6. Threaded cap. 7. Length of STEMCO Kaiser pin is 9 3/4". 8. STEMCO Kaiser pin is longer than OEM. 9. Torque Spec. for king pin nut 230 ft/lbs. 10. Torque Spec. for king pin nut is 300 ft/lbs. 11. Torque Spec. for king pin nut is 406 ft/lbs. 12. Torque Spec. for king pin nut is 350/475 ft/lbs. 13. Includes end caps. 14. Torque Spec. for knuckle attachment bolts is 170-200 ft/lbs. 15. Kit uses special removal tool ST90-1.

Steering Knuckle King Pin Kits

GMC, HENDRICKSON,
HINO, IMT / INGERSOLL

Model	Axle	Year	OEM No.	Pin Type	OEM Spec	Qwik Kit No. ¹	Plus Kit No. ²	Econo Kit No.	Lip Seal/ Bushing Driver Installation Tool	Axle Sleeve Used With APE	APE Cutter Kit Used
-------	------	------	---------	----------	----------	---------------------------	---------------------------	---------------	--	---------------------------	---------------------

GMC

7500 Series	9000# (F-090)	1966 to date	2321013 8885021	E	1.434 x 8.75	K95G ¹²	70.095.07 ¹²	50.095.07 ¹²	ST70-9		
	11000# (F-110)	1963-1975	2264897	E	1.609 x 9.75	K125G ¹²	70.125.07 ¹²	50.125.07 ¹²	ST70-5		
	12000# (F-120)	1963-1975	2264897	E	1.609 x 9.75	K125G ¹²	70.125.07 ¹²	50.125.07 ¹²	ST70-5		
	12000# (F-120D)	1975 to date	8885621	B	1.745 x 9.37	K121G ⁷	70.121.07 ⁷	50.121.07 ⁷	ST70-11		
	18000# (FL-901)	1970 to date	2452865	B	1.999 x 11.04	KH901L	78.901.12	58.901.12	ST70-12		
8500 Series	7000# (F-070)	1966 to date	3838390 3927943	A	1.249 x 7.87	K70G	70.070.07	50.070.07	ST70-1		
	9000# (F-090)	1963 to date	2321013 8885021	E	1.434 x 8.75	K95G ¹²	70.095.07 ¹²	50.095.07 ¹²	ST70-9		
	11000# (F-110)	1963-1972	2264897	E	1.609 x 9.75	K125G ¹²	70.125.07 ¹²	50.125.07 ¹²	ST70-5		
	12000# (F-120)	1963-1975	2264897	E	1.609 x 9.75	K125G ¹²	70.125.07 ¹²	50.125.07 ¹²	ST70-5		
	12000# (F-120D)	1975 to date	8885621	B	1.745 x 9.38	K121G ⁷	70.121.07 ⁷	50.121.07 ⁷	ST70-11		
	18000# (FL-901)	1971 to date	2452865	B	1.999 x 11.04	KH901L	78.901.12	58.901.12	ST70-12		
9000 Series	11000# (F-110)	1960-1962	2264897	E	1.609 x 9.75	K125G ¹²	70.125.07 ¹²	50.125.07 ¹²	ST70-5		
9500 Series	7000# (F-070)	1966 to date	3838390 3927943	A	1.249 x 7.87	K70G	70.070.07	50.070.07	ST70-1		
	9000# (F-090)	1966 to date	2321013 8885021	E	1.434 x 8.75	K95G ¹²	70.095.07 ¹²	50.095.07 ¹²	ST70-9		
	11000# (F-110)	1963-1975	2264897	E	1.609 x 9.75	K125G ¹²	70.125.07 ¹²	50.125.07 ¹²	ST70-5		
	11000# (FE-970)	1966-1972	2442145	B	1.606 x 8.81	K970R	70.970.18	50.970.18	ST70-13		
	12000# (F-120)	1963-1975	2264897	E	1.609 x 9.75	K125G ¹²	70.125.07 ¹²	50.125.07 ¹²	ST70-5		
	12000# (FE-900)	1966-1972	2264897	E	1.609 x 9.75	K125G ¹²	70.125.07 ¹²	50.125.07 ¹²	ST70-5		
	12000# (F-120D)	1975 to date	8885621	B	1.745 x 9.37	K121G ⁷	70.121.07 ⁷	50.121.07 ⁷	ST70-11		
	18000# (FL-901)	1966 to date	2452865	B	1.999 x 11.04	KH901L	78.901.12	58.901.12	ST70-12		
	18000# (FL-931)		2036352	B	1.999 x 11.21	KH931L	78.931.12	58.931.12	ST70-12	92.931.12	84.931.12

HENDRICKSON

FRONT STEER AXLE	AIRTEK SOFTEK STEERTEK 64905-004		60961-009 60961-039 60961-040 00063311 LT SIDE 00063312 RT SIDE 00063313 BT SIDES					50.121.08	ST70-32		
REAR TAG AXLES	UST		002916	A	1.810 x 10.56	K126W	70.126.23	50.126.23	ST70-33	91.127.23	84.122.05
	UC2, UC3, UC4 US2, US3, US4		003270 003200	H	1.810 x 9.54	K120H ¹⁴			ST70-33		
	USP		001434	A	1.810 x 10.56	K127W	70.127.23	50.127.23	ST70-33	91.127.23	84.122.05
			006648	A	1.810 x 9.54	K131H			ST70-33		

HINO

NA, NB, NC		2005-2008	R201478	A	1.234 x 6.78	K60R			ST70-10		
ND, NE, NJ-258 A-LP	8,000#	2005-2008	R201474	B	1.499 x 7.50	K80R	70.080.18	50.080.18	ST70-28		
ND, NE, NJ, NV	10,000#	2005-2008	R201470	B	1.794 x 10.40	K961L	70.961.12	50.961.12	ST70-7	92.961.12	84.122.05

IMT / INGERSOLL

	700214		700040	B	2.248 x 11.30	K700T	70.700.20		ST70-29	92.700.20	84.700.20
--	--------	--	--------	---	---------------	-------	-----------	--	---------	-----------	-----------

For all Qwik Kit® - BUSHING "T" HANDLE WRENCHES



Tool No.	Description
ST-100-1	Short "T" Handle Wrench
ST-100-2	Long "T" Handle Wrench
100M1-1	Replacement head
Above Wrenches will fit the bushings in most kits.	
The Following kits do not use wrenches: K80A, K120A, K120N, K150KG, K160A, K700T, K60U, 50.121.08	

Tool No.	Description
ST-100-3	Short "T" Handle Wrench
ST-100-4	Long "T" Handle Wrench
100M1-2	Replacement head
Above Wrenches will fit the bushings in the following kits: K50F, K71F, K72F, K80G, K110G, K120G, K122V, K146E, K147E, K180E, K68Z, K69Z	

Model	Axle	Year	OEM No.	Pin Type	OEM Spec	Owik Kit No. ¹	Plus Kit No. ²	Econo Kit No.	Lip Seal/ Bushing Driver Installation Tool	Axle Sleeve Used With APE	APE Cutter Kit Used
-------	------	------	---------	----------	----------	---------------------------	---------------------------	---------------	--	---------------------------	---------------------

INTERNATIONAL / NAVISTAR

7500# FA-65		1957-1966	61556R91	A	1.234 x 7.65	K98I	70.098.09	50.098.09	ST70-10		
8200# FA-71		1975-1988	473695C91	A	1.359 x 7.96	K101I	70.101.09	50.101.09	ST70-2	91.101.09	84.103.19
8200# FA-73		1975-1988	473695C91	A	1.359 x 7.96	K101I	70.101.09	50.101.09	ST70-2	91.101.09	84.103.19
8200# FA-74		1975-1988	473695C91	A	1.359 x 7.96	K101I	70.101.09	50.101.09	ST70-2	91.101.09	84.103.19
7500# FA-80		1950-1968	61556R91	A	1.234 x 7.65	K98I	70.098.09	50.098.09	ST70-10		
7500# FA-91		1960-1968	61556R91	A	1.234 x 7.65	K98I	70.098.09	50.098.09	ST70-10		
7500# FA-98		1950-1975	61556R91	A	1.234 x 7.65	K98I	70.098.09	50.098.09	ST70-10		
7500# FA-99		1957-1975	61556R91	A	1.234 x 7.65	K98I	70.098.09	50.098.09	ST70-10		
9000# FA-100		1950-1968	303136C92	B	1.433 x 8.50	KD901R	74.901.18	54.901.18	ST70-9		
7500# FA-101		1962-1975	61556R91	A	1.234 x 7.65	K98I	70.098.09	50.098.09	ST70-10		
8200# FA-101 FA-104		1975-1988	473695C91 1648204C91	A	1.359 x 7.96	K101I	70.101.09	50.101.09	ST70-2	91.101.09	84.103.19
8200# FA-101 FA-104		1989 to date	1660271C92	B	1.359 x 7.96	K102I	70.102.09	50.102.09	ST70-2	92.102.09	84.103.19
9000# FA-102		1963-1968	303136C92	B	1.433 x 8.50	KD901R	74.901.18	54.901.18	ST70-9		
7500# FA-103			473695C91	A	1.359 x 7.96	K101I	70.101.09	50.101.09	ST70-2	91.101.09	84.103.19
9000# FA-105		1955-1975	303136C92	B	1.433 x 8.50	KD901R	74.901.18	54.901.18	ST70-9		
9000# FA-109		1970-1981	408547C91 408547C93 472093C91	B	1.484 x 8.85	K109I		50.109.09			
9000# FA-109		1981 to date	493092C91 493095C92	A	1.484 x 8.85	K108I		50.108.09			
12000# FA-110		1950-1968	155932R92 303137C92 69576R92	E	1.609 x 9.75	K125G ¹²	70.125.07 ¹²	50.125.07 ¹²	ST70-5		
12000# FA-112		1960-1975	229265R91 303138C92	B	1.606 x 8.81	K970R	70.970.18	50.970.18	ST70-13		
12000# FA-113		1960-1975	229265R91 303138C92	B	1.606 x 8.81	K970R	70.970.18	50.970.18	ST70-13		
12000# FA-115		1955-1968	155932R92 303137C92 69576R92	E	1.609 x 9.75	K125G ¹²	70.125.07 ¹²	50.125.07 ¹²	ST70-5		
12000# FA-118		1981 to date	399942C93 588808C91 1658934C91	B	1.609 x 9.65	K140I	70.140.09	50.140.09	ST70-5	92.140.09	84.120.05
12000# FA-127		1981 to date	588808C91 1658934C91 399942C93	B	1.609 x 9.65	K140I	70.140.09	50.140.09	ST70-5	92.140.09	84.120.05
18000# FA-136		1963-1975	303140C92	B	1.999 x 11.04	KH901L	78.901.12	58.901.12	ST70-12		
12000# FA-139		1975-1981	472094C91 491611C93 493094C93	A	1.609 x 9.65	K139I	70.139.09	50.139.09	ST70-5		
12000# FA-139		1981 to date	588808C91 1658934C91 399942C93	B	1.609 x 9.65	K140I	70.140.09	50.140.09	ST70-5	92.140.09	84.120.05
12000# FA-201		1960-1972	303139C92 870148R92	B	1.794 x 9.12	K901L	70.901.12	50.901.12	ST70-7		
9000# FA-208		1960-1975	303136C92	B	1.433 x 8.50	KD901R	74.901.18	54.901.18	ST70-9		

PIN TYPE CHART:		C - SAME SIDE LOCK FLATS		G - STEP THREADED	
	A - SINGLE LOCK FLAT		E - TAPERED THREADED		H - NO LOCK FLATS
	B - DOUBLE LOCK FLAT		F - TAPERED		J - SINGLE STEP

1. STEMCO Kaiser Owik Kit® feature patented spiral steel bushings. 2. STEMCO Kaiser Plus Kit® feature pre-sized steel back bronze bushings. 3. Kit has composite bushings. 4. Modify spindles to receive end plates. 5. Bolt on cap. 6. Threaded cap. 7. Length of STEMCO Kaiser pin is 9 3/4". 8. STEMCO Kaiser pin is longer than OEM. 9. Torque Spec. for king pin nut is 300 ft/lbs. 10. Torque Spec. for king pin nut is 300 ft/lbs. 11. Torque Spec. for king pin nut is 406 ft/lbs. 12. Torque Spec. for king pin nut is 350/475 ft/lbs. 13. Includes end caps. 14. Torque Spec. for knuckle attachment bolts is 170-200 ft/lbs. 15. Kit uses special removal tool ST90-1.

Steering Knuckle King Pin Kits

INTERNATIONAL / NAVISTAR

Model	Axle	Year	OEM No.	Pin Type	OEM Spec	Qwik Kit No. ¹	Plus Kit No. ²	Econo Kit No.	Lip Seal/ Bushing Driver Installation Tool	Axle Sleeve Used With APE	APE Cutter Kit Used
-------	------	------	---------	----------	----------	---------------------------	---------------------------	---------------	--	---------------------------	---------------------

INTERNATIONAL / NAVISTAR

9000# FA-209		1960-1975	303136C92	B	1.433 x 8.50	KD901R	74.901.18	54.901.18	ST70-9		
12000# FA-211		1960-1973	303139C92 870148R92	B	1.794 x 9 .12	K901L	70.901.12	50.901.12	ST70-7		
12000# FA-212		1960-1973	303139C92 870148R92	B	1.794 x 9 .12	K901L	70.901.12	50.901.12	ST70-7		
12000# FA-215 FA-216, FA-217		1960-1973	303139C92 870148R92	B	1.794 x 9 .12	K901L	70.901.12	50.901.12	ST70-7		
12000# FA-218		1960-1973	303139C92 870148R92	B	1.794 x 9 .12	K901L	70.901.12	50.901.12	ST70-7		
12000# FA-219		1963-1973	303139C92 870148R92	B	1.794 x 9 .12	K901L	70.901.12	50.901.12	ST70-7		
12000# FA-228		1973 to date	452344C91	B	1.794 x 10.39	K921L	70.921.12	50.921.12	ST70-7		
16000# FA-231			474520C91	B	1.999 x 11.21	KH931L	78.931.12	58.931.12	ST70-12	92.931.12	84.931.12
18000# FA-232			474520C91	B	1.999 x 11.21	KH931L	78.931.12	58.931.12	ST70-12	92.931.12	84.931.12
9000# FA-309		1975-1981	470752C91 493095C91	A	1.609 x 9.15	K309I	70.309.09	50.309.09	ST70-5		
9000# FA-309		1981 to date	586806C91	B	1.609 x 9.15	K310I	70.310.09	50.310.09	ST70-5		
10800# FA-329		1975-1981	472094C91 491611C92 493094C92 493094C93	A	1.609 x 9.65	K139I	70.139.09	50.139.09	ST70-5		
12000# FA-329		1981 to date	588808C91 1658934C91 399942C93 1655421C91	B	1.609 x 9.65	K140I	70.140.09	50.140.09	ST70-5	92.140.09	84.120.05
12000# FA-339		1975-1981	472094C91 491611C92 493094C92 493094C93	A	1.609 x 9.65	K139I	70.139.09	50.139.09	ST70-5		
12000# FA-339 FA-337 FA-343		1981 to date	588808C91 1658934C91 399942C93	B	1.609 x 9.65	K140I	70.140.09	50.140.09	ST70-5	92.140.09	84.120.05
10800# FA-341 Aluminum Axle			472094C91 491611C92 493094C92 493094C93	A	1.609 x 9.65	K139I	70.139.09	50.139.09	ST70-5		
12000# FA-342 FA-343		1981 to date	588808C91 1658934C91 399942C93 493094C93	B	1.609 x 9.65	K140I	70.140.09	50.140.09	ST70-5	92.140.09	84.120.05
5000# I-050			473695C91	A	1.359 x 7.96	K101I	70.101.09	50.101.09	ST70-2	91.101.09	84.103.19
6000# I-060			473695C91	A	1.359 x 7.96	K101I	70.101.09	50.101.09	ST70-2	91.101.09	84.103.19
7500# I-075			473695C91	A	1.359 x 7.96	K101I	70.101.09	50.101.09	ST70-2	91.101.09	84.103.19
8000# I-80S, I-80SG, 02-ADB, 02-ADV			1660271C92	B	1.359 x 7.96	K102I	70.102.09	50.102.09	ST70-2	92.102.09	84.103.19
8000# 02-AEM, 02-AHA			3573204C91	C	1.359 x 7.97	K103S	70.103.19	50.103.19	ST70-2	93.103.19	84.103.19
9000# I-090		Before Aug. 1981	470752C91 493095C91	A	1.609 x 9.15	K309I	70.309.09	50.309.09	ST70-5		

For all Qwik Kit® - BUSHING "T" HANDLE WRENCHES



Tool No.	Description
ST-100-1	Short "T" Handle Wrench
ST-100-2	Long "T" Handle Wrench
100M1-1	Replacement head
Above Wrenches will fit the bushings in most kits.	
The Following kits do not use wrenches: K80A, K120A, K120N, K150KG, K160A, K700T, K60U, 50.121.08	

Tool No.	Description
ST-100-3	Short "T" Handle Wrench
ST-100-4	Long "T" Handle Wrench
100M1-2	Replacement head
Above Wrenches will fit the bushings in the following kits:	
K50F, K71F, K72F, K80G, K110G, K120G, K122V, K146E, K147E, K180E, K68Z, K69Z	

Model	Axle	Year	OEM No.	Pin Type	OEM Spec	Owik Kit No. ¹	Plus Kit No. ²	Econo Kit No.	Lip Seal/ Bushing Driver Installation Tool	Axle Sleeve Used With APE	APE Cutter Kit Used
-------	------	------	---------	----------	----------	---------------------------	---------------------------	---------------	--	---------------------------	---------------------

INTERNATIONAL / NAVISTAR

	9000# I-090	After Aug. 1981	586806C91	B	1.609 x 9.15	K310I	70.310.09	50.310.09	ST70-5		
	10000# I-100S I-100SG, 02-ADC		1688411C92	B	1.921 x 9.87	K120I ⁶	70.120.09 ⁸ 70.120.99 ^{3,8}	50.120.09 ⁸	ST70-19	92.120.09	84.147.05
	10000# I-100W 02-AER		329022	B	2.046 x 10.12	K141S ⁹	70.141.19 ⁸	50.141.19 ⁸	ST70-24		
	10800# I-108 All except code 02309		588808C91 399942C93	B	1.609 x 9.65	K140I	70.140.09	50.140.09	ST70-5	92.140.09	84.120.05
	10800# I-108 For code 02309		586806C91	B	1.609 x 9.15	K310I	70.310.09	50.310.09	ST70-5		
	12000# I-120 All except code 02309		588808C91 399942C93	B	1.609 x 9.65	K140I	70.140.09	50.140.09	ST70-5	92.140.09	84.120.05
	12000# I-120 For code 02309		586806C91	B	1.609 x 9.15	K310I	70.310.09	50.310.09	ST70-5		
	12000# I-120S I-120SG, 02-ADD 02-ADG, 02-ADP	1989 to date	1668411C91 1659688C91 1659686C91 1659687C91	B	1.921 x 9.87	K120I ⁶	70.120.09 ⁸ 70.120.99 ^{3,8}	50.120.09 ⁸	ST70-19	92.120.09	84.147.05
	13200# I-132 I-132S		586806C91	B	1.609 x 9.65	K140I	70.140.09	50.140.09	ST70-5	92.140.09	84.120.05
	14000# I-140S 02-ADE	1990 to date	1668412C91	B	2.046 x 10.12	K141S ⁹	70.141.19 ⁸	50.141.19 ⁸	ST70-24		
With Rockwell Axles:	12000# FE-900	1950-1962	303137C92 69576R92 155932R92	E	1.609 x 9.75	K125G ¹²	70.125.07 ¹²	50.125.07 ¹²	ST70-5		
	12000# FE-970	1964-1968	229265R91 303138C92	B	1.606 x 8.81	K970R	70.970.18	50.970.18	ST70-13		
	12000# FF-921	1972 to date	452344C91	B	1.794 x 10.39	K921L	70.921.12	50.921.12	ST70-7		
	18000# FL-901		303140C92 870148R92	B	1.999 x 11.04	KH901L	78.901.12	58.901.12	ST70-12		
	12000# FE-971		577684C91	B	1.607 x 9.37	K971R	70.971.18	50.971.18	ST70-13		
	12000# FF-931 FF-941		549800C91	B	1.794 x 10.40	K931L	70.931.12	50.931.12	ST70-7	92.961.12	84.122.05
	12000# FF-961 02-ARV, 02-ARA 02-ARW		2505492C91	B	1.794 x 10.40	K961L	70.961.12	50.961.12	ST70-7	92.961.12	84.122.05
	12000# 02-AED 02-AEG			A	1.794 x 9.05	K122E	70.122.05	50.122.05	ST70-7	91.22.05	84.122.05
	18000# FL-931 FL-941		474520C91	B	1.999 x 11.21	KH931L	78.931.12	58.931.12	ST70-12	92.931.12	84.931.12
	18000# 02-ARU		2505495C91	B	1.999 x 11.21	K180R	70.180.18	50.180.18	ST70-12	92.180.18	84.931.12
	12000# FF-981 02-ARK, 02-ARL 02-ASB, 02-ASD		2500542C91	B	1.794 x 8.87	K981R	70.981.18	50.981.18	ST70-7	92.961.12	84.122.05

ISUZU

FTR			12540329	G	1.889 x 9.20	K110G					
NPR		1990-1998	5-87830978-2 94058104	A	1.181 x 7.38	K68Z	70.068.26		ST70-37	91.068.26	84.056.07

PIN TYPE CHART:		C - SAME SIDE LOCK FLATS		G - STEP THREADED	
	A - SINGLE LOCK FLAT		E - TAPERED THREADED		H - NO LOCK FLATS
	B - DOUBLE LOCK FLAT		F - TAPERED		J - SINGLE STEP

1. STEMCO Kaiser Owik Kit® feature patented spiral steel bushings. 2. STEMCO Kaiser Plus Kit® feature pre-sized steel back bronze bushings. 3. Kit has composite bushings. 4. Modify spindles to receive end plates. 5. Bolt on cap. 6. Threaded cap. 7. Length of STEMCO Kaiser pin is 9 3/4". 8. STEMCO Kaiser pin is longer than OEM. 9. Torque Spec. for king pin nut 230 ft/lbs. 10. Torque Spec. for king pin nut is 300 ft/lbs. 11. Torque Spec. for king pin nut is 406 ft/lbs. 12. Torque Spec. for king pin nut is 350/475 ft/lbs. 13. Includes end caps. 14. Torque Spec. for knuckle attachment bolts is 170-200 ft/lbs. 15. Kit uses special removal tool ST90-1.

Steering Knuckle King Pin Kits

ISUZU,
KENWORTH, KGI,
KIMBLE MIXER,
LINK, MACK

Model	Axle	Year	OEM No.	Pin Type	OEM Spec	Qwik Kit No. ¹	Plus Kit No. ²	Econo Kit No.	Lip Seal/ Bushing Driver Installation Tool	Axle Sleeve Used With APE	APE Cutter Kit Used
-------	------	------	---------	----------	----------	---------------------------	---------------------------	---------------	--	---------------------------	---------------------

ISUZU

NPR		1998-present	5-87831608-1 97723802 98441181 5-87832211-1	A	1.181 x 7.38	K69Z	70.069.26		ST70-37	91.068.26	84.056.07
-----	--	--------------	--	---	--------------	------	-----------	--	---------	-----------	-----------

KENWORTH (See Rockwell / Meritor, Spicer / Dana / Eaton)

KGI

	15000# KGS150		579-1044	A	1.999 x 11.32	K150KG			ST70-26	91.150.07	84.931.12
	23000# KGS230		KA531	A	2.249 x 10.60	K230KG	70.230.07		ST70-29	94.230.07	84.700.20

KIMBLE MIXER

			T41-12001-71	C	1.872 x 9.05	K149E			ST70-23	93.147.05	84.147.05
--	--	--	--------------	---	--------------	-------	--	--	---------	-----------	-----------

LINK

	12000# DuraLift & Model 9000		84001930	A	1.794 x 9.05	K123K			ST70-7		
	13200# DuraLift & Model 9000		84001931	A	1.794 x 9.05	K132K			ST70-7	91.132.11	84.122.05

MACK

Midliner MS-CS	7500# 9500#		50.00336305	A	1.377 x 7.00	K75M					
DM, RM, DUMP, MIXER, CONSTRUCTION, REFUSE	10000# FA-507 FA-5071		301SQ46A	F	1.500 x 7.40	K535M ⁴					
	10000# FA-512		301SQ46A	F	1.500 x 7.40	K535M ⁴					
	10000# FA-514 FA-5141		301SQ46A	F	1.500 x 7.40	K535M ⁴					
	10000# FA-517		301SQ46A	F	1.500 x 7.40	K535M ⁴					
	12000# FA-522 FA-5221	1963 to date	301SQ47CPI 301SQ47D	F	1.625 x 7.46	K533M thin wall bushing	70.533.13	50.533.13	ST70-6		
	12000# FA-523 FA-5231	1963 to date	301SQ47CPI 301SQ47D 301SQ47E	F	1.625 x 7.46	K533M thin wall bushing	70.533.13	50.533.13	ST70-6		
	12000# FA-532 FA-538	1950 to date	301SQ47CPI 301SQ47D 301SQ47E	F	1.625 x 7.46	K533M thin wall bushing	70.533.13	50.533.13	ST70-6		
	10000# FA-535		301SQ46A	F	1.500 x 7.40	K535M ⁴					
	12000# FXL12		301SQ53	E	2.360 x 8.92	K536M ¹⁵					
	14600# FXL14.6		301SQ53	E	2.360 x 8.92	K536M ¹⁵					
	18000# FA-602 FA-604		205SQ12	B	1.999 x 10.90	KH901L	78.901.12	58.901.12	ST70-12		
	18000# FA-616 FA-617		301SQ52	F	2.125 x 8.75	K616M	70.616.13	50.616.13	ST70-18		
	18000# FXL18		301SQ53	E	2.360 x 8.92	K536M ¹⁵					
20000# FA-616 FA-617		301SQ52	F	2.125 x 8.75	K616M	70.616.13	50.616.13	ST70-18			

For all Qwik Kit® - BUSHING "T" HANDLE WRENCHES



Tool No.	Description
ST-100-1	Short "T" Handle Wrench
ST-100-2	Long "T" Handle Wrench
100M1-1	Replacement head
Above Wrenches will fit the bushings in most kits.	
The Following kits do not use wrenches: K80A, K120A, K120N, K150KG, K160A, K700T, K60U, 50.121.08	

Tool No.	Description
ST-100-3	Short "T" Handle Wrench
ST-100-4	Long "T" Handle Wrench
100M1-2	Replacement head
Above Wrenches will fit the bushings in the following kits: K50F, K71F, K72F, K80G, K110G, K120G, K122V, K146E, K147E, K180E, K68Z, K69Z	

Model	Axle	Year	OEM No.	Pin Type	OEM Spec	Owik Kit No. ¹	Plus Kit No. ²	Econo Kit No.	Lip Seal/ Bushing Driver Installation Tool	Axle Sleeve Used With APE	APE Cutter Kit Used
-------	------	------	---------	----------	----------	---------------------------	---------------------------	---------------	--	---------------------------	---------------------

MACK

DM, RM, DUMP, MIXER, CONSTRUCTION, REFUSE	20000# FXL20		301SQ53	E	2.360 x 8.92	K536M ¹⁵					
	23000# FXL23		301SQ53	E	2.360 x 8.92	K536M ¹⁵					
	24000# FA-616 FA-617		301SQ52	F	2.125 x 8.75	K616M	70.616.13	50.616.13	ST70-18		
With Rockwell Axles:	12000# FE-900	1960-1966	205SQ11	E	1.609 x 9.75	K125G ¹²	70.125.07 ¹²	50.125.07 ¹²	ST70-5		
	12000# FF-921	1972 to date	205SQ15	B	1.794 x 10.39	K921L	70.921.12	50.921.12	ST70-7		
	18000# FL-901		205SQ12	B	1.999 x 11.04	KH901L	78.901.12	58.901.12	ST70-12		

MAN

	V8 65C-02	1993	81.44205-6013 6313078	J	1.969 x 8.77	K120N			ST70-27		
--	-----------	------	--------------------------	---	--------------	-------	--	--	---------	--	--

MCI

MC-7, MC-8, MC-9	12000#		121	E	1.794 x 10.68	K170G ¹²					
	15000# 16000#		2254366 IC-2-40	E	1.794 x 10.68	K170G ¹²					
	13200# FF-941 FF-961			B	1.794 x 10.40	K961L	70.961.12	50.961.12	ST70-7	92.961.12	84.122.05
MC-12	14600# FG-931, FG-933, FG-941, FG-943, FG-952		U-2-54	B	1.794 x 10.40	KG931R	77.931.18	57.931.18	ST70-7	92.931.12	84.931.12
102DL3	16000# 20000# FH-946		01-01-1017 01-01-1079	B	1.794 x 9.19	KH946R	78.946.18	58.946.18	ST70-7	92.946.18	84.122.05
G COACH	16000# 1-160S			B	2.046 x 11.00	K161S			ST70-24		

McNELIUS MTM

			188033	A	1.810 x 10.56	K126W	70.126.23	50.126.23	ST70-33	91.127.23	84.122.05
--	--	--	--------	---	---------------	-------	-----------	-----------	---------	-----------	-----------

MITSUBISHI

			MK703748	A	1.101 x 7.10	K60U			ST70-34		
--	--	--	----------	---	--------------	------	--	--	---------	--	--

NEW FLYER

	MAN		6313078	J	1.969 x 8.77	K120N			ST70-27		
--	-----	--	---------	---	--------------	-------	--	--	---------	--	--







PETERBILT (See Rockwell / Meritor, Spicer / Dana / Eaton)

RIDEWELL

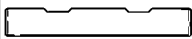
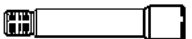
	RSS-232-8K		1660170	B	1.500 x 8.93	K941R	70.941.18	50.941.18	ST70-28		
	RSS-232LM, MM, HM		1660106	B	1.794 x 10.40	KG931R	77.931.18	57.931.18	ST70-7	91.931.18	84.122.05
			1667325B034	A	1.810 x 10.56	K127W	70.127.23	50.127.23	ST70-33	91.127.23	84.122.05
	RSS-232-20K		1660189	B	1.999 x 11.21	KH931L	78.931.12	58.931.12	ST70-12	92.931.12	84.931.12

ROCKWELL / MERITOR (Non-Driving Front Steering Axles)

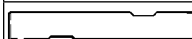
	12000# 16612, 16613, 16616		123, 144, 152, 186	E	1.607 x 9.75	K125G ¹²	70.125.07 ¹²	50.125.07 ¹²	ST70-5		
	12000# 16930, 16931		121	E	1.794 x 10.68	K170G ¹²					

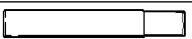
PIN TYPE CHART:					
	C - SAME SIDE LOCK FLATS		G - STEP THREADED		A - SINGLE LOCK FLAT
	E - TAPERED THREADED		H - NO LOCK FLATS		B - DOUBLE LOCK FLAT
	F - TAPERED		J - SINGLE STEP		

1. STEMCO Kaiser Owik Kit® feature patented spiral steel bushings. 2. STEMCO Kaiser Plus Kit® feature pre-sized steel back bronze bushings. 3. Kit has composite bushings. 4. Modify spindles to receive end plates. 5. Bolt on cap. 6. Threaded cap. 7. Length of STEMCO Kaiser pin is 9 3/4". 8. STEMCO Kaiser pin is longer than OEM. 9. Torque Spec. for king pin nut 230 ft/lbs. 10. Torque Spec. for king pin nut is 300 ft/lbs. 11. Torque Spec. for king pin nut is 406 ft/lbs. 12. Torque Spec. for king pin nut is 350/475 ft/lbs. 13. Includes end caps. 14. Torque Spec. for knuckle attachment bolts is 170-200 ft/lbs. 15. Kit uses special removal tool ST90-1.

Steering Knuckle King Pin Kits

ROCKWELL / MERITOR

Model	Axle	Year	OEM No.	Pin Type	OEM Spec	Qwik Kit No. ¹	Plus Kit No. ²	Econo Kit No.	Lip Seal/ Bushing Driver Installation Tool	Axle Sleeve Used With APE	APE Cutter Kit Used
-------	------	------	---------	----------	----------	---------------------------	---------------------------	---------------	--	---------------------------	---------------------

ROCKWELL / MERITOR (Non-Driving Front Steering Axles)

	14600# 17100, 17101, 17111, 17801		1309, 1310, 1319	B	1.794 x 10.40	KG931R	77.931.18	57.931.18	ST70-7	92.931.18	84.122.05
	5000# FA941			A	1.179 x 6.36	K56G	70.056.07	50.056.07	ST70-4	91.056.07	84.056.07
	7000# FC-901 FC-902, FC-903		143, 155	B	1.234 x 7.43	K70D	70.070.04	50.070.04	ST70-10		
	FC-921		1314, 1320	B	1.234 x 7.43	K71D	70.071.04	50.071.04	ST70-10		
	8000# FC-941		1318	B	1.500 x 8.93	K941R	70.941.18	50.941.18	ST70-28		
	9000# FD-900	1950-1955	136, 141	E	1.434 x 9.41	KD900R					
	9000# FD-901 FD-902, FD-903	1955 to date	138, 142, 154	B	1.434 x 8.50	KD901R	74.901.18	54.901.18	ST70-9		
	10000# FD-961 FD-965		1315, 1470, 1471	B	1.794 x 10.40	K961L	70.961.12	50.961.12	ST70-7	92.961.12	84.122.05
	11000# FE-900 FE-903, FE-910		123, 144	E	1.607 x 9.75	K125G ¹²	70.125.07 ¹²	50.125.07 ¹²	ST70-5		
	12000# FE-970 (Straight Pin)		156, 157	B	1.606 x 8.81	K970R	70.970.18	50.970.18	ST70-13		
	12000# FF-971		1300	B	1.609 x 9.37	K971R	70.971.18	50.971.18	ST70-13		
	12000# FF-901, FF-903		167, 172	B	1.794 x 9.12	K901L	70.901.12	50.901.12	ST70-7		
	12000# FF-921, FF-923		193, 199	B	1.794 x 10.39	K921L	70.921.12	50.921.12	ST70-7		
	16000# FH-901		168, 170	B	1.999 x 11.04	KH901L	78.901.12	58.901.12	ST70-12		
	18000# FL-901		168, 170	B	1.999 x 11.04	KH901L	78.901.12	58.901.12	ST70-12		
	12000# FF-930		121	E	1.794 x 10.68	K170G ¹²					
	12000# FF-931 FF-932, FF-933 FF-934		195, 1307	B	1.794 x 10.40	K931L	70.931.12	50.931.12	ST70-7	92.961.12	84.122.05
1-599 Series	13200# FF-941 FF-942, FF-943 FF-944, FF-945		195, 1307	B	1.794 x 10.40	K931L	70.931.12	50.931.12	ST70-7	92.961.12	84.122.05
600 Series	13200# FF-941 FF-942, FF-943 FF-944, FF-945		1315, 1470	B	1.794 x 10.40	K961L	70.961.12	50.961.12	ST70-7	92.961.12	84.122.05
	FF-946		R201473	B	1.794 x 10.40	K120R	70.120.18	50.120.18	ST70-7		
	13200# FF-961 FF-962, FF-966 FF-967, FC-965		1315, 1470	B	1.794 x 10.40	K961L	70.961.12	50.961.12	ST70-7	92.961.12	84.122.05
	12000# FF-981 FF-982, FF-983 FF-984, FF-986 FF-987		1419, 1472	B	1.794 x 8.87	K981R	70.981.18	50.981.18	ST70-7	92.931.12	84.122.05
	14600# FG-931 FG-933, FG-941 FG-943, FG-952		1309, 1310 1319, 1471	B	1.794 x 10.40	KG931R	77.931.18	57.931.18	ST70-7	92.931.18	84.122.05
	16000# FH-941 20000# FH-945 FH-946		1424 1420	B	1.794 x 9.19	KH946R	78.946.18	58.946.18	ST70-7	92.946.18	84.122.05
	18000# FL-931 FL-933, FL-941 FL-943, FH-951		198, 1312	B	1.999 x 11.21	KH931L	78.931.12	58.931.12	ST70-12	92.931.12	84.931.12

For all Qwik Kit® - BUSHING "T" HANDLE WRENCHES



Tool No.	Description
ST-100-1	Short "T" Handle Wrench
ST-100-2	Long "T" Handle Wrench
100M1-1	Replacement head
Above Wrenches will fit the bushings in most kits.	
The Following kits do not use wrenches: K80A, K120A, K120N, K150KG, K160A, K700T, K60U, 50.121.08	

Tool No.	Description
ST-100-3	Short "T" Handle Wrench
ST-100-4	Long "T" Handle Wrench
100M1-2	Replacement head
Above Wrenches will fit the bushings in the following kits: K50F, K71F, K72F, K80G, K110G, K120G, K122V, K146E, K147E, K180E, K68Z, K69Z	







Model	Axle	Year	OEM No.	Pin Type	OEM Spec	Owik Kit No. ¹	Plus Kit No. ²	Econo Kit No.	Lip Seal/ Bushing Driver Installation Tool	Axle Sleeve Used With APE	APE Cutter Kit Used
-------	------	------	---------	----------	----------	---------------------------	---------------------------	---------------	---	---------------------------------	------------------------

ROCKWELL / MERITOR (Non-Driving Front Steering Axles)

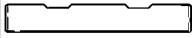
6000# MFS-06			R201478	A	1.234 x 6.78	K60R			ST70-3		
7000# MFS-07			R201479, R201483	B	1.499 x 7.15	K70R	70.070.18	50.070.18	ST70-28		
8000# MFS-08			R201474	B	1.499 x 7.50	K80R	70.080.18	50.080.18	ST70-28		
10000# MFS-10			R201470	B	1.794 x 10.40	K961L	70.961.12	50.961.12	ST70-7	92.961.12	84.122.05
12000# MFS-12122A MFS-12143A MFS-12153A			R201315 R201470	B	1.794 x 10.40	K961L	70.961.12	50.961.12	ST70-7	92.961.12	84.122.05
12000# MFS-12122D MFS-12143D MFS-12144D			R201419 R201472	B	1.794 x 8.87	K981R	70.981.18	50.981.18	ST70-7	92.961.12	84.122.05
12000# MFS-12144A MFS-12155A			R201473	B	1.794 x 10.40	K120R	70.120.18	50.120.18	ST70-7		
13000# MFS-13122D MFS-13143D MFS-13144D			R201419 R201472	B	1.794 x 8.87	K981R	70.981.18	50.981.18	ST70-7	92.961.12	84.122.05
13000# MFS-131015 MFS-13143A MFS-13144A			R201471	B	1.794 x 10.40	KG931R	77.931.18	57.931.18	ST70-7	92.931.18	84.122.05
14000# MFS-141015 MFS-14143A MFS-14153A			R201471	B	1.794 x 10.40	KG931R	77.931.18	57.931.18	ST70-7	92.931.18	84.122.05
16000# MFS-161015 MFS-16122A MFS-16143A			R201475	B	1.999 x 11.21	K180R	70.180.18	50.180.18	ST70-12	92.180.18	84.931.12
16000# MFS-16133A			R201476	B	1.999 x 11.21	K181R	70.181.18	50.181.18	ST70-12	92.931.12	84.931.12
18000# MFS-18133A			R201476	B	1.999 x 11.21	K181R	70.181.18	50.181.18	ST70-12	92.931.12	84.931.12
18000# MFS-18143A			R201475	B	1.999 x 11.21	K180R	70.180.18	50.180.18	ST70-12	92.180.18	84.931.12
20000# MFS-20133A			R201476	B	1.999 x 11.21	K181R	70.181.18	50.181.18	ST70-12	92.931.12	84.931.12
20000# MFS-20142A			R201477	B	1.999 x 11.21	KH931L	78.931.12	58.931.12	ST70-12	92.931.12	84.931.12

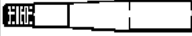
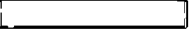
SPICER / DANA / EATON

02 CODES	6000# 02-ADA, 8000# 02-ADB, 02-ADV, 02-ADW		166027C91 101KK111	B	1.359 x 7.97	K102I	70.102.09	50.102.09	ST70-2	92.102.09	84.103.19
	8000# 02-AEM,	Before 10/2002	101KK111	B	1.359 x 7.97	K102I	70.102.09	50.102.09	ST70-2	92.102.09	84.103.19
	8000# 02-AEM, 02-AHA, 02-AGZ, 02-ADZ, 02-AGN	10/2002- Present	329182	C	1.359 x 7.97	K103S	70.103.19	50.103.19	ST70-2	93.103.19	84.103.19
	8000# 02-ATK		R201604	B	1.499 x 7.50	K80R	70.080.18	50.080.18	ST70-28		

PIN TYPE CHART:					
	C - SAME SIDE LOCK FLATS		G - STEP THREADED		A - SINGLE LOCK FLAT
	E - TAPERED THREADED		H - NO LOCK FLATS		B - DOUBLE LOCK FLAT
	F - TAPERED		J - SINGLE STEP		

1. STEMCO Kaiser Owik Kit® feature patented spiral steel bushings. 2. STEMCO Kaiser Plus Kit® feature pre-sized steel back bronze bushings. 3. Kit has composite bushings. 4. Modify spindles to receive end plates. 5. Bolt on cap. 6. Threaded cap. 7. Length of STEMCO Kaiser pin is 9 3/4". 8. STEMCO Kaiser pin is longer than OEM. 9. Torque Spec. for king pin nut is 230 ft/lbs. 10. Torque Spec. for king pin nut is 300 ft/lbs. 11. Torque Spec. for king pin nut is 406 ft/lbs. 12. Torque Spec. for king pin nut is 350/475 ft/lbs. 13. Includes end caps. 14. Torque Spec. for knuckle attachment bolts is 170-200 ft/lbs. 15. Kit uses special removal tool ST90-1.

Steering Knuckle King Pin Kits

SPICER / DANA / EATON

Model	Axle	Year	OEM No.	Pin Type	OEM Spec	Qwik Kit No. ¹	Plus Kit No. ²	Econo Kit No.	Lip Seal/ Bushings Driver Installation Tool	Axle Sleeve Used With APE	APE Cutter Kit Used
-------	------	------	---------	----------	----------	---------------------------	---------------------------	---------------	--	---------------------------------	------------------------

SPICER / DANA / EATON

02 CODES	10000# 02-ADC, 02-ADL		1668411C91	B	1.921 x 9.87	K120I [®]	70.120.09 [®] 70.120.99 ³ [®]	50.120.09 [®]	ST70-19	92.120.09	84.147.05
	12000# 02-ADD, 02-ADG, 02-ADN, 02-ADP	1989 to Date	1668411C91 120KK100	B	1.921 x 9.87	K120I [®]	70.120.09 [®] 70.120.99 ³ [®]	50.120.09 [®]	ST70-19	92.120.09	84.147.05
	02-AEA		806355	A	1.625 x 9.19	K120E	70.120.05	50.120.05	ST70-6	91.120.05	84.120.05
	12000# 02-AED, 02-AEG		816787, 823078, 328344, 328342	A	1.794 x 9.05	K122E	70.122.05 70.122.95 ¹	50.122.05	ST70-7	91.122.05	84.122.05
	12000# 02-AGA		328346, 328348	C	1.794 x 9.05	K123E	70.123.05	50.123.05	ST70-7		
	12000# 02-ARK, 02-ARL, 02-ASB, 02-ASD		2500542C91	B	1.794 x 8.87	K981R	70.981.18	50.981.18	ST70-7	92.961.12	84.122.05
	12000# 02-ARA, 02-ARV, 02-ARW, 02-ASX		1665531C91	B	1.794 x 10.40	K961L	70.961.12	50.961.12	ST70-7	92.961.12	84.122.05
	02-ARG			B	1.794 x 10.40	KG931R	77.931.18	57.931.18	ST70-7	92.931.18	84.122.05
	12000# 02-ASV, 02-ASW, 02-AUB, 02-AUC, 02-AUD		60961-009, 60961-039, 60961-040					50.121.08	ST70-32		
	14000# 02-ADE, 02-ADT, 02-AES, 02-AET, 02-AGL, 02-AGV	1990 to Date	140KK100 329022	B	2.046 x 10.12	K141S [®]	70.141.19 [®]	50.141.19 [®]	ST70-24		
	14600# 02-AEZ, 02-AGB, 02-AGC, 02-AGE		328347 328349	C	1.872 x 9.05	K147E	70.147.05	50.147.05	ST70-23	93.147.05	84.147.05
	16000# 02-ADH, 02-AEU, 02-AEV, 02-AEW, 18000# 02-ADJ, 20000# 02-ADK		220KK100 1685405C91	B	2.046 x 11.00	K160S	70.160.19	50.160.19	ST70-24		
	18000# 02-ARU		2505495C91	B	1.999 x 11.21	K180R	70.180.18	50.180.18	ST70-12	92.180.18	84.931.12
	18000# 02-ARZ, 02-ARY			B	1.999 x 11.21	K181R	70.181.18	50.181.18	ST70-12	92.931.12	84.931.12
D CODES	6000# D600, 7000# D700, 8500# D850		329182	C	1.359 x 7.97	K103S	70.103.19	50.103.19	ST70-2	93.103.19	84.103.19
	8000# D800	Before 10/2002	101KK111	B	1.359 x 7.97	K102I	70.102.09	50.102.09	ST70-2	92.102.09	84.103.19
	8000# D800F	10/2002- Present	329182	C	1.359 x 7.97	K103S	70.103.19	50.103.19	ST70-2	93.103.19	84.103.19
	20000# D2000F, 22000# D2200F		331434	B	2.046 x 10.07	K200S			ST70-24		
	20000# D2000F, 22000# D2200F		331435	C	2.046 x 10.07	K201S			ST70-24		
E CODES	10000# E1000I/W 12000# E1200I/W E1201I/W 13200# E1320I/W		823078 328344 328342	A	1.794 x 9.05	K122E	70.122.05 70.122.95 ¹	50.122.05 50.125.05 ¹	ST70-7	91.122.05	84.122.05
	12000# E1203I		328346 328348	C	1.794 x 9.05	K123E	70.123.05	50.123.05	ST70-7		

For all Qwik Kit[®] - BUSHING "T" HANDLE WRENCHES



Tool No.	Description
ST-100-1	Short "T" Handle Wrench
ST-100-2	Long "T" Handle Wrench
100M1-1	Replacement head
Above Wrenches will fit the bushings in most kits.	
The Following kits do not use wrenches: K80A, K120A, K120N, K150KG, K160A, K700T, K60U, 50.121.08	

Tool No.	Description
ST-100-3	Short "T" Handle Wrench
ST-100-4	Long "T" Handle Wrench
100M1-2	Replacement head
Above Wrenches will fit the bushings in the following kits:	
K50F, K71F, K72F, K80G, K110G, K120G, K122V, K146E, K147E, K180E, K68Z, K69Z	

Model	Axle	Year	OEM No.	Pin Type	OEM Spec	Owik Kit No. ¹	Plus Kit No. ²	Econo Kit No.	Lip Seal/ Bushing Driver Installation Tool	Axle Sleeve Used With APE	APE Cutter Kit Used
-------	------	------	---------	----------	----------	---------------------------	---------------------------	---------------	--	---------------------------	---------------------

SPICER / DANA / EATON

E CODES	14600# E1460I/W		824530 824920 328345 328343 329404 329405	A	1.872 x 9.05	K146E	70.146.05	50.146.05	ST70-23	91.146.05	84.147.05
	10000# E1002I/W 12000# E1202I/W 13200# E1322I/W 14600# E1462I/W		328347 328349	C	1.872 x 9.05	K147E	70.147.05	50.147.05	ST70-23	93.147.05	84.147.05
EFA CODES	12000# EFA12F3		806356 1005632	A	1.625 x 9.19	K121E	70.121.05	50.121.05	ST70-6		
	10000# EFA10F5 12000# EFA12F4 13200# EFA13F5		806355 815984 1008431	A	1.625 x 9.19	K120E	70.120.05	50.120.05	ST70-6	91.120.05	84.120.05
	18000# EFA18F3, EFA18F4 20000# EFA20F4 22000# EFA22T2, EFA22T5 24000# EFA24T2, EFA24T5		811525 1008500 329432 329433 329434	A	1.872 x 9.97	K180E	70.180.05	50.180.05	ST70-23	91.180.05	84.147.05
I CODES	5000# I-050		473695C91	A	1.359 x 7.97	K101I	70.101.09	50.101.09	ST70-2	91.101.09	84.103.19
	6000# I-060		473695C91	A	1.359 x 7.97	K101I	70.101.09	50.101.09	ST70-2	91.101.09	84.103.19
	6000# I-60S, I-60SG, I-61		166027C91 101KK111	B	1.359 x 7.97	K102I	70.102.09	50.102.09	ST70-2	92.102.09	84.103.19
	7500# I-075		473695C91	A	1.359 x 7.97	K101I	70.101.09	50.101.09	ST70-2	91.101.09	84.103.19
	8000# I-080		473695C91	A	1.359 x 7.97	K101I	70.101.09	50.101.09	ST70-2	91.101.09	84.103.19
	8000# I-80S I-80SG		166027C91 101KK111	B	1.359 x 7.97	K102I	70.102.09	50.102.09	ST70-2	92.102.09	84.103.19
	9000# I-090	Before Aug 1981	470752C91 483095C91	A	1.609 x 9.16	K309I	70.309.09	50.309.09	ST70-5		
	9000# I-090	After Aug 1981	586806C91	B	1.609 x 9.16	K310I	70.310.09	50.310.09	ST70-5		
	10000# I-100S, I-100SA, I-100SG		1668411C91	B	1.921 x 9.87	K120I ⁸	70.120.09 ⁸ 70.120.99 ^{3,8}	50.120.09 ⁸	ST70-19	92.120.09	84.147.05
	10800# I-108 All except code 02309		399942C93 1658934C91 586808C91	B	1.609 x 9.66	K140I	70.140.09	50.140.09	ST70-5	92.140.09	84.120.05
	10800# I-108 For code 02309		586806C91	B	1.609 x 9.16	K310I	70.310.09	50.310.09	ST70-5		
	12000# I-120 All except code 02309		399942C93 1658934C91 586808C91	B	1.609 x 9.66	K140I	70.140.09	50.140.09	ST70-5	92.140.09	84.120.05
	12000# I-120 For code 02309		586806C91	B	1.609 x 9.16	K310I	70.310.09	50.310.09	ST70-5		
	12000# I-120S I-120SG, I-120SGL	1989 to date	1668411C91 120KK100	B	1.921 x 9.87	K120I ⁸	70.120.09 ⁸ 70.120.99 ^{3,8}	50.120.09 ⁸	ST70-19	92.120.09	84.147.05
	13200# I-132		588808C91 1658394C91	B	1.609 x 9.66	K140I	70.140.09	50.140.09	ST70-5	92.140.09	84.120.05
	14000# I-140S I-140SG, I-140W I-132SG	1990 to date	140KK100 329022	B	2.046 x 10.12	K141S ⁸	70.141.19 ⁸	50.141.19 ⁸	ST70-24		

PIN TYPE CHART:		C - SAME SIDE LOCK FLATS		G - STEP THREADED	
	A - SINGLE LOCK FLAT		E - TAPERED THREADED		H - NO LOCK FLATS
	B - DOUBLE LOCK FLAT		F - TAPERED		J - SINGLE STEP

1. STEMCO Kaiser Owik Kit* feature patented spiral steel bushings. 2. STEMCO Kaiser Plus Kit* feature pre-sized steel back bronze bushings. 3. Kit has composite bushings. 4. Modify spindles to receive end plates. 5. Bolt on cap. 6. Threaded cap. 7. Length of STEMCO Kaiser pin is 9 3/4". 8. STEMCO Kaiser pin is longer than OEM. 9. Torque Spec. for king pin nut 230 ft/lbs. 10. Torque Spec. for king pin nut is 300 ft/lbs. 11. Torque Spec. for king pin nut is 406 ft/lbs. 12. Torque Spec. for king pin nut is 350/475 ft/lbs. 13. Includes end caps. 14. Torque Spec. for knuckle attachment bolts is 170-200 ft/lbs. 15. Kit uses special removal tool ST90-1.

Steering Knuckle King Pin Kits

SPICER / DANA / EATON,
STERLING, VOLVO,
WATSON & CHALIN

Model	Axle	Year	OEM No.	Pin Type	OEM Spec	Qwik Kit No. ¹	Plus Kit No. ²	Econo Kit No.	Lip Seal/ Bushing Driver Installation Tool	Axle Sleeve Used With APE	APE Cutter Kit Used
-------	------	------	---------	----------	----------	---------------------------	---------------------------	---------------	--	---------------------------	---------------------

SPICER / DANA / EATON

ICODES	14600# I-146S I-146SA		120KK102	B	1.860 x 10.75	K146S					
	16000# I-160S, I-160W 18000# I-180S, I-180W 20000# I-200S, I-200W 22000# I-220S, I-220W		220KK100 1685405C91 329023	B	2.046 x 11.00	K160S	70.160.19	50.160.19	ST70-24		
	16000# I-160S, I-160SB for MCI Buses only		161KK100	B	2.046 x 11.00	K161S			ST70-24		
	I-161		329116	B	1.794 x 11.00	K162S			ST70-7		

STERLING (See Rockwell / Meritor, Spicer / Dana / Eaton)

VOLVO

9000# FM9		85108338	E	2.360 x 8.92	K536M ¹⁵						
12000# FM12		85108338	E	2.360 x 8.92	K536M ¹⁵						
12000# FXL12		301SQ53	E	2.360 x 8.92	K536M ¹⁵						
14600# FXL14.6		301SQ53	E	2.360 x 8.92	K536M ¹⁵						
18000# FXL18		301SQ53	E	2.360 x 8.92	K536M ¹⁵						
20000# FXL20		301SQ53	E	2.360 x 8.92	K536M ¹⁵						
23000# FXL23		301SQ53	E	2.360 x 8.92	K536M ¹⁵						
10000# VF10 12000# VF12 12500# VF125 FAX5.5, FAX5.7		3130711 V3090267	E	1.777 x 8.62	K122V ⁹						
VF14, VF16, VF18		3090266	E	1.969 x 9.88	K140V						
		3093704	B	1.794 x 8.87	K981R	70.981.18	50.981.18	ST70-7	92.961.12	84.122.05	
		V1112810	A	1.625 x 9.19	K120E	70.120.05	50.120.05	ST70-6	91.120.05	84.120.05	
		85106184	A	1.794 x 9.05	K122E	70.122.05	50.122.05	ST70-7	91.122.05	84.122.05	

WATSON & CHALIN

SL8K w/ MERITOR AXLE		SRK103	B	1.500 x 8.93	K941R	70.941.18	50.941.18	ST70-28			
SL8K w/ WESTPORT AXLE		SRK115	B	1.500 x 8.93	K81W			ST70-28			
1100 Series w/ MERITOR AXLE		SRK102	B	1.794 x 10.40	K961L	70.961.12	50.961.12	ST70-7	91.961.12	84.122.05	
1100 Series w/ WESTPORT AXLE		SRK98 SRK112	B	1.794 x 10.40	K130W			ST70-7	91.961.12	84.122.05	
SL2089, SL2090, SLTL2095, STL2096 w/ MERITOR AXLE		SRK105	B	1.999 x 11.21	KH931L	78.931.12	58.931.12	ST70-12	92.931.12	84.931.12	
SL2089, SL2090, SLTL2095, STL2096 w/ WESTPORT AXLE		SRK120	B	1.999 x 11.21	K181R	70.181.18	50.181.18	ST70-12	92.931.12	84.931.12	

For all Qwik Kit® - BUSHING "T" HANDLE WRENCHES



Tool No.	Description
ST-100-1	Short "T" Handle Wrench
ST-100-2	Long "T" Handle Wrench
100M1-1	Replacement head
Above Wrenches will fit the bushings in most kits.	
The Following kits do not use wrenches: K80A, K120A, K120N, K150KG, K160A, K700T, K60U, 50.121.08	

Tool No.	Description
ST-100-3	Short "T" Handle Wrench
ST-100-4	Long "T" Handle Wrench
100M1-2	Replacement head
Above Wrenches will fit the bushings in the following kits: K50F, K71F, K72F, K80G, K110G, K120G, K122V, K146E, K147E, K180E, K68Z, K69Z	







Model	Axle	Year	OEM No.	Pin Type	OEM Spec	Owik Kit No. ¹	Plus Kit No. ²	Econo Kit No.	Lip Seal/ Bushing Driver Installation Tool	Axle Sleeve Used With APE	APE Cutter Kit Used
-------	------	------	---------	----------	----------	---------------------------	---------------------------	---------------	--	---------------------------	---------------------

WHITE / WESTPORT

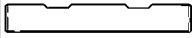
Trend Models	7000#	1966-1967		B	1.234 x 7.43	K70D	70.070.04	50.070.04	ST70-10		
	F4W-0800		143698-0040	B	1.300 x 7.75	K72F	70.072.06	50.072.06	ST70-17		
	F3W-1200 F5W-1200 F6W-1200 (12000#)	1952-1975	216446	A	1.810 x 10.78	K120W					
	F3W-1300, F3W-1400, F3W-1600, F6W-1300, F6W-1400, F6W-1600		143698-0052	A	1.810 x 10.56	K127W	70.127.23	50.127.23	ST70-33	91.127.23	84.122.05
	F3W-125 (12000#)	1975 to date	143698-0001	A	1.810 x 10.56	K125W	70.125.23	50.125.23	ST70-33		
	F3W-140, F5W-140, F6W-140 (14000#)	1966-1975	216446	A	1.810 x 10.78	K120W					
	F3W, F6W, 1200 Series	1975 to date	37090-5005 143698-0051	A	1.810 x 10.56	K126W	70.126.23	50.126.23	ST70-33	91.127.23	84.122.05
	F3W, F6W 1400 Series	1975 to date	217175 143698-0001	A	1.810 x 10.56	K125W	70.125.23	50.125.23	ST70-33		
	F0W-1800, F3W-2000, F2W-2000D		143698-0018	B	1.999 x 11.21	K181R	70.181.18	50.181.18	ST70-12	92.931.12	84.931.12
	9000# (FD-901)	1960-1967	138, 142, 154	B	1.434 x 8.50	KD901R	74.901.18	54.901.18	ST70-9		
	12000# (FE-900)	1955-1965	857328	E	1.609 x 9.75	K125G¹²	70.125.07 ¹²	50.125.07 ¹²	ST70-5		
	16000# (FH-901)	1965-1975	168, 170	B	1.999 x 11.04	KH901L	78.901.12	58.901.12	ST70-9		
	18000# (FL-901)	1965-1975	1720728 1739844	B	1.999 x 11.04	KH901L	78.901.12	58.901.12	ST70-12		
	Westport Axle	WS1637090-4405		143698-0051	A	1.811 x 10.56	K126W	70.126.23	50.126.23	ST70-33	91.127.23
F5W0900			143698-0053	B	1.606 x 9.08	K96F	70.096.06	50.096.06	ST70-13		

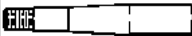
WORKHORSE

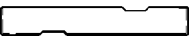
			8006372	A	1.179 x 6.36	K58G	70.058.07		ST70-4		
			8803050	A	1.179 x 6.36	K56G	70.056.07	50.056.07	ST70-4	91.056.07	84.056.07
			8003056	A	1.179 x 7.31	K50W			ST70-4	91.050.23	84.056.07

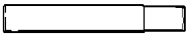
PIN TYPE CHART:					
	C - SAME SIDE LOCK FLATS		G - STEP THREADED		
	A - SINGLE LOCK FLAT		E - TAPERED THREADED		H - NO LOCK FLATS
	B - DOUBLE LOCK FLAT		F - TAPERED		J - SINGLE STEP

1. STEMCO Kaiser Owik Kit® feature patented spiral steel bushings. 2. STEMCO Kaiser Plus Kit® feature pre-sized steel back bronze bushings. 3. Kit has composite bushings. 4. Modify spindles to receive end plates. 5. Bolt on cap. 6. Threaded cap. 7. Length of STEMCO Kaiser pin is 9 3/4". 8. STEMCO Kaiser pin is longer than OEM. 9. Torque Spec. for king pin nut 230 ft/lbs. 10. Torque Spec. for king pin nut is 300 ft/lbs. 11. Torque Spec. for king pin nut is 406 ft/lbs. 12. Torque Spec. for king pin nut is 350/475 ft/lbs. 13. Includes end caps. 14. Torque Spec. for knuckle attachment bolts is 170-200 ft/lbs. 15. Kit uses special removal tool ST90-1.

Bus Steering Knuckle King Pin Kits

BLUEBIRD,
FORD, GILLIG,
GMC COACH

Model	Axle	Year	OEM No.	Pin Type	OEM Spec	Qwik Kit No. ¹	Plus Kit No. ²	Econo Kit No.	Lip Seal/ Bushing Driver Installation Tool	Axle Sleeve Used With APE	APE Cutter Kit Used
-------	------	------	---------	----------	----------	---------------------------	---------------------------	---------------	--	---------------------------	---------------------

BLUEBIRD

All American	Airtek Softek 649505-0004		00063311 LT SIDE 00063312 RT SIDE 00063313 BT SIDES					50.121.08	ST70-32		
	12000# FF-942			B	1.794 x 10.40	K931L	70.931.12	50.931.12	ST70-7	92.961.12	84.122.05
	12000# I-120S, I-120SG, I-120SGL		8305203	B	1.921 x 9.87	K120 ⁸	70.120.09 ⁸ 70.120.99 ^{3,8}	50.120.09 ⁸	ST70-19	92.120.09	84.147.05
TC2000	12000# I-120SA, I-120IS, I-126SA, I-126IS 14600# I-146SA	1990-	4294716	B	1.859 x 10.75	K146S					
TC2000	14000# I-140S I-140SG, I-146		8305211	B	2.046 x 10.12	K141S ⁹	70.141.19 ⁸	50.141.19 ⁸	ST70-24		
	10,800#	1988-1989	2156784 4293270	B	1.609 x 9.66	K140I	70.140.09	50.140.09	ST70-5	92.140.09	84.120.05
Rockwell Axles	12,000-13,200# FF-934, FF-942, FF-944		195, 1307	B	1.794 x 10.40	K931L	70.931.12	50.931.12	ST70-7	92.961.12	84.122.05
Uses Lock Pin Sizes 3.68 & 3.25	13,200# FF-961, FF-967		1315 4280855	B	1.794 x 10.40	K961L	70.961.12	50.961.12	ST70-7	92.961.12	84.122.05
	14,600# FG-941, FG-943		1309 1310	B	1.794 x 10.40	KG931R	77.931.18	57.931.18	ST70-7	92.931.18	84.122.05

FORD

	7000# Hyd. Brakes	1967-1988	C7TZ-3111A	A	1.231 x 8.90	K70F ⁴	70.073.06	50.073.06	ST70-3		
	7000-9000# Air Brakes	1975-1988	D6TZ-3111A	B	1.433 x 8.25	K75F ⁵	70.075.06 ⁵	50.075.06 ⁵	ST70-9		
	7000-9000# Air Brakes	1989-	E9HZ-3111C	B	1.433 x 8.25	K76F ⁶	70.076.06 ⁶	50.076.06 ⁶	ST70-9		
	9000# Hyd. Brakes	1960-1983	D1HZ-3111A C2TZ-3111G	B	1.434 x 8.50	KD901R	74.901.18	54.901.18	ST70-9		
	9000# Air Brakes	1975-1988	D6HZ-3111B	B	1.606 x 9.07	K95F ⁵	70.095.06 ⁵	50.095.06 ⁵	ST70-13		
	9000# Air Brakes	1989-	E9HZ-3111B	B	1.606 x 9.07	K96F ⁶	70.096.06 ⁶	50.096.06 ⁶	ST70-9		

GILLIG

	14600#FG-931		1309, 1310 1319, 1471	B	1.794 x 10.40	KG931R	77.931.18	57.931.18	ST70-7	92.931.18	84.122.05
	16000# FH-946		1420, 1424	B	1.794 x 9.19	KH946R	78.946.18	58.946.18	ST70-7	92.946.18	84.122.05

GMC COACH

Transit Coach	7000#		2470621	B	1.234 x 7.43	K70D	70.070.04	50.070.04	ST70-10		
	12000#		2362900 2237497	E	1.609 x 9.75	K125G ¹²	70.125.0712	50.125.07 ¹²	ST70-5		
	15000# 16000#		2254366 IC-2-40	E	1.794 x 10.68	K170G ¹²					

For all Qwik Kit® - BUSHING "T" HANDLE WRENCHES



Tool No.	Description
ST-100-1	Short "T" Handle Wrench
ST-100-2	Long "T" Handle Wrench
100M1-1	Replacement head
Above Wrenches will fit the bushings in most kits.	
The Following kits do not use wrenches: K80A, K120A, K120N, K150KG, K160A, K700T, K60U, 50.121.08	

Tool No.	Description
ST-100-3	Short "T" Handle Wrench
ST-100-4	Long "T" Handle Wrench
100M1-2	Replacement head
Above Wrenches will fit the bushings in the following kits:	
K50F, K71F, K72F, K80G, K110G, K120G, K122V, K146E, K147E, K180E, K68Z, K69Z	

Model	Axle	Year	OEM No.	Pin Type	OEM Spec	Owik Kit No. ¹	Plus Kit No. ²	Econo Kit No.	Lip Seal/ Bushing Driver Installation Tool	Axle Sleeve Used With APE	APE Cutter Kit Used
-------	------	------	---------	----------	----------	---------------------------	---------------------------	---------------	---	---------------------------------	------------------------

INTERNATIONAL / NAVISTAR

	6000#, I-60S (02-ADA)		1660271C92	B	1.359 x 7.97	K102I	70.102.09	50.102.09	ST70-2	92.102.09	84.103.19
	8000#, I-80S (02-ADB)		1660271C92	B	1.359 x 7.97	K102I	70.102.09	50.102.09	ST70-2	92.102.09	84.103.19
	10,000#, I-100S (02-ADC) 12,000#, I-120S (02-ADD)			B	1.921 x 9.87	K120I ⁸	70.120.09 ⁸ 70.120.99 ^{3, 8}	50.120.09 ⁸	ST70-19	92.120.09	84.147.05
	14,000#, I-140S (02-ADE) (02-AGV)		1668412C91	B	2.046 x 10.12	K141S ⁸	70.141.19 ⁸	50.141.19 ⁸	ST70-24		

MAN

	V8-65C-02	1993	81-44205-6013 6313078	J	1.969 x 8.77	K120N			ST70-27		
--	-----------	------	--------------------------	---	--------------	-------	--	--	---------	--	--

MCI

MC-7, MC-8, MC-9	15000# 16000#		2254366 IC-2-40	E	1.794 x 10.68	K170G ¹²					
MC-7, MC-8, MC-9	13200# FF-941, FF-961			B	1.794 x 10.40	K961L	70.961.12	50.961.12	ST70-7	92.961.12	84.122.05
MC-12	14600# FG-931		IJ-2-54	B	1.794 x 10.40	KG931R	77.931.18	57.931.18	ST70-7	92.931.18	84.122.05
102DL3	16000# 20000# FH-946		01-01-1017 01-01-1079	B	1.794 x 9.19	KH946R	78.946.18	58.946.18	ST70-7	92.946.18	84.122.05
G Coach	16000# I-160S			B	2.046 x 11.00	K161S			ST70-24		

NEO PLAN







	I-161		329116	B	1.794 x 11.00	K162S			ST70-7		
--	-------	--	--------	---	---------------	-------	--	--	--------	--	--

NEW FLYER

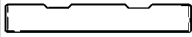
	MAN		6313078	J	1.969 x 8.77	K120N					
--	-----	--	---------	---	--------------	-------	--	--	--	--	--

ROCKWELL / MERITOR

	14,600# 17100, 17101, 17111, 17801		R201309 R201310 R201319 R201471	B	1.794 x 10.40	KG931R	77.931.18	57.931.18	ST70-7	92.931.18	84.122.05
	8000# MFS-08		R201474	B	1.500 x 7.50	K80R	70.080.18	50.080.18	ST70-28		
	12000# FF-931, FF-932, FF-933, FF-934		R200195 R201307	B	1.794 x 10.40	K931L	70.931.12	50.931.12	ST70-7	92.961.12	84.122.05
1-599 SERIES	13200# FF-941, FF-942, FF-943, FF-944, FF-945		R200195 R201307	B	1.794 x 10.40	K931L	70.931.12	50.931.12	ST70-7	92.961.12	84.122.05
600 SERIES	13200# FF-941, FF-942, FF-943, FF-944, FF-945		R201315 R201470	B	1.794 x 10.40	K961L	70.961.12	50.961.12	ST70-7	92.961.12	84.122.05
	13200# FF-961, FF-962, FF-966, FF-967, FC-965		R201315 R201470	B	1.794 x 10.40	K961L	70.961.12	50.961.12	ST70-7	92.961.12	84.122.05

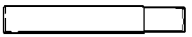
PIN TYPE CHART:					
	C - SAME SIDE LOCK FLATS		G - STEP THREADED		
	A - SINGLE LOCK FLAT		E - TAPERED THREADED		H - NO LOCK FLATS
	B - DOUBLE LOCK FLAT		F - TAPERED		J - SINGLE STEP

1. STEMCO Kaiser Owik Kit® feature patented spiral steel bushings. 2. STEMCO Kaiser Plus Kit® feature pre-sized steel back bronze bushings. 3. Kit has composite bushings. 4. Modify spindles to receive end plates. 5. Bolt on cap. 6. Threaded cap. 7. Length of STEMCO Kaiser pin is 9 3/4". 8. STEMCO Kaiser pin is longer than OEM. 9. Torque Spec. for king pin nut 230 ft/lbs. 10. Torque Spec. for king pin nut is 300 ft/lbs. 11. Torque Spec. for king pin nut is 406 ft/lbs. 12. Torque Spec. for king pin nut is 350/475 ft/lbs. 13. Includes end caps. 14. Torque Spec. for knuckle attachment bolts is 170-200 ft/lbs. 15. Kit uses special removal tool ST90-1.

Bus Steering Knuckle King Pin Kits

ROCKWELL / MERITOR,
THOMAS

Model	Axle	Year	OEM No.	Pin Type	OEM Spec	Qwik Kit No. ¹	Plus Kit No. ²	Econo Kit No.	Lip Seal/ Bushing Driver Installation Tool	Axle Sleeve Used With APE	APE Cutter Kit Used
-------	------	------	---------	----------	----------	---------------------------	---------------------------	---------------	--	---------------------------	---------------------

ROCKWELL / MERITOR

	14600#, FG-931 FG-933, FG-941, FG-943, FG-952		R201309 R201310 R201319 R201471	B	1.794 x 10.40	KG931R	77.931.18	57.931.18	ST70-7	92.931.18	84.122.05
	16000# FH-941, 20000# FH-945, FH-946		R201420 R201424	B	1.794 x 9.19	KH946R	78.946.18	58.946.18	ST70-7	92.946.18	84.122.05
	18000# FL-931, FL-933, FL-941, FL-943, FL-951		R200198 R201312	B	1.999 x 11.21	KH931L	78.931.12	58.931.12	ST70-12	92.931.12	84.931.12

THOMAS

ER-Series School Bus Chassis; Rear Engine			8314171	B	1.359 x 7.97	K102I	70.102.09	50.102.09	ST70-2	92.102.09	84.103.19
	13,200# FF-932		1307	B	1.794 x 10.40	K931L	70.931.12	50.931.12	ST70-7	92.961.12	84.122.05
	14,600# FG-941, FG-944		1309 1310	B	1.794 x 10.40	KG931R	77.931.18	57.931.18	ST70-7	92.931.18	84.122.05
	AF-10.0-3, AF-12.0-3, AF-13.0-3, AF-13.3-3, AF-14.7-3		P6073300019KZ P6073300119KZ	B	1.771 x 9.23	K120A			ST70-30		

For all Qwik Kit® - BUSHING "T" HANDLE WRENCHES



Tool No.	Description
ST-100-1	Short "T" Handle Wrench
ST-100-2	Long "T" Handle Wrench
100M1-1	Replacement head
Above Wrenches will fit the bushings in most kits.	
The Following kits do not use wrenches: K80A, K120A, K120N, K150KG, K160A, K700T, K60U, 50.121.08	

Tool No.	Description
ST-100-3	Short "T" Handle Wrench
ST-100-4	Long "T" Handle Wrench
100M1-2	Replacement head
Above Wrenches will fit the bushings in the following kits:	
K50F, K71F, K72F, K80G, K110G, K120G, K122V, K146E, K147E, K180E, K68Z, K69Z	

King Pin Dimensions Interchanges

Dia.	Length	Type	Make	Qwik Kit	Plus kit	Econo Kit
1.054	6.690	A	FORD	KE350F	75.350.06	55.350.06
1.101	7.100	A	MITSUBISHI	K60U	NA	NA
1.109	6.340	A	CHEVY	K51G	70.051.07	50.051.07
1.179	6.360	A	CHEVY	K55G	70.055.07	50.055.07
1.179	6.360	A	CHEVY	K56G	70.056.07	50.056.07
1.179	6.360	A	WORKHORSE	K58G	70.058.07	NA
1.179	7.310	A	WORKHORSE	K50W	NA	NA
1.181	7.380	A	ISUZU	K68Z	70.068.26	NA
1.181	7.380	A	ISUZU	K69Z	70.069.26	NA
1.230	8.906	A	FORD	K70F	70.073.06	50.073.06
1.231	7.859	A	FORD	K50F	70.053.06	50.053.06
1.234	6.780	A	MERITOR	K60R	NA	NA
1.234	7.437	B	DODGE	K70D	70.070.04	50.070.04
1.234	7.660	A	IH	K98I	70.098.09	50.098.09
1.249	7.875	A	CHEVY	K70G	70.070.07	50.070.07
1.300	7.270	A	FORD	K71F	70.071.06	50.071.06
1.300	7.750	B	FORD	K72F	70.072.06	50.072.06
1.359	7.970	C	DANA	K103S	70.103.19	50.103.19
1.359	7.970	A	IH	K101I	70.101.09	50.101.09
1.359	7.970	B	IH	K102I	70.102.09	50.102.09
1.377	7.000	A	MACK	K75M	NA	NA
1.430	8.250	B	FORD	K75F	70.075.06	50.075.06
1.430	8.250	B	FORD	K76F	70.076.06	50.076.06
1.433	8.500	B	ROCKWELL	KD901R	74.901.18	54.901.18
1.434	8.750	E	CHEVY	K95G	70.095.07	50.095.07
1.434	9.410	E	ROCKWELL	KD900R	NA	NA
1.484	8.850	A	IH	K108I	NA	NA
1.484	8.850	B	IH	K109I	NA	NA
1.500	7.150	B	MERITOR	K70R	70.070.18	50.070.18
1.500	7.400	F	MACK	K535M	NA	NA
1.500	7.500	B	ROCKWELL	K80R	70.080.18	50.080.18
1.500	8.930	B	ROCKWELL	K941R	70.941.18	50.941.18
1.606	8.812	B	ROCKWELL	K970R	70.970.18	50.970.18
1.606	9.080	B	FORD	K95F	70.095.06	50.095.06
1.606	9.080	B	FORD	K96F	70.096.06	50.096.06
1.609	9.160	A	IH	K309I	70.309.09	50.309.09
1.609	9.160	B	IH	K310I	70.310.09	50.310.09
1.609	9.380	B	ROCKWELL	K971R	70.971.18	50.971.18
1.609	9.660	A	IH	K139I	70.139.09	50.139.09
1.609	9.660	B	IH	K140I	70.140.09	50.140.09
1.609	9.750	E	CHEVY	K125G	70.125.07	50.125.07
1.614	8.000	G	CHEVY	K80G	NA	NA
1.625	7.468	F	MACK	K533M	70.533.13	50.533.13
1.625	9.190	A	EATON	K120E	70.120.05	50.120.05
1.625	9.190	A	EATON	K121E	70.121.05	50.121.05
1.745	9.380	B	CHEVY	K121G	70.121.07	50.121.07
1.771	8.060	B	ALLIANCE	K80A	NA	NA
1.771	9.230	B	ALLIANCE	K120A	NA	NA
1.777	8.620	E	VOLVO	K122V	NA	NA

Dia.	Length	Type	Make	Qwik Kit	Plus kit	Econo Kit
1.794	8.870	B	ROCKWELL	K981R	70.981.18	50.981.18
1.794	9.050	A	EATON	K122E	70.122.05	50.122.05
1.794	9.050	A	LINK	K123K	NA	NA
1.794	9.050	A	LINK	K132K	NA	NA
1.794	9.180	B	ROCKWELL	K901L	70.901.12	50.901.12
1.794	9.190	B	ROCKWELL	KH946R	78.946.18	58.946.18
1.794	9.050	C	DANA	K123E	70.123.05	50.123.05
1.794	10.070	B	FORD	K941F	70.941.06	50.941.06
1.794	10.070	B	FORD	K942F	70.942.06	50.942.06
1.794	10.392	B	ROCKWELL	K120R	70.120.18	50.120.18
1.794	10.400	B	ROCKWELL	K931L	70.931.12	50.931.12
1.794	10.400	B	ROCKWELL	K961L	70.961.12	50.961.12
1.794	10.400	B	ROCKWELL	KG931R	77.931.18	57.931.18
1.794	10.390	B	ROCKWELL	K921L	70.921.12	50.921.12
1.794	10.687	E	GMC COACH	K170G	NA	NA
1.794	11.000	B	NEOPLAN	K162S	NA	NA
1.810	9.540	H	HENDRICKSON	K120H	NA	NA
1.810	9.540	A	HENDRICKSON	K131H	NA	NA
1.810	10.530	B	FORD	K146F	NA	NA
1.810	10.560	A	WESTPORT	K125W	70.125.23	70.125.23
1.810	10.560	A	WESTPORT	K126W	70.126.23	50.126.13
1.810	10.560	A	WESTPORT	K127W	70.127.23	50.127.23
1.810	10.781	A	WESTPORT	K120W	NA	NA
1.860	10.750	B	SPICER	K146S	NA	NA
1.872	9.050	C	DANA	K147E	70.147.05	70.147.05
1.872	9.050	A	EATON	K146E	70.146.05	50.146.05
1.872	9.970	A	EATON	K180E	70.180.05	50.180.05
1.889	9.200	G	CHEVY	K110G	NA	NA
1.889	9.620	G	CHEVY	K120G	NA	NA
1.921	9.875	B	IH	K120I	70.120.09	50.120.09
1.921	10.625	B	IH	K120I	70.120.09	50.120.09
1.969	8.770	J	MAN	K120N	NA	NA
1.969	9.880	E	VOLVO	K140V	NA	NA
1.999	11.040	B	ROCKWELL	KH901L	78.901.12	58.901.12
1.999	11.212	B	ROCKWELL	K180R	70.180.18	50.180.19
1.999	11.212	B	ROCKWELL	K181R	70.181.18	50.181.18
1.999	11.212	B	FORD	KH931F	78.931.06	58.931.06
1.999	11.212	B	ROCKWELL	KH931L	78.931.12	58.931.12
1.999	11.320	A	KGI	K150KG	NA	NA
2.046	10.070	B	DANA	K200S	NA	NA
2.046	10.070	C	DANA	K201S	NA	NA
2.046	10.120	B	IH / SPICER	K141S	70.141.19	50.141.19
2.046	11.000	B	DANA	K161S	NA	NA
2.046	11.000	B	SPICER	K160S	70.160.19	50.160.19
2.125	8.750	F	MACK	K616M	70.616.13	50.616.13
2.125	9.750	B	ALLIANCE	K160A	NA	NA
2.248	11.300	B	IMT / INGERSOLL	K700T	70.700.20	NA
2.249	10.600	A	KGI	K230KG	70.230.07	NA
2.441	8.920	E	MACK	K536M	NA	NA

PIN TYPE CHART:					
	C - SAME SIDE LOCK FLATS		G - STEP THREADED		H - NO LOCK FLATS
	A - SINGLE LOCK FLAT		E - TAPERED THREADED		J - SINGLE STEP
	B - DOUBLE LOCK FLAT		F - TAPERED		

1. STEMCO Kaiser Qwik Kit® feature patented spiral steel bushings. 2. STEMCO Kaiser Plus Kit® feature pre-sized steel back bronze bushings. 3. Kit has composite bushings. 4. Modify spindles to receive end plates. 5. Bolt on cap. 6. Threaded cap. 7. Length of STEMCO Kaiser pin is 9 3/4". 8. STEMCO Kaiser pin is longer than OEM. 9. Torque Spec. for king pin nut 230 ft/lbs. 10. Torque Spec. for king pin nut is 300 ft/lbs. 11. Torque Spec. for king pin nut is 406 ft/lbs. 12. Torque Spec. for king pin nut is 350/475 ft/lbs. 13. Includes end caps. 14. Torque Spec. for knuckle attachment bolts is 170-200 ft/lbs. 15. Kit uses special removal tool ST90-1.

King Pin Support Information and Products

SPINDLE BORE and AXLE BORE SIZES

KAISER DESIGN	SPINDLE BORE SIZE	AXLE BORE SIZES	KAISER DESIGN	SPINDLE BORE SIZE	AXLE BORE SIZES	KAISER DESIGN	SPINDLE BORE SIZE	AXLE BORE SIZES
K101I	1.483/1.485	1.358/1.360	K149E	2.057/2.058	1.873/1.875	K71D	1.358/1.360	1.235/1.237
K102I	1.483/1.485	1.358/1.360	K150KG	2.373/2.374	2.000/2.002	K71F	1.460/1.462	1.301/1.303
K103S	1.483/1.485	1.358/1.360	K160A	2.440/2.442	2.126/2.128	K72F	1.454/1.456	1.301/1.303
K108I	1.608/1.610	1.485/1.487	K160S	2.171/2.173	2.047/2.048	K75F	1.560/1.562	1.433/1.435
K109I	1.608/1.610	1.485/1.487	K161S	2.171/2.173	2.047/2.048	K75M	1.652/1.654	1.378/1.380
K110G	2.047/2.049	1.891/1.893	K162S	1.919/1.921	1.794/1.796	K76F	1.560/1.562	1.433/1.435
K120A	2.045/2.047	1.772/1.774	K170G	1.919/1.921	Tapered	K80A	2.045/2.047	1.772/1.774
K120E	1.749/1.750	1.626/1.627	K180E	2.057/2.058	1.873/1.875	K80G	1.771/1.773	1.615/1.617
K120G	2.047/2.049	1.891/1.893	K180R	2.124/2.126	2.000/2.002	K80R	1.626/1.628	1.501/1.503
K120H	1.937/1.939		K181R	2.124/2.126	2.000/2.002	K901L	1.919/1.921	1.795/1.797
K120I	2.045/2.047	1.922/1.923	K200S	2.171/2.172	2.047/2.048	K921L	1.919/1.921	1.795/1.797
K120N	2.283/2.284	1.967/1.968	K201S	2.171/2.172	2.047/2.048	K931L	1.919/1.921	1.795/1.797
K120R	1.919/1.921	1.795/1.797	K230KG	2.624/2.626	2.250/2.252	K941F	1.919/1.921	1.795/1.797
K120W	1.937/1.939	1.811/1.812	K309I	1.733/1.735	1.610/1.612	K941FA	1.919/1.921	1.795/1.797
K121E	1.749/1.750	1.626/1.627	K310I	1.733/1.735	1.610/1.612	K941R	1.626/1.628	1.501/1.503
K121G	1.876/1.878	1.745/1.747	K50F	1.375/1.377	1.232/1.234	K942F	1.919/1.921	1.795/1.797
K122E	1.919/1.921	1.794/1.796	K50W	1.314/1.316	1.180/1.182	K942FA	1.919/1.921	1.795/1.797
K122V	1.969/1.971	Tapered	K51G	1.229/1.231	1.110/1.112	K95F	1.733/1.735	1.607/1.609
K123E	1.919/1.921	1.794/1.796	K533M	1.749/1.751	Tapered	K95G	1.560/1.562	Tapered
K123K	1.919/1.921	1.794/1.796	K535M	1.624/1.626	Tapered	K961L	1.919/1.921	1.795/1.797
K125G	1.733/1.735	Tapered	K536M	2.559/2.561	Tapered	K96F	1.733/1.735	1.607/1.609
K125W	1.937/1.939	1.811/1.812	K55G	1.298/1.300	1.180/1.182	K970R	1.733/1.735	1.608/1.610
K126W	1.936/1.938	1.811/1.812	K56G	1.314/1.316	1.180/1.182	K971R	1.733/1.735	1.608/1.610
K127W	1.936/1.938	1.811/1.812	K58G	1.314/1.316	1.180/1.182	K981R	1.920/1.921	1.795/1.797
K131H	1.937/1.939	1.811/1.812	K60R	1.358/1.360	1.235/1.237	K98I	1.358/1.360	1.235/1.237
K132K	1.919/1.921	1.794/1.796	K60U	1.337/1.339	1.102/1.104	KD900R	1.560/1.562	Tapered
K139I	1.733/1.735	1.610/1.612	K616M	2.499/2.501	Tapered	KD901R	1.560/1.562	1.434/1.436
K140I	1.733/1.735	1.610/1.612	K68Z	1.338/1.340	1.182/1.184	KE350F	1.179/1.181	1.055/1.057
K140V	2.164/2.166	TAPERED	K69Z	1.338/1.340	1.182/1.184	KG931R	1.919/1.921	1.795/1.797
K141S	2.171/2.173	2.047/2.048	K700T	2.499/2.501	2.250/2.252	KH901L	2.124/2.126	2.000/2.002
K146E	2.057/2.058	1.873/1.875	K70D	1.358/1.360	1.235/1.237	KH931F	2.124/2.126	2.000/2.002
K146F	1.936/1.938	1.811/1.812	K70F	1.355/1.357	1.232/1.234	KH931L	2.124/2.126	2.000/2.002
K146S	1.994/1.996	1.862/1.864	K70G	1.368/1.370	1.250/1.252	KH946R	1.919/1.921	1.795/1.797
K147E	2.057/2.058	1.873/1.875	K70R	1.626/1.628	1.501/1.503	50.121.08	1.937/1.939	

Qwik Kit® - BUSHING "T" HANDLE WRENCHES

Tool No.	Description	Tool No.	Description
ST-100-1	Short "T" Handle Wrench	ST-100-3	Short "T" Handle Wrench
ST-100-2	Long "T" Handle Wrench	ST-100-4	Long "T" Handle Wrench
100M1-1	Replacement head	100M1-2	Replacement head

Above Wrenches will fit the bushings in most kits.
The Following kits do not use wrenches: K80A, K120A, K120N, K150KG, K160A, K700T, K60U, 50.121.08

Above Wrenches will fit the bushings in the following kits:
K50F, K71F, K72F, K80G, K110G, K120G, K122V, K146E, K147E, K180E, K68Z, K69Z

"No Go" Gauge

"No Go" Gauge Kit -
STK80-1
Contains
ST81-1, ST81-2, ST81-3, ST81-4, ST81-5, ST81-6

"No Go" Gauge tools

NO-GO	Qwik Kit	Plus Kit	NO-GO	Qwik Kit	Plus Kit
ST81-1	K981R*	70.981.18	ST81-2	K56G	70.056.07
ST81-1	K122E*	70.122.05	ST81-2	K58G	70.058.07
ST81-1	K123K	NA	ST81-2	K50W	NA
ST81-1	K132K	NA	ST81-3	K103S	70.103.19
ST81-1	K901L	70.901.12	ST81-3	K101I	70.101.09
ST81-1	KH946R*	78.946.18	ST81-3	K102I	70.102.09
ST81-1	K123E*	70.123.05	ST81-4	K120E	70.120.05
ST81-1	K941F	70.941.06	ST81-4	K121E	70.121.05
ST81-1	K942F	70.942.06	ST81-5	K147E	70.147.05
ST81-1	K120R	70.120.18	ST81-5	K146E	70.146.05
ST81-1	K931L*	70.931.12	ST81-5	K180E	70.180.05
ST81-1	K961L*	70.961.12	ST81-6	KH901L	78.901.12
ST81-1	KG931R	77.931.18	ST81-6	K180R	70.180.18
ST81-1	K921L	70.921.12	ST81-6	K181R	70.181.18
ST81-1	K162S	NA	ST81-6	KH931L	78.931.12
ST81-2	K55G	70.055.07	ST81-6	K150KG	NA

Plus Kit® King Pin Bushing Drivers

PLUS KIT No.	DRIVER No.	PLUS KIT No.	DRIVER No.	PLUS KIT No.	DRIVER No.
70.075.06	ST70-9	70.125.07	ST70-5	70.901.12	ST70-7
70.076.06	ST70-9	70.125.23	ST70-33	70.700.20	ST70-29
70.080.18	ST70-28	70.126.23	ST70-33	70.921.12	ST70-7
70.095.06	ST70-13	70.127.23	ST70-33	70.931.12	ST70-7
70.095.07	ST70-9	70.139.09	ST70-5	70.941.06	ST70-7
70.051.07	ST70-14	70.140.09	ST70-5	70.941.18	ST70-28
70.053.06	ST70-3	70.141.19	ST70-24	70.942.06	ST70-7
70.055.07	ST70-4	70.146.05	ST70-23	70.961.12	ST70-7
70.056.07	ST70-4	70.147.05	ST70-23	70.970.18	ST70-13
70.058.07	ST70-4	70.160.19	ST70-24	70.971.18	ST70-13
70.068.26	ST70-37	70.180.05	ST70-23	74.901.18	ST70-9
70.069.26	ST70-37	70.180.18	ST70-12	74.931.18	ST70-13
70.070.07	ST70-1	70.181.18	ST70-12	75.350.06	ST70-15
70.070.18	ST70-28	70.230.07	ST70-29	77.931.18	ST70-7
70.071.04	ST70-10	70.121.07	ST70-11	78.901.12	ST70-12
70.071.06	ST70-17	70.122.05	ST70-7	78.931.06	ST70-12
70.072.06	ST70-17	70.122.95	ST70-7	78.931.12	ST70-12
70.073.06	ST70-3	70.123.05	ST70-7	78.946.18	ST70-7

Part Numbers Below Require Special Bushing Driver



Kit No.	Tool No.	Kit No.	Tool No.
K75M	ST70-25	K160A	ST70-31
K80A	ST70-30	K700T	ST70-29
K120A	ST70-30	K60U	ST70-34
K120N	ST70-27	50.121.08	ST70-32
K150KG	ST70-26		

Model	Pin			Bushing		OEM PIN No.	Location			Spring Products			
	Pin Type	Size	Lock	Size	SRI		F*	R*	H*	PIN No.	QWIK Bushing No.	LUBRAFLEX™ Bushing No.	GENERIC Bushing No.

ADVANCE MIXER

		1.25" x 7.70"		1.50" x 3.50"	RNI		X	X	X	BSP73-1	BSA120-5	BSL120-5	
--	---	---------------	--	---------------	-----	--	---	---	---	---------	----------	----------	--

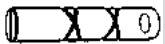
BLUEBIRD

TC2000 All American Pre-1998		1.12" x 5.00"	.61"†	1.37" x 3.00"	PLG		X	X		BSP25-2	BSA110-2		
		1.12" x 5.00"	.61"†	1.37" x 4.00"	PLK	0997056			X		BSP25-2	BSA110-7	
TC2000 & All American 1994 - Present		1.25" x 6.25"	5.08"	1.50" x 4.00"	RNK	1662774 00051758	X	X	X	BSP12-17	BSA120-9	BSL120-9	BSG120-9



CRANE CARRIER

Centurion Series		1.25" x 6.50"	.625"	1.50" x 4.00"	RNK	243-235	X			BSP37-2	BSA120-9	BSL120-9	BSG120-9
		1.25" x 6.12"	5.00"	1.50" x 4.00"	RNK	243-233		X	X		BSP12-12	BSA120-9	BSL120-9

FORD

F, FT, L, LN, LT, LNT, LST, LS, W, WT, H, HT, N, NT, 600 thru 1100		1.00" x 5.81"	4.84"	1.25" x 4.00"	NJK	D0HZ-5780F C7TZ-5348LC D1HA-5A314-AA E5HT-5780A E8HT-5A314-AA E5HZ-5780A	X	X	X	BSP10-7	BSA100-2	BSL100-2	BSG100-2
Louisville with cast front hangers		1.00" x 6.42"	5.16"	1.25" x 4.00"	NJK	D0HA-5A314-C D0HZ-5780E E5HZ-5780B	X			BSP10-8	BSA100-2	BSL100-2	BSG100-2
COE C Series BLUEBIRD TC2000		1.00" x 5.12"		1.25" x 3.00"	NJG	C6TZ-5304B		X	X	BSP64-2	BSA100-4		
COE C Series		1.00" x 5.01"		1.25" x 3.00"	NJG	B7TZ-5465B B7A-5465A B7Q-5465A D5HZ-5465A		X	X	BSP18-5-	BSA100-4		

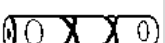
FREIGHTLINER

4 spring eyes strap style shackles		1.25" x 6.88"	5.37"	1.50" x 4.00"	RNK	16-12373-000 16-13470-000 16-13078-000	X	X	X	BSP38-2	BSA120-9	BSL120-9	BSG120-9
		1.25" x 7.12"	5.37"			16-12302-000	X	X	X	BSP79-1**			BSG0073-1
4 spring eyes strap style shackles		1.25" x 6.88"	5.37"	1.62" x 4.00"	TNK	16-12373-000 16-13470-000 16-13078-000 16-13079-000			X	BSP38-2	BSA120-10	BSL120-10	

GILLIG

All Models		1.37" x 7.00"				55-00696-001	X	X	X	BSP78-1**			
------------	---	---------------	--	--	--	--------------	---	---	---	-----------	--	--	--

HME

		1.00" x 6.68"								BSP53-1			
--	---	---------------	--	--	--	--	--	--	--	---------	--	--	--

INTERNATIONAL / NAVISTAR

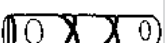
1710,1710A 1810,1810A Series		.87" x 5.0"	3.89"	1.12" x 3.00"	LHG	64146-HC	X			BSP8-1	BSA16-4		
------------------------------------	---	-------------	-------	---------------	-----	----------	---	--	--	--------	---------	--	--







* F = Spring front eye, R = Spring rear eye, H = Hanger, **Threaded pin, ***Kenworth Dealer Bushings,
†From opposite grease fitting end, ‡From grease fitting end, SRI = Spring Research Institute

Front Spring Pins and Bushings

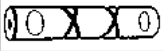
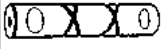
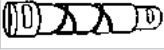
INTERNATIONAL / NAVISTAR,
KENWORTH, KME, MACK,
OSHKOSH

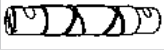
Model	Pin			Bushing		OEM PIN No.	Location			Spring Products			
	Pin Type	Size	Lock	Size	SRI		F*	R*	H*	PIN No.	QWIK Bushing No.	LUBRAFLEX™ Bushing No.	GENERIC Bushing No.

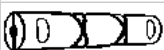
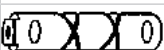
INTERNATIONAL / NAVISTAR

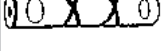
		.87" x 4.71"	3.78"	1.12" x 3.00"	LHG	76771-R1		X	X	BSP8-2	BSA16-4		
1910,1910A 2010, 2010A Series		1.00" x 6.18"	5.06"	1.25" x 4.00"	NJK	303865-C1	X	X	X	BSP10-9	BSA100-2	BSL100-2	BSG100-2
All 4000,5000 Series Hd. dia. grease fitting end 1.497; opp. end 1.062		1.25" x 7.06"	5.75"	1.75" x 4.00"	VNK	688953-R1	X			BSP19-2	BSA120-2		
		1.37" x 7.37"	5.75"	1.765" x 4.00"		688953-R1	X			BSP67-1**			BSG0026-1
Hd. dia. each end 1.062		1.25" x 7.06"	5.75"	1.75" x 4.00"	VNK	688952-R1		X	X	BSP20-2	BSA120-2		
		1.37" x 7.37"	5.75"	1.765" x 4.00"		688952-R1		X	X	BSP68-1**			BSG0026-1
All S models with 4 springs 1600,1700,1800 1900,2200,2400 2500,2600 Series		1.00" x 7.00"	.96"†	1.25" x 4.00"	NJK	1648109C1 468703C2	X			BSP34-1	BSA100-2	BSL100-2	BSG100-2
		1.00" x 6.31"	4.92"	1.25" x 4.00"	NJK	468704C1 1648110C1		X	X	BSP35-1	BSA100-2	BSL100-2	BSG100-2
All 9000 Series		1.00" x 7.25"	5.75"	1.75" x 4.00"	VJK		X	X	X	BSP41-1			
9000 Series COE & Conv.		1.37" x 7.37"	5.75"	1.75" x 4.00"		507203C1	X	X	X	BSP71-1**			BSG0068-1
S Models with 10,000# axle & heavier 2000,3000,3800, 4000, Series		1.25" x 6.50"	5.03"	1.50" x 4.00"	RNK	1661976C3 3511254C1	X	X	X	BSP49-1	BSA120-9	BSL120-9	BSG120-9
4800 Series with all wheel drive 1988 - Present		1.00" x 5.30"	3.92"	1.25" x 3.00"	NJG	1648112C1		X	X	BSP62-1	BSA100-4		

KENWORTH

Grease fitting port on large end of pin		1.37" x 7.37"	5.75"	1.75" x 4.00"		6262	X			BSP67-1**			BSG5295-1** BSG0068-1
Grease fitting port on small end of pin		1.37" x 7.37"	5.75"	1.75" x 4.00"		K179-378	X			BSP69-1**			BSG5295-1** BSG0068-1
		1.37" x 7.37"	5.75"	1.75" x 4.00"		5296		X	X	BSP70-1**			BSG5295-1** BSG0068-1

KME

		1.00" x 5.87"	4.53"	1.25" x 3.50"	NJI	023658F		X	X	BSP82-1		BSL100-7	
--	---	---------------	-------	---------------	-----	---------	--	---	---	---------	--	----------	--

MACK

		1.25" x 6.25"	.68"‡	1.50" x 3.50"	RNI	44QK173B	X			BSP31-6	BSA120-5	BSL120-5	
		1.31" x 7.03"	5.59"	1.77" x 4.00"		10QK310M5				BSP85-1**			BSG0078-1
		1.37" x 6.66"	5.01"	1.75" x 3.50"		44QK26A		X	X	BSP90-1**			BSG0069-1

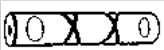
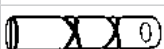
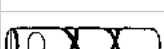

OSHKOSH

S Series Front Discharge Mixer 1994-		1.12" x 6.25"	4.63"	1.37" x 3.00"	PLG	2044870	X			BSP58-1	BSA110-6		
		1.12" x 4.95"	.19"‡	1.37" x 3.00"	PLG	57613BX		X		BSP75-1	BSA110-6		
Snowplow		1.12" x 6.25"	.44"†	1.37" x 3.00"	PLG	1664070	X			BSP74-1	BSA110-6		

* F = Spring front eye, R = Spring rear eye, H = Hanger, **Threaded pin, ***Kenworth Dealer Bushings,
†From opposite grease fitting end, ‡From grease fitting end, SRI = Spring Research Institute

Model	Pin			Bushing		OEM PIN No.	Location			Spring Products			
	Pin Type	Size	Lock	Size	SRI		F*	R*	H*	PIN No.	QWIK Bushing No.	LUBRAFLEX™ Bushing No.	GENERIC Bushing No.

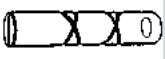
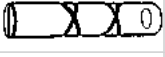
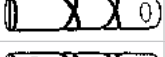

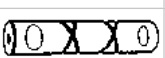
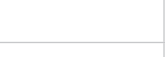
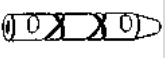
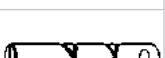
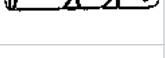
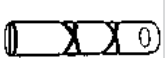

OSHKOSH

Snowplow		1.12" x 4.95"	.19"‡	1.37" x 3.00"	PLG	57613BX		X		BSP75-1	BSA110-6		
		1.12" x 4.95"	.19"‡	1.50" x 3.00"	RLG	57613BX			X	BSP75-1	BSA110-8		
P19A FIRE APPARATUS		1.12 x 5.50	.19"‡		RLG	1416710			X	BSP75-2	BSA110-8		
		1.25 x 6.12	.19"‡		RNK	107487B	X			BSP75-3	BSA110-8		
		1.25 x 6.62	.19"†	1.50" x 4.00"	RNK	1418150		X		BSP98-1	BSA120-9		

PIERCE

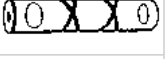
		1.12" x 7.00"	5.48"	1.37" X 4.00"	PLK	1006385 40-6954 40-9533 2267668	X	X	X	BSP24-2	BSA110-4	BSL110-4	BSG110-4
		1.25" x 6.50"	5.03"	1.50" X 4.00"	RNK	1006386 2267670 40-8553 40-9534	X	X	X	BSP49-1	BSA120-9	BSL120-9	BSG120-9
		1.25" x 5.56"	4.00"	1.50" X 3.00"	RNG	1006387 40-4958 40-9535 2267672		X	X	BSP55-1	BSA120-6	BSL120-6	BSG120-6
		1.12" x 5.50"	0.62"‡	1.37" X 3.00"	PLG	1006382 40-0195 40-9531 2267673				BSP65-1	BSA110-6		
		1.12" x 5.13"	0.62"‡	1.37" X 3.00"	PLG	1006383 40-6745 40-9532 2267676				BSP65-2	BSA110-6		
		1.00" x 5.59"	4.56"	1.25" x 3.50"	NJI	1006380 40-0190 40-9529 2267678				BSP66-1		BSL100-7	
		1.00" x 6.00"	4.75"	1.25" x 3.50"	NJI	1006381 40-6006 40-9530 2267679				BSP66-2		BSL100-7	

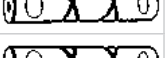
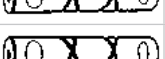
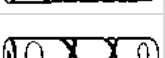
PETERBILT

359 Conv. 352 COE		1.25" x 6.12"	5.00"	1.50" x 3.50"	RNI	02-01560 02-00180 02-01846	X			BSP12-12	BSA120-5	BSL120-5	
		1.25" x 5.56"	4.37"	1.50" x 3.50"	RNI	02-00082 02-01847		X	X	BSP12-13	BSA120-5	BSL120-5	
Cab Over Model 362		1.25" x 6.25"	5.08"	1.50" x 4.00"	RNK	02-01561	X	X	X	BSP12-17	BSA120-9	BSL120-9	BSG120-9
Conventional Model 359		1.25" x 5.62"	4.50"	1.50" x 3.00"	RNG	02-01562			X	BSP12-18	BSA120-6	BSL120-6	BSG120-6
Cab Over Model 362		1.25" x 6.25"	5.08"	1.50" x 3.50"	RNI	02-01561		X		BSP12-17	BSA120-5	BSL120-5	
Conventional Models 357, 362, 379 1986 with Airide		1.25" x 6.85"	5.31"	1.50" x 4.00"	RNK	02-1767 02-1781	X	X	X	BSP50-1	BSA120-9	BSL120-9	BSG120-9

ROSENBAUER

		1.25" x 6.88"	5.37"							BSP39-1			
--	---	---------------	-------	--	--	--	--	--	--	---------	--	--	--

* F = Spring front eye, R = Spring rear eye, H = Hanger, **Threaded pin, ***Kenworth Dealer Bushings,
†From opposite grease fitting end, ‡From grease fitting end, SRI = Spring Research Institute

Front Spring Pins and Bushings

SUTPHEN FIRE CHASSIS,
THOMAS, VOLVO / GMC,
WESTERN STAR, WHITE

Model	Pin			Bushing		OEM PIN No.	Location			Spring Products			
	Pin Type	Size	Lock	Size	SRI		F*	R*	H*	PIN No.	QWIK Bushing No.	LUBRAFLEX™ Bushing No.	GENERIC Bushing No.

STERLING

		1.25" x 6.66"	5.12"	1.50" x 4.00"	RNK	F7HZ-5780DB	X	X	X	BSP50-2	BSA120-9	BSL120-9	BSG120-9
--	---	---------------	-------	---------------	-----	-------------	---	---	---	---------	----------	----------	----------





SUTPHEN FIRE CHASSIS

		1.00" x 4.63"		1.25" x 3.00"	NJG			X	X	BSP64-2 Shackle kit K1000F-9	BSA100-4		
		1.00" x 5.01"		1.25" x 3.00"	NJG		X			BSP18-5	BSA100-4		

THOMAS

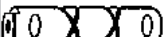
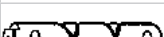
MODEL ER 1994 - Present		1.12" x 7.00"	5.48"	1.37" x 4.00"	PLK	62300122				BSP24-2	BSA110-3		
----------------------------	---	---------------	-------	---------------	-----	----------	--	--	--	---------	----------	--	--

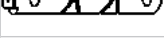
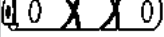
VOLVO / GMC

AERO Model w/German Springs		1.12" x 7.00"	5.48"	1.37" x 4.00"	PLK	37121-0001 3082276 3974787	X	X		BSP24-2		BSL110-4	BSG110-4
		1.12" x 7.00"	5.48"	1.37" x 4.00"	PLK	37121-0001 3082276 3974787			X	BSP24-2	BSA110-3 Bushings O.D. 1.3770	BSL110-4	BSG110-4
1989 - Present w/Hendrickson Springs		1.12" x 7.00"	5.48"	1.37" x 4.00"	PLK	37121-0001 3082276 3974788	X	X		BSP24-2	BSA110-1 Bushings O.D. 1.3735	BSL110-4	BSG110-4
1989 - Present w/Hendrickson Springs		1.12" x 7.00"	5.48"	1.37" x 4.00"	PLK	37121-0001 3082276 3974787			X	BSP24-2	BSA110-3 Bushings O.D. 1.3770	BSL110-4	BSG110-4
Models N10, N12 Grease fitting port on large end of pin		1.31" x 7.03"	5.59"	1.77" x 4.12"		1614230 1075723	X	X	X	BSP83-1			BSG0078-1
Grease fitting port on small end of pin		1.31" x 7.03"	5.59"	1.77" x 4.12"		1614229 1076334	X	X	X	BSP85-1			BSG0078-1

WESTERN STAR

F3W-125, F6W-1200 RB-2, RC-2		1.12" x 7.00"	5.48"	1.37" x 4.00"	PLK	37121-0001	X	X	X	BSP24-2	BSA110-1		
		1.12" x 5.95"	5.03"	1.37" x 4.00"	PLK	37121-3413		X	X	BSP63-1	BSA110-1		
		1.12" x 6.90"	5.63"	1.37" x 4.00"	PLK	37121-3412	X			BSP63-2	BSA110-1		

WHITE

F3W-120 12000#		1.00" x 6.25"	.51"†	1.25" x 4.00"	NJK	506267	X	X		BSP10-6	BSA101-1		
-------------------	---	---------------	-------	---------------	-----	--------	---	---	--	---------	----------	--	--

S.R.I. NUMBERING SYSTEM

S.R.I. Spring Research Institute Standardized Numbering System for Spring Eye Bushings

1ST LETTER REPRESENTING O.D. "J" is 1" ± each letter is 1/16" - "K" = 1 1/16" - "L" = 15/16"

2ND LETTER REPRESENTS I.D. "J" is 1" ± each letter is 1/16" - "K" = 1 1/16" - "L" = 15/16"

3RD LETTER REPRESENTS LENGTH "K" is 4" ± each letter is 1/4" = "J" is 3 3/4" - "L" is 4 1/4"

In addition, bushing material may be indicated with a two or three letter suffix. For example: SB = Steel Backed Bronze.

S.R.I. LETTERING SYSTEM			
DIMENSION	- INCREMENTS	BASE LETTER	+ INCREMENTS
O.D.	1/16"	J=1"	1/16"
I.D.	1/16"	J=1"	1/16"
LENGTH	1/4"	K=4"	1/4"

SPECIAL PIN APPLICATIONS					
MODEL	Description	OEM No.	OEM Spec.	Part No.	Remarks
Eagle Bus	pin-lower	010104003	1.889 x 7.79"	95.21.1	Upper and Lower
	pin-upper	050107003	1.494 x 6.46"	95.22.1	Lateral Pins

* F = Spring front eye, R = Spring rear eye, H = Hanger, **Threaded pin, ***Kenworth Dealer Bushings,
†From opposite grease fitting end, ‡From grease fitting end, SRI = Spring Research Institute

Rear Spring Pins and Bushings

Model	Pin			Bushings		OEM PIN No.	Location			Spring Products			
	Pin Type	Size	Lock	Size	SRI		F*	R*	H*	PIN No.	QWIK Bushing No.	LUBRAFLEX™ Bushing No.	GENERIC Bushing No.

BLUEBIRD

TC2000 Thru 1996		1.25" x 5.56"	4.00"	1.50" x 3.00"	RNG	1353440	X			BSP55-1	BSA120-6	BSL120-6	BSG120-6
All American Rear engine		1.25" x 6.00"	.59"‡	1.50" x 4.00"	RNK	1034271	X	X	X	BSP60-1	BSA120-13		

FORD

COE C Series		1.12" x 5.00"	.61"‡	1.37" x 3.00"	PLG	7EQ5780 B7Q5780A	X	X		BSP25-2	BSA110-2		
COE C Series		1.12" x 5.00"	.61"‡	1.25" x 2.75"	NLF				X	BSP25-2			
LN 600, 700, 750, 800, L 800, 900, F 700, 750, 800, 850, 900, 950, 1000, 1100, CL 900, H 1000, W 900, 1000,		1.25" x 5.00"	4.00"	1.50" x 3.00"	RNG	C3TZ-5780A D0HZ-5780B	X			BSP12-20	BSA120-6	BSL120-6	BSG120-6

FREIGHTLINER

		1.37" x 6.00"	4.21"	1.62" x 3.00"	TPG	6803250074	X			BSP50-3		BSL13-2	
--	--	---------------	-------	---------------	-----	------------	---	--	--	---------	--	---------	--

HENDRICKSON REAR SUSPENSION

340 Series		1.25" x 7.18"	.62"‡	1.50" x 4.00"	RNK	BE-4927 32276		X		BSP16-2	BSA120-9	BSL120-9	BSG120-9
380/440/450 Series		1.37" x 7.12"	.62"‡	1.62" x 4.00"	TPK	BE-13938 32277		X		BSP2-2	BSA13-1	BSL13-1	BSG13-1
380/440/450 Series		1.37" x 6.9"	5.37" Double Lock	1.62" x 4.00"	TPK	43146		X		BSP46-2	BSA13-1	BSL13-1	BSG13-1
RT500 Series		1.50" x 7.50"	.62"‡	1.75" x 4.00"	VRK	5		X		BSP22-2	BSA15-1		

INTERNATIONAL / NAVISTAR

S-SERIES		1.25" x 5.56"	4.00"	1.50" x 3.00"	RNG	1671766C1	X			BSP55-1	BSA120-6	BSL120-6	BSG120-6
----------	--	---------------	-------	---------------	-----	-----------	---	--	--	---------	----------	----------	----------

MACK

F&MH		1.25" x 5.62"	4.12"	1.50" x 3.00"	RNG	44QK143CP2	X			BSP59-1	BSA120-6	BSL120-6	BSG120-6
------	--	---------------	-------	---------------	-----	------------	---	--	--	---------	----------	----------	----------

Spring Eye Service Tools - Spring Product Support Items

	Part No.	Application		Part No.	Application		Part No.	Application
	ST-1000-1	(Fits all 1" pins)		ST-1000-11	(Fits all 1" pins)		ST-1000-5	(Fits all 1" pins)
	ST-1125-1	(Fits all 1 1/8" pins)		ST-1125-11	(Fits all 1 1/8" pins)		ST-1125-5	(Fits all 1 1/8" pins)
	ST-1250-1	(Fits all 1 1/4" pins)		ST-1250-11	(Fits all 1 1/4" pins)		ST-1250-5	(Fits all 1 1/4" pins)
	ST-1375-1	(Fits all 1 3/8" pins)		ST-1375-11	(Fits all 1 3/8" pins)		ST-1375-5	(Fits all 1 3/8" pins)
	ST-1000-6	(Fits all 1" pins)		ST-1000-12	(Fits all 1" pins)		ST-50-9	general
	ST-1125-6	(Fits all 1 1/8" pins)		ST-1125-12	(Fits all 1 1/8" pins)			
	ST-1250-6	(Fits all 1 1/4" pins)		ST-1250-12	(Fits all 1 1/4" pins)			
	ST-1375-6	(Fits all 1 3/8" pins)		ST-1375-12	(Fits all 1 3/8" pins)			

* F = Spring front eye, R = Spring rear eye, H = Hanger, **Threaded pin, ***Kenworth Dealer Bushings,
‡From opposite grease fitting end, †From grease fitting end, SRI = Spring Research Institute

King Pin Kit Interchange

Part No.	Qwik Kit	Plus Kit	Econo Kit
ALLIANCE AXLE			
P6073300019KZ	K120A		
P6073300119KZ	K120A		
P6073300219KZ	K80A		
P6073300319KZ	K80A		
P6073300419KZ	K160A		
P6073300519KZ	K160A		
AUTOCAR			
836687	K125G	70.125.07	50.125.07
857328	K125G	70.125.07	50.125.07
859552	K970R	70.970.18	50.970.18
1715447	K970R	70.970.18	50.970.18
1739844	KH901L	78.901.12	58.901.12
02-7091941	K921L	70.921.12	50.921.12
AUTOMANN			
460.102B	K70G	70.070.07	50.070.07
460.105B	K68Z	70.068.26	
460.106B	K69Z	70.069.26	
460.122B	K970R	70.970.18	50.970.18
460.148B	K921L	70.921.12	50.921.12
460.160B	K140I	70.140.09	50.140.09
460.162B	K75F	70.075.06	50.075.06
460.164B	K55G	70.055.07	50.055.07
460.166B	KH931L	78.931.12	58.931.12
460.168B	K941F	70.941.06	50.941.06
460.172B	KE350F	75.350.06	55.350.06
460.186B	KE350F	75.350.06	55.350.06
460.194B	K533M	70.533.13	50.533.13
460.196B	K121G	70.121.07	50.121.07
460.200B	K126W	70.126.23	50.126.23
460.204B	K931L	70.931.12	50.931.12
460.206B	K310I	70.310.09	50.310.09
460.207B	K700T	70.700.20	
460.212B	K616M	70.616.13	50.616.13
460.216B	K140I	70.140.09	50.140.09
460.220C	K120E	70.120.05	50.120.05
460.244B	K102I	70.102.09	50.102.09
460.246B	K961L	70.961.12	50.961.12
460.254B	K120E	70.120.05	50.120.05
460.255N	K122V		
460.260B	K120I	70.120.09	50.120.09
460.260C	K120I	70.120.09	50.120.09
460.262B	K141S	70.141.19	50.141.19
460.264B	K76F	70.076.06	50.076.06
460.266B	K80G		
460.286B	K122E	70.122.05	50.122.05
460.480B	K56G	70.056.07	50.056.07
460.512C	K146E	70.146.05	50.146.05
460.518C	K981R	70.981.18	50.981.18
460.534B	K147E	70.147.05	50.147.05
460.536C	K103S	70.103.19	50.103.19
BLUEBIRD			
00063311			50.121.08
00063312			50.121.08
00063313			50.121.08
2137305	K931L	70.931.12	50.931.12
2156784	K140I	70.140.09	50.140.09
2599033	K931L	70.931.12	50.931.12
4279568	KG931R	77.931.18	57.931.18
4280855	K961L	70.961.12	50.961.12
4293270	K140I	70.140.09	50.140.09
4294716	K146S		
8305203	K120I	70.120.09	50.120.09
8305211	K141S	70.141.19	50.141.19
8314171	K102I	70.102.09	50.102.09
BWP			
M-2300	K51G	70.051.07	50.051.07
M-2301	K98I	70.098.09	50.098.09
M-2305	K125G	70.125.07	50.125.07

Part No.	Qwik Kit	Plus Kit	Econo Kit
BWP			
M-2306	K95G	70.095.07	50.095.07
M-2309	K125G	70.125.07	50.125.07
M-2310	K50F	70.053.06	50.053.06
M-2311	KD901R	74.901.18	54.901.18
M-2312	KD901R	74.901.18	54.901.18
M-2313	K95G	70.095.07	50.095.07
M-2315	K901L	70.901.12	50.901.12
M-2316	K70G	70.070.07	50.070.07
M-2317	K70G	70.070.07	50.070.07
M-2318	K51G	70.051.07	50.051.07
M-2319	K51G	70.051.07	50.051.07
M-2320	K70F	70.073.06	50.073.06
M-2321	K70F	70.073.06	50.073.06
M-2322	K901L	70.901.12	50.901.12
M-2325	K109I		50.109.09
M-2326	K970R	70.970.18	50.970.18
M-2327	K970R	70.970.18	50.970.18
M-2331	K921L	70.921.12	50.921.12
M-2332	K140I	70.140.09	50.140.09
M-2333	K140I	70.140.09	50.140.09
M-2334	K75F	70.075.06	50.075.06
M-2335	K55G	70.055.07	50.055.07
M-2336	KH901L	78.901.12	58.901.12
M-2337	KE350F	75.350.06	55.350.06
M-2338	K95F	70.095.06	50.095.06
M-2339	KH931L	78.931.12	58.931.12
M-2340	K941F	70.941.06	50.941.06
M-2341	K101I	70.101.09	50.101.09
M-2342	K108I		50.108.09
M-2343	K139I	70.139.09	50.139.09
M-2344	K139I	70.139.09	50.139.09
M-2345	K309I	70.309.09	50.309.09
M-2347	K533M	70.533.13	50.533.13
M-2348	K931L	70.931.12	50.931.12
M-2349	K126W	70.126.23	50.126.23
M-2350	K121G	70.121.07	50.121.07
M-2351	K120W		
M-2352	KH901L	78.901.12	58.901.12
M-2353	K535M		
M-2358	K971R	70.971.18	50.971.18
M-2363	K70D	70.070.04	50.070.04
M-2370	K55G	70.055.07	50.055.07
M-2373	K309I	70.309.09	50.309.09
M-2375	KE350F	75.350.06	55.350.06
M-2378	K125W	70.125.23	50.125.23
M-2379	K310I	70.310.09	50.310.09
M-2380	K140I	70.140.09	50.140.09
M-2381	K931L	70.931.12	50.931.12
M-2382	K120E	70.120.05	50.120.05
M-2383	K121E	70.121.05	50.121.05
M-2384	K102I	70.102.09	50.102.09
M-2385	K961L	70.961.12	50.961.12
M-2386	K109I		50.109.09
M-2387	K140I	70.140.09	50.140.09
M-2388	K51G	70.051.07	50.051.07
M-2389	K120E	70.120.05	50.120.05
M-2390	K121E	70.121.05	50.121.05
M-2391	K56G	70.056.07	50.056.07
M-2392	K72F	70.072.06	50.072.06
M-2397	K122E	70.122.05	50.122.05
CHEVROLET / GMC			
722166	K55G	70.055.07	50.055.07
859552	K901L	70.901.12	50.901.12
1561960	K80G		
1561961	K110G		
1561962	K120G		
2010021	K931L	70.931.12	50.931.12
2036352	KH931L	78.931.12	58.931.12
CHEVROLET / GMC			
2224495	K51G	70.051.07	50.051.07
2254366	K170G		
2264897	K125G	70.125.07	50.125.07
2321013	K95G	70.095.07	50.095.07
2362900	K125G	70.125.07	50.125.07
2431372	K95G	70.095.07	50.095.07
2442145	K970R	70.970.18	50.970.18
2452865	KH901L	78.901.12	58.901.12
2470621	K70D	70.070.04	50.070.04
2927942	K51G	70.051.07	50.051.07
3691111	K51G	70.051.07	50.051.07
3745285	KD901R	74.901.18	54.901.18
3829410	K51G	70.051.07	50.051.07
3829970	K70G	70.070.07	50.070.07
3838390	K70G	70.070.07	50.070.07
3853990	K51G	70.051.07	50.051.07
3853994	K70G	70.070.07	50.070.07
3854744	K51G	70.051.07	50.051.07
3858389	K51G	70.051.07	50.051.07
3858390	K70G	70.070.07	50.070.07
3927942	K51G	70.051.07	50.051.07
3927943	K70G	70.070.07	50.070.07
8885021	K95G	70.095.07	50.095.07
8885621	K121G	70.121.07	50.121.07
8885856	K121G	70.121.07	50.121.07
8885857	K70G	70.070.07	50.070.07
12472161	K56G	70.056.07	50.056.07
12472162	K58G	70.058.07	
12540328	K80G		
12540329	K110G		
12540330	K120G		
12541348	K180E	70.180.05	50.180.05
15510849	K931L	70.931.12	50.931.12
15512233	K970R	70.970.18	50.970.18
15512234	KH901L	78.901.12	58.901.12
15512235	K901L	70.901.12	50.901.12
15512239	KG931R	77.931.18	57.931.18
15521976	K58G	70.058.07	
15522020	K56G	70.056.07	50.056.07
15536398	K55G	70.055.07	50.055.07
15584763	K56G	70.056.07	50.056.07
15585841	KH931L	78.931.12	58.931.12
15618118	KG931R	77.931.18	57.931.18
19243453	K180E	70.180.05	50.180.05
85106184	K122E	70.122.05	50.122.05
88911967	K56G	70.056.07	50.056.07
88911968	K56G	70.056.07	50.056.07
88911998	K120G		
88936011	K80R	70.080.18	50.080.18
88936044	K961L	70.961.12	50.961.12
88936084	K60R		
88936119	K70R	70.070.18	50.070.18
88936144	KG931R	77.931.18	57.931.18
94058104	K68Z	70.068.26	
97723802	K69Z	70.069.26	
97782770	K69Z	70.069.26	
98438973	K69Z	70.069.26	
98441181	K69Z	70.069.26	
98443583	K69Z	70.069.26	
98443939	K69Z	70.069.26	
98448583	K68Z	70.068.26	
IC-2-40	K170G		
DANA / NAPA			
101KK100	K101I	70.101.09	50.101.09
101KK111	K102I	70.102.09	50.102.09
120KK100	K120I	70.120.09	50.120.09
120KK102	K146S		
262-1012	K51G	70.051.07	50.051.07

Part No.	Qwik Kit	Plus Kit	Econo Kit
DANA / NAPA			
262-1016	K51G	70.051.07	50.051.07
262-1017	K70G	70.070.07	50.070.07
262-1018	K70F	70.073.06	50.073.06
262-1331	K51G	70.051.07	50.051.07
262-1336	K98I	70.098.09	50.098.09
262-1364	K125G	70.125.07	50.125.07
262-1406	K95G	70.095.07	50.095.07
262-1407	KD900R		
262-1414	KD901R	74.901.18	54.901.18
262-1421	K70D	70.070.04	50.070.04
262-1422	K125G	70.125.07	50.125.07
262-1425	KD901R	74.901.18	54.901.18
262-1431	K70D	70.070.04	50.070.04
262-1443	K120W		
262-1461	K50F	70.053.06	50.053.06
262-1462	K70G	70.070.07	50.070.07
262-1463	K51G	70.051.07	50.051.07
262-1464	K901L	70.901.12	50.901.12
262-1467	K95G	70.095.07	50.095.07
262-1468	K970R	70.970.18	50.970.18
262-1472	K51G	70.051.07	50.051.07
262-1473	K70G	70.070.07	50.070.07
262-1475	K51G	70.051.07	50.051.07
262-1476	K70F	70.073.06	50.073.06
262-1482	K901L	70.901.12	50.901.12
262-1483	K70F	70.073.06	50.073.06
262-1488	K970R	70.970.18	50.970.18
262-1490	K109I		50.109.09
262-1491	K140I	70.140.09	50.140.09
262-1506	K970R	70.970.18	50.970.18
262-1507	K901L	70.901.12	50.901.12
262-1508	K140I	70.140.09	50.140.09
262-1509	K109I		50.109.09
262-1510	KD901R	74.901.18	54.901.18
262-1512	KH901L	78.901.12	58.901.12
262-1513	KH901L	78.901.12	58.901.12
262-1514	K970R	70.970.18	50.970.18
262-1515	K70F	70.073.06	50.073.06
262-1525	K921L	70.921.12	50.921.12
262-1537	K75F	70.075.06	50.075.06
262-1547	K55G	70.055.07	50.055.07
262-1548	K55G	70.055.07	50.055.07
262-1549	KE350F	75.350.06	55.350.06
262-1550	K941F	70.941.06	50.941.06
262-1551	K95F	70.095.06	50.095.06
262-1554	KH931L	78.931.12	58.931.12
262-1555	K101I	70.101.09	50.101.09
262-1556	K941FA		
262-1557	K108I		50.108.09
262-1558	K139I	70.139.09	50.139.09
262-1559	K139I	70.139.09	50.139.09
262-1560	K309I	70.309.09	50.309.09
262-1561	K309I	70.309.09	50.309.09
262-1562	K140I	70.140.09	50.140.09
262-1563	KE350F	75.350.06	55.350.06
262-1569	K533M	70.533.13	50.533.13
262-1570	K535M		
262-1572	K931L	70.931.12	50.931.12
262-1574	K121G	70.121.07	50.121.07
262-1576	K126W	70.126.23	50.126.23
262-1577	K125W	70.125.23	50.125.23
262-1578	K98I	70.098.09	50.098.09
262-1579	K310I	70.310.09	50.310.09
262-1580	K971R	70.971.18	50.971.18
262-1582	K121G	70.121.07	50.121.07
262-1583	KG931R	77.931.18	57.931.18
262-1584	K140I	70.140.09	50.140.09
262-1585	K120E	70.120.05	50.120.05

Part No.	Qwik Kit	Plus Kit	Econo Kit
DANA / NAPA			
262-1586	K121E	70.121.05	50.121.05
262-1587	K71F	70.071.06	50.071.06
262-1588	K56G	70.056.07	50.056.07
262-1590	KH931L	78.931.12	58.931.12
262-1591	K616M	70.616.13	50.616.13
262-1592	K931L	70.931.12	50.931.12
262-1593	K931L	70.931.12	50.931.12
262-1594	K180E	70.180.05	50.180.05
262-1597	K72F	70.072.06	50.072.06
262-1598	K942F	70.942.06	50.942.06
262-1599	K96F	70.096.06	50.096.06
262-1600	K941F	70.941.06	50.941.06
262-1601	K941F	70.941.06	50.941.06
262-1603	K102I	70.102.09	50.102.09
262-1604	K961L	70.961.12	50.961.12
262-1605	K109I		50.109.09
262-1606	K140I	70.140.09	50.140.09
262-1608	K51G	70.051.07	50.051.07
262-1609	K120E	70.120.05	50.120.05
262-1610	K121E	70.121.05	50.121.05
262-1611	K56G	70.056.07	50.056.07
262-1632	K71F	70.071.06	50.071.06
262-1633	K180E	70.180.05	50.180.05
262-1634	K961L	70.961.12	50.961.12
262-1635	K120I	70.120.09	50.120.09
262-1636	K141S	70.141.19	50.141.19
262-1637	K76F	70.076.06	50.076.06
262-1638	K942FA		
262-1639	K146F		
262-1640	K80G		
262-1641	K110G		
262-1642	K120G		
262-1682	K121G	70.121.07	50.121.07
343KK103	K140I	70.140.09	50.140.09
429-4716	K146S		
DAYTON			
300-101A	K120H		
300-107	K51G	70.051.07	50.051.07
300-110	K98I	70.098.09	50.098.09
300-125	K125G	70.125.07	50.125.07
300-128	K95G	70.095.07	50.095.07
300-140	K70D	70.070.04	50.070.04
300-141	K70D	70.070.04	50.070.04
300-142	K120W		
300-148	K535M		
300-150	K125G	70.125.07	50.125.07
300-152	K51G	70.051.07	50.051.07
300-153	K70G	70.070.07	50.070.07
300-154	K70G	70.070.07	50.070.07
300-155	K50F	70.053.06	50.053.06
300-156	K50F	70.053.06	50.053.06
300-158	KD901R	74.901.18	54.901.18
300-159	KD901R	74.901.18	54.901.18
300-160	KD901R	74.901.18	54.901.18
300-161	KD901R	74.901.18	54.901.18
300-163	K95G	70.095.07	50.095.07
300-170	K70D	70.070.04	50.070.04
300-171	K901L	70.901.12	50.901.12
300-172	K70G	70.070.07	50.070.07
300-173	K70G	70.070.07	50.070.07
300-174	K51G	70.051.07	50.051.07
300-175	K51G	70.051.07	50.051.07
300-176	K51G	70.051.07	50.051.07
300-177	K51G	70.051.07	50.051.07
300-179	K70F	70.073.06	50.073.06
300-180	K70F	70.073.06	50.073.06
300-182	K901L	70.901.12	50.901.12
300-187	K109I		50.109.09

Part No.	Qwik Kit	Plus Kit	Econo Kit
DAYTON			
300-194	K109I		50.109.09
300-195	K970R	70.970.18	50.970.18
300-196	K970R	70.970.18	50.970.18
300-204	K921L	70.921.12	50.921.12
300-205	K140I	70.140.09	50.140.09
300-206	K140I	70.140.09	50.140.09
300-207	K75F	70.075.06	50.075.06
300-208	K55G	70.055.07	50.055.07
300-209	K55G	70.055.07	50.055.07
300-210	KH901L	78.901.12	58.901.12
300-211	KH901L	78.901.12	58.901.12
300-214	KE350F	75.350.06	55.350.06
300-215	K95F	70.095.06	50.095.06
300-216	KH931L	78.931.12	58.931.12
300-217	K941F	70.941.06	50.941.06
300-218	K101I	70.101.09	50.101.09
300-220	K108I		50.108.09
300-221	K139I	70.139.09	50.139.09
300-222	K139I	70.139.09	50.139.09
300-223	K309I	70.309.09	50.309.09
300-224	K309I	70.309.09	50.309.09
300-227	K941FA		
300-228	KE350F	75.350.06	55.350.06
300-230	K535M		
300-231	K533M	70.533.13	50.533.13
300-232	K931L	70.931.12	50.931.12
300-233	K121G	70.121.07	50.121.07
300-234	K125W	70.125.23	50.125.23
300-235	K126W	70.126.23	50.126.23
300-240	K971R	70.971.18	50.971.18
300-242	K931L	70.931.12	50.931.12
300-244	KG931R	77.931.18	57.931.18
300-245	K616M	70.616.13	50.616.13
300-248	K310I	70.310.09	50.310.09
300-249	K140I	70.140.09	50.140.09
300-250	K139I	70.139.09	50.139.09
300-255	K70D	70.070.04	50.070.04
300-257	K120E	70.120.05	50.120.05
300-258	K121E	70.121.05	50.121.05
300-259	K56G	70.056.07	50.056.07
300-260	K72F	70.072.06	50.072.06
300-261	K941F	70.941.06	50.941.06
300-262	K942F	70.942.06	50.942.06
300-263	K96F	70.096.06	50.096.06
300-264	KG931R	77.931.18	57.931.18
300-265	KH931L	78.931.12	58.931.12
300-266	K961L	70.961.12	50.961.12
300-267	K180E	70.180.05	50.180.05
300-268	K102I	70.102.09	50.102.09
300-269	K140I	70.140.09	50.140.09
300-270	K108I		50.108.09
300-271	K120I	70.120.09	50.120.09
300-273	K71F	70.071.06	50.071.06
300-274	K120E	70.120.05	50.120.05
300-275	K121E	70.121.05	50.121.05
300-276	K120I	70.120.09	50.120.09
300-277	K141S	70.141.19	50.141.19
300-278	K160S	70.160.19	50.160.19
300-279	K56G	70.056.07	50.056.07
300-280	K941F	70.941.06	50.941.06
300-281	K942FA		
300-282	K102I	70.102.09	50.102.09
300-283	K180E	70.180.05	50.180.05
300-284	K961L	70.961.12	50.961.12
300-285	K71F	70.071.06	50.071.06
300-286	K76F	70.076.06	50.076.06
300-287	K80G		
300-288	K110G		

King Pin Kit Interchange

Part No.	Qwik Kit	Plus Kit	Econo Kit
DAYTON			
300-289	K120G		
300-290	K122V		
300-291	K140V		
300-292	K146F		
300-293	K122E	70.122.05	50.122.05
300-294	K146E	70.146.05	50.146.05
300-295	K146E	70.146.05	50.146.05
300-296	K70D	70.070.04	50.070.04
300-297	K122E	70.122.05	50.122.05
300-298	K146S		
300-299	K981R	70.981.18	50.981.18
300-300	K942F	70.942.06	50.942.06
300-303	K123E	70.123.05	50.123.05
300-305	K147E	70.147.05	50.147.05
300-306	K147E	70.147.05	50.147.05
300-307	K146E	70.146.05	50.146.05
300-310	K180R	70.180.18	50.180.18
300-312	KH946R	78.946.18	58.946.18
300-314	K70R	70.070.18	50.070.18
300-316	K80R	70.080.18	50.080.18
300-317	K981R	70.981.18	50.981.18
300-318	K103S	70.103.19	50.103.19
300-319	K103S	70.103.19	50.103.19
300-324	K941R	70.941.18	50.941.18
300-325	K180E	70.180.05	50.180.05
300-329	K181R	70.181.18	50.181.18
300-330	K181R	70.181.18	50.181.18
300-332	KG931R	77.931.18	57.931.18
300-334	K120R	70.120.18	50.120.18
300-336			50.121.08
DODGE			
1643174	K125G	70.125.07	50.125.07
1692644	K50F	70.053.06	50.053.06
1818726	KD901R	74.901.18	54.901.18
1843208	K70D	70.070.04	50.070.04
2808618	K901L	70.901.12	50.901.12
E-ONE			
513823	KH931L	78.931.12	58.931.12
EATON			
316111	K122E	70.122.05	50.122.05
328342	K122E	70.122.05	50.122.05
328343	K146E	70.146.05	50.146.05
328344	K122E	70.122.05	50.122.05
328345	K146E	70.146.05	50.146.05
328346	K123E	70.123.05	50.123.05
328347	K147E	70.147.05	50.147.05
328348	K123E	70.123.05	50.123.05
328349	K147E	70.147.05	50.147.05
329022	K141S	70.141.19	50.141.19
329023	K160S	70.160.19	50.160.19
329116	K162S		
329182	K103S	70.103.19	50.103.19
329404	K146E	70.146.05	50.146.05
329405	K146E	70.146.05	50.146.05
329432	K180E	70.180.05	50.180.05
329433	K180E	70.180.05	50.180.05
331434	K200S		
331435	K201S		
524530	K146E	70.146.05	50.146.05
806355	K120E	70.120.05	50.120.05
806356	K121E	70.121.05	50.121.05
811525	K180E	70.180.05	50.180.05
815984	K120E	70.120.05	50.120.05
823078	K122E	70.122.05	50.122.05
823946	K146E	70.146.05	50.146.05
824530	K146E	70.146.05	50.146.05
824920	K146E	70.146.05	50.146.05
1008431	K120E	70.120.05	50.120.05

Part No.	Qwik Kit	Plus Kit	Econo Kit
EATON			
1008500	K180E	70.180.05	50.180.05
806355B	K120E	70.120.05	50.120.05
EATON TOP SPEC			
KP2230	K533M	70.533.13	50.533.13
KP2262	K981	70.098.09	50.098.09
KP2266	K125G	70.125.07	50.125.07
KP2268	K95G	70.095.07	50.095.07
KP2271	K125G	70.125.07	50.125.07
KP2272	K120W		
KP2275	K901L	70.901.12	50.901.12
KP2276	K95G	70.095.07	50.095.07
KP2277	K51G	70.051.07	50.051.07
KP2278	K51G	70.051.07	50.051.07
KP2279	K70G	70.070.07	50.070.07
KP2280	K70G	70.070.07	50.070.07
KP2281	K51G	70.051.07	50.051.07
KP2283	K70F	70.073.06	50.053.06
KP2284	K70F	70.073.06	50.053.06
KP2285	K109I		50.109.09
KP2288	KD901R	74.901.18	54.901.18
KP2289	K70D	70.070.04	50.070.04
KP2290	K70D	70.070.04	50.070.04
KP2291	K970R	70.970.18	50.970.18
KP2292	K901L	70.901.12	50.901.12
KP2293	K109I		50.109.09
KP2294	KD901R	74.901.18	54.901.18
KP2296	KH901L	78.901.12	58.901.12
KP2297	KH901L	78.901.12	58.901.12
KP2298	K970R	70.970.18	50.970.18
KP2305	K921L	70.921.12	50.921.12
KP2311	K140I	70.140.09	50.140.09
KP2312	K140I	70.140.09	50.140.09
KP2313	K75F	70.075.06	50.075.06
KP2314	KH931L	78.931.12	58.931.12
KP2315	K941F	70.941.06	50.941.06
KP2316	K95F	70.095.06	50.095.06
KP2317	K55G	70.055.07	50.055.07
KP2318	K55G	70.055.07	50.055.07
KP2319	KE350F	75.350.06	55.350.06
KP2320	K101I	70.101.09	50.101.09
KP2321	K941F	70.941.06	50.941.06
KP2322	K108I		50.108.09
KP2323	K139I	70.139.09	50.139.09
KP2324	K139I	70.139.09	50.139.09
KP2325	K309I	70.309.09	50.309.09
KP2326	K309I	70.309.09	50.309.09
KP2327	K931L	70.931.12	50.931.12
KP2329	K535M		
KP2330	K533M	70.533.13	50.533.13
KP2331	K121G	70.121.07	50.121.07
KP2333	K126W	70.126.23	50.126.23
KP2334	K125W	70.125.23	50.125.23
KP2336	K616M	70.616.13	50.616.13
KP2337	K310I	70.310.09	50.310.09
KP2338	K931L	70.931.12	50.931.12
KP2339	K971R	70.971.18	50.971.18
KP2340	K140I	70.140.09	50.140.09
KP2341	K120E	70.120.05	50.120.05
KP2342	K180E	70.180.05	50.180.05
KP2343	KE350F	75.350.06	55.350.06
KP2344	K50F	70.053.06	50.053.06
KP2365	K139I	70.139.09	50.139.09
KP2748	KH931L	78.931.12	58.931.12
KP2924	KG931R	77.931.18	57.931.18
KP2983	K50F	70.053.06	50.053.06
KP2985	K51G	70.051.07	50.051.07
KP2987	K55G	70.055.07	50.055.07
KP2990	K70D	70.070.04	50.070.04

Part No.	Qwik Kit	Plus Kit	Econo Kit
EATON TOP SPEC			
KP2991	K70F	70.073.06	50.053.06
KP2992	K70G	70.070.07	50.070.07
KP2994	K75F	70.075.06	50.075.06
KP2996	K95F	70.095.06	50.095.06
KP2997	K95G	70.095.07	50.095.07
KP2998	K981	70.098.09	50.098.09
KP3000	K101I	70.101.09	50.101.09
KP3001	K108I		50.108.09
KP3002	K109I		50.109.09
KP3004	K120E	70.120.05	50.120.05
KP3006	K120W		
KP3007	K121G	70.121.07	50.121.07
KP3008	K125G	70.125.07	50.125.07
KP3009	K125W	70.125.23	50.125.23
KP3010	K126W	70.126.23	50.126.23
KP3011	K139I	70.139.09	50.139.09
KP3012	K140I	70.140.09	50.140.09
KP3014	K170G		
KP3019	K309I	70.309.09	50.309.09
KP3020	K310I	70.310.09	50.310.09
KP3023	KE350F	75.350.06	55.350.06
KP3026	K533M	70.533.13	50.533.13
KP3028	K535M		
KP3030	K616M	70.616.13	50.616.13
KP3031	KD900R		
KP3032	K901L	70.901.12	50.901.12
KP3033	KD901R	74.901.18	54.901.18
KP3034	KH901L	78.901.12	58.901.12
KP3035	K921L	70.921.12	50.921.12
KP3037	K941F	70.941.06	50.941.06
KP3038	K931L	70.931.12	50.931.12
KP3039	KH931L	78.931.12	58.931.12
KP3040	K970R	70.970.18	50.970.18
KP3041	K971R	70.971.18	50.971.18
KP3130	K120E	70.120.05	50.120.05
KP3133	KG931R	77.931.18	57.931.18
KP3134	K56G	70.056.07	50.056.07
ELGIN			
KB325	K140I	70.140.09	50.140.09
KB325N	K140I	70.140.09	50.140.09
KB424	K109I		50.109.09
KB425	K109I		50.109.09
KB425CB	K109I		50.109.09
KB450	K125G	70.125.07	50.125.07
KB450A	K125G	70.125.07	50.125.07
KB450AN	K125G	70.125.07	50.125.07
KB458CB	K941F	70.941.06	50.941.06
KB459	KD900R		
KB462B	K51G	70.051.07	50.051.07
KB463	K95G	70.095.07	50.095.07
KB463N	K95G	70.095.07	50.095.07
KB465A	KD901R	74.901.18	54.901.18
KB465AN	KD901R	74.901.18	54.901.18
KB477A	K70D	70.070.04	50.070.04
KB477AN	K70D	70.070.04	50.070.04
KB477ANR	K70D	70.070.04	50.070.04
KB477AR	K70D	70.070.04	50.070.04
KB479X	K120W		
KB491A	K51G	70.051.07	50.051.07
KB491AN	K51G	70.051.07	50.051.07
KB492	K70G	70.070.07	50.070.07
KB492A	K70G	70.070.07	50.070.07
KB492AN	K70G	70.070.07	50.070.07
KB493	K50F	70.053.06	50.053.06
KB504	K901L	70.901.12	50.901.12
KB504N	K901L	70.901.12	50.901.12
KB505A	K970R	70.970.18	50.970.18
KB505AN	K970R	70.970.18	50.970.18

Part No.	Qwik Kit	Plus Kit	Econo Kit
ELGIN			
KB516	K109I		50.109.09
KB525	KE350F	75.350.06	55.350.06
KB534B	K921L	70.921.12	50.921.12
KB537	K75F	70.075.06	50.075.06
KB546	K95F	70.095.06	50.095.06
KB547	KH931L	78.931.12	58.931.12
KB547CB	KH931L	78.931.12	58.931.12
KB548	K941F	70.941.06	50.941.06
KB571	K70F	70.073.06	50.073.06
KB571N	K70F	70.073.06	50.073.06
KB571NR	K70F	70.073.06	50.073.06
KB571R	K70F	70.073.06	50.073.06
KB578	K71F	70.071.06	50.071.06
KB645	K101I	70.101.09	50.101.09
KB700	KH901L	78.901.12	58.901.12
KB700N	KH901L	78.901.12	58.901.12
KB722	K55G	70.055.07	50.055.07
KB722CB	K55G	70.055.07	50.055.07
KB722N	K55G	70.055.07	50.055.07
KB816	K108I		50.108.09
KB817	K139I	70.139.09	50.139.09
KB817N	K139I	70.139.09	50.139.09
KB818	K309I	70.309.09	50.309.09
KB818N	K309I	70.309.09	50.309.09
KB819	K941FA		
KB819CB	K941FA		
KB823	K931L	70.931.12	50.931.12
KB825	KE350F	75.350.06	55.350.06
KB828	K535M		
KB829BI	K533M	70.533.13	50.533.13
KB830	K121G	70.121.07	50.121.07
KB832	K125W	70.125.23	50.125.23
KB834	K616M	70.616.13	50.616.13
KB835	K310I	70.310.09	50.310.09
KB836	KG931R	77.931.18	57.931.18
KB836CB	KG931R	77.931.18	57.931.18
KB837	K971R	70.971.18	50.971.18
KB838	K126W	70.126.23	50.126.23
KB839	K931L	70.931.12	50.931.12
KB839CB	K931L	70.931.12	50.931.12
KB840	K140I	70.140.09	50.140.09
KB840CB	K140I	70.140.09	50.140.09
KB841CB	K120E	70.120.05	50.120.05
KB842CB	K121E	70.121.05	50.121.05
KB843	K72F	70.072.06	50.072.06
KB843CB	K72F	70.072.06	50.072.06
KB844	K942F	70.942.06	50.942.06
KB844CB	K942F	70.942.06	50.942.06
KB845	K96F	70.096.06	50.096.06
KB846CB	K180E	70.180.05	50.180.05
KB847	K102I	70.102.09	50.102.09
KB847CB	K102I	70.102.09	50.102.09
KB848CB	K961L	70.961.12	50.961.12
KB849	K120I	70.120.09	50.120.09
KB852	K110G		
KB861	K146E	70.146.05	50.146.05
KB864	K942FA		
KB868	K147E	70.147.05	50.147.05
EUCLID			
E-10104B	K80G		
E-10105B	K110G		
E-10106B	K120G		
E-10107B	K180E	70.180.05	50.180.05
E-10165N	K122V		
E-10166N	K140V		
E-11394B	K122E	70.122.05	50.122.05
E-11785	K160S	70.160.19	50.160.19
E-11808C	K981R	70.981.18	50.981.18

Part No.	Qwik Kit	Plus Kit	Econo Kit
EUCLID			
E-11812C	K80R	70.080.18	50.080.18
E-11813C	K180R	70.180.18	50.180.18
E-11814C	K181R	70.181.18	50.181.18
E-11816C	K70R	70.070.18	50.070.18
E-4430B	K51G	70.051.07	50.051.07
E-4431B	K98I	70.098.09	50.098.09
E-4434B	K125G	70.125.07	50.125.07
E-4434N	K125G	70.125.07	50.125.07
E-4435B	K95G	70.095.07	50.095.07
E-4435N	K95G	70.095.07	50.095.07
E-4438B	K70D	70.070.04	50.070.04
E-4438N	K70D	70.070.04	50.070.04
E-4440B	K50F	70.053.06	50.053.06
E-4441B	KD901R	74.901.18	54.901.18
E-4441N	KD901R	74.901.18	54.901.18
E-4442B	K901L	70.901.12	50.901.12
E-4442N	K901L	70.901.12	50.901.12
E-4443B	K70G	70.070.07	50.070.07
E-4443N	K70G	70.070.07	50.070.07
E-4444B	K51G	70.051.07	50.051.07
E-4444N	K51G	70.051.07	50.051.07
E-4445B	K70F	70.073.06	50.073.06
E-4445N	K70F	70.073.06	50.073.06
E-4446B	K109I		50.109.09
E-4448B	K109I		50.109.09
E-4449B	K970R	70.970.18	50.970.18
E-4449N	K970R	70.970.18	50.970.18
E-4450B	K921L	70.921.12	50.921.12
E-4451B	K140I	70.140.09	50.140.09
E-4451N	K140I	70.140.09	50.140.09
E-4452B	K75F	70.075.06	50.075.06
E-4453B	K55G	70.055.07	50.055.07
E-4453N	K55G	70.055.07	50.055.07
E-4454B	KH901L	78.901.12	58.901.12
E-4454N	KH901L	78.901.12	58.901.12
E-4457B	K95F	70.095.06	50.095.06
E-4458B	KH931L	78.931.12	58.931.12
E-4458C	KH931L	78.931.12	58.931.12
E-4459B	K941F	70.941.06	50.941.06
E-4459C	K941F	70.941.06	50.941.06
E-4460B	K101I	70.101.09	50.101.09
E-4461B	K108I		50.108.09
E-4462B	K139I	70.139.09	50.139.09
E-4462N	K139I	70.139.09	50.139.09
E-4463B	K309I	70.309.09	50.309.09
E-4463N	K309I	70.309.09	50.309.09
E-4464B	K941FA		
E-4466B	K535M		
E-4467B	K533M	70.533.13	50.533.13
E-4468B	K931L	70.931.12	50.931.12
E-4469B	K121G	70.121.07	50.121.07
E-4470B	K125W	70.125.23	50.125.23
E-4471B	K126W	70.126.23	50.126.23
E-4595B	K971R	70.971.18	50.971.18
E-4598B	K120W		
E-4599B	K616M	70.616.13	50.616.13
E-4693B	K140I	70.140.09	50.140.09
E-4694C	K931L	70.931.12	50.931.12
E-4695C	KG931R	77.931.18	57.931.18
E-4696B	K120E	70.120.05	50.120.05
E-4696C	K120E	70.120.05	50.120.05
E-4697B	K310I	70.310.09	50.310.09
E-4698B	K139I	70.139.09	50.139.09
E-5441B	KD900R		
E-5485B	K72F	70.072.06	50.072.06
E-6194B	K180E	70.180.05	50.180.05
E-6195B	K72F	70.072.06	50.072.06
E-6196B	K942F	70.942.06	50.942.06

Part No.	Qwik Kit	Plus Kit	Econo Kit
EUCLID			
E-6197B	K96F	70.096.06	50.096.06
E-6198B	K102I	70.102.09	50.102.09
E-6199B	K961L	70.961.12	50.961.12
E-6199C	K961L	70.961.12	50.961.12
E-6450B	KE350F	75.350.06	55.350.06
E-6451B	KE350F	75.350.06	55.350.06
E-6454B	K56G	70.056.07	50.056.07
E-6455B	K71F	70.071.06	50.071.06
E-6868B	KG931R	77.931.18	57.931.18
E-6869B	K121E	70.121.05	50.121.05
E-6869C	K121E	70.121.05	50.121.05
E-6875C	K140I	70.140.09	50.140.09
E-6876C	K108I		50.108.09
E-9312B	K901L	70.901.12	50.901.12
E-9941B	K120I	70.120.09	50.120.09
E-9942B	K141S	70.141.19	50.141.19
E-9943B	K76F	70.076.06	50.076.06
E-9944B	K942F	70.942.06	50.942.06
E-9945B	K146F		
FLAGG			
FKP-100-C	KG931R	77.931.18	57.931.18
FKP-101-C	K121E	70.121.05	50.121.05
FKP-102-C	K56G	70.056.07	50.056.07
FKP-103-B	K71F	70.071.06	50.071.06
FKP-104-B	K72F	70.072.06	50.072.06
FKP-105-B	K942F	70.942.06	50.942.06
FKP-106-B	K96F	70.096.06	50.096.06
FKP-107-C	K941F	70.941.06	50.941.06
FKP-108-C	K941F	70.941.06	50.941.06
FKP-109-B	K180E	70.180.05	50.180.05
FKP-110-B	K102I	70.102.09	50.102.09
FKP-111-B	K961L	70.961.12	50.961.12
FKP-111-C	K961L	70.961.12	50.961.12
FKP-112-B	K108I		50.108.09
FKP-113-C	K140I	70.140.09	50.140.09
FKP-114-B	K51G	70.051.07	50.051.07
FKP-115-B	K120E	70.120.05	50.120.05
FKP-116-B	K121E	70.121.05	50.121.05
FKP-117-B	K56G	70.056.07	50.056.07
FKP-118-B	K120I	70.120.09	50.120.09
FKP-119-B	K141S	70.141.19	50.141.19
FKP-11-B	K125G	70.125.07	50.125.07
FKP-120-B	K76F	70.076.06	50.076.06
FKP-121-B	K80G		
FKP-122-B	K110G		
FKP-123-B	K120G		
FKP-124B	K146F		
FKP-125-C	K942F	70.942.06	50.942.06
FKP-126-C	K122V		
FKP-127-C	K140V		
FKP-128-C	K942F	70.942.06	50.942.06
FKP-129B	K942FA		
FKP-130-B	K160S	70.160.19	50.160.19
FKP-130-C	K160S	70.160.19	50.160.19
FKP-131-B	K122E	70.122.05	50.122.05
FKP-132-B	K146E	70.146.05	50.146.05
FKP-133-C	K146E	70.146.05	50.146.05
FKP-134-C	K146S		
FKP-135-C	K139I	70.139.09	50.139.09
FKP-136-C	K981R	70.981.18	50.981.18
FKP-137-B	K126W	70.126.23	50.126.23
FKP-139-B	K123E	70.123.05	50.123.05
FKP-140-C	KH946R	78.946.18	58.946.18
FKP-141-C	K180R	70.180.18	50.180.18
FKP-142-C	K80R	70.080.18	50.080.18
FKP-143-C	K70R	70.070.18	50.070.18
FKP-144-B	K147E	70.147.05	50.147.05
FKP-145-C	K103S	70.103.19	50.103.19

King Pin Kit Interchange

FLAGG,
FLEETRITE,
FORD

Part No.	Qwik Kit	Plus Kit	Econo Kit
FLAGG			
FKP-146-C	K941R	70.941.18	50.941.18
FKP-27-B	K95G	70.095.07	50.095.07
FKP-34-B	K70F	70.073.06	50.073.06
FKP-36-B	K50F	70.053.06	50.053.06
FKP-37-B	K901L	70.901.12	50.901.12
FKP-38-B	K51G	70.051.07	50.051.07
FKP-39-B	K70G	70.070.07	50.070.07
FKP-40-B	K51G	70.051.07	50.051.07
FKP-43-B	K70F	70.073.06	50.073.06
FKP-44-B	K109I		50.109.09
FKP-46-B	K70D	70.070.04	50.070.04
FKP-49-B	K970R	70.970.18	50.970.18
FKP-4-B	K51G	70.051.07	50.051.07
FKP-50-B	K901L	70.901.12	50.901.12
FKP-51-B	K109I		50.109.09
FKP-52-B	KH901L	78.901.12	58.901.12
FKP-53-B	KD901R	74.901.18	54.901.18
FKP-54-B	K70F	70.073.06	50.073.06
FKP-59-B	K120W		
FKP-62-B	K921L	70.921.12	50.921.12
FKP-68-B	K140I	70.140.09	50.140.09
FKP-69-B	K75F	70.075.06	50.075.06
FKP-70-B	K55G	70.055.07	50.055.07
FKP-71-B	KH931L	78.931.12	58.931.12
FKP-72-B	K941F	70.941.06	50.941.06
FKP-73-B	K95F	70.095.06	50.095.06
FKP-74-B	KE350F	75.350.06	55.350.06
FKP-75-B	K101I	70.101.09	50.101.09
FKP-76-B	K108I		50.108.09
FKP-77-B	K139I	70.139.09	50.139.09
FKP-78-B	K309I	70.309.09	50.309.09
FKP-79-B	K941FA		
FKP-81-B	KE350F	75.350.06	55.350.06
FKP-82-B	K98I	70.098.09	50.098.09
FKP-84-B	K535M		
FKP-85-B	K533M	70.533.13	50.533.13
FKP-86-B	K121G	70.121.07	50.121.07
FKP-88-B	K126W	70.126.23	50.126.23
FKP-89-B	K125W	70.125.23	50.125.23
FKP-8-B	K98I	70.098.09	50.098.09
FKP-90-B	K931L	70.931.12	50.931.12
FKP-91-B	K310I	70.310.09	50.310.09
FKP-92-B	KG931R	77.931.18	57.931.18
FKP-93-B	K971R	70.971.18	50.971.18
FKP-94-B	K616M	70.616.13	50.616.13
FKP-96-B	K140I	70.140.09	50.140.09
FKP-97-C	K931L	70.931.12	50.931.12
FKP-98-C	K120E	70.120.05	50.120.05
FKP-99-C	KH931L	78.931.12	58.931.12
FLEETRITE			
FAK4444	K51G	70.051.07	50.051.07
FAK4446	K98I	70.098.09	50.098.09
FAK4454	K95G	70.095.07	50.095.07
FAK4460	K120W		
FAK4461	K50F	70.053.06	50.053.06
FAK4465	K95G	70.095.07	50.095.07
FAK4467	K70G	70.070.07	50.070.07
FAK4468	K70G	70.070.07	50.070.07
FAK4469	K51G	70.051.07	50.051.07
FAK4470	K51G	70.051.07	50.051.07
FAK4471	K70F	70.073.06	50.073.06
FAK4472	K70F	70.073.06	50.073.06
FAK4474	K109I		50.109.09
FAK4477	K109I		50.109.09
FAK4485	K140I	70.140.09	50.140.09
FAK4487	K75F	70.075.06	50.075.06
FAK4488	K55G	70.055.07	50.055.07
FAK4489	K55G	70.055.07	50.055.07

Part No.	Qwik Kit	Plus Kit	Econo Kit
FLEETRITE			
FAK4492	KE350F	75.350.06	55.350.06
FAK4493	K95F	70.095.06	50.095.06
FAK4494	K941F	70.941.06	50.941.06
FAK4495	K101I	70.101.09	50.101.09
FAK4497	K108I		50.108.09
FAK4498	K139I	70.139.09	50.139.09
FAK4500	K309I	70.309.09	50.309.09
FAK4504	K941FA		
FAK4505	KE350F	75.350.06	55.350.06
FAK4507	K535M		
FAK4508	K533M	70.533.13	50.533.13
FAK4509	K121G	70.121.07	50.121.07
FAK4510	K125W	70.125.23	50.125.23
FAK4511	K126W	70.126.23	50.126.23
FAK4514	K616M	70.616.13	50.616.13
FAK4516	K310I	70.310.09	50.310.09
FAK4517	K140I	70.140.09	50.140.09
FAK4518	K139I	70.139.09	50.139.09
FAK4524	KD900R		
FAK4526	K170G		
FAK4527	K125G	70.125.07	50.125.07
FAK4529	KD900R		
FAK4530	KD900R		
FAK4531	KD901R	74.901.18	54.901.18
FAK4532	K70D	70.070.04	50.070.04
FAK4533	K125G	70.125.07	50.125.07
FAK4536	KD901R	74.901.18	54.901.18
FAK4537	K70D	70.070.04	50.070.04
FAK4538	K970R	70.970.18	50.970.18
FAK4539	K970R	70.970.18	50.970.18
FAK4540	K901L	70.901.12	50.901.12
FAK4541	KH901L	78.901.12	58.901.12
FAK4542	KH901L	78.901.12	58.901.12
FAK4544	K901L	70.901.12	50.901.12
FAK4546	K109I		50.109.09
FAK4548	KD901R	74.901.18	54.901.18
FAK4549	K125G	70.125.07	50.125.07
FAK4550	K970R	70.970.18	50.970.18
FAK4551	K901L	70.901.12	50.901.12
FAK4552	KH901L	78.901.12	58.901.12
FAK4553	K921L	70.921.12	50.921.12
FAK4555	K931L	70.931.12	50.931.12
FAK4558	KH931L	78.931.12	58.931.12
FAK4559	K921L	70.921.12	50.921.12
FAK4560	K971R	70.971.18	50.971.18
FAK4561	K931L	70.931.12	50.931.12
FAK4564	K931L	70.931.12	50.931.12
FAK4566	KG931R	77.931.18	57.931.18
FAK4567	KG931R	77.931.18	57.931.18
FAK4568	KH931L	78.931.12	58.931.12
FAK4569	K70D	70.070.04	50.070.04
FAK4570	K961L	70.961.12	50.961.12
FAK4571	KH901L	78.901.12	58.901.12
FAK4572	K120E	70.120.05	50.120.05
FAK4573	K121E	70.121.05	50.121.05
FAK4574	K180E	70.180.05	50.180.05
FAK4580	K170G		
FAK4582	K102I	70.102.09	50.102.09
FAK4583	K120E	70.120.05	50.120.05
FAK4584	K121E	70.121.05	50.121.05
FAK4585	K51G	70.051.07	50.051.07
FAK4586	K72F	70.072.06	50.072.06
FAK4587	K942F	70.942.06	50.942.06
FAK4588	K941F	70.941.06	50.941.06
FAK4589	K96F	70.096.06	50.096.06
FAK4590	K941F	70.941.06	50.941.06
FAK4594	K56G	70.056.07	50.056.07
FAK4596	K180E	70.180.05	50.180.05

Part No.	Qwik Kit	Plus Kit	Econo Kit
FLEETRITE			
FAK4598	K141S	70.141.19	50.141.19
FAK4599	K76F	70.076.06	50.076.06
FAK4600	K80G		
FAK4601	K120I	70.120.09	50.120.09
FAK4603	K146F		
FAK4604	K110G		
FAK4605	K120G		
FAK4606	K942F	70.942.06	50.942.06
FAK4609	K160S	70.160.19	50.160.19
FAK4610	K122E	70.122.05	50.122.05
FAK4614	K981R	70.981.18	50.981.18
FAK4626	K103S	70.103.19	50.103.19
FAK5444	K101I	70.101.09	50.101.09
FAK5446	K139I	70.139.09	50.139.09
FAK5447	K309I	70.309.09	50.309.09
FAK5451	K310I	70.310.09	50.310.09
FAK5452	K101I	70.101.09	50.101.09
FAK5453	K140I	70.140.09	50.140.09
FAK5454	K102I	70.102.09	50.102.09
FAK5455	K120I	70.120.09	50.120.09
FAK5456	K141S	70.141.19	50.141.19
FAK5457	K160S	70.160.19	50.160.19
FAK5459	K536M		
FAK5465	K120I	70.120.09	50.120.09
FAK5466	K141S	70.141.19	50.141.19
FAK5500	K147E	70.147.05	50.147.05
FAK5506	K122E	70.122.05	50.122.05
FAK5507	K147E	70.147.05	50.147.05
FORD			
2C2Z-3111AA	K50W		
4C40-3010-RA	K103S	70.103.19	50.103.19
4C40-3111BA	K103S	70.103.19	50.103.19
4C4Z-3111AA	K120I	70.120.09	50.120.09
4C4Z-3111AB	K141S	70.141.19	50.141.19
4C4Z-3111BB	K103S	70.103.19	50.103.19
4C4Z-3111CA	K120I	70.120.09	50.120.09
B0Q-3111A	KD900R		
B7QH-3111A	KD901R	74.901.18	54.901.18
B7QH-3111B	K70D	70.070.04	50.070.04
B7TZ-3111B	K70D	70.070.04	50.070.04
B7TZ-3111C	K125G	70.125.07	50.125.07
B7TZ-3111D	KD901R	74.901.18	54.901.18
B7TZ-3111F	K70D	70.070.04	50.070.04
B7TZ-3111G	KD901R	74.901.18	54.901.18
B8QH-3111B	K125G	70.125.07	50.125.07
BC4Z-3111E	K80R	70.080.18	50.080.18
C1TZ-3111C	K125G	70.125.07	50.125.07
C2TZ-3111B	K70D	70.070.04	50.070.04
C2TZ-3111C	KD901R	74.901.18	54.901.18
C2TZ-3111D	K125G	70.125.07	50.125.07
C2TZ-3111F	K70D	70.070.04	50.070.04
C2TZ-3111G	KD901R	74.901.18	54.901.18
C3TZ-3111A	K50F	70.053.06	50.053.06
C3TZ-3111B	K901L	70.901.12	50.901.12
C3TZ-3111C	K901L	70.901.12	50.901.12
C3TZ-3111D	K50F	70.053.06	50.053.06
C4TA-3010C	K50F	70.053.06	50.053.06
C4TA-3010E	K50F	70.053.06	50.053.06
C4TZ-3111A	K970R	70.970.18	50.970.18
C4TZ-3111B	K970R	70.970.18	50.970.18
C5TZ-3111B	KH901L	78.901.12	58.901.12
C5TZ-3111D	KH901L	78.901.12	58.901.12
C7HZ-3111A	K70F	70.073.06	50.073.06
C7TA-3010J	K70F	70.073.06	50.073.06
C7TA-3010Z	KD901R	74.901.18	54.901.18
C7TZ-3111A	K70F	70.073.06	50.073.06
C9TA-3010D	K50F	70.053.06	50.053.06
C9TZ-3111C	K901L	70.901.12	50.901.12

Part No.	Qwik Kit	Plus Kit	Econo Kit
FORD			
D0HA-3010H	K901L	70.901.12	50.901.12
D0HZ-3111A	KD901R	74.901.18	54.901.18
D0HZ-3111B	K901L	70.901.12	50.901.12
D0HZ-3111C	K970R	70.970.18	50.970.18
D0HZ-3111E	KH901L	78.901.12	58.901.12
D1HT-3111B	K901L	70.901.12	50.901.12
D1HZ-3010AA	KH901L	78.901.12	58.901.12
D1HZ-3111A	KD901R	74.901.18	54.901.18
D1HZ-3111B	K901L	70.901.12	50.901.12
D1HZ-3111C	K901L	70.901.12	50.901.12
D1TZ-3111C	K901L	70.901.12	50.901.12
D2TZ-3111D	K50F	70.053.06	50.053.06
D3HA-3010AA	KH931F	78.931.06	58.931.06
D3HA-3010KA	KH931F	78.931.06	58.931.06
D3TZ-3111A	K70F	70.070.06	50.070.06
D5HZ-3111C	KH931F	78.931.06	58.931.06
D5TZ-3111B	K75F	70.075.06	50.075.06
D5UZ-3111B	KE350F	75.350.06	55.350.06
D5UZ-3111D	KE350F	75.350.06	55.350.06
D6HZ-3111A	K941F	70.941.06	50.941.06
D6HZ-3111B	K95F	70.095.06	50.095.06
D6HZ-3111C	K941F	70.941.06	50.941.06
D6HZ-3111D	K95F	70.095.06	50.095.06
D6TZ-3111A	K75F	70.075.06	50.075.06
D7HT-3010RA	K941F	70.941.06	50.941.06
D7HT-3010UA	K50F	70.053.06	50.053.06
D7HZ-3111A	KD901R	74.901.18	54.901.18
D7TZ-3111A	K70F	70.073.06	50.073.06
D8HZ-3111C	K941FA		
E0HT-3010AC	K70F	70.073.06	50.073.06
E0HT-3010CA	K75F	70.075.06	50.075.06
E0TZ-3111A	KE350F	75.350.06	55.350.06
E2HT-3010AA	K901L	70.901.12	50.901.12
E2HT-3010BA	K941F	70.941.06	50.941.06
E2HT-3010DA	K942FA		
E4HT-3010CB	K75F	70.075.06	50.075.06
E7HT-3010AA	K95F	70.095.06	50.095.06
E7HT-3010BA	K95F	70.095.06	50.095.06
E7HT-3010EA	K941F	70.941.06	50.941.06
E7HT-3010HA	K70F	70.073.06	50.073.06
E7HT-3010SA	KH931F	78.931.06	58.931.06
E7HT-3010TA	K942F	70.942.06	50.942.06
E7HZ-3010S	K942F	70.942.06	50.942.06
E7TZ-3111A	K75F	70.075.06	50.075.06
E8HZ-3111A	K72F	70.072.06	50.072.06
E8TA-3010A2C	K71F	70.071.06	50.071.06
E8TZ-3111A	K71F	70.071.06	50.071.06
E9HT-3010AA	K942F	70.942.06	50.942.06
E9HT-3010EA	K70F	70.073.06	50.073.06
E9HZ-3111A	K942F	70.942.06	50.942.06
E9HZ-3111B	K96F	70.096.06	50.096.06
E9HZ-3111C	K76F	70.076.06	50.076.06
FOHT-3010AA	KH931F	78.931.06	58.931.06
FOHT-3010BA	K96F	70.096.06	50.096.06
FOHT-3010CA	K72F	70.072.06	50.072.06
FOHT-3010DA	K72F	70.072.06	50.072.06
FOHT-3010EA	K76F	70.076.06	50.076.06
FOHT-3010FA	K76F	70.076.06	50.076.06
FOHT-3010SA	K76F	70.076.06	50.076.06
FOHZ-3111A	K942F	70.942.06	50.942.06
F1HT-3010AA	K942F	70.942.06	50.942.06
F1HZ-3010A	K76F	70.076.06	50.076.06
F1HZ-3010C	K76F	70.076.06	50.076.06
F1HZ-3111A	K72F	70.072.06	50.072.06
F2HT-3010AA	K942F	70.942.06	50.942.06
F4HZ-3010D	K942F	70.942.06	50.942.06
F5HT-3010BA	K72F	70.072.06	50.072.06
F5HT-3010DA	K942F	70.942.06	50.942.06

Part No.	Qwik Kit	Plus Kit	Econo Kit
FORD			
F5HT-3010EA	K942F	70.942.06	50.942.06
F5HT-3010GA	KH931F	78.931.06	58.931.06
F5HT-3010HA	KH931F	78.931.06	58.931.06
F5HT-3010JA	KH931F	78.931.06	58.931.06
F5HZ-3111A	K146F		
F6HT-3010AB	KH931F	78.931.06	58.931.06
F6HT-3010BA	K942F	70.942.06	50.942.06
F6HT-3010BB	K942F	70.942.06	50.942.06
F6HT-3010DB	K942F	70.942.06	50.942.06
F6HZ-3111AA	K942F	70.942.06	50.942.06
F6HZ-3111BB	K942F	70.942.06	50.942.06
F6HZ-3111CC	K942FA		
F6HZ-3111DB	K942F	70.942.06	50.942.06
F81-3010AA	K72F	70.072.06	50.942.06
F81A-3010CA	K76F	70.076.06	50.076.06
F81D-3010AA	K72F	70.072.06	50.072.06
F81Z-3010AA	K72F	70.072.06	50.072.06
F81Z-3010CA	K76F	70.076.06	50.076.06
L7HT-3010EA	K941F	70.941.06	50.941.06
FREIGHTLINER			
123	K125G	70.125.07	50.125.07
144	K125G	70.125.07	50.125.07
156	K970R	70.970.18	50.970.18
157	K970R	70.970.18	50.970.18
167	K901L	70.901.12	50.901.12
168	KH901L	78.901.12	58.901.12
170	KH901L	78.901.12	58.901.12
172	K901L	70.901.12	50.901.12
195	K931L	70.931.12	50.931.12
198	KH931L	78.931.12	58.931.12
199	K921L	70.921.12	50.921.12
1300	K971R	70.971.18	50.971.18
1303	K971R	70.971.18	50.971.18
1307	K931L	70.931.12	50.931.12
1320	K71D	70.071.04	50.071.04
P6073300019KZ	K120A		
P6073300119KZ	K120A		
P6073300219KZ	K80A		
P6073300319KZ	K80A		
P6073300419KZ	K160A		
P6073300519KZ	K160A		
GILLIG			
82-11863-000	KG931R	77.931.18	57.931.18
82-206-3800	KG931R	77.931.18	57.931.18
82-283305	KH946R	78.946.18	58.946.18
82-33422-000	K122E	70.122.05	50.122.05
82-90285-000	KH946R	78.946.18	58.946.18
HD PLUS			
HKP2025	K98I	70.098.09	50.098.09
HKP2030	K125G	70.125.07	50.125.07
HKP2055	K95G	70.095.07	50.095.07
HKP2065	K50F	70.053.06	50.053.06
HKP2070	K901L	70.0901.12	50.901.12
HKP2075	K51G	70.051.07	50.051.07
HKP2080	K70G	70.070.07	50.070.07
HKP2090	K51G	70.051.07	50.051.07
HKP2095	K70F	70.073.06	50.073.06
HKP2110	K70F	70.073.06	50.073.06
HKP2115	K970R	70.970.18	50.970.18
HKP2120	K901L	70.901.12	50.901.12
HKP2125	KH901L	78.901.12	58.901.12
HKP2130	KH901L	78.901.12	58.901.12
HKP2135	KH901L	78.901.12	58.901.12
HKP2160	K921L	70.921.12	50.921.12
HKP2180	K140I	70.140.09	50.140.09
HKP2185	K75F	70.075.06	50.075.06
HKP2190	K55G	70.055.07	50.055.07
HKP2200	KH931L	78.931.12	58.931.12

Part No.	Qwik Kit	Plus Kit	Econo Kit
HD PLUS			
HKP2205	K941F	70.941.06	50.941.06
HKP2210	K95F	70.095.06	50.095.06
HKP2220	K101I	70.101.09	50.101.09
HKP2230	K108I		50.108.09
HKP2235	K139I	70.139.09	50.139.09
HKP2245	K309I	70.309.09	50.309.09
HKP2250	K941FA		
HKP2270	K931L	70.931.12	50.931.12
HKP2275	K535M		
HKP2280	K533M	70.533.13	50.533.13
HKP2285	K126W	70.126.23	50.126.23
HKP2295	KG931R	77.931.18	57.931.18
HKP2300	KG931R	77.931.18	57.931.18
HKP2305	K971R	70.971.18	50.971.18
HKP2310	K121G	70.121.07	50.121.07
HKP2315	K140I	70.140.09	50.140.09
HKP2320	K120E	70.120.05	50.120.05
HKP2335	K121E	70.121.05	50.121.05
HKP2340	K616M	70.616.13	50.616.13
HKP2345	K102I	70.102.09	50.102.09
HKP2350	K961L	70.961.12	50.961.12
HKP2355	K72F	70.072.06	50.072.06
HKP2360	K96F	70.096.06	50.096.06
HKP2365	K942F	70.942.06	50.942.06
HKP2370	K70D	70.070.04	50.070.04
HKP2375	K120E	70.120.05	50.120.05
HKP2380	K121E	70.121.05	50.121.05
HKP2390	K310I	70.310.09	50.310.09
HKP2400	K56G	70.056.07	50.056.07
HKP2635	K70D	70.070.04	50.070.04
HKP2640	K120W		
HKP2660	K125G	70.125.07	50.125.07
HKP2665	K70G	70.070.07	50.070.07
HKP2670	K70G	70.070.07	50.070.07
HKP2685	KD901R	74.901.18	54.901.18
HKP2690	KD901R	74.901.18	54.901.18
HKP2695	K95G	70.095.07	50.095.07
HKP2730	K70D	70.070.04	50.070.04
HKP2735	K70G	70.070.07	50.070.07
HKP2740	K51G	70.051.07	50.051.07
HKP2745	K51G	70.051.07	50.051.07
HKP2750	K51G	70.051.07	50.051.07
HKP2815	K970R	70.970.18	50.970.18
HKP2840	K140I	70.140.09	50.140.09
HKP2855	K55G	70.055.07	50.055.07
HKP2860	KH901L	78.901.12	58.901.12
HKP2875	K101I	70.101.09	50.101.09
HKP2880	K101I	70.101.09	50.101.09
HKP2885	K102I	70.102.09	50.102.09
HKP2890	K108I		50.108.09
HKP2895	K139I	70.139.09	50.139.09
HKP2900	K139I	70.139.09	50.139.09
HKP2905	K139I	70.139.09	50.139.09
HKP2910	K309I	70.309.09	50.309.09
HKP2915	K309I	70.309.09	50.309.09
HKP2930	K931L	70.931.12	50.931.12
HKP2935	K125W	70.125.23	50.125.23
HKP2945	K121G	70.121.07	50.121.07
HKP2950	K310I	70.310.09	50.310.09
HKP2955	K310I	70.310.09	50.310.09
HKP2970	KD901R	74.901.18	54.901.18
HKP2975	K931L	70.931.12	50.931.12
HKP2995	KH931L	78.931.12	58.931.12
HKP3000	K941F	70.941.06	50.941.06
HKP3005	K180E	70.180.05	50.180.05
HKP3010	K180E	70.180.05	50.180.05
HKP3015	K102I	70.102.09	50.102.09

King Pin Kit Interchange

HD PLUS, HENDRICKSON, IMT / INGERSOLL,
ISUZU, KENWORTH, KGI, KIMBLE,
MACK, MAN, MCI BUS, MITSUBISHI, MOOG

Part No.	Qwik Kit	Plus Kit	Econo Kit
HD PLUS			
HKP3025	K961L	70.961.12	50.961.12
HKP3030	K961L	70.961.12	50.961.12
HKP3040	K108I		50.108.09
HKP3045	K941FA		
HKP3050	K120I	70.120.09	50.120.09
HKP3055	K120I	70.120.09	50.120.09
HKP3060	K141S	70.141.19	50.141.19
HKP3065	K942FA		
HKP3070	K76F	70.076.06	50.076.06
HKP3080	K120E	70.120.05	50.120.09
HKP3085	K121E	70.121.05	50.121.05
HKP3090	K146F		
HKP3095	K180E	70.180.05	50.180.05
HKP3100	K80G		
HKP3105	K110G		
HKP3110	K120G		
HKP3125	K141S	70.141.19	50.141.19
HKP3130	K942F	70.942.06	50.942.06
HKP3135	K942FA		
HKP3150	K160S	70.160.19	50.160.19
HKP3155	K122E	70.122.05	50.122.05
HKP3160	K146E	70.146.05	50.146.05
HKP3165	K146E	70.146.05	50.146.05
HKP3170	K139I	70.139.09	50.139.09
HKP3175	K180E	70.180.05	50.180.05
HKP3190	K122V		
HKP3195	K102I	70.102.09	50.102.09
HKP3200	K160S	70.160.19	50.160.19
HKP3235	K50F	70.073.06	50.053.06
HKP3240	K901L	70.901.12	50.901.12
HKP3250	K109I		50.109.09
HKP3290	K101I	70.101.09	50.101.09
HKP3295	K139I	70.139.09	50.139.09
HKP3385	K981R	70.981.18	50.981.18
HKP3395	K146S		
HKP3450	K147E	70.147.05	50.147.05
HKP3500	K180R	70.180.18	50.180.18
HENDRICKSON			
001434	K127W	70.127.23	50.127.23
002916	K126W	70.126.23	50.126.23
003200	K120H		
003270	K120H		
006648	K131H		
60961-040			50.121.08
IMT / INGERSOLL			
700040	K700T	70.700.20	
ISUZU			
94058104	K68Z	70.068.26	
97782770	K69Z	70.069.26	
98438973	K69Z	70.069.26	
98443939	K69Z	70.069.26	
98448583	K68Z	70.068.26	
987441181	K69Z	70.069.26	
997723802	K69Z	70.069.26	
5-87830978-2	K68Z	70.068.26	
5-87830978-5	K68Z	70.068.26	
5-87831608-1	K69Z	70.069.26	
5-87832183-2	K69Z	70.069.26	
5-87832209-0	K69Z	70.069.26	
5-87832211	K69Z	70.069.26	
5-87832219-0	K69Z	70.069.26	
5-87832219-1	K69Z	70.069.26	
5-87832220-0	K69Z	70.069.26	
KENWORTH			
123	K125G	70.125.07	50.125.07
144	K125G	70.125.07	50.125.07
156	K970R	70.970.18	50.970.18
157	K970R	70.970.18	50.970.18

Part No.	Qwik Kit	Plus Kit	Econo Kit
KENWORTH			
167	K901L	70.901.12	50.901.12
168	KH901L	78.901.12	58.901.12
170	KH901L	78.901.12	58.901.12
172	K901L	70.901.12	50.901.12
195	K931L	70.931.12	50.931.12
198	KH931L	78.931.12	58.931.12
199	K921L	70.921.12	50.921.12
1300	K971R	70.971.18	50.971.18
1307	K931L	70.931.12	50.931.12
KGI			
579-1044	K150KG		
KA531	K230KG	70.230.07	
KIMBLE			
1170860	K127W	70.127.23	50.127.23
1170859	K126W	70.126.23	50.126.23
T41-12001-71	K149E		
MACK			
195	K931L	70.931.12	50.931.12
198	KH931L	78.931.12	58.931.12
205SQ12	KH901L	78.901.12	58.901.12
205SQ15	K921L	70.921.12	50.921.12
250SQ11	K125G	70.125.07	50.125.07
301SQ28E	K535M		
301SQ44	KH901L	78.901.12	58.901.12
301SQ46A	K535M		
301SQ46B	K535M		
301SQ47B	K533M	70.533.13	50.533.13
301SQ47CP1	K533M	70.533.13	50.533.13
301SQ47D	K533M	70.533.13	50.533.13
301SQ47E	K533M	70.533.13	50.533.13
301SQ52	K616M	70.616.13	50.616.13
301SQ52A	K616M	70.616.13	50.616.13
301SQ53	K536M		
312SQ46B	K535M		
50.00.336305	K75M		
MAN			
81.44205-6013	K120N		
MCI BUS			
01-01-1017	KH946R	78.946.18	58.946.18
01-01-1079	KH946R	78.946.18	58.946.18
39470254-7	K961L	70.961.12	50.961.12
IJ-2-54	KG931R	77.931.18	57.931.18
MITSUBISHI			
MC992486	K60U		
MK703748	K60U		
MOOG			
8343B	K51G	70.051.07	50.051.07
8355B	K98I	70.098.09	50.098.09
8375B	K98I	70.098.09	50.098.09
8375T	K98I	70.098.09	50.098.09
8386B	K125G	70.125.07	50.125.07
8386N	K125G	70.125.07	50.125.07
8400B	KD900R		
8400N	KD900R		
8460B	KD901R	74.901.18	54.901.18
8460N	KD901R	74.901.18	54.901.18
8462B	K95G	70.095.07	50.095.07
8462N	K95G	70.095.07	50.095.07
8464B	K51G	70.051.07	50.051.07
8467	K70D	70.070.04	50.070.04
8476B	K120W		
8478B	K535M		
8479B	K70D	70.070.04	50.070.04
8479N	K70D	70.070.04	50.070.04
8483B	K970R	70.970.18	50.970.18
8483N	K970R	70.970.18	50.970.18
8484T	K51G	70.051.07	50.051.07
8486T	K70G	70.070.07	50.070.07

Part No.	Qwik Kit	Plus Kit	Econo Kit
MOOG			
8488B	K50F	70.053.06	50.053.06
8489B	K901L	70.901.12	50.901.12
8489N	K901L	70.901.12	50.901.12
8490T	K51G	70.051.07	50.051.07
8491B	K70G	70.070.07	50.070.07
8491N	K70G	70.070.07	50.070.07
8492B	K51G	70.051.07	50.051.07
8492N	K51G	70.051.07	50.051.07
8493N	K70F	70.073.06	50.073.06
8500B	K70F	70.073.06	50.073.06
8500F	K70F	70.073.06	50.073.06
8500N	K70F	70.073.06	50.073.06
8502B	K109I		50.109.09
8504B	KD901R	74.901.18	54.901.18
8507B	K70D	70.070.04	50.070.04
8507N	K70D	70.070.04	50.070.04
8509B	KE350F	75.350.06	55.350.06
8514B	K970R	70.970.18	50.970.18
8514N	K970R	70.970.18	50.970.18
8515B	K901L	70.901.12	50.901.12
8515N	K901L	70.901.12	50.901.12
8518B	KH901L	78.901.12	58.901.12
8518N	KH901L	78.901.12	58.901.12
8519B	KD901R	74.901.18	54.901.18
8519N	KD901R	74.901.18	54.901.18
8520B	K70F	70.073.06	50.073.06
8525B	K50F	70.053.06	50.053.06
8527B	K120W		
8536B	K125G	70.125.07	50.125.07
8536N	K125G	70.125.07	50.125.07
8553B	K921L	70.921.12	50.921.12
8567B	K140I	70.140.09	50.140.09
8567N	K140I	70.140.09	50.140.09
8568B	K75F	70.075.06	50.075.06
8570B	K55G	70.055.07	50.055.07
8570N	K55G	70.055.07	50.055.07
8571B	KH931L	78.931.12	58.931.12
8571C	KH931L	78.931.12	58.931.12
8572B	K941F	70.941.06	50.941.06
8572C	K941F	70.941.06	50.941.06
8573B	K95F	70.095.06	50.095.06
8574B	KE350F	75.350.06	55.350.06
8577B	K101I	70.101.09	50.101.09
8578B	K70D	70.070.04	50.070.04
8579B	K108I		50.108.09
8581B	K139I	70.139.09	50.139.09
8581N	K139I	70.139.09	50.139.09
8583B	K309I	70.309.09	50.309.09
8583N	K309I	70.309.09	50.309.09
8585B	K941FA		
8585C	K941FA		
8589B	KE350F	75.350.06	55.350.06
8590B	K931L	70.931.12	50.931.12
8591B	K98I	70.098.09	50.098.09
8591N	K98I	70.098.09	50.098.09
8593B	K535M		
8600B	K110G		
8601B	K533M	70.533.13	50.533.13
8603B	K121G	70.121.07	50.121.07
8605B	K126W	70.126.23	50.126.23
8607B	K125W	70.125.23	50.125.23
8609B	K50F	70.053.06	50.053.06
8610B	K310I	70.310.09	50.310.09
8611B	K931L	70.931.12	50.931.12
8611C	K931L	70.931.12	50.931.12
8612B	K971R	70.971.18	50.971.18
8613B	K121G	70.121.07	50.121.07
8615B	K616M	70.616.13	50.616.13
8616C	K931L	70.931.12	50.931.12

Part No.	Qwik Kit	Plus Kit	Econo Kit
MOOG			
8617B	K140I	70.140.09	50.140.09
8618C	K120E	70.120.05	50.120.05
8627B	K56G	70.056.07	50.056.07
8627C	K56G	70.056.07	50.056.07
8629C	K71F	70.071.06	50.071.06
8631C	K121E	70.121.05	50.121.05
8633C	K180E	70.180.05	50.180.05
8635C	KG931R	77.931.18	57.931.18
8637B	K102I	70.102.09	50.102.09
8639B	K72F	70.072.06	50.072.06
8641B	K96F	70.096.06	50.096.06
8643B	K942F	70.942.06	50.942.06
8645B	K108I		50.108.09
8647B	K120E	70.120.05	50.120.05
8653B	K76F	70.076.06	50.076.06
8655B	K120I	70.120.09	50.120.09
8659B	K80G		
8660B	K110G		
8661B	K120G		
80063B	K961L	70.961.12	50.961.12
80074B	K160S	70.160.19	50.160.19
80076B	K122E	70.122.05	50.122.05
80077B	K146E	70.146.05	50.146.05
NAVISTAR			
139994R91	KD900R		
151007R91	KD901R	74.901.18	54.901.18
155932R92	K125G	70.125.07	50.125.07
1648204C91	K101I	70.101.09	50.101.09
1651921C91	K120E	70.120.05	50.120.05
1658394C91	K310I	70.310.09	50.310.09
1658934C91	K140I	70.140.09	50.140.09
1658964C91	K931L	70.931.12	50.931.12
1659687C91	K120I	70.120.09	50.120.09
1659688C91	K120I	70.120.09	50.120.09
1659934C92	K140I	70.140.09	50.140.09
1660271C91	K102I	70.102.09	50.102.09
1662305C91	K125G	70.125.07	50.125.07
1662306C91	K921L	70.921.12	50.921.12
1665531C91	K961L	70.961.12	50.961.12
1668405C91	K160S	70.160.19	50.160.19
1668411C91	K120I	70.120.09	50.120.09
1668411C92	K120I	70.120.09	50.120.09
1668412C91	K141S	70.141.19	50.141.19
1668412C92	K141S	70.141.19	50.141.19
1685405C91	K160S	70.160.19	50.160.19
229265R91	K970R	70.970.18	50.970.18
2500542C91	K981R	70.981.18	50.981.18
2505823C91	K120R	70.120.18	50.120.18
2505492C91	K961L	70.961.12	50.961.12
2505494C91	K961L	70.961.12	50.961.12
2505495C91	K180R	70.180.18	50.180.18
2505496C91	K181R	70.181.18	50.181.18
2505823C91	K120R	70.120.18	50.120.18
2603340C91	KG931R	77.931.18	57.931.18
2612737C1	K103S	70.103.19	50.103.19
303136C91	KD901R	74.901.18	54.901.18
303136C92	KD901R	74.901.18	54.901.18
303137C92	K125G	70.125.07	50.125.07
303138C92	K970R	70.970.18	50.970.18
303138R92	K970R	70.970.18	50.970.18
303139C92	K901L	70.901.12	50.901.12
303140C91	KH901L	78.901.12	58.901.12
303140C92	KH901L	78.901.12	58.901.12
303140C93	KH901L	78.901.12	58.901.12
306920C91	K109I		50.109.09
306920C92	K109I		50.109.09
3532356C91	K120I	70.120.09	50.120.09
3545386C92	K120I	70.120.09	50.120.09

Part No.	Qwik Kit	Plus Kit	Econo Kit
NAVISTAR			
3564519C91	K103S	70.103.19	50.103.19
3573204C91	K103S	70.103.19	50.103.19
3573205C91	K103S	70.103.19	50.103.19
371416C91	K970R	70.970.18	50.970.18
399942C93	K140I	70.140.09	50.140.09
408547C91	K109I		50.109.09
408547C93	K109I		50.109.09
452344C91	K921L	70.921.12	50.921.12
470572C91	K309I	70.309.09	50.309.09
470752C91	K309I	70.309.09	50.309.09
472093C91	K109I		50.109.09
472094C91	K139I	70.139.09	50.139.09
472095C91	K101I	70.101.09	50.101.09
473695C91	K101I	70.101.09	50.101.09
474520C91	KH931L	78.931.12	58.931.12
491611C91	K139I	70.139.09	50.139.09
491611C92	K139I	70.139.09	50.139.09
493092C91	K108I		50.108.09
493094C91	K139I	70.139.09	50.139.09
493094C92	K139I	70.139.09	50.139.09
493095C91	K309I	70.309.09	50.309.09
507838C91	KH931L	70.931.12	50.931.12
549800C91	K931L	70.931.12	50.931.12
577684C91	K971R	70.971.18	50.971.18
579370C92	K310I	70.310.09	50.310.09
586806C91	K310I	70.310.09	50.310.09
588808C91	K140I	70.140.09	50.140.09
590831C91	K140I	70.140.09	50.140.09
591945C91	K109I		50.109.09
597258C91	KH931L	78.931.12	58.931.12
597556C91	K931L	70.931.12	50.931.12
61556R91	K98I	70.098.09	50.098.09
69576R92	K125G	70.125.07	50.125.07
870148R91	K901L	70.901.12	50.901.12
870148R92	K901L	70.901.12	50.901.12
966157R91	KH901L	78.901.12	58.901.12
966157R92	KH901L	78.901.12	58.901.12
974021R91	K125G	70.125.07	50.125.07
NEO PLAN			
KL0800000-025	K162S		
NEW FLYER			
6313078	K120N		
6330169	KH946R	78.946.18	58.946.18
NEW STAR S & S			
S-3596	K108I		50.108.09
S-3682	K55G	70.055.07	50.055.07
S-4483	K120I	70.120.09	50.120.09
S-4948	K139I	70.139.09	50.139.09
S-4949	K309I	70.309.09	50.309.09
S-4988	K140I	70.140.09	50.140.09
S-4996	K98I	70.098.09	50.098.09
S-5134	K310I	70.310.09	50.310.09
S-5223	K101I	70.101.09	50.101.09
S-6072	K533M	70.533.13	50.533.13
S-6073	K616M	70.616.13	50.616.13
S-6485	K120E	70.120.05	50.120.05
S-6486	K121E	70.121.05	50.121.05
S-6488	K70F	70.073.06	50.073.06
S-6492	K70D	70.070.04	50.070.04
S-6494	K70F	70.073.06	50.073.06
S-6501	KE350F	75.350.06	55.350.06
S-6502	K941F	70.941.06	50.941.06
S-6503	K95F	70.095.06	50.095.06
S-6504	K75F	70.075.06	50.075.06
S-6634	K51G	70.051.07	50.051.07
S-6635	K70G	70.070.07	50.070.07
S-6643	K121G	70.121.07	50.121.07
S-6663	K109I		50.109.09

Part No.	Qwik Kit	Plus Kit	Econo Kit
NEW STAR S & S			
S-6938	KD901R	74.901.18	54.901.18
S-6939	K125G	70.125.07	50.125.07
S-6942	K970R	70.970.18	50.970.18
S-6943	K970R	70.970.18	50.970.18
S-6944	K901L	70.901.12	50.901.12
S-6945	KH901L	78.901.12	58.901.12
S-6946	KH901L	78.901.12	58.901.12
S-6947	K901L	70.901.12	50.901.12
S-6948	K931L	70.931.12	50.931.12
S-6949	KH931L	78.931.12	58.931.12
S-6950	K921L	70.921.12	50.921.12
S-6963	K971R	70.971.18	50.971.18
S-6964	K931L	70.931.12	50.931.12
S-6965	KG931R	77.931.18	57.931.18
S-7190	K120W		
S-7191	K126W	70.126.23	50.126.13
S-7463	K140I	70.140.09	50.140.09
S-7721	K70G	70.070.07	50.070.07
S-7801	K140I	70.140.09	50.140.09
S-8371	K120E	70.120.05	50.120.05
S-8513	KG931R	77.931.18	57.931.18
S-8529	KH931L	78.931.12	58.931.12
S-8678	K961L	70.961.12	50.961.12
S-9304	K102I	70.102.09	50.102.09
S-9365	K180E	70.180.05	50.180.05
S-9722	K55G	70.055.07	50.055.07
S-A482	K102I	70.102.09	50.102.09
S-A483	K120I	70.120.09	50.120.09
S-A484	K141S	70.141.19	50.141.19
S-A811	K120I	70.120.09	50.120.09
S-C119	K981R	70.981.18	50.981.18
S-C464	K122E	70.122.05	50.122.05
S-D562	K122E	70.122.05	50.122.05
S-D819	K120G		
S-F091	K80G		
S-F092	K110G		
S-F187	K180E	70.180.05	50.180.05
OTTAWA			
90013937	K961L	70.961.12	50.961.12
PETERBILT			
123	K125G	70.125.07	50.125.07
144	K125G	70.125.07	50.125.07
156	K970R	70.970.18	50.970.18
157	K970R	70.970.18	50.970.18
167	K901L	70.901.12	50.901.12
168	KH901L	78.901.12	58.901.12
170	KH901L	78.901.12	58.901.12
172	K901L	70.901.12	50.901.12
195	K931L	70.931.12	50.931.12
198	KH931L	78.931.12	58.931.12
199	K921L	70.921.12	50.921.12
1300	K971R	70.971.18	50.971.18
1303	K971R	70.971.18	50.971.18
RIDEWELL			
1660106	KG931R	77.931.18	57.931.18
1667325B034	K127W	70.127.23	50.127.23
ROCKWELL			
17110	KG931R	77.931.18	57.931.18
17111	KG931R	77.931.18	57.931.18
R200001	K51G	70.051.07	50.051.07
R200003	K98I	70.098.09	50.098.09
R200011	K95G	70.095.07	50.095.07
R200017	K120W		
R200018	K50F	70.053.06	50.053.06
R200022	K95G	70.095.07	50.095.07
R200024	K70G	70.070.07	50.070.07
R200025	K70G	70.070.07	50.070.07
R200026	K51G	70.051.07	50.051.07

King Pin Kit Interchange

Part No.	Qwik Kit	Plus Kit	Econo Kit
ROCKWELL			
R200027	K51G	70.051.07	50.051.07
R200028	K70F	70.073.06	50.073.06
R200029	K70F	70.073.06	50.073.06
R200031	K109I		50.109.09
R200034	K109I		50.109.09
R200042	K140I	70.140.09	50.140.09
R200043	K140I	70.140.09	50.140.09
R200044	K75F	70.075.06	50.075.06
R200045	K55G	70.055.07	50.055.07
R200046	K55G	70.055.07	50.055.07
R200049	KE350F	75.350.06	55.350.06
R200050	K95F	70.095.06	50.095.06
R200051	K941F	70.941.06	50.941.06
R200052	K101I	70.101.09	50.101.09
R200054	K108I		50.108.09
R200055	K139I	70.139.09	50.139.09
R200056	K139I	70.139.09	50.139.09
R200057	K309I	70.309.09	50.309.09
R200058	K309I	70.309.09	50.309.09
R200061	K941FA		
R200062	KE350F	75.350.06	55.350.06
R200064	K535M		
R200065	K533M	70.533.13	50.533.13
R200066	K121G	70.121.07	50.121.07
R200067	K125W	70.125.23	50.125.23
R200068	K126W	70.126.23	50.126.23
R200071	K616M	70.616.13	50.616.13
R200073	K310I	70.310.09	50.310.09
R200074	K140I	70.140.09	50.140.09
R200075	K139I	70.139.09	50.139.09
R200121	K170G		
R200123	K125G	70.125.07	50.125.07
R200136	KD900R		
R200138	KD901R	74.901.18	54.901.18
R200141	KD900R		
R200142	KD901R	74.901.18	54.901.18
R200143	K70D	70.070.04	50.070.04
R200144	K125G	70.125.07	50.125.07
R200145	K170G		
R200152	K125G	70.125.07	50.125.07
R200154	KD901R	74.901.18	54.901.18
R200155	K70D	70.070.04	50.070.04
R200156	K970R	70.970.18	50.970.18
R200157	K970R	70.970.18	50.970.18
R200163	K901L	70.901.12	50.901.12
R200167	K901L	70.901.12	50.901.12
R200168	KH901L	78.901.12	58.901.12
R200170	KH901L	78.901.12	58.901.12
R200172	K901L	70.901.12	50.901.12
R200174	K109I		50.109.09
R200184	KD901R	74.901.18	54.901.18
R200186	K125G	70.125.07	50.125.07
R200188	K970R	70.970.18	50.970.18
R200189	KH901L	78.901.12	58.901.12
R200190	K901L	70.901.12	50.901.12
R200191	KH901L	78.901.12	58.901.12
R200193	K921L	70.921.12	50.921.12
R200195	K931L	70.931.12	50.931.12
R200198	KH931L	78.931.12	58.931.12
R200199	K921L	70.921.12	50.921.12
R200234	KD900R		
R200250	K180E	70.180.05	50.180.05
R200251	K121E	70.121.05	50.121.05
R200267	K120E	70.120.05	50.120.05
R200268	K102I	70.102.09	50.102.09
R200269	K120E	70.120.05	50.120.05
R200270	K121E	70.121.05	50.121.05
R200271	K51G	70.051.07	50.051.07
R200272	K72F	70.072.06	50.072.06

Part No.	Qwik Kit	Plus Kit	Econo Kit
ROCKWELL			
R200273	K942F	70.942.06	50.942.06
R200274	K941F	70.941.06	50.941.06
R200275	K96F	70.096.06	50.096.06
R200276	K941F	70.941.06	50.941.06
R200277	K108I		50.108.09
R200278	K140I	70.140.09	50.140.09
R200279	K160S	70.160.19	50.160.19
R200280	K76F	70.076.06	50.076.06
R200281	K122E	70.122.05	50.122.05
R200282	K80G		
R200283	K110G		
R200284	K120G		
R200285	KH931L	78.931.12	58.931.12
R2002916	K127W	70.127.23	50.127.23
R200300	K56G	70.056.07	50.056.07
R201300	K971R	70.971.18	50.971.18
R201303	K970R	70.970.18	50.970.18
R201307	K931L	70.931.12	50.931.12
R201309	KG931R	77.931.18	57.931.18
R201310	KG931R	77.931.18	57.931.18
R201312	KH931L	78.931.12	58.931.12
R201314	K70D	70.070.04	50.070.04
R201315	K961L	70.961.12	50.961.12
R201318	K941R	70.941.18	50.941.18
R201319	KG931R	77.931.18	57.931.18
R201320	K71D	70.071.04	50.071.04
R201370	K931L	70.931.12	50.931.12
R201419	K981R	70.981.18	50.981.18
R201420	KH946R	78.946.18	58.946.18
R201424	KH946R	78.946.18	58.946.18
R201425	KG931R	77.931.18	57.931.18
R201426	K120I	70.120.09	50.120.09
R201427	K141S	70.141.19	50.141.19
R201470	K961L	70.961.12	50.961.12
R201471	KG931R	77.931.18	57.931.18
R201472	K981R	70.981.18	50.981.18
R201473	K120R	70.120.18	50.120.18
R201474	K80R	70.080.18	50.080.18
R201475	K180R	70.180.18	50.180.18
R201476	K181R	70.181.18	50.181.18
R201477	KH931L	78.931.12	58.931.12
R201478	K60R		
R201479	K70R	70.070.18	50.070.18
R201483	K70R	70.070.18	50.070.18
R201484	K80R	70.080.18	50.080.18
R201490	K981R	70.981.18	50.981.18
R201600	K56G	70.056.07	50.056.07
R201601	K71F	70.071.06	50.071.06
R201602	K56G	70.056.07	50.056.07
R201604	K80R	70.080.18	50.080.18
R201605	K80R	70.080.18	50.080.18
R201606	K80R	70.080.18	50.080.18
SEALED POWER			
808-391C	K51G	70.051.07	50.051.07
808-401N	K98I	70.098.09	50.098.09
808-463	K95G	70.095.07	50.095.07
808-477	K70D	70.070.04	50.070.04
808-479	K120W		
808-489	K125G	70.125.07	50.125.07
808-492	K70G	70.070.07	50.070.07
808-493	K50F	70.053.06	50.053.06
808-496	KD901R	74.901.18	54.901.18
808-496B	KD901R	74.901.18	54.901.18
808-499	K95G	70.095.07	50.095.07
808-503	K70D	70.070.04	50.070.04
808-504	K901L	70.901.12	50.901.12
808-506	K70G	70.070.07	50.070.07
808-506B	K70G	70.070.07	50.070.07
808-507	K51G	70.051.07	50.051.07

Part No.	Qwik Kit	Plus Kit	Econo Kit
SEALED POWER			
808-507B	K51G	70.051.07	50.051.07
808-509	K70F	70.073.06	50.073.06
808-509B	K70F	70.073.06	50.073.06
808-510B	K901L	70.901.12	50.901.12
808-516	K109I		50.109.09
808-524B	K109I		50.109.09
808-526B	K970R	70.970.18	50.970.18
808-526D	K970R	70.970.18	50.970.18
808-534B	K921L	70.921.12	50.921.12
808-535B	K140I	70.140.09	50.140.09
808-535D	K140I	70.140.09	50.140.09
808-538	K75F	70.075.06	50.075.06
808-538B	K75F	70.075.06	50.075.06
808-539	K55G	70.055.07	50.055.07
808-539D	K55G	70.055.07	50.055.07
808-540B	K55G	70.055.07	50.055.07
808-541B	KH901L	78.901.12	58.901.12
808-542D	KH901L	78.901.12	58.901.12
808-545B	KE350F	75.350.06	55.350.06
808-546B	K95F	70.095.06	50.095.06
808-547B	KH931L	78.931.12	58.931.12
808-548B	K941F	70.941.06	50.941.06
808-549B	K101I	70.101.09	50.101.09
808-551B	K108I		50.108.09
808-552B	K139I	70.139.09	50.139.09
808-553D	K139I	70.139.09	50.139.09
808-554B	K309I	70.309.09	50.309.09
808-555D	K309I	70.309.09	50.309.09
808-558B	K941F	70.941.06	50.941.06
808-559B	KE350F	75.350.06	55.350.06
808-561B	K535M		
808-562B	K533M	70.533.13	50.533.13
808-563B	K931L	70.931.12	50.931.12
808-564B	K126W	70.126.23	50.126.23
808-565B	K125W	70.125.23	50.125.23
808-567B	K121G	70.121.07	50.121.07
808-570B	K971R	70.971.18	50.971.18
SPICER			
328342	K122E	70.122.05	50.122.05
328343	K146E	70.146.05	50.146.05
328344	K122E	70.122.05	50.122.05
328345	K146E	70.146.05	50.146.05
328346	K123E	70.123.05	50.123.05
328347	K147E	70.147.05	50.147.05
328348	K123E	70.123.05	50.123.05
328349	K147E	70.147.05	50.147.05
329022	K141S	70.141.19	50.141.19
329023	K160S	70.160.19	50.160.19
329116	K162S		
329182	K103S	70.103.19	50.103.19
329404	K146E	70.146.05	50.146.05
329405	K146E	70.146.05	50.146.05
329432	K180E	70.180.05	50.180.05
331434	K200S		
331435	K201S		
503701	K147E	70.147.05	50.147.05
806355	K120E	70.120.05	50.120.05
811525	K180E	70.180.05	50.180.05
101KK100	K101I	70.101.09	50.101.09
101KK109	K101I	70.101.09	50.101.09
101KK110	K101I	70.101.09	50.101.09
101KK111	K102I	70.102.09	50.102.09
101KK113	K101I	70.101.09	50.101.09
120KK100	K120I	70.120.09	50.120.09
120KK102	K146S		
140KK100	K141S	70.141.19	50.141.19
151KK101	K160S	70.160.19	50.160.19
161KK100	K161S		

Part No.	Qwik Kit	Plus Kit	Econo Kit
SPICER			
220KK100	K160S	70.160.19	50.160.19
309KK102	K310I	70.310.09	50.310.09
309KK103	K310I	70.310.09	50.310.09
309KK105	K140I	70.140.09	50.140.09
337KK100	K309I	70.309.09	50.309.09
337KK101	K139I	70.139.09	50.139.09
337KK103	K309I	70.309.09	50.309.09
337KK104	K139I	70.139.09	50.139.09
343KK100	K140I	70.140.09	50.140.09
KPK1001			50.121.08
KPK1002	K120A		
KPK1003	K120A		
KPK1004	K160A		
KPK1005	K160A		
KPK1006	K40D		
KPK1007	K50D	70.050.04	50.050.04
KPK1008	K70D	70.070.04	50.070.04
KPK1014	K50D	70.050.04	50.050.04
KPK1015	K50D	70.050.04	50.050.04
KPK1020	K170G		
KPK1025	K70F	70.073.06	50.073.04
KPK1026	K70F	70.073.06	50.073.04
KPK1029	K70D	70.070.04	50.070.04
KPK1030	K901L	70.901.12	50.901.12
KPK1042	K941F	70.941.06	50.941.06
KPK1043	K941F	70.941.06	50.941.06
KPK1044	K95F	70.095.06	50.095.06
KPK1045	KE350F	75.350.06	55.350.06
KPK1046	K941FA		
KPK1047	KE350F	75.350.06	55.350.06
KPK1051	K71F	70.071.06	50.071.06
KPK1052	K72F	70.072.06	50.076.06
KPK1053	K942F	70.942.06	50.942.06
KPK1054	K96F	70.096.06	50.096.06
KPK1055	K941F	70.941.06	50.941.06
KPK1056	K71F	70.071.06	50.071.06
KPK1057	K76F	70.076.06	50.076.06
KPK1058	K942FA		
KPK1062	K95G	70.095.07	50.095.07
KPK1063	K95G	70.095.07	50.095.07
KPK1067	K70G	70.070.07	50.070.07
KPK1068	K80R	70.080.18	70.080.18
KPK1069	K70G	70.070.07	50.070.07
KPK1073	K55G	70.055.07	50.055.07
KPK1075	K55G	70.055.074	50.055.07
KPK1076	K310I	70.310.09	50.310.09
KPK1077	K121G	70.121.07	50.121.07
KPK1078	K971R	70.971.18	50.971.18
KPK1080	K56G	70.056.07	50.056.07
KPK1082	K56G	70.056.07	50.56.07
KPK1083	K80G		
KPK1084	K110G		
KPK1085	K120G		
KPK1086	K981R	70.981.18	50.981.18
KPK1088	K901L	70.901.12	50.901.12
KPK1089	K109I		50.109.09
KPK1092	K970R	70.970.18	50.970.18
KPK1093	K109I		50.109.09
KPK1094	K140I	70.140.09	50.140.09
KPK1095	K108I		50.108.09
KPK1096	K139I	70.139.09	50.139.09
KPK1097	K309I	70.309.09	50.309.09
KPK1098	K981R	70.981.18	50.981.18
KPK1102	K108I		50.108.09
KPK1105	K535M		
KPK1106	K533M	70.533.13	50.533.13
KPK1108	K616M	70.616.13	50.616.13
KPK1109	K536M		
KPK1110	K125G	70.125.07	50.125.07

Part No.	Qwik Kit	Plus Kit	Econo Kit
SPICER			
KPK1111	KD901R	70.901.18	50.901.18
KPK1112	KH901L	78.901.12	58.901.12
KPK1113	KH901L	78.901.12	58.901.12
KPK1114	K970R	70.970.18	50.970.18
KPK1115	K921L	70.921.12	50.921.12
KPK1116	KH931L	78.931.12	58.931.12
KPK1117	K931L	70.931.12	50.931.12
KPK1118	KG931R	77.931.18	57.931.18
KPK1119	K931L	70.931.12	50.931.12
KPK1120	KG931R	77.931.18	57.931.18
KPK1121	KH931L	78.931.12	58.931.12
KPK1122	K961L	70.961.12	50.961.12
KPK1123	K961L	70.961.12	50.961.12
KPK1124	K180R	70.180.18	50.180.18
KPK1128	K120W		
KPK1130	K126W	70.126.23	50.126.23
KPK1131	K125W	70.125.23	50.125.23
KPK1134	K140I	70.140.09	50.140.09
KPK1136	K101I	70.101.09	50.101.09
KPK1147	KD900R		
KPK1148	K121E	70.121.05	50.121.05
STEMCO KAISER			
	K101I	70.101.09	50.101.09
	K102I	70.102.09	50.102.09
	K103S	70.103.19	50.103.19
	K108I		50.108.09
	K109I		50.109.09
	K120E	70.120.05	50.120.05
	K120I	70.120.09	50.120.09
	K120R	70.120.18	50.120.18
	K121E	70.121.05	50.121.05
	K121G	70.121.07	50.121.07
	K122E	70.122.05	50.122.05
	K123E	70.123.05	50.123.05
	K125G	70.125.07	50.125.07
	K125W	70.125.23	50.125.23
	K126W	70.126.23	50.126.23
	K127W	70.127.23	50.127.23
	K139I	70.139.09	50.139.09
	K140I	70.140.09	50.140.09
	K141S	70.141.19	50.141.19
	K146E	70.146.05	50.146.05
	K147E	70.147.05	50.147.05
	K160S	70.160.19	50.160.19
	K180E	70.180.05	50.180.05
	K180R	70.180.18	50.180.18
	K181R	70.181.18	50.181.18
	K309I	70.309.09	50.309.09
	K310I	70.310.09	50.310.09
	K50F	70.053.06	50.053.06
	K51G	70.051.07	50.051.07
	K533M	70.533.13	50.533.13
	K55G	70.055.07	50.055.07
	K56G	70.056.07	50.056.07
	K616M	70.616.13	50.616.13
	K68Z	70.068.26	
	K69Z	70.069.26	
	K70D	70.070.04	50.070.04
	K70F	70.073.06	50.073.06
	K70G	70.070.07	50.070.07
	K70R	70.070.18	50.070.18
	K70D	70.071.04	50.071.04
	K71F	70.071.06	50.071.06
	K72F	70.072.06	50.072.06
	K75F	70.075.06	50.075.06
	K76F	70.076.06	50.076.06
	K80R	70.080.18	50.080.18
	K901L	70.901.12	50.901.12
	K921L	70.921.12	50.921.12

Part No.	Qwik Kit	Plus Kit	Econo Kit
STEMCO KAISER			
	K931L	70.931.12	50.931.12
	K941F	70.941.06	50.941.06
	K941R	70.941.18	50.941.18
	K942F	70.942.06	50.942.06
	K95F	70.095.06	50.095.06
	K95G	70.095.07	50.095.07
	K961L	70.961.12	50.961.12
	K96F	70.096.06	50.096.06
	K970R	70.970.18	50.970.18
	K971R	70.971.18	50.971.18
	K981R	70.981.18	50.981.18
	K98I	70.098.09	50.098.09
	KD901R	74.901.18	54.901.18
	KE350F	75.350.06	55.350.06
	KG931R	77.931.18	57.931.18
	KH901L	78.901.12	58.901.12
	KH931F	78.931.06	58.931.06
	KH931L	78.931.12	58.931.12
	KH946R	78.946.18	58.946.18
THOMAS BUS			
8314171	K102I	70.102.09	50.102.09
1307	K931L	70.931.12	50.931.12
1309	KG931R	77.931.18	57.931.18
1310	KG931R	77.931.18	57.931.18
P6073300019KZ	K120A		
P6073300119KZ	K120A		
TRAYER / ROAD LEVELER			
TK257	K98I	70.098.09	50.098.09
TK331	K51G	70.051.07	50.051.07
TK331B	K51G	70.051.07	50.051.07
TK336	K98I	70.098.09	50.098.09
TK406	K95G	70.095.07	50.095.07
TK407	KD900R		
TK422	K125G	70.125.07	50.125.07
TK443	K120W		
TK461	K50F	70.053.06	50.053.06
TK462	K70G	70.070.07	50.070.07
TK463	K51G	70.051.07	50.051.07
TK464	K901L	70.901.12	50.901.12
TK467	K95G	70.095.07	50.095.07
TK472	K51G	70.051.07	50.051.07
TK472B	K51G	70.051.07	50.051.07
TK473	K70G	70.070.07	50.070.07
TK473B	K70G	70.070.07	50.070.07
TK475	K51G	70.051.07	50.051.07
TK480	K70D	70.070.04	50.070.04
TK481	K70D	70.070.04	50.070.04
TK482	K901L	70.901.12	50.901.12
TK483	K70F	70.073.06	50.073.06
TK483B	K70F	70.073.06	50.073.06
TK490	K109I		50.109.09
TK496	KD901R	74.901.18	54.901.18
TK497	K70D	70.070.04	50.070.04
TK498	K70D	70.070.04	50.070.04
TK506	K970R	70.970.18	50.970.18
TK507	K901L	70.901.12	50.901.12
TK509	K970R	70.970.18	50.970.18
TK510	KD901R	74.901.18	54.901.18
TK512	KH901L	78.901.12	58.901.12
TK513	KH901L	78.901.12	58.901.12
TK514	K970R	70.970.18	50.970.18
TK515	K70F	70.073.06	50.073.06
TK525	K921L	70.921.12	50.921.12
TK537	K75F	70.075.06	50.075.06
TK538	KH931L	78.931.12	58.931.12
TK539	K941F	70.941.06	50.941.06
TK540	K95F	70.095.06	50.095.06
TK541	K55G	70.055.07	50.055.07
TK541B	K55G	70.055.07	50.055.07

King Pin Kit Interchange

Part No.	Qwik Kit	Plus Kit	Econo Kit
TRAYER / ROAD LEVELER			
TK542	KE350F	75.350.06	55.350.06
TK546	K101I	70.101.09	50.101.09
TK546B	K101I	70.101.09	50.101.09
TK547	K941FA		
TK548	K108I		50.108.09
TK549	K139I	70.139.09	50.139.09
TK549B	K139I	70.139.09	50.139.09
TK550	K309I	70.309.09	50.309.09
TK550B	K309I	70.309.09	50.309.09
TK551	K931L	70.931.12	50.931.12
TK553	KE350F	75.350.06	55.350.06
TK554B	K98I	70.098.09	50.098.09
TK556	K535M		
TK557	K533M	70.533.13	50.533.13
TK558	K121G	70.121.07	50.121.07
TK560	K125W	70.125.23	50.125.23
TK561	K126W	70.126.23	50.126.23
TK562	K50F	70.053.06	50.053.06
TK566	K616M	70.616.13	50.616.13
TK567	K310I	70.310.09	50.310.09
TK567B	K310I	70.310.09	50.310.09
TK568	KG931R	77.931.18	57.931.18
TK569	K931L	70.931.12	50.931.12
TK570	K971R	70.971.18	50.971.18
TK571	K140I	70.140.09	50.140.09
TK589	K120E	70.120.05	50.120.05
TK590	KH931L	78.931.12	58.931.12
TK592	K56G	70.056.07	50.056.07
TK594	K71F	70.071.06	50.071.06
TK596	K121E	70.121.05	50.121.05
TK597	K72F	70.072.06	50.072.06
TK598	K942F	70.942.06	50.942.06
TK599	K96F	70.096.06	50.096.06
TK600	K941F	70.941.06	50.941.06
TK601	K941F	70.941.06	50.941.06
TK602	K180E	70.180.05	50.180.05
TK603	K102I	70.102.09	50.102.09
TK603B	K102I	70.102.09	50.102.09
TK604	K961L	70.961.12	50.961.12
TK605	K108I		50.108.09
TK606	K140I	70.140.09	50.140.09
TK608	K51G	70.051.07	50.051.07
TK609	K120E	70.120.05	50.120.05
TK610	K121E	70.121.05	50.121.05
TK611	K56G	70.056.07	50.056.07
TK613	K70D	70.070.04	50.070.04
TK614	K70G	70.070.07	50.070.07
TK616	K70D	70.070.04	50.070.04
TK624	K70G	70.070.07	50.070.07
TK626	K103S	70.103.19	50.103.19
TK632	K71F	70.071.06	50.071.06
TK633	K180E	70.180.05	50.180.05
TK634	K961L	70.961.12	50.961.12
TK635	K120I	70.120.09	50.120.09
TK635B	K120I	70.120.09	50.120.09
TK636	K141S	70.141.19	50.141.19
TK637	K76F	70.076.06	50.076.06
TK638	K942FA		
TK640	K80G		
TK641	K110G		
TK642	K120G		
TK645	K102I	70.102.09	50.102.09
TK646	K120I	70.120.09	50.120.09
TK652	K122E	70.122.05	50.122.05
TK653	K180E	70.180.05	50.180.05
TK654	K146E	70.146.05	50.146.05
TK716	K122E	70.122.05	50.122.05
TK750	K536M		

Part No.	Qwik Kit	Plus Kit	Econo Kit
TRAYER / ROAD LEVELER			
K391C	K51G	70.051.07	50.051.07
K391N	K51G	70.051.07	50.051.07
K401N	K98I	70.098.09	50.098.09
TRW			
K450	K125G	70.125.07	50.125.07
K459	KD900R		
K463	K95G	70.095.07	50.095.07
K465	KD901R	74.901.18	54.901.18
K477	K70D	70.070.04	50.070.04
K478	KD900R		
K479	K120W		
K482	K70D	70.070.04	50.070.04
K487	K535M		
K487B	K535M		
K489	K125G	70.125.07	50.125.07
K491	K51G	70.051.07	50.051.07
K491N	K51G	70.051.07	50.051.07
K492	K70G	70.070.07	50.070.07
K493	K50F	70.053.06	50.053.06
K494	K970R	70.970.18	50.970.18
K496	KD901R	74.901.18	54.901.18
K496B	KD901R	74.901.18	54.901.18
K499	K95G	70.095.07	50.095.07
K503	K70D	70.070.04	50.070.04
K504	K901L	70.901.12	50.901.12
K505	K970R	70.970.18	50.970.18
K505B	K970R	70.970.18	50.970.18
K506	K70G	70.070.07	50.070.07
K506B	K70G	70.070.07	50.070.07
K507	K51G	70.051.07	50.051.07
K507B	K51G	70.051.07	50.051.07
K508	K70F	70.073.06	50.053.06
K509	K70F	70.073.06	50.053.06
K509B	K70F	70.073.06	50.053.06
K510B	K901L	70.901.12	50.901.12
K516	K109I		50.109.09
K523B	K140I	70.140.09	50.140.09
K524B	K109I		50.109.09
K526B	K970R	70.970.18	50.970.18
K526D	K970R	70.970.18	50.970.18
K534B	K921L	70.921.12	50.921.12
K535B	K140I	70.140.09	50.140.09
K535D	K140I	70.140.09	50.140.09
K536B	K70G	70.070.07	50.070.07
K538B	K75F	70.075.06	50.075.06
K539D	K55G	70.055.07	50.055.07
K540B	K55G	70.055.07	50.055.07
K541B	KH901L	78.901.12	58.901.12
K542D	KH901L	78.901.12	58.901.12
K545B	KE350F	75.350.06	55.350.06
K546B	K95F	70.095.06	50.095.06
K547B	KH931L	78.931.12	58.931.12
K548B	K941F	70.941.06	50.941.06
K549B	K101I	70.101.09	50.101.09
K551B	K108I		50.108.09
K552B	K139I	70.139.09	50.139.09
K553D	K139I	70.139.09	50.139.09
K554B	K309I	70.309.09	50.309.09
K555D	K309I	70.309.09	50.309.09
K558B	K941FA		
K559B	KE350F	75.350.06	55.350.06
K561B	K535M		
K562B	K533M	70.533.13	50.533.13
K563B	K931L	70.931.12	50.931.12
K564B	K125W	70.125.23	50.125.23
K565B	K126W	70.126.23	50.126.23
K567B	K121G	70.121.07	50.121.07
K570B	K971R	70.971.18	50.971.18
K571B	K310I	70.310.09	50.310.09

Part No.	Qwik Kit	Plus Kit	Econo Kit
TRW			
K572B	K140I	70.140.09	50.140.09
K574B	K616M	70.616.13	50.616.13
K575B	KD900R		
K576C	K931L	70.931.12	50.931.12
K577C	K56G	70.056.07	50.056.07
K578B	K71F	70.071.06	50.071.06
K582	KG931R	77.931.18	57.931.18
K583	KG931R	77.931.18	57.931.18
K584	K120E	70.120.05	50.120.05
K585	KH931L	78.931.12	58.931.12
K586	K121E	70.121.05	50.121.05
K587	K72F	70.072.06	50.072.06
K588	K942F	70.942.06	50.942.06
K589	K96F	70.096.06	50.096.06
K590	K941F	70.941.06	50.941.06
K591B	K180E	70.180.05	50.180.05
K592	K102I	70.102.09	50.102.09
K593	K961L	70.961.12	50.961.12
K594	K140I	70.140.09	50.140.09
K595	K108I		50.108.09
K596	K941F	70.941.06	50.941.06
K602	K120I	70.120.09	50.120.09
K602C	K120I	70.120.99	50.120.09
K603C	K141S	70.141.19	50.141.19
K606C	K942FA		
K607B	K76F	70.076.06	50.076.06
K608	K51G	70.051.07	50.051.07
K609	K120E	70.120.05	50.120.05
K610	K121E	70.121.05	50.121.05
K611	K56G	70.056.07	50.056.07
K612B	K146F		
K617	K180E	70.180.05	50.180.05
K618C	K80G		
K619C	K110G		
K620	K120G		
K623C	K141S	70.141.19	50.141.19
K624C	K942F	70.942.06	50.942.06
K627C	K160S	70.160.19	50.160.19
K628	K122E	70.122.05	50.122.05
TW			
FKP102C	K56G	70.056.07	50.056.07
FKP105B	K941F	70.941.06	50.941.06
FKP115B	K120E	70.120.05	50.120.05
FKP39B	K70G	70.070.07	50.070.07
FKP68B	K140I	70.140.09	50.140.09
FKP77B	K139I	70.139.09	50.139.09
FKP85B	K533M	70.533.13	50.533.13
FKP86B	K121G	70.121.07	50.121.07
FKP90B	K931L	70.931.12	50.931.12
FKP94B	K616M	70.616.13	50.616.13
FKP98B	K120E	70.120.05	50.120.05
123	K125G	70.125.07	50.125.07
138	KD901R	74.901.18	54.901.18
142	KD901R	74.901.18	54.901.18
VOLVO-WHITE			
143	K70D	70.070.04	50.070.04
144	K125G	70.125.07	50.125.07
154	KD901R	74.901.18	54.901.18
155	K70D	70.070.04	50.070.04
156	K970R	70.970.18	50.970.18
157	K970R	70.970.18	50.970.18
167	K901L	70.901.12	50.901.12
168	KH901L	78.901.12	58.901.12
170	KH901L	78.901.12	58.901.12
172	K901L	70.901.12	50.901.12
195	K931L	70.931.12	50.931.12
198	KH931L	78.931.12	58.931.12
199	K921L	70.921.12	50.921.12

Part No.	Qwik Kit	Plus Kit	Econo Kit
VOLVO-WHITE			
1300	K971R	70.971.18	50.971.18
1307	K931L	70.931.12	50.931.12
216446	K120W		
216677	KD901R	74.901.18	54.901.18
217175	K125W	70.125.23	50.125.23
836687	K125G	70.125.07	50.125.07
857328	K125G	70.125.07	50.125.07
859552	K970R	70.970.18	50.970.18
1115275	K961L	70.961.12	50.961.12
1715442	K970R	70.970.18	50.970.18
1720728	KH901L	78.901.12	58.901.12
1739844	KH901L	78.901.12	58.901.12
20751021			50.121.08
3009155	K901L	70.901.12	50.901.12
3090266	K140V		
3090267	K122V		
3093704	K981R	70.981.18	50.981.18
3130711	K122V		
3133649	K121G	70.121.07	50.121.07
3947959	K122E	70.122.05	50.122.05
7000856	K901L	70.901.12	50.901.12
85101057	KG931R	77.931.18	57.931.18
85104370			50.121.08
85104371			50.121.08
85106184	K122E	70.122.05	50.122.05
85108338	K536M		
85125838	KH931L	78.931.12	58.931.12

Part No.	Qwik Kit	Plus Kit	Econo Kit
VOLVO-WHITE			
02-7091941	K921L	70.921.12	50.921.12
37090-4417	KG931R	77.931.18	57.931.18
37090-5000	K931L	70.931.12	50.931.12
37090-5002	KG931R	77.931.18	57.931.18
37090-5005	K126W	70.126.23	50.126.23
37090-5015	K971R	70.971.18	50.971.18
37090-5018	K931L	70.931.12	50.931.12
37090-5019	KG931R	77.931.18	57.931.18
37090-5022	KH931L	78.931.12	58.931.12
V1110083	KH931L	78.931.12	58.931.12
V1112400	K120E	70.120.05	50.120.05
V1112446	K120E	70.120.05	50.120.05
V1112810	K120E	70.120.05	50.120.05
V276193	K122V		
WATSON CHALIN			
SRK98	K130W		
SRK102	K961L	70.961.12	50.961.12
SRK103	K941R	70.941.18	50.941.18
SRK105	KH931L	78.931.12	58.931.12
SRK112	K130W		
SRK115	K81W		
SRK120	K181R	70.181.18	50.181.18
WESTERN STAR			
195	K931L	70.931.12	50.931.12
198	KH931L	78.931.12	58.931.12
1307	K931L	70.931.12	50.931.12

Part No.	Qwik Kit	Plus Kit	Econo Kit
WESTERN STAR			
217175	K125W	70.125.23	50.125.23
806355	K120E	70.120.05	50.120.05
37090-5000	K931L	70.931.12	50.931.12
37090-5002	KG931R	77.931.18	57.931.18
37090-5005	K126W	70.126.23	50.126.23
37090-5015	K971R	70.971.18	50.971.18
37090-5018	K931L	70.931.12	50.931.12
37090-5019	KG931R	77.931.18	57.931.18
37090-5022	KH931L	78.931.12	58.931.12
143698-0001	K125W	70.125.23	50.125.23
143698-0002	K126W	70.126.23	50.126.23
WESTPORT			
143698-0018	K181R	70.181.18	50.181.18
143698-0024	K95F	70.095.06	50.095.06
143698-0029	K127W	70.127.23	50.127.23
143698-0040	K72F	70.072.06	50.072.06
143698-0051	K126W	70.126.23	50.126.23
143698-0052	K127W	70.127.23	50.127.23
143698-0053	K96F	70.096.06	50.096.06
143698-0063	K127W	70.127.23	50.127.23
1637090-4405	K126W	70.126.23	50.126.23
WORKHORSE			
8003056	K50W		
8007225	K50W		
8006372	K58G	70.058.07	
8803050	K56G	70.056.07	50.056.07

BEARING INTERCHANGE

SUPPLIER	STEMCO Kaiser
T110	701.4.9
T119	701.4.14
T126	701.4.4
T1260S	701.4.34
T1370	701.4.23
T139	701.4.15
T139S	701.4.35
T149	701.4.5
T1490S	701.4.36
T163	701.4.1
T1760	701.4.18
T179SP	701.4.31
T182	701.4.2
T1822S	701.4.30
T18294S	701.4.28
T182S	701.4.27
T1880	701.4.3
T188S	701.4.25
T189	701.4.24
T1910	701.4.19
T1920	701.4.17
T1921	701.4.20
T194S	701.4.21
T195S	701.4.22
T202	701.4.29
T208	701.4.11
T208S	701.4.37
T216SP	701.4.32
528548B1	701.4.26

Spring Pin Interchange

Supplier	STEMCO Kaiser	Supplier	STEMCO Kaiser	Supplier	STEMCO Kaiser	Supplier	STEMCO Kaiser	Supplier	STEMCO Kaiser
BLUEBIRD		EUCLID		FORD		GILLIG		PETERBILT	
00051758	BSP12-17	E1817TU	BSP16-2	RB161	BSP41-1	55-00696-001	BSP78-1	02-01846	BSP12-12
0997056	BSP25-2	E1818	BSP2-2	7EQ-5780	BSP25-2	HENDRICKSON		02-01847	BSP12-13
0663856	BSP25-2	E3715	BSP31-6	B7TZ-5465-A	BSP18-5	32276	BSP16-2	PIERCE	
1034271	BSP60-1	EUCLID		B8QH-5780-A	BSP25-2	32277	BSP2-2	1006380	BSP66-1
1353440	BSP55-1	E3761	BSP46-2	B8QH-5780-B	BSP2-2	43146	BSP46-2	1006381	BSP66-2
1662774	BSP12-17	E7312	BSP34-1	D2HZ-5780-A	BSP22-2	45797	BSP54-1	1006382	BSP65-1
CRANE CARRIER		E7316	BSP35-1	DOHZ-5780-B	BSP12-20	5	BSP22-2	1006383	BSP65-2
243-233	BSP12-12	E7318	BSP71-1	DOHZ-5780-D	BSP16-2	BE13938	BSP2-2	1006385	BSP24-2
DAYTON		FLAGG		DOHZ-5780-E	BSP10-8	BE4927	BSP16-2	1006386	BSP49-1
327-106	BSP16-2	B1112-50	BSP16-2	DOHZ-5780-F	BSP10-7	INTERNATIONAL		1006387	BSP55-1
327-107	BSP2-2	B1120-55	BSP8-2	E3HZ-5780-A	BSP46-2	1648109C1	BSP34-1	2267668	BSP24-2
327-108	BSP22-2	B1140-62	BSP59-1	E5HZ-5780A	BSP10-7	1648110C1	BSP35-1	2267670	BSP49-1
327-109	BSP54-1	B1144-43	BSP25-2	E5HZ-5780B	BSP10-8	1661976C3	BSP49-1	2267672	BSP55-1
327-124	BSP16-2	B1146-43	BSP18-5	F7HT-5A314DA	BSP50-2	1671766C1	BSP55-1	2267673	BSP65-1
327-128	BSP60-1	B1171-50	BSP2-2	TWAA-5780-A	BSP16-2	303589C1	BSP12-21	2267676	BSP65-2
327-129	BSP35-1	B1185-43	BSP25-2	FREIGHTLINER		303865C1	BSP10-9	2267678	BSP66-1
327-148	BSP18-5	B1197-43	BSP10-7	16-12302-000	BSP79-1	3511254C1	BSP49-1	2267679	BSP66-2
327-209	BSP10-8	B1205-43	BSP12-20	16-12373	BSP38-2	3515804C1	BSP55-1	40-0190	BSP66-1
327-211	BSP10-7	B1220-55	BSP20-2	16-12373-000	BSP38-2	443864C1	BSP16-2	40-0195	BSP65-1
327-212	BSP12-20	B1220-55	BSP68-1	16-13078-000	BSP38-2	468703C2	BSP34-1	40-4958	BSP55-1
327-216	BSP25-2	B1221-55	BSP19-2	16-13079-000	BSP38-2	468704C1	BSP35-1	40-6006	BSP66-2
327-224	BSP12-13	B1221-55	BSP67-1	16-13470-000	BSP38-2	507203C1	BSP71-1	40-6745	BSP65-2
327-225	BSP12-12	B1252-96	BSP10-6	6803250074	BSP50-3	688941R1	BSG0026-1	40-6954	BSP24-2
327-227	BSP59-1	B1258-62	BSP31-6	GAUMERS		688951R1	BSG0026-1	40-8553	BSP49-1
327-229	BSP34-1	B1262-55	BSP12-20	21112	BSP16-2	688952R1	BSP68-1	40-9529	BSP66-1
327-230	BSP35-1	B1268-55	BSP10-9	21120	BSP8-2	688953R1	BSP67-1	40-9530	BSP66-2
327-237	BSP10-9	B1310-43	BSP10-7	21144	BSP25-2	76771R1	BSP8-2	40-9531	BSP65-1
327-240	BSP8-2	B1311-43	BSP10-8	21146	BSP18-5	KENWORTH		40-9532	BSP65-2
327-250	BSP25-2	B1314-55	BSP12-21	21146	BSP18-5	5296	BSP70-1	40-9533	BSP24-2
327-254	BSP2-2	B1316-50	BSP22-2	21171	BSP2-2	6262	BSP67-1	40-9534	BSP49-1
327-256	BSP12-21	B1318-16	BSP10-8	21197	BSP10-7	K179-378	BSP69-1	40-9535	BSP55-1
327-290	BSP20-2	B1335-75	BSP12-12	21205	BSP12-20	MACK		TW	
327-297	BSP67-1	B1336-75	BSP12-13	21220	BSP25-2	100K310M5	BSP85-1	B1205	BSP12-20
327-305	BSP68-1	B1339-62	BSP90-1	21221	BSP19-2	44QH26A	BSP90-1	B1220	BSP25-2
327-306	BSP69-1	B1354-96	BSP24-2	21253	BSP9-4	44QK143CP2	BSP59-1	B1258	BSP31-6
327-331	BSP90-1	B1355-62	BSP59-1	21258	BSP31-6	44QK173B	BSP31-6	B1310	BSP10-7
327-342	BSP31-6	B1363-59	BSP69-1	21262	BSP12-20	NEW STAR		B1311	BSP10-8
327-342	BSP31-6	B1368-55	BSP35-1	21268	BSP10-9	S-2357	BSP10-9	B1354	BSP24-2
327-384	BSP24-2	B1369-55	BSP34-1	21310	BSP10-7	S-2634	BSP68-1	B1400	BSP71-1
327-403	BSP10-8	B1372-59	BSP70-1	21311	BSP10-8	S-2680	BSP12-21	B1408	BSP38-2
327-434	BSP70-1	B1378-50	BSP2-2	21314	BSP12-21	S-4882	BSP16-2	B1434	BSP49-1
327-437	BSP46-2	B1386-50	BSP46-2	21316	BSP22-2	S-5017	BSP8-2	VOLVO	
327-443	BSP71-1	B1389-24	BSP12-12	21318	BSP10-8	S-5087	BSP34-1	1075226	BSG0078-1
327-445	BSP12-12	B1397-55	BSP62-1	21335	BSP12-12	S-5088	BSP35-1	1075723	BSP83-1
327-446	BSP12-17	B1400-55	BSP71-1	21336	BSP12-13	S-5779	BSP71-1	1076334	BSP85-1
327-447	BSP12-18	B1401-75	BSP12-12	21354	BSP24-2	S-7579	BSP55-1	1614229	BSP85-1
327-450	BSP38-2	B1403-75	BSP12-17	21355	BSP59-1	S-7580	BSP49-1	3082276	BSP24-2
327-479	BSP55-1	B1407-50	BSP54-1	21363	BSP19-2	S-8527	BSP10-8	3974787	BSP24-2
327-480	BSP49-1	B1408-46	BSP38-2	21368	BSP35-1	S-8528	BSP12-20	V1614230	BSP83-1
327-481	BSP38-2	B1409-46	BSP79-1	21369	BSP34-1	S-8610	BSP31-6	WESTERN STAR	
327-483	BSP50-1	B1419-75	BSP50-1	21372	BSP20-2	S-9432	BSP50-1	37121-3412	BSP63-2
327-485	BSP55-1	B1420-75	BSP50-1	21378	BSP2-2	S-9433	BSP38-2	37121-3413	BSP63-1
327-487	BSP38-2	B1430-46	BSP44-2	21386	BSP46-2	OSHKOSH		WHITE	
327-490	BSP79-1	B1434-55	BSP49-1	21397	BSP62-1	1664070	BSP74-1	04-9040450	BSP21-2
327-491	BSP50-3	B1435-55	BSP55-1	21400	BSP71-1	2044870	BSP58-1	37121-0001	BSP24-2
327-508	BSP63-1	B1438-46	BSP38-2	21401	BSP12-12	57613BX	BSP75-1	PETERBILT	
327-516	BSP50-2	B1445-46	BSP38-2	21403	BSP12-17	PETERBILT		02-00082	BSP12-13
327-521	BSP75-1	B1446-59	BSP67-1	21407	BSP54-1	02-00180	BSP12-12	02-01560	BSP12-12
327-522	BSP12-17	B1464-92	BSP83-1	21408	BSP38-2	02-01560	BSP12-12	02-01561	BSP12-17
327-533	BSP83-1	B1479-94	BSP63-1	21409	BSP79-1	02-01562	BSP12-18	02-01767	BSP50-1
327-737	BSP20-2	B1480	BSP60-1	21419	BSP50-1	02-01781	BSP50-1	STEMCO	
DODGE		B1488-46	BSP50-3	21420	BSP50-1				
E-1818	BSP2-2	B1489-14	BSP12-17	21434	BSP49-1	45			
E-3761	BSP46-2	B1491-96	BSP83-1	21435	BSP55-1				
		B1498-43	BSP50-2	21438	BSP38-2				

SHIM PACK CROSS-REFERENCE SHEET

INDIVIDUAL SHIM NUMBER	10 PACK NUMBER	THICKNESS	OUTSIDE DIAMETER	INSIDE DIAMETER	KIT REFERENCE (TOP 10)
80P1-1	SP1-1	0.005	2.87	1.63	K139I, K140I, K95F, K96F, K971R, 70.139.09, 70.140.09, 70.095.06, 70.096.06, 70.971.18
80P1-12	SP1-12	0.005	2.50	1.33	K71F, K72F, 50.071.06, 50.072.06, 70.071.06, 70.072.06
80P1-14	SP1-14	0.005	2.62	1.65	K120E, K121E, 50.120.05, 50.121.05, 70.120.05, 70.121.05
80P1-2	SP1-2	0.005	2.81	1.87	K122E, K126W, K127W, K931L, K961L, KG931R, KH946R, 70.122.05, 70.961.12
80P1-21	SP1-21	0.005	1.94	1.20	K50W, K55G, K565G, K58G, K68Z, K69Z, 50.055.07, 50.056.07, 70.055.07, 70.056.07, 70.058.07
80P1-22	SP1-22	0.005	2.24	1.39	K101I, K102I, K103S, 50.101.09, 50.102.09, 50.103.19, 70.101.09, 70.102.09, 70.103.19
80P1-23	SP1-23	0.005	3.60	2.14	K120I, K141S, K160A, K160S, K161S, 50.120.09, 50.141.19, 50.160.19, 70.120.09, 70.141.19, 70.160.19
80P1-24	SP1-24	0.005	3.00	1.90	K120H, K146E, K147E, 50.146.05, 50.147.05, 70.146.05, 70.146.05
80P1-26	SP1-26	0.005	1.61	1.32	K80G
80P1-30	SP1-30	0.005	3.75	2.27	K700T
80P1-5	SP1-5	0.005	2.50	1.50	K170G, K75F, K76F, KD901R, 50.075.06, 50.076.06, 54.901.18, 70.075.06, 70.076.06, 74.901.18
80P1-9	SP1-9	0.005	3.25	2.03	K180E, K180R, K181R, KH901L, KH931L, 50.180.05, 78.931.12, 70.180.05, 78.901.12, 78.931.12
80P2-1	SP2-1	0.010	2.00	1.31	K50F, K70D, K70F, K70G, K71D, 70.053.06, 70.073.06, 70.070.07, 70.071.04
80P2-10	SP2-10	0.010	2.50	1.33	K71F, K72F, 50.071.06, 50.072.06, 70.071.06, 70.072.06
80P2-11	SP2-11	0.010	2.62	1.65	K120E, K121E, 50.120.05, 50.121.05, 70.120.05, 70.121.05
80P2-15	SP2-15	0.010	2.50	1.81	K120R, K981R, 50.981.18, 70.981.18
80P2-17	SP2-17	0.010	1.94	1.20	K55G, K56G, K58G, K68Z, K69Z, 50.055.07, 50.056.07, 70.055.07, 70.056.07, 70.058.07
80P2-18	SP2-18	0.010	2.24	1.39	K101I, K102I, K103S, 50.101.09, 50.102.09, 50.103.19, 70.101.09, 70.102.09, 70.103.19
80P2-19	SP2-19	0.010	3.60	2.14	K120I, K140S, K160S, K161S, 50.120.09, 50.140.19, 50.160.19, 70.120.09, 70.140.19, 70.160.19
80P2-2	SP2-2	0.010	2.50	1.50	K170G, K75F, K76F, KD901R, 50.075.06, 50.076.06, 54.901.18, 70.075.06, 70.076.06, 74.901.18
80P2-20	SP2-20	0.010	3.00	1.90	K120H, K146E, K147E, 50.146.05, 50.147.05, 70.146.05, 70.146.05
80P2-21	SP2-21	0.010	2.50	1.52	K70R, K80R, K941R, 50.070.18, 50.080.18, 50.941.18, 70.070.18, 70.080.18, 70.941.18
80P2-24	SP2-24	0.010	1.95	1.25	K60R
80P2-27	SP2-27	0.010	3.75	2.27	K700T, 70.700.20
80P2-3	SP2-3	0.010	1.75	1.15	K51G, 50.051.07, 70.051.07
80P2-5	SP2-5	0.010	2.81	1.87	K122E, K126W, K127W, K931L, K961L, KG931R, KH946R, 70.122.05, 70.961.12
80P2-7	SP2-7	0.010	3.25	2.03	K180E, K180R, K181R, KH901L, KH931L, 50.180.05, 78.931.12, 70.180.05, 78.901.12, 78.931.12
80P2-8	SP2-8	0.010	2.00	1.15	KE350F, K50D, 55.350.06, 50.050.04, 75.300.06, 70.050.04
80P2-9	SP2-9	0.010	2.31	1.22	K95G, KD900R, 50.095.07, 70.095.07
80P3-24	SP3-24	0.030	2.81	1.87	K80A, K120A, K122E, K123E, K123K, 50.122.05, 50.123.05, 70.122.05, 70.123.05
80P3-26	SP3-26	0.015	1.89	1.60	K110G, K120G
80P3-29	SP3-29	0.030	3.25	2.03	K180E, K180R, K181R, KH901L, KH931L, 50.180.05, 78.931.12, 70.180.05, 78.901.12, 78.931.12
80P3-31	SP3-31	0.030	3.00	1.90	K120H, K146E, K147E, 50.146.05, 50.147.05, 70.146.05, 70.146.05

KIT REF.	K101I		K102I		K103S		K108I		K109I		K110G		K120A		K120E		K120G		
PART REF	QTY	PART No.	QTY	PART No.	QTY	PART No.	QTY	PART No.	QTY	PART No.	QTY	PART No.	QTY	PART No.	QTY	PART No.	QTY	PART No.	
KING PIN	2	10M13-1	2	10M37-1	2	10M56-1	2	10M27-1	2	10M14-2	2	10M42-5	2	10M63-1	2	10M24-10	2	10M42-6	
BUSHING	4	20M13-1	4	20M13-1	4	20M13-1	4	20M14-4	4	20M14-4	2	20M18-9	4	32A18-4	4	20M16-8	2	20M18-9	
STEEL LINER																			
TAPER LOCK PINS	2	60M7-1	2	60M4-10	4	60M2-20	2	60M2-11	4	602.4.1			4	60M1-21	2	60M2-15			
			2	60M4-11															
			2	60M7-8															
END PLATE / PLUG	4	401.12.1	4	401.12.1			4	401.3.1	4	401.3.1			4	45P8-4	4	401.127.2			
O-RING GASKET	4	93P1-6	4	93P1-6	4	92P1-28	4	92P1-8	4	92P1-8	2	41P10-2	4	92P1-37	4	92P1-11	2	41P10-2	
BUSHING SEAL	4	91P1-14	4	91P1-14	4	91P1-14	4	91P1-19			2	91P5-2	4	91P1-47	4	91P1-25	2	91P5-2	
											2	91P6-2					2	91P6-2	
BEARING	2	701.4.15	2	701.4.15	2	701.4.15	2	701.4.5	2	701.4.5	2	70P4-4A	1	701.4.31	2	701.4.19	2	70P4-4A	
											2	70P4-4B	1	701.7.1			2	70P4-4B	
BEARING SEAL	2	91P2-3	2	91P2-3	2	91P2-3	2	91P2-15											
SHIM	5	80P1-22	5	80P1-22	5	80P1-22	7	80P1-1	7	80P1-1	6	80P3-26	6	80P2-5	5	80P1-14	6	80P3-26	
	5	80P2-18	5	80P2-18	5	80P2-18							12	80P3-24	5	80P2-11			
CAP SCREW	8	5/16-18X.6	8	5/16-18X.6			12	5/16-18X.7	12	5/16-18X.7						12	5/16-18X1		
NUT	2	50P19-2	2	50P19-2	4	50P19-2	2	50P19-3					4	50P19-1	2	50P19-3			
LOCK WASHER	8	5/16	8	5/16			12	5/16	12	5/16						12	5/16		
FELT WASHER																			
EXPANSION PLUG													4	100P1-5					
RELIEF FITTING																			
COTTER PIN																			
LOCK RING																			
CASTLE NUT												2	50P17-1					2	50P17-1

KIT REF.	K120H		K120I		K120N		K120R		K120W		K121E		K121G		K122E		K122V		
PART REF	QTY	PART No.	QTY	PART No.	QTY	PART No.	QTY	PART No.	QTY	PART No.	QTY	PART No.	QTY	PART No.	QTY	PART No.	QTY	PART No.	
KING PIN	2	10M51-2	2	10M38-2	2	10M54-1	2	10M33-3	2	10M18-1	2	10M24-10	2	10M21-8	2	10M35-3	2	9M12-1	
BUSHING	4	20M18-10	4	20M21-11	2	32A18-1	4	20M20-1	2	20M18-1	4	20M16-8	2	20M19-7	4	20M19-9	2	20M24-2	
					2	32A18-2			2	20M18-2			2	20M19-8					
STEEL LINER																		2	31M18-1
TAPER LOCK PINS			2	60M2-19			2	60M1-1	2	60M2-1	2	60M2-15	2	60M4-7	2	60M1-9			
			2	60M2-20			2	60M1-8					2	60M4-8					
END PLATE / PLUG	4	45P8-1			4	401.140.1	4	401.128.1	4	401.20.1	4	401.127.2	4	401.128.1	4	45P6-1			
O-RING GASKET	4	92P1-17	4	92P1-20	4	92P1-27	4	92P1-4	4	92P1-4	4	92P1-11	4	92P1-4	4	93P1-12	2	92P1-24	
																	2	92P1-25	
BUSHING SEAL	4	91P1-44	4	91P1-32			4	91P1-29			4	91P1-25			4	91P1-29	2	91P7-1	
																	2	91P8-1	
BEARING	2	701.4.30	2	701.4.21	2	701.4.26	2	701.4.27	2	701.4.25	2	70P2-13	2	701.4.18	2	701.4.2	2	70P4-3	
BEARING SEAL													2	91P2-9/10					
SHIM	26	80P2-20	6	80P1-23	4	80P1-9	5	80P1-19	7	80P1-2	5	80P1-14	5	80P1-2	3	80P1-2	2	80P3-25	
			6	80P2-19	4	80P2-7	3	80P2-15			5	80P2-11	5	80P2-5	5	80P2-5	4	80P3-26	
			4	80P3-30	6	80P3-32	4	80P3-33							2	80P3-24	2	80P3-28	
CAP SCREW	4	5/8-11X1.25	12	5/16-18X1			12	5/16-18X1	12	1/4-20X1/2	12	5/16-18X1	12	5/16-18X.7					
NUT			4	50P19-2			4	50P19-1	2	50P19-1	2	50P19-3			2	50P19-1			
LOCK WASHER			12	5/16			12	5/16	12	1/4	12	5/16	12	5/16					
FELT WASHER																			
EXPANSION PLUG													2	45P1-16					
RELIEF FITTING					4	90P3-1			4	90P1-1			4	90P1-1					
COTTER PIN																	2	102P16-3	
LOCK RING	4	103P1-1			4	100P1-9							2	100P1-7					
CASTLE NUT																			

KIT REF.	K123E		K123K		K125G		K125W		K126W		K127W		K130W		K131H		K132K	
PART REF	QTY	PART No.	QTY	PART No.	QTY	PART No.	QTY	PART No.	QTY	PART No.	QTY	PART No.	QTY	PART No.	QTY	PART No.	QTY	PART No.
KING PIN	2	10M55-2	2	10M35-5	2	9M16-6	2	10M18-2	2	10M18-2	2	10M18-2	2	10M21-3	2	10M18-8	2	10M35-5
BUSHING	4	20M19-9	4	20M19-9	4	20M16-7	2	20M18-1	2	20M18-1	2	20M18-1	4	20M19-9	4	20M18-10	4	20M19-9
STEEL LINER					2	31M16-2												
TAPER LOCK PINS	2	60M1-16	2	60M1-23			2	60M2-8	2	60M2-8	2	60M2-8	2	60M1-1	2	60M1-1	2	60M1-23
	2	60M1-17																
END PLATE / PLUG			4	45P6-1	2	40P16	4	401.20.1	4	401.20.1	4	45P2-3	4	45P2-3	4	45P8-1	4	45P6-1
O-RING GASKET	4	93P1-12			2	41P4-1	4	92P1-4	4	92P1-4					4	92P1-17		
BUSHING SEAL	4	91P1-29	4	91P1-29	4	91P3-1	4	91P1-44	4	91P1-44	4	91P1-44	4	91P1-29	4	91P1-44	4	91P1-29
BEARING	2	701.4.28	2	701.4.2	2	701.4.1	2	701.4.25	2	701.4.17	2	701.4.20	2	701.4.27	2	701.4.30	2	701.4.20
BEARING SEAL												2	91P2-11					
SHIM	3	80P1-2	3	80P1-2	5	80P3-3	7	80P1-2	7	80P1-2	7	80P1-2	2	80P1-19	12	80P2-20	3	80P1-2
	5	80P2-5	5	80P2-5	2	80P3-4	5	80P2-5	5	80P2-5	5	80P2-5	2	80P2-15			5	80P2-5
	2	80P3-24	2	80P3-24	2	80P3-5							2	80P3-33			2	80P3-24
					2	80P3-6												
CAP SCREW					6	5/16-18X.5	12	1/4-20X1/2	12	1/4-20X1/2								
NUT	4	50P19-2	2	50P19-2			2	50P19-1	2	50P19-1	2	50P19-1	2	50P19-1			2	50P19-2
LOCK WASHER					6	5/16	12	1/4	12	1/4								
FELT WASHER																		
EXPANSION PLUG					2	45P1-8												
RELIEF FITTING							4	90P1-1	4	90P1-1								
COTTER PIN					2	102P16-1												
LOCK RING					2	100P1-2								4	103P1-1			
CASTLE NUT					2	50P14-1												

KIT REF.	K139I		K140I		K140V		K141S		K146E		K146F		K146S		K147E		K149E	
PART REF	QTY	PART No.	QTY	PART No.	QTY	PART No.	QTY	PART No.	QTY	PART No.	QTY	PART No.	QTY	PART No.	QTY	PART No.	QTY	PART No.
KING PIN	2	10M24-1	2	10M16-13	2	9M14-1	2	10M38-6	2	10M35-2	2	10M21-15	2	10M43-1	2	10M55-1	2	10M55-1
BUSHING	4	20M17-1	4	20M17-1	2	20M21-17	4	20M21-10	4	20M18-8	4	20M18-1	4	20M18-6	4	20M18-11	4	20M18-11
STEEL LINER					2	31M20-1												
TAPER LOCK PINS	2	60M2-11	4	602.4.1			4	60M2-19	2	60M1-9	2	60M1-25	2	60M2-19	2	60M1-16	4	60M1-24
							2	60M1-17			2	60M1-26	2	60M2-20	2	60M1-17		
END PLATE / PLUG	4	401.3.1	4	401.3.1							4	401.20.1			4	45P6-1	4	45P6-1
O-RING GASKET	4	92P1-8	4	92P1-8	2	92P1-34	4	92P1-20	4	93P1-12	4	92P1-4	4	92P1-20	4	93P1-12	4	93P1-12
					2	92P1-40	4	92P1-21										
BUSHING SEAL	4	91P3-1	4	91P3-1	2	91P1-50	4	91P1-34	4	91P1-36	4	91P1-44	4	91P1-38	4	91P1-36	4	91P1-36
					2	91P8-2												
BEARING	2	701.4.1	2	701.4.1	2	70P4-5	2	701.4.37	2	701.4.24	2	701.4.20	2	701.4.22	2	701.4.25	2	701.4.25
BEARING SEAL	2	91P2-2	2	91P2-2														
SHIM	7	80P1-1	7	80P1-1	2	80P2-24	3	80P1-23	3	80P1-24	4	80P1-2	5	80P1-2	3	80P1-24	3	80P1-24
	2	80P3-13	2	80P3-13	4	80P3-38	3	80P2-19	5	80P2-20	8	80P2-5	7	80P2-5	5	80P2-20	5	80P2-20
					4	80P3-39	2	80P3-30	2	80P3-31					2	80P3-31	2	80P3-31
					4	80P3-40												
CAP SCREW	12	5/16-18X.7	12	5/16-18X.7							12	1/4-20 X 3/4						
NUT	2	50P19-3					4	50P19-2	2	50P19-1	4	50P19-1	4	50P19-2	4	50P19-2	4	50P19-3
LOCK WASHER	12	5/16	12	5/16							12	1/4						
FELT WASHER																		
EXPANSION PLUG																		
RELIEF FITTING																		
COTTER PIN					2	102P16-4												
LOCK RING																		
CASTLE NUT																		

KIT REF.	K150KG		K160A		K160S		K161S		K162S		K170G		K180E		K180R		K181R		
PART REF	QTY	PART No.	QTY	PART No.	QTY	PART No.	QTY	PART No.	QTY	PART No.	QTY	PART No.	QTY	PART No.	QTY	PART No.	QTY	PART No.	
KING PIN	2	10M35-4	2	10M64-1	2	10M38-4	2	10M38-5	2	10M33-4	2	9M16-9	2	10M35-1	2	10M22-5	2	10M22-2	
BUSHING	4	32A18-3	4	32A18-6	4	20M21-10	4	20M21-10	4	20M19-9	4	20M19-4	4	20M18-11	4	20M21-2	4	20M21-2	
STEEL LINER	2	60M7-6									2	31M16-3							
TAPER LOCK PINS			2	60M1-21	2	60M1-12	2	60M7-7	2	60M1-1			2	60M2-18	2	60M1-1	2	60M1-4	
			2	60M1-22	2	60M1-13	2	60M7-8	2	60M1-2					2	60M1-8	2	60M1-8	
END PLATE / PLUG	4	401.142.1	4	45P13-1								2	40P16			4	401.128.2	4	401.128.2
O-RING GASKET	4	41P5-3	4	92P1-38	4	92P1-21	4	92P1-21	4	92P1-21	2	41P4-1	4	41P11-1	4	92P1-9	4	92P1-9	
BUSHING SEAL			4	91P1-48	4	91P1-34	4	91P1-34	4	91P1-29	4	91P1-29	4	91P1-36	4	91P1-15	4	91P1-15	
BEARING	2	701.4.29	1	701.4.32	2	701.4.37	2	701.4.37	2	701.4.2	2	701.4.2	2	701.4.24	2	701.4.37	2	701.4.37	
			1	701.7.2															
BEARING SEAL																			
SHIM	5	80P1-9			3	80P1-23	3	80P1-23	4	80P1-24	5	80P1-5	3	80P1-9	3	80P1-9	3	80P1-9	
	5	80P2-7			3	80P2-19	3	80P2-19	5	80P2-20	5	80P2-2	3	80P2-7	3	80P2-7	3	80P2-7	
	2	80P3-29			2	80P3-30	2	80P3-30	2	80P3-31	2	80P3-3/4	2	80P3-29	2	80P3-29	2	80P3-29	
									2	80P7-1	2	80P3-5/6			2	80P3-34	2	80P3-34	
CAP SCREW	12	1/4-28X1/2									6	5/16-18X.5	16	5/16-18X1	12	5/16-18X1	12	5/16-18X1	
NUT	2	50P19-3	4	50P19-1	4	50P19-2	4	50P19-2	4	50P19-2			2	50P19-3	4	50P19-1	4	50P19-1	
LOCK WASHER											6	5/16	16	5/16	12	5/16	12	5/16	
	12	1/4																	
FELT WASHER																			
EXPANSION PLUG											2	45P1-9							
RELIEF FITTING																			
COTTER PIN												2	102P16-1						
LOCK RING			4	100P1-10								2	100P1-1						
CASTLE NUT												2	50P14-1						

KIT REF.	K200S		K201S		K230KG		K309I		K310I		K50F		K50W		K51G		K533M	
PART REF	QTY	PART No.	QTY	PART No.	QTY	PART No.	QTY	PART No.	QTY	PART No.	QTY	PART No.	QTY	PART No.	QTY	PART No.	QTY	PART No.
KING PIN	2	10M38-7	2	10M55-3	2	10M35-6	2	10M24-2	2	10M16-12	2	10M12-20	2	10M11-17	2	10M11-9	2	9M15-3
BUSHING	4	20M21-18	4	20M21-18	2	32A18-7	4	20M17-1	4	20M17-1	4	20M2-3	4	20M11-14	4	20M11-3	2	20M16-3
					2	32A18-8												
STEEL LINER																		
TAPER LOCK PINS	2	60M1-12	2	60M1-12			2	60M2-11	4	602.4.1	2	60M2-3	2	60M1-11	2	60M3-1		
	4	60M1-13	4	60M1-13														
END PLATE / PLUG	4	45P6-1	4	45P6-1	4	401.146.1	4	401.3.1	4	401.3.1	4	401.120.3	4	45P2-4	4	40M123-2	2	45P10-2
O-RING GASKET					4	92P1-41	4	92P1-8	4	92P1-8	4	93P1-2			4	93P1-1	2	92P1-30
					2	92P1-42												
BUSHING SEAL	4	91P1-34	4	91P1-34			4	91P3-1	4	91P3-1			4	91P1-42			2	91P1-11
																	2	91P1-12
BEARING	2	701.4.37	2	701.4.37	2	70P7-1	2	701.4.1	2	701.4.1	2	701.4.4	2	701.4.14	2	701.4.9	2	70P2-1
							2	91P2-2	2	91P2-2							2	70P3-2
BEARING SEAL																		
SHIM	3	80P1-13	3	80P1-13	2	80P3-53	7	80P1-1	11	80P1-1	7	80P1-4	6	80P1-21	5	80P1-6		
	3	80P2-19	3	80P2-19					2	80P3-13	5	80P2-1			5	80P2-3		
	2	80P3-30	2	80P3-30														
CAP SCREW					12	5/16-24X3/4	12	5/16-18X.7	12	5/16-18X.7	8	10-32X5/8			8	1/4-28X5/8		
NUT	4	50P19-2	4	50P19-2			2	50P19-3			2	50P19-1	2	50P19-1	2	50P19-2		
LOCK WASHER					12	5/16	12	5/16	12	5/16	8	10/32			8	1/4		
FELT WASHER																		
EXPANSION PLUG																	2	50P4-1
RELIEF FITTING											4	90P1-3			4	90P1-3		
COTTER PIN																		
LOCK RING																		
CASTLE NUT																		

KIT REF.	K535M		K536M		K55G		K56G		K58G		K60R		K60U		K616M		K68Z		
PART REF	QTY	PART No.	QTY	PART No.	QTY	PART No.	QTY	PART No.	QTY	PART No.	QTY	PART No.	QTY	PART No.	QTY	PART No.	QTY	PART No.	
KING PIN	2	9M15-2	2	9M23-1	2	10M11-10	2	10M11-10	2	10M11-10	2	10M12-28	2	10M65-1	2	9M18-2	2	10M58-1	
BUSHING	2	20M15-2	2	20M23-2	4	20M11-7	4	20M11-9	4	20M11-9	4	20M12-7	4	32A22-1	2	20M23-1	4	20M11-12	
STEEL LINER																			
TAPER LOCK PINS					2	60M1-15	2	60M1-15	2	60M1-15	2	60M1-18	2	60M2-28			2	60M2-23	
END PLATE / PLUG	2	40M4-1			4	401.123.3	4	401.123.3	4	401.141.1	4	45P7-2	2	40P25-1	2	45P10-1	2	45P9-1	
O-RING GASKET	2	41P5-1	2	92P1-35	4	41P3-6	4	41P3-6	4	41P3-6					2	92P1-30	2	92P1-29	
			2	92P1-36															
BUSHING SEAL	2	91P1-10	2	91P10-1	4	91P1-45	4	91P1-42	4	91P1-42	4	91P1-43	2	91P12-1	2	91P1-21	2	91P9-1	
	2	91P1-9	2	91P11-1									2	94P1-1	2	91P1-22			
BEARING	2	70P2-1	2	70P5-1	2	701.4.14	2	701.4.14	2	701.4.14	4	701.4.4	2	70P2-18	2	70P2-8	2	70P2-16	
	2	70P3-1												2	70P3-3				
BEARING SEAL												2	91P2-16						
SHIM			4	80P1-29	7	80P1-21	7	80P1-21	7	80P1-21	3	80P1-28	2	80P1-31			5	80P1-21	
			2	80P2-26	5	80P2-17	5	80P2-17	5	80P2-17	3	80P2-24	2	80P3-41			5	80P2-17	
												2	80P3-36	2	80P3-42				
												2	80P3-37	2	80P3-43				
CAP SCREW	6	1/4-28X5/8			8	1/4-28X5/8	8	1/4-28X5/8	8	1/4-28X5/8								2	5/16-18X5/8
NUT					2	50P19-2	2	50P19-2	2	50P19-2	2	50P19-1	2	3/8-24				2	50P19-2
LOCK WASHER	6	1/4			8	1/4	8	1/4	8	1/4					2	3/8		2	5/16 FLAT
FELT WASHER																			
EXPANSION PLUG	2	45P1-12											2	45P1-11	2	50P4-1			
RELIEF FITTING	2	90P1-1			4	90P1-1	4	90P1-1											
COTTER PIN																			
LOCK RING																			
CASTLE NUT			2	50P20-1															

KIT REF.	K69Z		K700T		K70D		K70F		K70G		K70R		K71D		K71F		K72F	
PART REF	QTY	PART No.	QTY	PART No.	QTY	PART No.	QTY	PART No.	QTY	PART No.	QTY	PART No.	QTY	PART No.	QTY	PART No.	QTY	PART No.
KING PIN	2	10M58-1	1	10M60-1	2	10M2-1	2	10M12-2	2	10M12-1	2	10M52-3	2	10M2-1	2	10M13-6	2	10M37-4
			1	10M61-1														
BUSHING	4	20M11-12	4	32A21-1	4	20M2-1	4	20M2-7	4	20M12-1	4	20M15-7	4	20M2-1	4	20M13-4	4	20M13-7
STEEL LINER																		
TAPER LOCK PINS	2	60M2-23	4	60M2-27	4	602.4.1	2	60M2-3	2	60M3-1	2	60M1-14	4	602.4.1	2	60M2-17	2	60M1-10
											2	60M1-7					2	60M1-11
END PLATE / PLUG	2	45P9-1	4	401.145.1	2	40M123-1	4	401.120.3	4	401.12.2			4	401.143.1	4	45P2-4	4	45P2-4
O-RING GASKET	2	92P1-29	4	92P1-32	2	92P1-8	4	93P1-2	4	41P3-1			4	92P1-16				
			4	92P1-39														
BUSHING SEAL	2	91P9-1									4	91P1-41	4	91P1-43	4	91P1-35	4	91P1-35
BEARING	1	70P2-16	2	70P6-1	2	701.4.4	2	701.4.4	2	701.4.4	2	701.4.5	2	701.4.34	2	70P2-15	2	701.4.23
	1	70P2-17																
BEARING SEAL											2	91P2-15						
SHIM	5	80P1-21	4	80P1-30	5	80P1-4	5	80P1-4	5	80P1-4	5	80P1-25	5	80P1-4	5	80P1-12	5	80P2-10
	5	80P2-17	10	80P2-27	5	80P2-1	5	80P2-1	5	80P2-1	5	80P2-21	5	80P2-1	5	80P2-10		
CAP SCREW	2	5/16-18X5/8	2	3/8-16X1-1/4	4	5/16-18X3/4	8	10-32X5/8	8	1/4-28X1/2			8	5/16-18X3/4				
NUT	2	50P19-2	4	50P19-1			2	50P19-1	2	50P19-2	4	50P19-1			2	50P19-1	4	50P19-1
LOCK WASHER	2	5/16 FLAT			4	5/16	8	10/32	8	1/4			8	5/16				
										2	3/8							
FELT WASHER																		
EXPANSION PLUG					2	45P1-4												
RELIEF FITTING					2	90P1-3	4	90P1-3	4	90P1-1								
COTTER PIN																		
LOCK RING					2	100P1-4												
CASTLE NUT																		

KIT REF.	K75F		K75M		K76F		K80A		K80G		K80R		K81W		K901L		K921L		
PART REF	QTY	PART No.	QTY	PART No.	QTY	PART No.	QTY	PART No.	QTY	PART No.	QTY	PART No.	QTY	PART No.	QTY	PART No.	QTY	PART No.	
KING PIN	2	10M25-1	2	10M13-7	2	10M25-1	2	10M63-2	2	10M42-4	2	10M52-2	2	10M52-1	2	10M21-1	2	10M21-2	
BUSHING	4	20M14-6	4	32A16-12	4	20M14-6	4	32A18-5	2	20M16-11	4	20M15-7	4	20M15-5	4	20M19-5	4	20M20-1	
STEEL LINER																			
TAPER LOCK PINS	2	60M1-1	2	60P6-1	2	60M1-1	4	60M1-21			2	60M1-14	2	60M1-7	2	60M7-3	2	60M7-3	
	2	60M1-2			2	60M1-2					2	60M1-7			2	60M7-4	2	60M7-4	
END PLATE / PLUG	2	401.128.1	4	401.138.1	4	45P2-5	4	45P8-4					4	45P2-5	2	401.128.1	4	401.128.1	
O-RING GASKET	2	92P1-4	4	92P1-23			4	92P1-37	2	41P10-1					4	92P1-4	4	92P1-4	
BUSHING SEAL	4	91P1-16	4	91P1-37	4	91P1-16	4	91P1-47	2	91P5-1	4	91P1-41	4	91P1-41	4	91P1-29	4	91P1-6	
									2	91P6-1									
BEARING	2	701.4.5	2	70P2-14	2	701.4.5	1	701.4.31	2	70P4-2A	2	701.4.5	2	701.4.5	2	701.4.2	2	701.4.2	
							1	701.7.1	2	70P4-2B									
BEARING SEAL			2	91P2-14							2	91P2-15	2	91P2-15			2	91P2-1	
SHIM	5	80P1-5			5	80P1-5	6	80P2-5	8	80P1-26	5	80P1-25	2	80P1-25	5	80P1-2	5	80P1-2	
	5	80P2-2			5	80P2-2	12	80P3-24	4	80P2-22	5	80P2-21	6	80P2-21	8	80P2-5	8	80P2-5	
CAP SCREW	6	5/16-18X3/4														6	5/16-18X3/4	12	5/16-18X3/4
NUT	4	50P19-1	2	M10X1.5	4	50P19-1	4	50P19-1			4	50P19-1	2	50P19-1	4	50P19-2	4	50P19-2	
LOCK WASHER	6	5/16													6	5/16	12	5/16	
FELT WASHER																			
EXPANSION PLUG	2	45P1-11														2	45P1-9		
RELIEF FITTING	2	90P1-1														2	90P1-1		
COTTER PIN																			
LOCK RING	2	100P1-3	4	100P1-3			4	100P1-5							2	100P1-1			
CASTLE NUT									2	50P17-1									

KIT REF.	K931L		K941F		K941FA		K941R		K942F		K942FA		K95F		K95G		K961L	
PART REF	QTY	PART No.	QTY	PART No.	QTY	PART No.	QTY	PART No.	QTY	PART No.	QTY	PART No.	QTY	PART No.	QTY	PART No.	QTY	PART No.
KING PIN	2	10M21-3	2	10M33-2	2	10M33-2	2	10M52-1	2	10M33-2	2	10M33-2	2	10M26-1	2	9M16-7	2	10M21-3
BUSHING	4	20M20-1	4	20M20-1	4	20M20-1	4	20M15-5	4	20M20-1	4	20M20-1	4	20M16-7	2	20M14-1	4	20M20-1
															2	20M14-2		
STEEL LINER															2	31M16-4		
TAPER LOCK PINS	2	60M1-1	2	60M1-1	2	60M1-1	2	60M1-7	2	60M1-1	2	60M1-1	2	60M1-1			2	60M1-7
	2	60M1-2	2	60M1-2	2	60M1-2	2	60M1-14	2	60M1-2	2	60M1-2	2	60M1-2			2	60M1-8
END PLATE / PLUG	4	401.128.1	4	401.128.1	4	401.128.1	4	401.139.1	4	45P2-3	4	45P2-3	2	401.128.1	2	40P16	4	401.128.1
O-RING GASKET	4	92P1-4	4	92P1-4	4	92P1-4	4	92P1-26					2	92P1-4	2	41P4-1	4	92P1-4
BUSHING SEAL	4	91P1-29	4	91P1-29	4	91P1-29	4	91P1-41	4	91P1-29	4	91P1-29	4	91P3-1			4	91P1-29
BEARING	2	701.4.27	2	701.4.2	2	701.4.20	2	701.4.5	2	701.4.2	2	701.4.20	2	701.4.1	2	701.4.5	2	701.4.27
BEARING SEAL							2	91P2-15										
SHIM	5	80P1-2	9	80P1-2	9	80P1-2	5	80P2-21	9	80P1-2	9	80P1-2	9	80P1-1	9	80P2-9	5	80P1-2
	8	80P2-5	9	80P2-5	7	80P2-5			7	80P2-5	7	80P2-5			2	80P3-7	8	80P2-5
															2	80P3-9		
CAP SCREW	12	5/16-18X3/4	12	5/16-18X3/4	12	5/16-18X3/4	12	5/16-18X1					6	5/16-18X3/4	6	1/4-28X1/2	12	5/16-18X3/4
NUT	4	50P19-1	4	50P19-1	4	50P19-1	4	50P19-1	4	50P19-1	4	50P19-1	4	50P19-1	4	50P19-1	4	50P19-1
LOCK WASHER	12	5/16	12	5/16	12	5/16	12	5/16					6	5/16	6	1/4	12	5/16
FELT WASHER																		
EXPANSION PLUG													2	45P1-8	2	45P1-11		
RELIEF FITTING													2	90P1-1				
COTTER PIN															2	102P16-1		
LOCK RING													2	100P1-2	2	100P1-3		
CASTLE NUT															2	50P14-3		

KIT REF.	K96F		K970R		K971R		K981R		K98I		KD900R		KD901R		KE350F		KG931R	
PART REF	QTY	PART No.	QTY	PART No.	QTY	PART No.	QTY	PART No.	QTY	PART No.	QTY	PART No.	QTY	PART No.	QTY	PART No.	QTY	PART No.
KING PIN	2	10M26-1	2	10M16-5	2	10M16-7	2	10M21-12	2	10M12-3	2	9M16-10	2	10M14-1	2	10M10-3	2	10M21-3
BUSHING	4	20M16-7	4	20M16-7	4	20M16-7	4	20M19-9	4	20M12-3	4	20M14-6	4	20M14-6	4	20M5-2	4	20M20-1
STEEL LINER											2	31M16-8						
TAPER LOCK PINS	2	60M1-1	4	602.4.1	4	602.4.1	2	60M1-7	2	60M7-1			4	602.4.1	2	60M2-3	2	60M1-1
	2	60M1-2					2	60M1-8									2	60M1-2
																	2	60M1-8
END PLATE / PLUG	4	45P2-5	2	40M123-1	4	401.128.1	4	45P2-3	4	40M120-4	2	40P16	2	401.128.1	2	45P2-2	4	401.128.1
O-RING GASKET			2	92P1-8	4	92P1-4			4	93P1-1	2	41P4-1	2	92P1-4			4	92P1-4
BUSHING SEAL	4	91P3-1	4	91P3-1	4	91P3-1	4	91P1-29					4	91P1-16	4	91P1-23	4	91P1-29
BEARING	2	701.4.1	2	701.4.1	2	701.4.1	2	701.4.27	2	701.4.4	2	701.4.5	2	701.4.5	2	70P2-3	2	701.4.30
BEARING SEAL					2	91P2-7												
SHIM	9	80P1-1	13	80P1-1	7	80P1-1	5	80P1-19	5	80P1-4	9	80P2-9	5	80P1-5	5	80P1-10	5	80P1-2
							5	80P2-15	5	80P2-1	2	80P3-7	5	80P2-2	5	80P2-8	8	80P2-5
											2	80P3-9						
CAP SCREW			4	5/16-18X3/4	12	5/16-18X3/4			8	1/4-28X5/8	6	5/16-18X1/2	6	5/16-18X3/4			12	5/16-18X3/4
NUT	4	50P19-1					4	50P19-1	2	50P19-2					2	50P19-1	4	50P19-1
LOCK WASHER			4	5/16	12	5/16			8	1/4	6	5/16	6	5/16			12	5/16
FELT WASHER																		
EXPANSION PLUG			2	45P1-8							2	45P1-11	2	45P1-11				
RELIEF FITTING			2	90P1-3					4	90P1-3			2	90P1-1				
COTTER PIN											2	102P16-1						
LOCK RING			2	100P1-2							2	100P1-2	2	100P1-13				
CASTLE NUT											2	50P14-3						

KIT REF.	KH901L		KH931F		KH931L		KH946R											
PART REF	QTY	PART No.	QTY	PART No.	QTY	PART No.	QTY	PART No.	QTY	PART No.	QTY	PART No.	QTY	PART No.	QTY	PART No.	QTY	PART No.
KING PIN	2	10M22-1	2	10M22-2	2	10M22-2	2	10M21-14										
BUSHING	4	20M21-1	4	20M21-2	4	20M21-2	2	20M19-9										
							2	20M19-11										
STEEL LINER																		
TAPER LOCK PINS	4	60M4-4	2	60M1-3	2	60M1-3	2	60M1-3										
			2	60M1-4	2	60M1-4	2	60M1-4										
							2	60M1-8										
END PLATE / PLUG	2	401.128.2	4	401.128.2	4	401.128.2	4	45P7-1										
O-RING GASKET	2	92P1-9	4	92P1-9	4	92P1-9												
BUSHING SEAL			4	91P1-15	4	91P1-15	4	91P1-29										
BEARING	2	701.4.11	2	701.4.11	2	701.4.37	2	701.4.27										
BEARING SEAL																		
SHIM	5	80P1-9	5	80P1-9	5	80P1-9	10	80P1-2										
	9	80P2-7	9	80P2-7	9	80P2-7	10	80P2-5										
							2	80P3-29										
							2	80P3-34										
CAP SCREW	6	5/16-18X3/4	12	5/16-18X3/4	12	5/16-18X3/4												
NUT			4	50P19-1	4	50P19-1	4	50P19-1										
LOCK WASHER	6	5/16	12	5/16	12	5/16												
FELT WASHER																		
EXPANSION PLUG	2	45P1-10																
RELIEF FITTING	2	90P1-1																
COTTER PIN																		
LOCK RING	2	100P1-5																
CASTLE NUT																		

PLUSKIT® Components

KIT REF.	70.051.07		70.053.06		70.055.07		70.056.07		70.058.07		70.068.26		70.069.26		70.070.04		70.070.07	
PART REF	QTY	PART No.	QTY	PART No.	QTY	PART No.	QTY	PART No.	QTY	PART No.	QTY	PART No.	QTY	PART No.	QTY	PART No.	QTY	PART No.
KING PIN	2	105.11.9	2	105.50.3	2	105.11.10	2	105.11.10	2	105.11.10	2	105.58.1	2	105.58.1	2	105.2.1	2	105.12.1
BUSHING	4	202.11.3	4	202.2.3	4	202.11.7	4	202.11.10	4	202.11.10	4	202.11.12	4	202.11.12	4	202.2.1	4	202.12.1
STEEL LINER																		
TAPER LOCK PINS	2	60M3-1	2	60M2-3	2	60M1-15	2	60M1-15	2	60M1-15	2	60M2-23	2	60M2-23	4	602.4.1	2	60M3-1
END PLATE / PLUG									4	401.141.1	2	45P9-1	2	45P9-1				
O-RING GASKET	4	41P3-6	4	92P1-19	4	41P3-6	4	41P3-6	4	41P3-6	2	92P1-29	2	92P1-29	2	41P3-4	4	41P3-1
BUSHING SEAL					4	91P1-45	4	91P1-42	4	91P1-42	2	91P9-1	2	91P9-1				
BEARING	2	701.2.1	2	701.4.4	2	701.4.14	2	701.4.14	2	701.4.14	2	70P2-16	1	70P2-16	2	701.4.4	2	701.4.4
BEARING SEAL													1	70P2-17				
SHIM	5	80P1-6	5	80P1-4	7	80P1-21	7	80P1-21	7	80P1-21	5	80P1-21	5	80P1-21	5	80P1-4	5	80P1-4
	5	80P2-3	5	80P2-1	5	80P2-17	5	80P2-17	5	80P2-17	5	80P2-17	5	80P2-17	5	80P2-1	5	80P2-1
CAP SCREW									12	1/4-28X5/8	2	5/16-18X5/8	2	5/16-18X5/8	4	5/16-18X3/4		
NUT	2	50P19-2	2	50P19-1	2	50P19-2	2	50P19-2	2	50P19-2	2	50P19-2	2	50P19-2			2	50P19-2
LOCK WASHER									12	1/4	2	5/16 FLAT	2	5/16 FLAT	4	5/16		
FELT WASHER																		
EXPANSION PLUG																2	45P1-6	
RELIEF FITTING																2	90P1-3	
COTTER PIN																		
LOCK RING																2	100P1-4	
CASTLE NUT																		

KIT REF.	70.070.18		70.071.04		70.071.06		70.072.06		70.073.06		70.075.06		70.076.06		70.080.18		70.095.06	
PART REF	QTY	PART No.	QTY	PART No.	QTY	PART No.	QTY	PART No.	QTY	PART No.	QTY	PART No.	QTY	PART No.	QTY	PART No.	QTY	PART No.
KING PIN	2	105.52.3	2	105.2.1	2	105.13.6	2	105.37.4	2	105.50.2	2	105.25.1	2	105.25.1	2	105.52.2	2	105.26.1
BUSHING	4	202.15.7	4	202.2.1	4	202.13.4	4	202.13.7	4	202.2.7	4	202.14.6	4	202.14.6	4	202.15.7	4	202.16.7
STEEL LINER																		
TAPER LOCK PINS	2	60M1-14	4	602.4.1	2	60M2-17	2	60M1-10	2	60M2-3	2	60M1-1	2	60M1-1	2	60M1-14	2	60M1-1
	2	60M1-7					2	60M1-11			2	60M1-2	2	60M1-2	2	60M1-7	2	60M1-2
END PLATE / PLUG			4	401.143.1	4	45P2-4	4	45P2-4					4	45P2-5				
O-RING GASKET			4	92P1-16					4	92P1-19	2	41P7-1					2	41P7-1
BUSHING SEAL	4	91P1-41	4	91P1-43	4	91P1-35	4	91P1-35			4	91P1-16	4	91P1-16	4	91P1-41	4	91P3-1
BEARING			2	701.4.34	2	70P2-15	2	701.4.23	2	701.4.4	2	701.4.5	2	701.4.5	2	701.4.5	2	701.4.1
BEARING SEAL	2	91P2-15													2	91P2-15		
SHIM	5	80P1-25	5	80P1-4	5	80P1-12	5	80P2-10	5	80P1-4	5	80P1-5	5	80P1-5	5	80P1-25	9	80P1-1
	5	80P2-21	5	80P2-1	5	80P2-10			5	80P2-1	5	80P2-2	5	80P2-2	5	80P2-21		
CAP SCREW			8	5/16-18X3/4														
NUT	4	50P19-1			2	50P19-1	4	50P19-1	2	50P19-1	4	50P19-1	4	50P19-1	4	50P19-1	4	50P19-1
LOCK WASHER			8	5/16														
FELT WASHER																		
EXPANSION PLUG											2	45P1-11					2	45P1-8
RELIEF FITTING			2	90P1-3														
COTTER PIN																		
LOCK RING											2	100P1-3					2	100P1-2
CASTLE NUT																		

KIT REF.	70.095.07		70.096.06		70.098.09		70.101.09		70.102.09		70.103.19		70.120.05		70.120.09		70.120.18	
PART REF	QTY	PART No.	QTY	PART No.	QTY	PART No.	QTY	PART No.	QTY	PART No.	QTY	PART No.	QTY	PART No.	QTY	PART No.	QTY	PART No.
KING PIN	2	95.16.7	2	105.26.1	2	105.12.3	2	105.13.1	2	105.37.1	2	105.56.1	2	105.24.10	2	105.38.2	2	105.33.3
BUSHING	2	202.14.1	4	202.16.7	4	202.12.3	4	202.13.1	4	202.13.1	4	202.13.1	4	202.16.9	4	202.21.11	4	202.20.1
STEEL LINER	2	312.16.4																
TAPER LOCK PINS			2	60M1-1	2	60M7-1	2	60M7-1	2	60M4-10	4	60M2-20	2	60M2-15	2	60M2-19	2	60M1-1
			2	60M1-2					2	60M4-11			2	60M2-20	2	60M1-8		
									2	60M7-8								
END PLATE / PLUG			4	45P2-5									4	401.129.1			4	401.128.1
O-RING GASKET	2	41P4-1			4	41P3-3	4	92P1-16	4	92P1-16	4	92P1-28	4	41P5-2	4	92P1-20	4	92P1-4
BUSHING SEAL			4	91P3-1			4	91P1-14	4	91P1-14	4	91P1-14	4	91P1-25	4	91P1-32	4	91P1-29
BEARING	2	701.4.5	2	701.4.1	2	701.4.4	2	701.4.15	2	701.4.15	2	701.4.15	2	701.4.19	2	701.4.21	2	701.4.27
BEARING SEAL							2	91P2-3	2	91P2-3	2	91P2-3						
SHIM	9	80P2-9	9	80P1-1	5	80P1-4	4	80P1-22	5	80P1-22	5	80P1-22	5	80P1-14	6	80P1-23	5	80P1-19
	2	80P3-7			5	80P2-1	4	80P2-18	5	80P2-18	5	80P2-18	5	80P2-11	6	80P2-19	3	80P2-15
	2	80P3-9												4	80P3-30	4	80P3-33	
CAP SCREW													12	5/16-18X1	12	5/16-18X1	12	5/16-18X1
NUT			4	50P19-1	2	50P19-2	2	50P19-2	2	50P19-2	4	50P19-2	2	50P19-3	4	50P19-2	4	50P19-1
LOCK WASHER													12	5/16	12	5/16	12	5/16
FELT WASHER																		
EXPANSION PLUG	2	45P1-11																
RELIEF FITTING																		
COTTER PIN	2	102P16-1																
LOCK RING	2	100P1-3																
CASTLE NUT	2	50P14-3																

KIT REF.	70.120.99		70.121.05		70.121.07		70.122.05		70.122.95		70.123.05		70.125.07		70.125.23		70.126.23	
PART REF	QTY	PART No.	QTY	PART No.	QTY	PART No.	QTY	PART No.	QTY	PART No.	QTY	PART No.	QTY	PART No.	QTY	PART No.	QTY	PART No.
KING PIN	2	105.38.2	2	105.24.10	2	105.21.8	2	105.35.3	2	105.35.3	2	105.55.2	2	95.16.6	2	105.18.2	2	105.18.2
BUSHING	4	201.21.13	4	202.16.9	4	202.19.8	4	202.19.10	4	202.19.9	4	202.19.10	4	202.16.7	4	202.18.1	4	202.18.1
STEEL LINER													2	312.16.2				
TAPER LOCK PINS	2	60M2-19	2	60M2-15	2	60M4-7	2	60M1-9	2	60M1-9	2	60M1-16			2	60M2-8	2	60M2-8
	2	60M2-20			2	60M4-8					2	60M1-17						
END PLATE / PLUG			4	401.129.1	4	401.128.1	4	45P6-1	4	45P6-1					4	401.20.1	4	401.20.1
O-RING GASKET	4	92P1-20	4	41P5-2	4	92P1-4	4	93P1-12	4	93P1-12	4	93P1-12	2	41P4-1				
BUSHING SEAL	4	91P1-32	4	91P1-25			4	91P1-29	4	91P1-29	4	91P1-29	4	91P3-1	4	91P1-44	4	91P1-44
BEARING	2	701.4.21	2	70P2-13	2	701.4.18	2	701.4.2	2	701.4.2	2	701.4.28	2	701.4.1	2	701.4.25	2	701.4.17
BEARING SEAL					2	91P2-9/10												
SHIM	6	80P1-23	5	80P1-14	5	80P1-2	3	80P1-2	3	80P1-2	3	80P1-2	4	80P3-3	5	80P1-2	5	80P1-2
	6	80P2-19	5	80P2-11	5	80P2-5	5	80P2-5	5	80P2-5	5	80P2-5	2	80P3-4	5	80P2-5	5	80P2-5
	4	80P3-30					4	80P3-24	4	80P3-24	2	80P3-24	2	80P3-5				
													2	80P3-6				
CAP SCREW	12	5/16-18X1	12	5/16-18X1											12	1/4-20 X 3/4	12	1/4-20 X 3/4
NUT	4	50P19-2	2	50P19-3			2	50P19-1	2	50P19-1	4	50P19-2			2	50P19-1	2	50P19-1
LOCK WASHER	12	5/16	12	5/16											12	1/4	12	1/4
FELT WASHER																		
EXPANSION PLUG					2	45P1-16							2	45P1-8				
RELIEF FITTING															4	90P1-1	4	90P1-1
COTTER PIN													2	102P16-1				
LOCK RING					2	100P1-7							2	100P1-2				
CASTLE NUT													2	50P14-1				

PLUSKIT® Components

KIT REF.	70.127.23		70.139.09		70.140.09		70.141.19		70.146.05		70.147.05		70.160.19		70.180.05		70.180.18		
PART REF	QTY	PART No.	QTY	PART No.	QTY	PART No.	QTY	PART No.	QTY	PART No.	QTY	PART No.	QTY	PART No.	QTY	PART No.	QTY	PART No.	
KING PIN	2	105.18.2	2	105.24.1	2	105.16.13	2	105.38.6	2	105.35.2	2	105.55.1	2	105.38.4	2	105.35.1	2	105.22.5	
BUSHING	4	202.18.1	4	202.17.1	4	202.17.1	4	202.21.10	4	202.18.8	4	202.18.8	4	202.21.10	4	202.18.4	4	202.21.2	
STEEL LINER																			
TAPER LOCK PINS	2	60M2-8	2	60M2-11	4	602.4.1	4	60M2-19	2	60M1-9	2	60M1-16	2	60M1-12	2	60M2-18	2	60M1-1	
							2	60M1-17			2	60M1-17	2	60M1-13			2	60M1-8	
END PLATE / PLUG	4	45P2-3										4	45P6-1						
O-RING GASKET			4	92P1-15	4	92P1-15	4	92P1-20	4	93P1-12	4	93P1-12	4	92P1-21	4	41P11-1	4	41P4-2	
							4	92P1-21											
BUSHING SEAL	4	91P1-44	4	91P3-1	4	91P3-1	4	91P1-34	4	91P1-36	4	91P1-36	4	91P1-34	4	91P1-36	4	91P1-15	
BEARING	2	701.4.20	2	701.4.1	2	701.4.1	2	701.4.11	2	701.4.24	2	701.4.25	2	701.4.37	2	701.4.24	2	701.4.37	
BEARING SEAL	2	91P2-11	2	91P2-2	2	91P2-2	2	91P2-4											
SHIM	5	80P1-2	7	80P1-1	7	80P1-1	3	80P1-23	3	80P1-24	3	80P1-24	3	80P1-23	3	80P1-9	3	80P1-9	
	5	80P2-5	2	80P3-13	2	80P3-13	3	80P2-19	5	80P2-20	5	80P2-20	3	80P2-19	3	80P2-7	3	80P2-7	
							2	80P3-30	2	80P3-31	2	80P3-31	2	80P3-30	2	80P3-29	2	80P3-29	
																2	80P3-34		
CAP SCREW																16	5/16-18X1	12	5/16-18 X 1
NUT			2	50P19-3			4	50P19-2	2	50P19-3	4	50P19-2	4	50P19-2	2	50P19-3	4	50P19-1	
LOCK WASHER															16	5/16	12	5/16	
FELT WASHER																			
EXPANSION PLUG																			
RELIEF FITTING																			
COTTER PIN																			
LOCK RING																			
CASTLE NUT																			

KIT REF.	70.181.18		70.230.07		70.309.09		70.310.09		70.533.13		70.616.13		70.700.20		70.901.12		70.921.12		
PART REF	QTY	PART No.	QTY	PART No.	QTY	PART No.	QTY	PART No.	QTY	PART No.	QTY	PART No.	QTY	PART No.	QTY	PART No.	QTY	PART No.	
KING PIN	2	105.22.2	2	105.35.6	2	105.24.2	2	105.16.12	2	95.15.3	2	95.18.2	1	105.60.1	2	105.21.1	2	105.21.2	
													1	105.61.1					
BUSHING	4	202.21.2	2	202.27.2	4	202.17.1	4	202.17.1	2	202.16.3	2	201.23.1	4	202.27.1	4	202.19.5	4	202.20.1	
			2	202.27.3															
STEEL LINER																			
TAPER LOCK PINS	2	60M1-4			2	60M2-11	4	602.4.1					4	60M2-27	2	60M7-3	2	60M7-3	
	2	60M1-8													2	60M7-4	2	60M7-4	
END PLATE / PLUG	4	401.128.2	4	401.146.1					2	45P10-2	2	45P10-1	4	401.145.1					
O-RING GASKET	4	92P1-9	4	92P1-41	4	92P1-15	4	92P1-15	2	92P1-30	2	92P1-30	4	92P1-32	2	41P7-1	4	41P7-1	
			2	92P1-42									4	92P1-39					
BUSHING SEAL	4	91P1-15			4	91P3-1	4	91P3-1	2	91P1-11	2	91P1-21	4	91P1-29	4	91P1-6	4	91P1-6	
									2	91P1-12	2	91P1-22							
BEARING	2	701.4.37	2	70P7-1	2	701.4.1	2	701.4.1	2	70P2-1	2	70P2-8	2	70P6-1	2	701.4.2	2	701.4.2	
									2	70P3-2	2	70P3-3							
BEARING SEAL					2	91P2-2	2	91P2-2										2	91P2-1
SHIM	3	80P1-9			7	80P1-1	11	80P1-1					4	80P1-30	5	80P1-2	5	80P1-2	
	3	80P2-7					12	80P3-13					10	80P2-27	8	80P2-5	8	80P2-5	
	2	80P3-29	2	80P3-53															
	2	80P3-34																	
CAP SCREW	12	5/16-18 X 1	12	5/16-24 X 3/4									2	3/8-16 X 1-1/4					
NUT	4	50P19-1			2	50P19-3							4	50P19-1	4	50P19-2	4	50P19-2	
LOCK WASHER	12	5/16	12	5/16															
FELT WASHER																			
EXPANSION PLUG									2	50P1-1	2	50P1-1			2	45P1-9			
RELIEF FITTING															2	90P1-1			
COTTER PIN																			
LOCK RING															2	100P1-1			
CASTLE NUT																			

KIT REF.	70.931.12		70.941.06		70.941.18		70.942.06		70.961.12		70.970.18		70.971.18		70.981.18		74.901.18	
PART REF	QTY	PART No.	QTY	PART No.	QTY	PART No.	QTY	PART No.	QTY	PART No.	QTY	PART No.	QTY	PART No.	QTY	PART No.	QTY	PART No.
KING PIN	2	105.21.3	2	105.33.2	2	105.52.1	2	105.33.2	2	105.21.3	2	105.16.5	2	105.16.7	2	105.21.12	2	105.14.1
BUSHING	4	202.20.1	4	202.19.7	4	202.15.5	4	202.19.5	4	202.20.1	4	202.16.7	4	202.16.7	4	202.19.10	4	202.14.6
STEEL LINER																		
TAPER LOCK PINS	2	60M1-1	2	60M1-1	2	60M1-7	2	60M1-1	2	60M1-7	4	602.4.1	4	602.4.1	2	60M1-7	4	602.4.1
	2	60M1-2	2	60M1-2	2	60M1-14	2	60M1-2	2	60M1-8					2	60M1-8		
END PLATE / PLUG					4	401.139.1	4	45P2-3							4	45P2-3		
O-RING GASKET	2	41P7-1	4	41P7-1	4	92P1-26			4	41P7-1	2	41P3-4	4	41P7-1			2	41P7-1
BUSHING SEAL	4	91P1-29	4	91P1-29	4	91P1-41	4	91P1-29	4	91P1-29					4	91P1-29		
BEARING	2	701.4.27	2	701.4.2	2	701.4.5	2	701.4.2	2	701.4.27	2	701.4.1	2	701.4.1	2	701.4.27	2	701.4.5
BEARING SEAL					2	91P2-15							2	91P2-7				
SHIM	5	80P1-2	5	80P1-2	5	80P2-21	9	80P1-2	5	80P1-2	13	80P1-1	7	80P1-1	5	80P1-19	5	80P1-5
	8	80P2-5	8	80P2-5			9	80P2-5	8	80P2-5					5	80P2-15	5	80P2-2
CAP SCREW					12	5/16-18X1												
NUT	4	50P19-1	4	50P19-1	4	50P19-1	4	50P19-1	4	50P19-1					4	50P19-1		
LOCK WASHER					12	5/16												
FELT WASHER																		
EXPANSION PLUG											2	45P1-8					2	45P1-11
RELIEF FITTING																		
COTTER PIN																		
LOCK RING											2	100P1-2					2	100P1-3
CASTLE NUT																		

KIT REF.	75.350.06		77.931.18		78.901.12		78.931.06		78.931.12		78.946.18							
PART REF	QTY	PART No.	QTY	PART No.	QTY	PART No.	QTY	PART No.	QTY	PART No.	QTY	PART No.	QTY	PART No.	QTY	PART No.	QTY	PART No.
KING PIN	2	105.10.2	2	105.21.3	2	105.22.1	2	105.22.2	2	105.22.2	2	105.21.14						
BUSHING	4	202.5.1	4	202.20.1	4	202.21.1	4	202.21.2	4	202.21.2	2	202.19.10						
											2	202.19.11						
STEEL LINER																		
TAPER LOCK PINS	2	60M2-3	2	60M1-1	4	60M4-4	2	60M1-3	2	60M1-3	2	60M1-3						
			2	60M1-2			2	60M1-4	2	60M1-4	2	60M1-4						
			2	60M1-8							2	60M1-8						
END PLATE / PLUG	4	45P2-2									4	45P7-1						
O-RING GASKET			4	41P7-1	2	41P4-2	4	41P4-2	4	41P4-2								
BUSHING SEAL	4	91P1-23	4	91P1-29			2	91P1-15	2	91P1-15	4	91P1-29						
BEARING	2	70P2-3	2	701.4.30	2	701.4.11	2	701.4.11	2	701.4.37	2	701.4.27						
BEARING SEAL																		
SHIM	5	80P1-10	5	80P1-2	5	80P1-9	5	80P1-9	5	80P1-9	5	80P1-2						
	5	80P2-8	8	80P2-5	9	80P2-7	9	80P2-7	9	80P2-7	5	80P2-5						
							2	80P3-29	2	80P3-29								
							2	80P3-34	2	80P3-34								
CAP SCREW																		
NUT	2	50P19-1	4	50P19-1			4	50P19-1	4	50P19-1	4	50P19-1						
LOCK WASHER																		
FELT WASHER																		
EXPANSION PLUG					2	45P1-10												
RELIEF FITTING																		
COTTER PIN																		
LOCK RING					2	100P1-5												
CASTLE NUT																		

ECONOKIT™ Components

KIT REF.	50.051.07		50.053.06		50.055.07		50.056.07		50.070.04		50.070.07		50.070.18		50.071.04		50.071.06	
PART REF	QTY	PART No.	QTY	PART No.	QTY	PART No.	QTY	PART No.	QTY	PART No.	QTY	PART No.	QTY	PART No.	QTY	PART No.	QTY	PART No.
KING PIN	2	105.11.9	2	105.50.3	2	105.11.10	2	105.11.10	2	105.2.1	2	105.12.1	2	105.52.3	2	105.2.1	2	105.13.6
BUSHING	4	201.11.3	4	201.2.3	4	201.11.7	4	201.11.10	4	201.2.1	4	201.12.1	4	201.15.7	4	201.2.1	4	201.13.4
STEEL LINER																		
TAPER LOCK PINS	2	60M3-1	2	60M2-3	2	60M1-15	2	60M1-15	4	602.4.1	2	60M3-1	2	60M1-14	4	602.4.1	2	60M2-17
													2	60M1-7				
END PLATE / PLUG															4	401.143.1	4	45P2-4
O-RING GASKET	4	41P3-6	4	92P1-19	4	41P3-6	4	41P3-6	2	41P3-4	4	41P3-1			4	92P1-16		
BUSHING SEAL					4	91P1-45	4	91P1-42					4	91P1-41	4	91P1-43	4	91P1-35
BEARING	2	701.2.1	2	701.4.4	2	701.4.14	2	701.4.19	2	701.4.4	2	701.4.4			2	701.4.34	2	70P2-15
BEARING SEAL													2	91P2-15				
SHIM	5	80P1-6	5	80P1-4	7	80P1-21	7	80P1-21	5	80P1-4	5	80P1-21	5	80P1-25	5	80P1-4	5	80P1-12
	5	80P2-3	5	80P2-1	5	80P2-17	5	80P2-17	5	80P2-1	5	80P2-17	5	80P2-21	5	80P2-1	5	80P2-10
CAP SCREW									4	5/16-18X3/4					8	5/16-18X3/4		
NUT	2	50P19-2	2	50P19-1	2	50P19-2	2	50P19-2			2	50P19-2	4	50P19-1			2	50P19-1
LOCK WASHER									4	5/16					8	5/16		
FELT WASHER																		
EXPANSION PLUG									2	45P1-6								
RELIEF FITTING									2	90P1-3				2	90P1-3			
COTTER PIN																		
LOCK RING									2	100P1-4								
CASTLE NUT																		

KIT REF.	50.072.06		50.073.06		50.075.06		50.076.06		50.080.18		50.095.06		50.095.07		50.096.06		50.098.09	
PART REF	QTY	PART No.	QTY	PART No.	QTY	PART No.	QTY	PART No.	QTY	PART No.	QTY	PART No.	QTY	PART No.	QTY	PART No.	QTY	PART No.
KING PIN	2	105.37.4	2	105.50.2	2	105.25.1	2	105.25.1	2	105.52.2	2	105.26.1	2	95.16.7	2	105.26.1	2	105.12.3
BUSHING	4	201.13.7	4	201.2.7	4	201.14.6	4	201.14.6	4	201.15.7	4	201.16.7	2	201.14.1	4	201.16.7	4	201.12.3
													2	201.14.2				
STEEL LINER													2	315.16.4				
TAPER LOCK PINS	2	60M1-10	2	60M2-3	2	60M1-1	2	60M1-1	2	60M1-14	2	60M1-1			2	60M1-1	2	60M7-1
	2	60M1-11			2	60M1-2	2	60M1-2	2	60M1-7	2	60M1-2			2	60M1-2		
END PLATE / PLUG	4	45P2-4					4	45P2-5							4	45P2-5		
O-RING GASKET			4	92P1-19	2	41P7-1					2	41P7-1	2	41P4-1			4	41P3-3
BUSHING SEAL	4	91P1-35			4	91P1-16	4	91P1-16	4	91P1-41	4	91P3-1			4	91P3-1		
BEARING	2	701.4.23	2	701.4.4	2	701.4.5	2	701.4.5	2	701.4.5	2	701.4.1	2	701.4.5	2	701.4.1	2	701.4.4
BEARING SEAL									2	91P2-15								
SHIM	5	80P2-10	5	80P1-4	5	80P1-5	5	80P1-5	5	80P1-25	9	80P1-1	9	80P2-9	9	80P1-1	5	80P1-4
			5	80P2-1	5	80P2-2	5	80P2-2	5	80P2-21			2	80P3-7			5	80P2-1
													2	80P3-9				
CAP SCREW																		
NUT	4	50P19-1	2	50P19-1	4	50P19-1	4	50P19-1	4	50P19-1	4	50P19-1			4	50P19-1	2	50P19-2
LOCK WASHER																		
FELT WASHER																		
EXPANSION PLUG					2	45P1-11					2	45P1-8	2	45P1-11				
RELIEF FITTING																		
COTTER PIN														2	102P16-1			
LOCK RING					2	100P1-3					2	100P1-2	2	100P1-3				
CASTLE NUT													2	50P14-3				

KIT REF.	50.101.09		50.102.09		50.103.19		50.108.09		50.109.09		50.120.05		50.120.09		50.120.18		50.121.05	
PART REF	QTY	PART No.	QTY	PART No.	QTY	PART No.	QTY	PART No.	QTY	PART No.	QTY	PART No.	QTY	PART No.	QTY	PART No.	QTY	PART No.
KING PIN	2	105.13.1	2	105.37.1	2	105.56.1	2	105.27.1	2	105.14.2	2	105.24.10	2	105.38.2	2	105.33.3	2	105.24.10
BUSHING	4	201.13.1	4	201.13.1	4	201.13.1	4	201.14.4	4	201.14.4	4	201.16.9	4	201.21.11	4	201.20.1	4	201.16.9
STEEL LINER																		
TAPER LOCK PINS	2	60M7-1	2	60M4-10	4	60M2-20	2	60M2-11	4	602.4.1	2	60M2-15	2	60M2-19	2	60M1-1	2	60M2-15
			2	60M4-11								2	60M2-20	2	60M1-8			
			2	60M7-8														
END PLATE / PLUG							4	401.3.1	4	401.3.1	4	401.129.1			4	401.128.1	4	401.129.1
O-RING GASKET	4	92P1-16	4	92P1-16	4	92P1-28	4	92P1-8	4	92P1-8	4	41P5-2	4	92P1-20	4	92P1-4	4	41P5-2
BUSHING SEAL	4	91P1-14	4	91P1-14	4	91P1-14	4	91P1-19			4	91P1-25	4	91P1-32	4	91P1-29	4	91P1-25
BEARING	2	701.4.15	2	701.4.15	2	701.4.15	2	701.4.5	2	701.4.5	2	701.4.19	2	701.4.21	2	701.4.27	2	70P2-13
BEARING SEAL	2	91P2-3	2	91P2-3	2	91P2-3	2	91P2-6										
SHIM	5	80P1-22	5	80P1-22	5	80P1-22	7	80P1-1	7	80P1-1	5	80P1-14	6	80P1-23	5	80P1-19	5	80P1-14
	5	80P2-18	5	80P2-18	5	80P2-18				5	80P2-11	6	80P2-19	3	80P2-15	5	80P2-11	
												4	80P3-30	4	80P3-33			
CAP SCREW							12	5/16-18X3/4	12	5/16-18X3/4	12	5/16-18X1	12	5/16-18X1	12	5/16-18X1	12	5/16-18X1
NUT	2	50P19-2			4	50P19-2	2	50P19-3			2	50P19-3	4	50P19-2	4	50P19-1	2	50P19-3
LOCK WASHER							12	5/16	12	5/16	12	5/16	12	5/16	12	5/16	12	5/16
FELT WASHER																		
EXPANSION PLUG																		
RELIEF FITTING																		
COTTER PIN																		
LOCK RING																		
CASTLE NUT																		

KIT REF.	50.121.07		50.121.08		50.122.05		50.123.05		50.125.07		50.125.23		50.126.23		50.127.23		50.139.09	
PART REF	QTY	PART No.	QTY	PART No.	QTY	PART No.	QTY	PART No.	QTY	PART No.	QTY	PART No.	QTY	PART No.	QTY	PART No.	QTY	PART No.
KING PIN	2	105.21.8			2	105.35.3	2	105.55.2	2	95.16.6	2	105.18.2	2	105.18.2	2	105.18.2	2	105.24.1
BUSHING	4	201.19.8	4	201.18.10	4	201.19.10	2	201.19.10	4	201.16.7	4	201.18.1	4	201.18.1	4	201.18.1	4	201.17.1
STEEL LINER									2	315.16.2								
TAPER LOCK PINS	2	60M4-7			2	60M1-9	2	60M1-16			2	60M2-8	2	60M2-8	2	60M2-8	2	60M2-11
	2	60M4-8					2	60M1-17										
END PLATE / PLUG	4	401.128.1	4	45P8-1	4	45P6-1					4	401.20.1	4	401.20.1	4	45P2-3		
O-RING GASKET	4	92P1-4	4	92P1-17	4	93P1-12	4	93P1-12	2	41P4-1	4	92P1-4	4	92P1-4	4	92P1-4	4	92P1-15
BUSHING SEAL			4	91P1-44	4	91P1-29	4	91P1-29	4	91P3-1	4	91P1-44	4	91P1-44	4	91P1-44	4	91P3-1
BEARING	2	701.4.18	1	701.4.30	2	701.4.2	2	701.4.28	2	701.4.1	2	701.4.25	2	701.4.17	2	701.4.20	2	701.4.1
			1	701.5.1														
BEARING SEAL	2	91P2-9/10													2	91P2-11	2	91P2-2
SHIM	5	80P1-2	8	80P1-2	3	80P1-2	3	80P1-2	4	80P3-3	7	80P1-2	7	80P1-2	6	80P1-2	7	80P1-1
	5	80P2-5	2	80P3-35	5	80P2-5	5	80P2-5	2	80P3-4	6	80P2-5	6	80P2-5	6	80P2-5	2	80P3-13
					4	80P3-24	2	80P3-24	2	80P3-5								
									2	80P3-6								
CAP SCREW			4	5/8-11X1.25							12	1/4-20X1/2	12	1/4-20X1/2	12	1/4-20X1/2		
NUT					2	50P19-1	4	50P19-2			2	50P19-1	2	50P19-1	2	50P19-1	2	50P19-3
LOCK WASHER											12	1/4	12	1/4	12	1/4		
FELT WASHER																		
EXPANSION PLUG	2	45P1-16							2	45P1-8								
RELIEF FITTING											4	90P1-1	4	90P1-1	4	90P1-1		
COTTER PIN									2	102P16-1								
LOCK RING	2	100P1-7	4	103P1-1					2	100P1-2								
CASTLE NUT									2	50P14-1								

ECONOKIT™ Components

KIT REF.	50.140.09		50.141.19		50.146.05		50.147.05		50.160.19		50.180.05		50.180.18		50.181.18		50.309.09	
PART REF	QTY	PART No.	QTY	PART No.	QTY	PART No.	QTY	PART No.	QTY	PART No.	QTY	PART No.	QTY	PART No.	QTY	PART No.	QTY	PART No.
KING PIN	2	105.16.13	2	105.38.6	2	105.35.2	2	105.55.1	2	105.38.4	2	105.35.1	2	105.22.5	2	105.22.2	2	105.24.2
BUSHING	4	201.17.1	4	201.21.10	4	201.18.8	4	201.18.8	4	201.21.10	4	201.18.4	4	201.21.2	4	201.21.2	4	201.17.1
STEEL LINER																		
TAPER LOCK PINS	4	602.4.1	4	60M2-19	2	60M1-9	2	60M1-16	2	60M1-12	2	60M2-18	2	60M1-1	2	60M1-4	2	60M2-11
			2	60M1-17			2	60M1-17	2	60M1-13			2	60M1-8	2	60M1-8		
END PLATE / PLUG							4	45P6-1							4	401.128.2		
O-RING GASKET	4	92P1-15	4	92P1-20	4	93P1-12	4	93P1-12	4	92P1-21	4	41P11-1	4	41P4-2	4	92P1-9	4	92P1-15
			4	92P1-21														
BUSHING SEAL	4	91P3-1	4	91P1-34	4	91P1-36	4	91P1-36	4	91P1-34	4	91P1-36	4	91P1-15	4	91P1-15	4	91P3-1
BEARING	2	701.4.1	2	701.4.37	2	701.4.24	2	701.4.25	2	701.4.37	2	701.4.24	2	701.4.37	2	701.4.37	2	701.4.1
BEARING SEAL	2	91P2-2															2	91P2-2
SHIM	7	80P1-1	3	80P1-23	3	80P1-24	3	80P1-24	3	80P1-23	3	80P1-9	3	80P1-9	3	80P1-9	7	80P1-1
	2	80P3-13	3	80P2-19	5	80P2-20	5	80P2-20	3	80P2-19	3	80P2-7	3	80P2-7	3	80P2-7		
			4	80P3-30	2	80P3-31	2	80P3-31	2	80P3-30	2	80P3-29	2	80P3-29	2	80P3-29		
												2	80P3-34	2	80P3-34			
CAP SCREW												16	5/16-18X1	12	5/16-18 X 1	12	5/16-18 X 1	
NUT			4	50P19-2	2	50P19-3	4	50P19-2	4	50P19-2	2	50P19-3	4	50P19-1	4	50P19-1	2	50P19-3
LOCK WASHER												16	5/16	12	5/16	12	5/16	
FELT WASHER																		
EXPANSION PLUG																		
RELIEF FITTING																		
COTTER PIN																		
LOCK RING																		
CASTLE NUT																		

KIT REF.	50.310.09		50.533.13		50.616.13		50.901.12		50.921.12		50.931.12		50.941.06		50.941.18		50.942.06	
PART REF	QTY	PART No.	QTY	PART No.	QTY	PART No.	QTY	PART No.	QTY	PART No.	QTY	PART No.	QTY	PART No.	QTY	PART No.	QTY	PART No.
KING PIN	2	105.16.12	2	95.15.3	2	95.18.2	2	105.21.1	2	105.21.2	2	105.21.3	2	105.33.2	2	105.52.1	2	105.33.2
BUSHING	4	201.17.1	2	201.16.3	2	201.23.1	4	201.19.5	4	201.20.1	4	201.20.1	4	201.19.5	4	201.15.7	4	201.19.5
STEEL LINER																		
TAPER LOCK PINS	4	602.4.1					2	60M7-3	2	60M7-3	2	60M1-1	2	60M1-1	2	60M1-7	2	60M1-1
							2	60M7-4	2	60M7-4	2	60M1-2	2	60M1-2	2	60M1-14	2	60M1-2
END PLATE / PLUG			2	45P10-2	2	45P10-1									4	401.139.1	4	45P2-3
O-RING GASKET	4	92P1-15	2	92P1-30	2	92P1-30	2	41P7-1	4	41P7-1	2	41P7-1	4	41P7-1	4	92P1-26		
BUSHING SEAL	4	91P3-1	2	91P1-11	2	91P1-21	4	91P1-29	4	91P1-6	4	91P1-29	4	91P1-29	4	91P1-41	4	91P1-29
			2	91P1-12	2	91P1-22												
BEARING	2	701.4.1	2	70P2-1	2	70P2-8	2	701.4.2	2	701.4.2	2	701.4.27	2	701.4.2	2	701.4.5	2	701.4.2
			2	70P3-2	2	70P3-3												
BEARING SEAL	2	91P2-2						2	91P2-1						2	91P2-15		
SHIM	11	80P1-1					5	80P1-2	5	80P1-2	5	80P1-2	5	80P1-2	5	80P2-21	9	80P1-2
	12	80P3-13					8	80P2-5	8	80P2-5	8	80P2-5	8	80P2-5			7	80P2-5
CAP SCREW																		
NUT							4	50P19-2	4	50P19-2	4	50P19-1	4	50P19-1	12	5/16-18X1	4	50P19-1
LOCK WASHER															12	5/16	4	50P19-1
FELT WASHER																		
EXPANSION PLUG			2	50P4-1	2	50P4-1	2	45P1-9										
RELIEF FITTING							2	90P1-1										
COTTER PIN																		
LOCK RING							2	100P1-1										
CASTLE NUT																		

KIT REF.	50.961.12		50.970.18		50.971.18		50.981.18		54.901.18		55.350.06		57.931.18		58.901.12		58.931.06		
PART REF	QTY	PART No.	QTY	PART No.	QTY	PART No.	QTY	PART No.	QTY	PART No.	QTY	PART No.	QTY	PART No.	QTY	PART No.	QTY	PART No.	
KING PIN	2	105.21.3	2	105.16.5	2	105.16.7	2	105.21.12	2	105.14.1	2	105.10.3	2	105.21.3	2	105.22.1	2	105.22.2	
BUSHING	4	201.20.1	4	201.16.7	4	201.16.7	4	201.19.10	4	201.14.6	4	201.5.1	4	201.20.1	4	201.21.1	4	201.21.2	
STEEL LINER																			
TAPER LOCK PINS	2	60M1-7	4	602.4.1	4	602.4.1	2	60M1-7	4	602.4.1	2	60M2-3	2	60M1-1	4	60M4-4	2	60M1-3	
	2	60M1-8					2	60M1-8					2	60M1-2			2	60M1-4	
													2	60M1-8					
END PLATE / PLUG							4	45P2-3				4	45P2-2						
O-RING GASKET	4	41P7-1	2	41P3-4	4	41P7-1			2	41P7-1			4	41P7-1	2	41P4-2	4	41P4-2	
BUSHING SEAL	4	91P1-29					4	91P1-29				4	91P1-23	4	91P1-29			4	91P1-15
BEARING	2	701.4.27	2	701.4.1	2	701.4.1	2	701.4.27	2	701.4.5	2	70P2-3	2	701.4.30	2	701.4.11	2	701.4.11	
BEARING SEAL					2	91P2-7													
SHIM	5	80P1-2	13	80P1-1	7	80P1-1	3	80P1-19	5	80P1-5	5	80P1-10	5	80P1-2	5	80P1-9	5	80P1-9	
	8	80P2-5					3	80P2-15	5	80P2-2	5	80P2-8	8	80P2-5	9	80P2-7	9	80P2-7	
																	2	80P3-29	
																	2	80P3-34	
CAP SCREW																			
NUT	4	50P19-1					4	50P19-1				2	50P19-1	4	50P19-1			4	50P19-1
LOCK WASHER																			
FELT WASHER																			
EXPANSION PLUG			2	45P1-8					2	45P1-11				2	45P1-10				
RELIEF FITTING																			
COTTER PIN																			
LOCK RING			2	100P1-2					2	100P1-3				2	100P1-5				
CASTLE NUT																			

KIT REF.	58.931.12		58.946.18															
PART REF	QTY	PART No.	QTY	PART No.	QTY	PART No.	QTY	PART No.	QTY	PART No.	QTY	PART No.	QTY	PART No.	QTY	PART No.	QTY	PART No.
KING PIN	2	105.22.2	2	105.21.14														
BUSHING	4	201.21.2	2	201.19.10														
			2	201.19.11														
STEEL LINER																		
TAPER LOCK PINS	2	60M1-3	2	60M1-3														
	2	60M1-4	2	60M1-4														
			2	60M1-8														
END PLATE / PLUG			4	45P7-1														
O-RING GASKET	4	41P4-2																
BUSHING SEAL	4	91P1-15	4	91P1-29														
BEARING	2	701.4.37	2	701.4.27														
BEARING SEAL																		
SHIM	5	80P1-9	5	80P1-2														
	9	80P2-7	5	80P2-5														
	2	80P3-29																
	2	80P3-34																
CAP SCREW																		
NUT	4	50P19-1	4	50P19-1														
LOCK WASHER																		
FELT WASHER																		
EXPANSION PLUG																		
RELIEF FITTING																		
COTTER PIN																		
LOCK RING																		
CASTLE NUT																		

QWIKTIE™ Tie Rod Assembly



HIGHLY ADAPTABLE FOR MAXIMUM EFFICIENCY

Designed to increase simplicity and safety. STEMCO® QWIKTIE™ tie rod assembly offers a highly adaptable solution that can accommodate a wide range of straight tie rod lengths.

Advanced Technology

QWIKTIE's versatile range of adjustment makes it a flexible stock addition. QWIKTIE tie rod assemblies are highly adjustable to fit over 80% of the straight tie rod lengths and styles in the market. QWIKTIE features easy color attributes for identification and accurate installation. Patent Pending.

Increased Versatility

With a versatile tie rod solution, QWIKTIE tie rod assemblies reduce overhead for maximum efficiency. QWIKTIE fits from 57 ³/₈" to 73 ⁷/₈" total length from grease zerk to zerk.

Increased Strength

Increased strength certifies the ability to hold the alignment longer, reducing stress on other suspension

components providing increased fuel and tire mileage. QWIKTIE assemblies are heavy duty with a thicker and stronger cross-tube material for demanding loads.

Greater Accuracy

Finer threads provide more precise adjustment and increased strength to hold the alignment longer reducing stress on the steering system. Threads are pre-lubricated for ease of installation and easy adjustment over time.

Safe and Secure

Alignment settings secured with time saving precision achieve a safe, secure connection between the tie rod and threaded tie rod end.



STEMCO®

A Higher Standard of Performance.™

an EnPro Industries company

Making the Roadways Safer®

COMPETITOR #	ASSEMBLY	LEFT*	RIGHT*
AUTOCAR			
872469	QT967SS		QTE967R
872470	QT967SS	QTE967L	
85108888	QT108SB	QTE108L	
85108889	QT108SB		QTE108R
85112008	QT108SB		QTE108R
85112009	QT108SB	QTE108L	
370240004	QT967SS	QTE967L	
370240005	QT967SS		QTE967R
370245001	QT108SB	QTE108L	
370245002	QT108SB		QTE108R
887783A	QT108SB	QTE108L	
887784A	QT108SB		QTE108R
A8010185	QT108SB		QTE108R
A8010186	QT108SB	QTE108L	
A8015593	QT108SB	QTE108L	
A8015594	QT108SB		QTE108R
L24SV5042A12	QT967SS		QTE967R
L24SV5043A12	QT967SS	QTE967L	
AUTOMANN			
462.ES187L	QT967SS	QTE967L	
462.ES187R	QT967SS		QTE967R
462.ES2090L	QT108SB	QTE108L	
462.ES2090LS	QT108SB	QTE108L	
462.ES2091R	QT108SB		QTE108R
462.ES2091RS	QT108SB		QTE108R
462.ES2118L	QT967SS		QTE967R
462.ES2203R	QT967SS		QTE967R
462.ES2614L	QT967SS	QTE967L	
462.ES2614R	QT967SS		QTE967R
462.ES3030R	QT108SB		QTE108R
462.ES3031L	QT108SB	QTE108L	
462.ES3033L	QT108SB	QTE108L	
462.ES3034R	QT108SB		QTE108R
462.ES3176R	QT967SS		QTE967R
462.ES3177L	QT967SS	QTE967L	
462.ES3219L	QT967SS	QTE967L	
462.ES3220R	QT967SS		QTE967R
462.ES3297R	QT967SS		QTE967R
462.ES3298L	QT967SS	QTE967L	
462.ES3312R	QT967SS		QTE967R
462.ES3442R	QT967SS		QTE967R
462.ES3443L	QT967SS	QTE967L	
462.ES346L	QT108SB		QTE108R
462.ES346R	QT108SB	QTE108L	
462.ES411L	QT967SS	QTE967L	
462.ES411R	QT967SS		QTE967R
462.ES423L	QT967SS	QTE967L	
462.ES423R	QT967SS		QTE967R
462.ES431L	QT108SB		QTE108R
462.ES431LS	QT108SB		QTE108R
462.ES431R	QT108SB	QTE108L	
462.ES431RS	QT108SB	QTE108L	
462.ES4601L	QT108SB	QTE108L	
462.ES4601R	QT108SB		QTE108R
462.ES9001L	QT967SS	QTE967L	
462.ES9001R	QT967SS		QTE967R
462.ES9328L	QT108SB	QTE108L	
462.ES9329R	QT108SB		QTE108R

COMPETITOR #	ASSEMBLY	LEFT*	RIGHT*
AUTOMANN			
462.ES9678L	QT967SS	QTE967L	
462.ES9679R	QT967SS		QTE967R
BATCO			
21187L	QT967SS	QTE967L	
21187R	QT967SS		QTE967R
212041L	QT108SB	QTE108L	
212091R	QT108SB		QTE108R
212115R	QT108SB		QTE108R
212116L	QT108SB	QTE108L	
212118L	QT967SS		QTE967R
212202R	QT108SB		QTE108R
212204R	QT108SB		QTE108R
212207R	QT108SB		QTE108R
212208R	QT108SB		QTE108R
212209R	QT108SB		QTE108R
21220R	QT108SB		QTE108R
212614R	QT967SS		QTE967R
213030R	QT108SB		QTE108R
213034R	QT108SB		QTE108R
21346L	QT108SB		QTE108R
21346R	QT108SB	QTE108L	
21376L	QT108SB	QTE108L	
21411L	QT967SS	QTE967L	
21411R	QT967SS		QTE967R
21423L	QT967SS	QTE967L	
21423R	QT967SS		QTE967R
21431L	QT108SB		QTE108R
21431R	QT108SB	QTE108L	
BLUE BIRD			
63810	QT967SS	QTE967L	
663811	QT108SB		QTE967R
2597151	QT967SS	QTE967L	
2597250	QT108SB		QTE967R
4278487	QT967SS	QTE967L	
4278503	QT108SB		QTE967R
CHEVROLET / GMC			
685504	QT108SB		QTE108R
685505	QT108SB	QTE108L	
798203	QT108SB		QTE108R
798204	QT108SB	QTE108L	
2452860	QT108SB		QTE108R
2452861	QT108SB	QTE108L	
12541319	QT108SB	QTE108L	
12541320	QT108SB		QTE108R
15579760	QT108SB		QTE108R
88936085	QT108SB	QTE108L	
88936086	QT108SB		QTE108R
CHRYSLER			
1643277	QT967SS		QTE967R
1643278	QT967SS	QTE967L	
2585607	QT108SB	QTE108L	
2585608	QT108SB		QTE108R
3634206	QT108SB		QTE108R
3634207	QT108SB	QTE108L	
3744496	QT967SS		QTE967R
3744497	QT967SS	QTE967L	
L24SV5042A12	QT967SS		QTE967R
L24SV5043A12	QT967SS	QTE967L	

COMPETITOR #	ASSEMBLY	LEFT*	RIGHT*
DANA			
2692705	QT967SS		QTE967R
120TR109	QT967SS	QTE967L	
120TR110	QT967SS		QTE967R
120TR111	QT967SS	QTE967L	
120TR112	QT967SS		QTE967R
140TR111	QT967SS	QTE967L	
140TR112	QT967SS		QTE967R
220TR115	QT108SB	QTE108L	
220TR116	QT108SB		QTE108R
220TR118	QT108SB	QTE108L	
220TR119	QT108SB		QTE108R
DAYTON			
310-121	QT967SS	QTE967L	
310-122	QT967SS		QTE967R
310-169	QT108SB	QTE108L	
310-170	QT108SB		QTE108R
310-215	QT967SS	QTE967L	
310-216	QT967SS		QTE967R
310-222	QT967SS	QTE967L	
310-223	QT967SS		QTE967R
310-228	QT108SB		QTE108R
310-228SF	QT108SB		QTE108R
310-229	QT108SB	QTE108L	
310-229SF	QT108SB	QTE108L	
310-285	QT967SS	QTE967L	
310-286	QT967SS		QTE967R
310-296	QT967SS		QTE967R
310-316	QT108SB		QTE108R
310-317	QT967SS		QTE967R
310-322	QT108SB		QTE108R
310-381	QT967SS		QTE967R
310-395	QT108SB		QTE108R
310-396	QT108SB	QTE108L	
310-397	QT108SB	QTE108L	
310-397SF	QT108SB	QTE108L	
310-398	QT108SB		QTE108R
310-398SF	QT108SB		QTE108R
310-424	QT108SB	QTE108L	
310-425	QT108SB		QTE108R
310-433	QT108SB	QTE108L	
310-434	QT108SB		QTE108R
310-436	QT967SS		QTE967R
310-455	QT967SS		QTE967R
310-456	QT967SS	QTE967L	
310-463	QT108SB	QTE108L	
310-464	QT108SB		QTE108R
310-471	QT967SS	QTE967L	
310-472	QT967SS		QTE967R
310-483	QT967SS		QTE967R
310-484	QT967SS	QTE967L	
DODGE			
1643277	QT967SS	QTE967L	
1643278	QT967SS		QTE967R
3744496	QT967SS		QTE967R
3744497	QT967SS	QTE967L	
EATON			
310216	QT967SS		QTE967R
817018	QT967SS	QTE967L	

* Only compatible with STEMCO Cross Tube QTT5773

Tie Rod End Reference

QTE967 R - L (small taper - Green cap)
 Thread Diameter 1 1/8" Minor OD on taper 0.967"
 Including ES2203R, ES3442R, ES3443L

QTE108 R - L (big taper - Red cap)
 Thread Diameter 1 1/4" Minor OD on taper 1.080" Including ES5945R, ES5945L

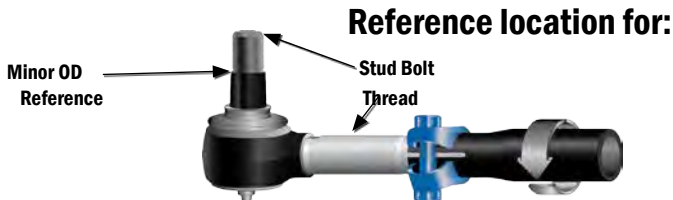

Tie Rod End Interchange to QWIKTIE Assembly

COMPETITOR #	ASSEMBLY	LEFT*	RIGHT*
EATON			
817019	QT967SS		QTE967R
818471	QT108SB		QTE108R
818472	QT108SB	QTE108L	
820626	QT108SB	QTE108L	
820627	QT108SB		QTE108R
820694	QT108SB	QTE108L	
820695	QT108SB		QTE108R
970701	QT967SS	QTE967L	
970702	QT967SS		QTE967R
971128	QT108SB	QTE108L	
971129	QT108SB		QTE108R
1006147	QT967SS		QTE967R
1006148	QT967SS	QTE967L	
1006149	QT967SS		QTE967R
1009009	QT967SS	QTE967L	
1009010	QT967SS		QTE967R
L24SV5042A12	QT967SS		QTE967R
L24SV5043A12	QT967SS	QTE967L	
TE2007	QT967SS	QTE967L	
TE2008	QT967SS		QTE967R
TE2017	QT108SB	QTE108L	
TE2018	QT108SB		QTE108R
TE2021	QT108SB	QTE108L	
TE2022	QT108SB		QTE108R
TE2026	QT967SS		QTE967R
TE2027	QT967SS	QTE967L	
TE2029	QT967SS	QTE967L	
TE2030	QT967SS		QTE967R
TE2041	QT108SB	QTE108L	
TE2042	QT108SB		QTE108R
TE2043	QT108SB		QTE108R
TE2044	QT108SB		QTE108R
TE2045	QT108SB	QTE108L	
TE2046	QT967SS		QTE967R
TE2048	QT967SS		QTE967R
TE2349	QT108SB		QTE108R
TE2350	QT108SB		QTE108R
TE2453	QT108SB		QTE108R
ELGIN			
ES187L	QT967SS	QTE967L	
ES187R	QT967SS		QTE967R
ES2091R	QT108SB		QTE108R
ES2113R	QT108SB	QTE108L	
ES2118L	QT967SS		QTE967R
ES2203R	QT967SS		QTE967R
ES2208R	QT108SB		QTE108R
ES2614R	QT967SS		QTE967R
ES3030R	QT108SB		QTE108R
ES3176R	QT967SS		QTE967R
ES3177L	QT967SS	QTE967L	
ES3178R	QT967SS		QTE967R
ES3216R	QT967SS		QTE967R
ES3217L	QT967SS	QTE967L	
ES3218R	QT967SS		QTE967R
ES3219L	QT967SS	QTE967L	
ES3220R	QT967SS		QTE967R
ES3297R	QT967SS		QTE967R
ES3298L	QT967SS	QTE967L	

COMPETITOR #	ASSEMBLY	LEFT*	RIGHT*
ELGIN			
ES3312R	QT967SS		QTE967R
ES3442R	QT967SS		QTE967R
ES3443L	QT967SS	QTE967L	
ES346L	QT108SB		QTE108R
ES346R	QT108SB	QTE108L	
ES3476	QT967SS		QTE967R
ES3477	QT967SS	QTE967L	
ES411L	QT967SS	QTE967L	
ES411R	QT967SS		QTE967R
ES423L	QT967SS	QTE967L	
ES423R	QT967SS		QTE967R
ES431L	QT108SB		QTE108R
ES431LA	QT108SB		QTE108R
ES431R	QT108SB	QTE108L	
ES431RA	QT108SB	QTE108L	
EUCLID			
E-10137	QT967SS		QTE967R
E-10138	QT967SS	QTE967L	
E-11023	QT967SS		QTE967R
E-11788	QT967SS		QTE967R
E-11789	QT967SS	QTE967L	
E-11981	QT967SS		QTE967R
E-14326	QT967SS	QTE967L	
E-4610	QT967SS	QTE967L	
E-4611	QT967SS		QTE967R
E-4614	QT967SS	QTE967L	
E-4615	QT967SS		QTE967R
E-4616	QT108SB	QTE108L	
E-4617	QT108SB		QTE108R
E-4617TU	QT108SB		QTE108R
E-4618	QT108SB		QTE108R
E-4619	QT108SB	QTE108L	
E-4628	QT108SB	QTE108L	
E-4629	QT108SB		QTE108R
E-4630	QT967SS	QTE967L	
E-4631	QT967SS		QTE967R
E-4640	QT967SS		QTE967R
E-4642	QT108SB		QTE108R
E-5393	QT108SB		QTE108R
E-5396	QT108SB	QTE108L	
E-5397	QT108SB		QTE108R
E-5470	QT967SS		QTE967R
E-6849	QT967SS		QTE967R
E-6856	QT108SB		QTE108R
E-6857	QT108SB	QTE108L	
E-8757	QT967SS	QTE967L	
E-8758	QT967SS		QTE967R
E-9877	QT108SB		QTE108R
E-9878	QT108SB	QTE108L	
E-9879	QT108SB		QTE108R
E-9880	QT108SB	QTE108L	
E-9949	QT967SS	QTE967L	
E-9950	QT967SS		QTE967R
E-9951	QT967SS	QTE967L	
E-9952	QT967SS		QTE967R
E-9956	QT967SS		QTE967R
E-9962	QT967SS	QTE967L	
E-9963	QT967SS		QTE967R

COMPETITOR #	ASSEMBLY	LEFT*	RIGHT*
FLAGG			
ES187L	QT967SS	QTE967L	
ES187R	QT967SS		QTE967R
ES2090L	QT108SB	QTE108L	
ES2091R	QT108SB		QTE108R
ES2114R	QT108SB		QTE108R
ES2116L	QT108SB	QTE108L	
ES2118L	QT967SS		QTE967R
ES2202R	QT108SB		QTE108R
ES2203R	QT967SS		QTE967R
ES2208R	QT108SB		QTE108R
ES2614R	QT967SS		QTE967R
ES3030R	QT108SB		QTE108R
ES3031L	QT108SB	QTE108L	
ES3176R	QT967SS		QTE967R
ES3177L	QT967SS	QTE967L	
ES3178R	QT967SS		QTE967R
ES3216R	QT967SS		QTE967R
ES3217L	QT967SS	QTE967L	
ES3218R	QT967SS		QTE967R
ES3219L	QT967SS	QTE967L	
ES3297R	QT967SS		QTE967R
ES3298L	QT967SS	QTE967L	
ES3312R	QT967SS		QTE967R
ES3442R	QT967SS		QTE967R
ES3443L	QT967SS	QTE967L	
ES3476	QT967SS		QTE967R
ES3477	QT967SS	QTE967L	
ES376L	QT108SB	QTE108L	
ES376R	QT108SB		QTE108R
ES411L	QT967SS	QTE967L	
ES411R	QT967SS		QTE967R
ES423L	QT967SS	QTE967L	
ES423R	QT967SS		QTE967R
ES431LA	QT108SB		QTE108R
ES431LS	QT108SB		QTE108R
ES431R	QT108SB	QTE108L	
ES431RA	QT108SB	QTE108L	
ES431RS	QT108SB	QTE108L	
ES9001L	QT967SS	QTE967L	
ES9001R	QT967SS		QTE967R
ES9009	QT967SS	QTE967L	
ES9010	QT967SS		QTE967R
KW1	QT108SB		QTE108R
FLEETRITE			
FTR2091R	QT108SB		QTE108R
FTR2203R	QT967SS		QTE967R
FTR2208R	QT108SB		QTE108R
FTR2614R	QT967SS		QTE967R
FTR3030R	QT108SB		QTE108R
FTR3034R	QT108SB		QTE108R
FTR346L	QT108SB		QTE108R
FTR346R	QT108SB	QTE108L	
FTR411L	QT967SS	QTE967L	
FTR411R	QT967SS		QTE967R
FTR423L	QT967SS	QTE967L	
FTR423R	QT967SS		QTE967R
FTR431L	QT108SB		QTE108R
FTR431R	QT108SB	QTE108L	

* Only compatible with STEMCO Cross Tube QTT5773

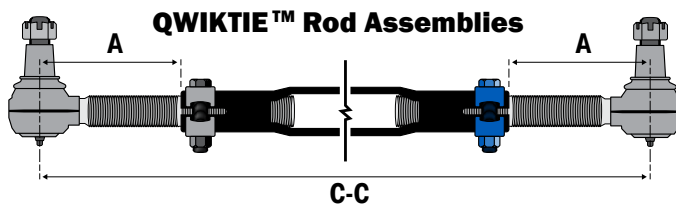

Fit a wide range of configurations,
QT967SS typical for 12,000 # axles (Green cap)
QT108SB typical for 16 & 20,000 # axles (Red cap)
Qwik Tie Assemblies adjust C-C 57⁵/₈" to 73⁵/₈"

When extending Rod Ends to the proper C-C
Maintain equal distance on both Left and Right A=A
Do not overextend beyond the groove on the thread

COMPETITOR #	ASSEMBLY	LEFT*	RIGHT*
FORD			
4C403280BA	QT967SS	QTE967L	
4C403A130JA	QT967SS		QTE967R
4C403A130KA	QT967SS	QTE967L	
4C403A130LA	QT967SS		QTE967R
4C403A130MA	QT967SS	QTE967L	
4C403A130NA	QT967SS		QTE967R
4C403A130PA	QT967SS	QTE967L	
4C4Z3280AA	QT967SS		QTE967R
4C4Z3280BA	QT967SS	QTE967L	
4C4Z3A130J	QT967SS		QTE967R
4C4Z3A130K	QT967SS	QTE967L	
4C4Z3A130LA	QT967SS		QTE967R
4C4Z3A130MA	QT967SS	QTE967L	
4C4Z3A130NA	QT967SS		QTE967R
4C4Z3A130PA	QT967SS	QTE967L	
B5TZ3A130A	QT967SS		QTE967R
B5TZ3A131A	QT967SS	QTE967L	
B8TZ-3A130B	QT108SB	QTE108L	
B8TZ3A131B	QT108SB		QTE108R
C1TZ3A130C	QT967SS		QTE967R
C1TZ3A131C	QT967SS	QTE967L	
C8TZ3A130A	QT967SS		QTE967R
D0HZ3A130A	QT967SS		QTE967R
D0HZ3A130B	QT108SB		QTE108R
D0HZ3A130C	QT108SB		QTE108R
D0HZ3A131A	QT967SS	QTE967L	
D0HZ3A131B	QT108SB	QTE108L	
D0HZ3A131C	QT108SB	QTE108R	
E3HZ3A130A	QT967SS		QTE967R
E3HZ3A131A	QT967SS	QTE967L	
E4HZ3A130A	QT967SS		QTE967R
E4HZ3A130B	QT967SS		QTE967R
E4HZ3A131A	QT967SS	QTE967L	
F1HZ3A130A	QT967SS		QTE967R
F1HZ3A130B	QT967SS		QTE967R
F1HZ3A131A	QT967SS	QTE967L	
F3HZ3A130B	QT967SS		QTE967R
F3HZ3A131A	QT967SS	QTE967L	
F5HZ3A130AA	QT967SS		QTE967R
F5HZ3A131AA	QT967SS	QTE967L	
F6HZ3A130AA	QT967SS		QTE967R
F6HZ3A131AA	QT967SS	QTE967L	
FREIGHTLINER			
817018	QT967SS	QTE967L	
817019	QT967SS		QTE967R
1009009	QT967SS	QTE967L	
1009010	QT967SS		QTE967R
6070910	QT108SB	QTE108L	
6073380010	QT108SB	QTE108L	
6073381010	QT967SS	QTE967L	
6073381310	QT108SB		QTE108R
6073381410	QT108SB		QTE108R
6073382410	QT967SS		QTE967R
681-460-15-05	QT108SB		QTE108R
A3144C237	QT108SB	QTE108L	
A3144C549	QT108SB	QTE108L	
A3144D238	QT108SB		QTE108R
A3144D524	QT967SS		QTE967R

COMPETITOR #	ASSEMBLY	LEFT*	RIGHT*
FREIGHTLINER			
A3144D550	QT108SB		QTE108R
A3144E525	QT967SS	QTE967L	
A3144F448	QT108SB		QTE108R
A3144G449	QT108SB	QTE108L	
A3144J296	QT108SB	QTE108L	
A3144J296	QT108SB	QTE108L	
A3144K297	QT108SB	QTE108L	
A3144Q225	QT967SS	QTE967L	
A3144R226	QT967SS		QTE967R
A6073381010	QT967SS	QTE967L	
A6073382410	QT967SS		QTE967R
L24SV5001A13	QT967SS		QTE967R
L24SV5001A14	QT967SS		QTE967R
L24SV5042A12	QT967SS		QTE967R
L24SV5042B12	QT967SS		QTE967R
L24SV5043A12	QT967SS	QTE967L	
L24SV5043A14	QT967SS	QTE967L	
L24SV5700A12	QT967SS		QTE967R
L28SV5000A14	QT108SB	QTE108L	
L28SV5000A18	QT108SB	QTE108L	
L28SV5000A18	QT108SB	QTE108L	
L28SV5000A30	QT108SB		QTE108R
L28SV5000H29	QT108SB	QTE108L	
L28SV5000H35	QT108SB	QTE108L	
L28SV5001A18	QT108SB		QTE108R
L28SV5003A14	QT108SB	QTE108L	
L28SV5003B18	QT108SB		QTE108R
L28SV5004D1	QT108SB		QTE108R
L28SV5200A12	QT108SB		QTE108R
L28SV5200D12	QT108SB		QTE108R
L28SV5201A12	QT108SB	QTE108L	
L28SV5201D12	QT108SB	QTE108L	
L28SV5207B16	QT108SB		QTE108R
MBA6073381010	QT967SS	QTE967L	
MBA6073382410	QT967SS		QTE967R
HENDRICKSON			
29141	QT967SS	QTE967L	
29142	QT108SB		QTE967R
60961025	QT967SS	QTE967L	
60961026	QT967SS		QTE967R
60961027	QT967SS	QTE967L	
60961028	QT967SS		QTE967R
60961029	QT967SS	QTE967L	
60961030	QT967SS		QTE967R
60961083	QT967SS	QTE967L	
60961084	QT967SS		QTE967R
60961085	QT967SS	QTE967L	
60961086	QT967SS		QTE967R
64000001	QT967SS	QTE967L	
64000002	QT967SS		QTE967R
64002001	QT967SS	QTE967L	
64002002	QT967SS		QTE967R
65033001	QT967SS	QTE967L	
65033002	QT967SS		QTE967R
65034001	QT967SS	QTE967L	
65034002	QT967SS		QTE967R
66645001	QT967SS	QTE967L	
66645002	QT967SS		QTE967R

COMPETITOR #	ASSEMBLY	LEFT*	RIGHT*
HENDRICKSON			
64004-001	QT967SS	QTE967L	
64004-002	QT967SS		QTE967R
INDUSTRY STANDARD			
ES-187L	QT967SS	QTE967L	
ES-187R	QT967SS		QTE967R
ES-2090L	QT108SB	QTE108L	
ES-2090LS	QT108SB	QTE108L	
ES-2091R	QT108SB		QTE108R
ES-2091RS	QT108SB		QTE108R
ES-2118	QT967SS		QTE967R
ES-2202R	QT108SB		QTE108R
ES-2203R	QT967SS		QTE967R
ES-2207R	QT108SB		QTE108R
ES-2208R	QT108SB		QTE108R
ES-2614L	QT967SS	QTE967L	
ES-2614R	QT967SS		QTE967R
ES-3030R	QT108SB		QTE108R
ES-3031L	QT108SB	QTE108L	
ES-3033L	QT108SB	QTE108L	
ES-3034R	QT108SB		QTE108R
ES-3056	QT108SB		QTE108R
ES-3057	QT108SB	QTE108L	
ES-3058	QT108SB		QTE108R
ES-3176L	QT967SS	QTE967L	
ES-3176R	QT967SS		QTE967R
ES-3177L	QT967SS	QTE967L	
ES-3178R	QT967SS		QTE967R
ES-3216	QT967SS		QTE967R
ES-3219L	QT967SS	QTE967L	
ES-3220R	QT967SS		QTE967R
ES-3297R	QT967SS		QTE967R
ES-3298L	QT967SS	QTE967L	
ES-3312R	QT967SS		QTE967R
ES-3442R	QT967SS		QTE967R
ES-3443L	QT967SS	QTE967L	
ES-346L	QT108SB		QTE108R
ES-346R	QT108SB	QTE108L	
ES-3476	QT967SS		QTE967R
ES-3477	QT967SS	QTE967L	
ES-411L	QT967SS	QTE967L	
ES411R	QT967SS		QTE967R
ES-423L	QT967SS	QTE967L	
ES-423R	QT967SS		QTE967R
ES-431L	QT108SB		QTE108R
ES-431LS	QT108SB		QTE108R
ES-431R	QT108SB	QTE108L	
ES-431RS	QT108SB	QTE108L	
ES-4601L	QT108SB	QTE108L	
ES-4601R	QT108SB		QTE108R
ES-9001L	QT967SS	QTE967L	
ES-9001R	QT967SS		QTE967R
ES-9328L	QT108SB	QTE108L	
ISUZU			
ES-9329R	QT108SB		QTE108R
ES-9678L	QT967SS	QTE967L	
ES-9679R	QT967SS		QTE967R
ES-C260411R	QT967SS		QTE967R
8889230850	QT108SB	QTE108L	

* Only compatible with STEMCO Cross Tube QTT5773

Tie Rod End Reference

QTE967 R - L (small taper - Green cap)
Thread Diameter 1 1/2" Minor OD on taper 0.967"
Including ES2203R, ES3442R, ES3443L

QTE108 R - L (big taper - Red cap)
Thread Diameter 1 1/2" Minor OD on taper 1.080" Including ES5945R, ES5945L

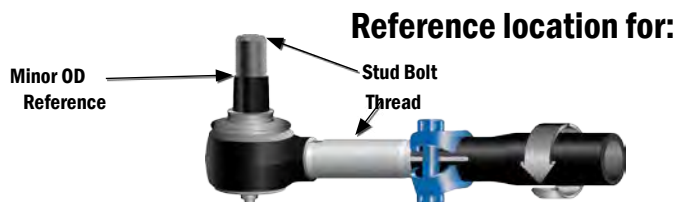

Tie Rod End Interchange to QWIKTIE Assembly

COMPETITOR #	ASSEMBLY	LEFT*	RIGHT*
ISUZU			
8889360850	QT108SB	QTE108L	
8889360860	QT108SB		QTE108R
KENWORTH			
817018	QT967SS	QTE967L	
817019	QT967SS		QTE967R
1006148	QT967SS	QTE967L	
1006149	QT967SS		QTE967R
1009009	QT967SS	QTE967L	
1009010	QT967SS		QTE967R
A1-3144F370	QT108SB		QTE108R
A3144C237	QT108SB	QTE108L	
A3144C549	QT108SB	QTE108L	
A3144D238	QT108SB		QTE108R
A3144D524	QT967SS		QTE967R
A3144D550	QT108SB		QTE108R
A3144E525	QT967SS	QTE967L	
A3144F448	QT108SB		QTE108R
A3144G449	QT108SB	QTE108L	
A3144J296	QT108SB		QTE108R
A3144K297	QT108SB	QTE108L	
A3144Q225	QT967SS	QTE967L	
A3144R226	QT967SS		QTE967R
A3144U437	QT108SB	QTE108L	
A3144V438	QT108SB		QTE108R
L24SV5042A12	QT967SS		QTE967R
L24SV5043A12	QT967SS	QTE967L	
L28SV5202A1	QT108SB		QTE108R
L28SV5203A1	QT108SB	QTE108L	
MACK			
27191009009	QT967SS	QTE967L	
27191009010	QT967SS		QTE967R
10QH241P1	QT967SS		QTE967R
10QH242P1	QT967SS		QTE967R
10QH243	QT967SS		QTE967R
10QH243P1	QT967SS		QTE967R
10QH243P2	QT967SS	QTE967L	
10QH248P1	QT967SS		QTE967R
10QH248P2	QT967SS	QTE967L	
10QH248P3	QT108SB		QTE108R
10QH248P4	QT108SB	QTE108L	
10QH248P5	QT108SB		QTE108R
10QH248P6	QT108SB	QTE108L	
10QH248P7	QT967SS		QTE967R
10QH309P1	QT108SB	QTE108L	
10QH309P1	QT108SB	QTE108L	
10QH311P1	QT108SB		QTE108R
10QH312P1	QT108SB	QTE108L	
10QH39P1	QT108SB	QTE108L	
18QK214P2	QT108SB		QTE108R
18QK23A	QT108SB		QTE108R
18QK28A	QT108SB	QTE108L	
18QK29301	QT108SB		QTE108R
310228SF	QT108SB		QTE108R
310229SF	QT108SB	QTE108L	
A3144E524	QT967SS		QTE967R
A3144E525	QT967SS	QTE967L	
A3144U438	QT108SB	QTE108L	

COMPETITOR #	ASSEMBLY	LEFT*	RIGHT*
MARMON			
A3144C237	QT108SB		QTE108R
A3144D238	QT108SB	QTE108L	
A3144D524	QT967SS		QTE967R
A3144E525	QT967SS	QTE967L	
A3144J296	QT108SB		QTE108R
A3144K297	QT108SB	QTE108L	
A3144Q225	QT967SS	QTE967L	
A3144R226	QT967SS		QTE967R
L24SV5042A12	QT967SS		QTE967R
L24SV5043A12	QT967SS	QTE967L	
MCQUAY			
ES187L	QT967SS	QTE967L	
ES187R	QT967SS		QTE967R
ES2040R	QT108SB		QTE108R
ES2041L	QT108SB	QTE108L	
ES2090L	QT108SB	QTE108L	
ES2091R	QT108SB		QTE108R
ES2113R	QT108SB		QTE108R
ES2114R	QT108SB		QTE108R
ES2115R	QT108SB		QTE108R
ES2116L	QT108SB	QTE108L	
ES2118L	QT967SS		QTE967R
ES2202R	QT108SB		QTE108R
ES2203R	QT967SS		QTE967R
ES2204R	QT108SB		QTE108R
ES2207R	QT108SB		QTE108R
ES2209R	QT108SB		QTE108R
ES2210L	QT108SB	QTE108L	
ES2614R	QT967SS		QTE967R
ES3030R	QT108SB		QTE108R
ES3031L	QT108SB	QTE108L	
ES3176R	QT967SS		QTE967R
ES3177L	QT967SS	QTE967L	
ES3178R	QT967SS		QTE967R
ES3216R	QT967SS		QTE967R
ES3217L	QT967SS	QTE967L	
ES3218R	QT967SS		QTE967R
ES3219L	QT967SS	QTE967L	
ES3220R	QT967SS		QTE967R
ES3297R	QT967SS		QTE967R
ES3298L	QT967SS	QTE967L	
ES3312R	QT967SS		QTE967R
ES3442R	QT967SS		QTE967R
ES3443L	QT967SS	QTE967L	
ES346L	QT108SB		QTE108R
ES346R	QT108SB	QTE108L	
ES3476	QT967SS		QTE967R
ES3477	QT967SS	QTE967L	
ES376L	QT108SB	QTE108L	
ES376R	QT108SB		QTE108R
ES411L	QT967SS	QTE967L	
ES411R	QT967SS		QTE967R
ES423L	QT967SS	QTE967L	
ES423R	QT967SS		QTE967R
ES431L	QT108SB		QTE108R
ES431LA	QT108SB		QTE108R
ES431R	QT108SB	QTE108L	
ES431RA	QT108SB	QTE108L	

COMPETITOR #	ASSEMBLY	LEFT*	RIGHT*
MERITOR			
230236	QT108SB	QTE108L	
230237	QT108SB		QTE108R
1668480C91	QT108SB		QTE108R
A23144J192	QT967SS		QTE967R
A23144K193	QT967SS	QTE967L	
A3144A547	QT108SB	QTE108L	
A3144C237	QT108SB	QTE108L	
A3144C549	QT108SB	QTE108L	
A3144D238	QT108SB		QTE108R
A3144D524	QT967SS		QTE967R
A3144D550	QT108SB		QTE108R
A3144E525	QT967SS	QTE967L	
A3144F448	QT108SB		QTE108R
A3144F526	QT967SS		QTE967R
A3144F552	QT967SS		QTE967R
A3144G449	QT108SB	QTE108L	
A3144G553	QT967SS	QTE967L	
A3144J296	QT108SB	QTE108L	
A3144K296	QT108SB		QTE108R
A3144K297	QT108SB	QTE108L	
A3144N534	QT967SS	QTE967L	
A3144P458	QT967SS		QTE967R
A3144Q225	QT967SS	QTE967L	
A3144Q459	QT967SS		QTE967R
A3144R226	QT967SS		QTE967R
A3144U437	QT108SB	QTE108L	
A3144V1088	QT967SS		QTE967R
A3144V1089	QT967SS	QTE967L	
A3144V438	QT108SB		QTE108R
A3144W1141	QT967SS	QTE967L	
A3144X1142	QT967SS		QTE967R
A3144Z546	QT108SB		QTE108R
A43144D524	QT967SS		QTE967R
A43144N456	QT967SS	QTE967L	
R230022	QT108SB	QTE108L	
R230023	QT108SB		QTE108R
R230028	QT967SS	QTE967L	
R230029	QT967SS		QTE967R
R230041	QT108SB		QTE108R
R230042	QT108SB	QTE108L	
R230043	QT967SS		QTE967R
R230050	QT108SB		QTE108R
R230051	QT967SS		QTE967R
R230052	QT108SB		QTE108R
R230055	QT108SB	QTE108L	
R230060	QT967SS	QTE967L	
R230061	QT967SS		QTE967R
R230066	QT108SB	QTE108L	
R230067	QT108SB		QTE108R
R230068	QT967SS	QTE967L	
R230069	QT967SS		QTE967R
R230070	QT108SB		QTE108R
R230071	QT108SB	QTE108L	
R230072	QT108SB	QTE108L	
R230073	QT108SB		QTE108R
R230076	QT108SB		QTE108R
R230077	QT108SB		QTE108R
R230088	QT967SS		QTE967R

* Only compatible with STEMCO Cross Tube QTT5773

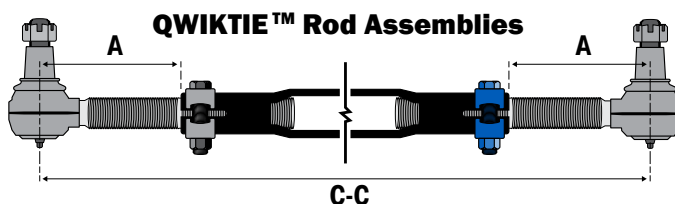

Fit a wide range of configurations,
QT967SS typical for 12,000 # axles (Green cap)
QT108SB typical for 16 & 20,000 # axles (Red cap)
Qwik Tie Assemblies adjust C-C 57⁵/₈" to 73⁵/₈"

When extending Rod Ends to the proper C-C
Maintain equal distance on both Left and Right A=A
Do not overextend beyond the groove on the thread

COMPETITOR #	ASSEMBLY	LEFT*	RIGHT*
MERITOR			
R230089	QT967SS	QTE967L	
R230090	QT967SS		QTE967R
R230091	QT108SB		QTE108R
R230092	QT108SB	QTE108L	
R230102	QT108SB		QTE108R
R230103	QT108SB	QTE108L	
R230104	QT108SB		QTE108R
R230105	QT108SB	QTE108L	
R230114	QT108SB		QTE108R
R230115	QT108SB	QTE108L	
R230127	QT967SS	QTE967L	
R230129	QT108SB		QTE108R
R230130	QT108SB	QTE108L	
R230131	QT967SS	QTE967L	
R230132	QT967SS		QTE967R
R230133	QT108SB	QTE108L	
R230134	QT108SB		QTE108R
R230135	QT967SS	QTE967L	
R230136	QT967SS		QTE967R
R230139	QT967SS		QTE967R
R230140	QT967SS	QTE967L	
R230145	QT967SS		QTE967R
R230146	QT967SS	QTE967L	
R230213	QT108SB	QTE108L	
R230214	QT108SB		QTE108R
R230230	QT967SS		QTE967R
R230240	QT967SS		QTE967R
R230241	QT967SS	QTE967L	
R230246	QT967SS	QTE967L	
R230247	QT967SS		QTE967R
R230408	QT967SS		QTE967R
R230409	QT967SS	QTE967L	
R230410	QT967SS		QTE967R
R230413	QT967SS	QTE967L	
R230414	QT967SS		QTE967R
R230415	QT967SS	QTE967L	
R230416	QT967SS		QTE967R
R230420	QT967SS		QTE967R
R230421	QT967SS	QTE967L	
MIDLAND			
M2ES187L	QT967SS	QTE967L	
M2ES187R	QT108SB		QTE967R
M2ES2090L	QT108SB	QTE108L	
M2ES2091R	QT108SB		QTE108R
M2ES2118L	QT108SB		QTE967R
M2ES2202R	QT108SB		QTE108R
M2ES2208R	QT108SB		QTE108R
M2ES2614R	QT108SB		QTE967R
M2ES3031L	QT108SB	QTE108L	
M2ES303OR	QT108SB		QTE108R
M2ES3056	QT108SB		QTE108R
M2ES3057	QT108SB	QTE108L	
M2ES3297R	QT108SB		QTE967R
M2ES3298L	QT967SS	QTE967L	
M2ES346L	QT108SB		QTE108R
M2ES346R	QT108SB	QTE108L	
M2ES411L	QT967SS	QTE967L	
M2ES411R	QT108SB		QTE967R

COMPETITOR #	ASSEMBLY	LEFT*	RIGHT*
MIDLAND			
M2ES423L	QT967SS	QTE967L	
M2ES423R	QT108SB		QTE967R
M2ES431L	QT108SB	QTE108L	
M2ES431R	QT108SB		QTE108R
MOOG			
ES187L	QT967SS	QTE967L	
ES187R	QT967SS		QTE967R
ES2040R	QT108SB		QTE108R
ES2041L	QT108SB	QTE108L	
ES2090L	QT108SB	QTE108L	
ES2091R	QT108SB		QTE108R
ES2113R	QT108SB		QTE108R
ES2114R	QT108SB		QTE108R
ES2115R	QT108SB		QTE108R
ES2116L	QT108SB	QTE108L	
ES2118L	QT967SS		QTE967R
ES2202R	QT108SB		QTE108R
ES2203R	QT967SS		QTE967R
ES2204R	QT108SB		QTE108R
ES2207R	QT108SB		QTE108R
ES2208R	QT108SB		QTE108R
ES2209R	QT108SB		QTE108R
ES2210L	QT108SB	QTE108L	
ES2215R	QT108SB	QTE108L	
ES2614R	QT967SS		QTE967R
ES3030R	QT108SB		QTE108R
ES3031L	QT108SB	QTE108L	
ES3041R	QT967SS		QTE967R
ES3056	QT108SB		QTE108R
ES3057	QT108SB	QTE108L	
ES3176R	QT967SS		QTE967R
ES3177L	QT967SS	QTE967L	
ES3178R	QT967SS		QTE967R
ES3216R	QT967SS		QTE967R
ES3217L	QT967SS	QTE967L	
ES3218R	QT967SS		QTE967R
ES3219L	QT967SS	QTE967L	
ES3220R	QT967SS		QTE967R
ES3297R	QT967SS		QTE967R
ES3298L	QT967SS	QTE967L	
ES3442R	QT967SS		QTE967R
ES3443L	QT967SS	QTE967L	
ES346L	QT108SB		QTE108R
ES346R	QT108SB	QTE108L	
ES3476	QT967SS		QTE967R
ES3477	QT967SS	QTE967L	
ES376L	QT108SB	QTE108L	
ES376R	QT108SB		QTE108R
ES411L	QT967SS	QTE967L	
ES411R	QT967SS		QTE967R
ES423R	QT967SS		QTE967R
ES431L	QT108SB		QTE108R
ES431LA	QT108SB		QTE108R
ES431LS	QT108SB		QTE108R
ES431R	QT108SB	QTE108L	
ES431RA	QT108SB	QTE108L	
ES461RS	QT108SB	QTE108L	
ES9009	QT967SS	QTE967L	

COMPETITOR #	ASSEMBLY	LEFT*	RIGHT*
NAVISTAR			
817018	QT967SS	QTE967L	
817019	QT967SS		QTE967R
110362R92	QT967SS	QTE967L	
110363R92	QT967SS		QTE967R
140TR109	QT967SS	QTE967L	
140TR111	QT967SS	QTE967L	
140TR112	QT967SS		QTE967R
1649637C91	QT967SS	QTE967L	
1649638C91	QT108SB		QTE967R
1668407C91	QT967SS	QTE967L	
1668408C91	QT967SS		QTE967R
1668409C91	QT967SS	QTE967L	
1668410C91	QT967SS		QTE967R
1668479C91	QT108SB	QTE108L	
1668480C91	QT108SB		QTE108R
1677271C91	QT108SB		QTE108R
220TR118	QT108SB	QTE108L	
220TR119	QT108SB		QTE108R
2603967C91	QT108SB		QTE967R
2603968C91	QT967SS	QTE967L	
377635C91	QT967SS	QTE967L	
377636C91	QT967SS		QTE967R
438368C91	QT967SS	QTE967L	
438369C91	QT967SS		QTE967R
442354C91	QT108SB		QTE108R
447094C91	QT967SS	QTE967L	
447095C91	QT108SB		QTE967R
461665C91	QT108SB		QTE108R
461672C91	QT108SB		QTE967R
468354C91	QT108SB	QTE108L	
477094C91	QT967SS	QTE967L	
477095C91	QT967SS		QTE967R
486354C91	QT108SB	QTE108L	
486355C91	QT108SB		QTE108R
486355C91F	QT108SB		QTE108R
486355R91	QT108SB		QTE108R
486807C91	QT108SB		QTE967R
491665C91	QT108SB		QTE108R
491666C91	QT108SB		QTE108R
506662C91	QT108SB		QTE967R
506684C91	QT108SB		QTE108R
507835C91	QT967SS	QTE967L	
507836C91	QT967SS		QTE967R
507837C91	QT967SS	QTE967L	
507838C91	QT967SS		QTE967R
581063C91	QT108SB		QTE108R
590583C91	QT108SB		QTE108R
590584C91	QT108SB	QTE108L	
596653C91	QT967SS		QTE967R
64002-001	QT967SS	QTE967L	
64002-002	QT967SS		QTE967R
969055R91	QT108SB	QTE108L	
969056R91	QT108SB		QTE108R
FRT423L	QT967SS	QTE967L	
FTR187L	QT967SS	QTE967L	
FTR187R	QT108SB		QTE967R
FTR2040R	QT108SB		QTE108R
FTR2090L	QT108SB	QTE108L	

* Only compatible with STEMCO Cross Tube QTT5773

Tie Rod End Reference

QTE967 R - L (small taper - Green cap)
Thread Diameter 1 1/2" Minor OD on taper 0.967"
Including ES2203R, ES3442R, ES3443L

QTE108 R - L (big taper - Red cap)
Thread Diameter 1 1/4" Minor OD on taper 1.080" Including ES5945R, ES5945L

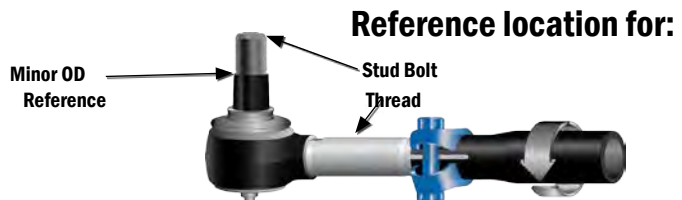

Tie Rod End Interchange to QWIKTIE Assembly

NAVISTAR, O&S MFG., PAI,
PERFECT CIRCLE, S&S, SPICER,
THOMAS BUILT BUSES, TRP

COMPETITOR #	ASSEMBLY	LEFT*	RIGHT*
NAVISTAR			
FTR2091R	QT108SB		QTE108R
FTR2113R	QT108SB		QTE108R
FTR2114R	QT108SB		QTE108R
FTR2115R	QT108SB		QTE108R
FTR2116L	QT108SB	QTE108L	
FTR2202R	QT108SB		QTE108R
FTR2203R	QT108SB		QTE967R
FTR2204R	QT108SB		QTE108R
FTR2207R	QT108SB		QTE108R
FTR2209R	QT108SB		QTE108R
FTR2210L	QT108SB	QTE108L	
FTR2614R	QT967SS		QTE967R
FTR3030R	QT108SB		QTE108R
FTR3031L	QT108SB	QTE108L	
FTR3033L	QT108SB		QTE108R
FTR3057	QT108SB	QTE108L	
FTR346L	QT108SB		QTE108R
FTR346R	QT108SB	QTE108L	
FTR3476	QT967SS		QTE967R
FTR3477	QT108SB	QTE967L	
FTR376L	QT108SB	QTE108L	
FTR376R	QT108SB		QTE108R
FTR411L	QT967SS	QTE967L	
FTR411R	QT108SB		QTE967R
FTR423L	QT967SS	QTE967L	
FTR423R	QT108SB		QTE967R
FTR431L	QT108SB		QTE108R
FTR431R	QT108SB	QTE108L	
FTR487L	QT967SS	QTE967L	
FTR8407	QT967SS	QTE967L	
FTR8408	QT967SS		QTE967R
FTR8409	QT967SS	QTE967L	
FTR8410	QT967SS		QTE967R
O&S MFG.			
ES2040R	QT108SB		QTE108R
ES2041L	QT108SB	QTE108L	
ES2090L	QT108SB	QTE108L	
ES2091R	QT108SB		QTE108R
ES2118L	QT967SS		QTE967R
ES2207R	QT108SB		QTE108R
ES2208R	QT108SB		QTE108R
ES346L	QT108SB		QTE108R
ES346R	QT108SB	QTE108L	
ES376L	QT108SB	QTE108L	
ES376R	QT108SB		QTE108R
ES411L	QT967SS	QTE967L	
ES411R	QT967SS		QTE967R
ES423L	QT967SS	QTE967L	
ES423R	QT967SS		QTE967R
ES431R	QT108SB	QTE108L	
PAI			
2692235	QT967SS		QTE967R
ARE9950	QT108SB	QTE108L	
ARE9955	QT967SS		QTE967R
ARE9984	QT967SS	QTE967L	
ARE9985	QT967SS		QTE967R
ARE9986	QT108SB		QTE108R
ARE9988	QT967SS		QTE967R

COMPETITOR #	ASSEMBLY	LEFT*	RIGHT*
PAI			
ARE9989	QT967SS		QTE967L
ARE9990	QT108SB		QTE108R
ARE9991	QT108SB		QTE108R
PERFECT CIRCLE			
2692041	QT967SS	QTE967L	
2692042	QT967SS		QTE967R
2692158	QT108SB		QTE108R
2692159	QT108SB	QTE108L	
2692234	QT967SS	QTE967L	
2692235	QT967SS		QTE967R
2692243	QT967SS	QTE967L	
2692244	QT967SS		QTE967R
2692311	QT108SB	QTE108L	
2692312	QT108SB	QTE108L	
2692446	QT108SB	QTE108L	
2692447	QT108SB		QTE108R
2692485	QT108SB		QTE108R
2692644	QT108SB		QTE108R
2692645	QT108SB	QTE108L	
2692653	QT967SS		QTE967R
2692663	QT967SS		QTE967R
2692698	QT108SB		QTE108R
2692699	QT108SB		QTE108R
2692700	QT108SB		QTE108R
2692705	QT967SS		QTE967R
2692709	QT108SB		QTE108R
2692710	QT108SB		QTE108R
2693039	QT967SS		QTE967R
2693040	QT967SS	QTE967L	
2695098	QT108SB		QTE108R
2962311	QT108SB		QTE108R
3693034	QT967SS	QTE967L	
S7460	QT967SS		QTE967R
S&S			
S4760	QT108SB		QTE108R
S5048	QT108SB	QTE108L	
S5049	QT108SB		QTE108R
S5056	QT967SS	QTE967L	
S5057	QT967SS		QTE967R
S5988	QT108SB		QTE108R
S6659	QT108SB		QTE108R
S7357	QT967SS		QTE967R
SPICER			
S7358	QT967SS	QTE967L	
S7459	QT967SS	QTE967L	
S7460	QT967SS		QTE967R
S8999	QT967SS	QTE967L	
S9000	QT967SS		QTE967R
817018	QT967SS		QTE967R
817019	QT967SS		QTE967R
917018	QT967SS	QTE967L	
1009009	QT967SS	QTE967L	
1009010	QT967SS		QTE967R
2692244	QT967SS		QTE967R
140TR109	QT967SS	QTE967L	
140TR110	QT967SS		QTE967R
140TR111	QT967SS	QTE967L	
140TR112	QT967SS		QTE967R

COMPETITOR #	ASSEMBLY	LEFT*	RIGHT*
SPICER			
220TR115	QT108SB		QTE108R
220TR116	QT108SB	QTE108L	
220TR118	QT108SB	QTE108L	
220TR119	QT108SB		QTE108R
S9692311	QT108SB		QTE108R
SP692042	QT967SS		QTE967R
SP692043	QT967SS	QTE967L	
SP692158	QT108SB		QTE108R
SP692159	QT108SB	QTE108L	
SP692234	QT967SS	QTE967L	
SP692235	QT967SS		QTE967R
SP692243	QT967SS	QTE967L	
SP692244	QT967SS		QTE967R
SP692311	QT108SB		QTE108R
SP692485	QT108SB		QTE108R
SP692486	QT108SB	QTE108L	
SP692644	QT108SB		QTE108R
SP692645	QT108SB	QTE108L	
SP692653	QT967SS		QTE967R
SP692698	QT108SB		QTE108R
SP692705	QT967SS		QTE967R
SP692709	QT108SB		QTE108R
SP692709	QT108SB		QTE108R
SP692710	QT108SB		QTE108R
TRE187BL	QT967SS	QTE967L	
TRE187BR	QT967SS		QTE967R
TRE187SL	QT967SS	QTE967L	
TRE187SR	QT967SS		QTE967R
TRE2090L	QT108SB	QTE108L	
TRE2091R	QT108SB		QTE108R
TRE2091R	QT108SB		QTE108R
TRE2118R	QT967SS		QTE967R
TRE2203R	QT967SS		QTE967R
TRE2208R	QT108SB		QTE108R
TRE2614R	QT967SS		QTE967R
TRE3176R	QT967SS		QTE967R
TRE3177L	QT967SS	QTE967L	
TRE3178R	QT967SS		QTE967R
TRE3216R	QT967SS		QTE967R
TRE3312R	QT967SS		QTE967R
TRE3442R	QT967SS		QTE967R
TRE3443L	QT967SS	QTE967L	
TRE346L	QT108SB		QTE108R
TRE346R	QT108SB	QTE108L	
TRE3476R	QT967SS		QTE967R
TRE3477L	QT967SS	QTE967L	
TRE411L	QT967SS	QTE967L	
TRE411R	QT967SS		QTE967R
TRE431BLA	QT108SB		QTE108R
TRE431BRA	QT108SB	QTE108L	
TRE431SLA	QT108SB		QTE108R
TRE431SRA	QT108SB	QTE108L	
TRE476R	QT967SS		QTE967R
THOMAS BUILT BUSES			
61110153	QT108SB		QTE967R
61110154	QT967SS	QTE967L	
TRP			
TE10001	QT967SS		QTE967R

* Only compatible with STEMCO Cross Tube QTT5773

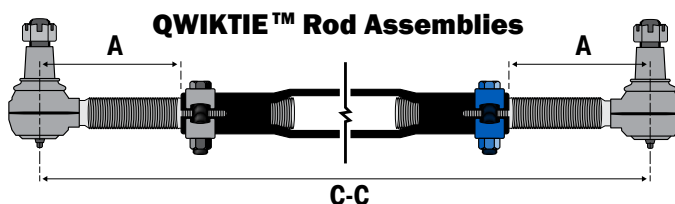

Fit a wide range of configurations,
QT967SS typical for 12,000 # axles (Green cap)
QT108SB typical for 16 & 20,000 # axles (Red cap)
Qwik Tie Assemblies adjust C-C 57⁵/₈" to 73⁵/₈"

When extending Rod Ends to the proper C-C
Maintain equal distance on both Left and Right A=A
Do not overextend beyond the groove on the thread

COMPETITOR #	ASSEMBLY	LEFT*	RIGHT*
TRP			
TE10002	QT967SS	QTE967L	
TE11003	QT967SS		QTE967R
TE11004	QT967SS	QTE967L	
TE11007	QT967SS		QTE967R
TE11008	QT967SS	QTE967L	
TE11981	QT967SS		QTE967R
TE11982	QT967SS	QTE967L	
TE11987	QT967SS		QTE967R
TE11988	QT967SS	QTE967L	
TE12007	QT108SB	QTE108L	
TE12008	QT108SB		QTE108R
TE12011	QT108SB		QTE108R
TE12039	QT108SB		QTE108R
TRW			
ES3476	QT967SS		QTE967R
ES3477	QT967SS	QTE967L	
ES2040R	QT108SB		QTE108R
ES2041L	QT108SB	QTE108R	
ES2090L	QT108SB		QTE108R
ES2091R	QT108SB		QTE108R
ES2113R	QT108SB		QTE108R
ES2114R	QT108SB		QTE108R
ES2115R	QT108SB		QTE108R
ES2116L	QT108SB	QTE108L	
ES2118L	QT967SS		QTE967R
ES2202R	QT108SB		QTE108R
ES2204R	QT108SB		QTE108R
ES2207R	QT108SB		QTE108R
ES2208R	QT108SB		QTE108R
ES2209R	QT108SB		QTE108R
ES2210L	QT108SB	QTE108L	
ES2614R	QT967SS		QTE967R
ES3030R	QT108SB		QTE108R
ES3031L	QT108SB	QTE108L	
ES3033L	QT108SB	QTE108L	
ES3034R	QT108SB		QTE108R
ES3057	QT108SB	QTE108L	
ES3176R	QT967SS		QTE967R
ES3177L	QT967SS	QTE967L	
ES3218R	QT967SS		QTE967R
ES3219L	QT967SS	QTE967L	
ES3220R	QT967SS		QTE967R
ES3297R	QT967SS		QTE967R
ES3298L	QT967SS	QTE967L	
ES3442R	QT967SS		QTE967R
ES3443L	QT967SS	QTE967L	
ES346L	QT108SB		QTE108R
ES346R	QT108SB	QTE108L	
ES3476	QT967SS		QTE967R
ES3477	QT967SS	QTE967L	
ES376L	QT108SB	QTE108L	
ES376R	QT108SB		QTE108R
ES411L	QT967SS	QTE967L	
ES411R	QT967SS		QTE967R
ES423L	QT967SS	QTE967L	
ES423R	QT967SS		QTE967R
ES431L	QT108SB	QTE108L	
ES431R	QT108SB		QTE108R

COMPETITOR #	ASSEMBLY	LEFT*	RIGHT*
TRW			
L20LV8041A13	QT967SS	QTE967L	
L20LV8041A14	QT967SS	QTE967L	
L20LV8041A15	QT967SS	QTE967L	
L20LV8042A13	QT967SS		QTE967R
L20LV8042A14	QT967SS		QTE967R
L20LV8042A15	QT967SS		QTE967R
L20LV8087A13	QT967SS	QTE967L	
L20LV8088A13	QT967SS		QTE967R
L20LV8128B12	QT967SS	QTE967L	
L20LV8129B12	QT967SS		QTE967R
L20LV8165A14	QT967SS	QTE967L	
L20LV8166A14	QT967SS		QTE967R
L20SV5180B14	QT967SS		QTE967R
L20SV5181B14	QT967SS	QTE967L	
L20SV8100B13	QT967SS	QTE967L	
L20SV8100C14	QT967SS	QTE967L	
L20SV8100D12	QT967SS	QTE967L	
L20SV8101B12	QT967SS		QTE967R
L20SV8101B15	QT967SS		QTE967R
L20SV8101C15	QT967SS		QTE967R
L20SV8101D12	QT967SS		QTE967R
L20SV8102D16	QT967SS	QTE967L	
L20SV8102F13	QT967SS	QTE967L	
L20SV8102K11	QT967SS		QTE967R
L20SV8103K11	QT967SS	QTE967L	
L20SV8104B14	QT967SS	QTE967L	
L20SV8104B16	QT967SS	QTE967L	
L20SV8105B14	QT967SS		QTE967R
L20SV8105B16	QT967SS		QTE967R
L20SV8107C12	QT967SS	QTE967L	
L20SV8108A13	QT967SS		QTE967R
L20SV8109A12	QT967SS		QTE967R
L20SV8110A17	QT967SS		QTE967R
L20SV8111A15	QT967SS	QTE967L	
L20SV8115A12	QT967SS	QTE967L	
L20SV8116A12	QT967SS		QTE967R
L20SV8132B12	QT967SS		QTE967R
L20SV8150A13	QT967SS		QTE967R
L20SV8150B16	QT967SS		QTE967R
L20SV8151A13	QT967SS	QTE967L	
L20SV8151B16	QT967SS	QTE967L	
L20SV8256A14	QT967SS		QTE967R
L24LV5324A12	QT967SS		QTE967R
L24LV5325A12	QT967SS	QTE967L	
L24LV8441A13	QT967SS	QTE967L	
L24LV8442A13	QT967SS		QTE967R
L24SV5042B12	QT967SS	QTE967L	
L24SV5042D14	QT967SS		QTE967R
L24SV5043A12	QT967SS		QTE967R
L24SV5043B12	QT967SS	QTE967L	
L24SV5044A12	QT967SS		QTE967R
L24SV5202A11	QT108SB		QTE108R
L24SV7002C12	QT967SS		QTE967R
L24SV8000C20	QT967SS	QTE967L	
L24SV8000E13	QT967SS	QTE967L	
L24SV8001E13	QT967SS		QTE967R
L24SV8002C13	QT967SS	QTE967L	
L24SV8100B13	QT108SB	QTE108L	

COMPETITOR #	ASSEMBLY	LEFT*	RIGHT*
TRW			
L24SV8100D12	QT967SS	QTE967L	
L24SV8100D18	QT967SS	QTE967L	
L24SV8101A21	QT108SB		QTE108R
L24SV8101A23	QT108SB		QTE108R
L24SV8101C22	QT108SB		QTE108R
L24SV8101E16	QT967SS		QTE967R
L24SV8101E19	QT967SS		QTE967R
L24SV8102C13	QT108SB	QTE108L	
L24SV8102C15	QT108SB	QTE108L	
L24SV8103C1	QT108SB		QTE108R
L24SV8103C12	QT108SB		QTE108R
L24SV8107A13	QT108SB	QTE108L	
L24SV8110D12	QT108SB		QTE108R
L24SV8202D18	QT108SB	QTE108L	
L24SV8203B18	QT108SB		QTE108R
L24SV8204A19	QT108SB		QTE108R
L24SV8204A19	QT108SB		QTE108R
L24SV8205C13	QT967SS	QTE967L	
L24SV8205C25	QT108SB	QTE108L	
L24SV8207A14	QT108SB	QTE108L	
L24SV8208B12	QT108SB	QTE108L	
L24SV8209B12	QT108SB	QTE108L	
L24SV8210A13	QT108SB	QTE108L	
L24SV8210A27	QT108SB		QTE108R
L24SV8211A16	QT108SB		QTE108R
L24SV8211B12	QT108SB	QTE108L	
L24SV8214B15	QT108SB		QTE108R
L24SV8312A13	QT967SS		QTE967R
L24SV8334A14	QT967SS		QTE967R
L24SV8339A12	QT967SS	QTE967L	
L24SV8348A12	QT967SS		QTE967R
L24SV8454A14	QT108SB		QTE108R
L24SV8454A16	QT108SB		QTE108R
L24SV8454A19	QT108SB		QTE108R
L24SV8455A14	QT108SB	QTE108L	
L24SV8455A16	QT108SB	QTE108L	
L24SV8455A19	QT108SB	QTE108L	
L28SV5201A11	QT108SB	QTE108L	
L28SV5201A12	QT108SB	QTE108L	
L28SV5202A11	QT108SB		QTE108R
L28SV5202A16	QT108SB		QTE108R
L28SV5207B16	QT108SB		QTE108R
L28SV5211B23	QT108SB		QTE108R
L28SV5211B37	QT108SB		QTE108R
L28SV5275A12	QT108SB	QTE108L	
L28SV5276A12	QT108SB		QTE108R
L28SV5326A14	QT108SB		QTE108R
R230415	QT967SS	QTE967L	
UNIMOTIVE			
TR187L	QT967SS	QTE967L	
TR187R	QT967SS		QTE967R
TR2040R	QT108SB		QTE108R
TR2041L	QT108SB	QTE108L	
TR2090L	QT108SB	QTE108L	
TR2091R	QT108SB		QTE108R
TR2113R	QT108SB		QTE108R
TR2114R	QT108SB		QTE108R
TR2115R	QT108SB		QTE108R

* Only compatible with STEMCO Cross Tube QTT5773

Tie Rod End Reference

QTE967 R - L (small taper - Green cap)
Thread Diameter 1 1/8" Minor OD on taper 0.967"
Including ES2203R, ES3442R, ES3443L

QTE108 R - L (big taper - Red cap)
Thread Diameter 1 1/4" Minor OD on taper 1.080" Including ES5945R, ES5945L

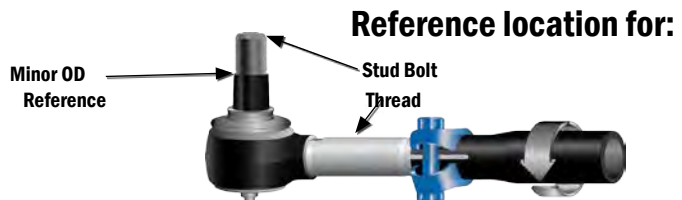

Tie Rod End Interchange to QWIKTIE Assembly

UNIMOTIVE, URRESKO,
VOLVO / WHITE, WESTERN STAR,
WESTPORT, WORKHORSE

COMPETITOR #	ASSEMBLY	LEFT*	RIGHT*
UNIMOTIVE			
TR2116L	QT108SB	QTE108L	
TR2118L	QT967SS		QTE967R
TR2202R	QT108SB		QTE108R
TR2204R	QT108SB		QTE108R
TR2207R	QT108SB		QTE108R
TR2209R	QT108SB		QTE108R
TR2210L	QT108SB	QTE108L	
TR346L	QT108SB		QTE108R
TR346R	QT108SB	QTE108L	
TR376L	QT108SB	QTE108L	
TR376R	QT108SB		QTE108R
TR411L	QT967SS	QTE967L	
TR411R	QT967SS		QTE967R
TR423L	QT967SS	QTE967L	
TR423R	QT967SS		QTE967R
TR431R	QT108SB	QTE108L	
URRESKO			
USK-0004R	QT108SB		QTE108R
USK-0005L	QT108SB	QTE108L	
USK-12007R	QT108SB		QTE108R
USK-12008L	QT108SB	QTE108L	
USK-128187R	QT967SS		QTE967R
USK-12889R	QT967SS		QTE967R
USK-12890L	QT967SS	QTE967L	
USK-13R	QT967SS		QTE967R
USK-147R	QT108SB		QTE108R
USK-14L	QT967SS	QTE967L	
USK-14R	QT967SS		QTE967R
USK-156R	QT108SB		QTE108R
USK-157R	QT108SB		QTE108R
USK-167R	QT108SB		QTE108R
USK-187L	QT967SS	QTE967L	
USK-187R	QT967SS		QTE967R
USK-2090L	QT108SB	QTE108L	
USK-2091R	QT108SB		QTE108R
USK-2203R	QT967SS		QTE967R
USK-2207R	QT108SB		QTE108R
USK-2208R	QT108SB		QTE108R
USK-2290L	QT108SB	QTE108L	
USK-2290L	QT108SB	QTE108L	
USK-2291R	QT108SB		QTE108R
USK-2291R	QT108SB		QTE108R
USK-248P1R	QT967SS		QTE967R
USK-248P2L	QT967SS	QTE967L	
USK-248P3R	QT108SB		QTE108R
USK-248P3R	QT108SB		QTE108R
USK-248P4L	QT108SB	QTE108L	
USK-248P4L	QT108SB	QTE108L	
USK-248P5R	QT108SB		QTE108R
USK-248P5R	QT108SB		QTE108R
USK-248P6L	QT108SB	QTE108L	
USK-256 R	QT108SB		QTE108R
USK-2838L	QT967SS	QTE967L	
USK-2838R	QT967SS		QTE967R
USK-2839L	QT967SS	QTE967L	
USK-2839R	QT967SS		QTE967R
USK-3219L	QT967SS	QTE967L	
USK-3220R	QT967SS		QTE967R

COMPETITOR #	ASSEMBLY	LEFT*	RIGHT*
URRESKO			
USK-3442R	QT967SS		QTE967R
USK-3443L	QT967SS	QTE967L	
USK-411L	QT967SS	QTE967L	
USK-411R	QT967SS		QTE967R
USK-423L	QT967SS	QTE967L	
USK-423R	QT967SS		QTE967R
USK-431L	QT108SB	QTE108L	
USK-431R	QT108SB		QTE108R
USK-502L	QT967SS	QTE967L	
USK-502R	QT967SS		QTE967R
USK-502R	QT967SS		QTE967R
USK-503L	QT108SB	QTE108L	
USK-503L	QT108SB	QTE108L	
USK-503R	QT108SB		QTE108R
USK-503R	QT108SB		QTE108R
USK-504R	QT967SS		QTE967R
USK-505R	QT967SS		QTE967R
USK-8084L	QT108SB	QTE108L	
USK-8084R	QT108SB		QTE108R
USK-817755L	QT108SB	QTE108L	
USK-817755R	QT108SB		QTE108R
USK-9716L	QT108SB	QTE108L	
USK-9716R	QT108SB		QTE108R
USK-AM1066L	QT967SS	QTE967L	
USK-AM1067R	QT967SS		QTE967R
USK-AM1137L	QT108SB	QTE108L	
USK-AM1138R	QT108SB		QTE108R
USK-AM1190L	QT967SS	QTE967L	
USK-AM1191R	QT967SS		QTE967R
USK-AM524R	QT967SS		QTE967R
USK-AM525L	QT967SS	QTE967L	
USK-AM546R	QT108SB		QTE108R
USK-AM547L	QT108SB	QTE108L	
USK-AM552R	QT967SS		QTE967R
USK-AM553L	QT967SS	QTE967L	
USK-AT12889R	QT967SS		QTE967R
USK-ES187L	QT967SS	QTE967L	
USK-ES187R	QT967SS		QTE967R
USK-K844L	QT108SB	QTE108L	
USK-K844R	QT108SB	QTE108L	QTE108R
VOLVO / WHITE			
111067	QT108SB	QTE108L	
111068	QT108SB		QTE108R
1016903	QT108SB	QTE108L	
1110067	QT108SB		QTE108R
1112811	QT967SS	QTE967L	
1117994	QT967SS	QTE967L	
1117995	QT108SB		QTE967R
3945950	QT108SB	QTE108L	
3945951	QT108SB		QTE108R
3948202	QT108SB		QTE967R
3948208	QT967SS		QTE967R
3948236	QT108SB	QTE967L	
3948867	QT967SS	QTE967L	
3948868	QT108SB		QTE967R
3948883	QT967SS	QTE967L	
3948884	QT108SB		QTE967R
27092084	QT967SS	QTE967L	

COMPETITOR #	ASSEMBLY	LEFT*	RIGHT*
VOLVO / WHITE			
27092085	QT108SB		QTE967R
85102466	QT108SB		QTE967R
85102535	QT967SS	QTE967L	
85106747	QT967SS	QTE967L	
85106953	QT108SB	QTE108L	
85106954	QT108SB		QTE108R
85110478	QT967SS	QTE967L	
85110479	QT108SB		QTE967R
85112006	QT108SB		QTE967R
85112007	QT967SS	QTE967L	
370240004	QT967SS	QTE967L	
370240005	QT108SB		QTE967R
370245001	QT108SB	QTE108L	
370245002	QT108SB		QTE108R
370245009	QT108SB		QTE967R
370245010	QT108SB		QTE967R
370245011	QT967SS	QTE967L	
851102007	QT967SS	QTE967L	
838308B	QT108SB	QTE108L	
839307B	QT108SB		QTE108R
839308B	QT108SB	QTE108L	
A13144F370	QT108SB		QTE108R
A3144C237	QT108SB	QTE108L	
A3144C549	QT108SB	QTE108L	
A3144D238	QT108SB		QTE108R
A3144D524	QT967SS		QTE967R
A3144D550	QT108SB		QTE108R
A3144E525	QT967SS	QTE967L	
A3144J296	QT108SB		QTE108R
A3144J297	QT108SB		QTE108R
A3144K297	QT108SB	QTE108L	
A3144K298	QT108SB	QTE108L	
A3144K298	QT108SB		QTE108R
A3144Q225	QT967SS	QTE967L	
A3144R226	QT967SS		QTE967R
A3144U437	QT108SB		QTE108R
A3144U438	QT108SB	QTE108L	
A3144V437	QT108SB		QTE108R
A3144V438	QT108SB	QTE108L	
V1091562	QT967SS	QTE967L	
V1091563	QT108SB		QTE967R
V1110067	QT108SB	QTE108L	
V1110068	QT108SB		QTE108R
V111067	QT108SB		QTE108R
V111068	QT108SB	QTE108L	
V1112818	QT967SS	QTE967L	
WESTERN STAR			
370035029	QT108SB	QTE108L	
370035031	QT108SB		QTE108R
370244412	QT967SS		QTE967R
WESTPORT			
143640-005	QT108SB		QTE108R
37025-0004	QT967SS	QTE967L	
37025-0005	QT967SS		QTE967R
WORKHORSE			
W8001028	QT108SB	QTE108L	
W8001029	QT108SB		QTE108R

* Only compatible with STEMCO Cross Tube QTT5773

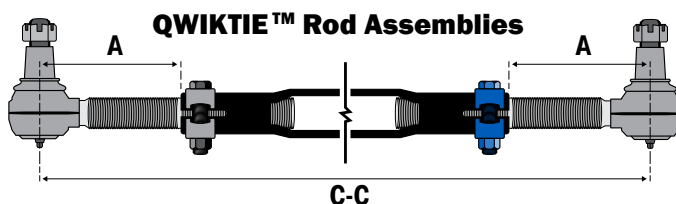

Fit a wide range of configurations,
QT967SS typical for 12,000 # axles (Green cap)
QT108SB typical for 16 & 20,000 # axles (Red cap)
Qwik Tie Assemblies adjust C-C 57⁵/₈" to 73⁵/₈"

When extending Rod Ends to the proper C-C
Maintain equal distance on both Left and Right A=A
Do not overextend beyond the groove on the thread

VERSATILE. EFFICIENT. SAFETY.

The QWIKTIE tie rod assembly offers a highly adaptable solution that can accommodate a wide range of tie rod lengths. Increased clamping and tube strength allows it to hold alignment longer, reducing stress on other suspension components.

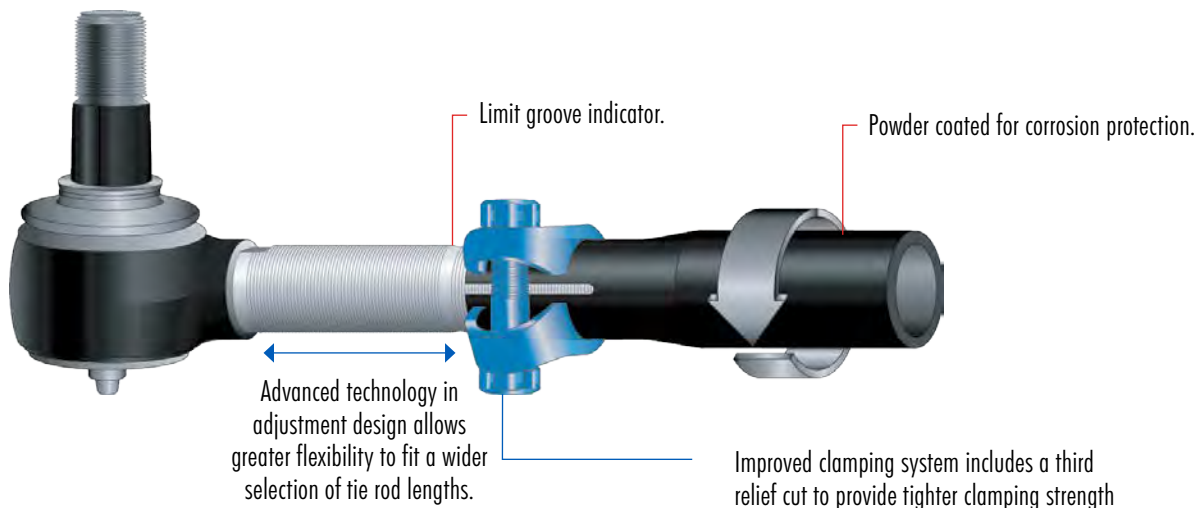
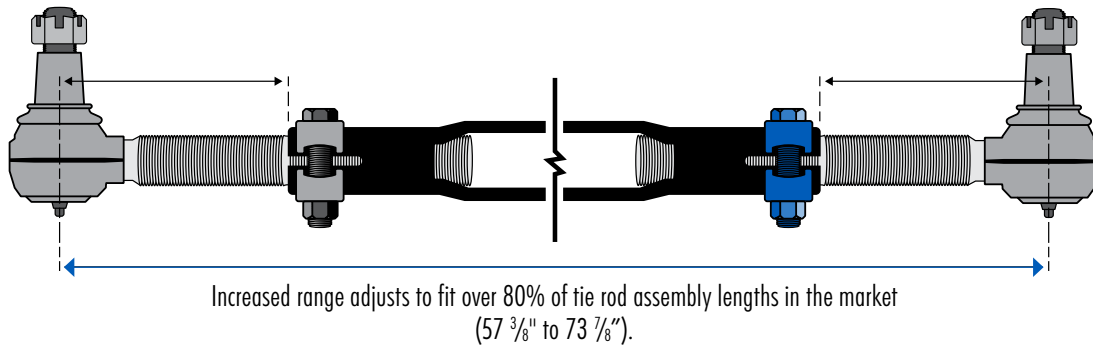

Improved clamping system includes a third relief cut to provide tighter clamping strength for a safer and more secure connection.

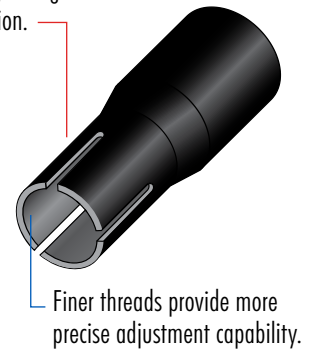

QWIKTIE TIE ROD ASSEMBLY

Tie Rod End Industry Std. Reference Number	QWIKTIE Part Number	Axle Code	King Pin
ES3219L, ES3220R	QT967SS	FF-961, FF-966	K961L
ES423L, ES423R		FF-981, FF-986	K981R
ES9001L, ES9001R		O2-ADD	K120I
ES431L, ES431R	QT108SB	FL-931, FL-941	KH931L
ES9328L, ES9329R		E1462I/W	K147E
ES431L, ES431R		EFA18F3, EFA20F4	K180E

This table captures example cross references to a QWIKTIE tie rod assembly. For any given axle or tie rod end, there can be many possible combinations of cross-tube lengths. For example, there could be as many as 40 different assemblies using the ES423L tie rod end.

FRONT STEERING AXLE

STEMCO Kaiser NO REAM king pin repairs do not require the complete removal of the spindle. Tear the unit down until the bushings can be removed. Be sure the spindles are clean and free from burrs prior to installing the bushings. Spiral bushings are easily installed by hand. After bushings are installed use the king pin to check for proper fit and clearance prior to placing the spindle back on the axle. Be sure and follow the installation instruction in the kit.

NO King Pin can repair worn axle or spindle eyes. Axle eyes can be repaired with the

AXLE · PRO · EQUIPMENT

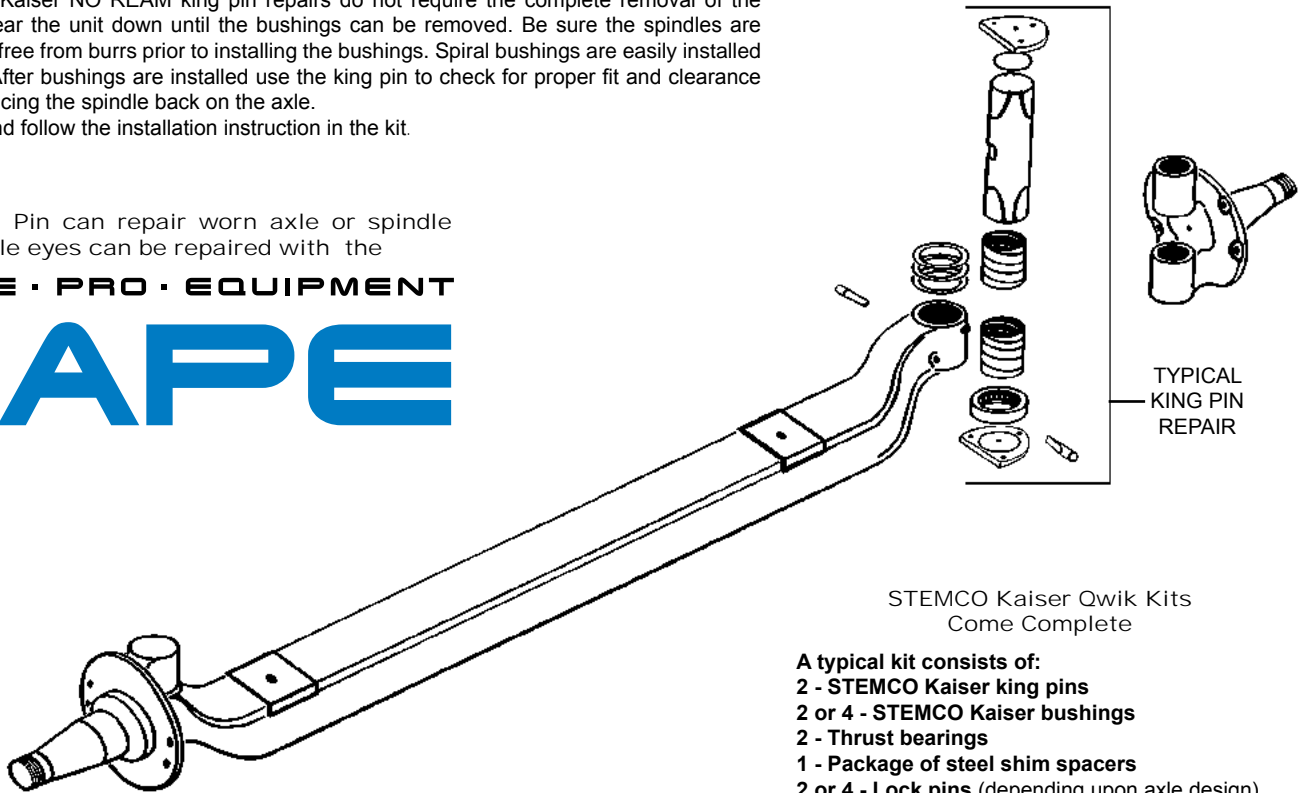

- STEMCO Kaiser Owik Kits
Come Complete
- A typical kit consists of:
- 2 - STEMCO Kaiser king pins
 - 2 or 4 - STEMCO Kaiser bushings
 - 2 - Thrust bearings
 - 1 - Package of steel shim spacers
 - 2 or 4 - Lock pins (depending upon axle design)
 - 4 - End plates and seals
 - 1 - Package of cap screws and washers

STEMCO Kaiser Spiral Steel Bushing must be used with STEMCO Kaiser grease grooved king pin.

FRONT SPRING SUSPENSION

STEMCO Kaiser grease grooved pins and NO-REAM bushing assemblies with seals will repair all positions on front springs and some rear spring applications.

It is not necessary to remove the spring from the vehicle. Repairing one end of the spring at a time will keep its position with the hanger. Drive out old pin and bushing and clean spring eye. Follow normal installation procedures.

Check pin in bushing assembly after it has been driven into the spring eye. Pin should not bind in bushing assembly.

The grooving on the pin provides more grease for better lubrication.

The seals on each end of the assembly keep lubrication in and dirt out. The combination provides longer life and less maintenance between repairs.

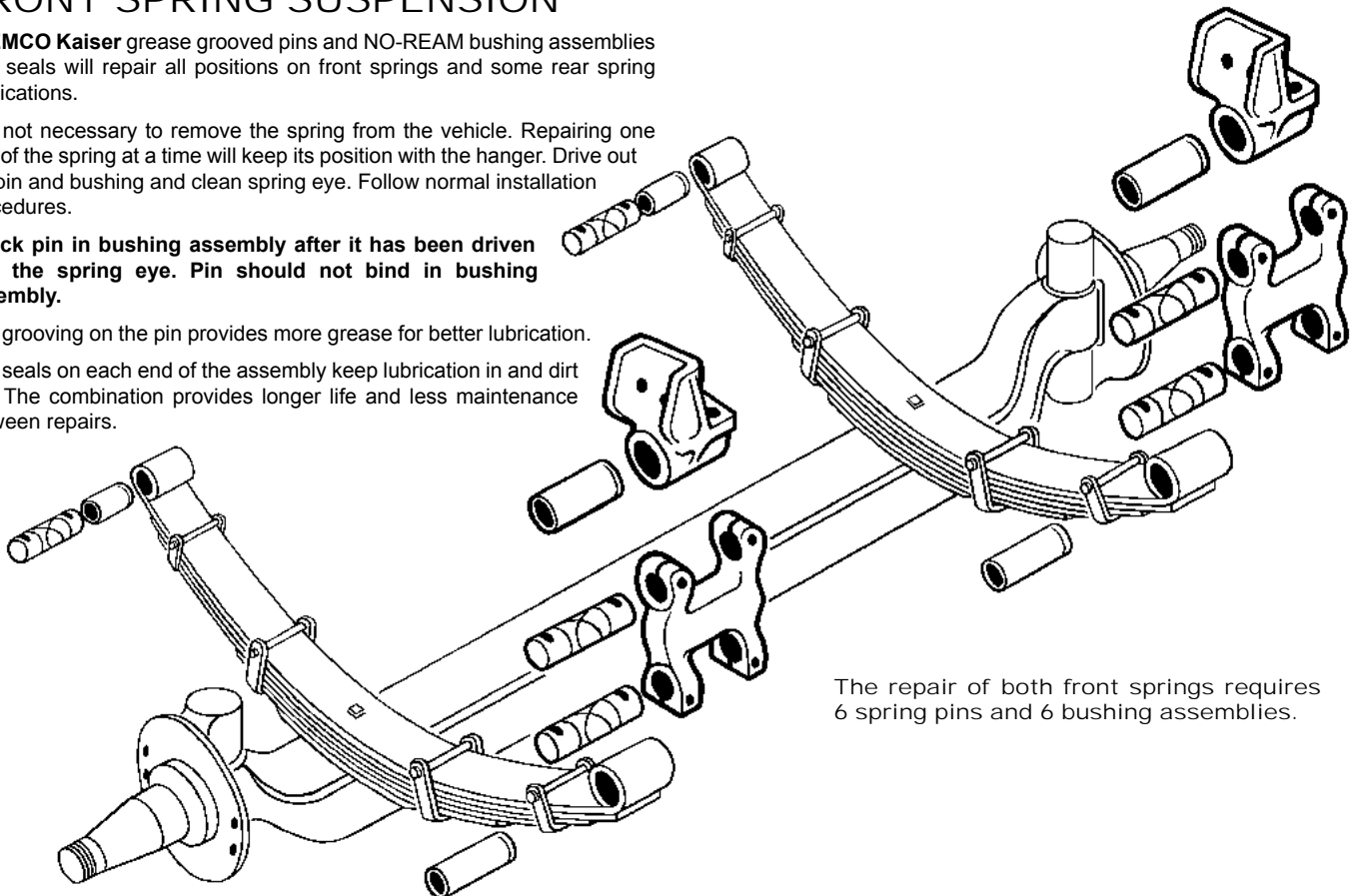

The repair of both front springs requires 6 spring pins and 6 bushing assemblies.

QWIKKIT® King Pin Kits



OPTIMALLY-LUBRICATED RAPID-INSTALL KING PINS LAST LONGER, MAKING THE ROADWAYS SAFER®

STEMCO Kaiser™ Qwik Kit® King Pin Kits install faster than reamed king pins, and last up to four times longer than original equipment and aftermarket competitors. A big reason for this longevity is a proprietary design allows for constant lubrication. STEMCO's king pins also showed in the Charpy Impact Test they stand up better to real-life peak loads such as curb strikes. This means they get a truck back on the road more quickly and keep them there over a longer, trouble-free king pin lifecycle.

Optimal Lubrication

STEMCO Kaiser™ No-Ream steel bushings and pins are grooved to provide an optimal stream of lubrication to high-wear areas.

Proven Materials

Proprietary high-chrome, high-carbon tool steel is found only in STEMCO king pins kits, balancing strength and resilience. This means it can withstand the constant turning and pounding placed on the steering knuckle and axle over the life of the vehicle.

Trained Technicians

STEMCO authorized technicians receive on-site training and complete technical information.

The Right Kit For You

Our VIN number search can cross-reference your vehicle to the correct kit from more than 100 kits for a proper fit.

Lifecycle Support

Live technical support is available for all STEMCO products.

Industry Leading Warranty

Less than two warranty claims per 10,000 kits.

Rapid Install

Faster turn time than reamed king pins.



PLUSKIT® King Pin Kits

**FOR NO REAM INSTALLATION, PERFECT FIT,
LESS DOWN TIME, AND BETTER QUALITY**

STEMCO Kaiser Plus Kit® has been offered as the preimum "no-ream" bi-metal king pin kit for over fifteen years. The Plus Kit offers pre-sized bi-metal bronze bushings with the fit of a tightly reamed king pin installation. The Plus Kit is the most economical way to do a king pin job. Now there is no reason to spend thousands on reamers and all the costs associated with reaming. You will get a great fit every time you use a STEMCO Kaiser Plus Kit.

Pre-Sized Bronze Bushings

Pre-sized bronze bushings have a fit as good as "reamed" without the expense.

Rapid Install

This kit installs faster with less down time than reaming; making the STEMCO Plus Kit® the best value in the market.

Trained Technicians

STEMCO authorized technicians receive on-site training and complete technical information.

The Right Kit For You

Our VIN number search can cross-reference your vehicle to the correct kit from more than 60 kits for a proper fit.

Life-Cycle Support

Live technical support is available for all STEMCO products.



AXLE · PRO · EQUIPMENT



APE
Axle Enhancement



THE SOLUTION FOR OUT-OF-ROUND AXLE EYES WITH EVERYTHING NEEDED FOR AN AXLE EYE REPAIR.

Only the STEMCO Axle Pro Equipment™ offers everything needed to enhance worn axle eyes. This revolutionary piece of equipment comes with mounting brackets, a magnetic-based drill, coolant, and safety equipment. When looking for an affordable, simple, and quick way to enhance worn axle eyes, choose the STEMCO APE.

Extending Axle Life

The STEMCO APE contains everything needed to enhance worn axle eyes without removing the axle.

Versatile System

Coverage to repair over 65 axle codes.

On The Spot Repair

Realize a quick return on investment with work done on-site without replacing or sending the axle out to be serviced.

Decreasing Down Time

A rugged, safe, and easy way, to enhance the axle eyes in just minutes.

Lifecycle Support

Live technical support is available for all STEMCO products.



STEMCO®

A Higher Standard of Performance.™

Making the Roadways Safer®

an EnPro Industries company



QWIKEXTRACT™



THE KING OF KING PIN REMOVAL SYSTEMS INTEGRATED CART AND SELF-ALIGNING PRESS FOR FAST, SAFE CHANGES

Designed by mechanics, for mechanics, the all-new STEMCO QwikExtract™ king pin removal system combines the speed and safety of a self-aligning, powerful removal press with a mobile wheel-end cart. The self-aligning system keeps the push rods lined up with the king pin for the fastest, most effective king pin removal in the industry. No need for wheel end tear down!

Convenient

Wheel end cart allows the brake drum, hub and their components to be moved out of the way together during the operation.

Reduces Strain

Eliminates operator strain and potential for injury from lifting or falling components.

Versatile

Interchangeable hub mounts accommodate most wheel end configurations.

Powerful

Industrial-quality hydraulic press removes the most stubborn king pins.

Strong

Holds up to 350 lbs.

Small Footprint

Ideal for working in tight spaces.



STEMCO®

A Higher Standard of Performance.™

an EnPro Industries company

Making the Roadways Safer®

HUBODOMETER[®]

TIRE CLASSIFICATION CATALOG

500,000 Mile Warranty



572-0007
Revised 8/99

STEMCO[®]
A Higher Standard of Performance.SM

WARRANTY

All merchandise ordered shall be sold subject to Stemco's standard warranty, viz: SELLER warrants that if any product of its manufacture upon examination is found by a SELLER representative to be defective in either workmanship or material under normal use and services, SELLER, at its option, will repair or replace same free of charge including transportation charges but not cost of installation or removal or will refund purchase price thereof. In no event shall SELLER be liable for any claim, whether arising from breach of contract or warranty or claims of negligence or negligent manufacture, in excess of the purchase price. ALL OTHER WARRANTIES EXPRESSED AND IMPLIED INCLUDING ANY WARRANTIES OF MERCHANTABILITY AND FITNESS FOR PARTICULAR USE ARE HEREBY DISCLAIMED. The foregoing expresses all of the SELLER'S obligations and liabilities with respect to the quality of items furnished by it and it shall under no circumstances be liable for consequential, collateral or special losses or damages.

All Hubodometers® manufactured during or after October, 1993 are warranted for 500,000 miles or 800,000 kilometers.

All Hubodometers® manufactured before October, 1993 are warranted for 300,000 miles or 500,000 kilometers.

Before submitting Hubodometers® for warranty consideration, please review the following list of conditions that nullify the Stemco warranty.

1. Stripped threads on stud.
2. Bent stud.
3. Back of Hubodometer® pulled out from over-torquing.
4. Back caved in.
5. Use of unauthorized bracket or improperly assembled bracket.
6. Side ring dented, bent, nicked or tampered with.
7. Polycarbonate front cover cracked, dented or abused.
8. Use of paints, solvents or thinner on the polycarbonate face.
9. Face plate caved in on the inside from a hard blow.
10. Hubodometers® manufactured before October, 1993 with more than 300,000 miles or 500,000 kilometers.
11. Hubodometers® manufactured after October, 1993 with more than 500,000 miles or 800,000 kilometers.

TABLE OF CONTENTS

WARRANTYINSIDE FRONT COVER

PRE-SET HUBODOMETERS®2

HUBODOMETER® APPLICATIONS BY MAKE, MODEL AND SIZE OF TIRE.....3

MOUNTING BRACKETS, ACCESSORIES AND HUB CAPS60

ENGINEERING CHANGES.....62

TIRE SIZE TO HUBODOMETER® CROSSOVER.....63

HUBODOMETER® CROSSOVER (OLD PART NUMBER TO NEW).....66

INSTALLATION INSTRUCTIONS.....INSIDE BACK COVER

HOW TO USE THIS CATALOG

This guide is to be used to identify the correct Stemco® Hubodometer® for commonly used truck tires listed by manufacturer and model.

Proper identification of the tire and the use of the appropriately calibrated Hubodometer® will provide the most accurate mileage recording. Stemco® Hubodometers® are specifically engineered and calibrated at the mid-tread life of the tire to assure mileage accuracy within ± 2%.

To identify the correct Hubodometer® for your particular tire, match the manufacturer, model and size identified on the tire sidewall to the corresponding information as listed in the guide. Select the calibration designation as it appears. For example: the Armstrong STR200 11R22.5 (p. 3) uses the Hubodometer® numbers 650-0601 (miles) or 650-0539 (km).

The designations in this guide relate solely to Hubodometer® calibration and do not imply traction, performance or mileage expectations of any tire. Tires with tread descriptions in the model name (Super Lug, Hi-Miler, etc.) are not indications of correct Hubodometer® calibration designations.

We are indebted to the tire manufacturers and their engineering staffs for their cooperation in providing the technical data that makes this list possible.



STEMCO®

A Higher Standard of Performance.™

TRUCK PRODUCTS DIVISION

Armstrong	Tire Size	Mile	Kilometer
DuraTrac	1100R20	650-0593	650-0534
DuraTrac	900R20	650-0601	650-0539
DuraTrac LP	285/75R24.5	650-0601	650-0539
DuraTrac LP	295/75R22.5	650-0610	650-0545
DuraTrac LP Drive	285/75R24.5	650-0601	650-0537
DuraTrac LP Drive	295/75R22.5	650-0610	650-0545
HD Trailer	8-14.5	650-0687	650-0578
Low Platform Trailer	1000-15	650-0626	650-0549
Low Platform Trailer	750-15	650-0688	None
Low Platform Trailer	825-15	650-0633	650-0561
Low Platform Trailer	900-15	650-0629	650-0554
Miracle Extra Traction	1000-20	650-0593	650-0535
Miracle Extra Traction	750-20	650-0618	650-0666
Miracle Extra Traction	825-20	650-0613	650-0664
Miracle Extra Traction	900-20	650-0601	650-0539
Norseman All Season	195/75R14	650-0700	650-0603
Norseman All Season	215/75R15	650-0698	None
Norseman All Season	215/85R16	650-0677	650-0571
Norseman All Season	235/75R15	650-0687	650-0578
Norseman All Season	235/85R16	650-0704	None
Norseman All Season	750R16	650-0675	None
Norseman All Season	875R16.5	650-0692	None
Norseman All Season	950R16.5	650-0690	650-0567
Premium Silent Lug	1000-20	650-0595	650-0537
Premium Silent Lug	1000-22	650-0583	650-0528
Premium Silent Lug	11-22.5	650-0593	650-0535
Premium Silent Lug	11-24.5	650-0671	650-0526
Premium Silent Lug	900-20	650-0601	650-0541
RTX	1000R20	650-0601	650-0539
RTX	1000R22	650-0587	650-0532
RTX	11R22.5	650-0601	650-0539
RTX	11R24.5	650-0587	650-0532
SD100	1000-20	650-0598	650-0539
SD100	1000-22	650-0584	650-0532
STR Traction 11	1000R20	650-0598	650-0537
STR Traction 11	1000R22	650-0587	650-0528
STR Traction 11	11R22.5	650-0598	650-0537
STR Traction 11	11R24.5	650-0587	650-0528
STR200	1000R20	650-0601	650-0539
STR200	1000R22	650-0587	650-0532
STR200	11R22.5	650-0601	650-0539
STR200	11R24.5	650-0587	650-0532
Super Heatmaster	1000-20	650-0598	650-0539
Super Heatmaster	1000-22	650-0584	650-0532
Super Heatmaster	11-22.5	650-0598	650-0539
Super Heatmaster	11-24.5	650-0584	650-0532
Super Heatmaster	1100-20	650-0591	650-0532
Super Heatmaster	750-20	650-0619	650-0666
Super Heatmaster	825-20	650-0616	650-0548
Super Heatmaster	900-20	650-0608	650-0545
Trailer Service Special	1000-20	650-0598	650-0539
Trailer Service Special	11-22.5	650-0598	650-0539
TransMiler	1000-20	650-0598	650-0539
TransMiler	1000-22	650-0583	650-0528
TransMiler	11-22.5	650-0598	650-0537
TransMiler	11-24.5	650-0671	650-0526
TransMiler	825-20	650-0613	650-0548
TransMiler	900-20	650-0605	650-0545

B. F. Goodrich	Tire Size	Mile	Kilometer
DR434	10R22.5	650-0608	650-0545
DR434	11R22.5	650-0601	650-0537
DR434	11R24.5	650-0587	650-0528
DR434	275/80R22.5	650-0610	650-0545
DR434	275/80R24.5	650-0601	650-0537
Regional Lug	11R22.5	650-0601	650-0539
Regional Lug	11R24.5	650-0591	650-0532
Regional Rib	10R22.5	650-0610	650-0545
Regional Rib	11R22.5	650-0601	650-0539
Regional Rib	11R24.5	650-0591	650-0532
ST220	11R22.5	650-0601	650-0539
ST220	11R24.5	650-0591	650-0532
ST230	10R22.5	650-0610	650-0545
ST230	11R22.5	650-0601	650-0539
ST230	12R22.5	650-0672	650-0549
ST230	255/70R22.5	650-0672	650-0549
ST230	315/80R22.5	650-0595	650-0535
ST234	11R22.5	650-0601	650-0539
ST234	11R24.5	650-0591	650-0532
ST234	275/80R22.5	650-0610	650-0545
ST234	275/80R24.5	650-0601	650-0539
ST565	11R22.5	650-0601	650-0539
TR134	11R22.5	650-0605	650-0541
TR134	11R24.5	650-0593	650-0534
TR134	275/80R22.5	650-0613	650-0664
TR134	275/80R24.5	650-0605	650-0541
Trailer	11R22.5	650-0605	650-0541
Trailer	11R24.5	650-0593	650-0534
Trailer	275/80R22.5	650-0613	650-0664
Trailer	275/80R24.5	650-0605	650-0541
Bridgestone			
AMR	1000-20	650-0601	650-0541
AMR	900-20	650-0610	650-0664
GG	900-20	650-0610	650-0545
K Miler	1000-20	650-0601	650-0541
K Miler	1000-22	650-0591	650-0532
K Miler	11-22.5	650-0601	650-0539
K Miler	11-24.5	650-0587	650-0532
K Miler	1100-22	650-0583	650-0528
K Miler	825-20	650-0618	650-0666
K Miler	900-20	650-0610	650-0664
L Miler	1000-20	650-0601	650-0539
L Miler	1000-22	650-0587	650-0532
L Miler	11-22.5	650-0601	650-0539
L Miler	11-24.5	650-0587	650-0532
L Miler	825-20	650-0618	650-0666
L Miler	900-20	650-0608	650-0545
L301	1000R20	650-0601	650-0537
L301	11R22.5	650-0601	650-0537
L301	11R24.5	650-0587	650-0528
L301	900R20	650-0608	650-0541
L312	445/65R22.5	650-0581	650-0525
L317	1000R20	650-0595	650-0537
L317	1000R22	650-0584	650-0528
L317	1100R20	650-0591	650-0532
L317	1100R22	650-0581	650-0525
L317	1100R24	650-0670	650-0521

Bridgestone...(cont'd)	Tire Size	Mile	Kilometer
L317	11R22.5	650-0595	650-0535
L317	11R24.5	650-0583	650-0528
L317	1200R24	650-0570	650-0519
L317	12R22.5	650-0587	650-0532
LM	750-20	650-0640	650-0549
M711	1000R20	650-0598	650-0537
M711	1000R22	650-0587	650-0528
M711	1100R22	650-0598	650-0537
M711	11R22.5	650-0598	650-0537
M711	11R24.5	650-0587	650-0528
M711	12R22.5	650-0591	650-0532
M711	255/70R22.5	650-0640	650-0549
M711	275/70R22.5	650-0617	650-0665
M711	285/75R24.5	650-0598	650-0537
M711	295/75R22.5	650-0608	650-0541
M711	385/65R22.5	650-0593	650-0535
M711	425/65R22.5	650-0583	650-0528
M716	1000R22	650-0587	650-0532
M716	1100R20	650-0593	650-0534
M716	1100R22	650-0583	650-0526
M716	11R24.5	650-0587	650-0532
M716	12R22.5	650-0593	650-0534
M716	215/70R17.5	650-0692	None
M716	255/70R22.5	650-0640	650-0549
M716F	10R22.5	650-0610	650-0545
M716F	215/75R17.5	650-0677	650-0571
M716F	245/75R22.5	650-0622	650-0666
M716F	265/75R22.5	650-0617	650-0548
M716F	9R22.5	650-0617	650-0548
M716F	1000R20	650-0601	650-0539
M716F	11R22.5	650-0601	650-0539
M716F	295/75R22.5	650-0608	650-0545
M716F	900R20	650-0610	650-0545
M716V	285/75R24.5	650-0601	650-0539
M716V	295/75R22.5	650-0608	650-0545
M720FE	285/75R24.5	650-0598	650-0537
M720FE	295/75R22.5	650-0608	650-0541
M722	1000R20	650-0598	650-0537
M722	11R22.5	650-0598	650-0537
M722	295/80R22.5	650-0598	650-0537
M724	8R19.5	650-0631	650-0559
M724F	225/70R19.5	650-0634	650-0563
M724F	245/70R19.5	650-0633	650-0561
M724F	8R19.5	650-0631	650-0559
M725	11R22.5	650-0598	650-0537
M725	11R24.5	650-0584	650-0528
M726	11R22.5	650-0598	650-0537
M726	11R24.5	650-0584	650-0528
M726	285/75R24.5	650-0595	650-0537
M726	295/75R22.5	650-0605	650-0541
M727	825R16	650-0631	650-0559
M741	11R24.5	650-0583	650-0528
M741	9R22.5	650-0616	650-0548
M747	18R19.5	650-0595	650-0535
M747	385/65R22.5	650-0595	650-0537
M747	425/65R22.5	650-0584	650-0528
M747	445/65R22.5	650-0671	650-0525
M747	445/75R19.5	650-0595	650-0535

Bridgestone...(cont'd)	Tire Size	Mile	Kilometer
M748	385/65R22.5	650-0595	650-0535
M748	425/65R22.5	650-0583	650-0526
M748	445/65R22.5	650-0581	650-0525
M757	1000R20	650-0601	650-0539
M757	1000R22	650-0587	650-0532
M757	10R22.5	650-0610	650-0545
M757	1100R20	650-0593	650-0534
M757	1100R22	650-0583	650-0526
M757	1100R24	650-0579	650-0523
M757	11R22.5	650-0601	650-0539
M757	11R24.5	650-0587	650-0532
M757	1200R20	650-0584	650-0528
M757	1200R24	650-0670	650-0521
M757	12R22.5	650-0593	650-0534
M757	315/80R22.5	650-0595	650-0535
M757	900R20	650-0610	650-0545
M767	1000R20	650-0601	650-0537
M767	11R22.5	650-0601	650-0537
M774	11R22.5	650-0593	650-0534
M774	11R24.5	650-0583	650-0526
M774	12R22.5	650-0587	650-0528
M810	11R22.5	650-0598	650-0537
M822	11R22.5	650-0595	650-0537
M840	1000R20	650-0595	650-0537
M840	1100R20	650-0587	650-0532
M840	1100R22	650-0671	650-0526
M840	11R22.5	650-0598	650-0537
M840	1200R20	650-0583	650-0526
M840	275/70R22.5	650-0617	650-0665
M840	295/80R22.5	650-0601	650-0537
M840	9R22.5	650-0616	650-0548
M843	11R22.5	650-0595	650-0535
M843	11R24.5	650-0583	650-0528
M843	12R22.5	650-0591	650-0532
M843	12R24.5	650-0671	650-0525
M843	315/80R22.5	650-0591	650-0532
M843	9R22.5	650-0616	650-0548
M844(F)	385/65R22.5	650-0593	650-0534
M844(F)	425/65R22.5	650-0583	650-0526
M844(F)	445/65R22.5	650-0581	650-0525
M847	18R19.5	650-0595	650-0535
M857	1000R20	650-0601	650-0539
M857	1000R22	650-0587	650-0532
M857	10R22.5	650-0610	650-0545
M857	1100R20	650-0593	650-0534
M857	1100R22	650-0583	650-0526
M857	1100R24	650-0579	650-0523
M857	11R22.5	650-0601	650-0539
M857	11R24.5	650-0587	650-0532
M857	1200R20	650-0584	650-0528
M857	1200R24	650-0670	650-0521
M857	12R22.5	650-0593	650-0534
M857	18R19.5	650-0595	650-0535
M857	255/70R22.5	650-0626	650-0549
M857	275/70R22.5	650-0617	650-0665
M857	315/80R22.5	650-0595	650-0535
M857	385/65R22.5	650-0595	650-0537
M857	425/65R22.5	650-0584	650-0528

Bridgestone...(cont'd)	Tire Size	Mile	Kilometer
M857	445/65R19.5	650-0595	650-0535
M857	445/65R22.5	650-0671	650-0525
M857	825R15	650-0633	650-0561
M857	825R20	650-0617	650-0665
M857	900R20	650-0610	650-0545
Metro R187F	10R22.5	650-0610	650-0545
Metro R187F	11R22.5	650-0601	650-0539
Metro R187F	225/70R19.5	650-0634	650-0563
Metro R187F	245/75R22.5	650-0622	650-0666
Metro R187F	265/75R22.5	650-0617	650-0665
Metro R187F	295/75R22.5	650-0610	650-0545
Metro R187F	8R19.5	650-0633	650-0561
Metro R187F	900R20	650-0613	650-0545
Metro R187F	9R22.5	650-0617	650-0665
MR	825-16	650-0633	650-0561
R160	385/65R22.5	650-0598	650-0537
R160	425/65R22.5	650-0584	650-0528
R164	385/65R22.5	650-0593	650-0535
R164	425/65R22.5	650-0583	650-0526
R164	445/65R22.5	650-0581	650-0525
R180	1000R15	650-0627	650-0552
R180	10R17.5	650-0631	None
R180	10R22.5	650-0610	650-0545
R180	11R22.5	650-0601	650-0539
R180	13/80R20	650-0601	650-0539
R180	14/80R20	650-0593	650-0534
R180	825R15	650-0673	650-0561
R180	825R16	650-0631	None
R180	825R20	650-0618	650-0665
R180	900R15	650-0629	650-0554
R180	900R20	650-0610	650-0545
R180	9R17.5	650-0673	650-0561
R180	9R22.5	650-0618	650-0665
R184	215/70R17.5	650-0695	650-0578
R184	215/75R17.5	650-0677	650-0571
R184	235/75R17.5	650-0704	None
R184	255/70R22.5	650-0672	650-0549
R184	275/70R22.5	650-0618	650-0665
R184	315/70R22.5	650-0610	650-0545
R184	315/75R22.5	650-0601	650-0539
R184	315/80R22.5	650-0610	650-0545
R184	9.5R17.5	650-0633	650-0561
R184LP	315/80R22.5	650-0610	650-0545
R187	1000R20	650-0601	650-0539
R187	10R22.5	650-0610	650-0545
R187	11R22.5	650-0601	650-0539
R187	11R24.5	650-0591	650-0532
R187	245/75R22.5	650-0622	650-0666
R187	295/75R22.5	650-0610	650-0545
R187	825R15TR	650-0633	650-0561
R187	900R20	650-0610	650-0545
R187	9R22.5	650-0617	650-0665
R187(F)	245/70R19.5	650-0633	650-0561
R187(F)	825R15	650-0633	650-0561
R192	275/70R22.5	650-0618	650-0665
R192	305/70R22.5	650-0613	650-0664
R194	1000R20	650-0605	650-0541
R194	11R22.5	650-0605	650-0541

Bridgestone...(cont'd)	Tire Size	Mile	Kilometer
R194	11R24.5	650-0593	650-0534
R194	255/70R22.5	650-0627	650-0552
R194	385/65R22.5	650-0593	650-0535
R194	425/65R22.5	650-0583	650-0526
R194F(FE)	285/75R24.5	650-0605	650-0541
R194F(FE)	295/75R22.5	650-0613	650-0545
R196	11R22.5	650-0601	650-0539
R196	11R24.5	650-0591	650-0532
R196	285/75R24.5	650-0601	650-0539
R196	295/75R22.5	650-0610	650-0545
R196	295/75R24.5	650-0610	650-0545
R220	750R16	650-0704	None
R226	11R22.5	650-0601	650-0539
R226	11R24.5	650-0587	650-0532
R226	285/75R24.5	650-0601	650-0539
R226	295/75R22.5	650-0610	650-0545
R227	11R22.5	650-0601	650-0539
R227	11R24.5	650-0591	650-0532
R227	285/75R24.5	650-0601	650-0539
R227	295/75R22.5	650-0610	650-0545
R230	700R15	650-0692	None
R230	750R16	650-0704	None
R250	11R22.5	650-0601	650-0539
R250	11R24.5	650-0591	650-0532
R250F	1000R20	650-0601	650-0539
R250F	10R22.5	650-0610	650-0545
R250F	1100R20	650-0595	650-0535
R250F	1100R22	650-0583	650-0528
R250F	1200R20	650-0583	650-0526
R250F	245/75R22.5	650-0622	650-0666
R250F	265/75R22.5	650-0617	650-0665
R250F	295/80R22.5	650-0601	650-0539
R250F	900R20	650-0610	650-0545
R250F	9R22.5	650-0617	650-0665
R250F	1000R20	650-0601	650-0539
R250F	10R22.5	650-0610	650-0545
R250F	1100R20	650-0595	650-0535
R250F	1100R22	650-0583	650-0528
R250F	1200R20	650-0583	650-0526
R250F	12R22.5	650-0593	650-0535
R250F	245/75R22.5	650-0622	650-0666
R250F	265/75R22.5	650-0617	650-0665
R250F	285/75R24.5	650-0601	650-0539
R250F	295/75R22.5	650-0610	650-0545
R250F	295/80R22.5	650-0601	650-0539
R250F	900R20	650-0610	650-0545
R250F	9R22.5	650-0617	650-0665
R250F	275/75R22.5	650-0610	650-0545
R251	1000R20	650-0601	650-0539
R251	11R22.5	650-0601	650-0539
R251	11R24.5	650-0591	650-0532
R260	800R16.5	650-0698	None
R260	875R16.5	650-0695	650-0578
R260	950R16.5	650-0677	650-0571
R260	9R16.5	650-0677	650-0571
R265	185/70R15.5	None	650-0603
R265	205/60R17.5	None	650-0589
R265	215/85R16	650-0677	650-0571

Bridgestone...(cont'd)	Tire Size	Mile	Kilometer
R265	225/75R16	650-0695	650-0578
R265	235/85R16	650-0704	None
R265	245/75R16	650-0677	650-0571
R265	8R17.5	650-0690	650-0567
R285	1000R20	650-0601	650-0539
R285	11R22.5	650-0601	650-0539
R290	1000R20	650-0601	650-0539
R290	1000R22	650-0591	650-0532
R290	10R22.5	650-0610	650-0545
R290	1100R20	650-0595	650-0535
R290	1100R22	650-0583	650-0528
R290	1200R20	650-0583	650-0528
R290	12R22.5	650-0593	650-0535
R290	900R20	650-0610	650-0545
R290	9R22.5	650-0617	650-0665
R293	11R22.5	650-0601	650-0539
R293	11R24.5	650-0591	650-0532
R294	215/75R17.5	650-0677	650-0571
R294	225/75R17.5	650-0688	650-0567
R294	255/70R22.5	650-0626	650-0549
R294	275/70R22.5	650-0618	650-0665
R294	275/80R22.5	650-0610	650-0545
R294	295/80R22.5	650-0601	650-0539
R294	305/70R22.5	650-0613	650-0664
R294	315/80R22.5	650-0595	650-0535
R295	900R20	650-0610	650-0545
R296	11R22.5	650-0605	650-0539
R299	11R22.5	650-0601	650-0539
R299	11R24.5	650-0591	650-0532
R299	275/80R22.5	650-0610	650-0545
R299	295/75R22.5	650-0610	650-0545
R299(FE)	285/75R24.5	650-0601	650-0539
R716	11R22.5	650-0601	650-0539
S740	11R22.5	650-0595	650-0537
S764	11R24.5	650-0583	650-0526
S764	1200R24	650-0570	650-0519
SF375	205/75R15	650-0699	650-0589
SLM	1000-20	650-0601	650-0539
SLM	1000-22	650-0587	650-0532
SLM	11-22.5	650-0598	650-0539
SLM	11-24.5	650-0584	650-0532
SLM	825-20	650-0618	650-0666
SLM	900-20	650-0610	650-0664
U Traction	1000-20	650-0598	650-0539
U Traction	1000-22	650-0584	650-0532
U Traction	11-22.5	650-0595	650-0537
U Traction	11-24.5	650-0583	650-0528
U Traction	900-20	650-0610	650-0545
ULX	1000-20	650-0601	650-0539
ULX	825-20	650-0617	650-0665
ULX	900-20	650-0610	650-0545
VHB	1400R24	650-0562	650-0514
VHB	385/95R24	650-0562	650-0514
VHB	385/95R25	650-0562	650-0514
VHB	445/95R25	650-0553	None
VSS	1000R20	650-0598	650-0537
VSS	1100R20	650-0593	650-0534
VSS	11R22.5	650-0598	650-0537

Bridgestone...(cont'd)	Tire Size	Mile	Kilometer
VSS	11R24.5	650-0584	650-0528
VSS	12R22.5	650-0593	650-0532
VSS	825R20	650-0617	650-0548
VSXA	750R16	650-0675	None
VSXA	8R17.5	650-0688	650-0567
VSXC	700R15	650-0692	None
VSXC	750R16	650-0675	None
Z Lug	1000-20	650-0595	650-0537
Z Lug	1000-22	650-0593	650-0535
Z Lug	1100-22	650-0581	650-0525
Z Lug	1200-24	650-0584	650-0532
Z Rib	1000-20	650-0595	650-0537
Z Rib	1000-22	650-0584	650-0528
Continental			
HC51	1100R20	650-0593	650-0534
HC51	11R22.5	650-0601	650-0539
HC51	11R24.5	650-0591	650-0532
HC51	1200R20	650-0583	650-0528
HC51	12R22.5	650-0583	650-0526
HC51	315/80R22.5	650-0595	650-0535
HC53	1000R20	650-0601	650-0539
HC53	1100R20	650-0593	650-0534
HC53	1100R22	650-0583	650-0526
HC53	1200R24	650-0670	650-0521
HC65	425/65R22.5	650-0583	650-0528
HC65	445/65R22.5	650-0671	650-0526
HC65	465/65R22.5	650-0583	650-0528
HD70	11R22.5	650-0601	650-0539
HD70	11R24.5	650-0591	650-0532
HD70	245/70R19.5	650-0633	650-0561
HD70	255/70R22.5	650-0626	650-0549
HD70	265/70R19.5	650-0631	650-0559
HD70	275/80R22.5	650-0608	650-0542
HD70	285/75R24.5	650-0601	650-0537
HD70	315/80R22.5	650-0595	650-0535
HD75	11R22.5	650-0601	650-0537
HD75	11R24.5	650-0587	650-0528
HD75	275/80R22.5	650-0608	650-0541
HD75	285/75R24.5	650-0601	650-0537
HD75	315/80R22.5	650-0595	650-0535
HD82	285/75R24.5	650-0598	650-0537
HD84/EOT	275/80R22.5	650-0608	650-0542
HD84/EOT	285/75R24.5	650-0601	650-0537
HMS45	315/80R22.5	650-0595	650-0535
HMS90	11R22.5	650-0605	650-0539
HMS90	245/70R19.5	650-0633	650-0561
HS41	1100R22	650-0583	650-0528
HS41	11R22.5	650-0601	650-0539
HS41	11R24.5	650-0591	650-0532
HS41	12R22.5	650-0593	650-0535
HS41	245/70R19.5	650-0673	650-0561
HS41	275/80R22.5	650-0610	650-0545
HS41	285/75R24.5	650-0601	650-0539
HS41	295/80R22.5	650-0601	650-0539
HS41	315/80R22.5	650-0595	650-0535
HS41	365/70R22.5	650-0593	650-0532
HS45	315/80R22.5	650-0595	650-0535

Continental...(cont'd)	Tire Size	Mile	Kilometer
HS62	11R22.5	650-0601	650-0539
HS62	11R24.5	650-0591	650-0532
HS62	215/75R17.5	650-0691	650-0571
HS62	235/75R17.5	650-0676	None
HS62	255/70R22.5	650-0672	650-0549
HS62	265/70R19.5	650-0631	650-0559
HS62	285/75R24.5	650-0601	650-0539
HS62	295/75R22.5	650-0601	650-0539
HS62	365/80R20	650-0593	650-0534
HS62	385/65R19.5	650-0616	650-0664
HS62	385/65R22.5	650-0598	650-0537
HS62	825R15	650-0673	650-0561
HS65	385/65R22.5	650-0598	650-0537
HS80/EOT	275/80R22.5	650-0608	650-0545
HS80/EOT	285/75R24.5	650-0601	650-0539
HS81	365/70R22.5	650-0593	650-0534
HS81/EOT	365/70R22.5	650-0593	650-0534
HT63	385/65R22.5	650-0598	650-0537
HT63	425/65R22.5	650-0671	650-0526
HT63	445/65R22.5	650-0671	650-0526
LS45	215/75R17.5	650-0691	650-0571
OS12	1000R15	650-0627	650-0552
RS415	10R17.5	650-0630	650-0559
RS415	10R22.5	650-0610	650-0545
RS415	205/75R17.5	650-0692	None
RS415	215/75R17.5	650-0690	650-0567
RS415	8.5R17.5	650-0704	None
RS415	8R17.5	650-0690	650-0567
RS415	900R20	650-0610	650-0545
RS415	9R22.5	650-0618	650-0665
RS415N	1100R20	650-0593	650-0534
RS415N	1200R20	650-0583	650-0528
RS415N	245/70R19.5	650-0673	650-0561
RS416	1000R20	650-0601	650-0539
RS416	10R22.5	650-0610	650-0545
RS416	1100R20	650-0595	650-0537
RS416	11R22.5	650-0601	650-0539
RS416	11R24.5	650-0591	650-0532
RS416	12R22.5	650-0595	650-0537
RS416	900R20	650-0610	650-0545
RS74	13/80R20	650-0601	650-0539
RT4	1000R20	650-0601	650-0537
RT4	1100R20	650-0593	650-0534
RT4	11R22.5	650-0601	650-0539
RT4	900R20	650-0610	650-0545
RT6	1000R20	650-0601	650-0537
RT6	11R22.5	650-0601	650-0539
RT6	900R20	650-0610	650-0545
RT8	1000R20	650-0601	650-0537
RT8	1100R20	650-0593	650-0534
RT8	11R22.5	650-0601	650-0537
Cooper			
ASR932	1000R20	650-0601	650-0539
ASR932	1000R22	650-0587	650-0532
ASR932	11R22.5	650-0601	650-0539
ASR932	11R24.5	650-0587	650-0532
ASR956	1000R20	650-0601	650-0539

Cooper...(cont'd)	Tire Size	Mile	Kilometer
ASR956	1000R22	650-0591	650-0532
ASR956	11R22.5	650-0601	650-0539
ASR956	11R24.5	650-0591	650-0532
ASR956	900R20	650-0610	650-0545
C120	215/85R16	650-0691	650-0571
C120	235/85R16	650-0704	None
C120	875R16.5	650-0695	None
C120	8R19.5	650-0631	None
C120	950R16.5	650-0677	650-0571
C140	215/85R16	650-0677	650-0571
C140	235/85R16	650-0675	None
C140	875R16.5	650-0692	None
C140	8R19.5	650-0631	650-0559
C140	950R16.5	650-0690	650-0567
CT240	295/75R22.5	650-0610	650-0545
CT240	11R22.5	650-0605	650-0539
CT240	11R24.5	650-0593	650-0534
CT240	285/75R24.5	650-0601	650-0539
CXML440	295/75R22.5	650-0605	650-0541
CXML440	11R22.5	650-0598	650-0537
CXML440	11R24.5	650-0587	650-0528
CXML440	285/75R24.5	650-0598	650-0537
CXMT340	10R22.5	650-0610	650-0545
CXMT340	295/75R22.5	650-0610	650-0545
CXMT340	1000R20	650-0601	650-0539
CXMT340	11R22.5	650-0601	650-0539
CXMT340	11R24.5	650-0591	650-0532
CXMT340	285/75R24.5	650-0601	650-0539
CXMT340	900R20	650-0610	650-0545
HiWay Service	1000-20	650-0601	650-0539
HiWay Service	1000-22	650-0587	650-0532
HiWay Service	11-22.5	650-0598	650-0539
HiWay Service	11-24.5	650-0584	650-0532
Low Platform Trailer	1000-15	650-0640	650-0549
Low Platform Trailer	750-15	650-0634	None
Low Platform Trailer	825-15	650-0631	650-0561
Low Platform Trailer	900-15	None	650-0554
Mastercraft H/T	11-22.5	650-0595	650-0537
Mastercraft H/T	1100-20	650-0593	650-0535
Mastercraft H/T	825-20	650-0616	650-0548
Mastercraft H/T	900-20	650-0605	650-0545
Mastercraft H/T	1000-20	650-0598	650-0537
Mastercraft H/T	1000-22	650-0584	650-0528
Mastercraft H/T	11-24.5	650-0583	650-0528
RoadGrip ST	1000-20	650-0595	650-0537
RoadGrip ST	1000-22	650-0583	650-0528
RoadGrip ST	11-22.5	650-0593	650-0535
RoadGrip ST	11-24.5	650-0671	650-0526
RoadGrip ST	1100-20	650-0587	650-0532
RoadGrip ST	825-20	650-0613	650-0664
RoadGrip ST	900-20	650-0598	650-0539
RoadMaster	1000-20	650-0598	650-0537
RoadMaster	1000-22	650-0584	650-0528
RoadMaster	11-22.5	650-0595	650-0537
RoadMaster	11-24.5	650-0583	650-0528
RoadMaster	1100-20	650-0593	650-0535
RoadMaster	700-15	650-0692	None
RoadMaster	750-16	650-0675	None

Cooper...(cont'd)	Tire Size	Mile	Kilometer
RoadMaster	825-20	650-0616	650-0548
RoadMaster	900-20	650-0605	650-0545
RoadMaster PV	1000-20	650-0601	650-0539
RoadMaster PV	1000-22	650-0587	650-0532
RoadMaster PV	11-22.5	650-0598	650-0539
RoadMaster PV	11-24.5	650-0584	650-0532
RoadMaster Trailer	1000-20	650-0598	650-0539
RoadMaster Trailer	11-22.5	650-0598	650-0539
RoadMaster Trailer	11-24.5	650-0584	650-0532
RoadMaster XML	1000-20	650-0595	650-0537
RoadMaster XML	1000-22	650-0583	650-0528
RoadMaster XML	11-22.5	650-0593	650-0535
RoadMaster XML	11-24.5	650-0671	650-0526
RoadMaster XML	1100-20	650-0587	650-0532
RoadMaster XML	825-20	650-0613	650-0664
RoadMaster XML	900-20	650-0598	650-0539
RoadMaster XMT	10-22.5	650-0601	650-0541
RoadMaster XMT	1000-20	650-0598	650-0539
RoadMaster XMT	11-22.5	650-0598	650-0539
RoadMaster XMT	11-24.5	650-0584	650-0532
RoadMaster XMT	1200-20	650-0584	650-0528
RoadMaster XMT	750-20	650-0622	650-0549
RoadMaster XMT	825-20	650-0616	650-0548
RoadMaster XMT	9-22.5	650-0613	650-0664
RoadMaster XMT	900-20	650-0605	650-0545
Super Road Master	245/75R16	650-0677	650-0571
Super Road Master	8-14.5	650-0694	650-0580
Super Road Master	8-17.5	650-0688	None
Super Road Master	8-19.5	650-0631	None
Super Road Master	800-16.5	650-0694	None
Super Road Master	875-16.5	650-0695	650-0578
Super Road Master	9-14.5	650-0694	None
Super Road Service	10-22.5	650-0601	650-0541
Super Road Service	1000-20	650-0598	650-0539
Super Road Service	11-22.5	650-0598	650-0539
Super Road Service	11-24.5	650-0584	650-0532
Super Road Service	1200-20	650-0584	650-0528
Super Road Service	750-20	650-0622	650-0549
Super Road Service	825-20	650-0616	650-0548
Super Road Service	9-22.5	650-0613	650-0664
Super Road Service	900-20	650-0605	650-0545
Super Traction	1000-20	650-0593	650-0535
Super Traction	750-20	650-0617	650-0665
Super Traction	825-20	650-0613	650-0664
Super Traction	900-20	650-0601	650-0541
Trailer Service	1000-20	650-0598	650-0539
Trailer Service	11-22.5	650-0598	650-0539
Trailer Service	11-24.5	650-0584	650-0532
Travel Trac	205/75R14	650-0700	650-0603
Travel Trac	205/75R15	650-0699	650-0592
Travel Trac	225/75R15	650-0698	650-0580
Truck Mud & Snow	1000-20	650-0593	650-0535
Truck Mud & Snow	750-20	650-0617	650-0665
Truck Mud & Snow	825-20	650-0613	650-0664
Truck Mud & Snow	900-20	650-0601	650-0541

Dayton	Tire Size	Mile	Kilometer
Extra Traction Lug	1000-20	650-0593	650-0535
Extra Traction Lug	825-20	650-0610	650-0664
Extra Traction Lug	900-20	650-0605	650-0541
Premium ESD	1000-20	650-0598	650-0537
Premium ESD	1000-22	650-0584	650-0528
Premium ESD	11-22.5	650-0598	650-0539
Premium ESD	11-24.5	650-0584	650-0532
Premium ESD	1100-20	650-0593	650-0535
Super EMT 11	1000-20	650-0601	650-0539
Super EMT 11	1000-22	650-0587	650-0532
Super EMT 11	11-22.5	650-0601	650-0539
Super EMT 11	11-24.5	650-0587	650-0532
Super EMT 11	1100-20	650-0593	650-0534
Super EMT 11	825-20	650-0616	650-0548
Super EMT 11	900-20	650-0608	650-0545
Super Highway	1000-15	650-0672	650-0552
Super Highway	750-15	650-0675	None
Super Highway	825-15	650-0633	650-0561
Super Highway	900-15	650-0629	650-0554
Thorobred	1000R20	650-0601	650-0539
Thorobred	1000R22	650-0591	650-0532
Thorobred	11R22.5	650-0601	650-0539
Thorobred	11R24.5	650-0591	650-0532
Traction Drive	1000R20	650-0601	650-0539
Traction Drive	1000R22	650-0591	650-0532
Traction Drive	11R24.5	650-0601	650-0539
Wide Track Rib L/P	285/75R24.5	650-0601	650-0539
Wide Track Rib L/P	295/75R22.5	650-0610	650-0545
Dunlop			
3 Rib HiWay	1000-20	650-0601	650-0539
3 Rib HiWay	1000-22	650-0587	650-0532
3 Rib HiWay	11-22.5	650-0598	650-0537
3 Rib HiWay	11-24.5	650-0584	650-0528
3 Rib HiWay	825-20	650-0616	650-0548
3 Rib HiWay	900-20	650-0608	650-0545
A/P RadialRover	750R16	650-0704	None
Gold Seal HT + Bar	1000-20	650-0593	650-0535
Gold Seal HT + Bar	900-20	650-0601	650-0541
Grandtrek	265/70R16	650-0677	650-0571
Grandtrek	275/70R16	650-0688	650-0567
HiWay Rib	1000-20	650-0598	650-0537
HiWay Rib	1000-22	650-0584	650-0528
HiWay Rib	11-22.5	650-0598	650-0537
HiWay Rib	11-24.5	650-0584	650-0528
HiWay Rib	900-20	650-0608	650-0545
Radial Rover A/T	215/85R16	650-0677	650-0571
Radial Rover A/T	225/75R16	650-0695	650-0578
Radial Rover A/T	235/85R16	650-0704	None
Radial Rover A/T	245/75R16	650-0677	650-0571
Radial Rover A/T	33x1250R16.5	650-0634	650-0563
Radial Rover A/T	750R16	650-0704	None
Radial Rover A/T	800R16.5	650-0696	650-0580
Radial Rover A/T	875R16.5	650-0692	None
Radial Rover A/T	950R16.5	650-0690	650-0567
Radial Rover HLT	215/85R16	650-0677	650-0571
Radial Rover HLT	225/75R16	650-0695	None
Radial Rover HLT	235/85R16	650-0704	None

Dunlop...(cont'd)	Tire Size	Mile	Kilometer
Radial Rover HLT	750R16	650-0704	None
Radial Rover HLT	875R16.5	650-0692	None
Radial Rover HLT	950R16.5	650-0690	650-0567
SP131	11R22.5	650-0605	650-0541
SP131	11R24.5	650-0593	650-0534
SP131	285/75R24.5	650-0605	650-0539
SP131	295/75R22.5	650-0613	650-0545
SP150	10R17.5	650-0631	650-0559
SP150	12R22.5	650-0595	650-0535
SP150	13/80R20	650-0601	650-0539
SP150	14/80R20	650-0593	650-0534
SP150	255/70R22.5	650-0627	650-0552
SP156	1000R20	650-0601	650-0539
SP156	1000R22	650-0591	650-0532
SP156	10R22.5	650-0610	650-0545
SP156	1100R20	650-0595	650-0535
SP156	11R22.5	650-0601	650-0539
SP156	11R24.5	650-0591	650-0532
SP156	900R20	650-0610	650-0545
SP156	9R22.5	650-0618	650-0665
SP160	1000R15	650-0627	650-0552
SP160	1000R20	650-0605	650-0539
SP160	10R22.5	650-0610	650-0545
SP160	1100R20	650-0595	650-0537
SP160	11R22.5	650-0605	650-0539
SP160	11R24.5	650-0593	650-0532
SP160	12R22.5	650-0595	650-0537
SP160	255/70R22.5	650-0672	650-0549
SP160	285/75R24.5	650-0601	650-0539
SP160	295/75R22.5	650-0610	650-0545
SP160	315/80R22.5	650-0595	650-0537
SP160	900R20	650-0610	650-0545
SP160	9R22.5	650-0618	650-0665
SP163	1000R15	650-0627	650-0552
SP163	825R15	650-0633	650-0561
SP163LPT	11R17.5	650-0627	650-0552
SP163LPT	10R17.5	650-0631	None
SP221	385/65R22.5	650-0595	650-0537
SP221	385/75R22.5	650-0595	650-0537
SP221	425/65R22.5	650-0584	650-0528
SP221	445/65R22.5	650-0581	650-0525
SP225	1000R20	650-0601	650-0539
SP225	11R22.5	650-0601	650-0537
SP231	255/70R22.5	650-0672	650-0549
SP231	385/65R22.5	650-0595	650-0537
SP231	425/65R22.5	650-0584	650-0528
SP231	445/65R22.5	650-0671	650-0525
SP280	1000R20	650-0598	650-0537
SP280	11R22.5	650-0598	650-0537
SP311	1100R22	650-0583	650-0526
SP321	10R22.5	650-0610	650-0545
SP321	1100R20	650-0595	650-0535
SP321	12R22.5	650-0595	650-0535
SP331	11R22.5	650-0601	650-0539
SP331	285/75R24.5	650-0601	650-0539
SP331	295/75R22.5	650-0610	650-0545
SP351	1000R20	650-0601	650-0539
SP351	11R22.5	650-0601	650-0539

Dunlop...(cont'd)	Tire Size	Mile	Kilometer
SP351	11R24.5	650-0591	650-0532
SP360	11R22.5	650-0605	650-0539
SP361	11R22.5	650-0601	650-0539
SP361	11R24.5	650-0591	650-0532
SP361	285/75R24.5	650-0601	650-0539
SP361	295/75R22.5	650-0610	650-0545
SP370	1000R20	650-0605	650-0539
SP370	11R22.5	650-0605	650-0539
SP370	900R20	650-0610	650-0545
SP407	1000R20	650-0601	650-0537
SP407	11R22.5	650-0601	650-0537
SP431	1000R20	650-0601	650-0537
SP431	1000R22	650-0587	650-0528
SP431	10R22.5	650-0610	650-0545
SP431	1100R20	650-0593	650-0534
SP431	11R22.5	650-0601	650-0537
SP431A	11R24.5	650-0587	650-0528
SP431A	12R22.5	650-0593	650-0534
SP431A	255/70R22.5	650-0626	650-0549
SP431A	285/75R24.5	650-0598	650-0537
SP431A	295/75R22.5	650-0605	650-0541
SP431A	900R20	650-0610	650-0545
SP777	1100R22	650-0583	650-0526
SP779	8R17.5	650-0675	None
SP781	1000R20	650-0601	650-0539
SP781	11R22.5	650-0601	650-0539
SP781	11R24.5	650-0587	650-0532
SP811	1000R20	650-0601	650-0539
SP811	1000R22	650-0591	650-0532
SP811	1100R20	650-0595	650-0535
SP811	1100R22	650-0583	650-0526
SP811	1100R24	650-0579	650-0523
SP811	11R22.5	650-0601	650-0539
SP811	11R24.5	650-0591	650-0532
SP811	1200R20	650-0584	650-0528
SP811	12R22.5	650-0581	650-0525
SP811	900R20	650-0610	650-0545
SP831	1000R20	650-0601	650-0539
SP831	1100R20	650-0593	650-0534
SP831	1100R22	650-0583	650-0526
SP831	11R22.5	650-0601	650-0539
SP831	11R24.5	650-0591	650-0532
SP831	12R22.5	650-0593	650-0534
SP880	11R22.5	650-0598	650-0537
SP880	12R22.5	650-0593	650-0534
SP889	11R22.5	650-0598	650-0537
SP889	11R24.5	650-0587	650-0528
SP889	12R22.5	650-0593	650-0534
SP931	1000R20	650-0595	650-0535
SP931	11R22.5	650-0595	650-0535
SP931	11R24.5	650-0583	650-0528
SP931	12R22.5	650-0591	650-0532
SPLT3	8R17.5	650-0688	650-0567
Triple Traction	1000-20	650-0595	650-0537
Triple Traction	825-20	650-0613	650-0548
Triple Traction	900-20	650-0605	650-0541

Firestone	Tire Size	Mile	Kilometer
ATX	225/75R15	650-0695	650-0578
ATX	235/75R15	650-0687	650-0578
City Transport	12.5-22.5	650-0593	650-0534
City Transport Radial	12R22.5	650-0593	650-0534
Duplex 2000	15R22.5	650-0598	650-0537
Duplex 2000	16.5R22.5	650-0584	650-0528
Duplex 2000	18R22.5	650-0671	650-0525
FD663	10R22.5	650-0608	650-0542
FD663	11R22.5	650-0601	650-0537
FD663	11R24.5	650-0587	650-0528
FD663	285/75R24.5	650-0601	650-0539
FD663	295/75R22.5	650-0608	650-0541
FS507	11R22.5	650-0601	650-0539
FS507	11R24.5	650-0597	650-0537
FS507	285/75R24.5	650-0601	650-0539
FS507	295/75R22.5	650-0610	650-0545
FT455	11R22.5	650-0605	650-0541
FT455	11R24.5	650-0593	650-0534
FT455	285/75R24.5	650-0601	650-0539
FT455	295/75R22.5	650-0613	650-0545
Heavy Duty Transport	1000-15	650-0672	650-0552
Heavy Duty Transport	750-15	650-0675	None
Heavy Duty Transport	825-15	650-0633	650-0561
Heavy Duty Transport	900-15	650-0629	650-0554
HP 2000	14/80R20	650-0593	650-0534
HP 2000	1000R20	650-0601	650-0539
HP 2000	1100R20	650-0595	650-0535
HP 2000	255/70R22.5	650-0626	650-0549
HP 2000	255/75R22.5	650-0610	650-0545
HP 2000	285/75R24.5	650-0601	650-0539
HP 2000	295/75R22.5	650-0610	650-0545
HP 2000	315/80R22.5	650-0595	650-0535
HP 2000	365/80R20	650-0593	650-0534
HP 3000	1100R20	650-0595	650-0535
HP 3000	1200R20	650-0587	650-0528
HP 3000	12R22.5	650-0595	650-0535
HP 3000	315/80R22.5	650-0595	650-0537
HP 3000	385/65R22.5	650-0595	650-0537
HS45	315/80R22.5	650-0595	650-0535
Longhauler	1100-20	650-0593	650-0535
Longhauler	750-20	650-0618	650-0666
PowerDrive	10-22.5	650-0598	650-0539
PowerDrive	1000-20	650-0595	650-0537
PowerDrive	1000-22	650-0583	650-0528
PowerDrive	11-22.5	650-0595	650-0537
PowerDrive	11-24.5	650-0583	650-0528
PowerDrive	1100-20	650-0584	650-0532
PowerDrive	1100-22	650-0579	650-0525
PowerDrive	825-20	650-0613	650-0664
PowerDrive	9-22.5	650-0610	650-0664
PowerDrive	900-20	650-0601	650-0539
PSD3000	1200R20	650-0583	650-0528
PSD3000	12R22.5	650-0593	650-0534
PSD3000	315/80R22.5	650-0593	650-0534
Rib Duplex	15-22.5	650-0598	650-0539
Rib Duplex	16.5-22.5	650-0593	650-0534
Rib Duplex	18-19.5	650-0598	650-0539
Rib Duplex	18-22.5	650-0583	650-0528

Firestone...(cont'd)	Tire Size	Mile	Kilometer
Super All Traction	750-20	650-0617	650-0665
Super All Traction	8-19.5	650-0629	650-0554
Super All Traction Duplex	14-17.5	650-0627	650-0552
Super All Traction Duplex	15-19.5	650-0613	650-0548
Super All Traction Duplex	15-22.5	650-0595	650-0537
Super All Traction Duplex	18-19.5	650-0595	650-0537
Super All Traction Duplex	18-22.5	650-0671	650-0526
Super All Traction ND	1000-20	650-0595	650-0537
Super All Traction ND	1100-20	650-0593	650-0534
Super All Traction ND	825-20	650-0610	650-0664
Super All Traction ND	900-20	650-0605	650-0541
T506	1000R20	650-0598	650-0537
T506	1000R22	650-0587	650-0528
T506	1100R20	650-0593	650-0532
T506	11R22.5	650-0598	650-0537
T506	11R24.5	650-0587	650-0528
T520	1000R20	650-0601	650-0539
T520	1000R22	650-0591	650-0532
T520	1100R22	650-0583	650-0528
T520	11R22.5	650-0601	650-0539
T520	11R24.5	650-0591	650-0532
T520	900R20	650-0610	650-0545
T545	11R22.5	650-0605	650-0541
T545	11R24.5	650-0593	650-0534
T545	285/75R24.5	650-0605	650-0541
T545	295/75R22.5	650-0593	650-0534
T546	1000R20	650-0601	650-0539
T546	1000R22	650-0591	650-0532
T546	10R22.5	650-0608	650-0542
T546	11R22.5	650-0601	650-0539
T546	11R24.5	650-0591	650-0532
T546	285/75R24.5	650-0601	650-0539
T546	295/75R22.5	650-0605	650-0541
T546	900R20	650-0610	650-0545
T559	1000R20	650-0601	650-0539
T559	10R22.5	650-0613	650-0545
T559	11R22.5	650-0601	650-0539
T559	11R24.5	650-0593	650-0532
T559	285/75R24.5	650-0601	650-0539
T559	295/75R22.5	650-0610	650-0545
T559	900R20	650-0613	650-0545
T574A	12.5-22.5	650-0593	650-0534
T574A	13-22.5	650-0584	650-0528
T575	1100R20	650-0595	650-0535
T575	1100R22	650-0583	650-0528
T575	12R22.5	650-0595	650-0535
T575	255/70R22.5	650-0626	650-0549
T588	285/75R24.5	650-0601	650-0539
T588	295/75R22.5	650-0610	650-0545
T589	11R22.5	650-0601	650-0539
T589	11R24.5	650-0591	650-0532
T589	255/70R22.5	650-0626	650-0549
T589	285/75R24.5	650-0601	650-0539
T589	295/75R22.5	650-0610	650-0545
T617	12.5-22.5	650-0593	650-0534
T663	10R22.5	650-0608	650-0542
T663	11R22.5	650-0598	650-0537
T663	11R24.5	650-0587	650-0528

Firestone...(cont'd)	Tire Size	Mile	Kilometer
T663	285/75R24.5	650-0601	650-0539
T663	295/75R22.5	650-0608	650-0541
T819	1000R20	650-0601	650-0539
T819	1100R20	650-0595	650-0535
T819	1100R22	650-0583	650-0526
T819	11R22.5	650-0601	650-0539
T819	11R24.5	650-0587	650-0532
T819	1200R20	650-0583	650-0526
T819	12R22.5	650-0593	650-0534
T823	1000R20	650-0598	650-0537
T823	1100R20	650-0593	650-0532
T823	11R22.5	650-0598	650-0537
T823	11R24.5	650-0587	650-0528
T831	1000R20	650-0598	650-0537
T831	1100R20	650-0595	650-0537
T831	1100R20	650-0591	650-0532
T831	11R22.5	650-0598	650-0537
T831	11R24.5	650-0583	650-0528
T831	12R22.5	650-0587	650-0532
T839	385/65R22.5	650-0595	650-0535
T839	425/65R22.5	650-0583	650-0528
T839	445/65R22.5	650-0581	650-0525
Traction Drive Radial	1000R20	650-0601	650-0539
Traction Drive Radial	1000R22	650-0587	650-0532
Traction Drive Radial	11R22.5	650-0601	650-0539
Traction Drive Radial	11R24.5	650-0587	650-0532
Transport	1200-20	650-0583	650-0528
Transport	700-15	650-0695	650-0578
Transport 1	10-22.5	650-0608	650-0545
Transport 1	1000-20	650-0595	650-0537
Transport 1	1000-22	650-0583	650-0528
Transport 1	11-22.5	650-0595	650-0537
Transport 1	11-24.5	650-0583	650-0528
Transport 1	1100-20	650-0591	650-0532
Transport 1	1100-22	650-0671	650-0526
Transport 1	12-22.5	650-0587	650-0532
Transport 1	750-20	650-0619	650-0666
Transport 1	8-19.5	650-0630	650-0559
Transport 1	825-20	650-0616	650-0548
Transport 1	9-22.5	650-0613	650-0664
Transport 1	900-20	650-0605	650-0541
Transport 1	950-16.5	650-0677	650-0571
Transport 110	8-19.5	650-0630	650-0559
Transport All Traction	1000-20	650-0595	650-0537
Transport All Traction	1000-22	650-0583	650-0528
Transport All Traction	1100-20	650-0587	650-0532
Transport All Traction	1100-22	650-0581	650-0525
Transport All Traction	825-20	650-0613	650-0548
Transport All Traction	900-20	650-0601	650-0541
Transport APS	1000-20	650-0601	650-0539
Transport APS	1000-22	650-0587	650-0532
Transport APS	11-22.5	650-0595	650-0537
Transport APS	11-24.5	650-0584	650-0532
Transport APS	825-20	650-0616	650-0548
Transport APS	900-20	650-0605	650-0541
Transport Duplex	15-19.5	650-0616	650-0548
UT2000	1000R20	650-0601	650-0539
UT2000	1000R22	650-0591	650-0532

Firestone...(cont'd)	Tire Size	Mile	Kilometer
UT2000	1100R20	650-0593	650-0535
UT2000	1100R22	650-0583	650-0526
UT2000	11R22.5	650-0601	650-0539
UT2000	11R24.5	650-0591	650-0532
UT2000	1200R20	650-0584	650-0528
UT2000	1200R24	650-0576	650-0521
UT2000	12R22.5	650-0593	650-0534
UT2000	315/80R22.5	650-0595	650-0535
WAT2000	10R22.5	650-0610	650-0545
WAT2000	1100R22	650-0583	650-0528
WAT2000	11R22.5	650-0601	650-0539
XR4	1000R15	650-0627	650-0552
XR4	1000R20	650-0601	650-0539
XR4	1000R22	650-0591	650-0532
XR4	10R17.5	650-0630	650-0554
XR4	11R22.5	650-0601	650-0539
XR4	11R24.5	650-0591	650-0532
XR4	825R15	650-0673	650-0561
XR4	900R15	650-0629	650-0554
General			
Ameri 550AS	215/85R16	650-0677	650-0571
Ameri 550AS	225/75R16	650-0695	650-0578
Ameri 550AS	235/75R15	None	650-0580
Ameri 550AS	235/75R15	None	650-0580
Ameri 550AS	235/85R16	650-0704	650-0680
Ameri 550AS	235/85R16	650-0704	None
Ameri 550AS	245/75R16	650-0691	650-0571
Ameri 550AS	25/75R16	650-0695	650-0578
Ameri 550AS	875R16.5	650-0695	650-0578
Ameri 550AS	950R16.5	650-0677	650-0571
Ameri 550TR	235/85R16	650-0634	650-0563
Ameri 550TR	245/75R16	650-0677	650-0571
Ameri DCL	1000-20	650-0595	650-0537
Ameri LP70	255/70R22.5	650-0672	650-0549
Ameri MSL	1000R20	650-0601	650-0539
Ameri MSL	1000R22	650-0587	650-0532
Ameri MSL	10R22.5	650-0610	650-0545
Ameri MSL	1100R20	650-0593	650-0534
Ameri MSL	1100R22	650-0583	650-0526
Ameri MSL	1100R24	650-0579	650-0523
Ameri MSL	11R22.5	650-0601	650-0539
Ameri MSL	11R24.5	650-0587	650-0532
Ameri MSL	1200R20	650-0584	650-0528
Ameri MSL	12R22.5	650-0595	650-0537
Ameri MSL	12R24.5	650-0583	650-0526
Ameri MSL	315/80R22.5	650-0595	650-0535
Ameri MSL	385/65R22.5	650-0598	650-0537
Ameri MSL	900R20	650-0610	650-0545
Ameri S350LP	285/75R24.5	650-0601	650-0539
Ameri S380	285/75R24.5	650-0601	650-0539
Ameri SRF	10-22.5	650-0605	650-0545
Ameri SRF	1000-20	650-0605	650-0545
Ameri SRF	1000-22	650-0584	650-0532
Ameri SRF	11-22.5	650-0608	650-0545
Ameri SRF	11-24.5	650-0595	650-0537
Ameri SRF	1100-20	650-0593	650-0534
Ameri SRF	12-24.5	650-0593	650-0535

General...(cont'd)	Tire Size	Mile	Kilometer
Ameri SRF	1200-20	650-0587	650-0532
Ameri SRF	825.20	650-0616	650-0548
Ameri SRF	9-22.5	650-0616	650-0548
Ameri SRF	900-20	650-0610	650-0545
AmeriFreight	1000-20	650-0605	650-0541
AmeriFreight	11-22.5	650-0598	650-0539
AmeriFreight	11-24.5	650-0591	650-0532
AmeriFreight	1100-20	650-0593	650-0535
AmeriFreight	825-20	650-0616	650-0548
AmeriFreight	900-20	650-0610	650-0545
AmeriGrip	215/85R16	650-0677	650-0571
AmeriJumbo JC	15-19.5	650-0616	650-0548
AmeriJumbo JC	15-22.5	650-0598	650-0537
AmeriJumbo JC	16.5-22.5	650-0584	650-0528
AmeriJumbo JC	18-22.5	650-0583	650-0528
AmeriJumbo SAG	15-19.5	650-0613	650-0664
AmeriJumbo SAG	15-22.5	650-0598	650-0537
AmeriJumbo SAG	18-19.5	650-0595	650-0537
AmeriJumbo SAG	18-22.5	650-0671	650-0526
AmeriLug	1000R20	650-0601	650-0537
AmeriLug	1000R22	650-0587	650-0528
AmeriLug	10R22.5	650-0608	650-0542
AmeriLug	1100R20	650-0593	650-0534
AmeriLug	12R22.5	650-0591	650-0532
AmeriLug	215/75R17.5	650-0690	650-0567
AmeriLug	245/70R19.5	650-0633	650-0561
AmeriLug	900R20	650-0610	650-0545
AmeriLug DT	1000R20	650-0595	650-0535
AmeriLug DT	1000R22	650-0583	650-0528
AmeriLug DT	1100R20	650-0591	650-0532
AmeriLug DT	1100R22	650-0671	650-0525
AmeriLug DT	1100R24	650-0670	650-0521
AmeriLug DT	11R22.5	650-0595	650-0535
AmeriLug DT	11R24.5	650-0583	650-0528
AmeriLug MS	1000R20	650-0601	650-0537
AmeriLug MS	11R22.5	650-0601	650-0537
AmeriLug MS	11R24.5	650-0587	650-0528
AmeriRib LP	285/75R24.5	650-0605	650-0539
AmeriRib LP	295/75R22.5	650-0610	650-0545
AmeriRib ST	11R22.5	650-0601	650-0539
AmeriRib ST	11R24.5	650-0591	650-0532
AmeriSteel	1000R20	650-0601	650-0539
AmeriSteel	1000R22	650-0591	650-0532
AmeriSteel	10R22.5	650-0610	650-0545
AmeriSteel	1100R20	650-0595	650-0537
AmeriSteel	11R22.5	650-0601	650-0539
AmeriSteel	11R24.5	650-0591	650-0532
AmeriSteel	1200R20	650-0584	650-0528
AmeriSteel	12R22.5	650-0595	650-0537
AmeriSteel	215/85R16	650-0677	650-0571
AmeriSteel	245/70R19.5	650-0633	650-0561
AmeriSteel	315/80R22.5	650-0595	650-0535
AmeriSteel	365/80R20	650-0593	650-0534
AmeriSteel	385/65R22.5	650-0598	650-0537
AmeriSteel	825R20	650-0618	650-0665
AmeriSteel	900R20	650-0613	650-0545
AmeriSteel	9R22.5	650-0618	650-0665
AmeriSteel LPT	1000R15	None	650-0552

General...(cont'd)	Tire Size	Mile	Kilometer
AmeriSteel LPT	215/75R17.5	650-0677	650-0571
AmeriSteel LPT	235/75R17.5	650-0704	None
AmeriSteel LPT	825R15	650-0673	650-0561
AmeriSteel LT	195/75R14	650-0700	650-0603
AmeriSteel LT	235/85R16	650-0704	None
AmeriSteel LT	750R16	650-0704	None
Big Foot	225/75R16	650-0695	650-0578
D400	285/75R24.5	650-0601	650-0537
D440	11R22.5	650-0601	650-0537
D440	11R24.5	650-0587	650-0528
D440	295/75R22.5	650-0605	650-0541
D450	11R22.5	650-0601	650-0537
D450	11R24.5	650-0587	650-0532
D450	285/75R24.5	650-0601	650-0537
D450	295/75R22.5	650-0608	650-0542
D450	295/75R24.5	650-0601	650-0537
D460	11R22.5	650-0601	650-0537
D460	11R24.5	650-0587	650-0532
D460	285/75R24.5	650-0601	650-0537
D460	295/75R22.5	650-0608	650-0542
GCS	12.5-22.5	650-0593	650-0535
GeneralRib ST	11R22.5	650-0605	650-0541
GeneralRib ST	11R24.5	650-0593	650-0534
Grabber AP	265/75R16	650-0704	None
LP70	295/75R22.5	650-0610	650-0545
M87	11R22.5	650-0601	650-0539
M87	9R22.5	650-0618	650-0665
M94	11R22.5	650-0601	650-0539
M97	950R16LT	650-0704	None
ND Waste Hauler	1000-20	650-0587	650-0532
ND Waste Hauler	1100-20	650-0584	650-0532
S330	11R22.5	650-0601	650-0539
S330	11R24.5	650-0591	650-0532
S350	295/75R22.5	650-0610	650-0545
S370	11R22.5	650-0601	650-0539
S370	11R24.5	650-0591	650-0532
S370	285/75R24.5	650-0601	650-0539
S370	295/75R22.5	650-0610	650-0545
S380	295/75R22.5	650-0610	650-0545
S380A	11R22.5	650-0601	650-0539
S380A	11R24.5	650-0591	650-0532
S380A	285/75R24.5	650-0601	650-0539
S380A	295-75R22.5	650-0610	650-0545
SD400	245/75R22.5	650-0622	650-0666
SD400	265/75R22.5	650-0617	650-0548
Super All Grip	1000-20	650-0598	650-0537
Super All Grip	1100-20	650-0593	650-0535
Super All Grip	825-20	650-0613	650-0548
Super All Grip	900-20	650-0605	650-0545
VersaTrac LT	235/85R16	650-0675	None
XP2000 ST	225/75R16	650-0695	650-0578
Goodyear			
4R	11.00-16SL	650-0622	None
4R	11L-15SL	650-0690	650-0571
4R	7.5L-15SL	650-0696	650-0580
4R	9.5L-15SL	650-0692	None
AT	7.50-16	650-0677	650-0571

Goodyear	Tire Size	Mile	Kilometer
AWT	12.4-16	650-0630	650-0559
AWT	13.6-16.1	650-0622	650-0549
AWT	13.6-28	650-0570	650-0521
AWT	14.9-24	650-0579	650-0523
AWT	16.5L-16.1SL	650-0672	650-0552
AWT	16.9-24	650-0576	650-0521
AWT	18.4-16.1	650-0605	650-0545
AWT	18.4-26	650-0565	650-0518
AWT	23.1-26	650-0555	650-0514
AWT	24.5-32	650-0663	650-0659
AWT	28L-26	650-0553	None
AWT	30.5L-32	None	650-0659
AWT	30.5L-32	650-0708	650-0659
AWT	9.5-16	650-0676	650-0567
AWT	9.5-24	650-0616	650-0548
City Cruiser XT	12.5-22.5	650-0593	650-0534
City Cruiser XT	1200-20	650-0584	650-0528
City Cruiser XT	13-22.5	650-0583	650-0528
Cross Rib HiMiler	11-22.5	650-0593	650-0535
Cross Rib HiMiler	1100-22	650-0581	650-0525
Cross Rib HiMiler	900-20	650-0605	650-0541
Custom Cross Rib	1000-20	650-0595	650-0537
Custom Cruiser	11.50-20	650-0593	650-0534
Custom Cruiser	12.5-22.5	650-0591	650-0532
Custom HiMiler	12-16.5	650-0634	650-0563
Custom HiMiler	1200-20	650-0587	650-0532
Custom HiMiler	1400-24	650-0565	650-0518
Custom HiMiler	18-19.5	650-0598	650-0539
Custom HiMiler	825-16	650-0631	None
Custom HiMiler SS	15-22.5	650-0593	650-0535
Custom HiMiler SS	16.5-22.5	650-0583	650-0528
Custom HiMiler SS	18-22.5	650-0598	650-0539
D205	295/75R22.5	650-0605	650-0541
D805	11R22.5	650-0598	650-0537
DR	11.00-16SL	650-0622	None
DR	11.00-24SL	650-0581	650-0525
DR	11L-15SL	650-0676	650-0567
DR	14L-16.1SL	650-0618	650-0666
DR	16.5L-16.1SL	650-0601	650-0541
Extra Grip HiMiler	1000-20	650-0598	650-0537
Extra Grip HiMiler	1100-20	650-0587	650-0532
Extra Grip HiMiler	750-20	650-0618	650-0666
Extra Grip HiMiler	825-20	650-0613	650-0664
Extra Grip HiMiler	900-20	650-0605	650-0541
Farms	12.5L-16SL	650-0675	None
Farms	14L-16.1SL	650-0630	650-0559
Farms	16.5L-16.1SL	650-0626	650-0549
Farms	19L-16.1SL	650-0622	650-0549
Farms	21.5L-16.1SL	650-0616	650-0548
FARMU	11L-15SL	650-0696	650-0580
FARMU	12.5L-15SL	650-0688	None
FHUT	11L-14SL	650-0694	None
FHWYSER	11L-15FI	650-0696	650-0580
FHWYSER	12.5L-15FI	650-0688	None
FHWYSER	9.5L-15FI	650-0687	650-0578
G152 Metro Miler	12.5R22.5	650-0593	650-0534
G22	825R16	650-0631	None
Hardrock Rib	1400-24	650-0560	650-0662

Goodyear...(cont'd)	Tire Size	Mile	Kilometer
HiMiler CS2	1000-20	650-0601	650-0539
HiMiler CS2	1000-22	650-0587	650-0532
HiMiler CS2	11-22.5	650-0601	650-0539
HiMiler CS2	11-24.5	650-0587	650-0532
HiMiler CS2	825-20	650-0618	650-0666
HiMiler CS2	900-20	650-0610	650-0664
HiMiler LPT	1000-15	650-0627	650-0552
HiMiler LPT	750-15	650-0675	None
HiMiler LPT	825-15	650-0633	650-0561
HiMiler LPT	900-15	650-0629	650-0559
HiWay Workhorse	950-16.5	650-0691	650-0571
Marathon	175/80R13	650-0702	None
Marathon	205/75R15	650-0699	650-0589
Marathon	225/75R15	650-0694	650-0580
MetroMiler	308/85R22.5	650-0591	650-0532
OHTSU	295/75R22.5	650-0610	650-0545
RT/S	255/70R16	650-0691	None
SGI	10.5/80-18	650-0630	650-0559
SGI	12.5/80-18	650-0672	650-0552
SGTR	12.5L-15SL	650-0704	650-0688
SGTR	13.50-16.1	650-0617	650-0665
SGTR	16.5L-16.1SL	650-0619	650-0666
SGTR	21.5L-16.1SL	650-0613	650-0664
SGTR	6.70-15SL	650-0698	None
SGTR	7.50-16SL	650-0692	None
SGTR	7.50-18SL	650-0634	None
SGTR	7.50-20SL	650-0631	650-0561
SGTR	7.60-15SL	650-0687	650-0578
SMO	16.9-30	650-0555	650-0514
SR	9.5L-15SL	650-0691	650-0705
ST 11	21.5L-16.1SL	650-0610	650-0664
Super HiMiler	10-22.5	650-0605	650-0541
Super HiMiler	1000-20	650-0601	650-0539
Super HiMiler	1000-22	650-0584	650-0532
Super HiMiler	1000R20	650-0601	650-0539
Super HiMiler	11-22.5	650-0598	650-0539
Super HiMiler	11-24.5	650-0587	650-0532
Super HiMiler	1100-20	650-0593	650-0535
Super HiMiler	1100-22	650-0583	650-0528
Super HiMiler	750-20	650-0622	None
Super HiMiler	825-20	650-0616	650-0548
Super HiMiler	900-20	650-0608	650-0545
Super HiMiler 11	1000-20	650-0598	650-0539
Super HiMiler 11	11-22.5	650-0598	650-0539
Super HiMiler TR	1000R20	650-0601	650-0539
Super HiMiler TR	11R22.5	650-0601	650-0539
Super HiMiler TR	11R24.5	650-0591	650-0532
Super Sure Grip	48x31x20	650-0576	650-0521
Sure Grip Grader	1400-24	650-0565	650-0518
SureGrip (G2)	15.5 x 25	650-0670	650-0523
SureGrip (L2)	15.5 x 25	650-0581	650-0526
Traction HiMiler	8-22.5	650-0640	None
Traction Road Lug SS	15-22.5	650-0595	650-0537
Traction Road Lug SS	18-22.5	650-0579	650-0525
Trailer Special	1000-20	650-0601	650-0541
Trailer Special	11-22.5	650-0601	650-0541
Trailer Special	8-22.5	650-0618	650-0666
Unisteel 11	1000R20	650-0601	650-0539

Goodyear...(cont'd)	Tire Size	Mile	Kilometer
Unisteel 11	1000R22	650-0591	650-0532
Unisteel 11	10R22.5	650-0610	650-0545
Unisteel 11	1100R20	650-0595	650-0535
Unisteel 11	11R22.5	650-0601	650-0539
Unisteel 11	11R24.5	650-0591	650-0532
Unisteel 11	12.75R22.5	650-0593	650-0534
Unisteel 11	12R22.5	650-0595	650-0535
Unisteel 11	825R20	650-0617	650-0665
Unisteel 11	900R20	650-0610	650-0545
Unisteel 11	9R22.5	650-0617	650-0665
Unisteel AT2A	1100R20	650-0593	650-0534
Unisteel AT2A	1400R20	650-0570	650-0519
Unisteel AT2A	1600R20	650-0565	650-0518
Unisteel G114	1000R15	650-0627	650-0552
Unisteel G114	1000R20	650-0601	650-0539
Unisteel G114	10R17.5	650-0631	None
Unisteel G114	10R22.5	650-0613	650-0664
Unisteel G114	11R17.5 HC	650-0627	650-0552
Unisteel G114	11R22.5	650-0601	650-0539
Unisteel G114	11R24.5	650-0591	650-0532
Unisteel G114	215/75R17.5	650-0677	650-0571
Unisteel G114	255/70R22.5	650-0627	650-0552
Unisteel G114	285/75R24.5	650-0601	650-0539
Unisteel G114	295/75R22.5	650-0610	650-0545
Unisteel G114	825R15TR	650-0633	650-0561
Unisteel G114	9R17.5 HC	650-0633	650-0561
Unisteel G124	1000R20	650-0601	650-0537
Unisteel G124	1000R22	650-0587	650-0532
Unisteel G124	10R22.5	650-0608	650-0545
Unisteel G124	1100R20	650-0593	650-0535
Unisteel G124	11R22.5	650-0601	650-0537
Unisteel G124	12R22.5	650-0593	650-0534
Unisteel G124	215/75R17.5	650-0691	650-0571
Unisteel G124	225/70R19.5	650-0634	650-0563
Unisteel G124	245/70R19.5	650-0633	650-0561
Unisteel G124	245/75R22.5	650-0622	650-0666
Unisteel G124	255/70R22.5	650-0626	650-0549
Unisteel G124	265/70R19.5	650-0630	650-0559
Unisteel G124	265/75R22.5	650-0616	650-0548
Unisteel G124	285/75R24.5	650-0601	650-0537
Unisteel G124	295/75R22.5	650-0608	650-0541
Unisteel G124	315/80R22.5	650-0593	650-0534
Unisteel G124	825R20	650-0617	650-0548
Unisteel G124	900R20	650-0610	650-0545
Unisteel G124	9R22.5	650-0617	650-0548
Unisteel G124LP	11R24.5	650-0587	650-0532
Unisteel G124LP	11R22.5	650-0601	650-0537
Unisteel G124LP	11R24.5	650-0587	650-0532
Unisteel G124LP	225/70R19.5	650-0634	650-0563
Unisteel G124LP	245/70R19.5	650-0633	650-0561
Unisteel G124LP	285/75R24.5	650-0601	650-0537
Unisteel G124LP	295/75R22.5	650-0608	650-0541
Unisteel G132	11R22.5	650-0601	650-0539
Unisteel G132	11R24.5	650-0591	650-0532
Unisteel G132	255/70R22.5	650-0627	650-0552
Unisteel G132	285/75R24.5	650-0601	650-0539
Unisteel G132	295/75R22.5	650-0610	650-0545
Unisteel G133	750R16	650-0688	650-0567

Goodyear...(cont'd)	Tire Size	Mile	Kilometer
Unisteel G133	875R16.5	650-0687	650-0578
Unisteel G133	950R16.5	650-0692	None
Unisteel G133LT	215/85R16	650-0677	650-0571
Unisteel G133LT	235/85R16	650-0690	650-0567
Unisteel G133LT	8R19.5	650-0633	650-0561
Unisteel G143	11R22.5	650-0595	650-0537
Unisteel G143	11R24.5	650-0584	650-0528
Unisteel G143	12R22.5	650-0593	650-0534
Unisteel G144	1000R20	650-0598	650-0537
Unisteel G144	1000R22	650-0587	650-0532
Unisteel G144	1100R20	650-0593	650-0534
Unisteel G144	1100R22	650-0671	650-0526
Unisteel G144	1100R24	650-0579	None
Unisteel G144	11R22.5	650-0598	650-0537
Unisteel G144	11R24.5	650-0584	650-0528
Unisteel G144	12R22.5	650-0593	650-0534
Unisteel G144	12R24.5	650-0583	650-0526
Unisteel G152	275/70R22.5	650-0618	650-0665
Unisteel G159	10R22.5	650-0610	650-0545
Unisteel G159	1100R20	650-0593	650-0534
Unisteel G159	12R22.5	650-0593	650-0534
Unisteel G159	225/70R19.5	650-0634	650-0563
Unisteel G159	245/70R19.5	650-0673	650-0561
Unisteel G159	245/75R22.5	650-0640	650-0549
Unisteel G159	265/75R22.5	650-0616	650-0548
Unisteel G159	275/70R22.5	650-0618	650-0665
Unisteel G159	295/80R22.5	650-0601	650-0539
Unisteel G159	365/80R20	650-0593	650-0534
Unisteel G159	385/65R22.5	650-0595	650-0537
Unisteel G159	825R20	650-0617	650-0665
Unisteel G159	900R20	650-0610	650-0545
Unisteel G159	9R22.5	650-0617	650-0665
Unisteel G159C	295/75R22.5	650-0608	650-0545
Unisteel G159A	1000R20	650-0601	650-0539
Unisteel G159A	1000R22	650-0591	650-0532
Unisteel G159A	11R22.5	650-0601	650-0539
Unisteel G159A	11R24.5	650-0591	650-0532
Unisteel G159A	225/70R19.5	650-0634	650-0563
Unisteel G159A	255/70R22.5	650-0672	650-0549
Unisteel G159A	285/75R24.5	650-0601	650-0539
Unisteel G159A	295/75R22.5	650-0608	650-0545
Unisteel G159LT	215/85R16	650-0677	650-0571
Unisteel G159LT	225/75R16	650-0695	650-0578
Unisteel G159LT	235/85R16	650-0690	650-0567
Unisteel G159LT	245/75R16	650-0690	650-0567
Unisteel G159LT	750R16	650-0688	650-0567
Unisteel G159LT	875R16.5	None	650-0580
Unisteel G159LT	8R19.5	650-0673	650-0561
Unisteel G159LT	950R16.5	650-0692	None
Unisteel G165	385/65R22.5	650-0595	650-0537
Unisteel G165	425/65R22.5	650-0584	650-0528
Unisteel G165	445/65R22.5	650-0671	650-0525
Unisteel G167	1000R22	650-0584	650-0528
Unisteel G167	10R22.5	650-0605	650-0541
Unisteel G167	1100R20	650-0593	650-0532
Unisteel G167	12R22.5	650-0593	650-0532
Unisteel G167	900R20	650-0605	650-0541
Unisteel G167A	1000R20	650-0598	650-0537

Goodyear...(cont'd)	Tire Size	Mile	Kilometer
Unisteel G167A	11R22.5	650-0598	650-0537
Unisteel G167A	11R24.5	650-0584	650-0528
Unisteel G167A	285/75R24.5	650-0598	650-0537
Unisteel G167A	295/75R22.5	650-0605	650-0541
Unisteel G171LT	215/85R16	650-0690	650-0567
Unisteel G171LT	235/85R16	650-0688	650-0567
Unisteel G171LT	750R16	650-0676	None
Unisteel G171LT	875R16.5	650-0695	650-0578
Unisteel G171LT	8R19.5	650-0633	650-0561
Unisteel G171LT	950R16.5	650-0677	650-0571
Unisteel G177	1000R20	650-0595	650-0537
Unisteel G177	1100R20	650-0587	650-0532
Unisteel G177	1100R22	650-0581	650-0525
Unisteel G177	11R22.5	650-0595	650-0537
Unisteel G177	11R24.5	650-0584	650-0528
Unisteel G177	1200R24	650-0570	650-0519
Unisteel G177	12R22.5	650-0587	650-0532
Unisteel G177	12R24.5	650-0581	650-0525
Unisteel G178SS	385/65R22.5	650-0593	650-0534
Unisteel G178SS	425/65R22.5	650-0583	650-0526
Unisteel G178SS	445/65R22.5	650-0579	650-0523
Unisteel G18	10R17.5	650-0631	None
Unisteel G18	825R15	650-0673	650-0561
Unisteel G180	14/80R20	650-0593	650-0534
Unisteel G181LT	215/85R16	650-0677	650-0571
Unisteel G181LT	235/85R16	650-0690	650-0567
Unisteel G181LT	750R16	650-0688	650-0567
Unisteel G181LT	875R16.5	650-0687	650-0578
Unisteel G181LT	8R19.5	650-0633	650-0561
Unisteel G181LT	950R16.5	650-0692	None
Unisteel G186	1000R20	650-0601	650-0537
Unisteel G186	1000R22	650-0587	650-0528
Unisteel G186	10R22.5	650-0608	650-0545
Unisteel G186	11R22.5	650-0601	650-0537
Unisteel G186	11R24.5	650-0587	650-0528
Unisteel G186	1200R20	650-0584	650-0528
Unisteel G186	1200R24	650-0670	650-0521
Unisteel G186	13/80R20	650-0601	650-0539
Unisteel G186	13R22.5	650-0583	650-0528
Unisteel G186	14/80R20	650-0593	650-0534
Unisteel G186	215/75R17.5	650-0690	650-0567
Unisteel G186	315/80R22.5	650-0595	650-0535
Unisteel G186	385/65R22.5	650-0595	650-0537
Unisteel G186	425/65R22.5	650-0584	650-0528
Unisteel G186	445/65R22.5	650-0671	650-0525
Unisteel G186	825R20	650-0617	650-0548
Unisteel G186	900R20	650-0608	650-0545
Unisteel G188	1000R20	650-0595	650-0535
Unisteel G188	1000R22	650-0583	650-0528
Unisteel G188	1100R20	650-0591	650-0532
Unisteel G188	1100R22	650-0671	650-0525
Unisteel G188	1100R24	650-0670	650-0521
Unisteel G188	11R22.5	650-0595	650-0535
Unisteel G188	11R24.5	650-0583	650-0528
Unisteel G188	1200R20	650-0583	650-0528
Unisteel G188	1200R24	650-0576	650-0519
Unisteel G188	12R22.5	650-0591	650-0532
Unisteel G188	12R24.5	650-0671	650-0525

Goodyear...(cont'd)	Tire Size	Mile	Kilometer
Unisteel G188	1400R20	650-0570	650-0519
Unisteel G188	445/65R22.5	650-0579	650-0523
Unisteel G218	11R22.5	650-0601	650-0539
Unisteel G244 (MSD)	1100R22	650-0583	650-0526
Unisteel G244 (MSD)	11R22.5	650-0598	650-0537
Unisteel G244 (MSD)	11R24.5	650-0584	650-0528
Unisteel G244 (MSD)	12R22.5	650-0591	650-0532
Unisteel G259	1000R20	650-0601	650-0539
Unisteel G259	1000R22	650-0591	650-0532
Unisteel G259	1100R20	650-0593	650-0535
Unisteel G259	11R22.5	650-0601	650-0539
Unisteel G259	11R24.5	650-0591	650-0532
Unisteel G259	12R22.5	650-0593	650-0535
Unisteel G259	245/75R22.5	650-0640	650-0549
Unisteel G259	255/70R22.5	650-0627	650-0552
Unisteel G259	265/75R22.5	650-0616	650-0548
Unisteel G259	285/75R24.5	650-0601	650-0539
Unisteel G259	295/75R22.5	650-0608	650-0545
Unisteel G286	1000R20	650-0598	650-0537
Unisteel G286	1000R22	650-0584	650-0528
Unisteel G286	1100R20	650-0593	650-0534
Unisteel G286	1100R22	650-0583	650-0526
Unisteel G286	1100R24	650-0579	None
Unisteel G286	11R22.5	650-0598	650-0537
Unisteel G286	11R24.5	650-0587	650-0528
Unisteel G286	1200R24	650-0576	650-0521
Unisteel G286	12R22.5	650-0593	650-0534
Unisteel G286	12R24.5	650-0583	650-0526
Unisteel G286	1400R20	650-0576	650-0521
Unisteel G286	315/80R22.5	650-0593	650-0535
Unisteel G286SS	385/65R22.5	650-0595	650-0535
Unisteel G286SS	425/65R22.5	650-0584	650-0528
Unisteel G286SS	445/65R22.5	650-0581	650-0525
Unisteel G291	1000R20	650-0601	650-0539
Unisteel G291	11R22.5	650-0601	650-0537
Unisteel G291	215/75R17.5	650-0691	650-0571
Unisteel G291	225/70R19.5	650-0675	None
Unisteel G291	245/70R19.5	650-0673	650-0561
Unisteel G291	265/70R19.5	650-0631	650-0559
Unisteel G291	275/70R22.5	650-0618	650-0665
Unisteel G291	285/70R19.5	650-0629	None
Unisteel G291	295/80R22.5	650-0601	650-0539
Unisteel G291	305/75R24.5	650-0595	650-0535
Unisteel G291	315/80R22.5	650-0595	650-0537
Unisteel G291	8.5R17.5	650-0704	None
Unisteel G291	8R17.5	650-0690	650-0567
Unisteel G291	900R20	650-0610	650-0545
Unisteel G302	11R22.5	650-0598	650-0537
Unisteel G302	295/75R22.5	650-0608	650-0541
Unisteel G314	11R22.5	650-0605	650-0541
Unisteel G314	11R24.5	650-0593	650-0534
Unisteel G314	285/75R24.5	650-0605	650-0541
Unisteel G314	295/75R22.5	650-0613	650-0545
Unisteel G328	11R22.5	650-0598	650-0537
Unisteel G328	11R24.5	650-0584	650-0528
Unisteel G328	285/75R24.5	650-0598	650-0537
Unisteel G328	295/75R22.5	650-0605	650-0541
Unisteel G357	11R22.5	650-0601	650-0539

Goodyear...(cont'd)	Tire Size	Mile	Kilometer
Unisteel G357	11R24.5	650-0591	650-0532
Unisteel G357	285/75R24.5	650-0601	650-0539
Unisteel G357	295/75R22.5	650-0610	650-0545
Unisteel G362	11R22.5	650-0598	650-0537
Unisteel G362	11R24.5	650-0584	650-0528
Unisteel G362	285/75R24.5	650-0598	650-0537
Unisteel G362	295/75R22.5	650-0605	650-0541
Unisteel G386	1000R20	650-0601	650-0539
Unisteel G386	1100R20	650-0595	650-0535
Unisteel G386	11R22.5	650-0601	650-0539
Unisteel G386	1200R20	650-0584	650-0528
Unisteel G386	1200R24	650-0576	650-0521
Unisteel G386	12R22.5	650-0593	650-0535
Unisteel G386	13R22.5	650-0584	650-0528
Unisteel G386	315/80R22.5	650-0595	650-0535
Unisteel G386	315/80R22.5	650-0595	650-0537
Unisteel G391	11R22.5	650-0601	650-0539
Unisteel G391	12R22.5	650-0593	650-0535
Unisteel G391	13R22.5	650-0584	650-0528
Unisteel G391	275/70R22.5	650-0619	650-0668
Unisteel G391	275/80R22.5	650-0613	650-0545
Unisteel G391	295/60R22.5	650-0610	650-0545
Unisteel G391	295/80R22.5	650-0601	650-0539
Unisteel G391	295/80R22.5	650-0605	650-0539
Unisteel G391	305/70R22.5	650-0613	650-0664
Unisteel G391	315/70R22.5	650-0610	650-0545
Unisteel G391	315/80R22.5	650-0595	650-0537
Unisteel G800A	12.5R20	650-0605	650-0541
Unisteel LP	285/75R24.5	650-0601	650-0539
Unisteel LP	295/75R22.5	650-0610	650-0545
Unisteel MVT	395/85R20	650-0579	650-0523
Unisteel TD	1000R20	650-0601	650-0537
Unisteel TD	1000R22	650-0587	650-0528
Unisteel TD	10R22.5	650-0608	650-0542
Unisteel TD	1100R20	650-0593	650-0534
Unisteel TD	11R22.5	650-0601	650-0537
Unisteel TD	11R24.5	650-0587	650-0528
Unisteel TD	12R22.5	650-0593	650-0534
Unisteel TD	825R20	650-0617	650-0548
Unisteel TD	900R20	650-0608	650-0542
Unisteel TD	9R22.5	650-0617	650-0548
Unisteel TDA	11R22.5	650-0598	650-0537
Unisteel TDA	11R24.5	650-0584	650-0528
Workhorse	235/85R16	650-0704	None
Workhorse	750-16	650-0634	650-0563
Workhorse	875-16	650-0687	650-0578
Workhorse	950-16.5	650-0691	650-0571
Workhorse EG	235/85R16	650-0675	None
Workhorse Rib	700-15	650-0692	None
Wrangler	215/75R15	650-0698	None
Wrangler	225/75R16	650-0687	650-0578
Wrangler	235/75R15	650-0687	650-0578
Wrangler Aquatred	235/85R16	650-0704	None
Wrangler Aquatred	245/75R16	650-0677	650-0571
Wrangler Aquatred	265/75R16	650-0704	None
Wrangler AT	245/75R16	650-0690	650-0567
Wrangler AT	255/85R16	650-0673	650-0561
Wrangler AT	265/75R16	650-0690	None

Goodyear...(cont'd)	Tire Size	Mile	Kilometer
Wrangler AT	31x1250R16.5	650-0677	650-0571
Wrangler AT	33x1250R16.5	650-0634	650-0563
Wrangler GSA	235/75R15	650-0687	650-0578
Wrangler GSA	235/85R16	650-0704	None
Wrangler GSA	245/70R15	650-0696	650-0580
Wrangler GSA	245/75R16	650-0677	650-0571
Wrangler GSA	265/75R16	650-0704	None
Wrangler GSA	37x12.50R16.5	650-0626	650-0549
Wrangler HT	235/85R16	650-0704	None
Wrangler HT	245/75R16	650-0677	650-0571
Wrangler LT	800R16.5	650-0694	650-0580
Wrangler LT	875R16.5	650-0695	650-0578
Wrangler LT	8R19.5	650-0633	650-0561
Wrangler LT	950R16.5	650-0677	650-0571
Wrangler Rib	8R19.5	650-0631	650-0559
Wrangler TD	265/75R16	650-0676	None
Hankook			
AH06	245/70R19.5	650-0633	650-0561
AH06	265/70R19.5	650-0630	650-0559
AH06	285/70R19.5	650-0628	None
AH06	8R19.5	650-0633	650-0561
AM01	1000R20	650-0601	650-0539
AM01	1000R22	650-0591	650-0532
AM01	1100R20	650-0593	650-0535
AM01	11R22.5	650-0601	650-0539
AM01	11R24.5	650-0591	650-0532
AM01	1200R20	650-0583	650-0528
AM01	1200R24	650-0576	650-0521
AM01	12R22.5	650-0593	650-0535
AM01	315/80R22.5	650-0595	650-0535
DH01	245/70R19.5	650-0633	650-0561
DM02	1000R20	650-0601	650-0539
DM02	1100R20	650-0593	650-0534
DM02	11R22.5	650-0601	650-0539
DM02	12R22.5	650-0593	650-0534
DW01	11R22.5	650-0595	650-0535
DW01	11R24.5	650-0584	650-0528
F17A	10R22.5	650-0610	650-0545
F17A	900R20	650-0610	650-0545
F19	1000R20	650-0601	650-0539
F19	1000R22	650-0591	650-0532
F19	11R22.5	650-0601	650-0539
F19	11R24.5	650-0591	650-0532
F19	265/75R22.5	650-0617	650-0665
F19	275/80R22.5	650-0610	650-0545
F19	275/80R24.5	650-0601	650-0539
F19	285/75R24.5	650-0601	650-0539
F19	295/75R22.5	650-0610	650-0545
F19	295/80R22.5	650-0601	650-0539
F19	315/80R22.5	650-0595	650-0537
F20	1000R20	650-0601	650-0539
F20	1000R22	650-0591	650-0532
F20	1100R20	650-0595	650-0535
F20	11R22.5	650-0601	650-0539
F20	11R24.5	650-0591	650-0532
F20	12R22.5	650-0595	650-0535
F22	1000R20	650-0601	650-0539

Hankook...(cont'd)	Tire Size	Mile	Kilometer
F22	1000R22	650-0591	650-0532
F22	1100R20	650-0595	650-0535
F22	1100R22	650-0583	650-0528
F22	11R22.5	650-0601	650-0539
F22	11R24.5	650-0591	650-0532
F22	12R22.5	650-0595	650-0535
F22	255/70R22.5	650-0672	650-0549
F22	285/75R24.5	650-0601	650-0539
F22	295/75R22.5	650-0610	650-0545
F22	295/80R22.5	650-0601	650-0539
F22	315/80R22.5	650-0595	650-0535
F23	1000R20	650-0601	650-0539
F23	1000R22	650-0591	650-0532
F23	11R22.5	650-0601	650-0539
F23	11R24.5	650-0591	650-0532
F23	285/75R24.5	650-0601	650-0539
F23	295/75R22.5	650-0610	650-0545
F25	1000R20	650-0601	650-0539
F25	1000R22	650-0591	650-0532
F25	1100R20	650-0595	650-0535
F25	11R22.5	650-0601	650-0539
F25	11R24.5	650-0591	650-0532
F25	285/75R24.5	650-0601	650-0539
F25	295/75R22.5	650-0610	650-0545
F26	1000R20	650-0601	650-0539
F26	1000R22	650-0591	650-0532
F26	1100R20	650-0593	650-0535
F26	11R22.5	650-0601	650-0539
F26	11R24.5	650-0591	650-0532
F26	12R22.5	650-0593	650-0535
F26	275/70R22.5	650-0618	650-0665
F26	285/75R24.5	650-0601	650-0537
F26	295/75R22.5	650-0608	650-0545
F26	295/80R22.5	650-0601	650-0539
F26	315/70R22.5	650-0610	650-0545
F26	315/80R22.5	650-0595	650-0535
F4	825-20	650-0617	650-0665
F40	14/80R20	650-0593	650-0534
F40	15R22.5	650-0595	650-0535
F40	16.5R22.5	650-0584	650-0528
F40	365/80R20	650-0593	650-0534
F40	385/65R22.5	650-0595	650-0535
F40	425/65R22.5	650-0584	650-0528
F5	1000-20	650-0598	650-0537
F5	900-20	650-0601	650-0539
F70	1000R20	650-0605	650-0541
F70	11R22.5	650-0605	650-0541
F70	11R24.5	650-0593	650-0534
F70	285/75R24.5	650-0601	650-0539
F70	295/75R22.5	650-0610	650-0545
F8	1000-20	650-0598	650-0539
F80	1000R20	650-0605	650-0541
F80	1000R22	650-0593	650-0534
F80	11R22.5	650-0605	650-0541
F80	11R24.5	650-0593	650-0534
F80	285/75R24.5	650-0605	650-0539
F80	295/75R22.5	650-0613	650-0545
S51	1000R20	650-0598	650-0537

Hankook...(cont'd)	Tire Size	Mile	Kilometer
S51	1100R20	650-0593	650-0534
S51	11R22.5	650-0598	650-0537
S51	12R22.5	650-0593	650-0534
S51A	1000R22	650-0587	650-0532
S51A	11R24.5	650-0587	650-0532
S52	12R22.5	650-0593	650-0534
T25	1000R20	650-0598	650-0537
T25	1000R22	650-0584	650-0528
T25	1100R20	650-0593	650-0534
T25	11R22.5	650-0598	650-0537
T25	11R24.5	650-0584	650-0528
T25	12R22.5	650-0593	650-0534
T25A	13R22.5	650-0583	650-0528
T5	825-20	650-0616	650-0548
T5	900-20	650-0608	650-0545
T77	1000.20	650-0593	650-0535
T77	900-20	650-0608	650-0545
Z33	11R22.5	650-0601	650-0539
Z33	1200R20	650-0584	650-0528
Z33	1200R24	650-0670	650-0521
Z33	13R22.5	650-0584	650-0528
Z35	1000R20	650-0601	650-0539
Z35	1000R22	650-0591	650-0532
Z35	1100R20	650-0593	650-0535
Z35	11R22.5	650-0601	650-0539
Z35	11R24.5	650-0591	650-0532
Z35	12R22.5	650-0593	650-0535
Z35A	1000R20	650-0601	650-0537
Z35A	1000R22	650-0587	650-0528
Z35A	1100R20	650-0593	650-0534
Z35A	11R22.5	650-0601	650-0537
Z35A	11R24.5	650-0587	650-0528
Z35A	12R22.5	650-0593	650-0534
Z35A	285/75R24.5	650-0598	650-0537
Z35A	295/75R22.5	650-0608	650-0541
Z35A	295/80R22.5	650-0601	650-0537
Z35A	315/80R22.5	650-0593	650-0534
Z37	1000R20	650-0601	650-0539
Z37	1100R20	650-0593	650-0535
Z37	11R22.5	650-0601	650-0539
Z37	11R24.5	650-0591	650-0532
Z37	12R22.5	650-0593	650-0535
Z37	275/80R22.5	650-0608	650-0545
Z37	275/80R24.5	650-0601	650-0537
Z37	285/75R24.5	650-0601	650-0539
Z37	295/75R22.5	650-0608	650-0545
Z37	295/80R22.5	650-0601	650-0539
Z37	315/80R22.5	650-0595	650-0535
Z38	1000R20	650-0601	650-0539
Z38	1000R22	650-0591	650-0532
Z38	1100R20	650-0595	650-0535
Z38	11R22.5	650-0601	650-0539
Z38	11R24.5	650-0591	650-0532
Z38	12R22.5	650-0595	650-0535
Z40	15R22.5	650-0595	650-0537
Z40	385/65R22.5	650-0595	650-0537
Z40	425/65R22.5	650-0584	650-0528
Z43	1200R24	650-0670	650-0521

Hankook...(cont'd)	Tire Size	Mile	Kilometer
Z48	1000R20	650-0601	650-0539
Z48	1000R22	650-0591	650-0532
Z48	11R22.5	650-0601	650-0539
Z48	11R24.5	650-0591	650-0532
Z49	1000R20	650-0598	650-0537
Z49	1000R22	650-0587	650-0528
Z49	11R22.5	650-0598	650-0537
Z49	11R24.5	650-0587	650-0528
Z49	285/75R24.5	650-0598	650-0537
Z49	295/75R22.5	650-0608	650-0541
Z59	1000R20	650-0598	650-0537
Z59	1000R22	650-0587	650-0528
Z59	1100R20	650-0593	650-0534
Z59	1100R22	650-0671	650-0526
Z59	11R22.5	650-0598	650-0537
Z59	11R24.5	650-0587	650-0528
Z59	12R22.5	650-0593	650-0534
Z59	285/75R24.5	650-0598	650-0537
Z59	295/75R22.5	650-0605	650-0541
Z59	295/80R22.5	650-0598	650-0537
Z59	315/80R22.5	650-0593	650-0534
Hercules			
DDT	1000R20	650-0601	650-0537
DDT	1000R22	650-0587	650-0528
DDT	11R22.5	650-0601	650-0537
DDT	11R24.5	650-0587	650-0528
DDT	285/75R24.5	650-0598	650-0537
DDT	295/75R22.5	650-0608	650-0542
DDT	295/85R22.5	650-0601	650-0537
DDT	315/80R22.5	650-0593	650-0534
DML	1000R20	650-0601	650-0539
DML	1000R22	650-0587	650-0532
DML	1100R20	650-0593	650-0534
DML	11R22.5	650-0601	650-0539
DML	11R24.5	650-0587	650-0532
DML	12R22.5	650-0593	650-0534
DTL	1000R20	650-0601	650-0539
DTL	11R22.5	650-0601	650-0539
DTL	11R24.5	650-0587	650-0532
HAR	1000R20	650-0601	650-0539
HAR	11R22.5	650-0601	650-0539
HAR	11R24.5	650-0591	650-0532
HCR	1000R20	650-0601	650-0539
HCR	1100R20	650-0593	650-0534
HCR	1100R22	650-0601	650-0539
HCR	11R22.5	650-0601	650-0539
HCR	11R24.5	650-0591	650-0532
HCR	1200R20	650-0584	650-0528
HDTL	1000-20	650-0595	650-0537
HDTL	750-20	650-0618	650-0666
HDTL	825-20	650-0613	650-0664
HDTL	900-20	650-0601	650-0541
Hercumile	215/75R15	650-0698	None
Hercumile	235/75R15	650-0696	650-0580
Hercumile	235/85R16	650-0692	None
Hercumile 11	1000-20	650-0598	650-0539
Hercumile 11	11-22.5	650-0608	650-0545

Hercules...(cont'd)	Tire Size	Mile	Kilometer
Hercumile 11	11-24.5	650-0584	650-0532
Hercumile 11	750-20	650-0622	None
Hercumile 11	825-20	650-0616	650-0548
Hercumile 11	9-22.5	650-0613	650-0664
Hercumile 11	900-20	650-0605	650-0545
HiWay Rib 8218	1000-20	650-0593	650-0535
HiWay Rib 8218	1000-22	650-0595	650-0537
HiWay Rib 8218	825-20	650-0610	650-0664
HiWay Rib 8218	900-20	650-0601	650-0539
HLP	285/75R24.5	650-0601	650-0539
HLP	295/75R22.5	650-0610	650-0545
HLS	285/75R24.5	650-0605	650-0539
HLS	295/75R22.5	650-0613	650-0664
HMS	1000R20	650-0601	650-0539
HMS	1000R22	650-0587	650-0532
HMS	1100R20	650-0593	650-0534
HMS	11R22.5	650-0601	650-0539
HMS	11R24.5	650-0587	650-0532
HMS	12R22.5	650-0593	650-0534
HMS	900R20	650-0610	650-0545
STL Lug	1000-20	650-0587	650-0532
STL Lug	1000-22	650-0671	650-0526
STL Lug	825-20	650-0605	650-0545
STL Lug	900-20	650-0598	650-0537
Super Drive Lug	1000-20	650-0595	650-0537
Super Drive Lug	1000-22	650-0583	650-0528
Super Drive Lug	11-22.5	650-0593	650-0535
Super Drive Lug	11-24.5	650-0671	650-0526
Super Drive Lug	1100-20	650-0587	650-0532
Super Drive Lug	825-20	650-0613	650-0664
Super Drive Lug	900-20	650-0601	650-0539
Super Express 11	1000-20	650-0598	650-0539
Super Express 11	1000-22	650-0584	650-0532
Super Express 11	11-22.5	650-0598	650-0537
Super Express 11	11-24.5	650-0587	650-0532
Super Express 11	1100-20	650-0593	650-0535
Super Express 11	825-20	650-0616	650-0548
Super Express 11	900-20	650-0605	650-0545
Trailer Service	1000-20	650-0598	650-0539
Trailer Service	1000-22	650-0584	650-0532
Trailer Service	11-22.5	650-0584	650-0532
Trailer Service	11-24.5	650-0584	650-0532
Kelly			
AD7	1000R20	650-0601	650-0537
AD7	1000R22	650-0587	650-0532
AD7	11R22.5	650-0601	650-0537
AD7	11R24.5	650-0587	650-0532
ADP	1000R20	650-0598	650-0537
ADP	1000R22	650-0584	650-0528
ADP	11R22.5	650-0598	650-0537
ADP	11R24.5	650-0584	650-0528
AH7	1000R15	650-0627	650-0552
AH7	1000R20	650-0601	650-0539
AH7	1000R22	650-0591	650-0532
AH7	11R22.5	650-0601	650-0539
AH7	11R24.5	650-0591	650-0532
AH7	825R15	650-0633	650-0561

Kelly...(cont'd)	Tire Size	Mile	Kilometer
AHP	1000R20	650-0601	650-0539
AHP	11R22.5	650-0601	650-0539
AHP	11R24.5	650-0591	650-0532
AHT	11R22.5	650-0601	650-0539
AHT	11R24.5	650-0591	650-0532
AHT	255/70R22.5	650-0627	650-0552
AHT	285/75R24.5	650-0601	650-0539
AHT	295/75R22.5	650-0610	650-0545
Custom Armor Trac	10-22.5	650-0610	650-0664
Custom Armor Trac	1000-20	650-0601	650-0541
Custom Armor Trac	1000-22	650-0593	650-0535
Custom Armor Trac	11-22.5	650-0601	650-0541
Custom Armor Trac	11-24.5	650-0591	650-0532
Custom Armor Trac	1100R20	650-0595	650-0537
Custom Armor Trac	750-20	650-0626	650-0549
Custom Armor Trac	825-20	650-0617	650-0665
Custom Armor Trac	9-22.5	650-0617	650-0665
Custom Armor Trac	900-20	650-0610	650-0664
H/D Explorer Trac	1000-20	650-0598	650-0539
H/D Explorer Trac	825-20	650-0616	650-0548
H/D Explorer Trac	900-20	650-0608	650-0545
HiWay Armor Trac	1000-20	650-0605	650-0541
HiWay Armor Trac	1000-22	650-0591	650-0532
HiWay Armor Trac	11-22.5	650-0605	650-0541
HiWay Armor Trac	11-24.5	650-0591	650-0532
HiWay Armor Trac	825-20	650-0618	650-0666
HiWay Armor Trac	900-20	650-0613	650-0664
HiWay Drive Trac	1000-20	650-0601	650-0539
HiWay Drive Trac	11-22.5	650-0601	650-0539
HiWay Drive Trac	11-24.5	650-0591	650-0532
HiWay Drive Trac	825-20	650-0617	650-0665
HiWay Drive Trac	900-20	650-0610	650-0545
KDA	11R22.5	650-0598	650-0537
KDA	11R24.5	650-0584	650-0528
KDA	285/75R24.5	650-0601	650-0539
KDA	295/75R22.5	650-0610	650-0545
KDM-1	1000R20	650-0598	650-0537
KDM-1	1000R22	650-0584	650-0528
KDM-1	11R22.5	650-0598	650-0537
KDM-1	11R24.5	650-0584	650-0528
KDM-LP	285/75R24.5	650-0598	650-0537
KDM-LP	295/75R22.5	650-0605	650-0541
KDS-11	1000R20	650-0601	650-0537
KDS-11	1000R22	650-0587	650-0532
KDS-11	11R22.5	650-0601	650-0537
KDS-11	11R24.5	650-0587	650-0532
KLH-1	1000R20	650-0601	650-0539
KLH-1	11R22.5	650-0601	650-0539
KLH-1	11R24.5	650-0591	650-0532
KLH-LP	285/75R24.5	650-0601	650-0539
KLH-LP	295/75R22.5	650-0610	650-0545
KLS-11	1000R15	650-0627	650-0552
KLS-11	1000R20	650-0601	650-0539
KLS-11	1000R22	650-0591	650-0532
KLS-11	11R22.5	650-0601	650-0539
KLS-11	11R24.5	650-0591	650-0532
KLS-11	825R15	650-0633	650-0561
KRM	1000R20	650-0601	650-0537

Kelly...(cont'd)	Tire Size	Mile	Kilometer
KRM	1000R22	650-0587	650-0528
KRM	1000R24	650-0579	650-0523
KRM	1100R20	650-0583	650-0526
KRM	11R22.5	650-0601	650-0537
KRM	11R24.5	650-0587	650-0528
KRM	12R22.5	650-0593	650-0534
KSA	1000R20	650-0601	650-0539
KSA	11R22.5	650-0601	650-0539
KSA	11R24.5	650-0593	650-0532
KSA	285/75R24.5	650-0601	650-0539
KSA	295/75R22.5	650-0610	650-0545
KTM	1100R22	650-0591	650-0532
KTM	11R22.5	650-0595	650-0535
KTM	1200R24	650-0576	650-0519
KTS	11R22.5	650-0601	650-0539
KTS	11R24.5	650-0591	650-0532
KTS	255/70R22.5	650-0627	650-0552
KTS	285/75R24.5	650-0601	650-0539
KTS	295/75R22.5	650-0610	650-0545
Registered Drive Trac	1000-20	650-0598	650-0537
Registered Drive Trac	1100-20	650-0593	650-0534
Registered Drive Trac	825-20	650-0616	650-0548
Registered Drive Trac	900-20	650-0616	650-0548
Road Rail Trailer	1000-20	650-0605	650-0541
Road Rail Trailer	11-22.5	650-0605	650-0541
Road Rail Trailer	11-24.5	650-0593	650-0535
Kumho			
832	33x1250x16.5	650-0634	650-0563
833	33x1250x16.5	650-0634	650-0563
853	750R16	650-0704	None
853	825R15TR	650-0633	650-0561
911	1200R20	650-0584	650-0528
911	1200R24	650-0576	650-0521
934	1000R20	650-0595	650-0537
934	1000R22	650-0584	650-0528
934	1100R20	650-0591	650-0532
934	11R22.5	650-0595	650-0537
934	11R24.5	650-0584	650-0528
934	12R22.5	650-0591	650-0532
936	1000R22	650-0584	650-0528
936	11R24.5	650-0584	650-0528
942	1000R20	650-0601	650-0537
942	1000R22	650-0587	650-0532
942	1100R20	650-0593	650-0534
942	11R22.5	650-0601	650-0537
942	11R24.5	650-0587	650-0532
942	12R22.5	650-0593	650-0534
943	1000R20	650-0601	650-0539
943	1000R22	650-0591	650-0532
943	1100R20	650-0593	650-0534
943	11R22.5	650-0601	650-0539
943	11R24.5	650-0591	650-0532
943	12R22.5	650-0593	650-0534
943	285/75R24.5	650-0601	650-0539
943	315/80R22.5	650-0593	650-0535
945	1000R20	650-0601	650-0537
945	1000R22	650-0587	650-0532

Kumho...(cont'd)	Tire Size	Mile	Kilometer
945	1100R20	650-0593	650-0534
945	11R22.5	650-0601	650-0537
945	11R24.5	650-0587	650-0532
945	12R22.5	650-0593	650-0534
945	285/75R24.5	650-0598	650-0537
945	295/75R22.5	650-0608	650-0542
945	315/80R22.5	650-0593	650-0534
948	11R22.5	650-0601	650-0537
948	11R24.5	650-0587	650-0532
948	285/75R24.5	650-0601	650-0537
948	295/75R22.5	650-0608	650-0541
955	1000R20	650-0601	650-0539
955	1000R22	650-0591	650-0532
955	1100R20	650-0593	650-0534
955	1100R22	650-0583	650-0526
955	11R22.5	650-0601	650-0539
955	11R24.5	650-0591	650-0532
955	12R22.5	650-0593	650-0534
955	900R20	650-0610	650-0545
956	1000R20	650-0601	650-0539
956	1000R22	650-0591	650-0532
956	10R22.5	650-0610	650-0545
956	1100R20	650-0593	650-0534
956	11R22.5	650-0601	650-0539
956	11R24.5	650-0591	650-0532
956	1200R20	650-0584	650-0528
956	1200R24	650-0670	None
956	12R22.5	650-0593	650-0534
956	900R20	650-0610	650-0545
958	365/80R20	650-0591	650-0532
958	385/65R22.5	650-0598	650-0537
958	425/65R22.5	650-0584	650-0528
958	445/65R22.5	650-0671	650-0525
961	255/70R2.5	650-0672	650-0549
961	285/75R24.5	650-0601	650-0539
961	295/75R22.5	650-0610	650-0545
961	295/80R22.5	650-0601	650-0539
961	315/80R22.5	650-0595	650-0535
962	1000R20	650-0601	650-0539
962	1000R22	650-0591	650-0532
962	1100R20	650-0593	650-0534
962	11R22.5	650-0601	650-0539
962	11R24.5	650-0591	650-0532
962	12R22.5	650-0593	650-0534
962	285/75R24.5	650-0601	650-0539
962	295/75R22.5	650-0610	650-0545
970	1000R20	650-0601	650-0539
970	1000R22	650-0591	650-0532
970	10R22.5	650-0610	650-0545
970	1100R20	650-0593	650-0535
970	1100R22	650-0583	650-0526
970	11R22.5	650-0601	650-0539
970	11R24.5	650-0591	650-0532
970	1200R20	650-0584	650-0528
970	12R22.5	650-0593	650-0535
970	13R22.5	650-0584	650-0528
970	900R20	650-0610	650-0545
980	1000R20	650-0601	650-0539

Kumho...(cont'd)	Tire Size	Mile	Kilometer
980	1000R22	650-0591	650-0532
980	1100R20	650-0601	650-0539
980	11R22.5	650-0601	650-0539
980	11R24.5	650-0591	650-0532
981	285/75R24.5	650-0601	650-0539
981	295/75R22.5	650-0704	None
982	1000R20	650-0605	650-0539
982	1000R22	650-0593	650-0534
982	11R22.5	650-0605	650-0539
982	11R24.5	650-0593	650-0534
982	285/75R24.5	650-0605	650-0539
982	295/75R22.5	650-0610	650-0545
Lee/Star			
Drive Radial 1	1000R20	650-0601	650-0537
Drive Radial 1	1000R22	650-0587	650-0532
Drive Radial 1	11R22.5	650-0601	650-0537
Drive Radial 1	11R24.5	650-0587	650-0532
HiWay Radial 1	1000R20	650-0601	650-0539
HiWay Radial 1	1000R22	650-0591	650-0532
HiWay Radial 1	11R22.5	650-0601	650-0539
HiWay Radial 1	11R24.5	650-0591	650-0532
Milemark Lug 11	1000-20	650-0601	650-0539
Milemark Lug 11	11-22.5	650-0601	650-0539
Milemark Lug 11	11-24.5	650-0591	650-0532
Milemark Lug 11	825-20	650-0617	650-0665
Milemark Lug 11	900-20	650-0610	650-0545
Milemark MST	1000-20	650-0595	650-0537
Milemark MST	825-20	650-0616	650-0548
Milemark MST	900-20	650-0605	650-0541
Milemark PBT	1000-20	650-0605	650-0541
Milemark PBT	11-22.5	650-0605	650-0541
Milemark PBT	11-24.5	650-0593	650-0535
Milemark PHL	1000-20	650-0598	650-0539
Milemark PHL	1000-22	650-0584	650-0528
Milemark PHL	1100-20	650-0593	650-0534
Milemark PHL	825-20	650-0616	650-0548
Milemark PHL	900-20	650-0605	650-0545
Milemark PHR	10-22.5	650-0610	650-0664
Milemark PHR	1000-20	650-0601	650-0539
Milemark PHR	1000-22	650-0591	650-0532
Milemark PHR	11-22.5	650-0601	650-0539
Milemark PHR	11-24.5	650-0591	650-0532
Milemark PHR	1100-20	650-0595	650-0537
Milemark PHR	750-20	650-0626	650-0549
Milemark PHR	825-20	650-0617	650-0665
Milemark PHR	9-22.5	650-0617	650-0665
Milemark PHR	900-20	650-0610	650-0664
Milemark Rib 11	1000-20	650-0605	650-0541
Milemark Rib 11	1000-22	650-0591	650-0532
Milemark Rib 11	11-22.5	650-0605	650-0541
Milemark Rib 11	11-24.5	650-0591	650-0532
Milemark Rib 11	825-20	650-0618	650-0666
Milemark Rib 11	900-20	650-0613	650-0664
McCreary			
Silent Service	1000-20	650-0593	650-0532
Silent Service	1000-22	650-0583	650-0526

McCreary...(cont'd)	Tire Size	Mile	Kilometer
Silent Service	11-22.5	650-0593	650-0532
Silent Service	11-24.5	650-0583	650-0526
Super Miles	10-22.5	650-0601	650-0537
Super Miles	1000-20	650-0598	650-0537
Super Miles	1000-22	650-0587	650-0532
Super Miles	11-22.5	650-0598	650-0537
Super Miles	11-24.5	650-0587	650-0532
Super Miles	1100-20	650-0593	650-0532
Super Miles	12-22.5	650-0593	650-0532
Super Miles	825-20	650-0616	650-0548
Super Miles	9-22.5	650-0616	650-0548
Super Miles	900-20	650-0601	650-0537
Super Transport	1000-20	650-0598	650-0537
Super Transport	1000-22	650-0587	650-0532
Super Transport	11-22.5	650-0598	650-0537
Super Transport	11-24.5	650-0587	650-0532
Super Transport	1100-20	650-0593	650-0532
Super Transport	1100-22	650-0583	650-0526
Super Transport	12-22.5	650-0593	650-0532
Super Transport	12-24.5	650-0583	650-0526
Super Transport	1200-20	650-0584	650-0526
Super Transport	13-22.5	650-0584	650-0526
Super Transport	825-20	650-0616	650-0548
Super Transport	9-22.5	650-0616	650-0548
Super Transport	900-20	650-0608	650-0545
Super Traxion	10-22.5	650-0601	650-0537
Super Traxion	825-20	650-0610	650-0545
Super Traxion	9-22.5	650-0610	650-0545
Super Traxion	900-20	650-0601	650-0537
Superlug Express	10-22.5	650-0601	650-0537
Superlug Express	1000-20	650-0598	650-0537
Superlug Express	1000-22	650-0587	650-0532
Superlug Express	11-22.5	650-0593	650-0532
Superlug Express	11-24.5	650-0583	650-0526
Superlug Express	1100-20	650-0593	650-0532
Superlug Express	1100-22	650-0581	650-0525
Superlug Express	12-22.5	650-0593	650-0532
Superlug Express	12-24.5	650-0581	650-0525
Superlug Express	825-20	650-0610	650-0545
Superlug Express	9-22.5	650-0610	650-0545
Superlug Express	900-20	650-0601	650-0537
Michelin			
LTX	235/75R16	650-0695	None
LTX	235/85R16	650-0675	None
LTX	245/75R16	650-0690	650-0567
LTX	LT235/75R16	650-0695	None
LTX	LT235/85R16	650-0675	None
LTX	LT245/75R16	650-0690	650-0567
LTX (A/S)	LT215/85R16	650-0691	650-0571
LTX (A/S)	LT225/75R16	650-0701	None
LTX (A/T)	LT215/85R16	650-0677	650-0571
LTX (M/S)	LT215/75R15	650-0698	None
LTX (M/S)	LT215/85R16	650-0677	650-0571
PMD1	275/80R22.5	650-0605	650-0541
PMD1	275/80R24.5	650-0601	650-0537
PXA	1000/90R20	650-0610	650-0545
PXCH4	215/75R17.5	650-0698	None

Michelin...(cont'd)	Tire Size	Mile	Kilometer
PXCH4	225/75R16	650-0695	650-0578
PXCH4	235/85R16	650-0675	None
PXCH4	245/75R16	650-0677	650-0571
PXD1	275/80R22.5	650-0605	650-0541
PXD1	275/80R24.5	650-0598	650-0537
PXDA	1000/90R20	650-0608	650-0545
PXDA	225/70R19.5	650-0704	None
PXDA	305/75R24.5	650-0593	650-0534
PXDA +	225/70R19.5	650-0704	None
PXDA +	275/80R24.5	650-0601	650-0539
PXDA +	255/70R22.5	650-0626	650-0549
PXDA +	275/80R22.5	650-0608	650-0541
PXDU	235/80R22.5	650-0622	650-0666
PXDU	255/80R22.5	650-0617	650-0665
PXDY	315/80R22.5	650-0593	650-0534
PXM+S4	275/80R22.5	650-0608	650-0545
PXM+S4	275/80R24.5	650-0601	650-0539
PXT1	275/80R22.5	650-0613	650-0664
PXT1	275/80R24.5	650-0605	650-0541
PXTA	275/80R22.5	650-0613	650-0545
PXTA	275/80R24.5	650-0605	650-0541
PXTA	285/70R19.5	650-0629	650-0554
PXZ	225/75R16	650-0695	650-0578
PXZA	225/70R19.5	650-0634	650-0563
PXZA	245/70R19.5	650-0633	650-0561
PXZA	255/70R22.5	650-0672	650-0549
PXZA	265/70R19.5	650-0631	650-0559
PXZA	275/70R22.5	650-0618	650-0665
PXZA	275/80R22.5	650-0610	650-0545
PXZA	285/70R19.5	650-0629	650-0554
PXZA	295/80R22.5	650-0601	650-0539
PXZA	305/75R24.5	650-0595	650-0535
PXZA	365/80R20	650-0591	650-0532
PXZA(1)	315/80R22.5	650-0595	650-0535
PXZA-1+	275/80R22.5	650-0610	650-0545
PXZA-1+	275/80R24.5	650-0601	650-0539
PXZT	225/70R19.5	650-0634	650-0563
PXZT	245/70R19.5	650-0633	650-0561
PXZT	265/70R19.5	650-0630	650-0559
PXZT	285/70R19.5	650-0628	None
PXZU	305/70R22.5	650-0613	650-0664
PXZU-4	225/70R19.5	650-0634	650-0563
PXZU-4	235/80R22.5	650-0622	650-0666
PXZU-4	245/70R19.5	650-0633	650-0561
PXZU-4	255/80R22.5	650-0617	650-0548
PXZU-4	275/80R22.5	650-0610	650-0545
PXZY	315/80R22.5	650-0595	650-0535
PXZY	385/65R22.5	650-0598	650-0537
X 4x4	750R16	650-0704	None
XC-4	LT235/85R16	650-0675	None
XCA	700R15	650-0695	650-0578
XCA	750R17	650-0633	650-0561
XCA	800R16.5	650-0698	None
XCA	8R17.5	650-0688	650-0567
XD-1	275/80R22.5	650-0605	650-0541
XD-1	275/80R24.5	650-0598	650-0537
XD-1	11R22.5	650-0598	650-0537
XD-1	11R24.5	650-0587	650-0528

Michelin...(cont'd)	Tire Size	Mile	Kilometer
XD-1	275/80R22.5	650-0605	650-0541
XD-1	275/80R24.5	650-0598	650-0537
XDA	1000R20	650-0601	650-0539
XDA	1100R22	650-0583	650-0526
XDA	275/80R22.5	650-0608	650-0545
XDA+	11R22.5	650-0601	650-0537
XDA+	11R24.5	650-0587	650-0532
XDA-2	11R22.5	650-0598	650-0537
XDA-2	11R24.5	650-0587	650-0528
XDA-2	275/80R22.5	650-0605	650-0541
XDA-2	275/80R24.5	650-0598	650-0537
XDE	11R22.5	650-0598	650-0537
XDE	11R24.5	650-0584	650-0528
XDE	12R22.5	650-0595	650-0535
XDHT	11R22.5	650-0598	650-0537
XDHT	11R24.5	650-0587	650-0528
XDHT	275/80R22.5	650-0605	650-0541
XDHT	275/80R24.5	650-0598	650-0537
XDL	1000R20	650-0595	650-0535
XDL	11R22.5	650-0595	650-0535
XDL	11R24.5	650-0583	650-0528
XDL	1200R24	650-0570	650-0519
XDN	11R22.5	650-0601	650-0537
XDN	11R24.5	650-0587	650-0528
XDN	12R22.5	650-0593	650-0534
XDY	1000R20	650-0598	650-0537
XDY	1100R22	650-0671	650-0525
XDY(1)	11R22.5	650-0598	650-0537
XDY(1)	11R24.5	650-0584	650-0528
XGC	1400R24	650-0562	650-0514
XHC	17.5R25	650-0562	650-0514
XL	1100R20	650-0593	650-0532
XL	1200R20	650-0593	650-0532
XL	14.5R20	650-0593	None
XM+S4	1000R20	650-0601	650-0539
XM+S4	1000R22	650-0591	650-0532
XM+S4	10R22.5	650-0610	650-0545
XM+S4	1100R20	650-0593	650-0534
XM+S4	1100R22	650-0583	650-0526
XM+S4	11R22.5	650-0601	650-0537
XM+S4	11R24.5	650-0587	650-0532
XM+S4	1200R20	650-0584	650-0528
XM+S4	12R22.5	650-0593	650-0534
XM+S4	275/80R22.5	650-0608	650-0545
XM+S4	8R19.5	650-0633	650-0561
XM+S4	900R20	650-0610	650-0545
XM+S4	9R22.5	650-0618	650-0665
XMD2	1800R25	None	650-0659
XMS	8R19.5	650-0631	650-0559
XPS	215/85R16	650-0690	650-0567
XPS	235/85R16	650-0675	None
XPS	750R16	650-0675	None
XPS	875R16.5	650-0687	650-0578
XPS	950R16.5	650-0677	650-0571
XPS	LT215/85R16	650-0690	650-0567
XPS	LT235/85R16	650-0675	650-0680
XS	1400R20	650-0570	650-0519
XS	1600R20	650-0562	650-0514

Michelin...(cont'd)	Tire Size	Mile	Kilometer
XT-1	11R22.5	650-0605	650-0541
XT-1	11R24.5	650-0593	650-0534
XT-1	275/80R22.5	650-0613	650-0664
XT-1	275/80R24.5	650-0605	650-0541
XTA	10R17.5	650-0631	650-0559
XTA	11R22.5	650-0605	650-0541
XTA	11R24.5	650-0593	650-0534
XTA	215/75R17.5	650-0690	650-0567
XTA	245/70R17.5	650-0676	None
XTA	265/70R19.5	650-0631	650-0559
XTA	9R17.5	650-0673	650-0561
XVC	1400R24	650-0560	650-0662
XY-1	18R22.5	650-0583	650-0526
XZ2	12R22.5	650-0595	650-0535
XZA	1000R20	650-0601	650-0539
XZA	1000R22	650-0591	650-0532
XZA	10R22.5	650-0610	650-0545
XZA	1100R20	650-0595	650-0535
XZA	1100R22	650-0583	650-0526
XZA	11R22.5	650-0601	650-0539
XZA	1200R20	650-0584	650-0528
XZA	12R22.5	650-0595	650-0535
XZA	1400R20	650-0576	650-0519
XZA	215/75R17.5	650-0690	650-0567
XZA	255/70R22.5	650-0672	650-0549
XZA	275/80R22.5	650-0610	650-0545
XZA	295/80R22.5	650-0601	650-0539
XZA	315/80R22.5	650-0595	650-0535
XZA	365/80R20	650-0591	650-0532
XZA	750R16	650-0704	None
XZA	8.5R17.5	650-0704	None
XZA	8R19.5	650-0633	650-0561
XZA	900R20	650-0613	650-0545
XZA	9R22.5	650-0618	650-0665
XZA(1)	11R24.5	650-0591	650-0532
XZA-1+	11R22.5	650-0601	650-0539
XZA-1+	11R24.5	650-0591	650-0532
XZA-1+	275/80R24.5	650-0601	650-0539
XZA-2	11R22.5	650-0601	650-0539
XZA-2	11R24.5	650-0591	650-0532
XZA-2	275/80R22.5	650-0610	650-0545
XZA-2	275/80R24.5	650-0601	650-0539
XZA-4	1400R20	650-0576	650-0519
XZA1	275/80R22.5	650-0610	650-0545
XZA1(+)	11R22.5	650-0601	650-0539
XZA1(+)	275/80R24.5	650-0601	650-0539
XZA1+	11R24.5	650-0591	650-0532
XZA2	11R22.5	650-0601	650-0539
XZA2	11R24.5	650-0591	650-0532
XZA2	275/80R22.5	650-0610	650-0545
XZA2	275/80R24.5	650-0601	650-0539
XZA4	G20	650-0576	650-0519
XZE	10 22.5	650-0610	None
XZE	10R22.5	650-0610	650-0545
XZE	11R22.5	650-0605	650-0539
XZE	11R24.5	650-0591	650-0532
XZE	12R22.5	650-0595	650-0537
XZE	245/70R19.5	650-0633	650-0561

Michelin...(cont'd)	Tire Size	Mile	Kilometer
XZE	275/80R22.5	650-0613	650-0664
XZE	275/80R24.5	650-0605	650-0541
XZE	9R22.5	650-0618	650-0665
XZH	445/65R22.5	650-0581	650-0525
XZT	215/75R17.5	650-0690	650-0567
XZT	8.5R17.5	650-0704	None
XZU	13/75R22.5	650-0601	650-0539
XZU-2	275/70R22.5	650-0618	650-0665
XZU-4	235/80R22.5	650-0622	650-0666
XZU-4	255/80R22.5	650-0617	650-0548
XZU-4	275/80R22.5	650-0610	650-0545
XZU2	11R22.5	650-0601	650-0537
XZU2	12R22.5	650-0593	650-0534
XZU2	275/70R22.5	650-0618	650-0665
XZU2	305/70R22.5	650-0613	650-0664
XZU4	10R22.5	650-0610	650-0545
XZU4	11R22.5	650-0601	650-0539
XZU4	255/80R22.5	650-0617	650-0548
XZU4	275/80R22.5	650-0610	650-0545
XZU4	9R22.5	650-0617	650-0665
XZY	1000R20	650-0601	650-0539
XZY	1000R22	650-0591	650-0532
XZY	10R22.5	650-0610	650-0545
XZY	1100R20	650-0593	650-0535
XZY	1100R22	650-0583	650-0526
XZY	1100R24	650-0579	650-0523
XZY	11R22.5	650-0601	650-0539
XZY	11R24.5	650-0591	650-0532
XZY	1200R20	650-0583	650-0528
XZY	1200R24	650-0576	650-0521
XZY	13R22.5	650-0584	650-0528
XZY	315/80R22.5	650-0595	650-0535
XZY	385/65R22.5	650-0595	650-0537
XZY	425/65R22.5	650-0583	650-0528
XZY	445/65R19.5	650-0595	650-0535
XZY	445/65R22.5	650-0581	650-0525
XZY	750R16	650-0704	None
XZY	825R20	650-0618	650-0665
XZY	8R19.5	650-0631	650-0559
XZY	900R20	650-0610	650-0545
XZY-1	11R22.5	650-0601	650-0539
XZY-1	11R24.5	650-0587	650-0532
XZY-1	12R22.5	650-0595	650-0535
XZY-1	12R24.5	650-0583	650-0526
XZY1	315/80R22.5	650-0595	650-0535
XZYXX	445/65R22.5	650-0581	650-0525
XZZ	1000R15	None	650-0552
XZZ	1300R20	650-0579	650-0523
XZZ	750R15	650-0691	650-0571
XZZ	825R15	650-0673	650-0561
Ohtsu			
B1-807D	1000R20	650-0598	650-0537
B1-807D	1000R22	650-0587	650-0528
B1-807D	11R22.5	650-0598	650-0537
B1-807D	11R24.5	650-0587	650-0528
B1-807D	285/75R24.5	650-0598	650-0537
B1-807D	295/75R22.5	650-0605	650-0541

Ohtsu...(cont'd)	Tire Size	Mile	Kilometer
C1-627	1000R22	650-0583	650-0528
C1-627	11R24.5	650-0583	650-0528
G1-337	1000R20	650-0601	650-0539
G1-337	1000R22	650-0587	650-0528
G1-337	11R22.5	650-0601	650-0539
G1-337	11R24.5	650-0587	650-0528
L2000	1000R20	650-0601	650-0539
L2000	1000R22	650-0591	650-0532
L2000	1100R20	650-0593	650-0534
L2000	11R22.5	650-0601	650-0539
L2000	11R24.5	650-0587	650-0528
M5500	1000R20	650-0601	650-0539
M5500	1000R22	650-0587	650-0532
M5500	11R22.5	650-0601	650-0539
M5500	11R24.5	650-0587	650-0532
M5500	900R20	650-0610	650-0545
R1-117	255/70R22.5	650-0627	650-0552
R1-117	285/75R24.5	650-0601	650-0539
R1-117	295/75R22.5	650-0610	650-0545
R1-117	315/80R22.5	650-0595	650-0535
R1-117II	1000R20	650-0601	650-0539
R1-117II	11R22.5	650-0601	650-0539
R1-117II	11R24.5	650-0591	650-0532
R1-127	11R22.5	650-0601	650-0539
R1-127	11R24.5	650-0591	650-0532
R1-127	285/75R24.5	650-0601	650-0539
R1-127	295/75R22.5	650-0610	650-0545
R100	1000-20	650-0601	650-0539
R100	1000-22	650-0584	650-0532
R100	11-22.5	650-0598	650-0539
R100	11-24.5	650-0584	650-0528
R100	1100-20	650-0593	650-0535
R1000	1000R20	650-0601	650-0539
R1000	1000R22	650-0593	650-0532
R1000	11R22.5	650-0601	650-0539
R1000	11R24.5	650-0593	650-0532
R1200	1000R20	650-0601	650-0539
R1200	1000R22	650-0591	650-0532
R1200	1100R20	650-0595	650-0535
R1200	11R22.5	650-0601	650-0539
R1200	11R24.5	650-0591	650-0532
R1200	12R22.5	650-0587	650-0532
R1200	900R20	650-0610	650-0545
R150	1000-20	650-0598	650-0537
R150	1000-22	650-0584	650-0528
R150	11-22.5	650-0598	650-0537
R150	11-24.5	650-0584	650-0528
R150	1100-20	650-0593	650-0534
R150	1200-20	650-0671	650-0526
R150	900-20	650-0605	650-0545
R1800	285/75R24.5	650-0601	650-0539
R1800	295/75R22.5	650-0610	650-0545
R310	1000-20	650-0595	650-0537
R310	1000-22	650-0583	650-0528
R310	11-22.5	650-0595	650-0537
R310	11-24.5	650-0584	650-0528
R310	1100-20	650-0593	650-0534
R310	1200-20	650-0671	650-0526

Ohtsu...(cont'd)	Tire Size	Mile	Kilometer
R310	1200-24	650-0576	650-0521
R310	900-20	650-0605	650-0545
R3500	1000R20	650-0601	650-0539
R3500	1000R22	650-0587	650-0532
R3500	10R22.5	650-0610	650-0545
R3500	11R22.5	650-0601	650-0539
R3500	11R24.5	650-0587	650-0532
R3500	900R20	650-0610	650-0545
R62	825-20	650-0616	650-0548
RX117	295/75R22.5	650-0610	650-0545
Pro-Par			
C.E.T. Nylon	10-22.5	650-0601	650-0537
C.E.T. Nylon	1000-20	650-0593	650-0532
C.E.T. Nylon	1000-22	650-0583	650-0526
C.E.T. Nylon	11-22.5	650-0593	650-0532
C.E.T. Nylon	11-24.5	650-0583	650-0526
C.E.T. Nylon	900-20	650-0601	650-0537
Custom EDL	10-22.5	650-0595	650-0535
Custom EDL	1000-20	650-0593	650-0532
Custom EDL	1000-22	650-0583	650-0526
Custom EDL	11-22.5	650-0593	650-0532
Custom EDL	11-24.5	650-0583	650-0526
Custom EDL	900-20	650-0595	650-0535
Pro Steel 11 Rib	1000R15	650-0627	650-0549
Pro Steel 11 Rib	1000R20	650-0598	650-0537
Pro Steel 11 Rib	1000R22	650-0587	650-0532
Pro Steel 11 Rib	10R22.5	650-0608	650-0545
Pro Steel 11 Rib	1100R20	650-0593	650-0532
Pro Steel 11 Rib	11R17.5	650-0627	650-0549
Pro Steel 11 Rib	11R22.5	650-0598	650-0537
Pro Steel 11 Rib	11R24.5	650-0587	650-0532
Pro Steel 11 Rib	12R22.5	650-0593	650-0532
Pro Steel 11 Rib	825R15	650-0633	650-0559
Pro Steel 11 Rib	900R20	650-0608	650-0545
Pro Steel 11 Traction	1000R20	650-0598	650-0537
Pro Steel 11 Traction	1000R22	650-0583	650-0526
Pro Steel 11 Traction	10R22.5	650-0608	650-0545
Pro Steel 11 Traction	11R22.5	650-0598	650-0537
Pro Steel 11 Traction	11R24.5	650-0583	650-0526
Pro Steel 11 Traction	900R20	650-0608	650-0545
Remington			
R145	255/70R22.5	650-0672	650-0549
R315	285/75R24.5	650-0601	650-0539
R315	295/75R22.5	650-0610	650-0545
R345	285/75R24.5	650-0601	650-0537
R425	11R22.5	650-0598	650-0537
R425	11R24.5	650-0587	650-0532
R425	285/75R24.5	650-0601	650-0537
R425	295/75R22.5	650-0605	650-0541
R515	295/75R22.5	650-0613	650-0545
R775	1000R20	650-0598	650-0537
R775	1000R22	650-0587	650-0532
R775	11R22.5	650-0598	650-0537
R775	11R24.5	650-0587	650-0532

Sears	Tire Size	Mile	Kilometer
680 Steel Radial	1000R20	650-0598	650-0537
680 Steel Radial	1000R22	650-0587	650-0532
680 Steel Radial	11R22.5	650-0598	650-0537
680 Steel Radial	11R24.5	650-0587	650-0532
Express Cargo	1000-22	650-0581	650-0526
Express Cargo	11-24.5	650-0581	650-0526
Express TRS	1000-20	650-0593	650-0532
Express TRS	11-22.5	650-0593	650-0532
Extra Traction	10-22.5	650-0601	650-0537
Extra Traction	1000-20	650-0593	650-0532
Extra Traction	11-22.5	650-0593	650-0532
Extra Traction	825-20	650-0610	650-0545
Extra Traction	9-22.5	650-0610	650-0545
Extra Traction	900-20	650-0601	650-0537
M90A Radial	1000R20	650-0598	650-0537
M90A Radial	1000R22	650-0587	650-0532
M90A Radial	10R22.5	650-0608	650-0545
M90A Radial	11R22.5	650-0598	650-0537
M90A Radial	11R24.5	650-0587	650-0532
M90A Radial	900R20	650-0608	650-0545
Plus Mileage Lug	10-22.5	650-0601	650-0537
Plus Mileage Lug	1000-20	650-0593	650-0532
Plus Mileage Lug	1000-22	650-0583	650-0526
Plus Mileage Lug	11-22.5	650-0593	650-0532
Plus Mileage Lug	11-24.5	650-0583	650-0526
Plus Mileage Lug	1100-20	650-0584	650-0526
Plus Mileage Lug	1100-22	650-0579	650-0523
Plus Mileage Lug	12-22.5	650-0584	650-0526
Plus Mileage Lug	12-24.5	650-0579	650-0523
Plus Mileage Lug	825-20	650-0616	650-0548
Plus Mileage Lug	9-22.5	650-0616	650-0548
Plus Mileage Lug	900-20	650-0601	650-0537
Plus Mileage Rib	10-22.5	650-0608	650-0545
Plus Mileage Rib	1000-20	650-0598	650-0537
Plus Mileage Rib	1000-22	650-0587	650-0532
Plus Mileage Rib	11-22.5	650-0598	650-0537
Plus Mileage Rib	11-24.5	650-0583	650-0526
Plus Mileage Rib	1100-20	650-0584	650-0526
Plus Mileage Rib	1100-22	650-0583	650-0526
Plus Mileage Rib	12-22.5	650-0593	650-0532
Plus Mileage Rib	12-24.5	650-0583	650-0526
Plus Mileage Rib	1200-20	650-0584	650-0526
Plus Mileage Rib	13-22.5	650-0584	650-0526
Plus Mileage Rib	825-20	650-0616	650-0548
Plus Mileage Rib	9-22.5	650-0616	650-0548
Plus Mileage Rib	900-20	650-0608	650-0545
Radial LDT	1000R15	650-0627	650-0549
Radial LDT	11R17.5	650-0627	650-0549
Road Handler Century LP	285/75R24.5	650-0601	650-0537
Road Handler Century LP	295/75R22.5	650-0610	650-0545
Roadhandler Lug	1000R20	650-0598	650-0537
Roadhandler Lug	1000R22	650-0587	650-0532
Roadhandler Lug	11R22.5	650-0598	650-0537
Roadhandler Lug	11R24.5	650-0587	650-0532
Roadhandler Rib	1000R20	650-0598	650-0537
Roadhandler Rib	1000R22	650-0587	650-0532
Roadhandler Rib	11R22.5	650-0598	650-0537
Roadhandler Rib	11R24.5	650-0587	650-0532

Sears...(cont'd)	Tire Size	Mile	Kilometer
Silent Trac	10-22.5	650-0601	650-0537
Silent Trac	1000-20	650-0593	650-0532
Silent Trac	1000-22	650-0583	650-0526
Silent Trac	11-22.5	650-0593	650-0532
Silent Trac	11-24.5	650-0583	650-0526
Silent Trac	825-20	650-0616	650-0548
Silent Trac	9-22.5	650-0616	650-0548
Silent Trac	900-20	650-0601	650-0537
Sumitomo			
SL717	750R16	650-0704	None
ST200	11-22.5	650-0598	650-0537
ST200	11-24.5	650-0584	650-0532
ST201	1000-20	650-0598	650-0537
ST201	1000-22	650-0583	650-0528
ST202	1000-20	650-0598	650-0537
ST202	1000-22	650-0583	650-0528
ST202	1100-22	650-0579	650-0525
ST502	1000-20	650-0598	650-0537
ST502	1000-22	650-0583	650-0528
ST506	1200R24	650-0670	650-0521
ST508	1000R20	650-0601	650-0539
ST508	1000R22	650-0591	650-0532
ST508	10R22.5	650-0610	650-0545
ST508	1100R20	650-0595	650-0535
ST508	1100R22	650-0583	650-0526
ST508	11R22.5	650-0601	650-0539
ST508	11R24.5	650-0591	650-0532
ST508	1200R20	650-0584	650-0528
ST508	12R22.5	650-0593	650-0535
ST508	825R20	650-0618	650-0665
ST508	900R20	650-0610	650-0545
ST510	425/65R22.5	650-0583	650-0528
ST518	1000R20	650-0601	650-0539
ST518	1100R20	650-0593	650-0534
ST518	11R22.5	650-0601	650-0539
ST518	11R24.5	650-0591	650-0532
ST518	12R22.5	650-0593	650-0534
ST518	315/80R22.5	650-0595	650-0535
ST616	1000R20	650-0601	650-0537
ST616	1100R20	650-0593	650-0534
ST616	11R22.5	650-0601	650-0537
ST616	11R24.5	650-0587	650-0528
ST616	12R22.5	650-0593	650-0534
ST700	11R22.5	650-0605	650-0541
ST700	11R24.5	650-0593	650-0534
ST700	285/75R24.5	650-0605	650-0539
ST700	295/75R22.5	650-0613	650-0545
ST701	1000-20	650-0598	650-0539
ST701	1000-22	650-0598	650-0539
ST701	11-22.5	650-0598	650-0537
ST701	11-24.5	650-0583	650-0528
ST701	1100-22	650-0583	650-0528
ST701	825-20	650-0616	650-0548
ST701	900-20	650-0605	650-0545
ST704	1000-22	650-0583	650-0528
ST710	425/65R22.5	650-0584	650-0528
ST717	1000R15	650-0627	650-0552

Sumitomo...(cont'd)	Tire Size	Mile	Kilometer
ST717	11R17.5	650-0627	650-0552
ST717	13/80R20	650-0601	650-0539
ST717	14/80R20	650-0593	650-0534
ST717	9R17.5	650-0633	650-0561
ST718	245/70R19.5	650-0633	650-0561
ST718	245/75R22.5	650-0640	650-0549
ST718	265/75R22.5	650-0617	650-0665
ST718	285/75R24.5	650-0601	650-0539
ST718	295/75R22.5	650-0610	650-0545
ST718	315/80R22.5	650-0595	650-0535
ST718	8R19.5	650-0631	None
ST720	385/65R22.5	650-0595	650-0537
ST720	425/65R22.5	650-0584	650-0528
ST720	445/65R22.5	650-0671	650-0525
ST727	1000R15	650-0627	650-0552
ST727	1000R20	650-0601	650-0539
ST727	1000R22	650-0593	650-0532
ST727	10R22.5	650-0610	650-0545
ST727	1100R20	650-0595	650-0535
ST727	11R22.5	650-0601	650-0539
ST727	11R24.5	650-0591	650-0532
ST727	1200R20	650-0584	650-0528
ST727	12R22.5	650-0595	650-0535
ST727	255/70R22.5	650-0627	650-0552
ST727	750R15	650-0692	None
ST727	825R15	650-0673	650-0561
ST727	825R20	650-0618	650-0665
ST727	900R20	650-0610	650-0545
ST738	1000R20	650-0601	650-0539
ST738	1100R20	650-0595	650-0535
ST738	11R22.5	650-0601	650-0539
ST738	11R24.5	650-0591	650-0532
ST738	12R22.5	650-0595	650-0535
ST748	11R22.5	650-0601	650-0539
ST748	285/75R24.5	650-0601	650-0539
ST748A	11R24.5	650-0591	650-0532
ST748A	295/75R22.5	650-0610	650-0545
ST748A	11R22.5	650-0601	650-0539
ST748A	285/75R24.5	650-0601	650-0539
ST77	1000-20	650-0598	650-0539
ST77	1000-22	650-0584	650-0532
ST77	11-22.5	650-0598	650-0539
ST77	11-24.5	650-0584	650-0532
ST770	385/65R22.5	650-0595	650-0537
ST7LPT	1000-15	650-0626	650-0549
ST7LPT	750-15	650-0704	None
ST7LPT	825-15	650-0673	650-0561
ST7LPT	900-15	650-0629	650-0554
ST806	1000-20	650-0601	650-0539
ST806	825-20	650-0616	650-0548
ST806	900-20	650-0605	650-0541
ST818	1000R20	650-0598	650-0537
ST818	1000R22	650-0584	650-0528
ST818	1100R20	650-0593	650-0532
ST818	11R22.5	650-0601	650-0537
ST818	11R24.5	650-0587	650-0528
ST818	12R22.5	650-0593	650-0534
ST838M	1000R20	650-0601	650-0539

Sumitomo...(cont'd)	Tire Size	Mile	Kilometer
ST838M	1000R22	650-0587	650-0532
ST838M	10R22.5	650-0610	650-0545
ST838M	1100R20	650-0593	650-0534
ST838M	11R22.5	650-0601	650-0539
ST838M	11R24.5	650-0587	650-0532
ST838M	12R22.5	650-0593	650-0534
ST838M	285/75R24.5	650-0601	650-0537
ST838M	295/75R22.5	650-0608	650-0545
ST838M	900R20	650-0608	650-0542
ST900	1000R20	650-0595	650-0537
ST900	1100R22	650-0671	650-0525
ST900	11R22.5	650-0595	650-0537
ST900	11R24.5	650-0583	650-0528
ST900	12R22.5	650-0591	650-0532
ST908	1000R20	650-0601	650-0537
ST908	11R22.5	650-0598	650-0537
ST908	11R24.5	650-0587	650-0528
ST908	12R22.5	650-0593	650-0534
ST908	285/75R24.5	650-0598	650-0537
ST908	295/75R22.5	650-0605	650-0541
Super Tire			
S/T All Purpose Rib	1000-20	650-0593	650-0532
S/T All Purpose Rib	1000-22	650-0581	650-0526
S/T All Purpose Rib	11-22.5	650-0593	650-0532
S/T All Purpose Rib	11-24.5	650-0581	650-0526
S/T Cross Rib QCR	1000-20	650-0593	650-0532
S/T Cross Rib QCR	1000-22	650-0583	650-0526
S/T Cross Rib QCR	11-22.5	650-0593	650-0532
S/T Cross Rib QCR	11-24.5	650-0583	650-0526
S/T Metal R Quadtrac	1000-20	650-0598	650-0537
S/T Metal R Quadtrac	1000-22	650-0587	650-0532
S/T Metal R Quadtrac	11-22.5	650-0598	650-0537
S/T Metal R Quadtrac	11-24.5	650-0587	650-0532
S/T Metal R Trimax	1000-20	650-0598	650-0537
S/T Metal R Trimax	1000-22	650-0587	650-0532
S/T Metal R Trimax	11-22.5	650-0598	650-0537
S/T Metal R Trimax	11-24.5	650-0587	650-0532
S/T Pr. Highway Rib	1000-20	650-0598	650-0537
S/T Pr. Highway Rib	1000-22	650-0587	650-0532
S/T Pr. Highway Rib	11-22.5	650-0598	650-0537
S/T Pr. Highway Rib	11-24.5	650-0587	650-0532
S/T Safety Rib	1000-20	650-0598	650-0537
S/T Safety Rib	1000-22	650-0583	650-0526
S/T Safety Rib	11-22.5	650-0598	650-0537
S/T Safety Rib	11-24.5	650-0583	650-0526
Super Traction SR3	1000-20	650-0598	650-0537
Super Traction SR3	1000-22	650-0587	650-0532
Super Traction SR3	11-22.5	650-0598	650-0537
Super Traction SR3	11-24.5	650-0587	650-0532
Taurus			
RFT1	1000R20	650-0601	650-0539
RFT1	1100R20	650-0595	650-0535
RFT1	1200R20	650-0584	650-0528
RFT2	1000R20	650-0601	650-0539
RFT2	1000R22	650-0591	650-0532
RFT2	1100R20	650-0595	650-0535

Taurus...(cont'd)	Tire Size	Mile	Kilometer
RFT2	11R22.5	650-0601	650-0539
RFT2	11R24.5	650-0591	650-0532
RFT2	12R22.5	650-0593	650-0535
RT1	1000R20	650-0601	650-0539
RT1	1100R20	650-0595	650-0535
RT1	11R22.5	650-0601	650-0539
RT1	11R24.5	650-0591	650-0532
RT1	12R22.5	650-0593	650-0535
RV1	1000R20	650-0601	650-0539
RV1	1000R22	650-0591	650-0532
RV1	1100R20	650-0595	650-0535
RV1	11R24.5	650-0591	650-0532
RV1	1200R20	650-0584	650-0528
RV1	12R22.5	650-0593	650-0535
RV1	13R22.5	650-0584	650-0528
RV1	825R15	650-0673	650-0561
RV2	11R22.5	650-0601	650-0539
RV2	900R20	650-0610	650-0545
RV3	1000R20	650-0601	650-0539
RV3	1200R20	650-0584	650-0528
RV5	295/80R22.5	650-0605	650-0539
RVA	1000R20	650-0601	650-0539
RVA	1000R22	650-0591	650-0532
RVA	1100R20	650-0595	650-0535
RVA	11R22.5	650-0601	650-0539
RVA	11R24.5	650-0591	650-0532
RVA	1200R20	650-0584	650-0528
RVA	12R22.5	650-0593	650-0535
Top 300	12R22.5	650-0593	650-0535
Top 300	275/80R22.5	650-0610	650-0545
Top 300	285/75R24.5	650-0601	650-0539
Top 300	295/75R22.5	650-0610	650-0545
Top 300	295/80R22.5	650-0605	650-0539
Top 300	315/80R22.5	650-0595	650-0535
Top 400	275/80R22.5	650-0610	650-0545
Top 400	295/80R22.5	650-0605	650-0539
Top 400	315/80R22.5	650-0595	650-0535
Top 410	285/75R24.5	650-0601	650-0539
Toyo			
800 +	175/70R13	650-0716	None
M101	1000R20	650-0605	650-0539
M101	1000R22	650-0591	650-0532
M101	11R22.5	650-0605	650-0539
M101	11R24.5	650-0591	650-0532
M101Z	11R24.5	650-0591	650-0532
M101Z	285/75R24.5	650-0605	650-0541
M101Z	295/75R22.5	650-0613	650-0545
M102Z	275/70R22.5	650-0619	650-0666
M103	1000R20	650-0601	650-0539
M103	1000R22	650-0591	650-0532
M103	11R22.5	650-0601	650-0539
M103	11R24.5	650-0591	650-0532
M104	1000R20	650-0601	650-0539
M104	1000R22	650-0591	650-0532
M104	10R22.5	650-0610	650-0545
M104	11R22.5	650-0601	650-0539
M104	11R24.5	650-0591	650-0532

Toyo...(cont'd)	Tire Size	Mile	Kilometer
M104	900R20	650-0610	650-0545
M104Z	245/75R22.5	650-0640	650-0549
M104Z	265/75R22.5	650-0617	650-0665
M104Z	285/75R24.5	650-0601	650-0539
M104Z	295/75R22.5	650-0610	650-0545
M105Z	385/65R22.5	650-0598	650-0537
M109Z	215/75R17.5	650-0677	650-0571
M110Z	315/80R22.5	650-0595	650-0535
M111Z	1100R22	650-0583	650-0528
M111Z	12R22.5	650-0595	650-0535
M111Z	315/80R22.5	650-0595	650-0535
M114Z	11R22.5	650-0601	650-0539
M114Z	11R24.5	650-0591	650-0532
M114Z	285/75R24.5	650-0601	650-0539
M114Z	295/75R22.5	650-0610	650-0545
M120Z	10R22.5	650-0610	650-0545
M120Z	11R22.5	650-0601	650-0539
M120Z	11R24.5	650-0591	650-0532
M120Z	255/70R22.5	650-0672	650-0549
M124Z	1000R20	650-0601	650-0539
M124Z	11R22.5	650-0601	650-0539
M124Z	11R24.5	650-0591	650-0532
M124Z	285/75R24.5	650-0601	650-0539
M124Z	295/75R22.5	650-0610	650-0545
M314Z	385/65R22.5	650-0595	650-0537
M315Z	11R22.5	650-0601	650-0539
M315Z	11R24.5	650-0587	650-0532
M410	30x950R15	650-0695	650-0578
M410	31x1050R15	650-0691	650-0571
M503	11R22.5	650-0598	650-0537
M503Z	11R24.5	650-0584	650-0528
M506Z	11R22.5	650-0601	650-0537
M506Z	11R24.5	650-0584	650-0528
M508Z	11R24.5	650-0583	650-0528
M54	215/85R16	650-0677	650-0571
M54	235/85R16	650-0704	None
M55	215/85R16	650-0690	650-0567
M55	225/75R16	650-0695	650-0578
M55	235/85R16	650-0675	None
M55	245/75R16	650-0690	650-0567
M56A	1000R20	650-0595	650-0537
M56A	1000R22	650-0584	650-0528
M56A	1100R20	650-0591	650-0532
M56A	11R22.5	650-0595	650-0537
M56A	11R24.5	650-0584	650-0528
M58ZF	11R22.5	650-0601	650-0537
M58ZF	11R24.5	650-0587	650-0528
M58ZF	12R22.5	650-0593	650-0534
M59	1000R20	650-0601	650-0539
M59	1000R22	650-0587	650-0532
M59	10R22.5	650-0610	650-0545
M59	1100R20	650-0595	650-0535
M59	1100R22	650-0583	650-0526
M59	11R22.5	650-0601	650-0539
M59	11R24.5	650-0587	650-0532
M59	900R20	650-0610	650-0545
M59Z	12R22.5	650-0593	650-0534
M60	9R22.5	650-0617	650-0665

Toyo...(cont'd)	Tire Size	Mile	Kilometer
M601Z	255/70R22.5	650-0626	650-0549
M604	1000R20	650-0601	650-0539
M604	1000R22	650-0587	650-0532
M604	11R22.5	650-0601	650-0539
M604	11R24.5	650-0587	650-0532
M605	1000R20	650-0598	650-0537
M605	1000R22	650-0584	650-0528
M605	11R22.5	650-0598	650-0537
M605	11R24.5	650-0584	650-0528
M605	12R22.5	650-0591	650-0532
M605Z	12R22.5	650-0593	650-0532
M605Z	295/75R22.5	650-0605	650-0541
M606	215/85R16	650-0690	650-0567
M606	225/75R16	650-0695	650-0578
M606	235/85R16	650-0675	None
M606	245/75R16	650-0690	650-0567
M608Z	11R24.5	650-0587	650-0532
M608Z	215/75R17.5	650-0690	650-0567
M608Z	245/70R19.5	650-0633	650-0561
M608Z	285/75R24.5	650-0601	650-0539
M608Z	295/75R22.5	650-0610	650-0545
M61	1000R20	650-0601	650-0539
M61	1100R20	650-0595	650-0535
M61	1100R22	650-0583	650-0528
M61	11R22.5	650-0601	650-0539
M61	1200R20	650-0584	650-0528
M61	12R22.5	650-0593	650-0535
M61	13R22.5	650-0584	650-0528
M61	900R20	650-0610	650-0545
M610Z	11R22.5	650-0598	650-0537
M610Z	11R24.5	650-0584	650-0528
M610Z	275/80R24.5	650-0598	650-0537
M610Z	285/75R24.5	650-0598	650-0537
M610Z	295/75R22.5	650-0605	650-0541
M610ZL	11R22.5	650-0598	650-0537
M610ZL	11R24.5	650-0584	650-0528
M610ZL	285/75R24.5	650-0598	650-0537
M610ZL	295/75R22.5	650-0605	650-0541
M61L	11R22.5	650-0601	650-0539
M61LA	11R24.5	650-0587	650-0532
M61LA	1000R22	650-0587	650-0532
M65	31x1050R16.5	650-0690	650-0567
M65	31x1150R15	650-0690	650-0567
M65	31x1150R15	650-0690	650-0567
M70	13/80R20	650-0601	650-0539
M70	14/80R20	650-0593	650-0534
M73Z	12R22.5	650-0593	650-0535
M74	1000R15	None	650-0552
M74(T)	825R15	650-0673	650-0561
M75	255/75R22.5	650-0672	650-0549
M75	295/75R22.5	650-0610	650-0545
M75Z	245/70R19.5	650-0673	650-0561
M75Z	255/70R22.5	650-0672	650-0549
M75Z	265/70R19.5	650-0630	650-0559
M75Z	285/70R19.5	650-0629	None
M76	285/75R24.5	650-0601	650-0539
M76	295/75R22.5	650-0608	650-0545
M82	875R16	650-0695	650-0578

Toyo...(cont'd)	Tire Size	Mile	Kilometer
M82	875R16.5	650-0695	650-0578
M82	950R16.5	650-0677	650-0571
M83	875R16.5	650-0692	None
M83	950R16.5	650-0690	650-0567
M84LA	1000R20	650-0601	650-0539
M84LA	1000R22	650-0591	650-0532
M84LA	1100R20	650-0595	650-0537
M84LA	11R22.5	650-0601	650-0539
M84LA	11R24.5	650-0591	650-0532
M84LA	1200R20	650-0584	650-0528
M84LA	12R22.5	650-0595	650-0535
M87	10R22.5	650-0610	650-0545
M87	1100R20	650-0593	650-0535
M87	1100R22	650-0583	650-0528
M87	11R22.5	650-0583	650-0528
M87	1200R20	650-0584	650-0528
M87	12R22.5	650-0593	650-0535
M87	825R20	650-0618	650-0665
M87	900R20	650-0610	650-0545
M87	9R22.5	650-0618	650-0665
M87ZF	12R22.5	650-0593	650-0534
M91	10R22.5	650-0610	650-0545
M91	1100R20	650-0610	650-0545
M91	1100R22	650-0583	650-0528
M91	900R20	650-0610	650-0545
M93	750R16	650-0675	None
M94	1000R20	650-0601	650-0539
M94	1000R22	650-0587	650-0532
M94	1100R20	650-0595	650-0535
M94	11R22.5	650-0601	650-0539
M94	11R24.5	650-0587	650-0532
M94	12R22.5	650-0595	650-0535
M94Z	12R22.5	650-0595	650-0535
Uniroyal Goodrich			
CLM ST	F78-15	650-0699	650-0589
Euzkadi S/T	1100-22	650-0583	650-0526
Euzkadi S/T	12-24.5	650-0583	650-0526
Extra Miler XL 11	10-22.5	650-0608	650-0545
Extra Miler XL 11	1000-20	650-0598	650-0537
Extra Miler XL 11	1000-22	650-0587	650-0532
Extra Miler XL 11	11-22.5	650-0598	650-0537
Extra Miler XL 11	11-24.5	650-0587	650-0532
Extra Miler XL 11	1100-20	650-0593	650-0532
Extra Miler XL 11	1100-22	650-0583	650-0526
Extra Miler XL 11	12-22.5	650-0593	650-0532
Extra Miler XL 11	12-24.5	650-0583	650-0526
Extra Miler XL 11	1200-20	650-0584	650-0526
Extra Miler XL 11	13-22.5	650-0584	650-0526
Extra Miler XL 11	825-20	650-0616	650-0548
Extra Miler XL 11	9-22.5	650-0616	650-0548
Extra Miler XL 11	900-20	650-0608	650-0545
Extra Traction	10-22.5	650-0595	650-0535
Extra Traction	1000-20	650-0598	650-0537
Extra Traction	1000-22	650-0583	650-0526
Extra Traction	11-22.5	650-0598	650-0537
Extra Traction	11-24.5	650-0583	650-0526
Extra Traction	1100-20	650-0584	650-0526

Uniroyal Goodrich...(cont'd)	Tire Size	Mile	Kilometer
Extra Traction	12-22.5	650-0584	650-0526
Extra Traction	825-20	650-0610	650-0545
Extra Traction	9-22.5	650-0610	650-0545
Extra Traction	900-20	650-0595	650-0535
FleetMaster Super Lug	10-22.5	650-0601	650-0545
FleetMaster Super Lug	1000-20	650-0598	650-0537
Fleetmaster Super Lug	1000-22	650-0583	650-0526
Fleetmaster Super Lug	11-22.5	650-0598	650-0537
Fleetmaster Super Lug	11-24.5	650-0583	650-0526
Fleetmaster Super Lug	1100-20	650-0593	650-0532
Fleetmaster Super Lug	12-22.5	650-0593	650-0532
Fleetmaster Super Lug	825-20	650-0610	650-0548
Fleetmaster Super Lug	9-22.5	650-0610	650-0548
Fleetmaster Super Lug	900-20	650-0601	650-0545
FleetMaster Triple Tread	10-22.5	650-0608	650-0545
FleetMaster Triple Tread	1000-20	650-0598	650-0541
Fleetmaster Triple Tread	1000-22	650-0587	650-0532
Fleetmaster Triple Tread	11-22.5	650-0598	650-0541
Fleetmaster Triple Tread	11-24.5	650-0587	650-0532
Fleetmaster Triple Tread	1100-20	650-0593	650-0537
Fleetmaster Triple Tread	12-22.5	650-0598	650-0537
Fleetmaster Triple Tread	825-20	650-0616	650-0665
Fleetmaster Triple Tread	9-22.5	650-0616	650-0665
Fleetmaster Triple Tread	900-20	650-0608	650-0545
HaulMaster Lug	10-22.5	650-0601	650-0537
HaulMaster Lug	1000-20	650-0593	650-0532
HaulMaster Lug	1000-22	650-0583	650-0526
HaulMaster Lug	11-22.5	650-0593	650-0532
HaulMaster Lug	11-24.5	650-0583	650-0526
HaulMaster Lug	1100-20	650-0584	650-0526
HaulMaster Lug	1100-22	650-0581	650-0525
HaulMaster Lug	12-22.5	650-0584	650-0526
HaulMaster Lug	12-24.5	650-0581	650-0525
HaulMaster Lug	825-20	650-0610	650-0545
HaulMaster Lug	9-22.5	650-0610	650-0545
HaulMaster Lug	900-20	650-0601	650-0537
HaulMaster Rib	10-22.5	650-0601	650-0537
HaulMaster Rib	1000-20	650-0593	650-0532
HaulMaster Rib	1000-22	650-0583	650-0526
HaulMaster Rib	11-22.5	650-0593	650-0532
HaulMaster Rib	11-24.5	650-0583	650-0526
HaulMaster Rib	1100-20	650-0584	650-0526
HaulMaster Rib	1100-22	650-0579	650-0523
HaulMaster Rib	12-22.5	650-0584	650-0526
HaulMaster Rib	12-24.5	650-0579	650-0523
HaulMaster Rib	900-20	650-0601	650-0537
Heavy Duty Express	1000-20	650-0608	650-0541
Heavy Duty Express	1000-22	650-0587	650-0532
Heavy Duty Express	11-22.5	650-0608	650-0541
Heavy Duty Express	11-24.5	650-0587	650-0532
Lifesaver	205/75R15	650-0699	650-0589
LineHaul Premium	10-22.5	650-0601	650-0537
LineHaul Premium	1000-20	650-0593	650-0532
LineHaul Premium	1000-22	650-0583	650-0526
LineHaul Premium	11-22.5	650-0593	650-0532
LineHaul Premium	11-24.5	650-0583	650-0526
LineHaul Premium	1100-20	650-0584	650-0526
LineHaul Premium	1100-22	650-0581	650-0525

Uniroyal Goodrich...(cont'd)	Tire Size	Mile	Kilometer
LineHaul Premium	12-22.5	650-0584	650-0526
LineHaul Premium	12-24.5	650-0581	650-0525
LineHaul Premium	900-20	650-0601	650-0537
Milesaver HDB	1000R20	650-0598	650-0537
Milesaver HDB	1000R22	650-0587	650-0532
Milesaver HDB	10R22.5	650-0608	650-0545
Milesaver HDB	11R22.5	650-0598	650-0537
Milesaver HDB	11R24.5	650-0587	650-0532
Milesaver HDB	900R20	650-0608	650-0545
Milesaver HDR	1000R20	650-0598	650-0537
Milesaver HDR	1000R22	650-0587	650-0532
Milesaver HDR	10R22.5	650-0608	650-0545
Milesaver HDR	11R22.5	650-0598	650-0537
Milesaver HDR	11R24.5	650-0587	650-0532
Milesaver HDR	900R20	650-0608	650-0545
ND Super Traction	10-22.5	650-0601	650-0537
ND Super Traction	1000-20	650-0598	650-0537
ND Super Traction	11-22.5	650-0598	650-0537
ND Super Traction	1100-20	650-0593	650-0532
ND Super Traction	12-22.5	650-0593	650-0532
ND Super Traction	900-20	650-0601	650-0537
Power Express	10-22.5	650-0608	650-0545
Power Express	1000-20	650-0608	650-0541
Power Express	1000-22	650-0587	650-0532
Power Express	11-22.5	650-0598	650-0541
Power Express	11-24.5	650-0587	650-0532
Power Express	1100-20	650-0584	650-0526
Power Express	12-22.5	650-0584	650-0526
Power Express	825-20	650-0616	650-0548
Power Express	9-22.5	650-0616	650-0548
Power Express	900-20	650-0608	650-0545
Power Traction	10-22.5	650-0608	650-0545
Power Traction	1000-20	650-0598	650-0537
Power Traction	1000-22	650-0587	650-0532
Power Traction	11-22.5	650-0598	650-0537
Power Traction	11-24.5	650-0587	650-0532
Power Traction	900-20	650-0608	650-0545
Silver Town	7.5-16	650-0675	None
Suburban Mileage	12-22.5	650-0593	650-0532
Traction Express	11-24.5	650-0581	650-0525
Traction Express Custom	10-22.5	650-0601	650-0537
Traction Express Custom	1000-20	650-0598	650-0537
Traction Express Custom	1000-22	650-0583	650-0526
Traction Express Custom	11-22.5	650-0587	650-0532
Traction Express Custom	11-24.5	650-0581	650-0565
Traction Express Custom	1100-20	650-0584	650-0526
Traction Express Custom	1100-22	650-0581	650-0525
Traction Express Custom	12-22.5	650-0584	650-0526
Traction Express Custom	12-24.5	650-0581	650-0525
Traction Express Custom	825-20	650-0616	650-0548
Traction Express Custom	9-22.5	650-0616	650-0548
Traction Express Custom	900-20	650-0601	650-0537
Traction Express X/Q	1000-20	650-0593	650-0532
Traction Express X/Q	1000-22	650-0583	650-0526
Traction Express X/Q	11-22.5	650-0593	650-0532
Traction Express X/Q	11-24.5	650-0583	650-0526
Traction Express X/Q	1100-22	650-0581	650-0525
Traction Express X/Q	12-24.5	650-0581	650-0525

Uniroyal Goodrich...(cont'd)	Tire Size	Mile	Kilometer
Trans Cargo XL	10-22.5	650-0608	650-0545
Trans Cargo XL	1000-20	650-0598	650-0537
Trans Cargo XL	1000-22	650-0587	650-0532
Trans Cargo XL	11-22.5	650-0608	650-0541
Trans Cargo XL	11-24.5	650-0587	650-0532
Trans Cargo XL	900-20	650-0608	650-0545
XLA	10-22.5	650-0608	650-0545
XLA	1000-20	650-0608	650-0545
XLA	1000-22	650-0587	650-0532
XLA	11-22.5	650-0608	650-0545
XLA	11-24.5	650-0587	650-0532
XLA	1100-20	650-0598	650-0537
XLA	1100-22	650-0587	650-0532
XLA	12-22.5	650-0598	650-0537
XLA	12-24.5	650-0587	650-0532
XLA	825-20	650-0616	650-0545
XLA	9-22.5	650-0616	650-0545
XLA	900-20	650-0608	650-0545
Yokohama			
Loader	19.5 x 24	650-0565	650-0518
LY003	1000R20	650-0598	650-0537
LY003	900R20	650-0610	650-0545
LY053	1000R20	650-0595	650-0537
LY053	1000R22	650-0584	650-0528
LY053	1100R20	650-0591	650-0532
LY053	11R22.5	650-0595	650-0537
LY053	11R24.5	650-0584	650-0528
LY053	12R22.5	650-0591	650-0532
MY243	15R22.5	650-0595	650-0537
MY243	385/65R22.5	650-0595	650-0537
MY243	425/65R22.5	650-0584	650-0528
MY243	445/65R22.5	650-0671	650-0525
MY507	11R22.5	650-0598	650-0537
MY507	11R24.5	650-0584	650-0528
RY083	1000R20	650-0601	650-0539
RY083	1000R22	650-0591	650-0532
RY083A	11R22.5	650-0601	650-0539
RY083A	11R24.5	650-0591	650-0532
RY083A	285/75R24.5	650-0601	650-0539
RY083A	295/75R22.5	650-0610	650-0545
RY083C	11R24.5	650-0591	650-0532
RY083C	12R22.5	650-0595	650-0535
RY103	11/70R22.5	650-0619	650-0666
RY103	225/70R22.5	650-0627	650-0552
RY103	245/75R22.5	650-0622	650-0666
RY103	255/70R22.5	650-0672	650-0549
RY103	265/75R22.5	650-0617	650-0665
RY103	275/70R22.5	650-0619	650-0666
RY103	275/80R22.5	650-0610	650-0545
RY103	275/80R24.5	650-0601	650-0539
RY103	295/75R22.5	650-0610	650-0545
RY103	315/80R22.5	650-0595	650-0537
RY112	1000R20	650-0605	650-0541
RY112	1000R22	650-0593	650-0534
RY112	285/75R24.5	650-0605	650-0541
RY112A	11R22.5	650-0605	650-0541
RY112A	11R24.5	650-0593	650-0534

Yokohama...(cont'd)	Tire Size	Mile	Kilometer
RY112A	285/75R24.5	650-0605	650-0541
RY112A	295/75R22.5	650-0613	650-0664
RY123	285/75R24.5	650-0601	650-0539
RY123	295/75R22.5	650-0610	650-0545
RY203	11R22.5	650-0598	650-0537
RY215	750R16	650-0676	None
RY253	385/65R22.5	650-0595	650-0537
RY253	425/65R22.5	650-0584	650-0528
RY253	445/65R22.5	650-0671	650-0525
RY513	11R22.5	650-0601	650-0539
RY513	11R24.5	650-0591	650-0532
RY513	285/75R24.5	650-0601	650-0539
RY513	295/75R22.5	650-0610	650-0545
SuperDigger	235/85R16	650-0675	None
SY055	11R22.5	650-0601	650-0537
SY055	11R24.5	650-0587	650-0528
SY055	12R22.5	650-0593	650-0534
TY025	750R16	650-0675	None
TY033	1000R20	650-0598	650-0537
TY033	1000R22	650-0587	650-0528
TY033	11R22.5	650-0598	650-0537
TY033	11R24.5	650-0587	650-0528
TY033	285/75R24.5	650-0598	650-0537
TY033	295/75R22.5	650-0608	650-0541
TY063	11R24.5	650-0584	650-0528
TY063	12R22.5	650-0591	650-0532
TY133	285/75R24.5	650-0598	650-0537
TY133	295/75R22.5	650-0608	650-0541
TY143	275/80R22.5	650-0610	650-0545
TY203A	1000R20	650-0598	650-0537
TY203A	1000R22	650-0587	650-0528
TY203A	1100R20	650-0593	650-0534
TY203A	11R22.5	650-0598	650-0537
TY203A	11R24.5	650-0587	650-0528
TY203A	12R22.5	650-0593	650-0534
TY203A	285/75R24.5	650-0598	650-0537
TY203A	295/75R22.5	650-0608	650-0541
TY303C	11R22.5	650-0598	650-0537
TY303C	11R24.5	650-0584	650-0528
TY303C	285/75R24.5	650-0598	650-0537
TY303C	295/75R22.5	650-0605	650-0541
TY503	11R22.5	650-0598	650-0537
TY503	11R24.5	650-0584	650-0528
TY503	285/75R24.5	650-0598	650-0537
TY503	295/75R22.5	650-0605	650-0541
Y703B	1000R20	650-0598	650-0537
Y703B	11R22.5	650-0598	650-0537
Y710L	1100R22	650-0583	650-0526
Y710L	1100R22	650-0670	650-0521
Y710L	1200R24	650-0670	650-0521
Y713B	1000R20	650-0601	650-0539
Y713B	1000R22	650-0587	650-0532
Y713B	10R22.5	650-0610	650-0545
Y713B	1100R20	650-0593	650-0534
Y713B	1100R22	650-0583	650-0526
Y713B	11R22.5	650-0601	650-0539
Y713B	11R24.5	650-0587	650-0532
Y713B	12R22.5	650-0593	650-0534

Yokohama...(cont'd)	Tire Size	Mile	Kilometer
Y713B	825R20	650-0617	650-0548
Y713B	900R20	650-0610	650-0545
Y713B	9R22.5	650-0617	650-0548
Y742S	750R16	650-0675	None
Y745B	950R16.5	650-0690	650-0567
Y773	1000R20	650-0601	650-0539
Y773	1000R22	650-0591	650-0532
Y773	10R22.5	650-0610	650-0545
Y773	1100R20	650-0593	650-0535
Y773	1100R22	650-0583	650-0526
Y773	11R22.5	650-0601	650-0539
Y773	11R24.5	650-0591	650-0532
Y773	1200R20	650-0584	650-0528
Y773	1200R24	650-0670	650-0521
Y773	12R22.5	650-0593	650-0535
Y773	13R22.5	650-0584	650-0528
Y773	13R22.5	650-0584	650-0528
Y773	900R20	650-0610	650-0545
Y780R	825R15	650-0673	650-0561
Y785R	1000R15	650-0627	650-0552
Y785R	1000R20	650-0601	650-0539
Y785R	1000R22	650-0591	650-0532
Y785R	10R17.5	650-0631	650-0559
Y785R	10R22.5	650-0610	650-0545
Y785R	1100R20	650-0595	650-0535
Y785R	11R17.5	650-0627	650-0552
Y785R	11R22.5	650-0601	650-0539
Y785R	11R24.5	650-0591	650-0532
Y785R	1200R20	650-0584	650-0528
Y785R	12R22.5	650-0595	650-0535
Y785R	13/80R20	650-0601	650-0539
Y785R	14/80R20	650-0593	650-0534
Y785R	365/80R20	650-0593	650-0534
Y785R	750R15	650-0691	650-0571
Y785R	825R15	650-0673	650-0561
Y785R	825R20	650-0618	650-0665
Y785R	900R20	650-0610	650-0545
Y785R	9R17.5	650-0673	650-0561
Y785R	9R22.5	650-0618	650-0665
Y788R	215/85R16	650-0677	650-0571
Y788R	235/85R16	650-0704	None
Y788R	950R16.5	650-0677	650-0571
Y793R	1000R20	650-0601	650-0539
Y793R	1000R22	650-0591	650-0532
Y793R	10R22.5	650-0610	650-0545
Y793R	1100R20	650-0595	650-0535
Y793R	11R22.5	650-0601	650-0539
Y793R	11R24.5	650-0591	650-0532
Y793R	1200R20	650-0584	650-0528
Y793R	12R22.5	650-0595	650-0535
Y793R	825R20	650-0617	650-0665
Y793R	900R20	650-0610	650-0545

STEMCO BRACKETS AND ACCESSORIES

BRACKETS BY PART NUMBER

Part Number	Bolt Circle Diameter	Stud Size	Height	Style
610-0001	5-1/4	1/2	1-11/16	A
610-0002*	5-1/2	5/8	1-11/16	A
610-0003*	6-3/8--6-1/2	1/2--9/16	1-11/16	A
610-0005*	7-1/4	9/16	1-11/16	A
610-0006*	7	5/8	1-11/16	A
610-0007*	7	3/4	1-11/16	A
610-0008	7-1/2	5/8	1-9/16	A
610-0009	7-1/2	5/8	3-11/16	A
610-0010	8-5/8	5/8	5-7/16	A
610-0011*	5-1/2--7-1/2	1/2	1-3/4	①
610-0012	4.292	29/64	1-3/4	②
610-0013	5-1/2	7/16	4	A
610-0014	7-5/8	5/8	4-3/8	A
610-0015	2-1/2--6-1/2	9/16	1-1/8	C③
610-0016	2-1/2--6-1/2	5/16--.343	1-1/8	C④
610-0017	5-7/32	5/8	1-11/16	A
610-0019	5-11/16	7/16	1-9/16	A
610-0021	5-1/16--5-5/16	7/16--20 Thrd.	1-3/8	B
610-0022	3-9/16	1/2	1/2	A
610-0023	3-15/16	1/2	1	A
610-0024*	5-1/2	5/16--18 Thrd.	4-1/2	⑤
610-0025	4-1/2--9	3/16	1-11/16	⑥
610-0026	4-3/8	1/2--20 Thrd.	1-1/2	B
610-0033	8-3/8	5/8	1-5/8	A
610-0039	5-5/16	1/2--20 Thrd.	1-1/2	B
610-0045	4-1/8	1/2	1-11/16	A
610-0058	6-1/2	1/2	4-1/2	A
610-0059	4	9/16	1-1/2	A⑦
610-0065*	5-1/2	5/16	3-1/2	A⑧
610-0066	6-1/2	5/8	5-1/4	A
610-0067	6-7/8	7/16	3-1/4	⑨
610-0079	7-1/4	3/4	1-11/16	A
610-0081	8-1/2	5/8	6	A
610-0084*	6-3/4	5/16	5	D⑩
610-0085*	5-1/2	5/16	4	A⑪

To measure bolt circle diameter:
(on axles with an even number of studs)

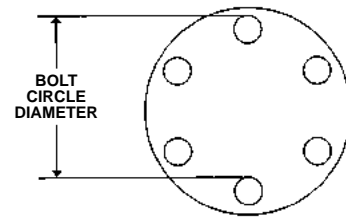

(on axles with an odd number of studs)

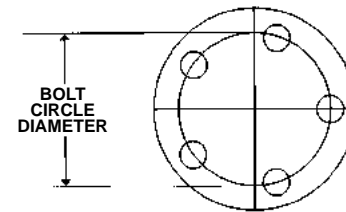

Style A and Style B are for axles with an even number of studs.
Style C for an odd number of studs.

Style A

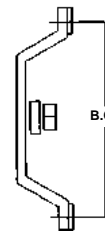

Style B

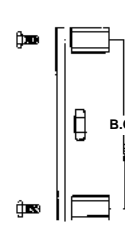

* Popular Brackets

- Universal Mount
- Mercedes (16-Stud Axle Flange)
- Car Mount Bracket (5-Stud Wheels)
- Truck Mount Bracket (5-Stud Wheels)
- Bracket mounts over trailer hub cap; Round plate with standoffs.
For replacement standoffs, order 641-0022 (pkg. of 3)
- TMK-90; completely adjustable
- For golf carts
- Fits over the 4009 hub cap
- Fits over the 4082 hub cap
- Fits bolt on Propar hub cap
- For use with PSI System

Style C

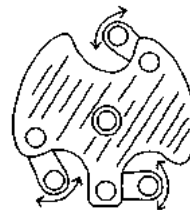

Style D

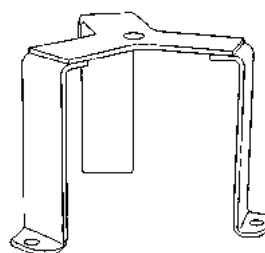

UNIVERSAL MOUNT

Can be assembled in minutes to fit most drive axles. The standard kit fits 5-1/2" to 7-3/4" bolt circles and 1/2" stud size.

Part No.

- 610-0011
- 1 - Angles
 - 2 - Strap
 - 3 - Washer
 - 4 - Nut
 - 5 - Rivets

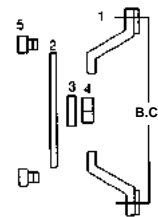

STEMCO BRACKETS AND ACCESSORIES

BRACKETS BY BOLT CIRCLE DIAMETER

Bolt Circle Diameter	Stud Size	Height	Style	Part Number
2-1/2--6-1/2	5/16	1-1/8	C①	610-0016
2-1/2--6-1/2	9/16	1-1/8	C②	610-0015
3-9/16	1/2	1/2	A	610-0022
3-15/16	1/2	1	A	610-0023
4	9/16	1-1/2	A③	610-0059
4-1/8	1/2	1-11/16	A	610-0045
4.292	29/64	1-3/4	④	610-0012
4-3/8	1/2--20 Thrd.	1-1/2	B	610-0026
4-1/2--9	3/16	1-11/16	⑤	610-0025
5-1/16--5-5/16	7/16--20 Thrd.	1-3/8	B	610-0021
5-7/32--5-1/4	5/8	1-11/16	A	610-0017
5-1/4	1/2	1-11/16	A	610-0001
5-1/2--7-1/2	1/2	1-3/4	⑥	610-0011*
5-5/16	1/2--20 Thrd.	1-1/2	B	610-0039
5-1/2	5/16	3-1/2	A⑦	610-0065*
5-1/2	5/16	4	A⑧	610-0085*
5-1/2	5/16--18 Thrd.	4-1/2	⑨	610-0024*
5-1/2	7/16	4	A	610-0013
5-1/2	5/8	1-11/16	A	610-0002*
5-11/16	7/16	1-9/16	A	610-0019
6-3/8--6-1/2	1/2--9/16	1-11/16	A	610-0003*
6-1/2	1/2	4-1/2	A	610-0058
6-1/2	5/8	5-1/4	A	610-0066
6-3/4	5/16	5	D⑩	610-0084*
6-7/8	7/16	3-1/4	⑪	610-0067
7	5/8	1-11/16	A	610-0006*
7	3/4	1-11/16	A	610-0007*
7-1/4	9/16	1-11/16	A	610-0005*
7-1/4	3/4	1-11/16	A	610-0079
7-1/2	5/8	1-9/16	A	610-0008
7-1/2	5/8	3-11/16	A	610-0009
7-5/8	5/8	4-3/8	A	610-0014
8-1/2	5/8	6	A	610-0081
8-3/8	5/8	1-5/8	A	610-0033
8-5/8	5/8	5-7/16	A	610-0010

* Popular Brackets



640-0001



640-0003

FOR TRAILER INSTALLATIONS

Hub Caps (supplied with gasket)

Part No.	Gasket Part No.	Bolt Circle Diameter	Number Of Holes	Bolt Diameter	Aluminum Equivalent
640-0001	641-0005	5-1/2	6	5/16	347-4009
640-0002	641-0017	5-1/2	5	5/16	347-4013
640-0003	330-3077	Propar Screw Cap			347-4075
Hubo Window to fit all Hub Caps with 3-1/2" Windows					359-6117

- Universal Mount
- Mercedes (16-Stud Axle Flange)
- Car Mount Bracket (5-Stud Wheels)
- Truck Mount Bracket (5-Stud Wheels)
- Bracket mounts over trailer hub cap; Round plate with standoffs.
For replacement standoffs, order 641-0022 (pkg. of 3)
- TMK-90; completely adjustable
- For golf carts
- Fits over the 4009 hub cap
- Fits over the 4082 hub cap
- Fits bolt on Propar hub cap
- For use with PSI System

ACCESSORIES

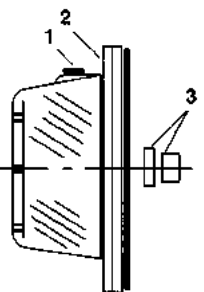

Description	Part No.
1-Pipe plug with O-ring	641-0001
2-Supporting hub cap flange 5 hole	641-0002
6 hole	641-0003
6 hole - 6" BC	641-0026
3-Hubodometer mounting washer & nut	641-0004
Replacement Standoffs for 610-0024 bracket (pkg of 3)	641-0022

ENGINEERING CHANGES SUMMARY

DISCONTINUED	REPLACED BY	DATE	DISCONTINUED	REPLACED BY	DATE
610-0004	610-0006	9/94	650-0651	N/A	8/96
610-0018	N/A	9/94	650-0653	N/A	8/96
610-0020	N/A	9/94	650-0654	N/A	8/96
610-0027	610-0022	5/85	650-0655	N/A	8/96
610-0028	610-0023	5/85	650-0657	N/A	8/96
610-0029	610-0017	5/85	650-0659	N/A	8/96
610-0030	610-0006	5/85	650-0661	N/A	8/96
610-0031	610-0005	5/85	650-0662	N/A	8/96
610-0032	610-0005	9/94	650-0663	N/A	8/96
610-0034	N/A	9/94	650-0668	N/A	8/96
610-0035	610-0026	2/86	650-0669	N/A	8/96
610-0036	N/A	9/94	650-0674	N/A	8/96
610-0037	N/A	5/85	650-0680	N/A	8/96
610-0038	610-0021	5/85	650-0685	N/A	8/96
610-0040	610-0009	5/85	650-0686	N/A	8/96
610-0041	610-0009	5/85	650-0689	N/A	8/96
610-0042	610-0010	5/85	650-0693	N/A	8/96
610-0043	N/A	1/98	650-0697	N/A	8/96
610-0044	N/A	1/98	650-0701	N/A	8/96
610-0046	N/A	6/87	650-0702	N/A	8/96
610-0047	N/A	9/94	650-0705	N/A	8/96
610-0048	N/A	1/86	650-0708	N/A	8/96
610-0049	610-0039	10/85	650-0711	N/A	8/96
610-0050	N/A	9/94	650-0712	N/A	8/96
610-0051	N/A	9/85	650-0714	N/A	8/96
610-0052	610-0032	1/86	650-0715	N/A	8/96
610-0053	N/A	9/94	650-0716	N/A	8/96
610-0057	610-0033	1/86	650-0717	N/A	8/96
610-0078	N/A	8/94	650-0718	N/A	8/96
610-0082	N/A	1/98	650-0719	N/A	8/96
640-0004	N/A	9/94	HU133X	N/A	11/84
640-0006	N/A	2/87	HU134	610-0022	11/84
640-0007	N/A	7/86	HU135	610-0023	11/84
640-0008	640-0003	10/85	HU140M	N/A	11/84
640-0009	N/A	1/98	HU141	610-0045	11/84
641-0017	330-3013	1/98	HU142X	610-0026	11/84
641-0018	330-3015	1/98	HU143X	N/A	11/84
641-0025	330-3056	1/98	HU144X	610-0081	11/84
641-0026	N/A	1/98	HU151	N/A	11/84
641-0027	N/A	1/98	HU152X	610-0021	11/84
650-0510	N/A	8/96	HU153	610-0019	11/84
650-0511	N/A	8/96	HU153M	610-0013	11/84
650-0512	N/A	8/96	HU154	610-0001	11/84
650-0513	N/A	8/96	HU154X	610-0039	11/84
650-0514	N/A	8/96	HU155	610-0002	11/84
650-0518	N/A	8/96	HU156	610-0017	11/84
650-0523	N/A	8/96	HU161	N/A	11/84
650-0524	N/A	8/96	HU164	610-0003	11/84
650-0527	N/A	8/96	HU171	N/A	11/84
650-0555	N/A	8/96	HU173	610-0006	11/84
650-0562	N/A	8/96	HU174	610-0005	11/84
650-0566	N/A	8/96	HU175	610-0006	11/84
650-0570	N/A	8/96	HU176	610-0007	11/84
650-0592	N/A	8/96	HU185	610-0008	11/84
650-0599	N/A	8/96	HU185M	610-0009	11/84
650-0614	N/A	8/96	HU186M	610-0014	11/84
650-0623	N/A	8/96	HU189	N/A	11/84
650-0624	N/A	8/96	HU196M	610-0010	11/84
650-0628	N/A	8/96	HU353L	640-0001	11/84
650-0632	N/A	8/96	HU360L	640-0002	11/84
650-0635	N/A	8/96	HU500	610-0015	11/84
650-0639	N/A	8/96	HU510	610-0016	11/84
650-0643	N/A	8/96	HU700L	610-0003	11/84
650-0645	N/A	8/96	HU910B	610-0024	11/84
650-0646	N/A	8/96	TMK	610-0011	11/84
650-0647	N/A	8/96	TMK-90	610-0025	11/84
650-0648	N/A	8/96			

TIRE SIZE TO HUBODOMETER® CROSSOVER

This is a comprehensive listing of tire sizes and their most common corresponding Hubodometer® part numbers for miles, kilometers and blank tenths. The left column includes a list of tire sizes in numerical order. Find the tire size needed, then locate the Stemco® Hubodometer® part number to the right. For the most accurate Hubodometer® for a given tire, the tire make, model and size is required. This section may not be as accurate for any given tire and should only be used if the tire make, model and size is unknown.

Tire Size	Miles	Kilometers	Blank Tenths (MILES)
10-22.5	650-0601	650-0537	650-0602
10.00-15	650-0626	650-0549	650-0625
10.00-20	650-0598	650-0537	650-0600
10.00-22	650-0587	650-0532	650-0588
10.00/90R20	650-0610	650-0545	650-0611
10.00R15	650-0627	650-0552	None
10.00R20	650-0601	650-0539	650-0602
10.00R22	650-0591	650-0537	650-0590
10.00R24	650-0579	650-0532	None
10R17.5	650-0631	650-0561	650-0632
10R22.5	650-0610	650-0545	650-0611
11-22.5	650-0598	650-0537	650-0600
11-24.5	650-0587	650-0532	650-0588
11.50-20	650-0593	650-0534	650-0594
11/70R22.5	650-0619	650-0666	650-0620
11.00-20	650-0593	650-0532	650-0594
11.00-22	650-0583	650-0526	None
11.00R20	650-0593	650-0532	650-0594
11.00R22	650-0583	650-0526	None
11.00R24	650-0579	650-0523	None
11R17.5	650-0627	650-0552	None
11R22.5	650-0598	650-0539	650-0602
11R24.5	650-0591	650-0532	650-0590
12-16.5	650-0634	650-0563	650-0635
12-22.5	650-0593	650-0532	650-0594
12-24.5	650-0583	650-0526	None
12.5-22.5	650-0593	650-0534	650-0594
12.5R20	650-0605	650-0541	650-0606
12.5R22.5	650-0593	650-0532	650-0594
12.75R22.5	650-0593	650-0534	650-0594
12.00-20	650-0584	650-0526	650-0585
12.00-24	650-0576	650-0521	None
12.00R20	650-0584	650-0526	650-0585
12.00R24	650-0670	650-0521	None
12R22.5	650-0593	650-0534	650-0594
12R24.5	650-0583	650-0526	None
13-22.5	650-0584	650-0526	650-0585
13/80R20	650-0601	650-0539	650-0602
13.00R20	650-0579	650-0523	None
13R22.5	650-0584	650-0528	650-0585
14-17.5	650-0627	650-0552	None
14.5R20	650-0704	None	None
14/80R20	650-0593	650-0534	650-0594
14.00-24	650-0565	None	None
14.00R20	650-0576	650-0519	None
15-19.5	650-0616	650-0548	650-0615
15-22.5	650-0598	650-0537	650-0600
15R22.5	650-0598	650-0537	650-0600
16.5-22.5	650-0584	650-0528	650-0585
16.5R22.5	650-0584	650-0528	650-0585

Tire Size	Miles	Kilometers	Blank Tenths (MILES)
16.00R20	650-0565	None	None
165/80R13	None	None	None
175/70R13	None	None	None
175/80R13	None	None	None
18-19.5	650-0595	650-0537	650-0597
18-22.5	650-0583	650-0528	None
185/70R15.5	None	650-0603	None
18R19.5	650-0595	650-0535	650-0597
18R22.5	650-0671	650-0525	None
195/75R14	650-0700	650-0603	None
205/60R17.5	None	650-0589	None
205/75R15	650-0699	650-0589	None
205/75R17.5	650-0692	None	650-0594
215/70R17.5	650-0692	None	650-0594
215/75R15	650-0698	None	None
215/75R17.5	650-0677	650-0571	650-0678
215/85R16	650-0677	650-0571	650-0678
225/70R19.5	650-0634	650-0563	650-0635
225/70R22.5	650-0627	650-0552	None
225/75R15	650-0695	650-0578	None
225/75R16	650-0695	650-0578	None
225/75R17.5	650-0688	650-0567	None
235/75R15	650-0687	650-0578	None
235/75R17.5	650-0704	None	None
235/80R22.5	650-0622	650-0666	650-0620
235/85R16	650-0704	None	None
245/70R15	650-0696	650-0580	None
245/70R17.5	650-0676	None	None
245/70R19.5	650-0633	650-0561	None
245/75R16	650-0677	650-0571	650-0678
245/75R22.5	650-0622	None	650-0620
255/70R22.5	650-0626	650-0549	650-0625
255/80R22.5	650-0617	650-0665	None
265/70R19.5	650-0631	650-0559	650-0632
265/75R16	650-0704	None	None
265/75R22.5	650-0617	650-0548	None
275/70R22.5	650-0618	650-0665	650-0620
275/80R22.5	650-0610	650-0545	650-0611
275/80R24.5	650-0601	650-0539	650-0602
285/70R19.5	650-0629	None	None
285/75R24.5	650-0601	650-0539	650-0602
295/75R22.5	650-0610	650-0545	650-0611
295/80R22.5	650-0601	650-0539	650-0602
295/85R22.5	650-0601	650-0537	650-0602
305/70R22.5	650-0613	650-0664	None
305/75R24.5	650-0595	650-0535	650-0597
315/70R22.5	650-0610	650-0545	650-0609
315/75R22.5	650-0601	650-0539	650-0602
315/80R22.5	650-0595	650-0535	650-0597
33X12.50X16.5	650-0634	650-0563	650-0635
33X12.50R16.5	650-0634	650-0563	650-0635
365/70R22.5	650-0593	650-0532	650-0594
365/80R20	650-0593	650-0534	650-0594
37X12.50R16.5	650-0626	650-0549	650-0625

Tire Size	Miles	Kilometers	Blank Tenths (MILES)
385/65R19.5	650-0616	650-0664	650-0615
385/65R22.5	650-0595	650-0537	650-0597
385/75R22.5	650-0595	650-0537	650-0597
385/95R24	None	None	None
395/85R20	650-0579	650-0523	None
425/65R22.5	650-0584	650-0528	650-0585
445/65R19.5	650-0595	650-0535	650-0597
445/65R22.5	650-0671	650-0525	None
445/75R19.5	650-0595	650-0535	650-0597
445/95R25	650-0553	None	None
48X31X20	650-0576	650-0521	None
7.5-16	650-0675	None	None
7.00-15	650-0692	None	None
7.00R15	650-0692	None	None
7.50-15	650-0675	None	None
7.50-16	650-0634	650-0563	650-0635
7.50-20	650-0618	650-0666	None
7.50R15	650-0691	650-0571	None
7.50R16	650-0704	None	None
8-14.5	650-0687	650-0580	None
8-19.5	650-0630	650-0559	None
8-22.5	650-0618	650-0666	None
8.5R17.5	650-0704	None	None
8.00R16.5	650-0696	650-0580	None
8.25-15	650-0633	650-0561	None
8.25-20	650-0616	650-0548	650-0615
8.25R15	650-0673	650-0561	None
8.25R20	650-0617	650-0665	None
8.75-16	650-0687	650-0578	None
8.75R16	650-0695	650-0578	None
8.75R16.5	650-0692	None	None
8R17.5	650-0690	650-0567	None
8R19.5	650-0633	650-0561	None
9-14.5	650-0694	None	None
9-22.5	650-0616	650-0548	650-0615
9.00-15	650-0629	650-0554	None
9.00-20	650-0601	650-0537	650-0602
9.00R15	650-0629	650-0554	None
9.00R20	650-0610	650-0545	650-0609
9.50-16.5	650-0677	650-0571	650-0678
9.50R16.5	650-0677	650-0571	650-0678
9R16.5	650-0677	650-0571	650-0678
9R17.5	650-0673	650-0561	None
9R22.5	650-0617	650-0665	None
F78-15	650-0699	650-0589	None
G20	650-0576	650-0519	None

OLD STEMCO PART NUMBERS TO NEW PART NUMBERS

Old Part Number	Tire Size BT=Blank Tenths KM=Kilometers	New Part Number	Old Part Number	Tire Size BT=Blank Tenths KM=Kilometers	New Part Number
650-0001	10.00-20 11-22.5 STD	650-0598	650-0069	7.50-20 8-22.5 HI	650-0618
650-0002	285/75R24.5 STD	650-0601	650-0070	18-22.5 HI	650-1670
650-0003	10.00-20 11-22.5 STD BT	650-0600	650-0071	9.50-16.5 HI	650-0688
650-0004	9.00-20 10-22.5 STD	650-0608	650-0072	12.5-22.5 STD	650-0591
650-0005	275/80R22.5 LO	650-0608	650-0073	11.00-15 STD	650-0627
650-0006	8.25-15 STD	650-0633	650-0074	11.00-24 STD	650-0670
650-0007	8.25-20 9-22.5 STD	650-0616	650-0075	11.00-24 HI	650-0576
650-0008	10.00-22 11-24.5 XHI	650-0581	650-0076	12.00-24 STD	650-0576
650-0009	255/70R22.5 STD	650-0626	650-0077	12.00-24 HI	None
650-0010	10.00-22 11-24.5 STD	650-0587	650-0078	7.00-16 STD	650-0688
650-0011	295/75R22.5 STD	650-0610	650-0079	7.50-15 8-17.5 HI	650-0704
650-0013	295/75R22.5 HI	650-0605	650-0080	7.50-16 HI	650-0673
650-0014	9.00-20 10-22.5 HI	650-0601	650-0081	7.50-17 STD	650-0630
650-0015	275/80R24.5 STD	650-0601	650-0082	8.00-16 STD	650-0692
650-0016	285/75R24.5 HI	650-0598	650-0083	8-16.5 STD	650-0694
650-0017	11.00-20 12-22.5 HI	650-0584	650-0084	8-16.5 HI	650-0696
650-0018	10.00-20 11-22.5 HI	650-0593	650-0085	8-19.5 HI	650-0629
650-0019	11.00-20 12-22.5 STD	650-0593	650-0086	8.75-16.5 HI	650-0690
650-0020	275/80R24.5 HI	650-0593	650-0087	12-16.5 STD	650-0634
650-0021	11.00-20 12-22.5 STD BT	650-0594	650-0088	14.00-24 STD	650-0565
650-0022	11.00-22 12-24.5 STD	650-0583	650-0089	36.00-51 STD KM	650-0503
650-0023	10.00-22 11-24.5 HI	650-0583	650-0090	48IN. DIA STD	None
650-0024	10.00-22 11-24.5 HI BT	None	650-0091	11/70R22.5 STD	650-0617
650-0025	11.00-20 12-22.5 STD KM	650-0532	650-0092	8-14.5 STD	650-0694
650-0026	10.00-22 11-24.5 STD KM	650-0532	650-0093	275/80R22.5 STD KM	650-0542
650-0027	10.00-20 11-22.5 HI KM	650-0532	650-0094	14.00-20 STD	650-0576
650-0028	10.00-20 11-22.5 STD KM	650-0537	650-0095	275/80R22.5 STD	650-0605
650-0029	9.00-20 10-22.5 STD KM	650-0545	650-0096	7.50-15 8-17.5 STD KM	650-0567
650-0032	8.25-20 9-22.5 STD KM	650-0548	650-0097	275/80R22.5 LO BT	650-0609
650-0033	10.00-15 11-17.5 STD KM	650-0549	650-0098	7.00-18 STD	650-0631
650-0034	8.25-15 STD KM	650-0559	650-0099	G78-15 STD	650-0694
650-0035	30.00-51 STD KM	650-0505	650-0100	255/80R22.5 STD	650-0617
650-0036	33.00-51 STD KM	None	650-0101	12.00-20 13-22.5 HI	650-0581
650-0037	14.00-24 STD KM	None	650-0102	27.00-49 STD	650-0658
650-0038	15-22.5 STD KM	650-0532	650-0103	10.00-22 11-24.5 HI KM	650-0526
650-0039	18-22.5 STD KM	650-0523	650-0104	20.50-25 STD	650-0553
650-0040	24.00-49 STD KM	None	650-0105	10.00-22 11-24.5 HI KM BT	None
650-0041	27.00-49 STD KM	650-0507	650-0106	21.00-49 STD	650-0660
650-0042	7.50-16 STD	650-0634	650-0107	F78-14 STD KM	None
650-0043	8.75-16.5 STD	650-0692	650-0108	7.50-20 8-22.5 STD KM	650-0666
650-0044	9.50-16.5 STD	650-0692	650-0109	18.00-25 STD KM	None
650-0045	10.00-15 11-17.5 STD	650-0627	650-0110	7.50-16 STD KM	650-0563
650-0047	7.50-20 8-22.5 STD	650-0622	650-0112	12.00-20 13-22.5 STD KM	650-0526
650-0048	11.00-20 12-22.5 LO	650-0598	650-0113	18.00-33 STD KM	None
650-0049	11.00-22 12-24.5 LO	650-0587	650-0114	14.00-25 STD	None
650-0050	11.00-22 12-24.5 HI	650-0581	650-0115	37.50-33 STD KM	None
650-0051	9.00-15 STD	650-0629	650-0116	29.50-29 STD KM	None
650-0054	10.00-20 11-22.5 XHI	650-0587	650-0117	21.00-35 STD KM	650-0508
650-0055	10.00-22 11-24.5 STD BT	650-0588	650-0118	23.50-25 STD KM	None
650-0057	11/80R22.5 STD	650-0610	650-0119	21.00-25 STD	650-0538
650-0058	11/80R24.5 STD	650-0601	650-0120	33.25-35 STD	650-0517
650-0060	13/75R22.5 STD	650-0598	650-0121	7.00-16 STD KM	650-0567
650-0061	315/80R22.5 STD	650-0595	650-0122	12.00-24 STD KM	650-0521
650-0062	7.50-15 8-17.5 STD	650-0688	650-0123	11.00-16 STD KM	650-0552
650-0063	8.25-20 9-22.5 HI	650-0610	650-0124	215/85R16 LO	650-0677
650-0064	18-22.5 STD	650-0579	650-0125	9.00-20 10-22.5 XHI	650-0595
650-0065	12.00-20 13-22.5 STD	650-0584	650-0126	9.00-20 10-22.5 HI KM	650-0537
650-0066	10-17.5 STD	650-0631	650-0127	9.00-20 10-22.5 XHI KM	650-0535
650-0067	8.25-20 9-22.5 XHI	650-0605	650-0128	7.50-20 8-22.5 XHI	650-0616
650-0068	12.75-22.5 STD	650-0593	650-0129	12.5-22.5 STD BT	650-0590

Old Part Number	Tire Size BT=Blank Tenths KM=Kilometers	New Part Number	Old Part Number	Tire Size BT=Blank Tenths KM=Kilometers	New Part Number
650-0130	9-17.5 STD	650-0633	650-0198	16.00-24 STD KM	None
650-0131	9.50-17.5 STD	650-0633	650-0199	8.25-20 9-22.5 LO	650-0619
650-0132	18.00-25 STD	N/A	650-0200	G78-14 STD KM	650-0580
650-0134	13.00-24 STD	650-0565	650-0201	7.00-17 STD	650-0633
650-0135	36.00-51 STD	650-0652	650-0202	7.00-18 HI	650-0630
650-0136	8-19.5 STD	650-0631	650-0203	7.50-15 8-17.5 HI KM	N/A
650-0137	8.50-17.5 HI	650-0634	650-0204	7.50-16 HI KM	650-0561
650-0138	24.00-35 STD	650-0517	650-0205	8.25-20 9-22.5 HI KM	650-0545
650-0139	315/80R22.5 STD KM	650-0534	650-0206	8.75-16.5 STD KM	650-0571
650-0140	215/85R16 STD	650-0676	650-0207	8.75-16.5 HI KM	650-0567
650-0141	11.00-22 12-24.5 STD KM	650-0526	650-0208	9.00-20 10-22.5 HI BT	650-0602
650-0142	10-16.5 STD	650-0688	650-0209	9.50-15 STD	650-0634
650-0143	13/80R20 STD	650-0601	650-0210	10-17.5 STD KM	650-0559
650-0144	30.00-51 E4 11/16 STUD	None	650-0211	11.00-15 HI	650-0640
650-0145	11.50-20 STD	650-0584	650-0212	11.00-20 12-22.5 LO BT	650-0600
650-0146	275/80R22.5 HI	650-0601	650-0213	11.00-22 12-24.5 XHI KM	650-0523
650-0148	10.00-20 11-22.5 LO	650-0608	650-0214	12.00-22 STD KM	650-0523
650-0149	30.00-51 STD	650-0656	650-0215	12.00-22 STD	650-0579
650-0150	18.00-33 STD	None	650-0216	9.00-20 10-22.5 LO KM	650-0548
650-0151	11.00-20 12-22.5 HI KM	650-0526	650-0217	12.00-24 HI KM	650-0519
650-0152	275/80R24.5 STD KM	650-0539	650-0218	12.00-24 XHI KM	None
650-0153	235/85R16 STD	650-0634	650-0219	20.50-25 STD KM 11/16 STUD	None
650-0154	14/80R20 STD	650-0593	650-0220	24.00-49 STD 11/16 STUD	None
650-0155	14.00-20 STD KM	650-0519	650-0222	11/80R24.5 STD KM	650-0539
650-0156	7.50-16 XHI	650-0633	650-0223	215/85R16 STD KM	None
650-0157	295/80R22.5 STD	650-0605	650-0224	255/70R22.5 STD KM	650-0552
650-0158	185R14 STD	650-0700	650-0225	275/80R22.5 HI KM	650-0539
650-0159	8.50-17.5 STD	650-0704	650-0226	16.00-24 STD	650-0553
650-0160	12.5-22.5 STD KM	650-0532	650-0227	17.50-25 STD KM	650-0519
650-0161	8.25-20 9-22.5 STD BT	650-0615	650-0228	F78-15 STD KM	650-0589
650-0162	24.00-49 E4 STD	None	650-0234	40.00-57 STD KM	650-0641
650-0163	13.00-24 STD KM	650-0519	650-0235	12.75-22.5 STD KM	650-0532
650-0165	295/75R22.5 HI KM	650-0541	650-0236	33.50-33 STD KM	None
650-0167	21.00-35 LO	650-0520	650-0237	13.00-20 STD KM	650-0523
650-0168	315/80R22.5 STD BT	650-0597	650-0238	9.00-20 10-22.5 STD BT	650-0609
650-0169	285/75R24.5 STD KM	650-0537	650-0239	J78-15 STD	650-0694
650-0171	16.5-22.5 STD	650-0671	650-0241	295/75R22.5 STD BT	650-0611
650-0172	255/80R22.5 STD KM	650-0665	650-0242	285/75R24.5 HI KM	650-0534
650-0173	11.00-24 STD KM	650-0521	650-0244	11.00-22 12-24.5 XHI	650-0579
650-0174	14.00-24 STD KM 11/16 STUD	650-0515	650-0246	10.00-20 11-22.5 HI BT	650-0594
650-0175	11/70R22.5 STD KM	650-0548	650-0248	11.00-20 12-22.5 STD (All Black Wheels)	N/A
650-0176	30.00-51 E4 SRL KM 11/16 STUD	N/A	650-0249	10/90R20 STD	650-0610
650-0177	7.00-15 STD	650-0692	650-0250	7.50-20 8-22.5 LO	650-0626
650-0178	8-16.5 STD KM	650-0578	650-0252	23.50-25 STD	None
650-0179	8-19.5 STD KM	650-0559	650-0253	295/80R22.5 STD KM	650-0541
650-0180	11.00-20 12-22.5 LO KM	650-0537	650-0256	15.50-20 STD	650-0587
650-0181	21.00-35 HI	650-0517	650-0257	13.00-20 STD	650-0579
650-0182	36.00-51 E4 SRL KM 11/16 STUD	650-0501	650-0258	17.50-25 STD	None
650-0183	12.00-20 13-22.5 HI BT	650-0582	650-0259	215/75R17.5 STD	650-0691
650-0184	15-22.5 STD	650-0595	650-0260	16.9-28 STD	650-0560
650-0185	11.00-22 12-24.5 HI KM	650-0525	650-0261	16.5-22.5 STD KM	650-0532
650-0185	275/70R22.5 STD	650-0619	650-0262	L78-15 HI	650-0695
650-0187	7.50-16 XLO	650-0676	650-0263	235/75R15 STD	650-0687
650-0188	275/70R22.5 STD KM	650-0665	650-0265	285/75R24.5 STD BT	650-0602
650-0189	275/65R22.5 STD	650-0626	650-0266	10.00-22 11-24.5 XHI BT	650-0582
650-0191	16.00-20 STD KM	None	650-0267	9-14.5 STD	650-0698
650-0192	26.50-25 LO KM	None	650-0268	26.50-25 STD	N/A
650-0193	H78-15 STD	650-0696	650-0269	275/80R24.5 STD BT	650-0602
650-0194	21.00-35 LO KM	None	650-0270	265/70R19.5 STD	650-0631
650-0195	14.00-24 HI	650-0560	650-0272	275/80R24.5 XHI	650-0587
650-0196	255/70R22.5 STD BT	650-0625	650-0273	16.9-30 STD	None
650-0197	8.25-15 HI	650-0631			

Old Part Number	Tire Size BT=Blank Tenths KM=Kilometers	New Part Number	Old Part Number	Tire Size BT=Blank Tenths KM=Kilometers	New Part Number
650-0274	9-17.5 STD KM	650-0561	650-0371	21.00-35 XLO	N/A
650-0275	175/80R13 STD	None	650-0373	29.50-25 STD	650-0538
650-0278	21.00-35 STD	N/A	650-0375	235/80R22.5 STD	650-0622
650-0279	12.5L-15 STD	650-0695	650-0377	275/65R22.5 LO	650-0672
650-0280	12.5L-15 STD KM	650-0578	650-0378	11.50-20 LO	650-0593
650-0281	B78-13 LO	None	650-0379	H78-15 LO	650-0698
650-0282	265/70R19.5 STD KM	650-0559	650-0380	12.5-22.5 LO	650-0593
650-0284	305/75R22.5 STD KM	650-0605	650-0381	12.5-22.5 LO KM	650-0535
650-0286	11.00-20 12-22.5 XHI	650-0583	650-0382	12-16.5 LO	650-0704
650-0287	37.00-57 STD	650-0509	650-0383	19-19.5 STD	650-0616
650-0288	255/75R19.5 STD	650-0634	650-0384	7.50-16 LO	650-0675
650-0290	9.50-16.5 STD BT	None	650-0385	235/85R16 XLO	650-0690
650-0309	11.00-22 12-24.5 STD BT	None	650-0386	8.25-20 9-22.5 LO KM	650-0665
650-0310	12.00-20 13-22.5 STD BT	650-0585	650-0388	37.00-57 STD KM	650-0642
650-0313	265/75R22.5 STD KM	650-0548	650-0389	205/80R15 STD KM	N/A
650-0314	10.00-15 11-17.5 HI	650-0640	650-0390	385/65R22.5 LO	650-0598
650-0315	11.5-22.5 STD	650-0583	650-0391	255/75R16 STD	650-0687
650-0316	6.50-16 STD	650-0688	650-0393	21.00-25 STD KM	None
650-0317	315/75R22.5 STD	650-0601	650-0394	425/65R22.5 STD	650-0583
650-0320	14.00-20 HI	None	650-0395	445/65R22.5 STD	650-0581
650-0322	7-14.5 STD	650-0699	650-0396	14.00-25 HI KM	None
650-0323	16.00-25 STD	650-0553	650-0398	295/75R22.5 STD KM	650-0664
650-0324	8.25-16 STD	650-0631	650-0399	12.00-20 13-22.5 LO KM	650-0528
650-0325	16.5-22.5 LO	650-0584	650-0403	195R16C STD BT	650-0683
650-0326	215/85R16 LO KM	650-0571	650-0404	295/75R22.5 HI BT	650-0606
650-0327	15-22.5 HI	650-0584	650-0405	10.00-20 11-22.5 LO KM	650-0541
650-0328	7.00-15 HI	650-0688	650-0406	7.50-17 STD KM	650-0554
650-0329	24.00-35 STD KM	650-0649	650-0407	185R14 STD KM	650-0603
650-0330	7.00-14 STD KM	N/A	650-0408	12.5-22.5 LO BT	650-0594
650-0331	6.50-16 STD KM	650-0571	650-0410	12.00-20 13-22.5 LO KM BT	650-0529
650-0332	9.00-15 STD KM	650-0554	650-0411	12.5-22.5 LO KM BT	650-0682
650-0333	7.00-20 STD	650-0627	650-0412	205/75R17.5 STD	650-0695
650-0334	13/75R22.5 STD BT	650-0600	650-0413	205/75R16 STD BT	650-0683
650-0335	12.5-22.5 HI	650-0671	650-0414	7.50-15 8-17.5 STD BT	None
650-0336	9.00-15 HI KM	650-0552	650-0415	205/75R17.5 XLO BT	650-0678
650-0337	235/85R16 LO	650-0704	650-0416	195R16 STD KM	650-0580
650-0338	9.00-16 STD KM	650-0554	650-0417	245/70R19.5 STD	650-0633
650-0340	40.00-57 STD	650-0650	650-0418	275/70R22.5 STD BT	650-0620
650-0341	245/75R22.5 HI	650-0622	650-0419	825-16 STD BT	650-0632
650-0342	245/75R22.5 STD	650-0640	650-0420	850-17.5 HI BT	650-0635
650-0343	255/70R22.5 LO	650-0627	650-0421	33.00-51 STD	None
650-0344	285/75R24.5 LO	650-0605	650-0422	650-10 STD KM	None
650-0345	265/75R22.5 STD	650-0617	650-0423	445/65R22.5 LO	650-0601
650-0346	215/75R17.5 STD KM	650-0571	650-0424	900/20 10-22.5 LO BT	None
650-0347	10.00-22 11-24.5 LO	650-0595	650-0427	8.75-16.5 LO	650-0687
650-0349	9.00-20 10-22.5 LO	650-0613	650-0429	950-17.5 STD KM	650-0561
650-0350	385/65R22.5 STD	650-0595	650-0430	285/75R24.5 STD BT	650-0602
650-0351	295/80R22.5 STD BT	650-0606	650-0431	285/75R24.5 HI BT	650-0600
650-0352	11/70R22.5 STD BT	N/A	650-0433	285/75R24.5 LT KM	650-0541
650-0355	8-14.5 LO	650-0698	650-0437	45/65R45 STD KM	None
650-0357	18-22.5 LO	650-0671	650-0440	4.8-12 STD	None
650-0358	9.00-16 STD	None	650-0442	275/80R22.5 LO KM	650-0542
650-0359	425/65R22.5 STD KM	650-0528	650-0446	12.5-22.5 LO KM	650-0535
650-0360	275/80R24.5 LO	650-0605	650-0449	9-14.5 HI	650-0696
650-0362	11.2/10-24 STD	650-0601	650-0450	8.25-16 STD KM	650-0559
650-0363	7.50-15 8-17.5 LO	650-0677	650-0451	225/70R19.5 STD	650-0634
650-0364	185R14 STD BT	650-0685	650-0454	9.00-24 HI KM	650-0532
650-0365	9.50-17.5 LO BT	None	650-0456	7.50-16 KM	None
650-0366	11/70R22.5 LO BT	650-0620	650-0457	245/70R19.5 STD BT	650-0681
650-0367	18-19.5 STD	650-0595			
650-0368	255/80R22.5 LO	650-0622			
650-0370	11.00-20 12-22.5 HI BT	650-0585			

STEMCO HUBODOMETER®

INSTALLATION INSTRUCTIONS

1. **Mount Hubodometer® to face of hub cap or bracket.**
2. **Use washer under locknut.**
3. **Use 15-ft lbs. of torque to tighten locknut.**

DO NOT USE AIR IMPACT WRENCH.

DO NOT EXCEED 15-ft. lbs. OF TORQUE.

4. **If necessary, use strap wrench to hold Hubodometer® while tightening.**
5. **DO NOT USE PAINTS, SOLVENTS OR THINNERS ON THE HUBODOMETER® FACE, GRILAMID HUB CAP OR HUBODOMETER® HUB CAP WINDOW.**

The recommended torque for the 3/8" pipe plug for aluminum hub caps is 9 ft.-lbs. A suitable sealant may be used on the pipe plug threads if desired. On Grilamid hub caps with plastic fill plug and o-ring, tighten to torque not to exceed 10 ft.-lbs.

The proper oil level for the Stemco Hubodometer® window is indicated by the inside protruding ledge of the window. (See drawing.)

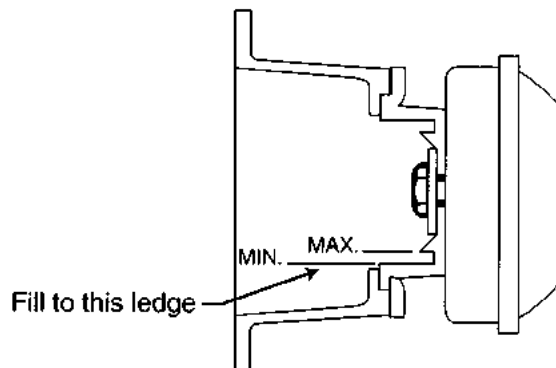

Stemco Quality Products



STEMCO®

A Higher Standard of Performance.™



STEMCO
GAFF™



Polyurethane Mounts and Suspension Parts

STEMCO
SUSPENSION PRODUCTS™

TORQUE ROD

Exceptional Value and Versatility



Torque Rod Assemblies

Compatible with	OEM Number	Length	Type	(Bushings)	GAFF No.
Freightliner®	16-16749-000	C-C 22 7/8"	1	(2-13521)	11153
Freightliner®	16-16749-001	C-C 23 13/16"	1	(2-11004)	11078
Freightliner®	16-16749-002	C-C 24 5/16"	1	(2-11004)	11081
Freightliner®	16-18972-000	C-C 24 3/16"	1	(2-13520)	11152
Hendrickson®	62010-455	C-C 17 15/16"	1	(2-13520)	12396
Hendrickson®	62350-615	C-C 24 1/4"	2	(13520, 13518)	13733
Hendrickson®	62007-365	C-C 14 3/8"	1	(2-13520)	13735
Kenworth® / Peterbilt®	925150	C-C 25"	2	(13520, 13518)	11794
Kenworth® / Peterbilt®	C65-1009	C-C 21 1/4"	1	(2-11729)	11793
Kenworth® / Peterbilt®	C65-6009	C-C 25 9/16"	1	(2-13521)	11792
Kenworth® / Peterbilt®	C65-6011-002	C-C 24 11/16"	3	(13521, 14010)	11795
Kenworth® / Peterbilt®	K195-375	C-C 24"	1	(2-13520)	11751
Kenworth® / Peterbilt®	K195-376	C-C 24"	1	(13520, 13518)	11080
Kenworth® / Peterbilt®	K195-474	C-C 19 3/4"	2	(2-11729)	11773
Mack®	25162529	C-C 18"	2	(13520, 12031)	12072
Mack®	25164945	C-C 23 3/4"	1	(2-11729)	12074
Mack®	25170831	C-C 20"	1	(2-13520)	12070
Mack®	25170832	C-C 21"	1	(2-13520)	12069
Mack®	25170833	C-C 24 3/16"	1	(2-13520)	12071
Mack®	25174658	C-C 21 1/2"	1	(2-13520)	12073
Mack®	25174706	C-C 22"	1	(2-11729)	13634
Mack® / Volvo®	35801-0033	C-C 22"	2	(13520, 13518)	13657
Mack® / Volvo®	35801-0068	C-C 22 1/8"	1	(2-13520)	18860
Mack® / Volvo®	35801-5018	C-C 26" max	2*	(13520, 12031)	12042
Mack® / Volvo®	35801-5012	C-C 26" max	1*	(2-13520)	12044
Navistar®	1612516C91	C-C 23 1/4"	1	(2-13520)	34556
Navistar®	3580088C1	C-C 25 3/8"	1	(2-13521)	34563
Navistar®	444122C91	C-C 25 1/4"	2	(13520, 13518)	34555
Peterbilt®	03-04059	C-C 22 7/8"	1	(2-13520)	34554
Peterbilt®	62350-635	C-C 25"	2	(13520, 13518)	13679
Peterbilt®	943711	C-C 25 9/16"	1	(2-13520)	12398
Peterbilt®	924175 / 03-04327	C-C 17 5/16"	1	(13528, 13520)	12395
Peterbilt®	C65-6011-001	C-C 23 3/4"	3	(13521, 14010)	12397
Volvo®	35800-48575	C-C 22 5/8"	1	(2-11729)	31095

TORQUE ROD ENDS



ROD END ASSEMBLIES

(includes bushing)

GAFF No.	Length	Rod	(Bushing)
13689	33 7/16"	13707	(13685)
13690	33 7/16"	13707	(13520)
13691	25 7/16"	13682	(13520)
13692	33 7/16"	13707	(13684)
13693	25 7/16"	13682	(13684)
13694	33 7/16"	13707	(13518)
13695	25 7/16"	13682	(13518)
13696	33 7/16"	13707	(12031)
13697	25 7/16"	13682	(12031)
13698	33 7/16"	13707	(13616)
13699	25 7/16"	13682	(13516)
13702	33 7/16"	13707	(13528)
13703	25 7/16"	13682	(13528)
13704	25 7/16"	13682	(13685)



TUBE END ASSEMBLIES

(includes bushing)

GAFF No.	Length	Rod	(Bushing)
13683	8 9/16"	13681	(13520)
13686	8 9/16"	13681	(13518)
13687	8 9/16"	13681	(13517)
13688	8 9/16"	13681	(13516)
13700	8 9/16"	13681	(13685)
13701	8 9/16"	13681	(13528)

Available torque rod types

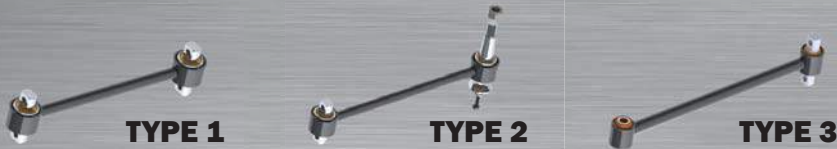

* Two piece design - weld to length

The use of a manufacturer's name, product number and part description is intended to assist our customers in identifying replacement parts. Names referenced may be trademarks or trade names of their respective manufacturers or suppliers and are not intended to show affiliation between STEMCO and the owners of those names.

STEMCO - USA

P. O. Box 1989 • Longview, TX 75606-1989
(903) 758-9981 • 1-800-527-8492 • FAX: 1-800-874-4297

STEMCO - Canada

5650 Timberlea Blvd. Unit B • Mississauga, ON L4W 4M6
(905) 206-9922 • 877-232-9111 • FAX: (877) 244-4555

STEMCO - Australia

Unit 6 CNR Rookwood & Muir Roads • Yagoona, NSW 2199
Phone: 011-61-2-8713-2502 • FAX: 011-61-2-9793-2544

STEMCO GAFF is a trademark of STEMCO LP ©2014 STEMCO LP

Printed in the USA • Part No. 577-9050

Horak • 12/14

Catalog Table of Contents

OEM Summaries 2 - 280

Application Summaries 281 - 313

- Brakes 281 - 285
- Bumpers 286 - 287
- Fifth Wheel & Hinge Bushings 287 - 295
- Hood Latches 296 - 300
- Reefer Units 300 - 301
- Torque Rod 301 - 313

Miscellaneous 313 - 326

Tools 326 - 329

Crass Reference Table 330 - 369

Index By Part ID 370 - 376

Abbreviations:

Description	Label
Bolt Center to Center	BCC
Bolt Hole	BH
Second Bolt Hole	BH ²
Center to Center	CC
Dowel Diameter	Dowel
Hardness	HD
Height	HGT
Inner Diameter	D
Minor Inner Diameter	ID<
Length	LG
Second Length	LG ²
Outer Diameter	OD
Minor Outer Diameter	OO<
Thickness	THK
Thread Size	THR
Width	WO

OEM Summaries

Arvin Meritor	2-7.
Autocar	7-8
Chalmers	8-10
Ford	0-7.
Freightliner	7-46
Fruehauf	46-56
GMC	57-62
Hendrickson	63-95
Hino/Isuzu/Mitsubishi/Nissan	95-96
Hutchens	96-102
International	102-136
Kenworth	137-157
Mack	:157-72
Neway	:173-86
Peterbilt	:187-20:1
Reyco	20:1-2:14
Ridewell	215-218
Sterling Truck	218-225
Trailers	225-236
Transit/Coach - MC, GMC, RTS, New Flyer	236-25
Volvo	252-274
Watson & Chalin	27.4-27.5
Western Star	276-280
Application Summaries	28:1-3:13
Tools	326-329

8 OEM Su11111aries

t
wt
1-
18

Arvin Meritor

DESCRIPTION	OEM	PRICE ID	PAGE
Camshaft Bushing	1225-L-1208 / E-5512 / 02-210	17501	5
Camshaft Bushing	1225-B-834 / 02-242	17504	5
Camshaft Bushing	1225-R-1058 / E-2361	17529	5
Camshaft Bushing	1225-N-378 / E-536	17538	5
Camshaft Bushing	A 1225-V-438	17574	5
Camshaft Bushing	1225-X-804 / E-2551	18439	6
Camshaft Bushing	1225-R-1058 / E-2361	18991	6
Carrier Bearing Assy	210661-1X/ CB2106611XSA/ DS-6049	40074	6
Carrier Bearing Assy	CB210121-1X/ CB2101211XSA/ CCB101 / DS-6048	40075	6
Control Arm Bushing	1225-R-1370 / 202815-3 / A-1225-L-1416 / M302500 / PB00-36314	34514	6
Control Arm Bushing Kit	1225-R-1370 / A-1225-L-1416 / FRK0510030 / KIT11126 2 / KIT11300 / 334-1674 / SU99-39114 / SU99-39116	50032	6
Easy-MountTorque Rod Bushing	A-2297-Y-77A / 20-833PU / R302226 / R307639 / C879 / C879UB / E-2226 / E4664 / E-7639 / D423 / 321-132 / 321-132U / M2070 / 09-5723 / TRB6820 / TRB6820UB / TS38000	83520	7
Pivot Bushing Kit	2122663 / A1225N1522 / KIT11201 / E-14347	13599	5
Shock Absorber Bushing	415015-001 / 401754 / PL1026	18010	6
Torque Rod Assy	A13102146A / 925030 / TR5941375	11751	4
Torque Rod Bushing	39400013 / 30-1382 / IH9 / E-3086 / 321-186 / M2135 / TRB8640	10000	4
Torque Rod Bushing	A-2297-J-1050	11716	4
Torque Rod Bushing	A-2297-K-1052 / A-2297-V-4806 / 35-501 / R309323 / E-9323 / 0244 / 321-325 / 321-325A / 09-7241 / TRB6801 / TRB6801 UB / RW53000	11735	4
Torque Rod Bushing	A-2297-Y-77A / 20-833PU / R302226 / R307639 / C879 / C879UB / E-2226 / E4664 / E-7639 / D423 / 321-132 / 321-132U / M2070 / 09-5723 / TRB6820 / TRB6820UB / TS38000	13520	5
Torque Rod Bushing	A-2297-Y-77A / 20-833PU / R302226 / R307639 / C879UB / E-2226 / E4664 / E-7639 / D423 / 321-132U / M2070 / 09-5723 / TRB6820UB	13536	5
Torque Rod Bushing	A1225-G-1437 / SU99-39113	50031	6
Torque Rod Bushing	KIT11126 / E-11763 / 334-1672 / TRK4931 / PB00-26422 / SU99-39115	50033	7

STEM1CO GAFF replacement parts compatible with:
ARVINMERITOR® CS SUSPENSION RANGE

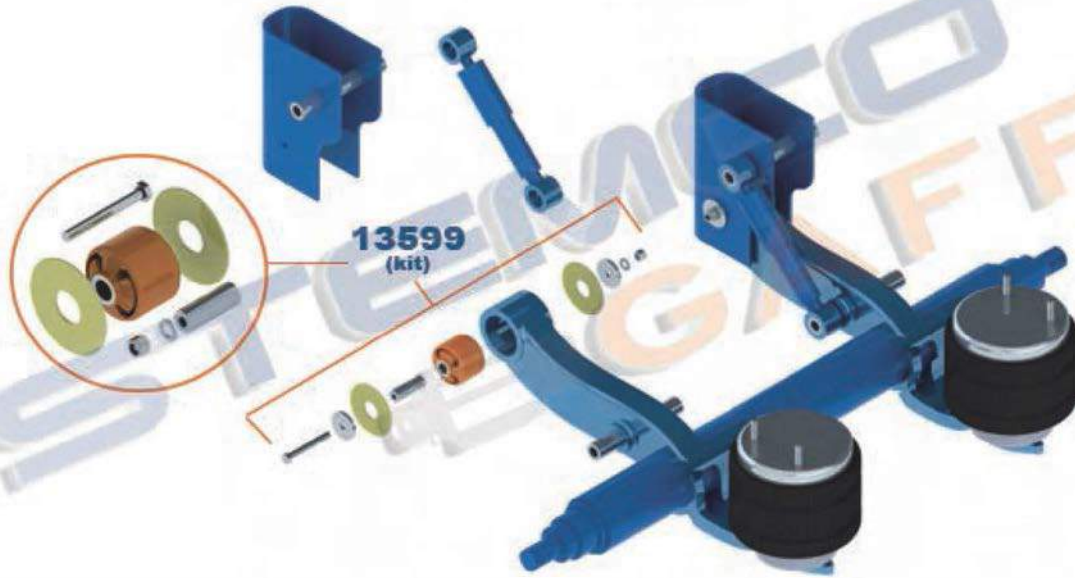

STEM,CO GAFF replacement parts compatible with:
ARVINMERITOR® RIDESENTRY®
MPA 38/40 SUSPENSION



t
wt
18

STEMCO GAFF replacement parts compa.ti.ble with:
ARVINMERITOR® RIDESTAR® RHP SUSPENSION

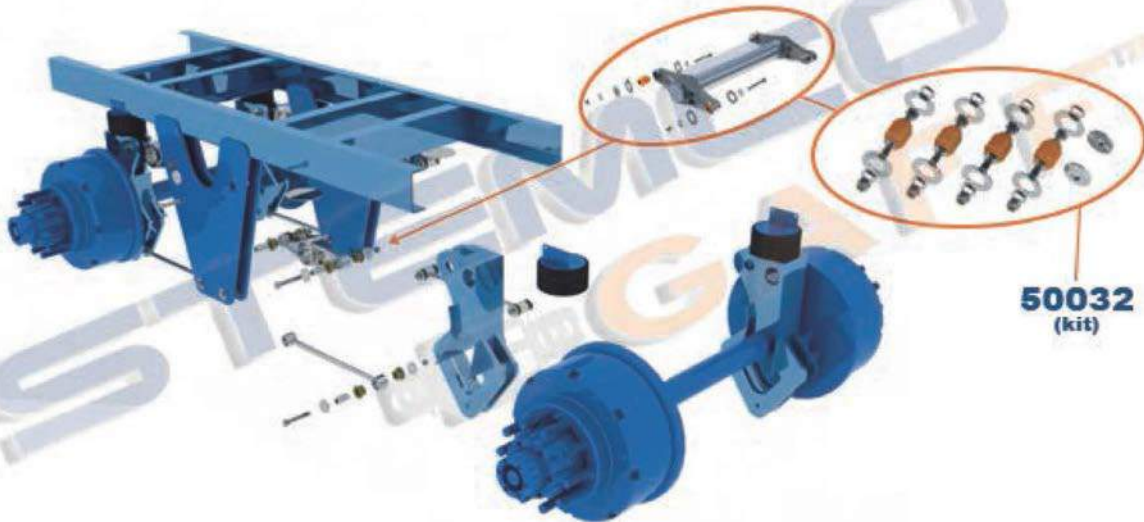

50032
(kit)

10000



Torque Rod Bushing

OD	2	3/8	-
ID		7/8	-
LG	3	1/8	-
HD	80A		

OEM
 39400013
 30-1382
 IH9
 E-3086
 321-186
 M2135
 TRB8640

Notes:

11716



Torque Rod Bushing

OD	5	7/16	-
OD<	4	7/8	-
ID	4	3/16	-
LG	4	3/8	-
HD	80A-72D		

OEM
 A-2297-J-1050

Notes:

11735



Torque Rod Bushing

OD	4	1/8	-
CC	4	3/8	-
BH		3/4	-
HD	80A		

OEM
 A-2297-K-1052
 A-2297-V-4806
 35-501
 R309323
 E-9323
 D244
 321-325
 321-325A
 09-7241
 TRB6801

Notes: see 11512 for smaller BH

11751



Torque Rod Assy

C-C	24		
BC-C	4	3/8	-
HD	80A		

INCLUDES
 QTY 1 11754
 QTY 2 13520

OEM
 A13102146A
 925030
 TR59-41375

Notes:

Arvin Meritor continued

13520



Torque Rod Bushing

OD	2 3/4 -	OEM A-2297-Y-77A 20-833PU R302226 R307639 C879 C879UB E-2226 E-4664 E-7639 D423
C-C	4 3/8 -	
BH	5/8 -	
HD	80A	

INCLUDED IN:
Several Kits

TOOLS 18551, 18833

Notes: 83520 - easy mount/ 13536 - no metal sleeve

13536



Torque Rod Bushing

OD	2 15/16 -	OEM A-2297-Y-77A 20-833PU R302226 R307639 C879UB E-2226 E-4664 E-7639 D423 321-132U
C-C	4 3/8 -	
BH	5/8 -	
HD	80A	

TOOL 18831

Notes: 83520 - easy mount/ 13520 - metal sleeve

13599



Pivot Bushing Kit

OD	5 15/16 -	OEM 2122663 A1225N1522 KIT11201 E-14347
ID	1 9/16 -	
LG	5 3/4 -	
HD	80A	

Notes: wear shims 13648 Included

17501



Camshaft Bushing

OD	1 7/8 -	OEM 1225-L-1208 E-5512 02-210
ID	1 1/2 -	
LG	1 3/16 -	
HD	71D	

Notes:

17504



Camshaft Bushing

OD	1 7/8 -	OEM 1225-B-834 02-242
ID	1 5/8 -	
LG	1 1/8 -	
HD	71D	

Notes:

17529



Camshaft Bushing

OD	2 1/2 -	OEM 1225-R-1058 E-2361
ID	1 1/2 -	
LG	1 3/4 -	
HD	71D	

Notes:

17538



Camshaft Bushing

OD	1 7/8 -	OEM 1225-N-378 E-536
ID	1 1/2 -	
LG	1 1/2 -	
HD	71D	

Notes:

17574



Camshaft Bushing

OD	2 3/16 -	OEM A 1225-V-438
ID	1 1/2 -	
LG	7/8 -	
HD	71D	

Notes:

8 Arvin Meritor continued

t
wt
s

18010



Shock Absorber Bushing

OD	1 1/2 -	OEM 415015-001 401754 PL 1026
ID	3/4 -	
LG	15/16 -	
HD	B0A	

Notes:

18439



Camshaft Bushing

OD	1 7/8 -	OEM 1225-X-804 E-2551
ID	1 1/2 -	
LG	111/16 -	
HD	710	

Notes:

18991



Camshaft Bushing

OD	2 -	OEM 1225-R-1058 E-2361
ID	1 1/2 -	
LG	1	
HD	71D	

Notes:

34514



Torque Rod Bushing Green

OD	3 -	OEM 1225-R-1370 202815-3 A-1225-L-1416 M302500 PB00-36314
OD<	2 1/4 -	
ID	1 1/2 -	
LG	1 7/16 -	
HD	90A	

INCLUDED IN:
50033

Notes: used in Arvin Meritor Kit 11102

40074



Carrier Bearing Assy

ID	2 3/8 -	OEM 210661-1X CB2106611XSA DS-6049
C-C	8 1/2 -	
BH	1/2 -	
HGT	3 21/64 -	
HD	70A	

Notes: includes carrier bearing bushing 18002

40075



Carrier Bearing Assy

ID	2 -	OEM CB210121-1X CB2101211XSA CCB101 DS-6048
C-C	7 7/16 -	
BH	1/2 -	
HGT	2 25/32 -	
HD	70A	

Notes: includes carrier bearing bushing 18725

50031



Torque Rod Bushing

OD	2 3/8 -	OEM A1225-G-1437 SU99-39113
ID	7/8 -	
LG	3	
HD	B0A	

INCLUDED IN:
50032

Notes: only available in kits not sold individually

50032



Control Arm Bushing Kit

OD	2 3/8 -	OEM 1225-R-1370 A-1225-L-1416 FRK0510030 KIT11126 2 KIT11300 334-1674 SU99-39114 SU99-39116
ID	7/8 -	
LG	3	
HD	B0A	

INCLUDES

QTY 4	50031
QTY 4	Bolt 1/2", -UNCx6"G8
QTY 2	Pivot Washer 3"x, 1/4"x1/2"
QTY 4	Lock Nut 1/2", UNC
QTY 8	Thrust Washer 7/16"
QTY 8	Flat Washer 1/2"

TOOL 50034

Notes: see tech tip 01 577 9020 & 01 577 9024

Arvin Meritor continued

50033



Torque Rod Bushing

INCLUDES
 QTY 2 34514
 QTY 1 Pivot Bolt 1/2" - 16 UNFx 6 G8
 QTY 1 Lock Nut 1/2"
 QTY 1 Flat Washer 1/2"
 QTY 1 Sleeve 1 1/2"x1/ix3"

OEM
 KIT11126
 E-11763
 334-1672
 TRK4931
 PB00-26422
 SU99-39115

Notes: coming soon call tech department

83520



Easy-Mount Torque Rod Bushing

OD 2 3/4 -
C-C 4 3/8 -
BH 5/8 -
HD 80A

TOOLS 18551, 18833

OEM
 A-2297-Y-77A
 20-833PU
 R302226
 R307639
 C879
 C879UB
 E-2226
 E-4664
 E-7639
 D423

Notes: standard -13520 / no metal sleeve -13536

Autocar

DESCRIPTION	OEM	ID	PAGE
Auxiliary Load Spring	60314000 / 64179004 / HS99 / E-14047 / 334-1720 / MHS225K LP50-24974	13611	7
Bolster Spring Kit	64179004 / R309410 / HS99 / E-11496 / E-14047 / D2003 / 334-1720 / 334-852 / MHS225K / LP50-24974	13722	8
Carrier Bearing Assy	210661-1X / DS-6049	40074	8
Easy-Mount Torque Rod Bushing	34013-088L / 20-859 / R309326 / BP-87 / BP-88 / E-9326 / 334-831 / 09-5525 / BP200	83596	8
Motor Mount	12005-3207	12304	7
Motor Mount	12005 3208	12305	7
Torque Rod Assy	35801-0033 / 358010-560 / R9247 / TR13-41022 / 924711	13657	7
Torque Rod Assy	A3580010-635 / S3580001-635 / S3580003-635 / TR59-41150	13679	8
Torque Rod Assy	3187322/75-1709/VT20/ E-8821 / 345-219/ 345-898/R531 / R63/TR96-41068	18860	8

12304



Motor Mount Front

THK 2 1/16 -
WD 3 1/2 -
LG 10 -
C-C 4 -
BC-C 8 9/16 -
BH 5/8 -
HD 72D-80A

OEM
 12005-3207

Notes:

12305



Motor Mount Front (Upper)

OD 2 13/16 -
D 5/8 -
HGT 1 1/16 -
HD 80A

OEM
 12005 3208

Notes:

13611



Auxiliary Load Spring

OD 4 1/16 -
WD 5 1/8 -
LG 5 -
HD 80A

INCLUDED IN:
 13722

OEM
 60314000
 64179004
 HS99
 E-14047
 334-1720
 MHS225K
 LP50-24974

Notes:

13657



Torque Rod Assy

C-C 22

INCLUDES
 QTY 1 13629
 QTY 1 13520
 QTY 1 13518

OEM
 35801-0033
 358010-560
 TMR9247
 TR13-41022
 924711

Notes:

Autocar continued

13679



LG' 8 1/16 -
C-C 25 -
BC-C 4 3/8 -
BH 5/8 -
HD BOA

INCLUDES
QTY 1 13680
QTY 1 13518
QTY 1 13520

OEM
A3580010-635
S3580001-635
S3580003-635
TR59-41150

Torque Rod Assy

Notes:

13722



INCLUDES
QTY 2 13601
QTY 1 13611
QTY 16 Bolts 7/16x 1 1/2 UNF
QTY 16 Lock Nuts 7/16 UNF
QTY 32 Flat Washer 7/16

OEM
64179004
R309410
HS99
E-11496
E-14047
D2003
334-1720
334-852
MHS225K
LP50-24974

Bolster Spring Kit

Notes: 2 kits per truck/ recommended to replace set in same repair/ don't mix brands / see tech tip 01 577 9038

18860



C-C 22 1/8 -
BC-C 4 3/8 -
BH 5/8 -
HD BOA

INCLUDES
QTY 1 18859
QTY 2 13520

OEM
3187322
75-1709
VT20
E-8821
345-219
345-898
TMR531
TMR63
TR96-41068

Torque Rod Assy

Notes:

40074



ID 2 3/8 -
C-C 8 1/2 -
BH 1/2 -
HGT 3 21/64 -
HD 70A

OEM
210661-1X
DS-6049

Carrier Bearing Assy

Notes: Includes carrier bearing bushing 18002

83596



OD 4 3/8 -
C-C 8 1/2 -
BH 1 1/16 -
HD BOA

OEM
34013-088L
20-859
R309326
BP-87
BP-88
E-9326
334-831
09-5525
BP200

Easy-Mount
Beam End Bushing

TOOL 18542, 13588

Notes: easy mount/ standard - 13596 / no shims required - 13607

Chalmers

DESCRIPTION	OEM	TRETT ID	PAGE
Load Spring	15002 / R304685 / CHA03 / E-4685 / 325-156 / MLC11 / LP19-24002	11740	10
Torque Rod Bushing	22082 / 22128 / R308701 / CHA22 / E-7427 / E-8701 / D187 / 321-274 / TRB6328 / TH19-22128	18919	10
Torque Rod Bushing	22129 / R304678A/ R308702 / CHA23 / E-8702 / D187 / 321-274 / TH19-22129	18920	10
Torque Rod Bushing	800009 / R307767 / R308917 / CHA53 / E-7767 / E-8917 / D188 / 321-277 / TRB8645 / PL 1049	18921	10
Torque Rod Bushing	800010 / R307766 / CHA54 / E-7426 / E-7766 / D186 / 321-276 / TRB8644 / 1515966C1 / TH19-22010	11739	10

**STEMCO GAFF replacement parts compatible with:
CHALMERS™ 700 SERIES, 800 SERIES**

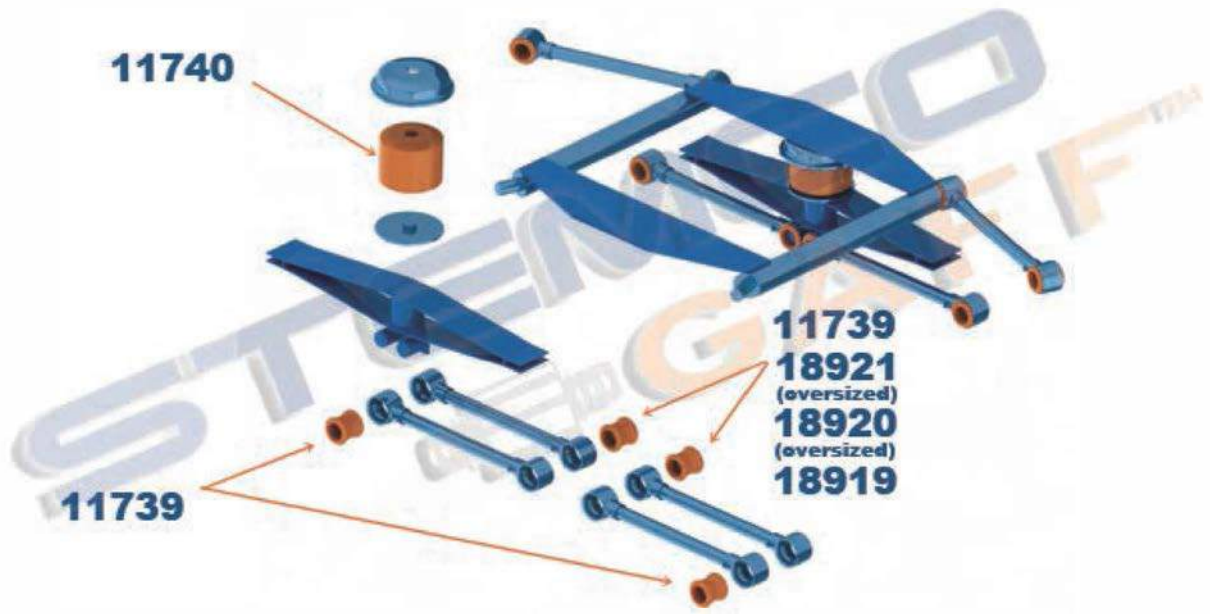

**STEMCO GAFF replacement parts compatible with:
CHALMERS™ 1000 SERIES**



Chalmers continued

11739



Torque Rod Bushing

OD	4 1/4 -
OD<	3 1/2 -
ID	2 9/16 -
LG	4 3/16 -
HD	BOA

OEM
800010
 R307766
 CHA54
 E-7426
 E-7766
 D186
 321-276
 TRB8644
 1515966C1
 TH19-22010

Notes: 16 per suspension / longer life single piece design

11740



Load Spring

OD	9 1/4 -
D	2
LG	8
HD	BOA

OEM
15002
 R304685
 CHA03
 E-4685
 325-156
 MLC11
 LP19-24002

Notes:

18919



Torque Rod Bushing

OD	3 5/8 -
OD<	3 7/64 -
ID	2 3/8 -
LG	3 3/4 -
HD	BOA

OEM
22082
22128
 R308701
 CHA22
 E-7427
 E-8701
 0187
 321-274
 TRB6328
 TH19-22128

Notes: oversized - 18920

18920



Torque Rod Bushing Oversized

OD	3 5/8 -
OD<	3 11/64 -
ID	2 3/8 -
LG	3 3/4 -
HD	BOA

OEM
22129
 R304678A
 R308702
 CHA23
 E-8702
 0187
 321-274
 TH19-22129

Notes: oversized application / regular -18919

18921



Torque Rod Bushing Oversized

OD	4 1/2 -
OD<	3 9/16 -
ID	2 1/2 -
LG	4 1/4 -
HD	BOA

OEM
800009
 R307767
 R308917
 CHA53
 E-7767
 E-8917
 D188
 321-277
 TRB8645
 PL 1049

Notes: oversized application

Ford

DESCRIPTION	OEM		PAGE
Beam End Adapter Kit	E3HZ5A646A / 20-801 / R309420 / HAK44 / E-9420 / 334-127 / 334-467 / 09-5462 / HAK112 / AK38200	13609	14
Beam End Bushing	TWAA5873A / 20-809PU / R309511 / C865 / E-9511 / 0404 / 321-120 / M1724 / M1976 / EB34000	13501	13
Beam End Bushing	B8QH5873A / 20-810PU / R302771 / C871 / E-9512 / D402 / 321-242 / M1726 / M1988 / EB38000	13553	14
Camshaft Bushing	B8QH2237A / E-5512 / 02-210	17501	16
Carrier Bearing Assy	D4TZ4800J / OS-6049	40074	17

Ford continued

DESCRIPTION	OEM		PAGE
Carrier Bearing Assy	D4TZ4800G / DS-6048	40075	17
Center Bushing	TWAA5872A / R309520 / 20-816 / C864 / E-9520 / D403 / 321-119 / M1725 / M1978 / CB34012	13500	13
Center Bushing	TALAA5872A / 20-817 / R309359 / C887 / E-9359 / D401 / 321-243 / M1727 / M1972 / CB38012	13505	14
Center Bushing	C9HS5872A / R301594 / C866 / E-1594 / D403 / 321-118 / 09-5620 / CB34010 / CB34011	13537	14
Center Bushing	C9HS5872A / 20-820 / R309510 / C888 / E-9510 / D401 / 321-244 / M1980 / CB38010 / CB38011	13543	14
Equalizer Bushing	E4HZ5872A / R305269 / R309401 / C868 / E-9401 / D425 / 321-245 / 09-5017 / TRB5168 / CB27500	13526	14
Load Pad	C3TZ5899B / 20-824 / R309513 / LC3 / E-9513 / D135 / 325-103 / 325-104 / M2062 / MLC4 / MLC8 / HC20000	13650	15
Motor Mount	DOHZ6068B / 30-1384PU / R308918 / UM207 / E-8918 / D430 / 329-150U / M20304 / M20304UB / PL1048	10075	12
Motor Mount	CSTZ6038B / E1 HZ5038A	11022	12
Motor Mount		12323	13
Motor Mount		17285	16
Motor Mount	CSTZ6068B / EM-2752	18433	16
Motor Mount	D3HA-6038-AA / D3HZ6038A / M203031	18694	16
Motor Mount	4C40-6038-AA / 4C4Z6038A / MM55-623C3 / MM55-624C3	34509	17
Motor Mount Kit	4C40-6038-AA / 4C4Z6038A / MM55-623C3 / MM55-624C3	34526	17
Motor Mount Kit	4C4Z6068BA	34529	17
Overload Cushion	D2HS5732AA / 20-823 / R309514 / LC4 / E-9514 / D134 / 325-100 / M2061 / MLC10 / HC10000	13649	15
Shock Absorber Bushing	1T18197A / SB03-83008	30507	16
Spring Bushing	16-17769-00 / 680-322-01-05 / 680-322-01-50 / RB211 / RB233 / RB-211 / RB-233 / SP46-52800	11066	12
Spring Bushing	E4HZ5873A / 20-843 / R309566 / C886 / E-9566 / D426 / 323-167 / M3784 / TRB5911 / EB27500	13512	14
Spring Bushing	BF85781B / F2UA-5781-CD / F2UZ-5781-CD / F81A-5781-BA / RB198 / RB-198 / MR642 / SP43-11198	17275	15
Spring Bushing	BF85781A / F81A-5781-CA	17276	15
Spring Bushing Kit	C2TZ5780B / C2TZ5781A / DOHZ5780B / DOHZ570800B / B1442-55 / E694-55 / IS620 / 334-964 / MIS1486 / SP55-113C1	19001	16
Spring Mount	58918-000 / 593461 / 58918-000	18994	16
Spring Pin Bushing	W300861 / 10-1010 / R308804 / RB260 / E-8804 / D46 / RB-234 / RB-268 / MR664 / UB20500	11005	12
Spring Pin Bushing	16-14603-000 / 16-17194-000 / 16-17770-000 / 16-18023-000 / RB263 / RB-263 / MR772 / MR772UB / SP46-11023	11094	13
Spring Pin Bushing	FH4Z5560B / 50-275 / TB68 / 327-434 / 50-275 / TB-68 / M5212 / SP59-11010	11758	13
Stabilizer Bar Bushing	D9TZ-3B283-A	17250	15
Stabilizer Bar Bushing	C5TZ-3B-203B / COAZ-5719-A / F2VZ-5K486-A / R210600	17251	15
Stabilizer Bar Bushing	TAR-411-041	17279	16
Torque Rod Assy	32271-102 / 48411-006 / 50376-001 / 62007-365 / E-9394 / E-9409 / 345-734 / 345-792 / 345-815 / TRS0-41102	13735	15
Torque Rod Bushing	932244694 / M2069	11556	13
Torque Rod Bushing	C3TZ4613C	11716	13
Torque Rod Bushing	932246735 / R309518 / C884 / E-2815 / E-9518 / D293 / 321-136 / 09-5719 / TRB6119 / 38000	12031	13
Torque Rod Bushing	E1 HT5781EA / 55-130 / R305276 / R208 / E-3362 / E-5276 / 321-162 / 09-2497 / TRB6025 / TH50-22692	14010	15
Vertical Drive Bushing	C3TZ54599A / C3TZ5A598A / R309515 / C874 / E-9515 / D107 / 321-125 / 09-5535 / TRB5170 / HV38000	13592	14

STEMCO GAFF replacement parts compat'ible with:

**HENDRICKSON®-AIRTEK®/WESTERN STAR®/
FREIGHTLINER® / FORD® / STERLING®**



10075

OD	3	-
ID	1 1/2	-
LG	3	-
BH	BOA	-

OEM
DOHZ6068B
30-1384PU
R308918
UM207
E-8918
D430
329-150U
M20304
M20304UB
PL 1048

Motor Mount Rear
TOOL 11076

Notes: metal sleeve

11005

OD	2 1/2	-
LG	7 1/2	-
C-C	5 3/4	-
BH	13/16	-
HD	BOA	-

OEM
W300861
10-1010
R308804
RB260
E-8804
D46
RB-234
RB-268
MR664
UB20500

Spring Pin Bushing
Tool 11069

Notes:

11022

THK	1	1/8	-
WD	2	5/16	-
LG	8	1/8	-
BH		9/16	-
BH2		3/4	-
HD	BOA		-

OEM
C8TZ6038B
E1HZ5038A

Motor Mount

Notes:

11066

OD	2	1/4	-
ID		13/16	-
LG	4	1/4	-
BH	BOA		-

OEM
16-17769-00
680-322-01-05
680-322-01-50
RB211
RB233
RB-211
RB-233
SP46-52800

Spring Bushing

Notes:

Ford continued

11094



Spring Pin Bushing

OD	2 1/4 -
OD<	1 1/4 -
LG	6 7/8 -
HD	80A

OEM
 16-14603-000
 16-17194-000
 16-17770-000
 16-18023-000
 RB263
 RB-263
 MR772
 MR772UB
 SP46-11023

Notes:

11556



Torque Rod Bushing

OD	2 11/16 -
C-C	4 3/8 -
BH	5/8 -
HD	80A

OEM
 932244694
 M2069

Notes: verify dimensions compare to 13522 and 83522

11716



Torque Rod Bushing

OD	5 7/16 -
OD<	4 7/8 -
ID	4 3/16 -
LG	4 3/8 -
HD	80A- 72D

OEM
 C3TZ4613C

Notes:

11758



Spring Pin Bushing

OD	1 3/4 -
C-C	5 3/4 -
HD	80A

OEM
 FH4Z5560B
 50-275
 TB68
 327-434
 50-275
 TB-68
 M5212
 SP59-11010

INCLUDED IN:
 11757

TOOL40090

Notes:

12031



Torque Rod Bushing

OD	2 3/4 -
LG	7
THR	1 1/4 - 12 UNF
HD	80A

OEM
 932246735
 R309518
 C884
 E-2815
 E-9518
 D293
 321-136
 09-5719
 TRB6119
 TM38000

INCLUDED IN:
 12042, 12072

Notes:

12323



Motor Mount

THK	2 3/4 -
WD	3 3/4 -
ID	1 1/2 -
HD	70A - 71D

OEM

Notes:

13500



Center Bushing

OD	3 5/8 -
OD<	2 3/4 -
LG	12
HD	80A

OEM
 TWAA5872A
 R309520
 20-816
 C864
 E-9520
 D403
 321-119
 M1725
 M1978
 CB34012

INCLUDED IN:
 13503, 13504, 13591

TOOLS 18543, 18544

Notes:

13501



Beam End Bushing

OD	4 3/8 -
ID	2 1/2 -
LG	5 1/4 -
HD	80A

OEM
 TWAA5873A
 20-809PU
 R309511
 C865
 E-9511
 D404
 321-120
 M1724
 M1976
 EB34000

INCLUDED IN:
 13503, 13504

TOOLS 13564, 18541, 18542

Notes: for complete repair use adapter 13502 / additional tool suggestion 13588

Ford continued

13505



Center Bushing

OD	4 3/4 -
OD<	3 1/2 -
LG	12
HD	BOA

INCLUDED IN:
13508, 13548, 13587

TOOLS 13570, 18539, 18540

OEM
TALAA5872A
20-817
R309359
C887
E-9359
D401
321-243
M1727
M1972
CB38012

Notes: standard-welded plug/ double bonded-welded plug - 13636 / standard-loose plug-13543

13512



Spring Bushing

OD	2 3/8 -
ID	7/8 -
LG	3 1/8 -
HD	BOA

OEM
E4HZ5873A
20-843
R309566
C886
E-9566
D426
323-167
M3784
TRB5911
EB27500

Notes:

13526



Equalizer Bushing

OD	2 3/4 -
ID	1
LG	4 5/8 -
HD	BOA

OEM
E4HZ5872A
R305269
R309401
C868
E-9401
D425
321-245
09-5017
TRB5168
CB27500

Notes:

13537



Center Bushing

OD	3 5/8 -
ID	2
LG	10 1/2 -
HD	BOA

OEM
C9HS5872A
R301594
C866
E-1594
D403
321-118
09-5620
CB34010
CB34011

Notes: no plug /verify dimensions/ compatible with Raydan

13543



Center Bushing
Loose Plug

OD	4 3/4 -
ID	2 1/2 -
LG	12
HD	BOA

OEM
C9HS5872A
20-820
R309510
C888
E-9510
D401
321-244
M1980
CB38010
CB38011

Notes: 13505 for welded end plug option/ New suggested tools 13570, 18539, 18540

13553



Beam End Bushing

OD	4 3/8 -
ID	2 1/2 -
LG	5 3/4 -
HD	BOA

INCLUDED IN:
13587

TOOLS 13563, 13588

OEM
B8QH5873A
20-810PU
R302771
C871
E-9512
D402
321-242
M1726
M1988
EB38000

Notes: uncrimped sleeve double bonded bushing/ supersedes 13506 / use adapter 13507 for complete repair/ additional tool suggestion 13595

13592



Vertical Drive Bushing

OD	4 1/8 -
ID	2
LG	4
HD	80A

OEM
C3TZ54599A
C3TZ5A598A
R309515
C874
E-9515
D107
321-125
09-5535
TRB5170
HV38000

Notes:

13609



Beam End Adapter Kit

OD<	3 1/2 -
LG	1 1/8 -
HD	811115-Steel

INCLUDED IN:
13566

OEM
E3HZ5A646A
20-801
R309420
HAK44
E-9420
334-127
334-467
09-5462
HAK112
AK38200

Notes: Supersedes 13540 / For use with 13506

Ford continued

13649



Overload Cushion

OD	7	-
ID	1	-
LG	4	-
HD	80A	-

OEM
D2HS5732AA
20-823
R309514
LC4
E-9514
D134
325-100
M2061
MLC10
HC10000

Notes:

13650



Load Pad

OD	6 3/4	-
ID	3 15/16	-
ID<THK	3 1/8	-
LG	4 1/16	-
HD	1115/16	-
	80A	

OEM
C3TZ5899B
20-824
R309513
LC3
E-9513
325-103
325-104
M2062
MLC4
MLCB

Notes:

13735



Torque Rod Assy

C-C	14 3/8	-
BC-C	4 3/8	-
BH	5/8	-

INCLUDES
QTY 2 13520

OEM
32271-102
48411-006
50376-001
62007-365
E-9394
E-9409
345-734
345-792
345-815
TR50-41102

Notes:

14010



Torque Rod Bushing

OD	2	-
ID	7/8	-
LG	3	-
HD	BOA	-

INCLUDED IN:
11795, 12397

OEM
E1HT5781EA
55-130
R305276
R208
E-3362
E-5276
321-162
09-2497
TRB6025
TH50-22692

TOOL 18836

Notes: New tool coming soon 40124

17250



Stabilizer Bar Bushing

OD	2 5/8	-
ID	7/8	-
LG	3 3/16	-
HD	80A-71D	-

OEM
D9TZ-3B283-A

Notes: Components not sold separately

17251



Stabilizer Bar Bushing

OD	115/16	-
ID	7/8	-
LG	215/16	-
HD	BOA	-

OEM
C5TZ-3B-203B
COAZ-5719-A
F2VZ-5K486-A
R210600

Notes: Components not sold separately

17275



Spring Bushing

OD	1 3/4	-
ID	41/64	-
LG	3 1/2	-
HD	80A	-

OEM
BF85781B
F2UA-5781-CD
F2UZ-5781-CD
F81A-5781-BA
RB198
RB-198
MR642
SP43-11198

Notes:

17276



Spring Bushing

OD	2 11/64	-
ID	23/32	-
LG	3 1/2	-
HD	80A	-

OEM
BF85781A
F81A-5781-CA

Notes:

Ford continued

17279



Stabilizer Bar Bushing

OD	2 5/8 -
OD<	2 5/16 -
ID	1 3/4 -
LG	2 3/4 -
HD	80A

OEM
TAR-411-041

Notes:

17285



Motor Mount

OD	4 -
OD<	3 1/2 -
ID	1 1/2 -
LG	3 -
HD	70A

OEM

Notes:

17501



Camshaft Bushing

OD	1 7/8 -
ID	1 1/2 -
LG	1 3/16 -
HD	71D

OEM
BBQH2237A
E-5512
02-210

Notes:

18433



Motor Mount

ID	13/16 -
THK	2 5/16 -
WD	3 3/16 -
LG	5 -
HD	80A

OEM
C8TZ6068B
EM-2752

Notes:

18694



Motor Mount

THK	1 5/16 -
WD	2 5/16 -
LG	8 3/16 -
C-C	6 -
BH	11/16 -
HD	80A

OEM
O3HA-6038-AA
O3HZ6038A
M203031

Notes:

18994



Spring Mount Rear

ID	13/16 -
WD	2 -
C-C	5 -
HD	EOA

INCLUDED IN:
13725

OEM
58918-000
593461
58918-000

Notes:

19001



Spring Bushing Kit

OD	1 1/2 -
ID	1 -
LG	3 -
HD	90A

OEM
C2TZ5780B
C2TZ5781A
D0HZ5780B
D0HZ570800B
81442-55
E694-55
IS620
334-964
MIS1486
SP55-113C1

Notes:

30507



Shock Absorber Bushing

OD	115/16 -
ID	1 -
LG	15/16 -
HD	80A

OEM
1T18197A
S803-83008

Notes:

Ford continued

34509



ID 11/16 -
 THK 2 -
 WD 4 3/16 -
 LG 4 1/16 -
 HD BOA
INCLUDED IN:
 34526

OEM
 4C40-6038-AA
 4C4Z6038A
 MM55-623C3
 MM55-624C3

Motor Mount Front

Notes: Components not sold separately

34526



INCLUDES
 QTY 2 34509
 QTY 2 Bolt 3/4" x 31/, GB
 QTY 2 Lock Nut y;
 QTY 4 Flat Washers 3/4.

OEM
 4C40-6038-AA
 4C4Z6038A
 MM55-623C3
 MM55-624C3

Motor Mount Kit Front

Notes:

34529



WD 4 3/4 -
 LG 4 7/16 -
 HGT 311/16 -
 HD 70A

OEM
 4C426068BA

Motor Mount Kit Rear

Notes: bracket not included/ reuse original bracket for repair

40074



ID 2 3/8 -
 C-C 8 1/2 -
 BH 1/2 -
 HGT 3 21/64 -
 HD 70A

OEM
 D4TZ4800J
 DS-6049

Carrier Bearing Assy

Notes: Includes carrier bearing bushing 18002

40075



ID 2 -
 C-C 7 7/16 -
 BH 1/2 -
 HGT 2 25/32 -
 HD 70A

OEM
 D4TZ4800G
 DS-6048

Carrier Bearing Assy

Notes: Includes carrier bearing bushing 18725

Freightliner

DESCRIPTION	OEM	ITEM #	PAGE
Beam End Bushing	NEW 90008139 / WCM 10050 / 60-1535 / R304382A/ N120 / E-8683 / D441 / 321-229 / TRB5713 / PB57-21139	14513	44
Beam End Bushing	HLD90008149 / WCM11223 / 60-1501 / R304410A/ N124 / E-4410A/ D448 / 321-231 / TRB5703 / PB57-21149	14533	44
Bolster Spring Kit	HDR 64179 037 / HS130 / E-14044 / E-14374 / 334-1727 / 334-1845 / MLC3 / MLC5 / LP50-24179	13626	42
Cab Mount	7007-05	11007	32
Cab Mount	681-891-00-01 / A681-891-00-01 / LORSB33310017A / CM46-61891 / 10-1067PU	11008	32
Cab Mount	681-890-00-01 / A681-890-00-01 / LORSB33310017B / CM46-61890	11009	33

Freightliner continued

DESCRIPTION	OEM	Part #	PAGE
Cab Mount		11012	33
Cab Mount		11023	34
Cab Mount	18-44009-000 / 18-45384-000 / BJ-1769	11075	35
Cab Mount	680-891-04-01 / 68-08910-401	11111	38
Cab Mount	HUN 12004 3401 / J7165-1 / 35-548PU / R307472 / E-7472 / 06 / 329-136U / M17412 / MM96-62401 / PL 1015	11520	40
Cab Mount	HUN 12004 3401 / J7165-1 / 35-548PU / R307472 / E-7472 / 06 / 329-136U / M17412 / MM96-62401 / PL 1015	11523	40
Cab Mount	CBA28-1050 / 35-569PU / R307506 / E-7506 / 04 / 0540 / 329-163U / M17804UB / PL 1070 / PL 1105	11707	41
Cab Mount Kit	681-890-00-01 / 681-891-00-01 / A681-890-00-01 / A681-891-00-01 / LORSB33310017A/ LORSB33310017B / CM46-61001	11086	36
Cab Mount Kit		11092	36
Cab Mount Kit	1844009000 / 1845384000 / 18-44009-000 / 18-45384-000 / BJ-1769 / CM46-61384	11110	38
Carrier Bearing Assy	SP2106611X/ DS-6049	40074	46
Carrier Bearing Assy	TOA CCB101 / DS-6048	40075	46
Clutch Bar Bushing	11118 / MS46-29002	11118	39
Deflector Pad	A 16-15303-000 / A 16-15773-000	31624	45
Easy-Mount Torque Rod Bushing	151087-148 / 20-832PU / R307638 / FL55 / E-7638 / 321-131 / M2069 / TRB6164 / TS34000 / TS34095	83522	45
Equalizer Bushing	16-13568-000 / A16-10549 / 10-1007PU / R303540A/ FL5 / E-3540A/ 049 / 322-138 / TRB5906 / PL 1054	11000	31
Equalizer Bushing	16-10549-000 / 16-13568-000 / A16-10549 / 10-1007PU / R303540A/ E-3540A/ 049 / 334-492 / TRB5906 / PL 1054	11064	34
Exhaust Mount	04-17003-000 / M46730	30504	45
Fifth Wheel Bushing	FON BSH 109 L / FW99-32109 / FW99-32172	10079	31
Fifth Wheel Bushing	HLD XB 0011 / FW51-32011	18215	44
Fifth Wheel Bushing	HLD XB 0009 / KP116	18221	44
Fifth Wheel Bushing	HLD-XB10605 / FW99-32605	40035	46
Fuel Tank Cap Gasket		11070	35
Fuel Tank Gasket		11120	39
Hood Guide	A17-13666-000 / HLK2005	11124	39
Hood Guide	A17-15140-000	11145	39
Hood Guide Bushing	A17-10464-001 / D102 / 329-199U / M17331 / M17331UB / PL 1051	11020	33
Hood Hinge		11098	37
Hood Hinge Bushing	J17700-5 / PL 1133	11019	33
Hood Hinge Bushing		11056	34
Hood Hinge Bushing	CB1121-10 / 40-312 / D542 / 329-205U / PL 1107	11544	40
Hood Latch	17-12434-000	11096	37
Hood Latch	8574FL	11097	37
Hood Latch	17-12434-000	11102	37
Hood Latch	680-880-01-60	11103	37
Hood Latch	17-12435-000 / HLK1011	11104	37
Hood Latch	17-12435-001 / HLK1012	11105	37
Hood Latch	17-15553-001 / HLK1020	11106	37
Hood Latch	17-15553-000 / HLK1019	11107	38
Hood Latch	17-14781-000 / HLK2001	11109	38
Hood Latch	680-880-01-60	12365	42
Hood Latch Assy	HLN1002	10506	31
Hood Latch Assy	17-12438-000 / HLK1024	11134	39
Motor Mount	J6210-41 / J6210-49 / 30-1357PU / R307484 / UM1328 / E-7484 / D41 / 329-133U / PL 1110	10020	31

Freightliner continued

III
J
S:
CAN
110

DESCRIPTION	OEM	Illustration	PAGE
Motor Mount	A01-11166-000 / R307430 / E-7430 / 329-115U / M17328 / M17328UB / PL 1052	11013	33
Motor Mount		11014	33
Motor Mount		11015	33
Motor Mount	01-15047-000 / LOR553310017 / LOR553310018 / 55B3310017 / 55B3310018 / MM46-62003	11018	33
Motor Mount		11054	34
Motor Mount	J20941-3 / J20941-6 / LOR J20941 6 / LOR J20941 7 / MM46-62416	11065	34
Motor Mount	BCD 267041 / BCD 27651 3 / BCD 27651-1 / BCD 27651-2 / BCD 28945-1 / BCD267041 / BCD276511 / BCD276512 / BCD276513 / BCD289451 / MM46-62002	11090	36
Motor Mount	17-1843	11095	36
Motor Mount		11112	38
Motor Mount	J6198-2 / 35-549PU / R307469 / UM1157 / E-7469 / D432 / D7 / 329-194U / M17406 / PL 1013	11537	40
Motor Mount	J6198-2 / 35-549PU / R307469 / E-7469 / D432 / D7 / 329-159U / 329-194U / M17406 / PL 1013	11613	41
Motor Mount	CBA-24-650-17 / 10-1059PU / R307431 / E-7431 / D48 / 329-116U / M17330 / M17330UB / PL 1003	11725	41
Motor Mount	C8TZ6068B / EM-2752	18433	44
Motor Mount Kit	BCD 267041 / BCD 27651 3 / BCD 27651-2 / BCD 28945-1 / BCD267041 / BCD276511 / BCD276512 / BCD276513 / BCD289451 / MM46-62002	11074	35
Motor Mount Kit	BCD 27330 / BCD 27330-1 / BCD 27330-2 / BCD 288051 / BCD267012 / BCD27330 1 / BCD27330 2 / BCD27651-1 / MM46-62001 / MM46-62051 / MM46-62301	11077	35
Motor Mount Kit	CBA-24-650-17 / 10-1059PU / UM324 / E-7431 / D48 / 329-116U / M17330UB / PL 1003	11085	35
Motor Mount Kit	01-15047-000 / LOR553310017 / LOR553310018 / 55B3310017 / 55B3310018 / MM46-62003	11087	36
Motor Mount Kit	J20941-3 / J20941-6 / J20941-7 / LOR J20941 6 / LOR J20941 7 / MM46-62416	11088	36
Motor Mount Kit	BCD 27330 1 / BCD 27330 2 / BCD 288051 / BCD267012 / BCD273301 / BCD273302 / BCD274772 / BCD288051 / MM46-62000	11089	36
Motor Mount Kit		11113	38
Motor Mount Kit	BCD274772 / M17445 / MM55-62005	34525	45
Pivot Bushing	RDW 1117680B060 / RDW 1117680B070 / 321-338 / 321-368 / RD1170 / RD1175 / PB85-36080	11711	41
Radiator Mount	05-16070-000	11021	34
Radiator Mount	A6805040382 / LOR 5M1035 9 / MBT A6805040382 / RM46-63359	11117	38
Radiator Mount	BCD 28721-1 / BCD 28847-1 / RM46-63471	11129	39
Radiator Mount	A 6805040382	11144	39
Radiator Mount	CB1121-10 / 40-312 / 40-354 / D542 / 329-205U / PL 1107	18837	45
Shackle	16-11890-000 / 16-11890-001 / 16-12302-000 / 16-12373-000 / 16-12399-000 / 16-13470-000 / A16-12301-000 / 81409-46 / E-8800 / 327-487	18600	45
Shifter Bushing Kit	FUL K-3399 / MS99-63399	11611	40
Shock Absorber Bushing	A1601005002 / 40-340 / R307529 / HB593 / E-7529 / D1 / 320-153 / M695 / MH1432 / PL 1026	18566	44
Spring Bushing	16-17769-00 / 680-322-01-05 / 680-322-01-50 / RB211 / RB233 / RB-211 / RB-233 / SP46-52800	11066	34
Spring Bushing		11123	39
Spring Mount	58918-000	18994	45
Spring Pin Bushing	16-13962-000 / 16-18035-000 / 681-325-01-50 / 681-325-02-50 / 10-1010 / R308804 / E-8804 / RB-268 / MR664 / UB20500	11005	32
Spring Pin Bushing	HR1-HB0S41 / HR1-HBUS-41 / E-9874 / D429 / RB-175 / MR596	11063	34
Spring Pin Bushing	16-16412-000 / 16-16412-001 / 16-18035-000 / 681-325-01-50 / RB268 / E-8804 / RB-268 / MR782 / PB46-26268 / UB20500-OS	11083	35

Freightliner continued

DESCRIPTION	OEM	QTY	PAGE
Spring Pin Bushing	16-14603-000 16-17194-000 16-17770-000 16-18023-000 / RB263 RB-263 MR772 / MR772UB SP46-11023	11094	36
Spring Pin Bushing		11775	41
Torque Rod Assy	16-16749-001 681-326-6716 / FL39 / 345-212 / 925000 / 943885 / R514 / TR46-41716	11078	35
Torque Rod Assy	16-16749-002 / 16-18972-000 681-326-72-16 / 345-868 / 947106 / TR030010040 / TR46-41002	11081	35
Torque Rod Assy	16-15632-000 16-18972-000 / 925050 / R536 / TR46-41000	11152	40
Torque Rod Assy	16-16749-000 / 681-326-6316 / FL42 / E-8808 / 345-213 / 943886 / R515 / ITR46-41316	11153	40
Torque Rod Assy	6813262065 68-13262-065 / 925030 / TR59-41375	11751	41
Torque Rod Assy		11777	41
Torque Rod Assy	IPC928661 / MR661 / UR661 / E-2642	12044	41
Torque Rod Assy	HDR 62010 455 / TR50-42455	12396	42
Torque Rod Assy	681-326-70-16 ITR59-41150	13679	42
Torque Rod Assy	HDR 62350 615 / TR50-41615	13733	43
Torque Rod Assy	HDR 62350 645 / TR50-41645	34555	45
Torque Rod Assy	681-326-2516 HDR 62001 590 HDR62000 590 / 924920 / 942174 / 944160 / 944220 / 948574 / TR50-42590	34556	45
Torque Rod Bushing	25508 119569111-09569-000 / FL63 E-1197 / 322-123 / M1788 / 09-6540	11001	32
Torque Rod Bushing	16-11351-000 A16-11351 / R303296 / FL6 / E-3296 D50 320-177U / M2857 / TRB6303 / PL1053	11002	32
Torque Rod Bushing	15-1087-148 / E-9395 / D421 / M3472 / TRB6164	11003	32
Torque Rod Bushing	A16-119448 / 20-836PU / R305275 / HS44 / E-5275 / D405 / 321-223 / 321-223U / TRB6185 / PL1146A	11004	32
Torque Rod Bushing		11006	32
Torque Rod Bushing	151087148 / M2069	11556	40
Torque Rod Bushing	A16-119448 / 20-836PU / R305275 / HS44 / E-5275 / D405 / 321-223 / TRB6185 / PL1146 / TS50-22691	13521	42
Torque Rod Bushing	151087-148 20-832PU / R307638 / C878 / E-7638 / D421 / 321-131 / TRB 164 / TS34000 / TS34095	13522	42
Torque Rod Bushing	J-142662	13525	42
Torque Rod Bushing	HDRR005422 / E-11763 / 334-1672 ITRK4931 / PB00-26422 SU99-39115	50033	46
Torque Rod Bushing Kit	REY TK19089 / R301983 / R003 E-1983 / E-9545 / 334-253 09-2360 / TRK6008 / TH83-22089 TH83-37997	15064	44
Torque Rod End Assy	IPC928610 / R3010310 R302639 / MR610 / E-10310 / 345-741 / 345-742 928610 / RU610 / TR71000	13683	43
Torque Rod End Assy	IPC928630 / MR630 / UR630 / 345-620 / 345-630 / 345-738 / 928630 / 09-5422 IRU620 / TR72000	13686	43
Torque Rod End Assy	IPC928660 / IPC928661 / R302642 / UR661 / E-2642 / 345-742 / 928661 / 09-5431 / RU661 ITR75000	13691	43
Torque Rod End Assy	IPC928680 / 20-9033 / MR680 / UR680 / E-2643 / 345-680 / 928680 / 09-5433 / R680 / TR76000	13694	43
Torque Rod End Assy	IPC928681 / 20-9023 / MR681 IUR681 / E-10317 / 345-681 / 928681 / 09-5426 / R681 / TR76000	13695	43
Torque Rod End Assy	IPC928690 / 20-9032 MR690 UR690 / 345-690 / 928690 / 09-5435 / R690 / TR77000	13696	46
Torque Rod End Assy	IPC928691 / 20-9022 / R302812 / MR691 / E-2812 / 345-691 / 928691 / 09-5429 / R691 / TR77000	13697	43
Torsion Spring Mount		12344	42
Transmission Bushing	11115	11115	38
Vibration Mount	LOR CB2202-12 / MS99-62620 / HLD XB 0011 / FW51-32011	18015	44



É

É

É



STEM.CO GAFF replacement parts compatible with:
HENDRICKSON®-AIRTEK®/WESTERN STAR® /
FREIGHTLINER® I FORD® / STERLING®



STEMCO GAFF replacement parts compatible with:
FREIGHTLINER® AIR LINER II 46,000 lb.

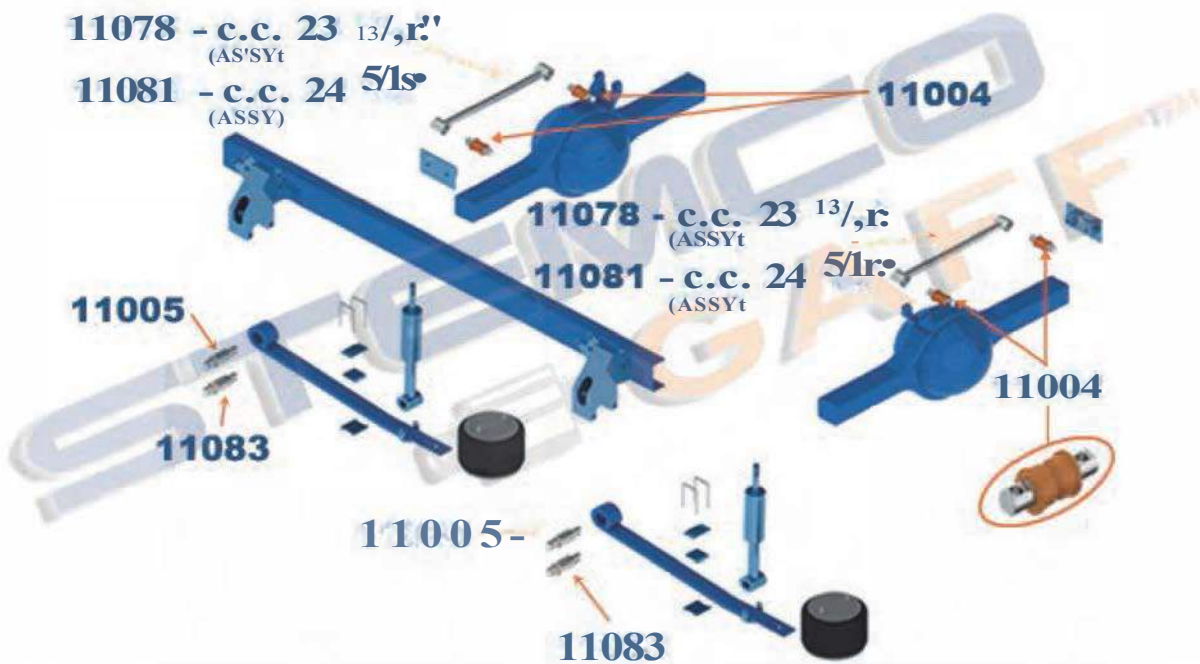

18

**STEMCO GAFF replacement parts compatible with:
FREIGHTLINER® AIR LINER II FAST II
38,000 & 40,000 lb.**

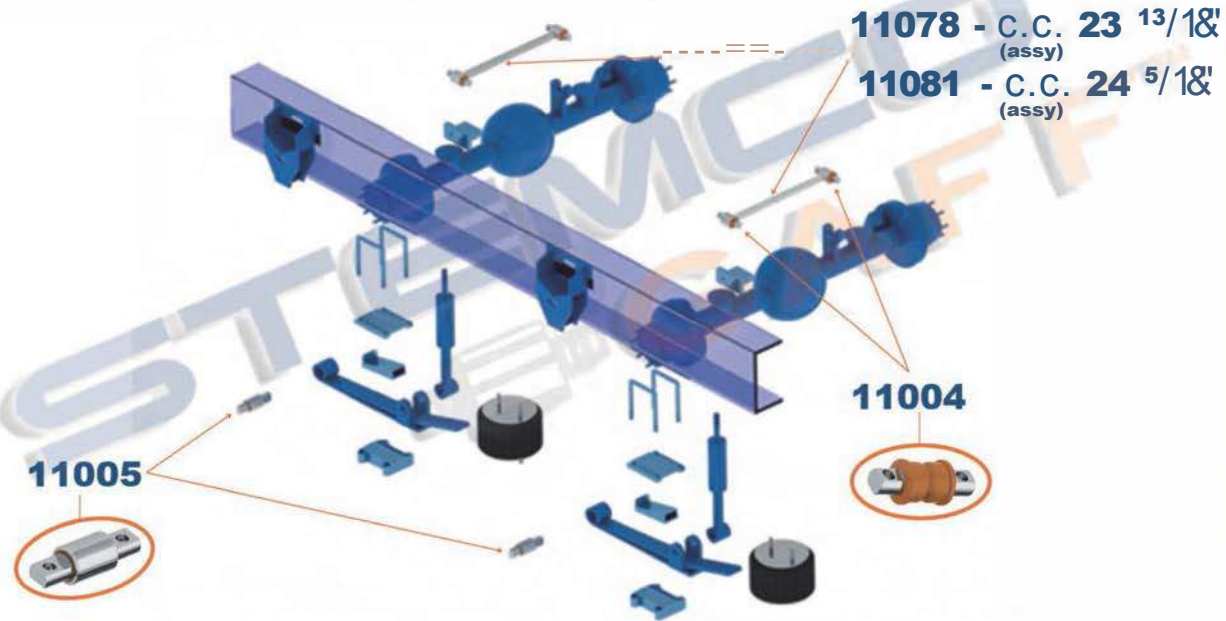

**STEMCO GAFF replacement parts compat'ible with:
FREIGHTLINER BUSINESS CLASS, CENTURY
MB-FL-50, MB-FL&O, MB-FL70, MB-FLBO, MB-FL106,
3" SPRING CENTURY CLASS 4" SPRING**



**STEMCO GAFF replacement parts compatible with:
FREIGHTLINER® CENTURY CLASS**



**STEMCO GAFF replacement parts compatible with:
FREIGHTLINER® - CENTURY CLASS/ COLUMBIA
MOTOR MOUNT**

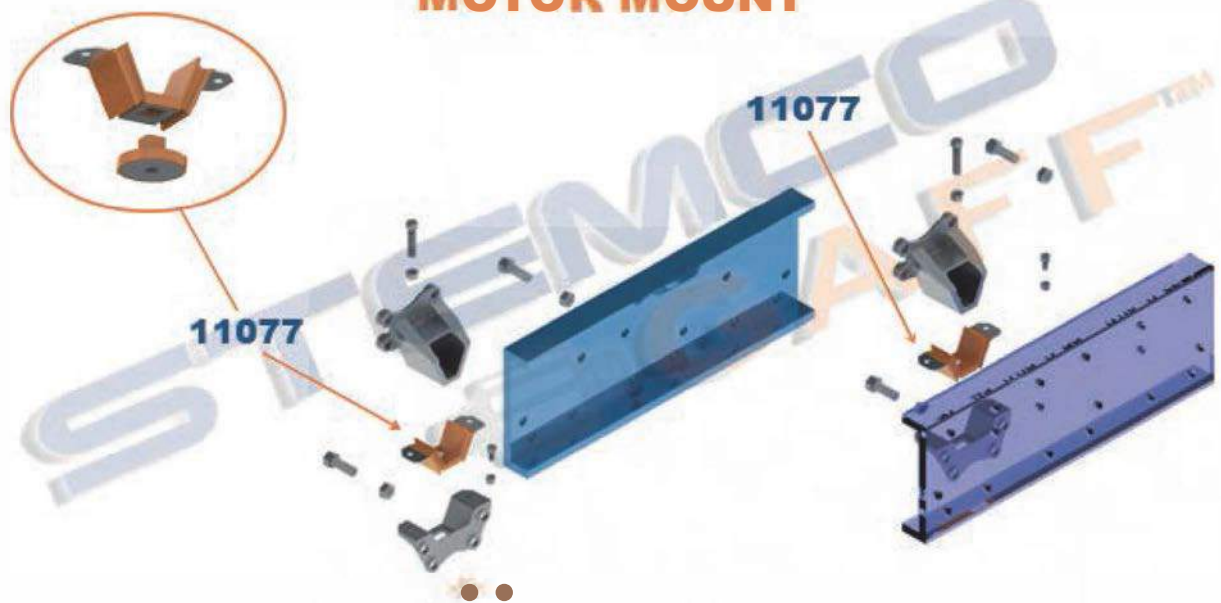

18

**STEMCO GAFF replacement parts compatible with:
FREIGHTLINER® CENTURY CLASS/ COLUMBIA
RADIATOR MOUNT**

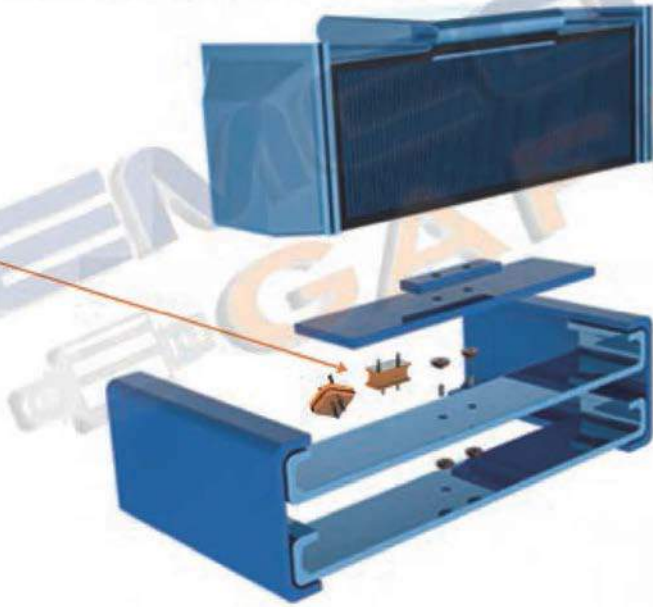

**STEMCO GAFF replacement parts compatible with:
FREIGHTLINER® ENGINE MOUNT**



**STEMCO GAFF replacement parts compatible with:
FREIGHTLINER® FAS I AIR RIDE**



**STEMCO GAFF replacement parts compatible with:
FREIGHTLINER® FAS II AIR RIDE**



18

**STEMCO GAFF replacement parts compa.l'ible with:
FREIGHTLINER® FASII AIR RIDE
SINGLE TANDEM**

11078 - C.C. 23 Bl&™
(assy)

11081 - C.C. 24 S/s•
(assy)

11005

11004



**STEMCO GAFF replacement parts compal'ible with:
FREIGHTLINER® FH32-36 FOUR SPRING**

11001

11006

11001

11006

11001

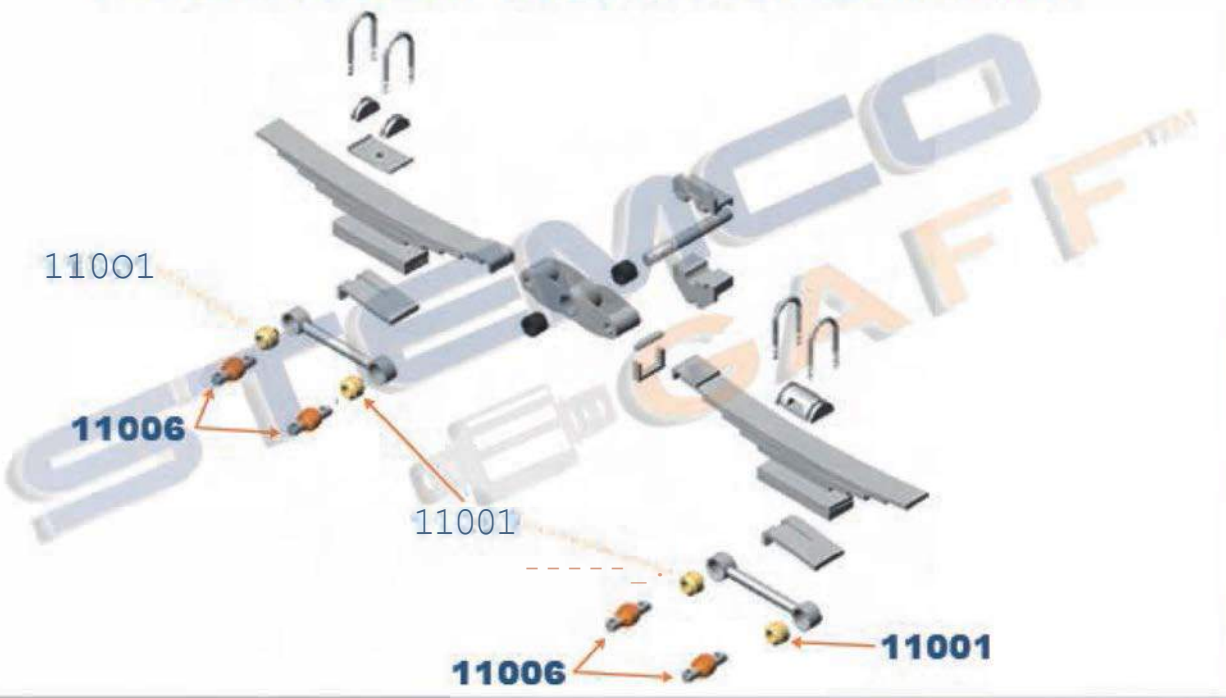

STEMCO GAFF replacement parts compatible with:
FREIGHTLINER® FH34

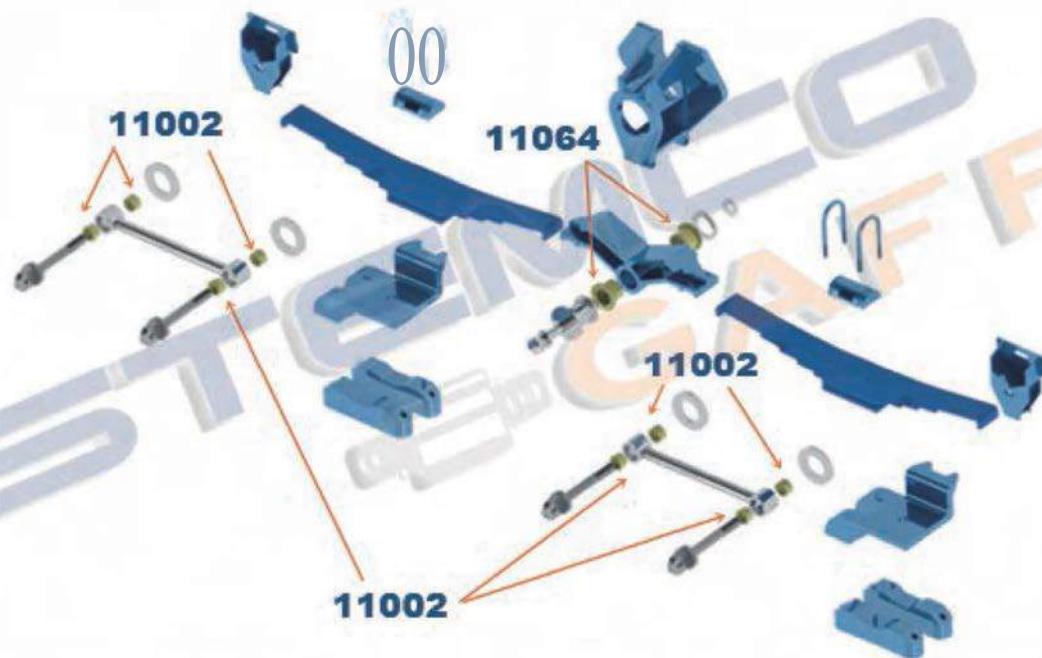

STEMCO GAFF replacement parts compatible with:
FREIGHTLINER® FH34A

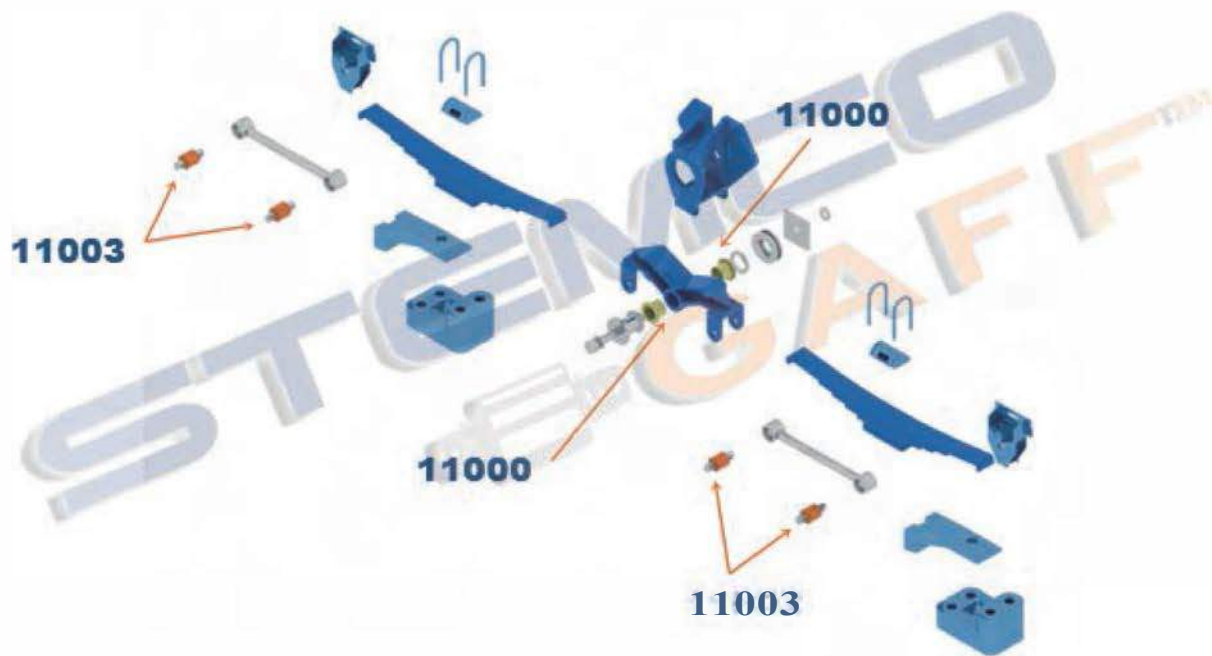

**STEMCO GAFF replacement parts compal'i.ble with:
FREIGHTLINER® FL-120**

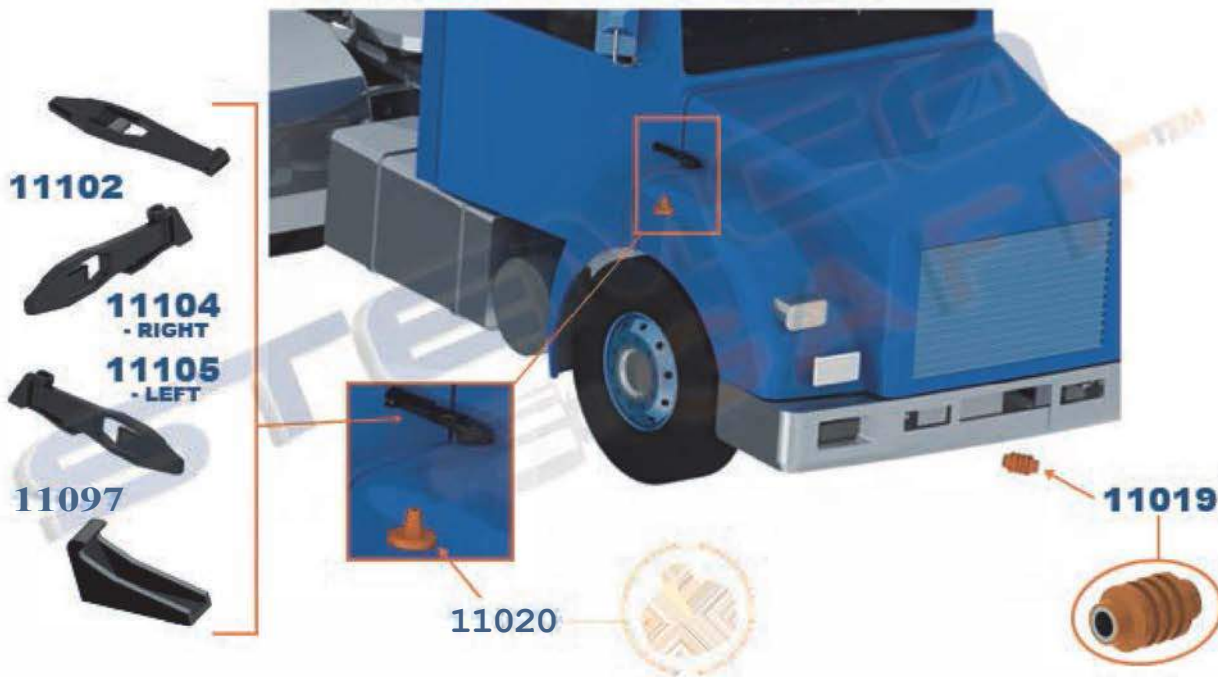

**STEMCO GAFF replacement parts compatible with:
FREIGHTLINER® FL-120
FRONT & REAR SUPPORT**



**STEMCO GAFF replacement parts compatible with:
FREIGHTLINER® FL-120 RADIATOR MOUNT**



11021
(kit)

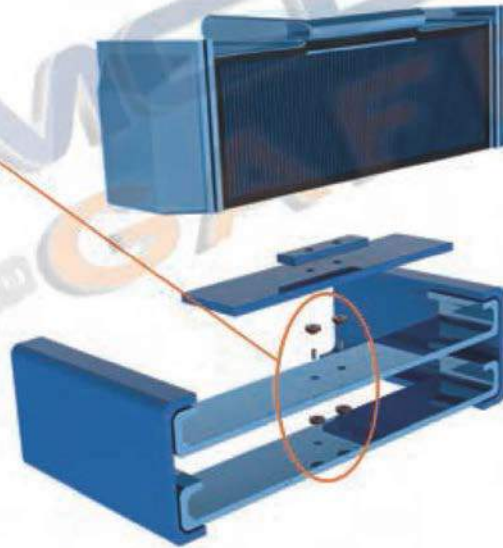
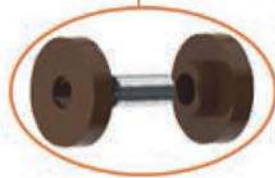

**STEMCO GAFF replacement parts compatible with:
FREIGHTLINER® FLD112, 120
CONVENTIONAL/ COE - 4" WIDE SPRINGS**

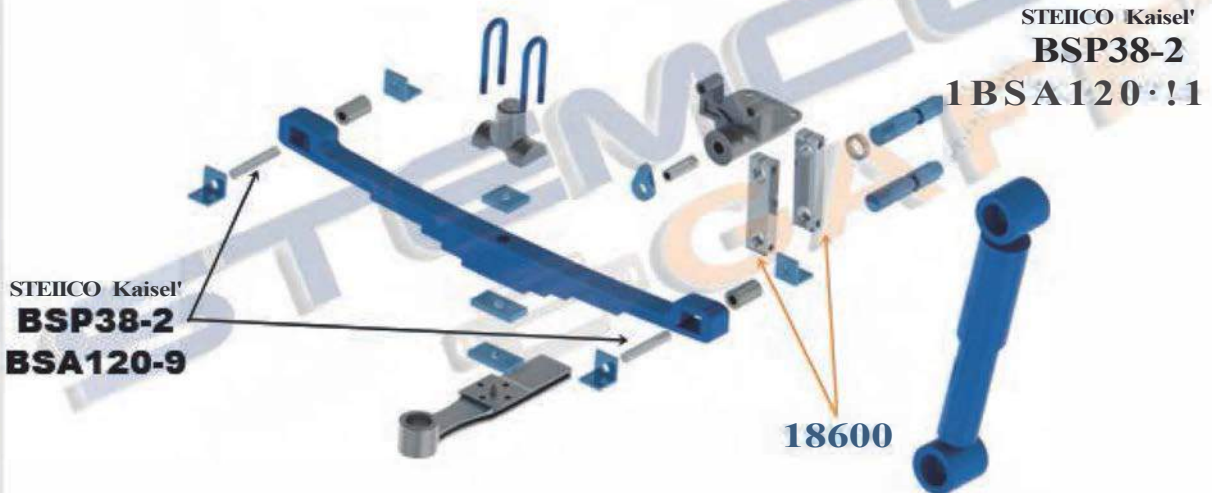

**STEMCO GAFF replacement parts compal'i.ble with:
FREIGHTLINER® HOOD**



**STEMCO GAFF replacement parts compatible with:
FREIGHTLINER® M2 REAR SUPPORT**

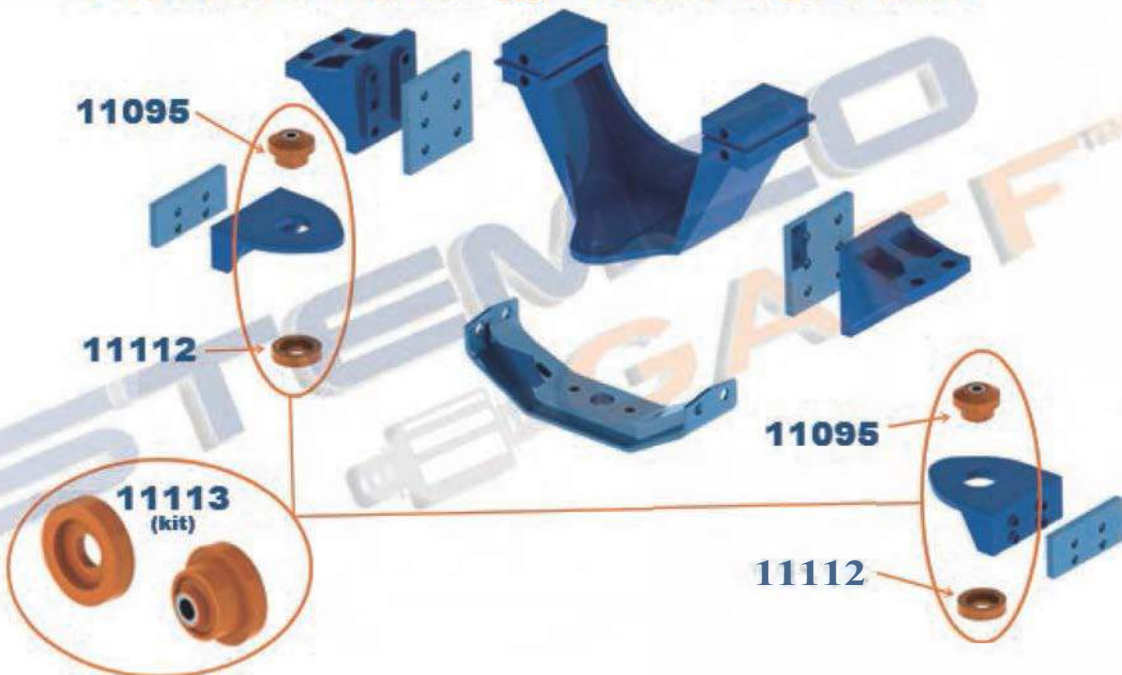

STEMCO GAFF replacement parts compatible with: FREIGHTLINER® M2 112

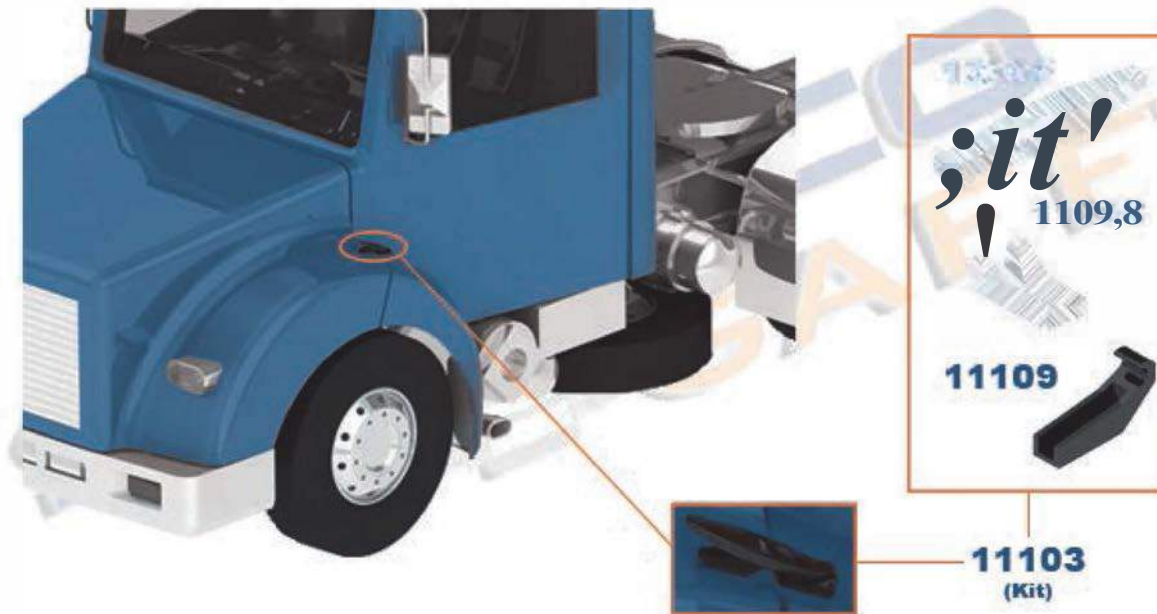

10020



Motor Mount
Front (Lower)

OD	3	"
OD<	1	15/16 -
ID		5/8 -
LG	2	3/16 -
HD	80A	

OEM
J6210-41
J6210-49
30-1357PU
R307484
UM1328
E-7484
D41
329-133U
PL1110

Notes: supersedes 10018 and 10019

10079



Fifth Wheel Bushing

OD	3	3/16 -
ID	1	1/4 -
LG	2	11/16 -
LG2	2	5/16 -
HD	80A	

OEM
FON BSH 109 L
FW99-32109
FW99-32172

Notes: components not sold separately

10506



Hood Latch Assy

LG	8	"
HD	80A-97A	

OEM
HLN1002
315-5101
16899930C91
1699929C9
499523C3

Notes: all components not sold separately

11000



Equalizer Bushing

OD	3	3/16 -
OD<	2	3/4 -
ID	2	1/4 -
LG	2	1/4 -
HD	71D	

OEM
16-13568-000
A16-10549
10-1007PU
R303540A
FL5
E-3540A
D49
322-138
TRB5906
PL 1054

Notes: grooved/ no lubrication grooves -11064

Freightliner continued

11001



Torque Rod Bushing

OD	2	7/16 -	OEM 25508 119569 11-09569-000 FL63 E-1197 322-123 M1788 09-6540
OD<	1	15/16 -	
ID	1	5/16 -	
LG	1	15/16 -	
HD	7	7D	

Notes:

11002



Torque Rod Bushing

OD	2	1/8 -	OEM 16-11351-000 A16-11351 R303296 FL6 E-3296 D50 320-177U M2857 TRB6303 PL1053
ID	1	3/8 -	
LG	1	3/16 -	
HD	97A		

Notes:

11003



Torque Rod Bushing

OD	2	7/16 -	OEM 15-1087-148 E-9395 D421 M3472 TRB6164
LG	1	15/16 -	
C-C	4	3/8 -	
BH	5	5/8 -	
HD	BOA		

Notes: no sleeve/ metal sleeve - 13522 / easy mount - 83522

11004



Torque Rod Bushing

OD	2	1/16 -	OEM A16-119448 20-836PU R305275 HS44 E-5275 D405 321-223 321-223U TRB6185 PL1146A
LG	6	5/8 -	
C-C	4	3/8 -	
BH	5	5/8 -	
HD	BOA		

INCLUDED IN:
11078, 11081, 11769

TOOLS 11071, 18836

Notes: rib style/ 11006-oversized / 12051 -grooved for torque rod with a center rib/ 13521 - chamfered

11005



Spring Pin Bushing

OD	2	1/2 -	OEM 16-13962-000 16-18035-000 681-325-01-50 681-325-02-50 10-1010 R308804 E-8804 RB-268 MR664 UB20500
LG	7	1/2 -	
C-C	5	3/4 -	
BH	13	13/16	
HD	BOA		

Tool 11069

Notes:

11006



Torque Rod Bushing

OD	2	5/16 -	OEM
LG	6	5/8 -	
C-C	4	3/8 -	
BH	5	5/8 -	
HD	BOA		

Notes: oversized/ 11004- rib style/ 12051 -grooved for torque rod with a center rib/ 13521 - chamfered

11007



Cab Mount

OD	3	-	OEM 7007-05
OD<	2	3/4 -	
ID	1	5/8 -	
LG	2	1/8 -	
HD	70A		

Notes: components not sold separately

11008



Cab Mount Front (Lower)

OD	3	3/4 -	OEM 681-891-00-01 A681-891-00-01 LORSB33310017A CM46-61891 10-1067PU
ID	1	3/16 -	
LG	1	5/16 -	
HD	BOA		

INCLUDED IN:
11086

Notes: for best value use kit 11086

Freightliner continued

11009



OD	3	13/16 -
OD<	2	1/2 -
ID		3/4 -
LG	2	9/16 -
HD		BOA

OEM
681-890-00-01
A681-890-00-01
LORSB33310017B
CM46-61890

INCLUDED IN:
11086

Cab Mount
Front (Upper)

Notes: for best value use kit 11086

11012



THK	1	7/16 -
WD	3	1/8 -
LG	4	3/16 -
BH		1/2 -
THR	y:	-13 UNC
HD		BOA

OEM

Cab Mount

Notes:

11013



THK	1	9/16 -
WD	2	1/4 -
LG	3	
BH		3/4 -
HD		70A

OEM
A01-11166-000
R307430
E-7430
329-115U
M17328
M17328UB
PL1052

Motor Mount
Rear

Notes:

11014



THK	1	3/8 -
WD	2	3/16 -
LG	3	5/16 -
BH		3/4 -
HD		70A

OEM

Motor Mount
Rear

Notes: compatible with CAT engine

11015



THK		5/8 -
WD	2	5/8 -
LG	4	9/16 -
THR	•,:	16UNCx1_5-
HD		BOA

OEM

Motor Mount
Rear

Notes:

11018



OD	3	1/4 -
ID		3/4 -
LG	2	3/16 -
HD		70A

OEM
01-15047-000
LORSS3310017
LORSS3310018
SSB3310017
SSB3310018
MM46-62003

INCLUDED IN:
11087

Motor Mount
Front

Notes: components not sold separately

11019



OD	1	3/8 -
ID		1/2 -
LG	2	3/16 -
HD		BOA

OEM
J17700-5
PL1133

Hood Hinge Bushing

Notes:

11020



OD	4	-
OD<	1	1/16 -
ID		1/2 -
LG	3	
HD		BOA

OEM
A17-10464-001
D102
329-199U
M17331
M17331UB
PL1051

Hood Guide Bushing

Notes:

Freightner continued

11021



Radiator Mount

Notes: components not sold separately

OD	2	15/16 -
ID	1	11/16 -
LG	1	13/16 -
HD		70A

OEM
05-16070-000

11023



Cab Mount Front

Notes:

OD	2	15/16 -
ID	1	11/16 -
LG	1	13/16 -
HD		70A

OEM

11054



Motor Mount Front

Notes:

OD	2	5/8 -
ID	1	3/8 -
OD<		5/8 -
LG	2	1/16 -
HD		80A

OEM

11056



Hood Hinge Bushing

Notes:

OD	2	3/8 -
ID	1	5/16 -
OD<	2	1/4 -
LG		80A
HD		

OEM

11063



Spring Pin Bushing

Notes:

OD	1	3/4 -
LG	6	3/4 -
C-C	5	3/8 -
BH		5/8 -
HD		80A

OEM
HR1-HB0541
HR1-HBUS-41
E-9874
D429
RB-175
MR596

TOOLS -18836,11068

11064



Equalizer Bushing

Notes: no lubrication grooves/ grooved -11000

OD	3	1 1/4
OD<	2	3/4 -
ID	2	1/4 -
LG	2	3/8 -
HD		72D

OEM
16-10549-000
16-13568-000
A16-10549
10-1007PU
R303540A
E-3540A
049
334-492
TRB5906
PL1054

11065



Motor Mount Rear

Notes:

OD	1	3/8 -
BH		5/8 -
WD	2	3/8 -
CC	5	3/8 -
FD	3	
		80A

INCLUDED IN:
11088

OEM
J20941-3
J20941-6
LORJ209416
LORJ209417
MM46-62416

11066



Spring Bushing

Notes:

OD	2	1/4 -
ID		13/16 -
LG	4	1/4 -
HD		80A

OEM
16-17769-00
680-322-01-05
680-322-01-50
RB211
RB233
RB-211
RB-233
SP46-52800

Freightliner continued

11070



Fuel Tank Cap Gasket

OD	3	3/8 -	OEM
ID	2	7/16 -	
THK		3/16 -	
HD	BOA		

Notes:

11074



Motor Mount Kit Front

WD	3	1/4 -	OEM
LG	7	1/8 -	
C-C	4		
BH		3/4 -	
HD	BOA		

INCLUDES

QTY1	11072
QTY1	11073

INCLUDED IN:

11090

Notes: components not sold separately

11075



Cab Mount Bushing

OD	3	3/4 -	OEM
ID		5/8 -	
LG	3	1/8 -	
HD	BOA		

INCLUDED IN:

11110, 11092

TOOL-11079

Notes: 2 per truck/ recommended to replace set in same repair/ for complete repair use kit 11092 / compatible with Freightliner- Century, Columbia, Coronado

11077



Motor Mount Kit Rear

WD	3		OEM
LG	9	7/8 -	
C-C	8	5/16 -	
BH		9/16 -	
HD	70A		

INCLUDED IN:

11089

Notes: lower mount is round design/ components not sold separately/ lower mount alternate option 31083 - D shape design special order only

11078



Torque Rod Assy

C-C	23	13/16 -	OEM
BC-C	4	3/8 -	
BH		11/16 -	
HD	BOA		

INCLUDES

QTY 2	11004
-------	-------

Notes:

11081



Torque Rod Assy

C-C	24	5/16 -	OEM
BC-C	4	3/8 -	
BH		11/16 -	
HD	BOA		

INCLUDES

QTY 2	11004
-------	-------

Notes:

11083



Spring Pin Bushing

OD	2	1/2 -	OEM
LG	7	7/16 -	
C-C	5	11/16 -	
BH		7/8 -	
HD	BOA		

TOOL 11069

Notes: anti walk design

11085



Motor Mount Kit Rear

INCLUDES

QTY4	11725
QTY4	1/4", x4" G8
QTY4	Lock Nuts 3/4"
QTY8	Flat Washers 1/2"

OEM

CBA-24-650-17
10-1059PU
UM324
E-7431
D48
329-116U
M17330UB
PL 1003

Notes: kit not offered by OE

Freightliner continued

11086



INCLUDES
 QTY 2 11008
 QTY 2 11009
 QTY 2 3/4 x 5 G8
 QTY 2 Lock Nuts 3/4
 QTY 2 Flat Washers 3/4

OEM
 681-890-00-01
 681-891-00-01
 A681-890-00-01
 A681-891-00-01
 LORSB33310017A
 LORSB33310017B
 CM46-61001

Cab Mount Kit

Notes: kit not offered by OE

11087



INCLUDES
 QTY 2 11018
 QTY 2 3/4"x4 1/2"G8
 QTY 2 Lock Nuts 3/4
 QTY 4 Flat Washers 3/4

OEM
 01-15047-000
 LOR553310017
 LOR553310018
 SSB3310017
 SSB3310018
 MM46-62003

Motor Mount Kit Front

Notes: kit not offered by OE

11088



INCLUDES
 QTY 2 11065
 QTY 2 1/ix 4"G8
 QTY 4 Lock Nuts 1/4
 QTY 8 Flat Washers 3/8

OEM
 J20941-3
 J20941-6
 J20941-7
 LORJ20941 6
 LORJ20941 7
 MM46-62416

Motor Mount Kit Rear

Notes: kit not offered by OE

11089



INCLUDES
 QTY 2 11077
 QTY 2 3/1X4 1/2 G8
 QTY 2 Lock Nuts 3/4
 QTY 4 Flat Washers 3/4

OEM
 BCD 273301
 BCD273302
 BCD288051
 BCD267012
 BCD273301
 BCD273302
 BCD274772
 BCD288051
 MM46-62000

Motor Mount Kit Rear

Notes: kit not offered by OE

11090



INCLUDES
 QTY 1 11074
 QTY 2 3/4"X4 1/2"G8
 QTY 2 Lock Nuts 3/4
 QTY 4 Flat Washers 3/4

OEM
 BCD267041
 BCD 276513
 BCD 27651-1
 BCD 27651-2
 BCD 28945-1
 BCD267041
 BCD276511
 BCD276512
 BCD276513
 MM46-62002

Motor Mount Front

Notes: kit not offered by OE

11092



INCLUDES
 QTY 2 11110
 QTY 2 3/4 X4"G8
 QTY 4 Lock Nuts 3/4
 QTY 8 Flat Washers 3/4

OEM

Cab Mount Kit

Notes: kit not offered by OE / compatible with Freightliner - Century, Columbia, Coronado

11094



INCLUDES
 OD 2 1/4 -
 OD< 1 1/4 -
 LG 6 7/8 -
 HD 80A

OEM
 16-14603-000
 16-17194-000
 16-17770-000
 16-18023-000
 RB263
 RB-263
 MR772
 MR772UB
 SP46-11023

Spring Pin Bushing

Notes:

11095



INCLUDES
 OD 3 3/4 -
 OD< 2 3/16 -
 BH 13/16 -
 THK 2 11/16"
 HD 70A

OEM
 17-1843

INCLUDED IN:
 11113

Motor Mount Upper

Notes:

Freightliner continued

11096 LG 5
HD 71D

OEM
17-12434-000



Hood Latch Hook

Notes: for complete repair use with 11102 / component not offered by OE

11097 LG 3 1/2
HD 71D

OEM
8574FL



Hood Latch Hook

Notes:

11098 LG 3 1/16
HD 71D

OEM

INCLUDED IN
11103



Hood Hinge

Notes:

11102 LG 10
HD 70A

OEM
17-12434-000

Hood Latch

Notes: for complete repair use with 11096 / component not offered by OE

11103 LG 8 9/16
HD 70A

OEM
680-880-01-60

INCLUDES
QTY 1 11098



Hood Latch W/ Mount

Notes: bracket not sold separately

11104 LG 11 1/4
HD 70A

OEM
17-12435-000
HLK1011



Hood Latch W/ Mount Left

Notes: bracket not sold separately

11105 LG 11 1/4
HD 70A

OEM
17-12435-001
HLK1012



Hood Latch W/ Mount Right

Notes: bracket not sold separately

11106 LG 11 4/4
HD 70A

OEM
17-15553-001
HLK1020



Hood Latch W/ Mount Right

Notes: bracket not sold separately

Freightliner continued

11107 LG 11 1/4 -
HD 70A -

OEM
17-15553-000
HLK1019



Hood Latch
W/ Mount
Left

Notes: bracket not sold separately

11109 LG 313/16-
HD 710 -

OEM
17-14781-000
HLK2001



Hood Latch
Hook

Notes:

11110 LG 3 1/8 -
CC 515/16-
BH 9/16-
THK 7 1/8 -

OEM
1844009000
1845384000
18-44009-000
18-45384-000
BJ-1769
CM46-61384



Cab Mount Kit

INCLUDES
QTY 1 11075
QTY 1 3/4"X4.G8
QTY 1 Lock Nuts 7/8"
QTY 2 Flat Washers 1/2"

INCLUDED IN:
11092

Notes: 2 per truck/ recommended to replace set in same repair/ for complete repair use kit 11092 / compatible with Freightliner- Century, Columbia, Coronado

11111 OD 4 1/8 -
LG 2 7/16 -
THR 1/2"UNC
HD 70A -

OEM
680-891-04-01
68-08910-401



Cab Mount

Notes: hamburger mount/ compatible with Freightliner - FL?0

11112 OD 3 5/16 -
D 211115-
ID< 1 5/16 -
THK 7/8 -
HD 70A -

OEM



Motor Mount
Lower

INCLUDED IN:
11113

Notes:

11113 **INCLUDES**
QTY 1 11112
QTY 1 11095

OEM



Motor Mount
Kit

Notes: compatible with M2 trucks

11115 OD 1 1/16 -
D 3/8 -
LG 1 -
HD 70A -

OEM
11115



Transmission Bushing

Notes:

11117 WD 113/16-
LG 315/16-
CC 1 3/4 -
BC-C 2 3/8 -
THR 3/4"x1"-UNC
HGT 1 5/8 -
HD BOA -

OEM
A6805040382
LORSM10359
MBT A6805040382
RM46-63359



Radiator Mount

Notes: verify dimensions compare to 11144

Freightliner continued

11118



Clutch Bar Bushing

OD	1 1/16 -	OEM 11118 MS46-29002
ID	1/2 -	
LG	1	
HD	70A	

Notes:

11120



Fuel Tank Gasket

OD	3 3/8 -	OEM
ID	2 3/16 -	
TWK	1/8 -	
HD	70A	

Notes: compatible with FLD Columbia

11123



Spring Bushing Front

OD	2	OEM
ID	1 3/16 -	
LG	3 1/4	
HD	80A	

Notes: sleeveless bushing for leaf springs/ bushing with sleeve is 11133 / compatible with AirTek leaf spring on FLD Columbia

11124



Hood Guide

WD	111/16 -	OEM A17-13666-000 HLK2005
LG	3 7/16 -	
C-C	1 5/8 -	
HGT	2 1/4	
HD	70A	

Notes: new short plate/ 11145- long plate/ compatible with Century and Columbia trucks

11129



Radiator Mount

TWK	1 1/4 -	OEM BCD 28721-1 BCD 28847-1 RM46-63471
WD	3 7/8 -	
LG	4 -	
C-C	1 1/4 -	
C-C	1 7/8	
HD	70A	

Notes: compatible with FLD Century Class

11134



Hood Latch Assy

LG	811/16 -	OEM 17-12438-000 HLK1024
LG'	4 3/16 -	
HD	70A-97A	

Notes: bracket not sold separately

11144



Radiator Mount

WD	113/16 -	OEM A 6805040382
LG	315/16 -	
C-C	1 3/4 -	
BC-C	2 3/8 -	
THR	1" -UNC	
HGT	2 1/8 -	
HD	80A	
'la"x		

Notes: verify dimensions compare to 11117

11145



Hood Guide

IG	2 7/8 -	OEM A17-15140-000
C-C	1 11/16 -	
HGT	4	
HD	70A	
HD		

Notes: new long plate/ 11124 for short plate/ compatible with Century and Columbia trucks

Freightliner continued

11152

C-C	24	3/16 -
BC-C	4	3/8 -
BH		5/8 -

INCLUDES
QTY 2 13520

OEM
16-15632-000
16-18972-000
925050
TMR536
TR46-41000



Torque Rod Assy
Angled

Notes:

11153

C-C	22	7/8 -
BC-C	4	3/8 -
BH		5/8 -

INCLUDES
QTY 2 13521

OEM
16-16749-000
681-326-6316
FL42
E-8808
345-213
943886
TMR515
TR46-41316



Torque Rod Assy

Notes:

11520

OD	2	7/8 -
OD<	1	7/8 -
ID		5/8 -
LG	1	5/16 -
HD		80A

OEM
HUN 12004 3401
J7165-1
35-548PU
R307472
E-7472
D6
329-136U
M17412
MM96-62401
PL1015



Cab Mount
W/ Metal Sleeve

Notes: metal bushing stepped design/ verify dimensions compare to 11523 or 11552

11523

OD	2	7/8 -
OD<	1	13115-
ID		5/8 -
LG	1	5/16 -
HD		80A

OEM
HUN 12004 3401
J7165-1
35-548PU
R307472
E-7472
D6
329-136U
M17412
MM96-62401
PL1015



Cab Mount
W/ Metal Sleeve

Notes: metal bushing stepped design/ verify dimensions compare to 11523 or 11552 / compatible with Western Star using (2) 11523 with a 12301

11537

OD	3	11/16 -
OD<	2	1/16 -
ID		3/4 -
LG	2	1/2 -
HD		80A

OEM
J6198-2
35-549PU
R307469
UM1157
E-7469
D432
D7
329-194U
M17406
PL1013



Motor Mount
Front

Notes:

11544

OD	1	3/4 -
OD<	1	1/4 -
ID		1/2 -
LG	1	1/4 -
HD		80A

OEM
CB1121-10
40-312
D542
329-205U
PL1107



Hood Hinge Bushing

Notes:

11556

OD	2	11/16 -
C-C	4	3/8 -
BH		5/8 -
HD		80A

OEM
151087148
M2069



Torque Rod Bushing

Notes: verify dimensions compare to 13522 and 83522

11611

OD	1	1/2 -
ID		13/16 -
LG	2	5/16 -
BH		3/4 -
HD		90A

OEM
FUL K-3399
MS99-63399



Shifter Bushing Kit

Notes:

Freightliner continued

11613



Motor Mount
Front

OD	3 13/16 -
OD<	2 1/16 -
ID	3/4 -
LG	2 9/16 -
HD	BOA

OEM
 J6198-2
 35-549PU
 R307469
 E-7469
 D432
 D7
 329-159U
 329-194U
 M17406
 PL 1013

Notes:

11707



Cab Mount

OD	2 1/2 -
OD<	1 5/8 -
ID	5/8 -
LG	2
HD	BOA

OEM
 CBA28-1050
 35-569PU
 R307506
 E-7506
 D4
 D540
 329-163U
 M17804UB
 PL 1070
 PL 1105

Notes: OD< chamfered / 12355 - standard / also used as motor mount

11711



Pivot Bushing

OD	5 1/2 -
ID	1 1/2 -
LG	6 3/4 -
HD	BOA

OEM
 ROW 1117680B060
 ROW 1117680B070
 321-338
 321-368
 RD1170
 RD1175
 PB85-360B0

Notes:

11725



Motor Mount
Front

OD	2 3/8 -
OD<	1 1/2 -
ID	5/8 -
LG	2 1/8 -
HD	BOA

INCLUDED IN:
 11085

OEM
 CBA-24-650-17
 10-1059PU
 R307431
 E-7431
 D48
 329-116U
 M17330
 M17330UB
 PL 1003

Notes: supersedes 1101611017 and 11054

11751



Torque Rod Assy

C-C	24
BC-C	4 3/8 -
HD	BOA

INCLUDES
 QTY 1 11754
 QTY 2 13520

OEM
 6813262065
 68-13262-065
 925030
 TR59-41375

Notes:

11775



Spring Pin Bushing
Front

OD	2 1/16 -
C-C	5 3/4 -
HD	BOA

OEM

Notes: new suggested tool 40093

11777



Torque Rod Assy

C-C	19 3/4 -
BC-C	4 3/8 -
BH	11115-
HD	BOA

INCLUDES
 QTY 1 11770
 QTY 2 13677

OEM

Notes:

12044



Torque Rod Assy
Weldable

C-C	26
BC-C	4 3/8 -
BH	5/8 -

INCLUDES
 QTY 1 13590
 QTY 2 13520

OEM
 IPC928661
 MR661
 UR661
 E-2642

Notes: universal torque rod

Freightliner continued

12344



Torsion Spring Mount

THK	3	7/8	-
WD	4	5/16	-
LG	4	1/8	-
CC	3	5/16	-
BH		7/16	"

OEM

Notes: compatible with VNL 630

12365



Hood Latch

LG	8	11/16	-
HD		70A	

OEM
680-880-01-60

Notes:

12396



Torque Rod Assy

CC	17	5/16	-
BC-C	4	3/8	-
BH		5/8	-

INCLUDES
QTY 2 13520

OEM
HOR 62010 455
TRS0-42455

Notes:

13521



Torque Rod Bushing

OD	2	1/16	-
LG	6	5/8	-
CC	4	3/8	-
BH		5/8	-
HD		BOA	

INCLUDED IN:
11153, 11792, 11795, 12397, 34563

TOOLS 11071, 18836

OEM
A16-119448
20-836PU
R305275
HS44
E-5275
D405
321-223
TRB6185
PL1146
TSS0-22691

Notes: chamfered / 11004 - rib style/ 11006 - oversized / 12051 - grooved for torque rod with a center rib

13522



Torque Rod Bushing

OD	2	1113r	
C-C	4	3/8	-
BH		5/8	-
HD		BOA	

TOOLS 18553, 18833

OEM
151087-148
20-832PU
R307638
C878
E-7638
D421
321-131
TRB164
TS34000
TS34095

Notes: metal sleeve/ easy mount - 83522 / no sleeve - 11003 / additional tool suggestion coming soon 40131

13525



Torque Rod Bushing

OD	3	1/2	-
C-C	4	3/8	-
BH		5/8	-
HD		BOA	

TOOL 18831

OEM
J-142662

Notes:

13626



Bolster Spring Kit

BC-C	4	3/4	-
THR		1/2	-
HD		BOA	

OEM
HOR 64179 037
HS130
E-14044
E-14374
334-1727
334-1845
MLC3
MLC5
LPS0-24179

Notes: 4 kits per truck/ recommended to replace set in same repair/ don't mix brands

13679



Torque Rod Assy

LG'	8	1/16	-
CC	25		
BC-C	4	3/8	-
BH		5/8	-
HD		80A	

INCLUDES
QTY 1 13680
QTY 1 13518
QTY 1 13520

OEM
681-326-70-16
TR59-41150

Notes:

Freightliner continued

13683



LG	8	W16-
BC-C	4	3/8 -
BH		5/8 -
HD	80A	

INCLUDES

QTY 1	13520
QTY 1	13681

Torque Rod End Assy
Tube End

Notes:

OEM
IPC928610
R3010310
R302639
MR610
E-10310
345-741
345-742
928610
TMRU610
TR71000

13686



LG	8	9/16 -
LG'	8	1/16 -
THR	11/16-12	UNF
HD	80A	

INCLUDES

QTY 1	13681
QTY 1	13518

Torque Rod End Assy
Tube End

Notes:

OEM
IPC928630
MR630
UR630
345-620
345-630
345-738
928630
09-5422
TMRU620
TR72000

13691



LG	25	7/16 -
BC-C	4	3/8 -
BH		5/8 -
HD	80A	

INCLUDES

QTY 1	13682
QTY 1	13520

Torque Rod End Assy
27" Rod End

Notes:

OEM
IPC928660
IPC928661
R302642
UR661
E-2642
345-742
928661
09-5431
TMRU661
TR75000

13694



LG	33	7/16 -
LG'	8	1/16 -
THR	1 1/4"-12	UNF
HD	80A	

INCLUDES

QTY 1	13707
QTY 1	13518

Torque Rod End Assy
35" Rod End

Notes:

OEM
IPC928680
20-9033
MR680
UR680
E-2643
345-680
928680
09-5433
TMR680
TR76000

13695



LG	25	7/16-
LG'	8	11/15-
THR	1 1/4"-12	UNF
HD	80A	

INCLUDES

QTY 1	13682
QTY 1	13518

Torque Rod End Assy
27" Rod End

Notes:

OEM
IPC928681
20-9023
MR681
UR681
E-10317
345-681
928681
09-5426
TMR681
TR76000

13696



LG	33	7/16-
LG'	7	
THR	1 1/4"-12	UNF
HD	80A	

INCLUDES

QTY 1	13707
QTY 1	12031

Torque Rod End Assy
35" Rod End

Notes:

OEM
IPC928690
20-9032
MR690
UR690
345-690
928690
09-5435
TMR690
TR77000

13697



LG	25	7/16 -
LG'	7	
THR	1 1/4"-12	UNF
HD	80A	

INCLUDES

QTY 1	13682
QTY 1	12031

Torque Rod End Assy
27" Rod End

Notes:

OEM
IPC928691
20-9022
R302812
MR691
E-2812
345-691
928691
09-5429
TMR691
TR77000

13733



C-C	14	3/8 -
BC-C	4	3/8 -
BH		5/8 -
THR	1 1/4"-12	UNF

INCLUDES

QTY 1	13520
QTY 1	13518

Torque Rod Assy

Notes:

OEM
HDR 62350 615
TR50-41615

Freightliner continued

14513



Beam End Bushing

OD	3 1/2 -
ID	1 1/8 -
LG	5 1/4 -
HD	80A

OEM
NEW 90008139
WCM 10050
 60-1535
 R304382A
 N120
 E-8683
 D441
 321-229
 TRB5713
 PB57-21139

Notes: additional tool suggestion 14531

14533



Beam End Bushing

OD	213/16 -
D	1 1/8 -
LG	5 -
HD	80A

OEM
HLD90008149
WCM11223
 60-1501
 R304410A
 N124
 E-4410A
 0448
 321-231
 TRB5703
 PB57-21149

Notes: supersedes 14528 / additional tool suggestion 14531

15064



Torque Rod Bushing Kit

INCLUDES

QTY 2	15073
QTY 1	Bolt 1"-14UNFxT
QTY 1	Nut f -14UNF
QTY 2	Flat Washers
	1 x 1/1,THK

OEM
REYTK19089
 R301983
 R003
 E-1983
 E-9545
 334-253
 09-2360
 TRK6008
 TH83-22089
 TH83-37997

Notes: compatible with Reyco 21 B

18015



Vibration Mount

OD	1 7/8 -
OD<	1 5/16 -
D	1/2 -
LG	2 -
HD	70A

OEM
LOR CB2202-12
 MS99-62620
 HLO XB 0011
 FW51-32011

Notes: components not sold separately

18215



Fifth Wheel Bushing

OD	2 -
ID	1 1/8 -
LG	4 1/4 -
HD	80A

OEM
HLD XB 0011
 FW51-32011

Notes: no groove/ verify dimensions compare to 18094

18221



Fifth Wheel Bushing

OD	3 1/2 -
ID	1 1/4 -
LG	3 3/4 -
HD	80-71A

OEM
HLDXB0009
 KP116

Notes:

18433



Motor Mount

ID	13/16 -
THK	2 5/16 -
WD	3 3/16 -
LG	5 -
HD	80A

OEM
C8TZ6068B
 EM-2752

Notes:

18566



Shock Absorber Bushing

OD	1 7/8 -
D	1 -
LG	1 -
HD	80A

OEM
A1601005002
 40-340
 R307529
 HB593
 E-7529
 01
 320-153
 M695
 MH1432
 PL1026

Notes:

18600



Shackle

ID	1	1/4	~
THK	1		~
WD	2		~
LG	7	13/16	~
C-C	5	5/16	~

OEM
 16-11890-000
 16-11890-001
 16-12302-000
 16-12373-000
 16-12399-000
 16-13470-000
 A16-12301-000
 B1409-46
 E-8800
 327-487

Notes:

18837



Radiator Mount

OD	2		~
OD<	1	5/16	~
ID		5/8	~
LG	1	1/4	~
HD		80A	

OEM
 CB1121-10
 40-312
 40-354
 D542
 329-205U
 PL1107

Notes:

18994



Spring Mount Rear

ID		13/16	~
WD	2		~
C-C	5		~
HD		80A	

INCLUDED IN:
 13725

OEM
 58918-000

Notes:

30504



Exhaust Mount

OD	2	5/8	~
OD<	1	1/4	~
ID		1/2	~
LG	1	5/8	~
HD		80A	

OEM
 04-17003-000
 M46730

Notes: compatible with most Freightliner - Century, Columbia and Coronado

31624



Deflector Pad

WD	5	5/16	~
LG	7	9/16	~
BH		9/16	~
HGT	5	5/16	~
HD		70A	

OEM
 A16-15303-000
 A16-15773-000

Notes:

34525



Motor Mount Kit Rear

INCLUDES
 QTY 2 34510
 QTY 2 Bolt 3/4" x 4" G8
 QTY 2 Lock Nut 3/4"
 QTY 4 Flat Washers 3/4"

OEM
 BCD274772
 M17445
 MM55-62005

Notes:

34555



Torque Rod Assy

LG	8	1/4	~
C-C	25	1/4	~
BC-C	4	3/8	~
BH		5/8	~
THR	1 1/4	12 UNF	

INCLUDES
 QTY 1 13520
 QTY 1 13518

OEM
 HDR 62350 645
 TR50-41645

Notes:

34556



Torque Rod Assy

C-C	23	1/4	~
BC-C	4	3/8	~
BH		5/8	~

INCLUDES
 QTY 2 13520

OEM
 681-326-2516
 HDR 62001 590
 HDR62000 590
 924920
 942174
 944160
 944220
 948574
 TR50-42590

Notes:

Freightliner continued

40035



Fifth Wheel Bushing Kit

OD	3 7/8"
OD<	2 5/16"
ID	1 5/32"
LG	2 1/16"
HD	80A

OEM
HLD-XB10605
FW99-32605

Notes: components not sold separately

40074



Carrier Bearing Assy

ID	2 3/8"
C-C	8 1/2"
BH	1/2"
HGT	3 21/64"
HD	70A

OEM
SP2106611X
DS-6049

Notes: includes carrier bearing bushing 18002

40075



Carrier Bearing Assy

ID	2"
C-C	7 7/16"
BH	1/2"
HGT	2 25/32"
HD	70A

OEM
TDA CCB101
DS-6048

Notes: includes carrier bearing bushing 18725

50033



Torque Rod Bushing

INCLUDES

QTY 2	34514
QTY 1	Pivot Bolt 7/8" - 16 UNF x 6 G8
QTY 1	Lock Nut 7/8"
QTY 1	Flat Washer 7/8"
QTY 1	Sleeve 1 1/2" x 1/4" x 3"

OEM
HDDR005422
E-11763
334-1672
TRK4931
PB00-26422
SU99-39115

Notes:

83522



Easy-Mount Torque Rod Bushing

OD	2 17/32"
C-C	4 3/8"
BH	5/8"
HD	80A

OEM
151087-148
20-832PU
R307638
FL55
E-7638
321-131
M2069
TRB6164
TS34000
TS34095

TOOLS 18553, 18833

Notes: easy mount / metal sleeve - 13522 / no metal sleeve - 11003

Fruehauf

DESCRIPTION	OEM	PART ID	PAGE
Beam End Bushing	MNW900081395 / 60-1535 / R304382A / N120 / E-8683 / D441 / 321-229 / M3456 / TRB5713 / PB57-21139	14513	55
Camshaft Bushing	515147 / E-5512 / 02-210	17501	56
Camshaft Bushing	AXA-0429-900 / E-1571	17502	56

Fruehauf continued

DESCRIPTION	OEM	PART ID	PAGE
Camshaft Bushing	AXA-0413-900 / E-1567	17505	56
Camshaft Bushing	ACA-3266	17574	56
Camshaft Bushing	ACD-2285-900 / E-1577A	17668	56
Center Bushing	MNW90008148S / 60-1501 / R304410A / N124 / E-4410A / 321-231 / TRB-5703	14529	55
Equalizer Bolt	UXA-0015001 / 15-1204 / FR267 / E-1019 / 334-453A / M1807 / TRS4309	13011	54
Equalizer Bushing	UXA-000004 / 15-1203PU / R307432 / FR263 / E-7432 / D214 / 321-190 / TRB5384 / PL1085	13005	54
Equalizer Bushing	A80BL1050	13007	54
Equalizer Bushing	UCA-0472 / 25-705PU / R307452 / H102 / E-7452 / D95 / 321-176U / M1452 / TRB5541 / EQ53-35234	14000	55
Equalizer Bushing Kit	UXA-000004-900 / UXA-0004-900 / FR264 / E-1024 / E-9361 / D214 / 334-452A / TRK5384HD / TRK5384UB / EQ47-35900	13041	55
Shock Absorber Bushing	663400 / 40-340 / R307529 / HB593 / E-7529 / D1 / 320-153 / M695 / MH1432 / PL1026	18566	56
Shock Absorber Bushing	1T18197A / 2350908 / 2350908U / 12-5-123 / 12-5-123A / SB03-83008 /	30507	56
Spring Pad		13010	54
Spring Pad	UCD-005635001 / UCD-5635-001 / R308664 / FR220 / E-8664 / D217 / 325-151 / 09-2274 / M9632 / PL1005	13037	54
Torque Rod Bolt	UXA-000016 / E-1018 / 334-566 / TRS3309	13015	54
Torque Rod Bushing	UXA-000011 / 25-750PU / R30927 / RBT200 / E-7433 / D100 / 321-177 / M1818 / TRB6300 / PL1084	13001	54
Torque Rod Bushing	586121 / UXA-0011 / 25-750PU / RB200 / E-7433 / E-927 / D100 / M1818 / 09-2247 / TRB6300	14003	55
Torque Rod Bushing	UCA-3754 / 25-708PU / R30934 / RB201 / E-934 / D94 / 321-175 / M1888 / TRB6326 / PL1119	14008	55
Torque Rod Bushing	UCA-3754 / 25-708PU / R30934 / RB201 / E-934 / D94 / 321-175 / 09-3344 / TRB6326 / PL1119	14073	55
Torque Rod Bushing Kit	UXA000011-900 / UXA-000011900 / 15-1217 / H236 / E-9362 / 334-565 / 334-640 / TRK6300 / TH47-37900 / TH53-37637	13042	55
Trunnion Bushing	UXA-000160 / UXA-000160SP1 / UXA-000160SPX / UXA-0160 / R308663 / E-8663 / D218 / 325-150 / M9626 / PL1004	13009	54

STEMCO GAFF replacement parts compatible with: FRUEHAUF™ D-2 SERIES

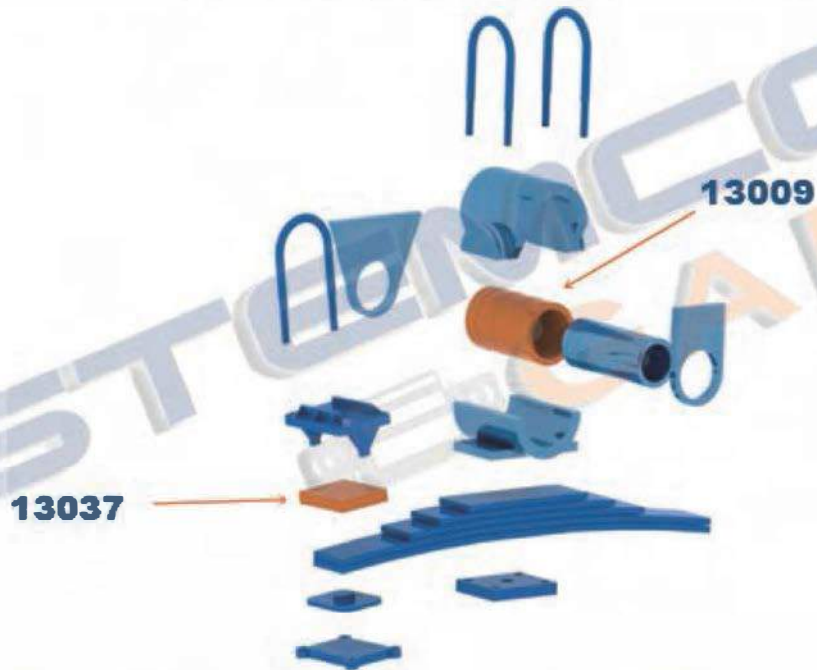

STEMCO GAFF replacement parts compatible with: FRUEHAUF™ F-2 STANDARD HANGERS

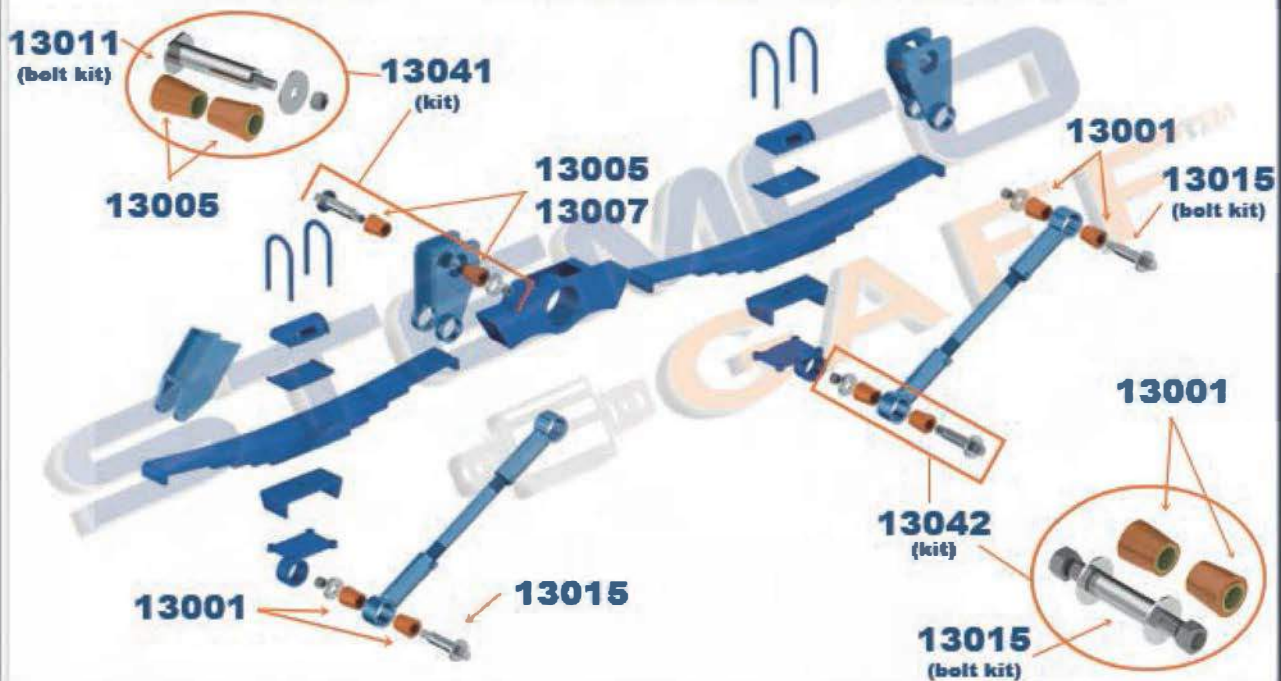

**STEMCO GAFF replacement parts compatible with:
FRUEHAUF™ F-2 WIDE-BASE HANGERS**

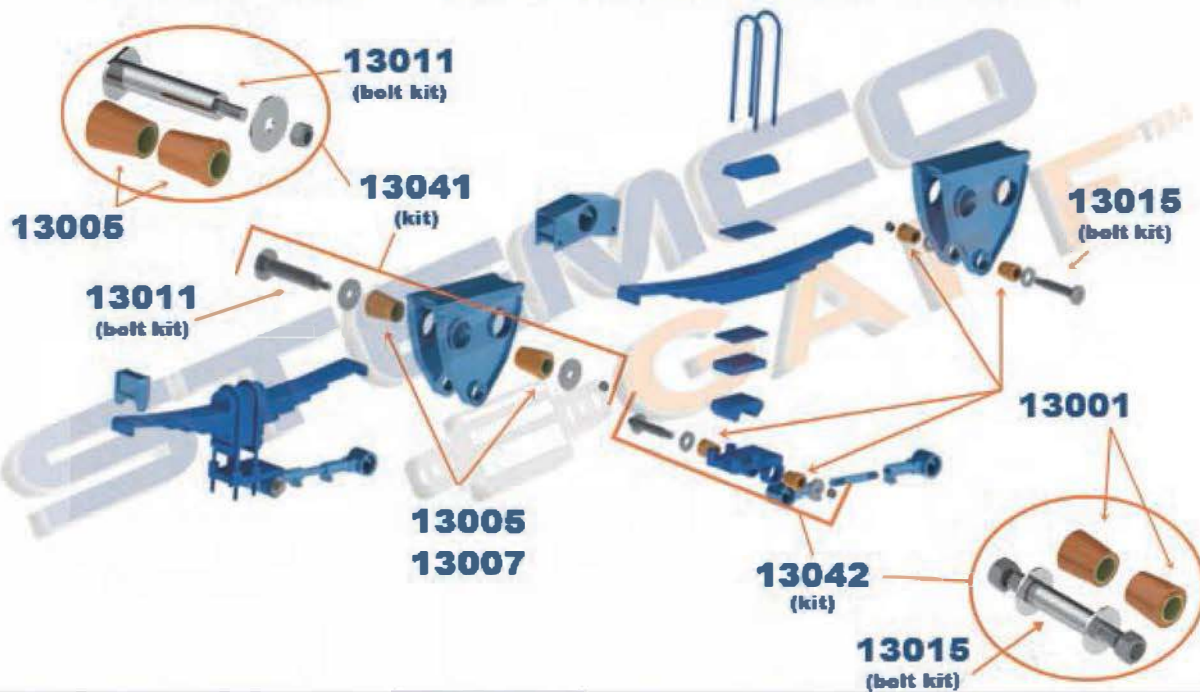

**STEMCO GAFF replacement parts compatible with:
FRUEHAUF™ F-2W SERIES**

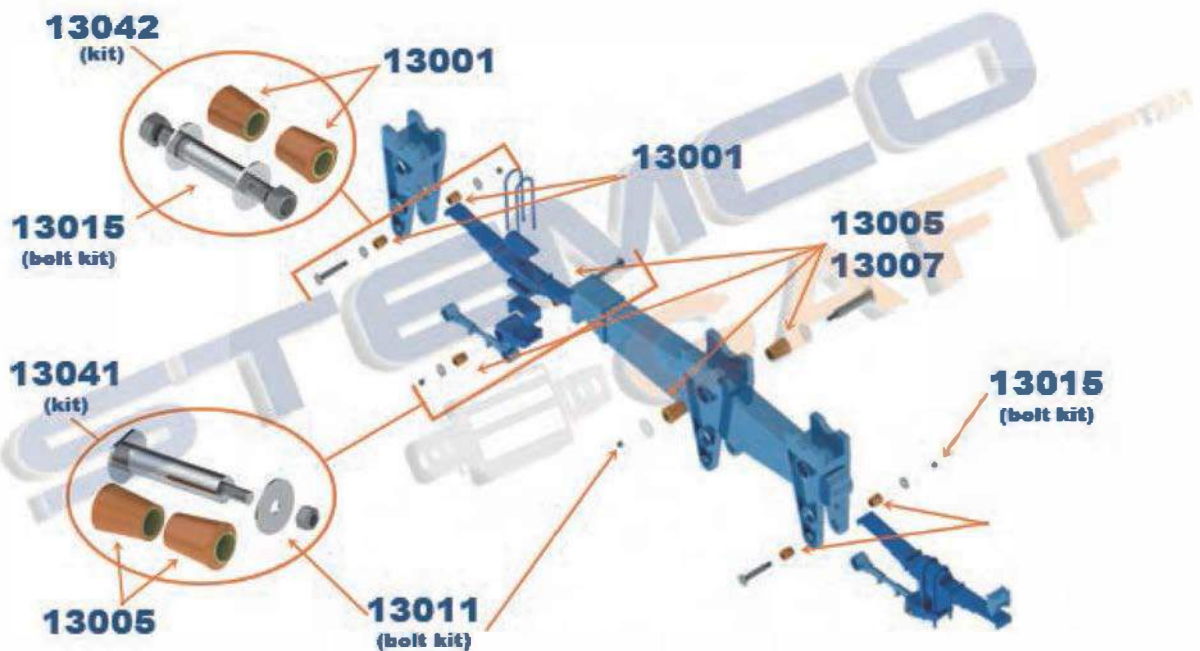

STEMCO GAFF replacement parts compatible with: FRUEHAUF™ J-2 SERIES

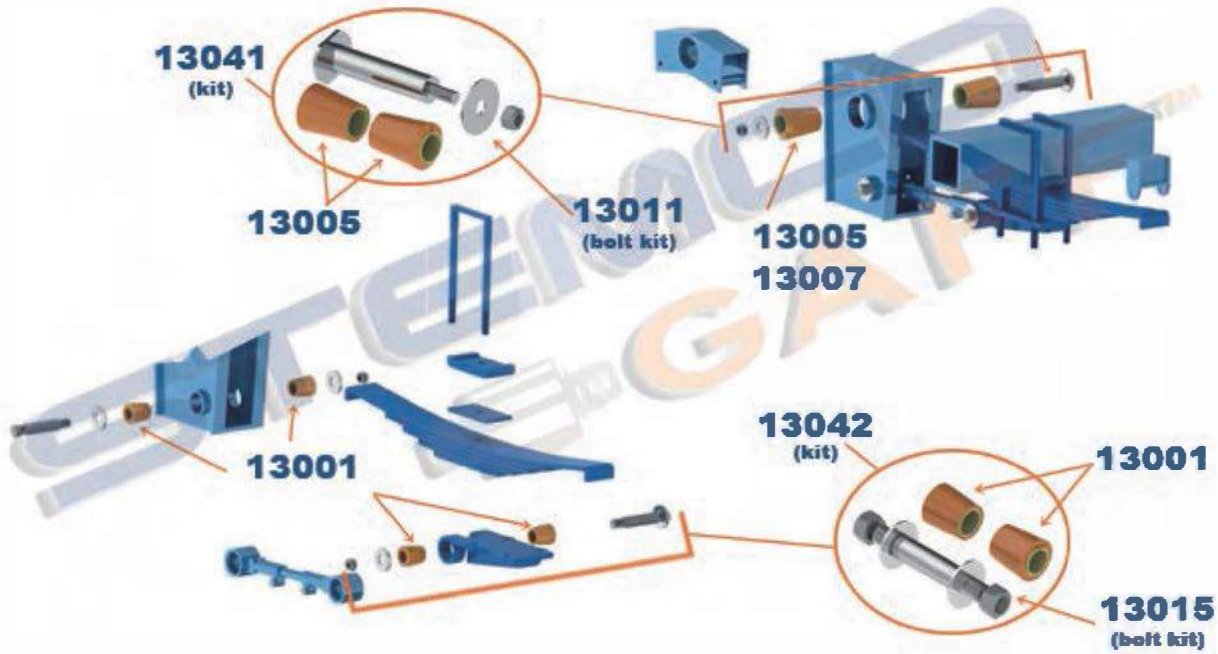

STEMCO GAFF replacement parts compatible with: FRUEHAUF™ M-2 SERIES - UNDERSLUNG

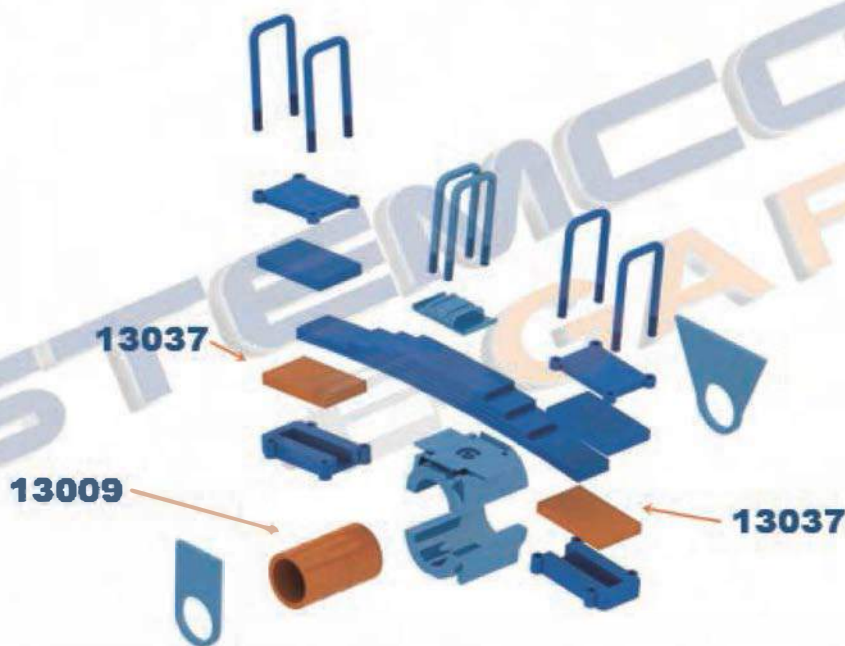

**STEMCO GAFF replacement parts compatible with:
FRUEHAUF™ M-2 SERIES**

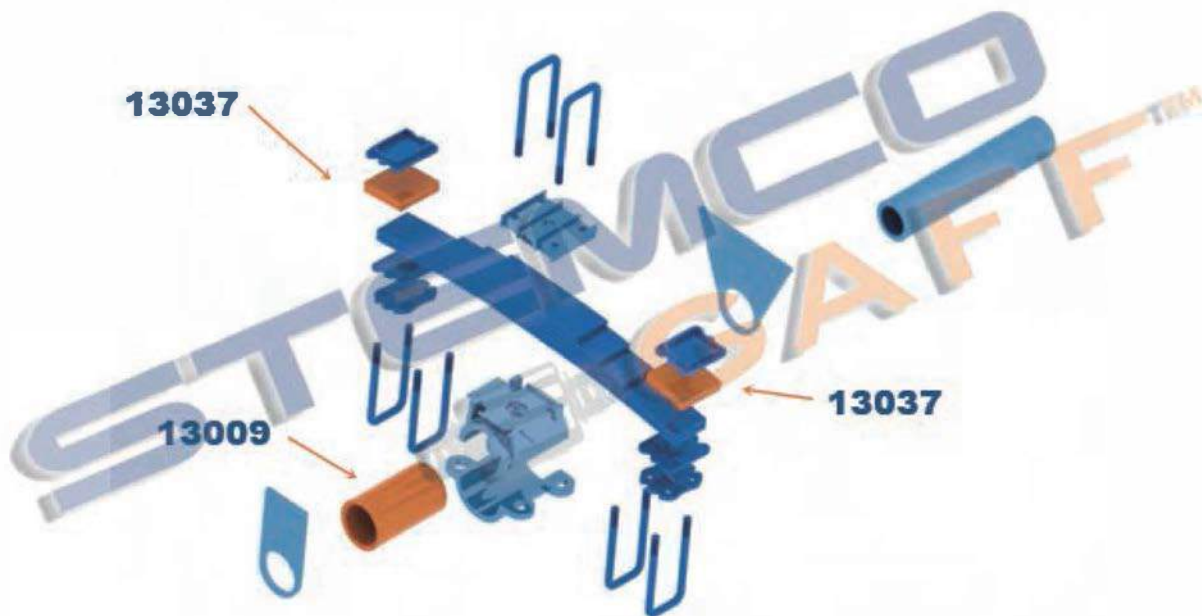

**STEMCO GAFF replacement parts compatible with:
FRUEHAUF™ M-2 SINGLE POINT
TRAILER SUSPENSION**



STEMCO GAFF replacement parts compatible with:
FRUEHAUF™ NF2 PRO-TRAC
FOUR SPRING TRAILER



STEMCO GAFF replacement parts compatible with:
FRUEHAUF™ NT SERIES

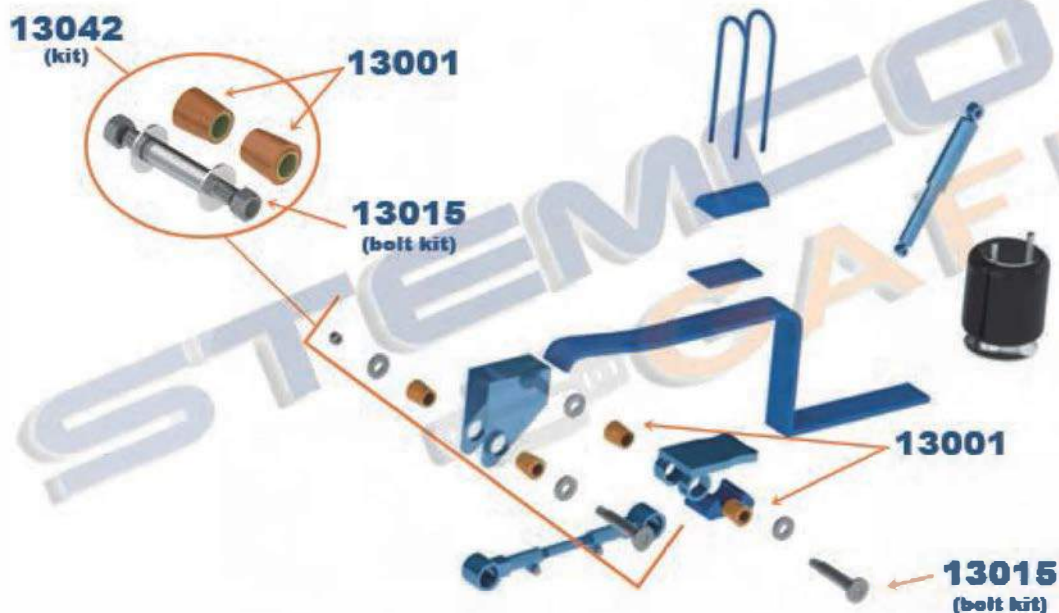

STEMCO GAFF replacement parts compatible with:
FRUEHAUF™ NT-2, NT-2W
PRO-TRAC AIR SUSPENSION

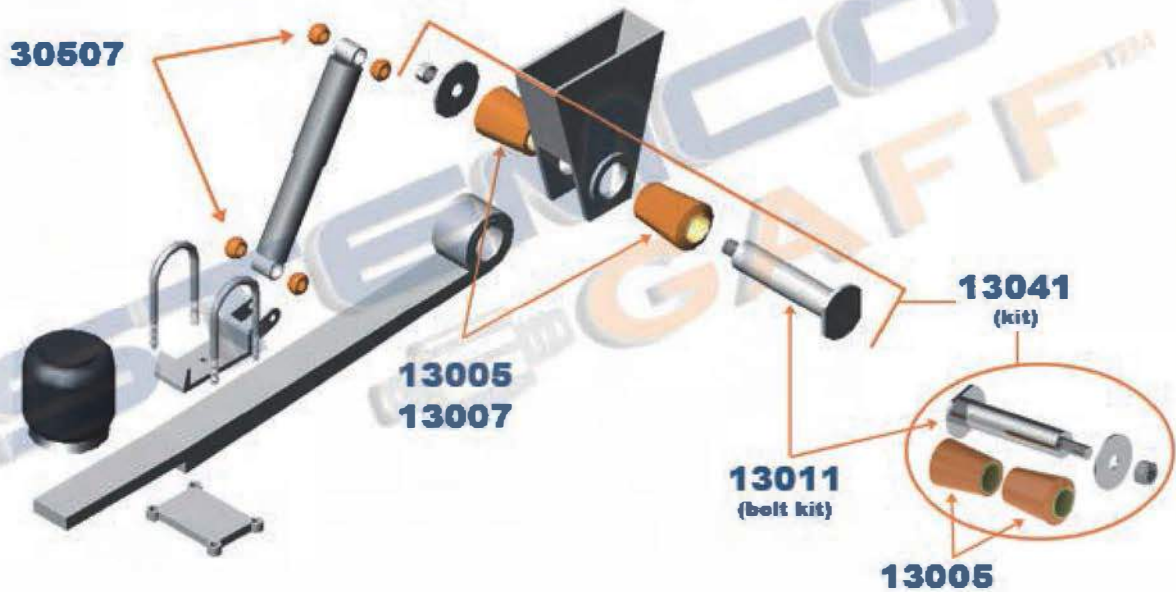

STEMCO GAFF replacement parts compatible with:
FRUEHAUF™ W24T1 / T SERIES



Fruehauf continued

13001



Torque Rod Bushing

OD	2 3/16"
OD<	1 13/16"
ID	1 1/4"
LG	2 3/8"
HD	90A

INCLUDED IN:
13042

OEM
UXA-000011
25-750PU
R30927
RBT200
E-7433
D100
321-177
M1818
TRB6300
PL1084

Notes: hard poly inner sleeve

13005



Equalizer Bushing

OD	3 1/2"
OD<	2 11/16"
ID	2
LG	4 7/16"
HD	90A

INCLUDED IN:
13041

OEM
UXA-000004
15-1203PU
R307432
FR263
E-7432
D214
321-190
TRB5384
PL1085

Notes: no tool needed, bushing is pressed into the equalizer using the bolt / uses bolt 13011/13007 - narrow

13007



Equalizer Bushing
Narrow

OD	3 7/16"
OD<	2 5/8"
ID	2
LG	4 7/16"
HD	97A - 80A

OEM
A80BL1050

Notes: no tool needed bushing is pressed into the equalizer using the bolt / use bolt 13011/13005 -standard

13009



Trunnion Bushing

OD	5
ID	4
LG	8 1/4"
HD	80A

OEM
UXA-000160
UXA-000160SP1
UXA-000160SPX
UXA-0160
R308663
E-8663
D218
325-150
M9626
PL1004

Notes:

13010



Spring Pad

THK	5/8"
WD	5
LG	6
HD	80A

OEM

Notes:

13011



Equalizer Bolt

OD	2
LG	11
THR	1" - 14 UNF

INCLUDED IN:
13041

OEM
UXA-0015001
15-1204
FR267
E-1019
334-453A
M1807
TRS4309

Notes: used with 13005 and 13007

13015



Torque Rod Bolt

OD	1 1/4"
LG	7 1/8"
THR	1" - 14 UNF

INCLUDED IN:
13042

OEM
UXA-000016
E-1018
334-566
TRS3309

Notes: used with 13001

13037



Spring Pad

THK	1
WD	4 3/4"
LG	7 5/8"
HD	80A

OEM
UCD-005635001
UCD-5635-001
R308664
FR220
E-8664
D217
325-151
09-2274
M9632
PL1005

Notes:

13041

INCLUDES
QTY 2
QTY 1

13005
13011



Equalizer Bushing Kit

OEM
UXA-00004-900
UXA-0004-900
FR264
E-1024
E-9361
D214
334-452A
TRK5384HD
TRK5384UB
EQ47-35900

Notes: no tool needed bushing is pressed into the equalizer using the bolt

13042

INCLUDES
QTY 2
QTY 1

13001
13015



Torque Rod Bushing Kit

OEM
UXA000011-900
UXA-000011900
15-1217
H236
E-9362
334-565
334-640
TRK6300
TH47-37900
TH53-37637

Notes: no tool needed bushing is pressed into the equalizer using the bolt

14000

OD 3 5/16" ~
LG 3 7/8" ~
BH 3/4" ~
HD 80A



Equalizer Bushing

OEM
UCA-0472
25-705PU
R307452
H102
E-7452
D95
321-176U
M1452
TRB5541
EQ53-35234

Notes:

14003

OD 2 3/16" ~
OD< 1 13/16" ~
ID 1 1/4" ~
LG 2 3/8" ~
HD 90A



Torque Rod Bushing

OEM
586121
UXA-0011
25-750PU
RB200
E-7433
E-927
D100
M1818
09-2247
TRB6300

Notes: no inner sleeve flat sides / uses bolt 13015 / 13001- hard poly inner sleeve

14008

OD 1 15/16" ~
ID 1" ~
LG 3" ~
HD 80A



Torque Rod Bushing

TOOL 18836

OEM
UCA-3754
25-708PU
R30934
RB201
E-934
D94
321-175
M1888
TRB6326
PL1119

Notes: chamfered / stepped ends - 14073

14073

OD 1 15/16" ~
ID 1" ~
LG 3" ~
HD 80A



Torque Rod Bushing

TOOL 18836

OEM
UCA-3754
25-708PU
R30934
RB201
E-934
D94
321-175
09-3344
TRB6326
PL1119

Notes: stepped ends / new design / chamfered - 14008

14513

OD 3 1/2" ~
ID 1 1/8" ~
LG 5 1/4" ~
HD 80A



Beam End Bushing

OEM
MNW900081395
60-1535
R304382A
N120
E-8683
D441
321-229
M3456
TRB5713
PB57-21139

Notes: additional tool suggestion 14531

14529

OD 2 13/16" ~
ID 1" ~
LG 5 1/8" ~
HD 80A



Center Bushing

OEM
MNW90008148S
60-1501
R304410A
N124
E-4410A
321-231
TRB-5703

Notes:

Fruehauf continued

17501



Camshaft Bushing

OD	1 7/8 ~
ID	1 1/2 ~
LG	1 3/16 ~
HD	71D

OEM
515147
E-5512
02-210

Notes:

17502



Camshaft Bushing

OD	2 7/8 ~
OD<	2 1/16 ~
ID	1 5/8 ~
LG	2 7/16 ~
HD	71D

OEM
AXA-0429-900
E-1571

Notes:

17505



Camshaft Bushing

OD	2 3/16 ~
ID	1 5/8 ~
LG	7/8 ~
HD	71D

OEM
AXA-0413-900
E-1567

Notes:

17574



Camshaft Bushing

OD	2 3/16 ~
ID	1 1/2 ~
LG	7/8 ~
HD	71D

OEM
ACA-3266

Notes:

17668



Camshaft Bushing

OD	2 7/16 ~
ID	1 5/8 ~
LG	1 1/2 ~
HD	71D

OEM
ACD-2285-900
E-1577A

Notes:

18566



Shock Absorber Bushing

OD	1 7/8 ~
ID	1 ~
LG	1 ~
HD	80A

OEM
663400
40-340
R307529
HB593
E-7529
D1
320-153
M695
MH1432
PL1026

Notes:

30507



Shock Absorber Bushing

OD	1 15/16 ~
ID	1 ~
LG	15/16 ~
HD	80A

OEM
1T18197A
2350908
2350908U
12-5-123
12-5-123A
SB03-83008

Notes:

DESCRIPTION	OEM	PART ID	PAGE
Beam End Bushing	2325973 / 20-809PU / R309511 / C865 / E-9511 / 321-120 / M1724 / 09-5501 / M1976 / EB34000	13501	58
Beam End Bushing	2359281 / 15533787 / 20-810PU / R302771 / C871 / E-9512 / D402 / 321-242 / M1988 / EB38000	13553	58
Beam End Bushing Kit	12387455 / 20-861 / R309325 / BP-87 / E-9325 / 334-830 / 09-5524 / 09-5528 / BP198 / EB50-21013	13607	59
Cab Mount	2005774 / 15506936 / R307439 / R308650 / E-7439 / E-8650 / D56 / 329-117U / PL1087 / PL1088	18222	61
Cab Mount	19875340	18760	61
Camshaft Bushing	15664483 / E-5512 / 02-210	17501	56
Camshaft Bushing	714923 / E-2361	17529	61
Camshaft Bushing	714906 / E-2551	18439	61
Carrier Bearing Assy	15512196 / DS-6049	40074	62
Carrier Bearing Assy	2406989 / DS-6048	40075	62
enter Bushing	2325972 / 15533680 / R309520 / 20-816 / C864 / E-9520 / 321-119 / 09-5500 / M1978 / CB34012	13500	58
Center Bushing	2359280 / 20-817 / R309359 / C887 / E-9359 / 321-243 / 09-5513 / M1972 / M1972UB / CB38012	13505	58
Easy-Mount Torque Rod Bushing	12477594 / 20-859 / R309326 / BP-87 / BP-88 / E-9326 / 334-831 / 09-5525 / BP200	83596	62
Load Pad	2423368 / C3TZ5899B / 26953 / 48972 / 48973 / 26953-000 / 48973-000 / 427893R1 / 42984R1 / 20-824 / 20-826PU / R301598A / R301960 / R309513 / LC1 / LC1UB / LC3 / LC3UB / E-1598A / E-1599A / E-1960 / E-9513 / D135 / 325-101 / 325-103 / 325-104 / 325-104U / M2062 / 09-5532 / 09-5536 / 09-5537 / MLC4 / 750501 / A80BL1031 / 683671 / 683672 / MLC8 / HC20000	13650	59
Lower Shock		16006	60
Motor Mount	15624948	16035	60
Motor Mount	702727 / 10-1059PU / 75-1759PU / R307440 / E-7440 / D54 / 329-110U / 329-165U / M17348 / PL1086	18232	61
Motor Mount	1506314	18847	62
Overload Cushion		16007	60
Rebound Roller Kit	15963119	11747	58
Spring Bushing		16002	59
Spring Bushing		16003	60
Spring Bushing		16032	60
Spring Bushing		16034	60
Spring Bushing Kit	3765438 / E694-55 / IS620 / 334-964 / MIH14UB / MIS1486 / SK00-10500 / SK55-10600 / SK55-10700 / SP55-113C1	19001	62
Spring Pad		16004	60
Spring Pad		16005	60
Spring Pin Bushing	2017504 / 50-275 / TB68 / 327-434 / 50-275 / TB-68 / M5212 / SP59-11010	11758	58
Stabilizer Bar Bushing	3927019 / R210608 / E-6616 / 320-110	16000	59
Suspension Mount	14994568	18698	61
Torque Rod Bushing	686924	13525	58
Torque Rod Bushing	14994876	18693	61
Torque Rod Bushing	723330 / 2383283 / 2426422 / 2449224 / TH03-82750 / TH03-85001 / TH03-85033	33502	62
Torque Rod Bushing	723330 / 2383283 / 2426422 / 2449224 / TH03-82725	33503	62
Torque Rod End Assy	15533801 / 20-9034 / MR660 / 345-660 / 09-5431 / R660 / TR75000	13690	59
Torque Rod End Assy	15533803 / 20-9031 / MR670 / 345-670 / 09-5432 / R670 / TR81000	13692	59
Torque Rod End Assy	15533809 / 20-9036 / MR700 / 345-700 / 928700 / 09-5434 / R700 / TR85000	13698	59
Torque Rod End Assy	15533810 / 20-9026 / MR701 / E-10319 / 345-701 / 928701 / 09-5430 / R701 / TR85000	13699	59
Transmission Mount	686924	18125	61
Vertical Drive Bushing	2425394 / R309515 / C874 / E-1940 / E-9515 / D107 / 321-125 / 09-5535 / TRB5170 / HV38000	13592	58

GMC continued

11747



Rebound Roller Kit

OD 2 1/2 ~
ID 9/16 ~
LG 3 5/8 ~
HD 80A

INCLUDES

QTY 1 Roller
QTY 1 Bolt
QTY 2 Flat Washer
QTY 1 Metal Sleeve
QTY 1 Lock Nut

OEM
15963119

Notes: components not sold separately

11758



Spring Pin Bushing

OD 1 3/4 ~
C-C 5 3/4 ~
HD 80A

INCLUDED IN:
11757

OEM
2017504
50-275
TB68
327-434
50-275
TB-68
M5212
SP59-11010

TOOL 40090

Notes:

13500



Center Bushing

OD 3 5/8 ~
OD< 2 3/4 ~
LG 12 ~
HD 80A

INCLUDED IN:
13503, 13504, 13591

TOOLS 18543, 18544

OEM
2325972
15533680
R309520
20-816
C864
E-9520
321-119
09-5500
M1978
CB34012

Notes: welded plug

13501

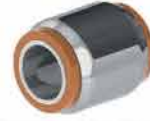

Beam End Bushing

OD 4 3/8 ~
ID 2 1/2 ~
LG 5 1/4 ~
HD 80A

INCLUDED IN:
13503, 13504

TOOLS 13564, 18541, 18542

OEM
2325973
20-809PU
R309511
C865
E-9511
321-120
M1724
09-5501
M1976
EB34000

Notes: for complete repair use adapter 13502 / additional tool suggestion 13588

13505



Center Bushing

OD 4 3/4 ~
OD< 3 1/2 ~
LG 12 ~
HD 80A

INCLUDED IN:
13508, 13548, 13587

TOOLS 13570, 18539, 18540

OEM
2359280
20-817
R309359
C887
E-9359
321-243
09-5513
M1972
M1972UB
CB38012

Notes: standard-welded plug / double bonded-welded plug - 13636 / standard-loose plug - 13543

13525



Torque Rod Bushing

OD 3 1/2 ~
C-C 4 3/8 ~
BH 5/8 ~
HD 80A

TOOL 18831

OEM
686924

Notes:

13553



Beam End Bushing

OD 4 3/8 ~
ID 2 1/2 ~
LG 5 3/4 ~
HD 80A

INCLUDED IN:
13587

TOOLS 13563, 13588

OEM
2359281
15533787
20-810PU
R302771
C871
E-9512
D402
321-242
M1988
EB38000

Notes: uncrimped sleeve double bonded bushing / supersedes 13506 / use adapter 13507 for complete repair / additional tool suggestion 13595

13592



Vertical Drive Bushing

OD 4 1/8 ~
ID 2 ~
LG 4 ~
HD 80A

OEM
2425394
R309515
C874
E-1940
E-9515
D107
321-125
09-5535
TRB5170
HV38000

Notes:

13607



Beam End Bushing Kit

OD	4 3/8"
BH	1 1/16"
HD	80A

OEM
12387455
20-861
R309325
BP-87
E-9325
334-830
09-5524
09-5528
BP198
EB50-21013

TOOL 13595

Notes: double bounded / straight sleeve / wider inner pin no shims required/ for options requiring shims standard - 13596 or easy mount - 83596

13650



Load Pad

OD	6 3/4"
ID	3 15/16"
ID<	3 1/8"
THK	4 1/16"
LG	11 15/16"
HD	80A

OEM
2423368
C3TZ5899B
26953
48972
48973
26953-000
48973-000
427893R1
42984R1
20-824

Notes:

13690



**Torque Rod End Assy
35" Rod End**

LG	33 7/16"
BC-C	4 3/8"
BH	5/8"
HD	80A

INCLUDES
QTY 1 13707
QTY 1 13520

OEM
15533801
20-9034
MR660
345-660
09-5431
TMR660
TR75000

Notes:

13692



**Torque Rod End Assy
35" Rod End**

LG	33 7/16"
LG ²	6 5/8"
THR	1 1/4" - 12 UNF
HD	80A

INCLUDES
QTY 1 13707
QTY 1 13684

OEM
15533803
20-9031
MR670
345-670
09-5432
TMR670
TR81000

Notes:

13698



**Torque Rod End Assy
36" Rod End**

ID	1 1/8"
LG	34 7/16"
LG ²	3 1/4"
HD	80A

INCLUDES
QTY 1 13708
QTY 1 13516

OEM
15533809
20-9036
MR700
345-700
928700
09-5434
TMR700
TR85000

Notes:

13699



**Torque Rod End Assy
27" Rod End**

ID	1 1/8"
LG	25 7/16"
LG ²	3 1/4"
HD	80A

INCLUDES
QTY 1 13682
QTY 1 13516

OEM
15533810
20-9026
MR701
E-10319
345-701
928701
09-5430
TMR701
TR85000

Notes:

16000



Stabilizer Bar Bushing

ID	1 5/16"
WD	2 1/2"
LG	1 7/16"
HGT	2 9/16"
HD	80A

OEM
3927019
R210608
E-6616
320-110

Notes:

16002



Spring Bushing

OD	1 1/2"
ID	9/16"
LG	3
HD	80A

OEM

Notes:

16003

OD	1 3/4"
ID	3/4"
LG	3 1/4"
HD	80A

OEM



Spring Bushing

Notes:

16004

THK	1 1/8"
WD	3 13/16"
LG	2 7/8"
HD	80A

OEM



Spring Pad

Notes:

16005

THK	1 5/16"
WD	4 3/4"
LG	3 3/16"
HD	80A

OEM



Spring Pad

Notes:

16006

THK	3 1/16"
WD	2 3/16"
HD	70A

OEM



Lower Shock

Notes:

16007

OD	1 15/16"
LG	2 5/16"
HD	70A

OEM



Overload Cushion

Notes:

16032

OD	1 9/16"
OD<	1 1/4"
ID	3/4"
LG	1 1/2"
HD	90A

OEM



Spring Bushing

Notes:

16034

OD	2 1/16"
OD<	1 13/16"
ID	3/4"
LG	1 1/2"
HD	80A

OEM



Spring Bushing

Notes:

16035

OD	3 13/16"
ID	5/8"
LG	2 1/2"
HD	80A

OEM
15624948

Motor Mount

Notes: components not sold separately

17501



Camshaft Bushing

OD	1 7/8"	OEM 15664483 E-5512 02-210
ID	1 1/2"	
LG	1 3/16"	
HD	71D	

Notes:

17529



Camshaft Bushing

OD	2 1/2"	OEM 714923 E-2361
ID	1 1/2"	
LG	1 3/4"	
HD	71D	

Notes:

18125



Transmission Mount

THK	2 5/8"	OEM 686924
WD	3 1/4"	
LG	4 7/8"	
THR	1/2" - 13 UNC	
HD	80A	

Notes:

18222



Cab Mount

OD	2 7/16"	OEM 2005774 15506936 R307439 R308650 E-7439 E-8650 D56 329-117U PL1087 PL1088
OD<	1 5/8"	
ID	5/8"	
LG	1 15/16"	
HD	80A	

Notes:

18232



Motor Mount Front

OD	3 1/4"	OEM 702727 10-1059PU 75-1759PU R307440 E-7440 D54 329-110U 329-165U M17348 PL1086
OD<	2 1/4"	
ID	1 11/16"	
LG	2 5/8"	
HD	80A	

Notes:

18439



Camshaft Bushing

OD	1 7/8"	OEM 714906 E-2551
ID	1 1/2"	
LG	1 11/16"	
HD	71D	

Notes:

18693



Torque Rod Bushing

OD	2 3/4"	OEM 14994876
ID	2 1/2"	
LG	2 11/16"	
HD	71D	

Notes:

18698



Suspension Mount

OD	4 5/16"	OEM 14994568
ID	2 1/2"	
LG	1 1/16"	
HD	80A	

Notes:

GMC continued

18760

OD	2 3/16"
ID	3/4"
LG	1 5/8"
HD	80A

OEM
19875340



Cab Mount

Notes: components not sold separately

18847

OD	4"
ID	5/8"
LG	2 1/16"
HD	80A

OEM
1506314



Motor Mount Front

Notes: components not sold separately

19001

OD	1 1/2"
ID	1"
LG	3"
HD	90A

OEM
3765438
E694-55
IS620
334-964
MIH14UB
MIS1486
SK00-10500
SK55-10600
SK55-10700
SP55-113C1



Spring Bushing Kit

Notes: components not sold separately

33502

OD	3 5/8"
ID	2 1/2"
LG	2 1/2"
HD	80A

OEM
723330
2383283
2426422
2449224
TH03-82750
TH03-85001
TH03-85033



Torque Rod Bushing

Notes: solid design / 33503 - open design

33503

OD	3 3/4"
ID	2 1/2"
LG	2 1/2"
HD	80A

OEM
723330
2383283
2426422
2449224
TH03-82725



Torque Rod Bushing

Notes: open design / 33502 - solid design

40074

ID	2 3/8"
C-C	8 1/2"
BH	1/2"
HGT	3 21/64"
HD	70A

OEM
15512196
DS-6049



Carrier Bearing Assy

Notes: includes carrier bearing bushing 18002

40075

ID	2"
C-C	7 7/16"
BH	1/2"
HGT	2 25/32"
HD	70A

OEM
2406989
DS-6048



Carrier Bearing Assy

Notes: includes carrier bearing bushing 18725

83596

OD	4 3/8"
C-C	8 1/2"
BH	1 1/16"
HD	80A

OEM
12477594
20-859
R309326
BP-87
BP-88
E-9326
334-831
09-5525
BP200



Easy-Mount Beam End Bushing

TOOL 18542, 13588

Notes: easy mount / standard - 13596 / no shims required - 13607

Hendrickson

DESCRIPTION	OEM	PART ID	PAGE
Alignment Shim	201-05-120 / 50130-000 / 20-847 / HS41 / E-9327 / 334-879	13665	90
Auxiliary Load Spring	641794 / 60314000 / 64179004 / HS99 / E-14047 / 334-1720 / MHS225K / LP50-24974	13611	88
Auxiliary Load Spring	49395 / 49395-000 / R309416 / E-9416 / 334-848 / 09-6110 / MLC2 / HS11000	13625	88
Beam Bushing Kit		13503	80
Beam Bushing Kit	4500013L / R302862 / SK80340	13504	80
Beam Bushing Kit		13508	80
Beam Bushing Kit	5919 / 49400 / 110222 / 34013088 / 29483-5 / 34013-88L / 49400-000 / SK80382	13548	84
Beam Bushing Kit	70000-2 / HCK380 / E-2863 / 339-102 / HCK100 / SK80380 /	13587	86
Beam Bushing Kit		13662	90
Beam End Adapter	45000005 / 45000013 / 45000-013 / 4500013L / R302372 / 20-802 / HAK34 / E-2372 / 334-108 / AK34100	13502	80
Beam End Adapter	496530 / 45000-007 / 20-800 / HAK38 / E-2374 / 334-109 / HAK100	13507	80
Beam End Adapter	211407 / R302555 / 20-806 / HAK50 / E-2555 / 334-138 / 09-5472 / HAK124 / AK50100	13547	84
Beam End Adapter	46493-000 / AK65100	13549	85
Beam End Adapter Kit	21140-034 / 21140-34 / R309420 / 20-801 / HAK44 / E-9420 / 334-467 / 09-5462 / HAK112 / AK38200	13609	87
Beam End Adapter Kit	21140-033 / 21140-33 / 2114033L / 45000 011L / R309421 / 20-805 / E-9421 / 334-1123 / AK45100 / AK50-45000	13610	88
Beam End Bushing	6969 / 06969-000L / R309511 / 20-809PU / C865 / E-9511 / D404 / 321-120 / M1976 / EB34000	13501	80
Beam End Bushing	45900-000	13506	80
Beam End Bushing	10363 / 10363-000 / 10363L / R302554 / 20-813 / C872 / E-2554 / 321-129 / 09-5471 / EB50000	13545	84
Beam End Bushing	10364 / 10364-000 / 20-814 / 321-318 / 09-5451 / EB65000	13546	84
Beam End Bushing	45900 / 29878-1 / 45900-000L / R302771 / 20-810PU / C871 / E-1341A / 321-242 / M1988 / EB38000	13553	85
Beam End Bushing	45407 / 45407-000 / 45407L / R309419 / C875 / E-9419 / 321-127 / 321-127U / 09-5460 / EB45000	13560	85
Beam End Bushing	34013088 / 34013-88L / R309326 / 20-859 / BP-88 / E-9326 / 334-831 / 09-5525 / BP200	13596	87
Beam End Bushing Kit		13531	83
Beam End Bushing Kit	34013-051 / 3401351L / 334-960 / 09-5674	13562	85
Beam End Bushing Kit	34013050 / 34013-049 / 34013-050 / 34013-073 / 34013-49 / EA38000 / BA122 / BA122UB / BA123 / 334-381 / E-5309 / BA49 / BA50 / R305309 / R309577 / 3133712 /	13566	86
Beam End Bushing Kit		13574	86
Beam End Bushing Kit	10363 END BUSHING / 211407 ADAPTER KIT / EA50000	13586	86
Beam End Bushing Kit		13591	86
Beam End Bushing Kit	50150 / 50150000 / 34013-087L / 34013-87 / R309325 / 20-861 / BP-87 / E-9325 / 334-830 / EB50-21013	13607	87
Bolster Spring	49377 / 49377-000 / 60879-000 / HS56 / E-11496 / 334-852 / HS10000 / LP50-24000 / SK80268	13601	87
Bolster Spring Kit	64179-002 / 64179-037 / HS130 / E-14044 / E-14374 / 334-1727 / 334-1845 / MLC3 / MLC5 / LP50-24179	13626	88
Bolster Spring Kit	49377 / 60879 / 641794 / 60314000 / 64179004 / 49377-000 / 60879000L / 60879L / LP50-24000 / LP50-24974	13722	93
Bolster Spring Pair	49377 / 60879 / 49377000 / 60879000L / 60879L / HS56 / E-11496 / 334-852 / HS10000 / LP50-24000	13721	93
Bolt Kit	48941 / 56659-1 / B1509-50 / 334-832 / BPK100	13555	85
Center Bushing	20-816 / 6664 / 22279 / 06664-000L / 29481-5 / R309520 / C864 / E-9520 / 321-119 / CB34012	13500	79

Hendrickson continued

DESCRIPTION	OEM	PART ID	PAGE
Center Bushing	5919 / 49400 / 110222 / 29483-5 / 49400-000 / 5919-000 / R309359 / E-9359 / 321-243 / CB38012	13505	80
Center Bushing	30437000L / 34013-054 / 3401354L / 20-860 / R301546 / HBK38 / E-1546 / 322-102 / 08-6301 / HBK100	13534	83
Center Bushing	22279 / 22279-000L / R301594 / C866 / E-1594 / D403 / 321-118 / 09-5620 / CB34010 / CB34011	13537	83
Center Bushing		13538	83
Center Bushing	22282 / 49600 / 22282-000L / 49600-000 / R309510 / 20-820 / E-9510 / 321-244 / CB38010 / CB38011	13543	84
Center Bushing	10366 / 10366-000 / 10366L / R302553 / 20-818 / C873 / E-2553 / 321-128 / CB50000 / CB50011	13544	84
Center Bushing	29483-005 / 34013-097 / E-9359 / C2000	13656	89
Center Bushing	15464 / 15464-000 / 321-317 / 09-5450 / CB65002 / CB65011	13658	89
Center Bushing Kit	30437-000 / 30437L / R301546 / 20-860 / HBK38 / E-1546 / 322-102A / HBK100	13558	85
Control Arm Bushing	004931 / PB00-36314	34514	94
Easy-Mount Torque Rod Bushing	44695 / 64400-002L / 66649-002 / R307639 / 20-833PU / C879 / E-7639 / 321-132 / TRB6820 / TS38000	83520	95
Easy-Mount Torque Rod Bushing	44694 / 44694-000L / R307638 / 20-832PU / C878 / E-7638 / 321-131 / TRB6164 / TS34000 / TS34095	83522	95
Easy-Mount Torque Rod Bushing	34013088 / 34013-088L / 34013-88L / R309326 / 20-859 / BP-87 / BP-88 / E-9326 / 334-831 / BP200	83596	95
Eccentric Washer, Bolt Kit	60632-006 / S-20924 / S-20925 / S-21052 / S-24679 / R3010730A / E-10730A / 334-1579 / 334-1699	13604	87
Eccentric Washer, Bolt Kit	S-20924 / S-20925 / S-23319	13673	90
Equalizer Bushing	47420 / 48402 / 48932 / R309401 / C868 / E-9401 / D425 / 321-245 / TRB5168 / CB27500	13526	82
Inner Bushing Sleeve	S-20681 / E-3770 / 334-1134 / DLS118634	13541	84
Load Pad	26953 / 48972 / 48973 / 26953-000 / 48973-000 / 20-824 / LC3 / E-9513 / 325-104 / HC20000	13650	89
Overload Cushion	24209 / 24209-000 / R309514 / 20-823 / LC4 / E-9514 / D134 / 325-100 / MLC10 / HC10000	13649	89
Pivot Bushing	58648000 / 58648-000 / HS102 / 321-387 / RB299 / TRB5031 / PB50-26648	18821	94
Rebound Roller Kit	57989000	11747	78
Rebound Roller Kit	48883-000 / 49175-005 / 49175-013 / 57989-000 / R309432 / HS65 / E-9432A / 334-527 / 09-5184 / MHS79K	13527	82
Spring Bushing	RB211 / RB233 / RB-211 / RB-233 / SP46-52800 / 16-17769-00 / 680-322-01-05 / 680-322-01-50	11066	77
Spring Bushing		11123	78
Spring Bushing		13511	81
Spring Bushing	47421 / 48401 / 48929 / R309566 / 20-843 / C886 / E-9566 / 321-246 / TRB5911 / EB27500	13512	81
Spring Mount	593461 / 58918-000	18994	94
Spring Mount Kit	609612 / 325-242	13725	93
Spring Pin Bushing	52296 / RB205 / RB268 / E-8804 / RB-157-OS / RB-205 / RB-268 / MR782 / PB46-26268 / UB20500-OS	11083	77
Spring Pin Bushing	RB263 / RB-263 / MR772 / MR772UB / SP46-11023 / 16-14603-000 / 16-17194-000 / 16-17770-000 / 16-18023-000	11094	77
Spring Pin Bushing	50252 / 50-275 / TB68 / 327-434 / 50-275 / TB-68 / M5212 / SP59-11010	11758	79
Suspension Bushing	A-6914 / S-6914 / HT207 / E-6121 / 334-658 / TRK5912 / PB50-36914	13510	81
Suspension Bushing	C-3558 / S-6914 / R3010729A / R306121 / HT207 / TRB5912	13565	85
Suspension Bushing	D-25364 / S-23320 / S-26321 / 22-904 / HT249 / E-14377 / DT1610 / 334-1628 / TRB5914UB / PB50-36321	13594	87
Suspension Bushing	S-24691 / HT245 / E-10729A / 334-1576 / TRB5912 / PB50-36100	13600	87

Hendrickson continued

DESCRIPTION	OEM	PART ID	PAGE
Suspension Bushing	S-21166 / S-24691 / R3010729A / HT245 / E-10729A / 334-1576 / MHS736 / PB50-36000	13628	88
Suspension Bushing		13671	90
Torque Rod	64473-000 / 64474-000 / TR60000 / TR70005 /	13590	86
Torque Rod	587575 / 58757-005	13597	87
Torque Rod		13629	88
Torque Rod Assy	62000-610 / 925030 / TR59-41375	11751	78
Torque Rod Assy	46661 / 66661-000H / MR661 / UR661 / E-2642	12044	79
Torque Rod Assy	3226713 / TR62-413M3	12070	79
Torque Rod Assy	62000-615 / 92883-4 / TR62-41243	12071	79
Torque Rod Assy	62010-455 / TR50-42455	12396	79
Torque Rod Assy	62000-650 / 50-1437 / PB46 / E-7853 / 345-215 / TR75-41108	12398	79
Torque Rod Assy	57857006 / 943853 / R547 / TR62-41220	13634	89
Torque Rod Assy	62350-635 / 681-326-70-16 / 925150 / 925150 / A3580010-635 / S3580001-635 / S3580003-635 / TR59-41150	13679	90
Torque Rod Assy	62350-615 / TR50-41615	13733	93
Torque Rod Assy	48411006 / 50376001 / 62007365 / 32271-102 / E-9409 / 345-815 / TR50-41102	13735	93
Torque Rod Assy	62350-645 / TR50-41645	34555	95
Torque Rod Assy	62000-590 / 62001-590 / 924920 / 942174 / 944160 / 944220 / 948574 / TR50-42590	34556	95
Torque Rod Bushing	47691 / 47691000 / 20-836PU / R305275 / HS44 / E-5275 / D405 / 321-223 / TRB6185 / PL1146A	11004	77
Torque Rod Bushing		11509	78
	932420 / K195-415-13 / 35-505 / E-9324 / 321-335 / 321-335A / TRB6810	11511	78
Torque Rod Bushing	44694 / M2069	11556	78
Torque Rod Bushing	57256-000 / 40-334 / R309395 / VT21 / E9395 / E-9395 / 321-279 / TRB6165 / TS50-22256	11714	78
Torque Rod Bushing	R3010303 / E10303 / E-10303 / 321-369 / CS70815 / KB920 / 836940 / TS59-22400 / 836940 / 839310	11729	78
Torque Rod Bushing	46735 / 64400-007L / R302815 / R309518 / C884 / E-9518 / D293 / 321-136 / TRB6119 / 38000	12031	79
Torque Rod Bushing	45477 / R302238 / 20-850 / C870 / E-2238 / D316 / 321-141 / 09-5519 / TRB6186 / IN35190	13514	81
Torque Rod Bushing	476991 / 73073-1 / R303411 / 20-885 / RBT207 / E-3411 / D312 / 321-144 / TRB6260 / IN35180	13515	81
Torque Rod Bushing	46736 / 64400-010L / R302816 / 20-876 / C881 / E-13967 / 321-137 / 09-5716 / TRB6181 / TH50000	13516	81
Torque Rod Bushing	46734 / 64400-009L / R309517 / 20-834 / C880 / E-13964 / E-9517 / 321-135 / TRB6118 / TS49000	13517	81
Torque Rod Bushing	44697 / 64400-004L / 66649-004 / R308651 / 20-831PU / C883 / E-8651 / 321-133 / TRB6112 / TT38000	13518	81
Torque Rod Bushing	32174-000	13519	82
Torque Rod Bushing	44695 / 64400-002L / 66649-002 / R307639 / 20-833PU / C879 / E-7639 / 321-132 / TRB6820 / TS38000	13520	82
Torque Rod Bushing	47691 / 47691-000 / R305275 / 20-836PU / HS44 / E-5275 / 321-223 / TRB6185 / PL1146 / TS50-22691	13521	82
Torque Rod Bushing	44694 / 44694-000L / R307638 / 20-832PU / C878 / E-7638 / 321-131 / TRB164 / TS34000 / TS34095	13522	82
Torque Rod Bushing	32174-000	13525	82
Torque Rod Bushing	49210 / 64400-005L / 66649-005 / R303868 / 20-851PU / C889 / E-3868 / 321-265 / TRB6822 / TS38750	13528	83
Torque Rod Bushing		13532	83
Torque Rod Bushing	44697 / 20-831PU / R302228 / E-2228 / D422 / M2072 / 09-5721 / TRB6112 / TT38000	13533	83
Torque Rod Bushing	44695 / 64400-002L / 66649-002 / R307639 / 20-833PU / C879UB / E-7639 / 321-132U / M2070 / TRB6820UB	13536	83
Torque Rod Bushing	64697 / 64697-000 / HS73 / E-10309 / 321-360 / TT50-22697	13582	86

Hendrickson continued

DESCRIPTION	OEM	PART ID	PAGE
Torque Rod Bushing		13618	88
Torque Rod Bushing	60383000 / 60383-000 / C890 / E-14026 / 321-388 / TRB6205 / SU50-29383	13627	88
Torque Rod Bushing	65831-000	13652	89
Torque Rod Bushing	6966 / 06966000 / E-9519 / D410 / 321-320 / 09-5494 / TH85000	13659	89
Torque Rod Bushing	69210-000 / 69210-000H / 20-914 / HS79 / E-10322 / 321-366 / TRB6175 / TS50-22210	13672	90
Torque Rod Bushing	44809 / 44809-000 / R302227 / C885 / E-2227 / 321-134 / M2071 / 09-5720 / TRB6116 / TT34000	13684	90
Torque Rod Bushing	47692 / 47692-000 / R303362 / R305276 / 55-130 / R208 / E-5276 / 321-162 / TRB6025 / TH50-22692	14010	94
Torque Rod Bushing	A1712 / R301980 / R307520 / 55-129 / R129 / E-8687 / 321-153 / M1449 / PL1118 / UB30000	15013	94
Torque Rod Bushing	49305-1110 / TS45000	18830	94
Torque Rod Bushing Kit	A1712 / 55-11001 / R002 / E-1981 / E-9552 / 334-247 / TH83-22302	15063	94
Torque Rod End Assy	46610 / 66610-000H / IPC928610 / 1693531C1 / R301024 / R3010310 / R302639 / MR610 / UR610 / E-10310 / E-2639 / 345-610 / 345-741 / 345-742 / 928610 / 09-5420 / RU610 / TR71000	13683	90
Torque Rod End Assy	46630 / 66630-000H / MR630 / E-2638 / 345-738 / 928630 / RU620 / TR72000	13686	91
Torque Rod End Assy	46640 / 66640-000H / 20-9015 / MR640 / E-10313 / E-2810 / 345-640 / 09-5809 / R640 / TR82000	13687	91
Torque Rod End Assy	46650 / 66650-000H / 20-9016 / MR650 / E-10314 / 345-740 / M2085 / 09-5804 / R640 / TR84000	13688	91
Torque Rod End Assy		13689	91
Torque Rod End Assy	46660 / 66660-000H / 20-9034 / MR660 / 345-660 / 09-5431 / R660 / TR75000	13690	91
Torque Rod End Assy	46660 / 46661 / 66660-000H / 66661-000H / R302642 / MR661 / E-2642 / 345-742 / 928661 / TR75000	13691	91
Torque Rod End Assy	46670 / 66670-000H / 20-9031 / MR670 / 345-670 / 09-5432 / R670 / TR81000	13692	91
Torque Rod End Assy	46671 / R302641 / 20-9031 / MR671 / E-2641 / 345-736 / TR81000	13693	91
Torque Rod End Assy	46680 / 66680-000H / 20-9033 / MR680 / UR680 / E-2643 / 345-680 / 928680 / R680 / TR76000	13694	92
Torque Rod End Assy	46681 / 66681-000H / 20-9023 / MR681 / UR681 / E-10317 / 345-681 / 928681 / R681 / TR76000	13695	92
Torque Rod End Assy	46690 / 66690-000H / 20-9032 / MR690 / UR690 / 345-690 / 928690 / 09-5435 / R690 / TR77000	13696	92
Torque Rod End Assy	46691 / 66691-000H / R302812 / 20-9022 / MR691 / E-2812 / 345-691 / 928691 / R691 / TR77000	13697	92
Torque Rod End Assy	46700 / 66700-000H / 20-9036 / MR700 / 345-700 / 928700 / 09-5434 / R700 / TR85000	13698	92
Torque Rod End Assy	46701 / 66701-000H / 20-9026 / MR701 / E-10319 / 345-701 / 928701 / 09-5430 / R701 / TR85000	13699	92
Torque Rod End Assy	56766 / 66766-000H / MR766 / E-11784 / 345-612 / 942690 / TR83000	13700	92
Torque Rod End Assy	56767 / 66767-000H / 20-9017 / MR767 / E-11748 / 345-794 / 09-5807 / TR74000	13701	92
Torque Rod End Assy	57046 / 67046-000H / 345-614 / 928666	13702	93
Torque Rod End Assy	57047 / 67047-000H / 345-794 / 928665 / 09-5813 / TR78000	13703	93
Torque Rod End Assy	57048 / 67048-000H / 345-668 / 928668 / TR79000	13704	93
Torque Rod Mount	46868-000	18538	94
Vertical Drive Bushing	19279 / R309515 / C874 / E-1940 / E-9515 / D107 / 321-125 / 09-5535 / TRB5170 / HV38000	13592	86
Wear Pad	565572 / 56557-002 / HS-55 / E-9391 / 334-833 / 09-5097 / MMB985	13524	82
Wear Pad	565574 / 56557004 / 56929-000 / HS82 / HS83 / 334-1597 / 334-1602	13550	85
Wear Shim	B-21099 / S-21099 / HT258 / 334-1810	13648	89
Wear Shims	B1161-3 / S-1161-3 / R306122 / HT212 / E-6122 / 334-898 / 09-6241 / M14712	13542	84

STEMCO GAFF replacement parts compatible with:

**HENDRICKSON® -AIRTEK® / WESTERN STAR® /
FREIGHTLINER® / FORD® / STERLING®**

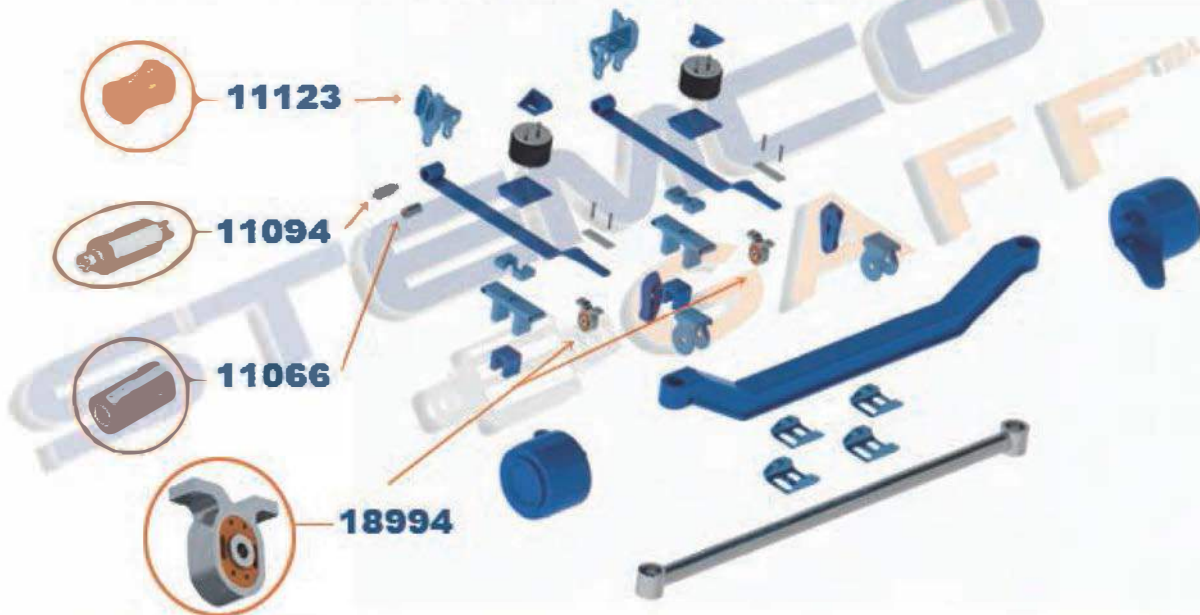

STEMCO GAFF replacement parts compatible with:

HENDRICKSON® E4-360/400 SERIES



STEMCO GAFF replacement parts compatible with: HENDRICKSON® HA-360/400/460 AIR RIDE



STEMCO GAFF replacement parts compatible with: HENDRICKSON® HAS 360/400/402/460 SERIES

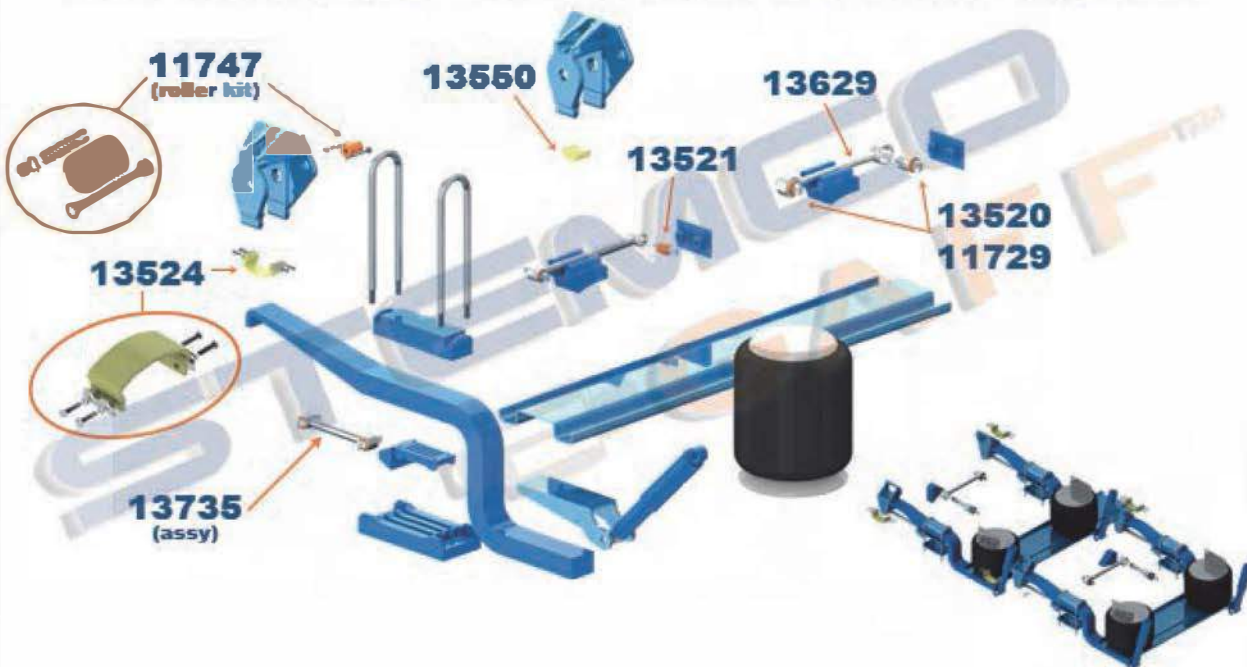

**STEMCO GAFF replacement parts compatible with:
HENDRICKSON® HAULMAAX®**

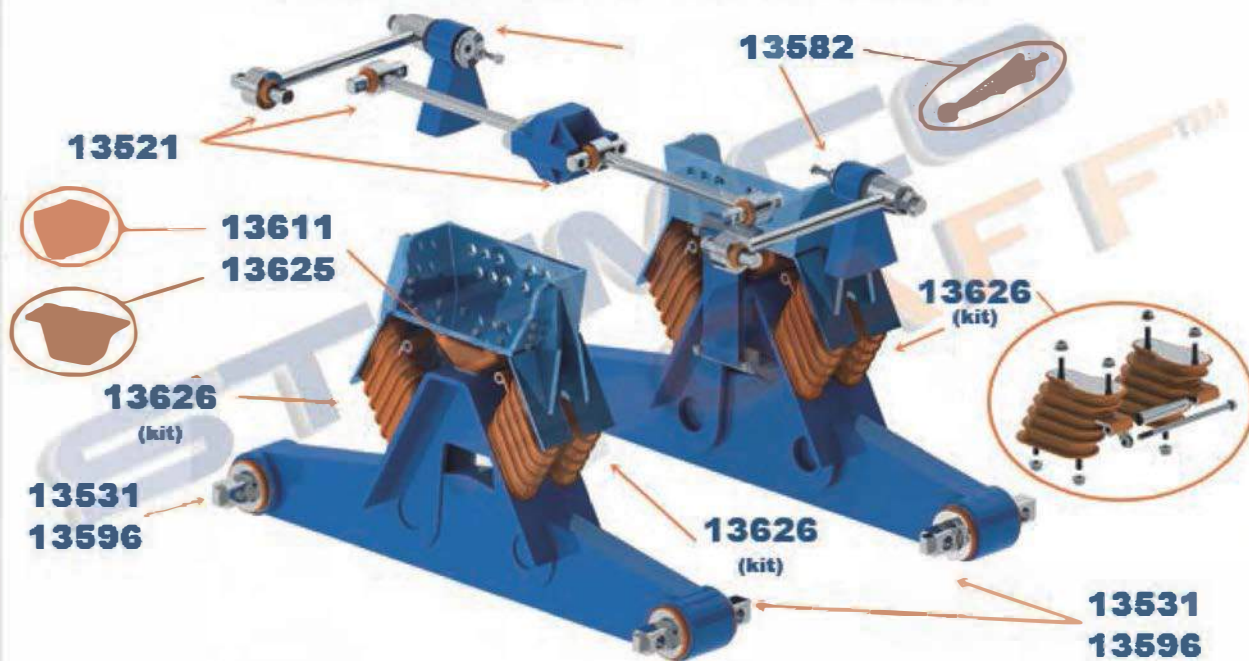

**STEMCO GAFF replacement parts compatible with:
HENDRICKSON® HFS-360/400 SERIES**



STEMCO GAFF replacement parts compatible with:
HENDRICKSON® HT/ INTRAAX®/ 300

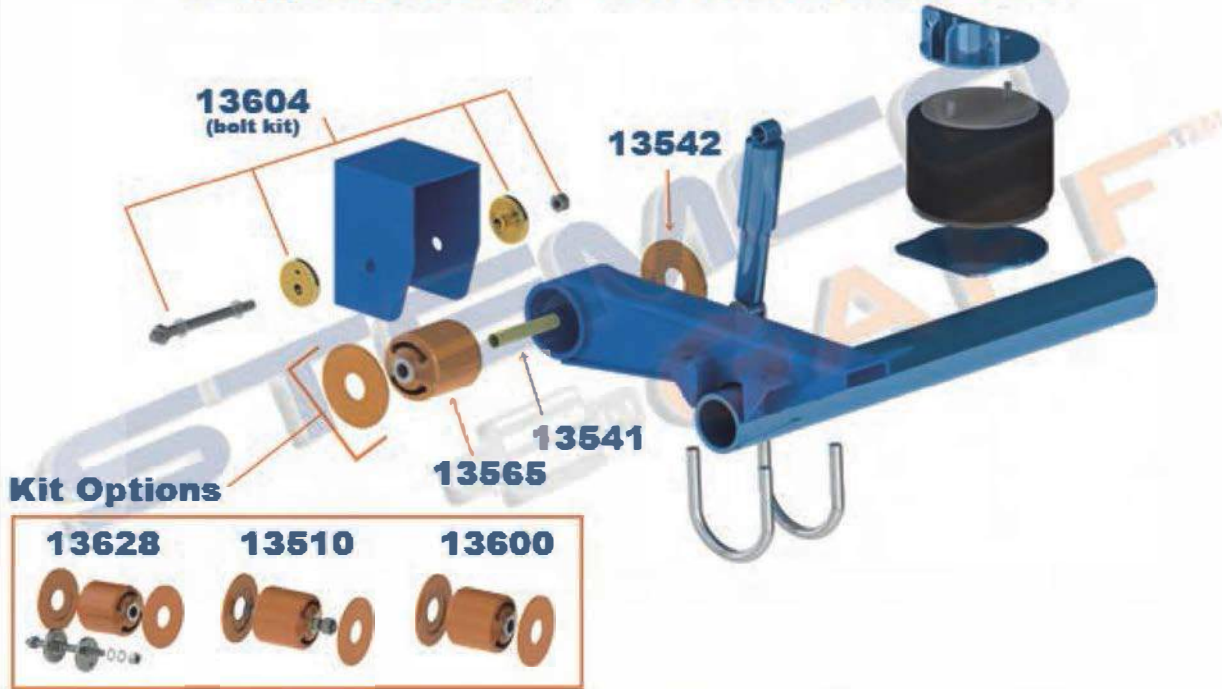

STEMCO GAFF replacement parts compatible with:
HENDRICKSON® PRIMAAX® EX 262/522/782,
FIREMAAX® EX 272/542 8½" - 10" RIDE HEIGHT



STEMCO GAFF replacement parts compatible with: HENDRICKSON® HN® - 402/460/462/522 SERIES

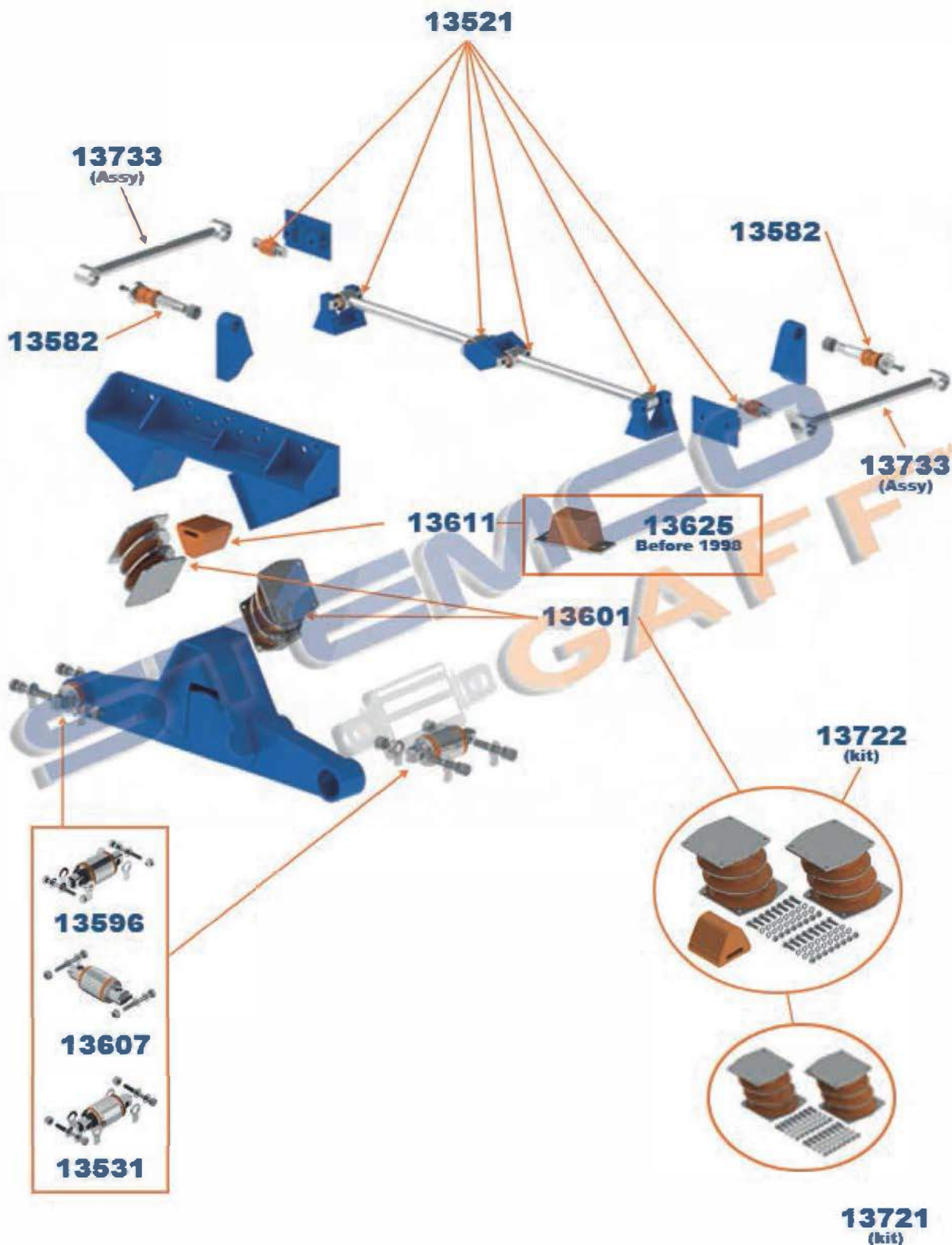

Hendrickson continued

STEMCO GAFF replacement parts compatible with:

**HENDRICKSON® PRIMAAX® EX 230/460/690
FIREMAAX® EX 240/480 8½" - 10" RIDE HEIGHT**



STEMCO GAFF replacement parts compatible with:

**HENDRICKSON® PRIMAAX® EX 230/460/690*
FIREMAAX® EX 240/480 12½" - 14⅜" - 15½"
RIDE HEIGHT**



STEMCO GAFF replacement parts compatible with:

HENDRICKSON® PRIMAAAX® EX 232/462/692*

FIREMAAX® EX 242/482 8½" - 10½"



STEMCO GAFF replacement parts compatible with:

HENDRICKSON® RT 340 SERIES



**STEMCO GAFF replacement parts compatible with:
HENDRICKSON® RT 380/440 SERIES**

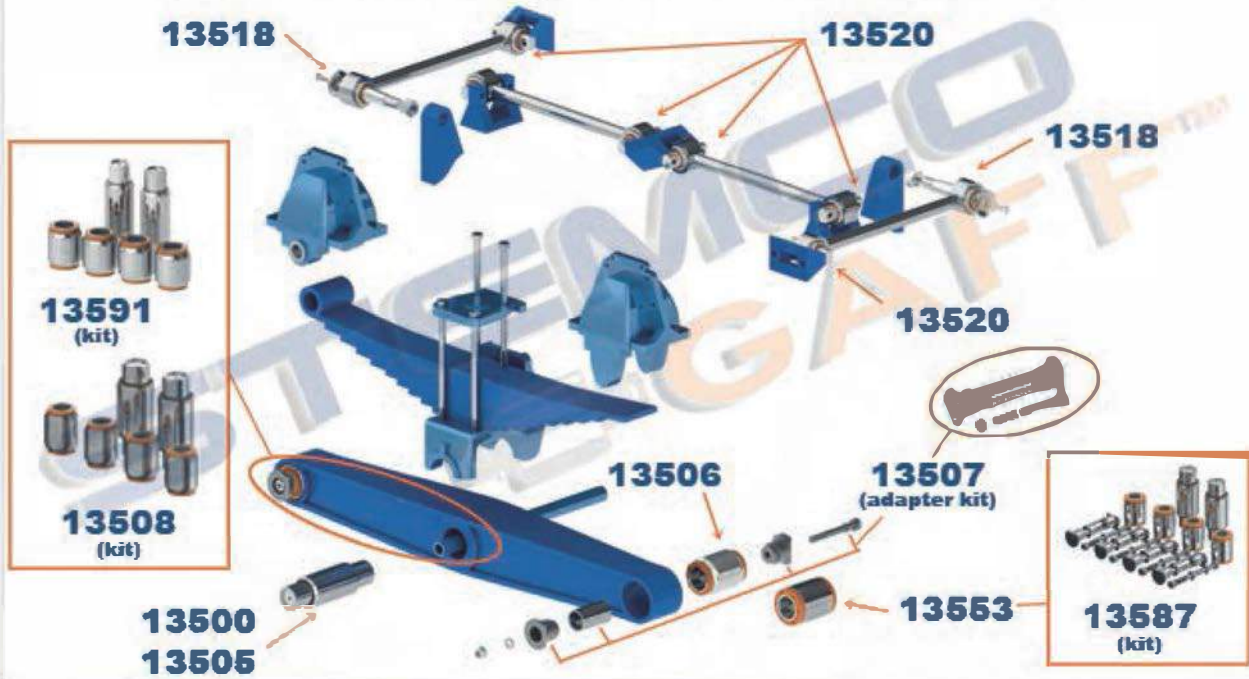

**STEMCO GAFF replacement parts compatible with:
HENDRICKSON® RT 650 SERIES**



STEMCO GAFF replacement parts compatible with: HENDRICKSON® RS 400/403/460/463 SERIES

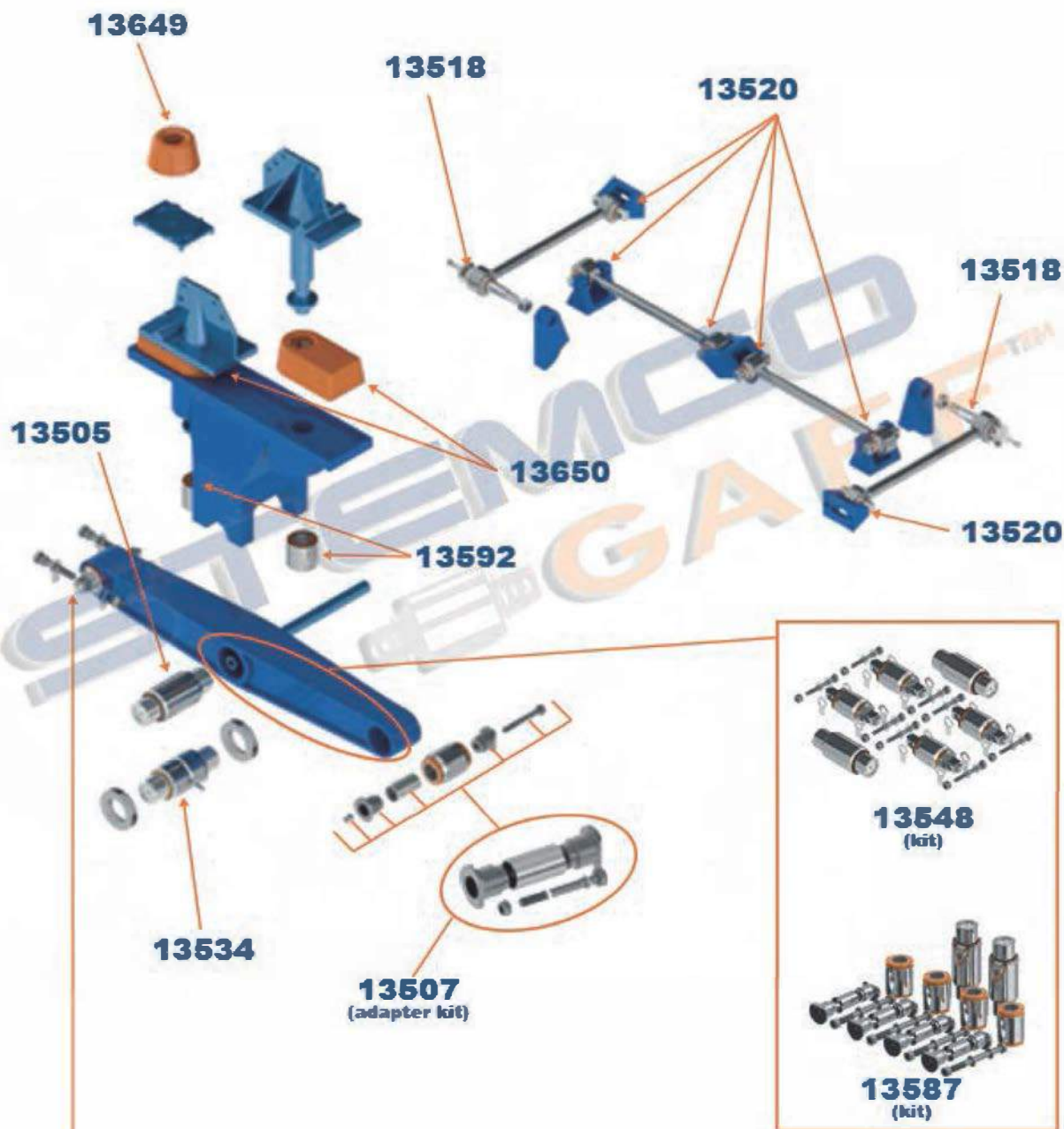

**STEMCO GAFF replacement parts compatible with:
HENDRICKSON® RT 700 SERIES****STEMCO GAFF replacement parts compatible with:
HENDRICKSON® RT/RTE 400/403/460/463 SERIES**

STEMCO GAFF replacement parts compatible with: HENDRICKSON® VANTRAAX®

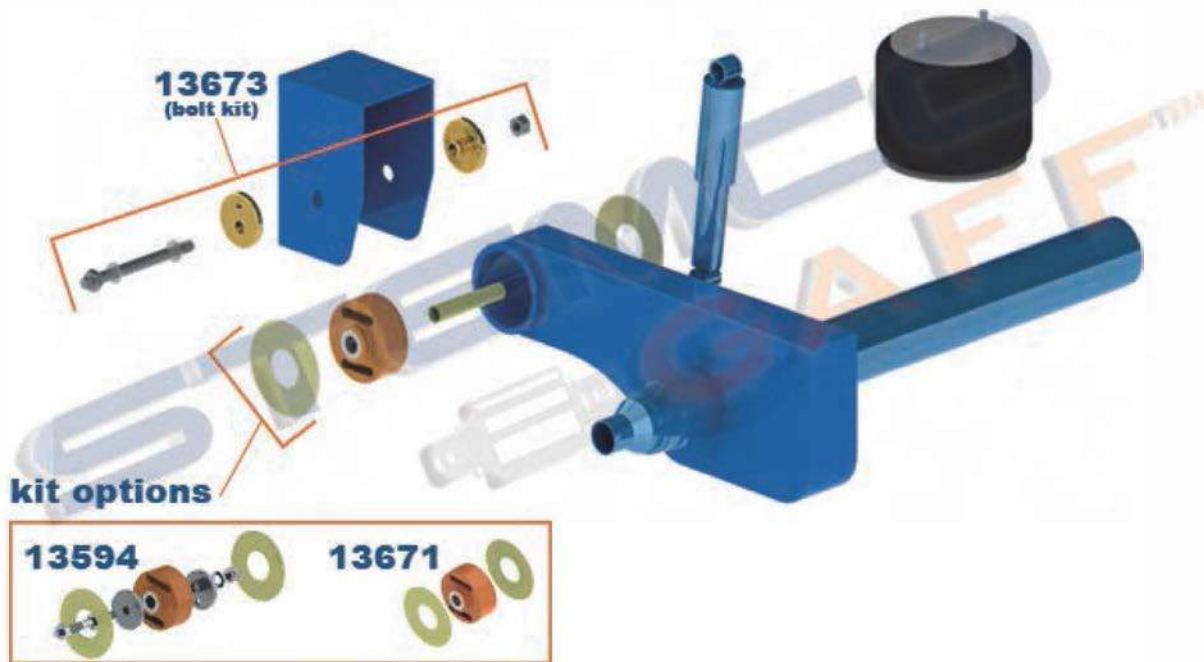

11004



Torque Rod Bushing

OD	2	1/16"
LG	6	5/8"
C-C	4	3/8"
BH		5/8"
HD	80A	

INCLUDED IN:
11078, 11081, 11769

TOOLS 11071, 18836

OEM
47691
47691000
20-836PU
R305275
HS44
E-5275
D405
321-223
TRB6185
PL1146A

Notes: rib style / 11006 - oversized / 12051 - grooved for torque rod with a center rib / 13521 - chamfered

11066



Spring Bushing

OD	2	1/4"
ID		13/16"
LG	4	1/4"
HD	80A	

OEM
RB211
RB233
RB-211
RB-233
SP46-52800
16-17769-00
680-322-01-05
680-322-01-50

Notes:

11083



Spring Pin Bushing

OD	2	1/2"
LG	7	7/16"
C-C	5	11/16"
BH		7/8"
HD	80A	

TOOL 11069

OEM
52296
RB205
RB268
E-8804
RB-157-OS
RB-205
RB-268
MR782
PB46-26268
UB20500-OS

Notes: anti walk design

11094



Spring Pin Bushing

OD	2	1/4"
OD<	1	1/4"
LG	6	7/8"
HD	80A	

OEM
RB263
RB-263
MR772
MR772UB
SP46-11023
16-14603-000
16-17194-000
16-17770-000
16-18023-000

Notes:

Hendrickson continued

11123



Spring Bushing
Front

OD	2	-
ID	1	3/16
LG	3	1/4
HD	80A	-

OEM

Notes: sleeveless bushing for leaf springs / bushing with sleeve is 11133 / compatible with AirTek leaf spring on FLD Columbia

11509



Torque Rod Bushing

OD	3	1/2	-
C-C	4	3/8	-
BH		5/8	-
HD	80A		-

OEM

Notes: additional tool suggestions 11731, 18834

11511



Torque Rod Bushing

OD	3	1/2	-
C-C	4	3/8	-
BH		5/8	-
HD	80A		-

OEM

35-505
E-9324
321-335
321-335A
932420
K195-415-13
TRB6810

Notes: Big 6 Suspension / 12 per truck / used in rare, heavy duty applications / additional tool suggestions 11731, 18834

11556



Torque Rod Bushing

OD	2	11/16	-
C-C	4	3/8	-
BH		5/8	-
HD	80A		-

OEM

44694
M2069

Notes: verify dimensions compare to 13522 and 83522

11714



Torque Rod Bushing

OD	2	7/16	-
C-C	4	3/8	-
BH		5/8	-
HD	80A		-

OEM

57256-000
40-334
R309395
VT21
E9395
E-9395
321-279
TRB6165
TS50-22256

Notes: additional tool suggestions 18552, 18833, coming soon 40131

11729



Torque Rod Bushing

OD	2	3/4	-
C-C	4	3/8	-
BH		11/16	-
HD	80A		-

OEM

R3010303
E10303
E-10303
321-369
CS70815
KB920
836940
TS59-22400
836940
839310

INCLUDED IN:
11773, 11793, 12074,
13634, 31095

TOOLS 18551, 18833

Notes: high articulation bushing

11747



Rebound Roller Kit

OD	2	1/2	-
ID		9/16	-
LG	3	5/8	-
HD	80A		-

OEM

57989000

INCLUDES

QTY 1	Roller
QTY 1	Bolt
QTY 2	Flat Washer
QTY 1	Metal Sleeve
QTY 1	Lock Nut

Notes: components not sold separately

11751



Torque Rod Assy

C-C	24	-
B C-C	4	3/8
HD	80A	-

OEM

62000-610
925030
TR59-41375

INCLUDES

QTY 1	11754
QTY 2	13520

Notes:

11758



Spring Pin Bushing

OD	1 3/4"
C-C	5 3/4"
HD	80A

INCLUDED IN:
11757

TOOL 40090

OEM
50252
50-275
TB68
327-434
50-275
TB-68
M5212
SP59-11010

Notes:

12031



Torque Rod Bushing

OD	2 3/4"
LG	7
THR	1 1/4" - 12 UNF
HD	80A

INCLUDED IN:
12042, 12072

OEM
46735
64400-007L
R302815
R309518
C884
E-9518
D293
321-136
TRB6119
TM38000

Notes:

12044



**Torque Rod Assy
Weldable**

C-C	26"
BC-C	4 3/8"
BH	5/8"

INCLUDES
QTY 1 13590
QTY 2 13520

OEM
46661
66661-000H
MR661
UR661
E-2642

Notes: universal torque rod

12070



Torque Rod Assy

C-C	20"
BC-C	4 3/8"
BH	5/8"

INCLUDES
QTY 2 13520

OEM
3226713
TR62-413M3

Notes:

12071



Torque Rod Assy

C-C	24 3/16"
BC-C	4 3/8"
BH	5/8"

INCLUDES
QTY 2 13520

OEM
62000-615
92883-4
TR62-41243

Notes:

12396



Torque Rod Assy

C-C	17 5/16"
BC-C	4 3/8"
BH	5/8"

INCLUDES
QTY 2 13520

OEM
62010-455
TR50-42455

Notes:

12398



Torque Rod Assy

C-C	25 9/16"
BC-C	4 3/8"
BH	5/8"

INCLUDES
QTY 2 13520

OEM
62000-650
50-1437
PB46
E-7853
345-215
TR75-41108

Notes:

13500



Center Bushing

OD	3 5/8"
OD<	2 3/4"
LG	12
HD	80A

INCLUDED IN:
13503, 13504, 13591

TOOLS 18543, 18544

OEM
20-816
6664
22279
06664-000L
29481-5
R309520
C864
E-9520
321-119
CB34012

Notes: welded plug

Hendrickson continued

13501



Beam End Bushing

OD 4 3/8 ~
ID 2 1/2 ~
LG 5 1/4 ~
HD 80A

INCLUDED IN:
13503, 13504

TOOLS 13564, 18541, 18542

OEM
6969
06969-000L
R309511
20-809PU
C865
E-9511
D404
321-120
M1976
EB34000

Notes: for complete repair use adapter 13502 / additional tool suggestion 13588

13502



Beam End Adapter

OD 3 1/2 ~
OD< 2 1/2 ~
LG 8

INCLUDED IN:
13504

OEM
4500005
45000013
45000-013
4500013L
R302372
20-802
HAK34
E-2372
334-108
AK34100

Notes: used with 13501 and 13503

13503



Beam Bushing Kit

INCLUDES
QTY 4 13501
QTY 2 13500

INCLUDED IN:
13504

OEM

Notes: for complete repair use adapter 13502

13504



Beam Bushing Kit

INCLUDES
QTY 4 13502
QTY 2 13500
QTY 4 13501

OEM
4500013L
R302862
SK80340

Notes:

13505



Center Bushing

OD 4 3/4 ~
OD< 3 1/2 ~
LG 12 ~
HD 80A

INCLUDED IN:
13508, 13548, 13587

TOOLS 13570, 18539, 18540

OEM
5919
49400
110222
29483-5
49400-000
5919-000
R309359
E-9359
321-243
CB38012

Notes: standard-welded plug / double bonded-welded plug - 13636 / standard-loose plug - 13543

13506



Beam End Bushing

OD 4 3/8 ~
ID 2 1/2 ~
LG 5 3/4 ~
HD 80A

INCLUDED IN:
13508, 13509, 13566, 13591

TOOLS 13564, 18541, 18542

OEM
45900-000

Notes: crimped sleeve / only available in kits not sold individually

13507



Beam End Adapter

OD 3 1/2 ~
OD< 2 1/2 ~
LG 8

INCLUDED IN:
13509, 13574, 13587

OEM
496530
45000-007
20-800
HAK38
E-2374
334-109
HAK100

Notes: used with 13506, 13508, 13553, 13591

13508



Beam Bushing Kit

INCLUDES
QTY 4 13506
QTY 2 13505

OEM

Notes: for complete repair use adapter 13507

Hendrickson continued

13510



Suspension Bushing Kit

OD	5 7/8"	
ID	1 1/4"	
LG	6 3/4"	
HD	80A	

INCLUDES

QTY 1	13565
QTY 1	13542
QTY 1	13541
QTY 1	13555

TOOL 13581

Notes: 1 1/8" Bolt

OEM

A-6914
S-6914
HT207
E-6121
334-658
TRK5912
PB50-36914

13511



Spring Bushing

OD	2 3/8"	
ID	1"	
LG	3 1/8"	
HD	80A	

OEM

Notes:

13512



Spring Bushing

OD	2 3/8"	
ID	7/8"	
LG	3 1/8"	
HD	80A	

OEM

47421
48401
48929
R309566
20-843
C886
E-9566
321-246
TRB5911
EB27500

Notes:

13514



Torque Rod Bushing

OD	3"	
ID	1 1/8"	
LG	3 1/4"	
HD	80A	

TOOLS 13585, 18831

Notes: additional tool suggestion 13585

OEM

45477
R302238
20-850
C870
E-2238
D316
321-141
09-5519
TRB6186
IN35190

13515



Torque Rod Bushing

OD	3"	
C-C	5 11/16"	
BH	13/16"	
HD	80A	

TOOL 18831

Notes: additional tool suggestion 13585

OEM

476991
73073-1
R303411
20-885
RBT207
E-3411
D312
321-144
TRB6260
IN35180

13516



Torque Rod Bushing

OD	2 3/4"	
ID	1 1/8"	
LG	3 1/4"	
HD	80A	

INCLUDED IN:
13688, 13698, 13699

TOOL 18833

Notes: additional tool suggestions 18551, coming soon 40131

OEM

46736
64400-010L
R302816
20-876
C881
E-13967
321-137
09-5716
TRB6181
TH50000

13517



Torque Rod Bushing

OD	2 3/4"	
C-C	5 11/16"	
BH	13/16"	
HD	80A	

INCLUDED IN:
13687

TOOL 18833

Notes: additional tool suggestions 18551, coming soon 40131

OEM

46734
64400-009L
R309517
20-834
C880
E-13964
E-9517
321-135
TRB6118
TS49000

13518



Torque Rod Bushing

OD	2 3/4"	
LG	8 1/16"	
THR	1 1/4" - 12 UNF	
HD	80A	

INCLUDED IN:
11794, 11808, 13657, 13679, 13686, 13694, 13695, 34555

TOOLS 13584, 18833

Notes: metal sleeve/ 13533 - no sleeve / additional tool suggestion 18551, coming soon 40131

OEM

44697
64400-004L
66649-004
R308651
20-831PU
C883
E-8651
321-133
TRB6112
TT38000

Hendrickson continued

13519



Torque Rod Bushing

OD	3 5/8	~
C-C	4 3/8	~
BH	5/8	~
HD	80A	

OEM
32174-000

TOOL 18051

Notes:

13520



Torque Rod Bushing

OD	2 3/4	~
C-C	4 3/8	~
BH	5/8	~
HD	80A	

OEM
44695
64400-002L
66649-002
R307639
20-833PU
C879
E-7639
321-132
TRB6820
TS38000

INCLUDED IN:
Several Kits

TOOLS 18551, 18833

Notes: 83520 - easy mount / 13536 - no metal sleeve

13521



Torque Rod Bushing

OD	2 1/16	~
LG	6 5/8	~
C-C	4 3/8	~
BH	5/8	~
HD	80A	

OEM
47691
47691-000
R305275
20-836PU
HS44
E-5275
321-223
TRB6185
PL1146
TS50-22691

INCLUDED IN:
11153, 11792, 11795, 12397, 34563

TOOLS 11071, 18836

Notes: chamfered / 11004 - rib style / 11006 - oversized / 12051 - grooved for torque rod with a center rib

13522



Torque Rod Bushing

OD	2 17/32	~
C-C	4 3/8	~
BH	5/8	~
HD	80A	

OEM
44694
44694-000L
R307638
20-832PU
C878
E-7638
321-131
TRB164
TS34000
TS34095

TOOLS 18553, 18833

Notes: metal sleeve / easy mount - 83522 / no sleeve - 11003 / additional tool suggestion coming soon 40131

13524



Wear Pad

WD	3	~
LG	6 3/4	~
HGT	2 7/8	~
HD	71D	

OEM
565572
56557-002
HS-55
E-9391
334-833
09-5097
MMB985

Notes:

13525



Torque Rod Bushing

OD	3 1/2	~
C-C	4 3/8	~
BH	5/8	~
HD	80A	

OEM
565572
56557-002
HS-55
E-9391
334-833
09-5097
MMB985

TOOL 18831

Notes:

13526



Equalizer Bushing

OD	2 3/4	~
ID	1	~
LG	4 5/8	~
HD	80A	

OEM
47420
48402
48932
R309401
C868
E-9401
D425
321-245
TRB5168
CB27500

Notes:

13527



Rebound Roller Kit

OD	1 15/16	~
ID	5/8	~
LG	3	~
HD	80A	

OEM
48883-000
49175-005
49175-013
57989-000
R309432
HS65
E-9432A
334-527
09-5184
MHS79K

Notes: components not sold separately

Hendrickson continued

13528



Torque Rod Bushing

OD	2 3/4"	
C-C	4 3/8"	
BH	3/4"	
HD	80A	

INCLUDED IN:
12395, 13701, 13702, 13703

TOOLS 18833, 18551

OEM
49210
64400-005L
66649-005
R303868
20-851PU
C889
E-3868
321-265
TRB6822
TS38750

Notes: new tool coming soon 40131

13531



Beam End Bushing Kit

OD	4 3/8"	
C-C	8 1/2"	
BH	1 1/16"	
HD	80A	

INCLUDED IN:
13548, 13696, 13697

OEM

Notes: only available in kits not sold individually/ crimped sleeve bushing / 13596 - uncrimped sleeve double bonded bushing

13532



Torque Rod Bushing

OD	2 3/4"	
BH	5/8"	
HD	80A	

TOOLS 18551, 18833

OEM

Notes: new tool coming soon 40131

13533



Torque Rod Bushing

OD	2 15/16"	
LG	8 1/16"	
THR	1 1/4" - 12 UNF	
HD	80A	

TOOL 18831

OEM
44697
20-831PU
R302228
E-2228
D422
M2072
09-5721
TRB6112
TT38000

Notes: 13518 - metal sleeve

13534



Center Bushing

OD	4 3/4"	
ID	2 1/2"	
LG	12"	
HD	Bronze	

INCLUDED IN:
13558, 13662

OEM
30437000L
34013-054
3401354L
20-860
R301546
HBK38
E-1546
322-102
08-6301
HBK100

Notes: additional tool suggestions 13570, 18539, 18540

13536



Torque Rod Bushing

OD	2 15/16"	
C-C	4 3/8"	
BH	5/8"	
HD	80A	

TOOL 18831

OEM
44695
64400-002L
66649-002
R307639
20-833PU
C879UB
E-7639
321-132U
M2070
TRB6820UB

Notes: 83520 - easy mount / 13520 - metal sleeve

13537



Center Bushing

OD	3 5/8"	
ID	2"	
LG	10 1/2"	
HD	80A	

OEM
22279
22279-000L
R301594
C866
E-1594
D403
321-118
09-5620
CB34010
CB34011

Notes: no plug / verify dimensions / compatible with Raydan

13538



Center Bushing

OD	3 5/8"	
ID	2"	
LG	9 9/16"	
HD	80A	

OEM

Notes: compatible with Raydan

Hendrickson continued

13541



Inner Bushing Sleeve

OD	1 1/4	-
ID	1 1/8	-
LG	6 3/4	-
HD	72D	-

INCLUDED IN:
13510

OEM
S-20681
E-3770
334-1134
DLS118634

Notes:

13542



Wear Shims

OD	7	-
ID	2 5/16	-
THK	5/16	-
HD	72D	-

INCLUDED IN:
13510, 13600

OEM
B1161-3
S-1161-3
R306122
HT212
E-6122
334-898
09-6241
M14712

Notes:

13543



Center Bushing Loose Plug

OD	4 3/4	-
ID	2 1/2	-
LG	12	-
HD	80A	-

INCLUDED IN:
13510

OEM
22282
49600
22282-000L
49600-000
R309510
20-820
E-9510
321-244
CB38010
CB38011

Notes: standard-loose plug / double bonded-welded plug - 13636 / standard-welded plug - 13505

13544



Center Bushing

OD	5 1/2	-
ID	3	-
LG	14 5/8	-
HD	80A	-

INCLUDED IN:
13510

OEM
10366
10366-000
10366L
R302553
20-818
C873
E-2553
321-128
CB50000
CB50011

Notes: additional tool suggestions 13570, 18540

13545



Beam End Bushing

OD	6	-
ID	3	-
LG	6	-
HD	80A	-

INCLUDED IN:
13586

OEM
10363
10363-000
10363L
R302554
20-813
C872
E-2554
321-129
09-5471
EB50000

TOOL 13569

Notes: for complete repair use 13547

13546



Beam End Bushing

OD	6	-
ID	3	-
LG	7	-
HD	80A	-

INCLUDED IN:
13586

OEM
10364
10364-000
20-814
321-318
09-5451
EB65000

TOOL 13569

Notes: for complete repair use adapter 13549

13547



Beam End Adapter

OD	3	-
ID	2	-
LG	9 3/4	-
HD	Steel	-

INCLUDED IN:
13586

OEM
211407
R302555
20-806
HAK50
E-2555
334-138
09-5472
HAK124
AK50100

Notes: for use with 13545

13548



Beam Bushing Kit

INCLUDES		
QTY 4	13531	
QTY 2	13505	

INCLUDED IN:
13586

OEM
5919
49400
110222
34013088
29483-5
34013-88L
49400-000
SK80382

Notes:

Hendrickson continued

13549

OD	3	"
ID	2	"
LG	10	3/4"
HD	Steel	

OEM
46493-000
AK65100



Beam End Adapter

Notes: for use with 13546

13550

HGT	1	9/16"
WD	3	11/16"
LG	3	3/16"
HD	71D	

OEM
565574
56557004
56929-000
HS82
HS83
334-1597
334-1602



Wear Pad

Notes:

13553

OD	4	3/8"
ID	2	1/2"
LG	5	3/4"
HD	80A	

OEM
45900
29878-1
45900-000L
R302771
20-810PU
C871
E-1341A
321-242
M1988
EB38000



Beam End Bushing

INCLUDED IN:
13587

TOOLS 13563, 13588

Notes: uncrimped sleeve double bonded bushing / supersedes 13506 / use adapter 13507 for complete repair / additional tool suggestion 13595

13555

LG	9	1/2"
THR	1 1/4"	7 UNC
HD	Steel	

OEM
48941
56659-1
B1509-50
334-832
BPK100



Bolt Kit

INCLUDED IN:
13510

Notes: for use with 13565

13558

INCLUDES		
QTY 2	13534	

INCLUDED IN:
13662

OEM
30437-000
30437L
R301546
20-860
hbk38
E-1546
322-102A
HBK100



Center Bushing Kit

Notes:

13560

OD	4	3/8"
ID	2	1/2"
LG	6	
HD	80A	

OEM
45407
45407-000
45407L
R309419
C875
E-9419
321-127
321-127U
09-5460
EB45000



Beam End Bushing

INCLUDED IN:
13562

Notes: for complete repair use adapter 13610 / additional tool suggestion 13564, 13588, 18541, 18542

13562

INCLUDES		
QTY 1	13610	
QTY 1	13560	

OEM
34013-051
3401351L
334-960
09-5674



Beam End Bushing Kit

Notes:

13565

OD	5	7/8"
ID	1	1/4"
LG	6	3/4"
HD	80A	

OEM
C-3558
S-6914
R3010729A
R306121
HT207
TRB5912



Suspension Bushing

INCLUDED IN:
13510

TOOL 13581

Notes: 13628 - easy-align kit / see tech tip 01 577 9035

Hendrickson continued

13566



Beam End Bushing Kit

INCLUDES		
QTY 1	13609	
QTY 1	13506	

OEM
34013050
34013-049
34013-050
34013-073
34013-49
EA38000
BA122
BA122UB
BA123
334-381

Notes:

13574



Beam End Bushing Kit

INCLUDES		
QTY 1	13591	
QTY 4	13507	

OEM

Notes:

13582



Torque Rod Bushing

OD	2 1/16"
LG	8 1/16"
HD	80A

OEM
64697
64697-000
HS73
E-10309
321-360
TT50-22697

Notes: additional tool suggestion 11071, 18836

13586



Beam End Bushing Kit

INCLUDES		
QTY 1	13545	
QTY 1	13547	

OEM
10363 End Bushing
211407 Adapter Kit
EA50000

Notes:

13587



Beam Bushing Kit

INCLUDES		
QTY 4	13553	
QTY 2	13505	
QTY 4	13507	

OEM
70000-2
HCK380
E-2863
339-102
HCK100
SK80380

Notes: supersedes 13509

13590



Torque Rod Weldable

ID	2 3/4"
C-C	26"

INCLUDED IN:
12042, 12044

OEM
64473-000
64474-000
TR60000
TR70005

13591



Beam End Bushing Kit

INCLUDES		
QTY 2	13500	
QTY 4	13506	

INCLUDED IN:
13574

OEM

Notes: only available in full kit 13574 including adapter 13507

13592



Vertical Drive Bushing

OD	4 1/8"
ID	2"
LG	4"
HD	80A

OEM
19279
R309515
C874
E-1940
E-9515
D107
321-125
09-5535
TRB5170
HV38000

Notes:

Hendrickson continued

13594



OD	6	~
OD<	2 13/16	~
ID	1 1/4	~
LG	3 5/8	~
HD	80A	

INCLUDES

QTY 1	13673
QTY 1	13671
QTY 1	13648

Suspension Bushing Easy-Align Kit

TOOL 13623

OEM
D-25364
S-23320
S-26321
22-904
HT249
E-14377
DT1610
334-1628
TRB5914UB
PB50-36321

Notes: 2 per axle / includes alignment collars / see tech tip 01 577 9035

13596



OD	4 3/8	~
C-C	8 1/2	~
BH	1 1/16	~
HD	80A	

INCLUDED IN:
13662

Beam End Bushing

TOOL 13595

OEM
34013088
34013-88L
R309326
20-859
BP-88
E-9326
334-831
09-5525
BP200

Notes: double bounded / straight sleeve / easy mount - 83596 / 13607 - no shims required

13597



ID	1 7/8	~
C-C	22 1/16	~

Torque Rod

Notes:

OEM
587575
58757-005

13600



OD	5 15/16	~
ID	1 1/4	~
LG	6 3/4	~
HD	80A	

INCLUDES

QTY 1	13542
QTY 1	13565

Suspension Bushing no Bolt Kit

INCLUDED IN:
13628

Notes: see tech tip 01 577 9035

OEM
S-24691
HT245
E-10729A
334-1576
TRB5912
PB50-36100

13601



C-C	6 7/8	~
C-C ²	5 5/8	~
HGT	5 1/2	~
HD	80A	

INCLUDED IN:
13721, 13722

Bolster Spring

Notes: 4 per truck / recommended to replace set in same repair / don't mix brands / see tech tip 01 577 9038

OEM
49377
49377-000
60879-000
HS56
E-11496
334-852
HS10000
LP50-24000
SK80268

13604



C-C	9 7/8	~
THR	7/8" - 8 UNC	

INCLUDED IN:
13628

Eccentric Washer, Bolt Kit Easy-Mount

Notes: includes alignment collars / use with 13600, 13565

OEM
60632-006
S-20924
S-20925
S-21052
S-24679
R3010730A
E-10730A
334-1579
334-1699

13607



OD	4 3/8	~
BH	1 1/16	~
HD	80A	

Beam End Bushing Kit

TOOL 13595

OEM
50150
50150000
34013-087L
34013-87
R309325
20-861
BP-87
E-9325
334-830
EB50-21013

Notes: double bounded / straight sleeve / wider inner pin no shims required/ for options requiring shims standard - 13596 or easy mount - 83596

13609



OD	3 1/2	~
OD<	1 1/8	~
LG	8 11/16	~
HD	Steel	

INCLUDED IN:
13566

Beam End Adapter Kit

Notes: supersedes 13540 / for use with 13506

OEM
21140-034
21140-34
R309420
20-801
HAK44
E-9420
334-467
09-5462
HAK112
AK38200

Hendrickson continued

13610



Beam End Adapter Kit

OD 3 1/2 -
OD< 2 1/2 -
LG 9 3/16 -
HD Steel

INCLUDED IN:
13562

OEM
21140-033
21140-33
2114033L
45000 011L
R309421
20-805
E-9421
334-1123
AK45100
AK50-45000

Notes: use with 13560

13611



Auxiliary Load Spring

OD 4 1/16 -
WD 5 1/8 -
LG 5 -
HD 80A

INCLUDED IN:
13722

OEM
641794
60314000
64179004
HS99
E-14047
334-1720
MHS225K
LP50-24974

Notes:

13618



Torque Rod Bushing

OD 2 7/16 -
BH 5/8 -
HD 80A

OEM

Notes: additional tool suggestion 18552

13625



Auxiliary Load Spring

THK 2 1/16 -
WD 2 -
LG 4 3/4 -
BC-C 4 1/8 -
HD 80A

OEM
49395
49395-000
R309416
E-9416
334-848
09-6110
MLC2
HS11000

Notes:

13626



Bolster Spring Kit

BC-C 4 3/4 -
THR 1/2 -
HD 80A

OEM
64179-002
64179-037
HS130
E-14044
E-14374
334-1727
334-1845
MLC3
MLC5
LP50-24179

Notes: 4 kits per truck / recommended to replace set in same repair / don't mix brands

13627



Torque Rod Bushing

OD 2 1/2 -
C-C 5 1/2 -
BH 7/8 -
HD 80A

OEM
60383000
60383-000
C890
E-14026
321-388
TRB6205
SU50-29383

Notes:

13628



Suspension Bushing
Easy-Align Kit

OD 5 15/16 -
ID 1 1/4 -
LG 6 3/4 -
BH 7/8 -
HD 80A

INCLUDES
QTY 1 13604
QTY 1 13600

TOOL 13581

OEM
S-21166
S-24691
R3010729A
HT245
E-10729A
334-1576
MHS736
PB50-36000

Notes: supersedes 13624 / see tech tip 01 577 9035

13629



Torque Rod

ID 2 3/4 -
C-C 22 -

INCLUDED IN:
13634, 13657

OEM

Notes:

Hendrickson continued

13634 C-C 22 ~

INCLUDES
QTY 2 11729
QTY 1 13629

OEM
57857006
943853
TMR547
TR62-41220



Torque Rod Assy

Notes:

13648 OD 7 ~
ID 2 15/16 ~
THK 5/16 ~
HD 72D

INCLUDED IN:
13594, 13599

OEM
B-21099
S-21099
HT258
334-1810



Wear Shims

Notes:

13649 OD 7 ~
ID 1 ~
LG 4 ~
HD 80A

OEM
24209
24209-000
R309514
20-823
LC4
E-9514
D134
325-100
MLC10
HC10000



Overload Cushion

Notes:

13650 OD 6 3/4 ~
ID 3 15/16 ~
ID< 3 1/8 ~
THK 4 1/16 ~
LG 11 15/16 ~
HD 80A

OEM
26953
48972
48973
26953-000
48973-000
20-824
LC3
E-9513
325-104
HC20000



Load Pad

Notes:

13652 OD 2 1/2 ~
C-C 6 1/4 ~
BH 7/8 ~
HD 80A

OEM
65831-000



Torque Rod Bushing

Notes:

13656 OD 3 5/8 ~
OD< 2 3/4 ~
ID 2 ~
LG 12 ~
HD 80A

OEM
29483-005
34013-097
E-9359
C2000



Center Bushing

Notes:

13658 OD 5 7/16 ~
OD< 4 ~
LG 18 ~
HD 80A

OEM
15464
15464-000
321-317
09-5450
CB65002
CB65011



Center Bushing

Notes:

13659 OD 4 3/8 ~
ID 2 1/2 ~
LG 4 7/16 ~
HD 80A

OEM
6966
06966000
E-9519
D410
321-320
09-5494
TH85000



Torque Rod Bushing

Notes:

Hendrickson continued

13662



Beam Bushing Kit

INCLUDES
QTY 4 13596
QTY 1 13558

OEM

Notes:

13665



Alignment Shim

OD	2 1/8"
ID	1 1/8"
THK	3/16"
LG	3 1/2"

OEM
201-05-120
50130-000
20-847
HS41
E-9327
334-879

Notes:

13671



Suspension Bushing Kit

OD	6"
OD<	2 13/16"
ID	1 1/4"
LG	3 5/8"
HD	80A

INCLUDED IN:
13594

TOOLS 13623

OEM

Notes:

13672



Torque Rod Bushing

OD	2"
C-C	4 3/8"
BH	3/4"
HD	80A

TOOL 18836

OEM
69210-000
69210-000H
20-914
HS79
E-10322
321-366
TRB6175
TS50-22210

Notes: additional tool suggestion 11071

13673



Eccentric Washer, Bolt Kit Easy-Mount

LG	6 7/8"
THR	7/8" - 8 UNC

INCLUDED IN:
13594

OEM
S-20924
S-20925
S-23319

Notes: includes alignment collars/ for use with 13671

13679



Torque Rod Assy

LG ²	8 1/16"
C-C	25"
BC-C	4 3/8"
BH	5/8"
HD	80A

INCLUDES
QTY 1 13680
QTY 1 13518
QTY 1 13520

OEM
62350-635
681-326-70-16
925150
925150
A3580010-635
S3580001-635
S3580003-635
TR59-41150

Notes:

13683



Torque Rod End Assy Tube End

LG	8 9/16"
BC-C	4 3/8"
BH	5/8"
HD	80A

INCLUDES
QTY 1 13520
QTY 1 13681

OEM
46610
66610-000H
IPC928610
1693531C1
R301024
R3010310
R302639
MR610
UR610
E-10310

Notes:

13684



Torque Rod Bushing

OD	2 3/4"
LG	6 5/8"
THR	1 1/2" - UNF
HD	80A

INCLUDED IN:
13692, 13693

TOOLS 13584, 18833

OEM
44809
44809-000
R302227
C885
E-2227
321-134
M2071
09-5720
TRB6116
TT34000

Notes: additional tool suggestions 18551, coming soon 40131

Hendrickson continued

13686



**Torque Rod End Assy
Tube End**

LG	8 9/16"	OEM
LG ²	8 1/16"	46630
THR	1 1/2" - 12 UNF	66630-000H
HD	80A	MR630

INCLUDES

QTY 1	13681
QTY 1	13518

Notes:

13687



**Torque Rod End Assy
Tube End**

LG	8 9/16"	OEM
BC-C	5 11/16"	46640
BH	13/16"	66640-000H
HD	80A	20-9015

INCLUDES

QTY 1	13681
QTY 1	13517

Notes:

13688



**Torque Rod End Assy
Tube End**

ID	1 1/8"	OEM
LG	8 9/16"	46650
LG ²	3 1/4"	66650-000H
HD	80A	20-9016

INCLUDES

QTY 1	13681
QTY 1	13516

Notes:

13689



**Torque Rod End Assy
35" Rod End**

LG	33 7/16"	OEM
BC-C	4 3/8"	
BH	7/8"	
HD	80A	

INCLUDES

QTY 1	13707
QTY 1	13685

Notes:

13690



**Torque Rod End Assy
35" Rod End**

LG	33 7/16"	OEM
BC-C	4 3/8"	46660
BH	5/8"	66660-000H
HD	80A	20-9034

INCLUDES

QTY 1	13707
QTY 1	13520

Notes:

13691



**Torque Rod End Assy
27" Rod End**

LG	25 7/16"	OEM
BC-C	4 3/8"	46660
BH	5/8"	46661
HD	80A	66660-000H

INCLUDES

QTY 1	13682
QTY 1	13520

Notes:

13692



**Torque Rod End Assy
35" Rod End**

LG	33 7/16"	OEM
LG ²	6 5/8"	46670
THR	1 1/2" - 12 UNF	66670-000H
HD	80A	20-9031

INCLUDES

QTY 1	13707
QTY 1	13684

Notes:

13693



**Torque Rod End Assy
27" Rod End**

LG	25 7/16"	OEM
LG ²	6 5/8"	46671
THR	1 1/2" - 12 UNF	R302641
HD	80A	20-9031

INCLUDES

QTY 1	13682
QTY 1	13684

Notes:

Hendrickson continued

13694

LG	33	7/16"
LG ²	8	1/16"
THR	1 1/2"	12 UNF
HD	80A	

INCLUDES
QTY 1 13707
QTY 1 13518

OEM
46680
66680-000H
20-9033
MR680
UR680
E-2643
345-680
928680
TMR680
TR76000

Torque Rod End Assy
35" Rod End

Notes:

13695

LG	25	7/16"
LG ²	8	1/16"
THR	1 1/2"	12 UNF
HD	80A	

INCLUDES
QTY 1 13682
QTY 1 13518

OEM
46681
66681-000H
20-9023
MR681
UR681
E-10317
345-681
928681
TMR681
TR76000

Torque Rod End Assy
27" Rod End

Notes:

13696

LG	33	7/16"
LG ²	7	
THR	1 1/2"	12 UNF
HD	80A	

INCLUDES
QTY 1 13707
QTY 1 12031

OEM
46690
66690-000H
20-9032
MR690
UR690
345-690
928690
09-5435
TMR690
TR77000

Torque Rod End Assy
35" Rod End

Notes:

13697

LG	25	7/16"
LG ²	7	
THR	1 1/2"	12 UNF
HD	80A	

INCLUDES
QTY 1 13682
QTY 1 12031

OEM
46691
66691-000H
R302812
20-9022
MR691
E-2812
345-691
928691
TMR691
TR77000

Torque Rod End Assy
27" Rod End

Notes:

13698

ID	1	1/8"
LG	34	7/16"
LG ²	3	1/4"
HD	80A	

INCLUDES
QTY 1 13708
QTY 1 13516

OEM
46700
66700-000H
20-9036
MR700
345-700
928700
09-5434
TMR700
TR85000

Torque Rod End Assy
36" Rod End

Notes:

13699

ID	1	1/8"
LG	25	7/16"
LG ²	3	1/4"
HD	80A	

INCLUDES
QTY 1 13682
QTY 1 13516

OEM
46701
66701-000H
20-9026
MR701
E-10319
345-701
928701
09-5430
TMR701
TR85000

Torque Rod End Assy
27" Rod End

Notes:

13700

LG	8	9/16"
BC-C	4	3/8"
BH		7/8"
HD	80A	

INCLUDES
QTY 1 13681
QTY 1 13685

OEM
56766
66766-000H
MR766
E-11784
345-612
942690
TR83000

Torque Rod End Assy
Tube End

Notes:

13701

LG	8	9/16"
BC-C	4	3/8"
BH		3/4"
HD	80A	

INCLUDES
QTY 1 13681
QTY 1 13528

OEM
56767
66767-000H
20-9017
MR767
E-11748
345-794
09-5807
TR74000

Torque Rod End Assy
Tube End

Notes:

Hendrickson continued

13702

LG	33	7/16"
B C-C	4	3/8"
BH		3/4"
HD	80A	

OEM
57046
67046-000H
345-614
928666

INCLUDES
QTY 1 13707
QTY 1 13528

Torque Rod End Assy
35" Rod End

Notes:



13703

LG	25	7/16"
B C-C	4	3/8"
BH		3/4"
HD	80A	

OEM
57047
67047-000H
345-794
928665
09-5813
TR78000

INCLUDES
QTY 1 13682
QTY 1 13528

Torque Rod End Assy
27" Rod End

Notes:



13704

LG	25	7/16"
BC-C	4	3/8"
BH		7/8"
HD	80A	

OEM
57048
67048-000H
345-668
928668
TR79000

INCLUDES
QTY 1 13682
QTY 1 13685

Torque Rod End Assy
27" Rod End

Notes:



13721

INCLUDES
QTY 2 13601
QTY 16 Bolts 7/16" x 1 1/4" UNF
QTY 16 Lock Nuts 7/16" UNF
QTY 32 Flat Washer 7/16"

OEM
49377
60879
49377000
60879000L
60879L
HS56
E-11496
334-852
HS10000
LP50-24000

Bolster Spring Pair

Notes: 2 per truck / recommended to replace set in same repair / don't mix brands / see tech tip 01 577 9038



13722

INCLUDES
QTY 2 13601
QTY 1 13611
QTY 16 Bolts 7/16" x 1 1/4" UNF
QTY 16 Lock Nuts 7/16" UNF
QTY 32 Flat Washer 7/16"

OEM
49377
60879
641794
60314000
64179004
49377-000
60879000L
60879L
LP50-24000
LP50-24974

Bolster Spring Kit

Notes: 2 kits per truck / recommended to replace set in same repair / don't mix brands / see tech tip 01 577 9038



13725

OD	2	-
ID		13/16"
C-C	5	-
HD	70A	

INCLUDES
QTY 1 18994
QTY 2 Bolt 1/2" x 2 1/2" UNF
QTY 2 Lock Nut 1/2" UNF
QTY 4 Flat Washer 1/2"
QTY 1 Spring End Plate

OEM
609612
325-242

Spring Mount Kit
Rear

Notes:



13733

C-C	14	3/8"
BC-C	4	3/8"
BH		5/8"
THR	1 1/2"	12UNF

OEM
62350-615
TR50-41615

INCLUDES
QTY 1 13520
QTY 1 13518

Torque Rod Assy

Notes:



13735

C-C	14	3/8"
BC-C	4	3/8"
BH		5/8"

INCLUDES
QTY 2 13520

OEM
48411006
50376001
62007365
32271-102
E-9409
345-815
TR50-41102

Torque Rod Assy

Notes:



Hendrickson continued

14010



OD	2	--
ID	3	7/8
LG	3	--
HD	80A	--

INCLUDED IN:
11795, 12397

TOOL 18836

OEM
47692
47692-000
R303362
R305276
55-130
R208
E-5276
321-162
TRB6025
TH50-22692

Torque Rod Bushing

Notes: additional tool suggestion coming soon 40124

15013



OD	1 15/16	--
ID	3	7/8
LG	3	--
HD	80A	--

INCLUDED IN:
15063

OEM
A1712
R301980
R307520
55-129
R129
E-8687
321-153
M1449
PL1118
UB30000

Torque Rod Bushing

Notes: additional tool suggestions 18836, coming soon 40124

15063



INCLUDES
QTY 1 15013
QTY 1 Hex Bolt 1/2"-12 x 5 1/2"
QTY 1 Lock Nut 1/2"-12 UNF

OEM
A1712
55-11001
R002
E-1981
E-9552
334-247
TH83-22302

Torque Rod Bushing Kit

Notes:

18538



ID	1 3/8	--
THK	2 3/16	--
WD	3 3/16	--
LG	4 15/16	--
HD	Steel	--

OEM
46868-000

Torque Rod Mount

Notes: needs welding

18821



OD	3 3/4	--
ID	1 1/4	--
LG	3 5/8	--
HD	80A	--

OEM
58648000
58648-000
HS102
321-387
RB299
TRB5031
PB50-26648

Pivot Bushing

Notes:

18830



OD	4 3/16	--
C-C	4 5/16	--
BH	3 3/4	--
HD	80A	--

OEM
49305-1110
TS45000

Torque Rod Bushing

Notes:

18994



ID	13/16	--
WD	2	--
C-C	5	--
HD	80A	--

INCLUDED IN:
13725

OEM
593461
58918-000

Spring Mount Rear

Notes:

34514



OD	3	--
OD<	2 1/4	--
ID	1 1/2	--
LG	1 7/16	--
HD	90A	--

INCLUDED IN:
50033

OEM
004931
PB00-36314

Torque Rod Bushing Green

Notes: compatible with Arvin Meritor kit 11102

Hendrickson continued

34555

LG	8	1/4	~
C-C	25	1/4	~
BC-C	4	3/8	~
BH		5/8	~
THR	1 1/2	12 UNF	

INCLUDES
QTY 1 13520
QTY 1 13518

OEM
62350-645
TR50-41645



Torque Rod Assy

Notes:

34556

C-C	23	1/4	~
BC-C	4	3/8	~
BH		5/8	~

INCLUDES
QTY 2 13520

OEM
62000-590
62001-590
924920
942174
944160
944220
948574
TR50-42590



Torque Rod Assy

Notes:

83520

OD	2	3/4	~
C-C	4	3/8	~
BH		5/8	~
HD	80A		

TOOLS 18551, 18833

OEM
44695
64400-002L
66649-002
R307639
20-833PU
C879
E-7639
321-132
TRB6820
TS38000



Easy-Mount
Torque Rod Bushing

Notes: standard - 13520 / no metal sleeve - 13536

83522

OD	2	17/32	~
C-C	4	3/8	~
BH		5/8	~
HD	80A		

TOOLS 18553, 18833

OEM
44694
44694-000L
R307638
20-832PU
C878
E-7638
321-131
TRB6164
TS34000
TS34095



Easy-Mount
Torque Rod Bushing

Notes: easy mount / metal sleeve - 13522 / no metal sleeve - 11003

83596

OD	4	3/8	~
C-C	8	1/2	~
BH	1	1/16	~
HD	80A		

TOOL 18542, 13588

OEM
34013088
34013-088L
34013-88L
R309326
20-859
BP-87
BP-88
E-9326
334-831
BP200



Easy-Mount
Beam End Bushing

Notes: easy mount / standard - 13596 / no shims required - 13607

Hino/ Isuzu/ Mitsubishi/ Nissan

DESCRIPTION	OEM	PART ID	PAGE
Carrier Bearing Assy	2101211X / DS-6048	40075	96
Hood Latch	680-880-01-60	11103	96
Hood Latch	17-14781-000 / HLK2001	11109	96
Hood Latch	680-880-01-60	12365	96
Torque Rod Bushing	55542-Z2001 / 17257-56601 / 49305-1020 / 1515190371 / 1515190412 / 1515191130 / MC806960 / MC81266 / MC812666 / MK336202 / MK633449 / 55542-00Z00 / 55542-90002 / 55542-Z2000 / TS45000	18830	96

Hino/ Isuzu/ Mitsubishi/ Nissan continued

11103 LG 8 9/16" HD 70A **OEM** 680-880-01-60

INCLUDES
QTY 1 11098



Hood Latch
W / Mount

Notes: bracket not sold separately

11109 LG 3 13/16" HD 71D **OEM** 17-14781-000
HLK2001



Hood Latch
Hook

Notes:

12365 LG 8 11/16" HD 70A **OEM** 680-880-01-60



Hood Latch

Notes:

18830 OD 4 3/16" C-C 4 5/16" BH 3/4" HD 80A **OEM** 17257-56601
49305-1020
1515190371
1515190412
1515191130
MC806960
MC81266
MC812666
MK336202
MK633449
55542-00Z00
55542-90002
55542-Z2000
55542-Z2001
TS45000



Torque Rod Bushing

Notes:

40075 ID 2" C-C 7 7/16" BH 1/2" HGT 2 25/32" HD 70A **OEM** 2101211X
DS-6048



Carrier Bearing Assy

Notes: includes carrier bearing bushing 18725

Hutchens

DESCRIPTION	OEM	PART ID	PAGE
Equalizer Bushing	7010-00 / UCA-0472 / 064200 / 076800 / 32460848 / 25-705PU / A80BL1025 / R301999A / R307452 / H102 / E-1999A / E-7452 / D95 / 321-176U / M1452 / 09-3351 / TRB5541 / TRB5541UB / EQ53-35234	14000	100
Equalizer Bushing		14022	101
Equalizer Bushing	16146-01 / 25-706PU / A80BL8666 / R307621 / R308666 / H227 / E-7621 / E-8666 / E-9472 / E-9473 / D101 / 321-221U / 334-1272 / M3483 / TRB5542 / TRK5542 / TRK5542UB / EQ53-35118	14038	102
Equalizer Bushing		14072	102
Torque Rod Bushing	7620-00 / UXA-000011 / A80BL1051 / 7620-00 / GDH7620-00 / 25-750PU / R307433 / R30927 / RBT200 / RBT200UB / E-7433 / E-927 / D100 / 321-177 / 321-177U / M1818 / TRB6300 / TRB6300UB / PL1084	13001	100

Hutchens continued

DESCRIPTION	OEM	PART ID	PAGE
Torque Rod Bushing	7620-00 / 586121 / UXA-0011 / 090600 / 31339 / 25-750PU / RB200 / E-7433 / E-927 / 321177U / D100 / M1818 / 09-2247 / TRB6300 / A80BL1051	14003	100
Torque Rod Bushing		14007	100
Torque Rod Bushing	722-00 / UCA-3754 / 026900 / A80BL1026 / 2530037 / 32460730 / 12855 / 3-12-35 / 15209 / 31219 / 17012 / 25-708PU / R307453 / R30934 / RB201 / RBT201 / E-7453 / E-934 / D94 / 321-175 / 321-175U / M1888 / 09-3344 / TRB6326 / TRB6326UB / PL1119	14008	100
Torque Rod Bushing	222-00 / A80BL1052 / 16592 / 25-741PU / H151 / E-7454 / D99 / 321-173U / M1848 / 09-3341 / TRB6330	14011	100
Torque Rod Bushing		14014	100
Torque Rod Bushing		14015	101
Torque Rod Bushing		14016	101
Torque Rod Bushing		14017	101
Torque Rod Bushing		14026	101
Torque Rod Bushing		14029	101
Torque Rod Bushing		14030	101
Torque Rod Bushing		14031	102
Torque Rod Bushing		14071	102
Torque Rod Bushing	722-00 / UCA-3754 / 026900 / A80BL1026 / 2530037 / 32460730 / 12855 / 3-12-35 / 15209 / 31219 / 17012 / 25-708PU / R307453 / R30934 / RB201 / RBT201 / E-7453 / E-934 / D94 / 321-175 / 321-175U / M1888 / 09-3344 / TRB6326 / TRB6326UB / PL1119	14073	102
Torque Rod Bushing Kit	7620-00 / UXA000011-900 / UXA-000011900 / 3-69-2 / 7637-00 / GDH7620-00 / 15-1217 / FR266 / H236 / E-1023 / E-9362 / 334-565 / 334-640 / TRK6300 / TRK6300UB / TH47-37900 / TH53-37637	13042	100
Trunnion Bushing	11357-00 / 20248-01 / 890-00 / T5711 / A80BL3020 / 385216 / 43.2001 / 25-828 / R305216 / R305217 / R307455 / H126 / H126UB / H127 / E-5216 / E-5217 / E-7455 / D97 / 325-107 / 325-107U / 325-122 / 09-3365 / 09-3366 / M12900 / M12900UB / HU10000 / HU10065	14027	101
Trunnion Bushing		14503	102

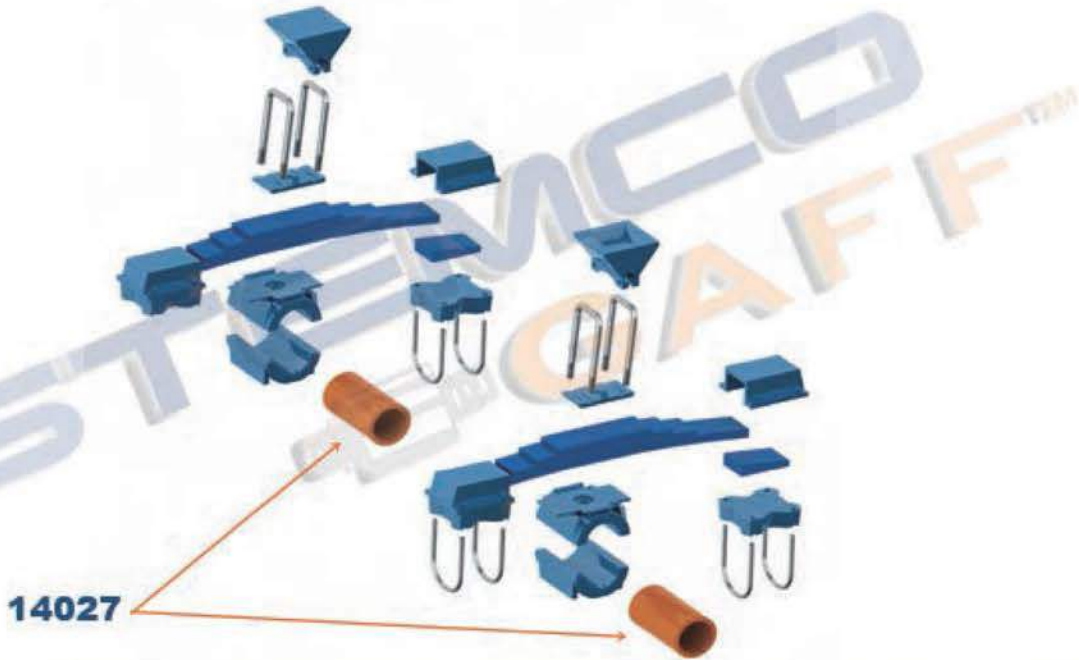
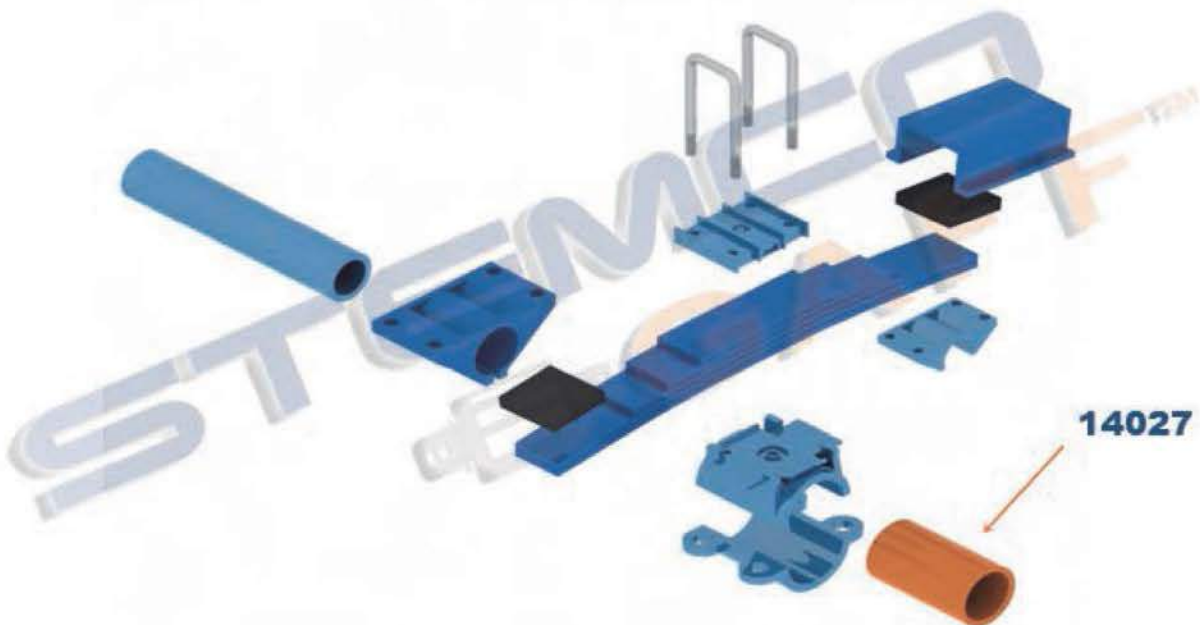

**STEMCO GAFF replacement parts compatible with:
HUTCHENS™ H-440 SERIES****STEMCO GAFF replacement parts compatible with:
HUTCHENS™ H-900 SERIES**

**STEMCO GAFF replacement parts compatible with:
HUTCHENS™ H-9600/CH-9600 (CAST)
& H-7600/CH-7600 (CAST) SERIES**



**STEMCO GAFF replacement parts compatible with:
HUTCHENS™ H-9700/CH-9700 & H-7700/CH-7700
SERIES TWS (TANDEM WIDESPREAD)
H-9700 & CH-9700 (CAST) TWS 109 & 121**

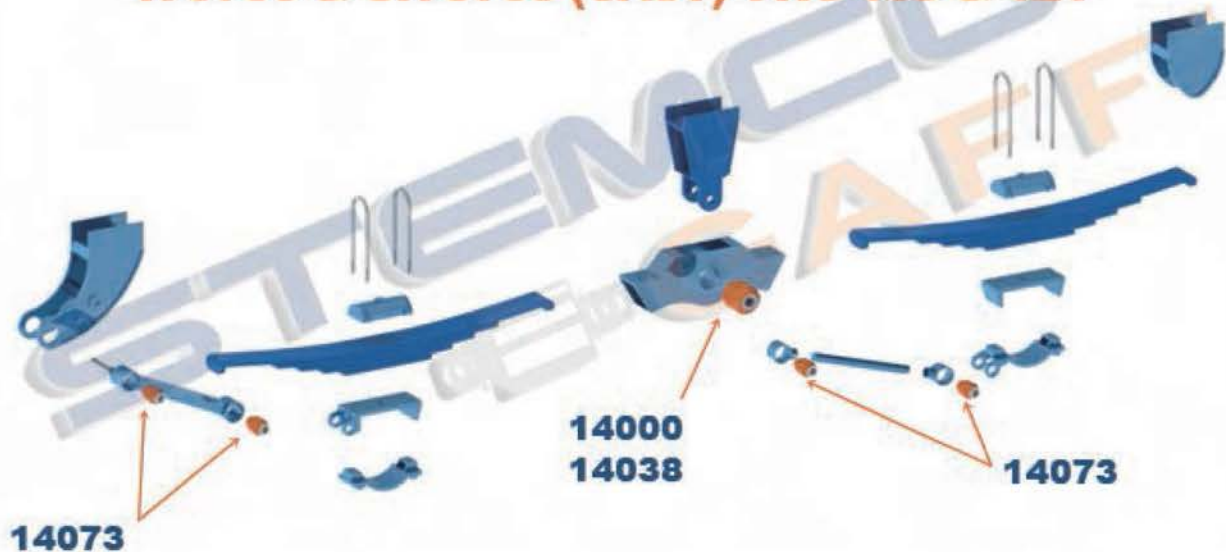

Hutchens continued

13001



Torque Rod Bushing

OD	2	3/16"
OD<	1	13/16"
ID	1	1/4"
LG	2	3/8"
HD	90A	

INCLUDED IN:
13042

OEM
7620-00
UXA-000011
A80BL1051
7620-00
GDH7620-00
25-750PU
R307433
R30927
RBT200
RBT200UB

Notes: hard poly inner sleeve

13042



Torque Rod Bushing Kit

INCLUDES	
QTY 2	13001
QTY 1	13015

OEM
7620-00
UXA000011-900
UXA-000011900
3-69-2
7637-00
GDH7620-00
15-1217
FR266
H236
E-1023

Notes: no tool needed bushing is pressed into the equalizer using the bolt

14000



Equalizer Bushing

OD	3	5/16"
LG	3	7/8"
BH		3/4"
HD	80A	

OEM
7010-00
UCA-0472
064200
076800
32460848
25-705PU
A80BL1025
R301999A
R307452
H102

Notes:

14003



Torque Rod Bushing

OD	2	3/16"
OD<	1	13/16"
ID	1	1/4"
LG	2	3/8"
HD	90A	

OEM
7620-00
586121
UXA-0011
090600
31339
25-750PU
RB200
E-7433
E-927
321177U

Notes: no inner sleeve flat sides / uses bolt 13015 / 13001- hard poly inner sleeve

14007



Torque Rod Bushing

OD	2	-
ID	1	-
LG	3	-
HD	80A	

OEM

TOOL 18836

Notes: chamfered / universal (known as 1-2-3 because of dimensions) / 14014 - standard / additional tool suggestion coming soon 40124

14008



Torque Rod Bushing

OD	1	15/16"
ID	1	-
LG	3	-
HD	80A	

OEM
722-00
UCA-3754
026900
A80BL1026
2530037
32460730
12855
3-12-35
15209
31219

Notes: chamfered / stepped ends - 14073

TOOL 18836

14011



Torque Rod Bushing

OD	2	3/16"
OD<	1	3/4"
ID	1	-
LG	3	1/8"
HD	80A	

OEM
222-00
A80BL1052
16592
25-741PU
H151
E-7454
D99
321-173U
M1848
09-3341

Notes: additional tool suggestions 18836, coming soon 40124

14014



Torque Rod Bushing

OD	2	-
ID	1	-
LG	3	-
HD	80A	

OEM

Notes: standard / universal (known as 1-2-3) / 14007- chamfered / additional tool suggestions 18836, coming soon 40124

Hutchens continued

14015

OD	1 13/16	~
ID	1	~
LG	3	~
HD	80A	

OEM



Torque Rod Bushing

Notes: additional tool suggestions 18836, coming soon 40124

14016

OD	2	~
ID	1 1/4	~
LG	3	~
HD	90A	

OEM



Torque Rod Bushing

Notes: additional tool suggestions 18836, coming soon 40125

14017

OD	1 15/16	~
ID	1 1/4	~
LG	2 3/4	~
HD	80A	

OEM



Torque Rod Bushing

Notes: additional tool suggestions 18836, coming soon 40126

14022

OD	6	~
ID	5	~
LG	7	~
HD	80A	

OEM



Equalizer Bushing

Notes:

14026

OD	1 13/16	~
ID	7/8	~
LG	3	~
HD	80A	

OEM



Torque Rod Bushing

Notes: additional tool suggestions 18836, coming soon 40128

14027

OD	5	~
ID	4	~
LG	9	~
HD	90A	

OEM



Trunnion Bushing

Notes: standard / chamfered - 14012

11357-00
20248-01
890-00
T5711
A80BL3020
385216
43.2001
25-828
R305216
R305217R307455

14029

OD	1 3/4	~
ID	1	~
LG	3	~
HD	80A	

OEM



Torque Rod Bushing

Notes: additional tool suggestions 18836, coming soon 40128

14030

OD	2 1/16	~
ID	1	~
LG	3	~
HD	80A	

OEM



Torque Rod Bushing

Notes: additional tool suggestions 18836, coming soon 40128

Hutchens continued

14031



Torque Rod Bushing

OD	1 3/4"
ID	7/8"
LG	3"
HD	80A

OEM

Notes: additional tool suggestions 18836, coming soon 40130

14038



Equalizer Bushing

OD	3 5/16"
ID	1 1/4"
LG	3 7/8"
HD	80A

OEM
16146-01
25-706PU
321-221U
334-1272
D101
E-7621
E-8666
E-9472
E-9473
EQ53-35118

Notes: additional tool suggestions 18836, coming soon 40132

14071



Torque Rod Bushing

OD	2 9/16"
ID	1 1/2"
LG	4 1/8"
HD	80A-71D

OEM

Notes:

14072



Equalizer Bushing

OD	3 1/4"
ID	1"
LG	3"
HD	80A

OEM

Notes:

14073



Torque Rod Bushing

OD	1 15/16"
ID	1"
LG	3"
HD	80A

OEM
UCA-3754
026900
A80BL1026
2530037
32460730
12855
3-12-35
15209
31219
17012

TOOL 18836

Notes: stepped ends / new design / chamfered - 14008

14503



Trunnion Bushing

OD	5"
ID	4"
LG	8"
HD	80A

OEM

Notes:

International

DESCRIPTION	OEM	PART ID	PAGE
Alternator Bushing		31560	131
Auxiliary Load Spring	3554205C2	34521	133
Beam Bushing Kit	HCK340LP / R302862 / SK80340 /	13504	118
Beam End Adapter	496529C91 / 20-802 / R302372 / HAK34 / E-2372 / 334-108 / M2010 / HAK92 / AK34100 / HCK340LP / R302862 / SK80340	13502	118
Beam End Adapter	593717C91 / 20-806 / R302555 / HAK50 / E-2555 / 334-138 / 09-5472 / HAK124 / AK50100	13547	120
Beam End Adapter Kit	90001002 / 537372C91 / 20-801 / R309420 / HAK44 / E-9420 / 334-127 / 334-467 / 09-5462 / HAK112 / AK38200	13609	121

International continued

DESCRIPTION	OEM	PART ID	PAGE
Beam End Adapter Kit	1611872C91 / 484891C91 / AK50-45000 / 20-803 / 20-805 / R309421 / HAK45 / E-9421 / 334-1123 / 334-126 / 334-354 / M2966 / 09-5461 / 09-5495 / HAK114 / AK45100	13610	121
Beam End Bushing	124865R1 / 20-809PU / R301340 / R309511 / C865 / C865UB / E-1340 / E-9511 / D404 / D404 / 321-120 / 321-120U / M1724 / 09-5501 / M1976 / EB34000	13501	118
Beam End Bushing	233432R91 / 20-813 / R302554 / C872 / E-2554 / 321-129 / 09-5471 / M1990HE / EB50000	13545	120
Beam End Bushing	124892R1 / 441302C92 / 20-810PU / R301341A / R302771 / C862 / C862UB / C871 / E-1341A / E-2771 / E-9512 / D402 / 321-126 / 321-126U / 321-242 / M1726 / 09-5511 / 09-5728 / M1970 / M1970UB / M1988 / EB38000	13553	120
Beam End Bushing	590162C1 / 60-1540PU / N109 / E-2940 / E-8677 / D240 / 325-235U / M2118 / 09-4410 / TRB5721	14504	124
Beam End Bushing	2507714C1 / WC10050 / 60-1535 / R304382A / N120 / N120UB / E-4382A / E-8683 / D441 / 321-229 / 321-229U / M3456 / TRB5713 / PB57-21139	14513	125
Beam End Bushing	90008149 / 2507718C1 / 60-1501 / R304410A / N124 / E-4410A / D448 / 321-231 / 321-231U / M3454 / TRB5703 / PB57-21149	14533	125
Beam End Bushing Kit	1697717 / 1697717C91 / 20-861 / R309325 / BP-87 / E-9325 / 334-830 / 334-830U / 09-5524 / 09-5528 / BP198 / BP198HE / BP198UB / EB50-21013	13607	121
Bearing Washer		31556	130
Bolster Spring	2506180C91 / ZAK60879L / 2501596C1 / E-11496 / LP50-24000 / SK80268 / HS56 / HS10000 / E-9410 / D2003 / 334-852 / 334-852A / 09-6100	13601	121
Bolster Spring Kit	HD64179037 / E-14374 / 334-1727 / MLC3 / HS130 / E-14044 / 334-1845 / MLC5 / LP50-24179	13626	121
Bolster Spring Kit	ZAK60879L / 2506180C91 / E-11496 / LP50-24000 / HS56 / HS10000 / R3011496 / R309410 / HS99 / E-14047 / E-9410 / D2003 / 334-1720 / 334-852 / 334-852A / 09-6100 / MHS225K / LP50-24974	13722	124
Bolster Spring Pair	2506180C91 / ZAK60879L / E-11496 / LP50-24000 / HS56 / HS10000 / R3011496 / R309410 / E-9410 / D2003 / 334-852 / 334-852A / 90-6100	13721	124
Bushing Kit		31551	130
Cab Mount	14003022 / 14004200 / 449713C1 / 449713C2	10004	112
Cab Mount		10005	112
Cab Mount		10007	112
Cab Mount	7007-05	10008	112
Cab Mount	436149R1 / 555645C1 / AM52137	10009	112
Cab Mount	174085-03	10010	112
Cab Mount	476869C1 / 35-1363PU / 35-564PU / R307462 / UM1196 / E-7462 / D36 / D5 / D51 / 329-147U / 329-177U / M17392UB / M17417 / M17417UB / PL1009 / PL1136	11705	116
Cab Mount	2074780	18103	126
Cab Mount	3515345C1 / 3515345C2 / CM55-615C2	34515	133
Cab Mount	3574670C91 / 3574671C91 / 3574678C1 / 3574680C1 / 3589599C91 / 3844147C91	34516	133
Cab Mount Bushing		34532	135
Cab Mount Bushing		34552	135
Cab Mount Kit	3512064C4 / CM55-614C4	34528	134
Cab Mount Kit	3444147C91 / 3574670C91 / 3574671C91 / 3589599C91 / 3844147C91 / 3574678C1 / 3574680C1 / CM55-61454	34540	135
Camshaft Bushing	1691529C2 / E-5512 / 02-210	17501	126
Carrier Bearing Assy	283071C93 / CB2106611XSA / DS-6049	40074	136
Carrier Bearing Assy	2101211X / 2591050C91 / 283069C93 / DS-6048	40075	136
Center Bushing	965080R1 / M1978 / R301338 / R309520 / 20-816 / C864 / E-1338 / E-9520 / D403 / 321-117 / 321-119 / M1725 / 09-5500 / M1974 / CB34012	13500	118
Center Bushing	124901R91 / 20-817 / R301339 / R306979 / R309359 / C863 / C877 / C887 / E-1339 / E-6979 / E-9359 / D401 / 321-122 / 321-124 / 321-243 / M1727 / 09-5510 / 09-5512 / 09-5513 / M1972 / M1972UB / CB38012	13505	118
Center Bushing	893059R92 / 20-860 / R301546 / HBK38 / E-1546 / 322-102 / 322-102A / 08-6301 / HBK100	13534	120
Center Bushing	1672608C1 / E-9359 / C2000	13656	112
Center Bushing	790337C1 / 60-1531PU / R304253 / R308681 / N112 / N112UB / E-4253 / E-8681 / D237 / 321-237 / 321-237U / M3453 / TRB5709 / PL1155	14527	125

International continued

DESCRIPTION	OEM	PART ID	PAGE
Compressor Mount		30511	128
Coupling	162426 / 867499R1 / FP99-69426	17506	126
Easy-Mount Torque Rod Bushing	1693061C1 / E-4664 / 20-833PU / R302226 / R307639 / C879 / C879UB / E-2226 / E-7639 / D423 / 321-132 / 321-132U / M2070 / 09-5723 / TRB6820 / TRB6820UB / TS38000	83520	136
Easy-Mount Torque Rod Bushing	1693060C1 / 3249322R1 / 20-832PU / R302225 / R307638 / C878 / C878UB / FL55 / E-2225 / E-7638 / D421 / 321-131 / 321-131U / M2069 / TRB164 / TRB6164 / TS34000 / TS34095	83522	136
Easy-Mount Torque Rod Bushing	1691140C91 / 20-859 / R309326 / BP-87 / BP-88 / E-9326 / 334-831 / 09-5525 / BP200	83596	136
Equalizer Bushing		10028	114
Equalizer Bushing	497501C2 / 30-1302 / R303784 / IH5 / E-3784 / D437 / 321-195 / 321-195U / M3478 / 09-6851 / TRB5169 / TRB5169UB / NA47000	13577	120
Equalizer Bushing	1607727C1 / 55-152PU / R301966 / R303977 / R308654 / R209 / E-3977 / E-8654 / D069 / D69 / 321-152 / 321-191 / 321-191U / M3399 / TRB5029 / PL1148	15001	125
Exhaust Mount		31524	129
Fan Hood Mount		31539	129
Fifth Wheel Bushing	SAFXB0011 / XB0011 / FW51-32011	18215	126
Fifth Wheel Bushing	SAFXB0009 / KP116	18221	127
Fifth Wheel Bushing	SAFXB10605 / FW99-32605	40035	136
Hood Guide	1685916C1 / 472697C1 / 30-1358PU / R307483 / UM1313 / E-7483 / D42 / 329-106U / M17434 / M17434UB / PL1113	10026	114
Hood Guide		34536	135
Hood Hinge Bushing		10025	114
Hood Latch		10024	114
Hood Latch		10510	115
Hood Latch Assy	16899930C91 / 1699929C9 / 499523C3 / HLN1002	10506	115
Hood Packing Pad	598958C1 / 598958C2	10027	114
Hood Pin		10507	115
Hood Swivel Bushing		34530	134
Load Pad	427893R1 / 42984R1 / 20-824 / 20-826PU / R301598A / R301960 / R309513 / LC1 / LC1UB / LC3 / LC3UB / E-1598A / E-1599A / E-1960 / E-9513 / D135 / 325-101 / 325-103 / 325-104 / 325-104U / M2062 / 09-5532 / 09-5536 / 09-5537 / MLC4 / MLC8 / HC20000	13650	122
Load Pad		30508	128
Motor Mount		10017	113
Motor Mount	753997C91 / 753997C92 / 753997C93 / 30-1357PU / R307484 / UM1328 / E-7484 / D41 / 329-133U / PL1110	10020	113
Motor Mount		10021	113
Motor Mount	2226-06	10022	113
Motor Mount		10032	114
Motor Mount	503579C1 / 503837C1 / 507569C91 / 30-1384PU / R308918 / UM207 / E-8918 / D430 / 329-150U / M20304 / M20304UB / PL1048	10075	114
Motor Mount	1811 / 470031C2 / EE14003053 / 30-1369PU / D53 / 329-179U / M20307 / M20307UB / PL1055	10503	115
Motor Mount	4170 / 14003030 / 14003052 / 479237C1 / 583955C1 / 30-1372PU / D301 / 329-181U / M20309 / M20309UB / PL1104	10505	115
Motor Mount		17257	126
Motor Mount		30500	127
Motor Mount		30503	127
Motor Mount		30509	128
Motor Mount		30510	128
Motor Mount		30516	128
Motor Mount	AZ-14840-06	30517	128
Motor Mount		30518	129
Motor Mount	286235C2 / 7807231C1 / 301-379PU / D309 / 329-187U	34505	132
Motor Mount	286236C2 / 301-380PU / D310 / 329-188U	34506	132

International continued

DESCRIPTION	OEM	PART ID	PAGE
Motor Mount	1664730C5 / 1664730C7 / 2014777C2 / 1664728C2 / M17445 / MM55-620C7 / MM55-626C2	34507	132
Motor Mount	1664723C1 / 1664723C2 / 1664723C3 / 1664724C1 / 1664724C2 / 1664724C3 / MM55-623C3 / MM55-624C3	34509	133
Motor Mount Kit	1664728C1 / 1664728C2	34500	132
Motor Mount Kit	1664730C5 / 1664730C7 / 2014777C2 / 1664729C1 / 1664729C2 / 1664729C3 / 1664729C4 / 1664729C5 / 1664729C7 / M17445 / MM55-62004 / MM55-629C7	34510	133
Motor Mount Kit	1664728C1 / 1664728C2	34524	134
Motor Mount Kit	1664730C5 / 1664730C7 / 2014777C2 / 1664729C1 / 1664729C2 / 1664729C3 / 1664729C4 / 1664729C5 / 1664729C7 / M17445 / MM55-62005	34525	134
Motor Mount Kit	1664723C1 / 1664723C2 / 1664723C3 / MM55-624C3 / MM55-623C3	34526	134
Motor Mount Kit	3549169C1 / 3549169C2	34529	134
Overload Cushion	759832C1 / 20-823 / R302232 / R309514 / LC4 / LC4UB / E-2232 / E-9514 / D134 / 325-100 / 325-100U / M2061 / 09-5690 / MLC10 / HC10000	13649	122
Radiator Mount	987395A2 / 30-1356PU / E-7482 / D40 / 329-112U	10011	112
Radiator Mount	780723C1 / 30-1378PU	10012	113
Radiator Mount	780723C7 / 30-1378PU	10013	113
Radiator Mount	459591C2 / 30-1373PU	10014	113
Radiator Mount	CBA 2465027	10016	113
Radiator Mount	270203C1 / R307644 / E-7644 / D44 / 329-119U / PL1114	18063	126
Radiator Mount		30513	128
Radiator Mount		30520	129
Radiator Mount		31552	130
Radiator Mount	471478C1 / 471478C2 / M203021 / RM55-638C2	31604	132
Radiator Mount		34545	135
Radiator Tie Rod Bushing		10508	115
Rebound Roller Kit	1622375C1 / 3514950C1	11747	117
Shifter Bushing Kit	FULK3399 / MS99-63399	11611	116
Shifter Linkage Bushing		31561	131
Shock Absorber Bushing	401754 / 40-340 / R307529 / HB593 / SB1UB / E-7529 / D1 / 320-153 / 320-153U / M695 / M-17526UB / MH1432 / MH1432UB / PL1026	18566	127
Shock Absorber Bushing	1T18197A / 2350908 / 2350908U / 12-5-123 / 12-5-123A / SB03-83008	30507	127
Shock Absorber Bushing		30522	129
Shock Absorber Bushing		30539	129
Shock Absorber Bushing		30557	129
Shock Absorber Bushing		31581	131
Spring Bushing		10074	114
Spring Bushing		31554	129
Spring Bushing	3525665C1 / RB253 / RB-253 / SP55-52600	34511	133
Spring Bushing	47937C1	34523	134
Spring Bushing Kit	471226C1 / 53099V / 1671766C1 / 1680033C1 / 1664223C1 / RNG-OGB / RNG-BM / OGB-RNG / B1442-55 / 327-485 / M5352 / B1163-22 / B1205-43 / B1314-55 / B1435-55 / E694-55 / IS620 / 327-179 / 327-212 / 327-256 / 327-479 / 330-149 / 330-190 / 334-964 / M1634 / M4794 / M4878 / M5096 / MIH14UB / MIS1486 / SK00-10500 / SK55-10600 / SK55-10700 / SP55-113C1	19001	127
Spring Bushing Kit	47937C1	34519	133
Spring Bushing Kit	47937C1	34537	135
Spring Pad	IH14 / 334-747 / MIH52	30544	129
Spring Pin Bushing	3538115C1 / 10-1010 / R308804 / RB205 / RB205UB / RB234 / RB235 / RB260 / RB268 / E-8804 / D46 / RB-205 / RB-205U / RB-234 / RB-268 / 09-6516 / MR656 / MR656UB / MR664 / UB20500	11005	115
Spring Pin Bushing	503611C1 / 503611C2 / B1363-59 / RB161 / TB68 / 327-306 / RB-161 / TB-68 / M16884 / M5212 / MR568 / MTB160 / SP59-11378 / UB16100	11060	116

International continued

DESCRIPTION	OEM	PART ID	PAGE
Spring Pin Bushing	358115C1 / RB205 / RB268 / E-8804 / RB-157-OS / RB-205 / RB-268 / MR782 / PB46-26268 / UB20500-OS	11083	116
Spring Pin Bushing	1697129C91 / 50-275 / TB68 / 327-434 / 50-275 / TB-68 / M5212 / SP59-11010	11758	117
Stabilizer Bar Bushing		17272	126
Stabilizer Bar Bushing		17273	126
Stabilizer Bar Bushing		31546	130
Stabilizer Bar Bushing		31547	130
Stabilizer Bar Bushing		31548	130
Stabilizer Bar Bushing		31553	130
Stabilizer Bar Bushing		31564	131
Stabilizer Bar Bushing		31565	131
Stabilizer Bar Bushing		31567	131
Stabilizer Bar Bushing		31570	131
Stabilizer Bar Bushing		31583	131
Stabilizer Bar Bushing		31594	132
Stabilizer Bar Bushing		31609	132
Suspension Bushing Kit		15060	125
Suspension Mount		30515	128
Sway Bar Bushing	16005305 / 501535C2 / R303795	12329	118
Torque Rod		12054	117
Torque Rod		13629	121
Torque Rod		34527	134
Torque Rod Assy	3581270C1 / 945381 / TR59-41376	11080	116
Torque Rod Assy	1661925C91 / A13102146A / 6813262065 / 68-13262-065 / 62000-610 / 944270 / K195-375 / 25164946 / 17QF460P240 / 1RY39307P13 / 5435-947794 / IPC 925030 / 925030 / TR59-41375	11751	117
Torque Rod Assy	1693537C1 / MR661 / UR661 / E-2642	12044	117
Torque Rod Assy	1516350C91 / 1516350C92 / 924970 / 942119 / 943790 / 945240 / TR62-41238	12074	117
Torque Rod Assy	HD62010455 / HUD62010455 / ZAK62010455 / ZJF62010455 / TR50-42455	12396	117
Torque Rod Assy	HD62350615 / HUD62350615 / ZAK62350615 / ZJF62350615 / TR50-41615	13733	118
Torque Rod Assy	48411006 / 50376001 / 62007365 / 32271-102 / E-9394 / E-9409 / 345-734 / 345-792 / 345-815 / TR50-41102	13735	124
Torque Rod Assy	HD62350645 / HUD62350645 / ZAK62350645 / ZJF62350645 / TR50-41645	34555	124
Torque Rod Assy	HD62000590 / HD62001590 / HUD62000590 / HUD62001590 / ZAK62000590 / ZAK62001590 / ZJF62000590 / ZJF62001590 / 924920 / 942174 / 944160 / 944220 / 948574 / TR50-42590	34556	135
Torque Rod Assy	3548381C1 / 4C4Z4612AA / 501565C2 / IH22 / E13989 / 345-866 / R533 / TR55-418C1	34563	136
Torque Rod Bushing	412587C1 / 30-1382 / IH9 / E-3086 / 321-186 / M2135 / TRB8640	10000	136
Torque Rod Bushing	20-836PU / R305275 / HS44 / E-5275 / D405 / 321-223 / 321-223U / TRB6185 / TRB6185UB / PL1146A	11004	112
Torque Rod Bushing	3249322R1 / M2069	11556	116
Torque Rod Bushing	698468R92	11716	116
Torque Rod Bushing	836940 / 836940 / 839310 / R3010303 / E10303 / E-10303 / 321-369 / TS59-22400 / CS70815 / KB920	11729	116
Torque Rod Bushing	1515966C1 / R307426 / R307766 / CHA54 / CHA54UB / E-7426 / E-7766 / D186 / 321-276 / 321-276U / TRB8644 / TRB8644UB / PL1046 / TH19-22010	11739	117
Torque Rod Bushing	1693064C1 / R302815 / R309518 / C884 / E-2815 / E-9518 / D293 / D293S / 321-136 / 321-136U / 09-5719 / TRB6119 / 38000	12031	117
Torque Rod Bushing	322069C91 / 20-850 / R302238 / C870 / E-2238 / D316 / 321-141 / 321-141U / M2068 / 09-5519 / TRB6186 / TRB6186UB / IN35190	13514	118
Torque Rod Bushing	438506C1 / 438506C91 / 20-885 / R303411 / RBT207 / E-3411 / D312 / 321-144 / 321-144U / M-3262 / 09-5518 / TRB6260 / TRB6260UB / IN35180	13515	119
Torque Rod Bushing	1693069C1 / 20-876 / R302816 / C881 / E-13967 / E-2816 / 321-137 / M2088 / 09-5716 / TRB6181 / TH50000	13516	119

International continued

DESCRIPTION	OEM	PART ID	PAGE
Torque Rod Bushing	1693070C1 / 384191C91 / 20-834 / R302814 / R309517 / C880 / E-13964 / E-2814 / E-9517 / D406 / 321-135 / M2087 / TRB6118 / TS49000	13517	119
Torque Rod Bushing	1693066C1 / 20-831PU / R302228 / R308651 / C883 / C883UB / E-2228 / E-8651 / D422 / 321-133 / 321-133U / M2072 / 09-5721 / TRB6112 / TRB6112UB / TT38000	13518	119
Torque Rod Bushing	1693061C1 / E-4664 / 20-833PU / R302226 / R307639 / C879 / C879UB / E-2226 / E-7639 / D423 / 321-132 / 321-132U / M2070 / 09-5723 / TRB6820 / TRB6820UB / TS38000	13520	119
Torque Rod Bushing	ZJF47691L / 20-836PU / R305275 / HS44 / E-5275 / D405 / 321-223 / 321-223U / TRB6185 / TRB6185UB / PL1146 / TS50-22691	13521	119
Torque Rod Bushing	1693060C1 / 3249322R1 / 20-832PU / R302225 / R307638 / C878 / C878UB / FL55 / E-2225 / E-7638 / D421 / 321-131 / 321-131U / M2069 / TRB164 / TRB6164UB / TS34000 / TS34095	13522	119
Torque Rod Bushing	1693063C1 / 20-851PU / R303868 / C889 / E-3868 / D424 / 321-265 / 321-265U / TRB6822 / TRB6822UB / TS38750	13528	119
Torque Rod Bushing	1693066C1 / 20-831PU / R302228 / E-2228 / D422 / M2072 / 09-5721 / TRB6112 / TT38000	13533	120
Torque Rod Bushing	1693061C1 / E-4664 / 20-833PU / R302226 / R307639 / C879UB / E-2226 / E-7639 / D423 / 321-132U / M2070 / 09-5723 / TRB6820UB	13536	120
Torque Rod Bushing	TSHS73 / HS73 / E-10309 / 321-360 / TT50-22697	13582	121
Torque Rod Bushing	1693065C1 / 44809 / 44809-000 / 57750230 / 09-5720 / 321-134 / C885 / E-2227 / M2071 / R302227 / TRB6116 / TT34000	13684	122
Torque Rod Bushing	1694129C1 / 321-267 / TS38875	13685	122
Torque Rod Bushing	513267C1 / 55-128PU / R150UB / E-7521 / E-812 / D72 / 321-158 / 321-158U / M1846 / TRB6002 / TRB6002UB / PL1117	15008	125
Torque Rod Bushing	34734C1 / 55-129 / 55-129PU / R301980 / R307520 / R129 / R129UB / E-1061 / E-1980 / E-7520 / E-8687 / D73 / 39400016 / 321-153 / 321-153U / M1449 / TRB6004 / TRB6004UB / PL1118 / UB30000	15013	125
Torque Rod Bushing		30505	127
Torque Rod Bushing		30506	127
Torque Rod Bushing		34512	133
Torque Rod Bushing		34534	135
Torque Rod Bushing Kit	TSR234 / 55-146 / R309350 / R234 / E9350 / 334-896 / 09-228202 / TRK6002 / TH83-37640	15061	125
Torque Rod End Assy	1693531C1 / E-10310 / R301024 / R3010310 / R302639 / MR610 / UR610 / E-2639 / 345-610 / 345-741 / 345-742 / 928610 / 09-5420 / RU610 / TR71000	13683	112
Torque Rod End Assy	1693533C1 / MR630 / UR630 / E-2638 / 345-620 / 345-630 / 345-738 / 928630 / 09-5422 / RU620 / TR72000	13686	122
Torque Rod End Assy	1691033C91 / 20-9034 / MR660 / 345-660 / 09-5431 / R660 / TR75000	13690	122
Torque Rod End Assy	1693536C1 / 1693537C1 / R3010315 / R302642 / MR660 / MR661 / UR660 / UR661 / E-2642 / 345-660 / 345-661 / 345-741 / 345-742 / 928660 / 928661 / 09-5424 / 09-5431 / RU660 / RU661 / TR75000	13691	123
Torque Rod End Assy	1691035C91 / 20-9031 / MR670 / 345-670 / 09-5432 / R670 / TR81000	13692	123
Torque Rod End Assy	1693542C1 / 20-9033 / MR680 / UR680 / E-2643 / 345-680 / 928680 / 09-5433 / R680 / TR76000	13694	123
Torque Rod End Assy	1693543C1 / 20-9023 / MR681 / UR681 / E-10317 / 345-681 / 928681 / 09-5426 / R681 / TR76000	13695	123
Torque Rod End Assy	1693544C1 / 20-9032 / MR690 / UR690 / 345-690 / 928690 / 09-5435 / R690 / TR77000	13696	123
Torque Rod End Assy	1693545C1 / 20-9022 / R302812 / MR691 / UR691 / E-2812 / 345-691 / 928691 / 09-5429 / R691 / TR77000	13697	123
Torque Rod End Assy	1693546C1 / MR700 / 345-700 / 20-9036 / 928700 / 09-5434 / R700 / TR85000	13698	123
Torque Rod End Assy	1693535C1 / MR701 / 345-701 / 20-9026 / E-10319 / 928701 / 09-5430 / R701 / TR85000	13699	123
Torque Rod End Assy	MR766 / E-11784 / 345-612 / 942690 / TR83000	13700	124
Torque Rod End Assy	1693550C1 / 20-9017 / MR767 / E-11748 / 345-794 / 09-5807 / TR74000	13701	124
Torque Rod End Assy	1693559C1 / 345-794 / 928665 / 90-5813 / TR78000	13703	124
Vertical Drive Bushing	868789R91 / R301940 / R309515 / C874 / C874UB / E-1940 / E-9515 / D107 / 321-125 / 321-125U / 09-5535 / TRB5170 / HV38000	13592	121
Wear Pad		31598	132
Wear Shims	258892C91 / R306122 / HT212 / E-6122 / 334-898 / 09-6241 / M14712	13542	120

**STEMCO GAFF replacement parts compatible with:
INTERNATIONAL
MOTOR MOUNT ASSEMBLY 9400**

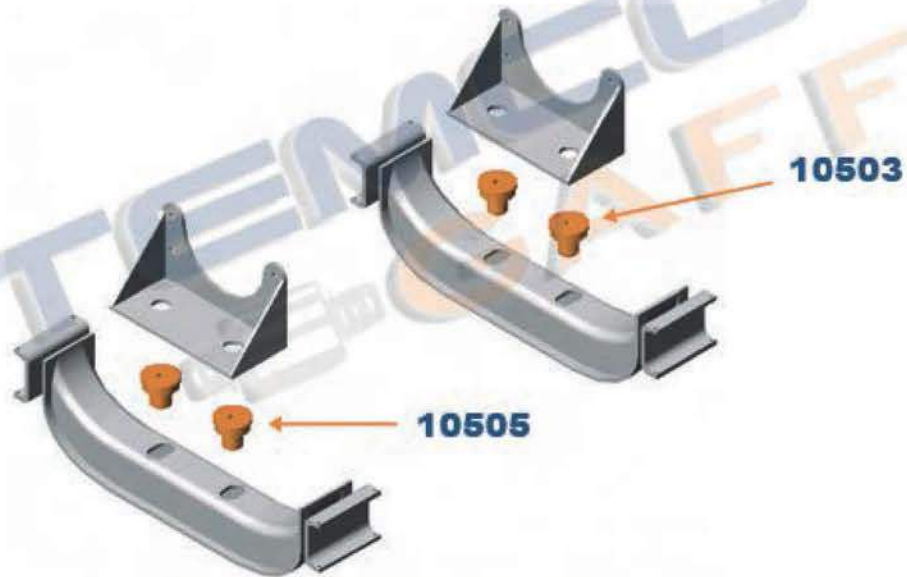

**STEMCO GAFF replacement parts compatible with:
INTERNATIONAL® AIR SINGLE-TANDEM
REAR AXLE**



**STEMCO GAFF replacement parts compatible with:
INTERNATIONAL® DRIVE AXLE
TRUCK SPRING**



**STEMCO GAFF replacement parts compatible with:
INTERNATIONAL® MOTOR MOUNT
REAR ASSEMBLE**

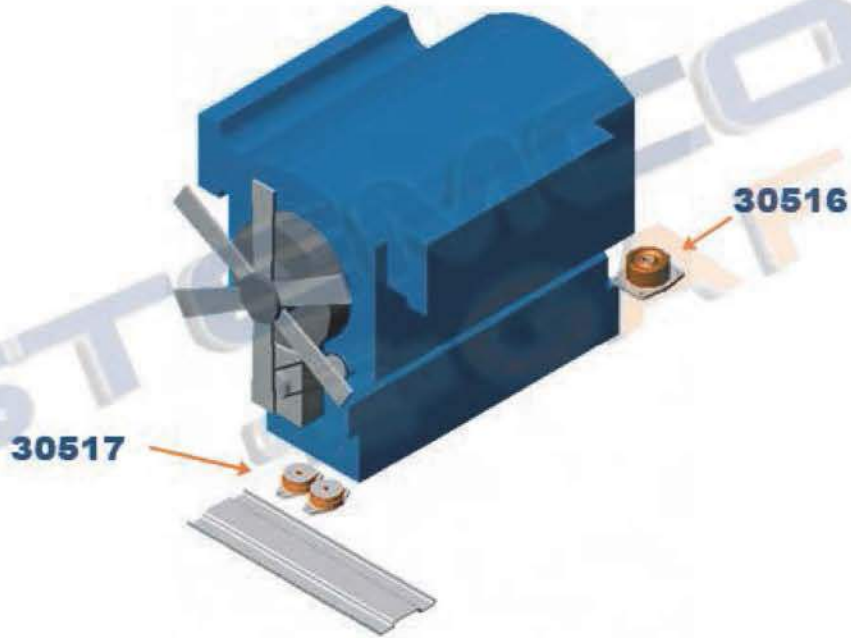
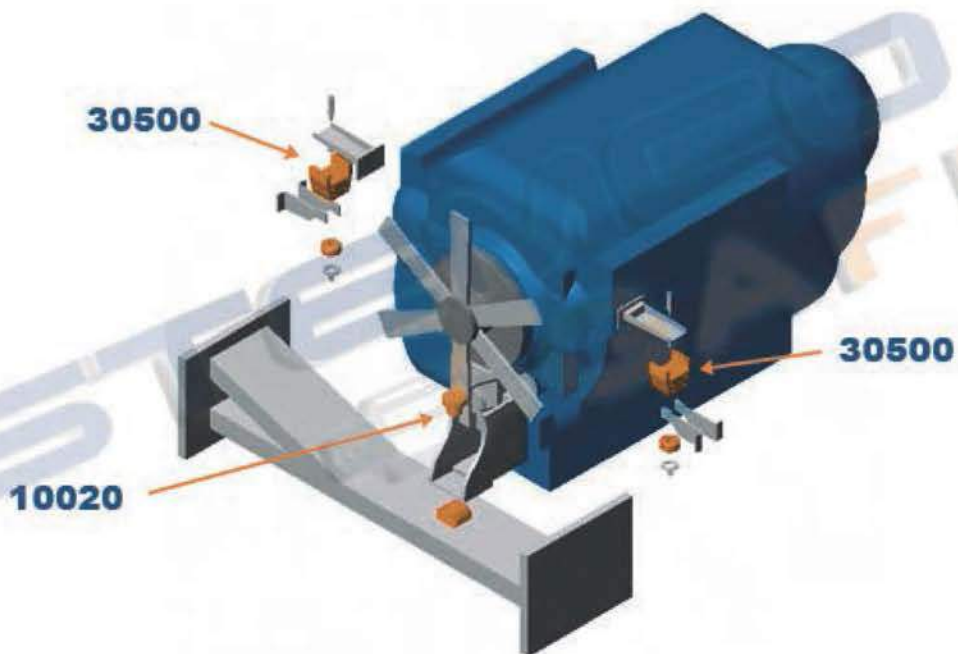

**STEMCO GAFF replacement parts compatible with:
INTERNATIONAL® MOTOR MOUNT****STEMCO GAFF replacement parts compatible with:
INTERNATIONAL® MOTOR MOUNT 2**

**STEMCO GAFF replacement parts compatible with:
INTERNATIONAL® SUSPENSION**



**STEMCO GAFF replacement parts compatible with:
INTERNATIONAL® SUSPENSION 2**



International continued

10000

Torque Rod Bushing

OD	2 3/8	-
ID	7/8	-
LG	3 1/8	-
HD	80A	

OEM
412587C1
30-1382
IH9
E-3086
321-186
M2135
TRB8640

Notes:

10004

Cab Mount

THK	1 15/16	-
WD	3	-
LG	3 1/2	-
HD	80A	

OEM
14003022
14004200
449713C1
449713C2

Notes:

10005

Cab Mount

OD	2 7/8	-
OD<	1 3/4	-
ID	5/8	-
LG	2 11/16	-
HD	80A	

OEM

Notes: use with 10007

10007

Cab Mount

OD	2 3/4	-
ID	5/8	-
LG	1 5/16	-
HD	80A	

OEM

Notes: use with 10005

10008Cab Mount
Front

THK	2 5/16	-
WD	3 3/16	-
LG	3 5/16	-
HD	80A	

OEM
7007-05

Notes:

10009Cab Mount
Rear

THK	1 15/16	-
WD	2 3/4	-
LG	2 13/16	-
HD	80A	

OEM
436149R1
555645C1
AM52137

Notes:

10010Cab Mount
Front

OD	1 5/8	-
ID	5/8	-
LG	1 1/8	-
HD	80A	

OEM
174085-03

Notes:

10011

Radiator Mount

OD	1 9/16	-
ID	5/8	-
LG	13/16	-
HD	80A	

OEM
987395A2
30-1356PU
E-7482
D40
329-112U

Notes:

International continued

10012

THK	3/4	~
WD	1 5/8	~
LG	5 7/16	~
HD	80A	

OEM
780723C1



Radiator Mount

Notes:

10013

THK	11/16	~
WD	1 13/16	~
LR	4 15/16	~
HD	80A	

OEM
780723C7
30-1378PU



Radiator Mount

Notes:

10014

OD	1 7/8	~
ID	1 1/8	~
LG	1/2	~
HD	80A	

OEM
459591C2
30-1373PU



Radiator Mount

Notes:

10016

OD	2 7/16	~
ID	1 11/16	~
LG	1 1/2	~
HD	80A	

OEM
CBA 2465027



Radiator Mount

Notes:

10017

OD	2 3/8	~
ID	3/4	~
LG	3 3/4	~
HD	80A	

OEM



Motor Mount

Notes:

10020

OD	3	~
OD<	1 15/16	~
ID	5/8	~
LG	2 3/16	~
HD	80A	

OEM
753997C91
753997C92
753997C93
30-1357PU
R307484
UM1328
E-7484
D41
329-133U
PL1110



Motor Mount
Front (Lower)

Notes: supersedes 10018 and 10019

10021

OD	2 13/16	~
ID	5/8	~
LG	1	~
HD	80A	

OEM



Motor Mount
Front (Upper)

Notes:

10022

ID	15/16	~
LG	2 7/16	~
C-C	4 5/8	~
HD	80A	

OEM
2226-06



Motor Mount
Front

Notes:

International continued

10024 LD 5 7/8 ~
HD 70A **OEM**



Hood Latch

Notes: universal hood latch / fits several old trucks battery box covers etc.

10025 OD 1 15/16 ~
ID 7/8 ~
LG 1 7/16 ~
HD 80A **OEM**



Hood Hinge Bushing

Notes:

10026 OD 2 3/16 ~
LG 2 1/16 ~
THR 3/4" - 16 UNC
HD 80A **OEM**



Hood Guide

Notes:

OEM
1685916C1
472697C1
30-1358PU
R307483
UM1313
E-7483
D42
329-106U
M17434
M17434UB

10027 THK 1/2 ~
WD 1 3/8 ~
LG 2 ~
HD 71D **OEM**



Hood Packing Pad

Notes:

OEM
598958C1
598958C2

10028 OD 2 5/8 ~
ID 1 ~
LG 4 15/16 ~
HD 80A **OEM**



Equalizer Bushing

Notes: no sleeve / verify dimensions compare to 13577 - metal sleeve or 13513 - metal sleeve

10032 THK 1/2 ~
WD 1 5/8 ~
LG 6 1/8 ~
HD 80A **OEM**



Motor Mount

Notes:

10074 OD 1 15/16 ~
OD< 1 9/16 ~
ID 7/8 ~
LG 1 11/16 ~
HD 90A **OEM**



Spring Bushing

Notes:

10075 OD 3 ~
ID 1 1/2 ~
LG 3 ~
HD 80A **OEM**



Motor Mount Rear

Notes: with metal sleeve

TOOL 11076

OEM
503579C1
503837C1
507569C91
30-1384PU
R308918
UM207
E-8918
D430
329-150U
M20304

International continued

10503



OD	2 13/16"
OD<	1 1/12"
ID	5/8"
LG	2 3/8"
HD	80A

OEM
1811
470031C2
EE14003053
30-1369PU
D53
329-179U
M20307
M20307UB
PL1055

Motor Mount Front

Notes:

10505



OD	3 1/16"
OD<	1 5/8"
ID	5/8"
LG	2 5/8"
HD	80A

OEM
4170
14003030
14003052
479237C1
583955C1
30-1372PU
D301
329-181U
M20309
M20309UB

Motor Mount Front

Notes:

10506



LG	8"
HD	80A - 97A

OEM
16899930C91
1699929C9
499523C3
HLN1002

Hood Latch Assy

Notes: all components not sold separately

10507



OD	2 1/4"
LG	1 3/4"
THR	5/16" - 18 UNC
HD	80A

OEM

Hood Pin

Notes:

10508



OD	1 7/8"
ID	1"
LG	7/16"
HD	80A

OEM

Radiator Tie Rod Bushing

Notes:

10510



LG	8"
HD	80A

OEM

Hood Latch

Notes: latch for 10506

11004



OD	2 1/16"
LG	6 5/8"
C-C	4 3/8"
BH	5/8"
HD	80A

OEM
20-836PU
R305275
HS44
E-5275
D405
321-223
321-223U
TRB6185
TRB6185UB
PL1146A

INCLUDED IN:
11078, 11081, 11769

TOOLS 11071, 18836

Torque Rod Bushing

Notes: rib style / 11006 - oversized / 12051 - grooved for torque rod with a center rib / 13521 - chamfered

11005



OD	2 1/2"
LG	7 1/2"
C-C	5 3/4"
BH	13/16"
HD	80A

OEM
3538115C1
10-1010
R308804
RB205
RB205UB
RB234
RB235
RB260
RB268
E-8804

Tool 11069

Spring Pin Bushing

Notes:

International continued

11060



Spring Pin Bushing
Front

OD	1 13/16"
OD<	1"
LG	7"
HD	80A

OEM
503611C1
503611C2
B1363-59
RB161
TB68
327-306
RB-161
TB-68
M16884
M5212

Notes: additional tool suggestion 40090

11080



Torque Rod Assy

LG ²	8 1/16"
C-C	24"
BC-C	4 3/8"
BH	5/8"
HD	80A

INCLUDES
QTY 1 11754
QTY 1 13520
QTY 1 13518

OEM
3581270C1
945381
TR59-41376

Notes:

11083



Spring Pin Bushing

OD	2 1/2"
LG	7 7/16"
C-C	5 11/16"
BH	7/8"
HD	80A

OEM
358115C1
RB205
RB268
E-8804
RB-157-OS
RB-205
RB-268
MR782
PB46-26268
UB20500-OS

TOOL 11069

Notes: anti walk design

11556



Torque Rod Bushing

OD	2 11/16"
C-C	4 3/8"
BH	5/8"
HD	80A

OEM
3249322R1
M2069

Notes: verify dimensions compare to 13522 and 83522

11611



Shifter Bushing Kit

OD	1 1/2"
ID	13/16"
LG	2 5/16"
BH	3/4"
HD	90A

OEM
FULK3399
MS99-63399

Notes:

11705



Cab Mount

OD	3"
OD<	1 13/16"
ID	5/8"
LG	2 3/8"
HD	80A

OEM
476869C1
35-1363PU
35-564PU
R307462
UM1196
E-7462
D36
D5
D51
329-147U

Notes: used in multiple applications

11716



Torque Rod Bushing

OD	5 7/16"
OD<	4 7/8"
ID	4 3/16"
LG	4 3/8"
HD	80A - 72D

OEM
698468R92

Notes:

11729



Torque Rod Bushing

OD	2 3/4"
C-C	4 3/8"
BH	11/16"
HD	80A

INCLUDED IN:
11773, 11793, 12074,
13634, 31095

TOOLS 18551, 18833

OEM
836940
R3010303
836940
KB920
CS70815
839310
E10303
E-10303
321-369
TS59-22400

Notes: high articulation bushing

11739



Torque Rod Bushing

OD	4	1/4"	~
OD<	3	1/2"	~
ID	2	9/16"	~
LG	4	3/16"	~
HD	80A		

OEM
1515966C1
R307426
R307766
CHA54
CHA54UB
E-7426
E-7766
D186
321-276
321-276U

Notes: 16 per suspension / longer life single piece design

11747



Rebound Roller Kit

OD	2	1/2"	~
ID		9/16"	~
LG	3	5/8"	~
HD	80A		

INCLUDES
QTY 1 Roller
QTY 1 Bolt
QTY 2 Flat Washer
QTY 1 Metal Sleeve
QTY 1 Lock Nut

OEM
1622375C1
3514950C1

Notes: components not sold separately

11751



Torque Rod Assy

C-C	24	"	~
B C-C	4	3/8"	~
HD	80A		

INCLUDES
QTY 1 11754
QTY 2 13520

OEM
1661925C91
A13102146A
6813262065
68-13262-065
62000-610
944270
K195-375
25164946
17QF460P240
1RY39307P13

Notes:

11758



Spring Pin Bushing

OD	1	3/4"	~
C-C	5	3/4"	~
HD	80A		

INCLUDED IN:
11757

OEM
1697129C91
50-275
TB68
327-434
50-275
TB-68
M5212
SP59-11010

TOOL 40090

Notes:

12031



Torque Rod Bushing

OD	2	3/4"	~
LG	7		~
THR	1 1/4"	12 UNF	~
HD	80A		

INCLUDED IN:
12042, 12072

OEM
1693064C1
R302815
R309518
C884
E-2815
E-9518
D293
D293S
321-136
321-136U

Notes:

12044



Torque Rod Assy Weldable

C-C	26	"	~
BC-C	4	3/8"	~
BH		5/8"	~

INCLUDES
QTY 1 13590
QTY 2 13520

OEM
1693537C1
MR661
UR661
E-2642

Notes: universal torque rod

12054



Torque Rod

ID	2	3/4"	~
C-C	18	1/8"	~

OEM

Notes:

12074



Torque Rod Assy

C-C	23	3/4"	~
BC-C	4	3/8"	~
BH		11/16"	~

INCLUDES
QTY 2 11729

OEM
1516350C91
1516350C92
924970
942119
943790
945240
TR62-41238

Notes:

International continued

12329



Sway Bar Bushing

OD	1 5/32"
ID	17/32"
LG	7/16"
HD	80A

OEM
16005305
501535C2
R303795

Notes:

12396



Torque Rod Assy

C-C	17 5/16"
BC-C	4 3/8"
BH	5/8"

INCLUDES
QTY 2 13520

OEM
HD62010455
HUD62010455
ZAK62010455
ZJF62010455
TR50-42455

Notes:

13500



Center Bushing

OD	3 5/8"
OD<	2 3/4"
LG	12"
HD	80A

INCLUDED IN:
13503, 13504, 13591

OEM
965080R1
M1978
R301338
R309520
20-816
C864
E-1338
E-9520
D403
321-117

TOOLS 18543, 18544

Notes: welded plug

13501



Beam End Bushing

OD	4 3/8"
ID	2 1/2"
LG	5 1/4"
HD	80A

INCLUDED IN:
13503, 13504

OEM
124865R1
20-809PU
R301340
R309511
C865
C865UB
E-1340
E-9511
D404
D404

TOOLS 13564, 18541, 18542

Notes: for complete repair use adapter 13502 / additional tool suggestion 13588

13502



Beam End Adapter

OD	3 1/2"
OD<	2 1/2"
LG	8"

INCLUDED IN:
13504

OEM
496529C91
20-802
R302372
HAK34
E-2372
334-108
M2010
HAK92
AK34100

Notes: used with 13501 and 13503

13504



Beam Bushing Kit

INCLUDES
QTY 4 13502
QTY 2 13500
QTY 4 13501

OEM
HCK340LP
R302862
SK80340

Notes:

13505



Center Bushing

OD	4 3/4"
OD<	3 1/2"
LG	12"
HD	80A

INCLUDED IN:
13508, 13548, 13587

OEM
124901R91
20-817
R301339
R306979
R309359
C863
C877
C887
E-1339
E-6979

TOOLS 13570, 18539, 18540

Notes: standard-welded plug / double bonded-welded plug - 13636 / standard-loose plug - 13543

13514



Torque Rod Bushing

OD	3"
ID	1 1/8"
LG	3 1/4"
HD	80A

TOOLS 13585, 18831

OEM
322069C91
20-850
R302238
C870
E-2238
D316
321-141
321-141U
M2068
09-5519

Notes: additional tool suggestion 13585

International continued

13515



Torque Rod Bushing

OD	3	~
C-C	5 11/16	~
BH	13/16	~
HD	80A	

TOOL 18831

OEM
438506C1
438506C91
20-885
R303411
RBT207
E-3411
D312
321-144
321-144U
M-3262

Notes: additional tool suggestion 13585

13516



Torque Rod Bushing

OD	2 3/4	~
ID	1 1/8	~
LG	3 1/4	~
HD	80A	

TOOL 18833

OEM
1693069C1
20-876
R302816
C881
E-13967
E-2816
321-137
M2088
09-5716
TRB6181

INCLUDED IN:
13688, 13698, 13699

Notes: additional tool suggestions 18551, coming soon 40131

13517



Torque Rod Bushing

OD	2 3/4	~
C-C	5 11/16	~
BH	13/16	~
HD	80A	

TOOL 18833

OEM
1693070C1
384191C91
20-834
R302814
R309517
C880
E-13964
E-2814
E-9517
D406

INCLUDED IN:
13687

Notes: additional tool suggestions 18551, coming soon 40131

13518



Torque Rod Bushing

OD	2 3/4	~
LG	8 1/16	~
THR	1 1/2 - 12 UNF	~
HD	80A	

TOOLS 13584, 18833

OEM
1693066C1
20-831PU
R302228
R308651
C883
C883UB
E-2228
E-8651
D422
321-133

INCLUDED IN:
11794, 11808, 13657, 13679,
13686, 13694, 13695, 34555

Notes: metal sleeve/ 13533 - no sleeve / additional tool suggestion 18551, coming soon 40131

13520



Torque Rod Bushing

OD	2 3/4	~
C-C	4 3/8	~
BH	5/8	~
HD	80A	

TOOLS 18551, 18833

OEM
1693061C1
E-4664
20-833PU
R302226
R307639
C879
C879UB
E-2226
E-7639
D423

INCLUDED IN:
Several Kits

Notes: 83520 - easy mount / 13536 - no metal sleeve

13521



Torque Rod Bushing

OD	2 1/16	~
LG	6 5/8	~
C-C	4 3/8	~
BH	5/8	~
HD	80A	

TOOLS 11071, 18836

OEM
ZJF47691L
20-836PU
R305275
HS44
E-5275
D405
321-223
321-223U
TRB6185
TRB6185UB

INCLUDED IN:
11153, 11792, 11795, 12397,
34563

Notes: chamfered / 11004 - rib style / 11006 - oversized / 12051 - grooved for torque rod with a center rib

13522



Torque Rod Bushing

OD	2 17/32	~
C-C	4 3/8	~
BH	5/8	~
HD	80A	

TOOLS 18553, 18833

OEM
1693060C1
3249322R1
20-832PU
R302225
R307638
C878
C878UB
FL55
E-2225
E-7638

Notes: metal sleeve / easy mount - 83522 / no sleeve - 11003 / additional tool suggestion coming soon 40131

13528



Torque Rod Bushing

OD	2 3/4	~
C-C	4 3/8	~
BH	3/4	~
HD	80A	

TOOLS 18833, 18551

OEM
1693063C1
20-851PU
R303868
C889
E-3868
D424
321-265
321-265U
TRB6822
TRB6822UB

INCLUDED IN:
12395, 13701, 13702, 13703

Notes: additional tool suggestion coming soon 40131

International continued

13533



Torque Rod Bushing

OD	2 15/16"
LG	8 1/16"
THR	1 1/4" - 12 UNF
HD	80A

TOOL 18831

OEM
1693066C1
20-831PU
R302228
E-2228
D422
M2072
09-5721
TRB6112
TT38000

Notes: 13518 - metal sleeve

13534



Center Bushing

OD	4 3/4"
ID	2 1/2"
LG	12"
HD	Bronze

INCLUDED IN:
13558, 13662

OEM
893059R92
20-860
R301546
HBK38
E-1546
322-102
322-102A
08-6301
HBK100

Notes: additional tool suggestions 13570, 18539, 18540

13536



Torque Rod Bushing

OD	2 15/16"
C-C	4 3/8"
BH	5/8"
HD	80A

TOOL 18831

OEM
1693061C1
E-4664
20-833PU
R302226
R307639
C879UB
E-2226
E-7639
D423
321-132U

Notes: 83520 - easy mount / 13520 - metal sleeve

13542



Wear Shims

OD	7"
ID	2 5/16"
THK	5/16"
HD	72D

INCLUDED IN:
13510, 13600

OEM
258892C91
R306122
HT212
E-6122
334-898
09-6241
M14712

Notes:

13545



Beam End Bushing

OD	6"
ID	3"
LG	6"
HD	80A

INCLUDED IN:
13586

TOOL 13569

OEM
233432R91
20-813
R302554
C872
E-2554
321-129
09-5471
M1990HE
EB50000

Notes: for complete repair use 13547

13547



Beam End Adapter

OD	3"
ID	2"
LG	9 3/4"
HD	Steel

INCLUDED IN:
13586

OEM
593717C91
20-806
R302555
HAK50
E-2555
334-138
09-5472
HAK124
AK50100

Notes: for use with 13545

13553



Beam End Bushing

OD	4 3/8"
ID	2 1/2"
LG	5 3/4"
HD	80A

INCLUDED IN:
13587

TOOLS 13563, 13588

OEM
124892R1
441302C92
20-810PU
R301341A
R302771
C862
C862UB
C871
E-1341A
E-2771

Notes: uncrimped sleeve double bonded bushing / supersedes 13506 / use adapter 13507 for complete repair / additional tool suggestion 13595

13577



Equalizer Bushing

OD	2 1/2"
ID	1"
LG	4 3/4"
HD	80A

OEM
497501C2
30-1302
R303784
IH5
E-3784
D437
321-195
321-195U
M3478
09-6851

Notes: metal sleeve / verify dimensions compare to 13513 - metal sleeve or 10028 - no sleeve

International continued

13582

OD	2 1/16"
LG	8 1/16"
HD	80A

OEM
TSHS73
HS73
E-10309
321-360
TT50-22697



Torque Rod Bushing

Notes: additional tool suggestion 11071, 18836

13592

OD	4 1/8"
ID	2"
LG	4"
HD	80A

OEM
868789R91
R301940
R309515
C874
C874UB
E-1940
E-9515
D107
321-125
321-125U



Vertical Drive Bushing

Notes:

13601

C-C	6 7/8"
C-C²	5 5/8"
HGT	5 1/2"
HD	80A

INCLUDED IN:
13721, 13722

OEM
2506180C91
ZAK60879L
2501596C1
E-11496
LP50-24000
SK80268
HS56
HS10000
E-9410
D2003



Bolster Spring

Notes: 4 per truck / recommended to replace set in same repair / don't mix brands / see tech tip 01 577 9038

13607

OD	4 3/8"
BH	1 1/16"
HD	80A

OEM
1697717
1697717C91
20-861
R309325
BP-87
E-9325
334-830
334-830U
09-5524
09-5528



Beam End Bushing Kit

TOOL 13595

Notes: double bounded / straight sleeve / wider inner pin no shims required/ for options requiring shims standard - 13596 or easy mount - 83596

13609

OD	3 1/2"
OD<	1 1/8"
LG	8 11/16"
HD	Steel

INCLUDED IN:
13566

OEM
90001002
537372C91
20-801
R309420
HAK44
E-9420
334-127
334-467
09-5462
HAK112



Beam End Adapter Kit

Notes: supersedes 13540 / for use with 13506

13610

OD	3 1/2"
OD<	2 1/2"
LG	9 3/16"
HD	Steel

INCLUDED IN:
13562

OEM
1611872C91
484891C91
AK50-45000
20-803
20-805
R309421
HAK45
E-9421
334-1123
334-126



Beam End Adapter Kit

Notes: use with 13560

13626

BC-C	4 3/4"
THR	1/2"
HD	80A

OEM
HD64179037
E-14374
334-1727
MLC3
HS130
E-14044
334-1845
MLC5
LP50-24179



Bolster Spring Kit

Notes: 4 kits per truck / recommended to replace set in same repair / don't mix brands

13629

ID	2 3/4"
C-C	22"

INCLUDED IN:
13634, 13657

OEM



Torque Rod

Notes:

International continued

13649



Overload Cushion

OD	7	--
ID	1	--
LG	4	--
HD	80A	

OEM
759832C1
20-823
R302232
R309514
LC4
LC4UB
E-2232
E-9514
D134
325-100

Notes:

13650



Load Pad

OD	6 3/4	--
ID	3 15/16	--
ID<	3 1/8	--
THK	4 1/16	--
LG	11 15/16	--
HD	80A	

OEM
427893R1
42984R1
20-824
20-826PU
R301598A
R301960
R309513
LC1
LC1UB
LC3

Notes:

13656



Center Bushing

OD	3 5/8	--
OD<	2 3/4	--
ID	2	--
LG	12	--
HD	80A	

OEM
1672608C1
E-9359
C2000

Notes:

13683



Torque Rod End Assy
Tube End

LG	8 9/16	--
BC-C	4 3/8	--
BH	5/8	--
HD	80A	

INCLUDES
QTY 1 13520
QTY 1 13681

OEM
1693531C1
E-10310
R301024
R3010310
R302639
MR610
UR610
E-2639
345-610
345-741

Notes:

13684



Torque Rod Bushing

OD	2 3/4	--
LG	6 5/8	--
THR	1 1/2 - UNF	--
HD	80A	

INCLUDED IN:
13692, 13693

TOOLS 13584, 18833

OEM
1693065C1
44809
44809-000
57750230
09-5720
321-134
C885
E-2227
M2071
R302227

Notes: additional tool suggestions 18551, coming soon 40131

13685



Torque Rod Bushing

OD	2 3/4	--
C-C	4 3/8	--
BH	7/8	--
HD	80A	

INCLUDED IN:
13689, 13700, 13704

TOOLS 18851, 18833

OEM
1694129C1
321-267
TS38875

Notes: additional tool suggestion coming soon 40131

13686



Torque Rod End Assy
Tube End

LG	8 9/16	--
LG²	8 1/16	--
THR	1 1/2 - 12 UNF	--
HD	80A	

INCLUDES
QTY 1 13681
QTY 1 13518

OEM
1693533C1
MR630
UR630
E-2638
345-620
345-630
345-738
928630
09-5422
TMRU620

Notes:

13690



Torque Rod End Assy
35" Rod End

LG	33 7/16	--
BC-C	4 3/8	--
BH	5/8	--
HD	80A	

INCLUDES
QTY 1 13707
QTY 1 13520

OEM
1691033C91
20-9034
MR660
345-660
09-5431
TMR660
TR75000

Notes:

13691

LG	25	7/16"
BC-C	4	3/8"
BH		5/8"
HD	80A	

INCLUDES
QTY 1 13682
QTY 1 13520

OEM
1693536C1
1693537C1
R3010315
R302642
MR660
MR661
UR660
UR661
E-2642
345-660



Torque Rod End Assy
27" Rod End

Notes:

13692

LG	33	7/16"
LG ²	6	5/8"
THR	1 1/4"	12 UNF
HD	80A	

INCLUDES
QTY 1 13707
QTY 1 13684

OEM
1691035C91
20-9031
MR670
345-670
09-5432
TMR670
TR81000



Torque Rod End Assy
35" Rod End

Notes:

13694

LG	33	7/16"
LG ²	8	1/16"
THR	1 1/4"	12 UNF
HD	80A	

INCLUDES
QTY 1 13707
QTY 1 13518

OEM
1693542C1
20-9033
MR680
UR680
E-2643
345-680
928680
09-5433
TMR680
TR76000



Torque Rod End Assy
35" Rod End

Notes:

13695

LG	25	7/16"
LG ²	8	1/16"
THR	1 1/4"	12 UNF
HD	80A	

INCLUDES
QTY 1 13682
QTY 1 13518

OEM
1693543C1
20-9023
MR681
UR681
E-10317
345-681
928681
09-5426
TMR681
TR76000



Torque Rod End Assy
27" Rod End

Notes:

13696

LG	33	7/16"
LG ²	7	
THR	1 1/4"	12 UNF
HD	80A	

INCLUDES
QTY 1 13707
QTY 1 12031

OEM
1693544C1
20-9032
MR690
UR690
345-690
928690
09-5435
TMR690
TR77000



Torque Rod End Assy
35" Rod End

Notes:

13697

LG	25	7/16"
LG ²	7	
THR	1 1/4"	12 UNF
HD	80A	

INCLUDES
QTY 1 13682
QTY 1 12031

OEM
1693545C1
20-9022
R302812
MR691
UR691
E-2812
345-691
928691
09-5429
TMR691



Torque Rod End Assy
27" Rod End

Notes:

13698

ID	1	1/8"
LG	34	7/16"
LG ²	3	1/4"
HD	80A	

INCLUDES
QTY 1 13708
QTY 1 13516

OEM
1693546C1
MR700
345-700
20-9036
928700
09-5434
TMR700
TR85000



Torque Rod End Assy
36" Rod End

Notes:

13699

ID	1	1/8"
LG	25	7/16"
LG ²	3	1/4"
HD	80A	

INCLUDES
QTY 1 13682
QTY 1 13516

OEM
1693535C1
MR701
345-701
20-9026
E-10319
928701
09-5430
TMR701
TR85000



Torque Rod End Assy
27" Rod End

Notes:

International continued

13700

LG	8	9/16"
BC-C	4	3/8"
BH		7/8"
HD	80A	

INCLUDES
 QTY 1 13681
 QTY 1 13685

OEM
 MR766
 E-11784
 345-612
 942690
 TR83000



**Torque Rod End Assy
Tube End**

Notes:

13701

LG	8	9/16"
BC-C	4	3/8"
BH		3/4"
HD	80A	

INCLUDES
 QTY 1 13681
 QTY 1 13528

OEM
1693550C1
 20-9017
 MR767
 E-11748
 345-794
 09-5807
 TR74000



**Torque Rod End Assy
Tube End**

Notes:

13703

LG	25	7/16"
B-C-C	4	3/8"
BH		3/4"
HD	80A	

INCLUDES
 QTY 1 13682
 QTY 1 13528

OEM
1693559C1
 345-794
 928665
 90-5813
 TR78000



**Torque Rod End Assy
27" Rod End**

Notes:

13721

INCLUDES
 QTY 2 13601
 QTY 16 Bolts 7/16" x 1 1/4" UNF
 QTY 16 Lock Nuts 7/16" UNF
 QTY 32 Flat Washer 7/16"

OEM
2506180C91
ZAK60879L
 E-11496
 LP50-24000
 HS56
 HS10000
 R3011496
 R309410
 E-9410
 D2003



Bolster Spring Pair

Notes: 2 per truck / recommended to replace set in same repair / don't mix brands / see tech tip 01 577 9038

13722

INCLUDES
 QTY 2 13601
 QTY 1 13611
 QTY 16 Bolts 7/16" x 1 1/4" UNF
 QTY 16 Lock Nuts 7/16" UNF
 QTY 32 Flat Washer 7/16"

OEM
ZAK60879L
 2506180C91
 E-11496
 LP50-24000
 HS56
 HS10000
 R3011496
 R309410
 HS99
 E-14047



Bolster Spring Kit

Notes: 2 kits per truck / recommended to replace set in same repair / don't mix brands / see tech tip 01 577 9038

13733

C-C	14	3/8"
BC-C	4	3/8"
BH		5/8"
THR	1 1/2"	12UNF

INCLUDES
 QTY 1 13520
 QTY 1 13518

OEM
HD62350615
HUD62350615
ZAK62350615
ZJF62350615
 TR50-41615



Torque Rod Assy

Notes:

13735

C-C	14	3/8"
BC-C	4	3/8"
BH		5/8"

INCLUDES
 QTY 2 13520

OEM
48411006
50376001
62007365
32271-102
 E-9394
 E-9409
 345-734
 345-792
 345-815
 TR50-41102



Torque Rod Assy

Notes:

14504

OD	2	3/8"
ID	1	1/4"
LG	5	
HD	80A	

OEM
590162C1
 60-1540PU
 N109
 E-2940
 E-8677
 D240
 325-235U
 M2118
 09-4410
 TRB5721



Beam End Bushing

Notes:

International continued

14513



Beam End Bushing

OD	3 1/2"
ID	1 1/8"
LG	5 1/4"
HD	80A

OEM
2507714C1
WC10050
60-1535
R304382A
N120
N120UB
E-4382A
E-8683
D441
321-229

Notes: additional tool suggestion 14531

14527



Center Bushing

OD	3 7/8"
ID	2 1/2"
LG	5 3/4"
HD	80A

OEM
790337C1
60-1531PU
R304253
R308681
N112
N112UB
E-4253
E-8681
D237
321-237

Notes:

14533



Beam End Bushing

OD	2 13/16"
ID	1 1/8"
LG	5"
HD	80A

OEM
90008149
2507718C1
60-1501
R304410A
N124
E-4410A
D448
321-231
321-231U
M3454

Notes: supersedes 14528 / additional tool suggestion 14531

15001



Equalizer Bushing

OD	3 1/8"
ID	1 1/2"
LG	4 1/2"
HD	80A

OEM
1607727C1
55-152PU
R301966
R303977
R308654
R209
E-3977
E-8654
D069
D69

Notes: supersedes 15021

15008



Torque Rod Bushing

OD	3 1/8"
OD<	1 13/16"
ID	1 1/16"
LG	2 13/16"
HD	80A

INCLUDED IN:
15061

OEM
513267C1
55-128PU
R150UB
E-7521
E-812
D72
321-158
321-158U
M1846
TRB6002

Notes: verify dimensions compare to 15020 - inner Sleeve

15013



Torque Rod Bushing

OD	1 15/16"
ID	7/8"
LG	3"
HD	80A

INCLUDED IN:
15063

OEM
34734C1
55-129
55-129PU
R301980
R307520
R129
R129UB
E-1061
E-1980
E-7520

Notes: additional tool suggestions 18836, coming soon 40124

15060



Suspension Bushing Kit

OD	6 5/16"
ID	1 1/4"
LG	4 1/2"
HD	80A

INCLUDES
QTY 1 Bolt 3/4"-14UNF x 7 1/2"
QTY 1 Lock Nut 3/4"-14UNF
QTY 2 Flat Washers
QTY 1 Sleeve

OEM

Notes: compatible with Reyco Air-Ride - Dock master

15061



Torque Rod Bushing Kit

INCLUDES
QTY 2 15008
QTY 1 Bolt 1"-14 x 7 1/2" G8
QTY 1 Lock Nut 1"-14UNF
QTY 2 Flat Washer 3/4"

OEM
TSR234
55-146
R309350
R234
E9350
334-896
09-228202
TRK6002
TH83-37640

Notes:

International continued

17257

OD	3 7/16"	OEM
LG	2 3/8"	
HD	80A	



Motor Mount
Front

Notes:

17272

OD	1 3/8"	OEM
ID	7/16"	
LG	3 5/16"	
THR	1/2" - 20 UNF	
HD	80A	



Stabilizer Bar Bushing

Notes:

17273

OD	1 11/16"	OEM
ID	7/16"	
LG	5 3/8"	
HD	80A	



Stabilizer Bar Bushing

Notes:

17501

OD	1 7/8"	OEM
ID	1 1/2"	
LG	1 3/16"	
HD	71D	



Camshaft Bushing

Notes:

17506

OD	2 1/16"	OEM
ID	3/4"	
THK	7/16"	
HD	90A	



Coupling

Notes: for fuel pump

18063

OD	1 5/8"	OEM
OD<	13/16"	
ID	1/2"	
LG	3/4"	
HD	80A	



Radiator Mount

Notes:

18103

THK	1 13/16"	OEM
WD	2"	
LG	6 1/4"	
THR	1/2" - 20 UNF	
HD	80A	



Cab Mount

Notes: compatible with old International cab over

18215

OD	2"	OEM
ID	1 1/8"	
LG	4 1/4"	
HD	80A	



Fifth Wheel Bushing

Notes: no groove / verify dimensions compare to 18094

18221



Fifth Wheel Bushing

OD	3 1/2"	OEM SAFXB0009 KP116
ID	1 1/4"	
LG	3 3/4"	
HD	80-71A	

Notes:

18566



Shock Absorber Bushing

OD	1 7/8"	OEM 401754 40-340 R307529 HB593 SB1UB E-7529 D1 320-153 320-153U M695
ID	1"	
LG	1"	
HD	80A	

Notes:

19001



Spring Bushing Kit

OD	1 1/2"	OEM 471226C1 53099V 1671766C1 1680033C1 1664223C1 RNG-OGB RNG-BM OGB-RNG B1442-55
ID	1"	
LG	3"	
HD	90A	

Notes: components not sold separately

30500



Motor Mount Rear

ID	1"	OEM
THK	4 5/16"	
WD	2 15/16"	
LG	4 3/16"	
HD	80A	

Notes:

30503



Motor Mount Rear

ID	15/16"	OEM
WD	4 7/16"	
LG	6 7/16"	
HGT	2 7/16"	
HD	80A	

Notes:

30505



Torque Rod Bushing

OD	2 13/16"	OEM
OD<	1 13/16"	
ID	1 1/8"	
LG	1 9/16"	
HD	80A	

Notes:

30506



Torque Rod Bushing

OD	2 13/16"	OEM
OD<	1 15/16"	
ID	1 3/16"	
LG	1 9/16"	
HD	80A	

Notes:

30507



Shock Absorber Bushing

OD	1 15/16"	OEM 1T18197A 2350908 2350908U 12-5-123 12-5-123A SB03-83008
ID	1"	
LG	1 15/16"	
HD	80A	

Notes: verify dimensions compare to 15011 or 15019

International continued

30508



THK 2 7/8 -
WD 2 5/8 -
LG 4 7/16 -
THR 3/4 -24 UNF -
HD 70A

OEM

Load Pad

Notes:

30509



OD 2 7/16 -
ID 1 -
LG 1 -
HD 80A

OEM

Motor Mount
Rear (Upper)

Notes:

30510



OD 2 7/16 -
ID 3/4 -
LG 1 -
HD 80A

OEM

Motor Mount
Rear (Upper)

Notes:

30511



WD 1 3/4 -
LG 4 -
THR 1/2 -20 UNF -
HGT 2 1/2 -
HD 80A

OEM

Compressor Mount

Notes:

30513



OD 2 -
ID 1/2 -
LG 9/16 -
HD 80A

OEM

Radiator Mount

Notes:

30515



THK 4 1/16 -
WD 2 7/16 -
LG 6 1/16 -
HD 80A

OEM

Suspension Mount

Notes:

30516



ID 1 -
WD 5 15/16 -
LG 6 3/4 -
HGT 4 1/16 -
HD 70A

OEM
08-18-1008

Motor Mount
Rear

Notes:

30517



ID 11/16 -
WD 3 3/4 -
LG 6 1/4 -
HGT 1 3/4 -
HD 80A

OEM
AZ-14840-06

Motor Mount
Front (Lower)

Notes:

International continued

30518



Motor Mount
Front (Upper)

OD	2 7/16"	OEM
ID	1 1/16"	
LG	1 7/16"	
HD	70A	

Notes:

30520



Radiator Mount

OD	2"	OEM
ID	5/8"	
LG	9/16"	
HD	70A	

Notes:

30522



Shock Absorber Bushing

OD	1 7/16"	OEM
ID	3/4"	
LG	1 9/16"	
HD	80A	

Notes:

30539



Shock Absorber Bushing

OD	1 15/16"	OEM
ID	3/4"	
LG	15/16"	
HD	80A	

Notes:

30544

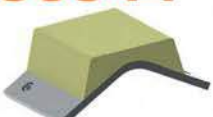

Spring Pad

THK	2 1/16"	OEM
WD	2 1/2"	
LG	5 9/16"	
HD	80A	
		IH14
		334-747
		MIH52

Notes:

30557



Shock Absorber Bushing

OD	1 13/16"	OEM
ID	1"	
LG	2"	
HD	80A	

Notes:

31524



Exhaust Mount

OD	2 3/16"	OEM
LG	3 1/8"	
THR	10 mm - P1.25	
HD	70A	

Notes:

31539



Fan Hood Mount

OD	1 13/16"	OEM
ID	1/2"	
LG	1 9/16"	
HD	80A	

Notes:

International continued

31546



OD	2 1/2"
ID	1 5/8"
LG	1"
HD	90A

OEM

Stabilizer Bar Bushing

Notes:

31547



OD	2 1/16"
ID	1 1/4"
LG	1 7/16"
HD	90A

OEM

Stabilizer Bar Bushing

Notes:

31548



OD	2 5/16"
ID	1 5/16"
LG	3 5/16"
HD	80A

OEM

Stabilizer Bar Bushing

Notes:

31551



OD	1 5/16"
ID	1/2"
LG	1 1/8"
HD	80A

OEM

Bushing Kit

Notes: components not sold separately

31552



OD	1 1/2"
LG	2 7/8"
THR	10 mm - P1.5
HD	80A

OEM

Radiator Mount

Notes:

31553



OD	1 3/4"
ID	1 3/16"
LG	1 15/16"
HD	80A

OEM

Stabilizer Bar Bushing

Notes:

31554



OD	2 1/8"
ID	1 3/16"
LG	1 9/16"
HD	80A

OEM

Spring Bushing

Notes:

31556



OD	4 3/8"
ID	2"
THK	1"
HD	80A

OEM

Bearing Washer

Notes:

International continued

31560



Alternator Bushing

OD	1	-
ID	1/2	-
LG	1 5/8	-
HD	80A	

OEM

Notes:

31561



Shifter Linkage Bushing

OD	1 1/2	-
ID	1 3/16	-
LG	13/16	-
HD	71D	

OEM

Notes:

31564



Stabilizer Bar Bushing

OD	1 5/8	-
ID	1/2	-
LG	1 15/16	-
HD	80A	

OEM

Notes:

31565



Stabilizer Bar Bushing

OD	2 5/16	-
ID	9/16	-
LG	3/4	-
HD	80A	

OEM

Notes:

31567



Stabilizer Bar Bushing

OD	1 3/8	-
ID	7/16	-
LG	15/16	-
HD	80A	

OEM

Notes:

31570



Stabilizer Bar Bushing

OD	2 11/16	-
ID	1 9/16	-
LG	3 3/16	-
HD	80A	

OEM

Notes:

31581



Shock Absorber Bushing

OD	1 13/16	-
ID	9/16	-
LG	7/8	-
HD	80A	

OEM

Notes:

31583



Stabilizer Bar Bushing

ID	2 1/16	-
WD	2 3/8	-
HGT	3 1/8	-
HD	80A	

OEM

Notes:

International continued

31594



Stabilizer Bar Bushing

ID	1 5/8"	OEM
LG	2 3/8"	
HGT	2 5/8"	
HD	80A	

Notes:

31598



Wear Pad

WD	2 3/4"	OEM
LG	8 7/16"	
HGT	2 13/16"	
HD	71D	

Notes:

31604



Radiator Mount

THK	9/16"	OEM
WD	2 1/16"	
LG	8 1/16"	
BH	3/4"	
HD	80A	

OEM
471478C1
471478C2
M203021
RM55-638C2

Notes:

31609



Stabilizer Bar Bushing

ID	1 3/8"	OEM
LG	1 13/16"	
HGT	1 1/8"	
HD	80A	

Notes:

34500



Motor Mount Kit

THK	3 11/16"	OEM
WD	3 1/8"	
LG	5 1/2"	
BH	11/16"	
HD	80A	

OEM
1664728C1
1664728C2

INCLUDES
QTY 1 34507
QTY 1 34508

INCLUDED IN:
34524

Notes: all components not sold separately

34505



Motor Mount Front

THK	1 7/16"	OEM
WD	1 9/16"	
LG	5 1/16"	
C-C	1 3/4"	
BH	13/16"	
HD	80A	

OEM
286235C2
7807231C1
301-379PU
D309
329-187U

Notes:

34506



Motor Mount Front

THK	1 11/16"	OEM
WD	2 5/16"	
LG	6 5/16"	
C-C	1 3/4"	
BH	13/16"	
HD	80A	

OEM
286236C2
301-380PU
D310
329-188U

Notes:

34507



Motor Mount Upper

OD	3"	OEM
ID	5/8"	
THK	9/16"	
HD	80A	

INCLUDED IN:
34500

OEM
1664730C5
1664730C7
2014777C2
1664726C2
M17445
MM55-620C7
MM55-626C2

Notes:

34509



ID	11/16"	OEM 1664723C1 1664723C2 1664723C3 1664724C1 1664724C2 1664724C3 MM55-623C3 MM55-624C3
THK	2	
WD	4 3/16"	
LG	4 1/16"	
HD	80A	

INCLUDED IN:
34526

Motor Mount Front

Notes: components not sold separately

34510



WD	3 5/16"	OEM 1664730C5 1664730C7 2014777C2 1664729C1 1664729C2 1664729C3 1664729C4 1664729C5 1664729C7 M1744
LG	7	
BH	13/16"	
HGT	4 11/16"	
HD	80A	

INCLUDES
QTY 1 34507

INCLUDED IN:
34525

Motor Mount Kit Rear

Notes: all components not sold separately

34511



OD	1 27/32"	OEM 3525665C1 RB253 RB-253 SP55-52600
LD	4 1/4"	
HD	80A	

Spring Bushing

Notes:

34512



OD	2 11/16"	OEM
C-C	4 3/8"	
BH	5/8"	
HD	80A	

Torque Rod Bushing

TOOL 18836

Notes: flanged design / verify dimensions compare to 11003 or 13522 - metal sleeve

34515



OD<	3 3/8"	OEM 3515345C1 3515345C2 CM55-615C2
LG	3	
C-C	5	
BH	3/4"	
HD	70A	

Cab Mount

Notes:

34516



OD	2 7/8"	OEM 3574670C91 3574671C91 3574678C1 3574680C1 3589599C91 3844147C91
ID	1/2"	
LG	3 3/8"	
HD	70A	

INCLUDED IN:
34540

Cab Mount

TOOL 18937

Notes:

34519



OD	1 1/2"	OEM 47937C1
ID	3/4"	
LG	4	
HD	80A	

Spring Bushing Kit

TOOL 18936

Notes:

34521



WD	3	OEM 35542052
LG	5 1/8"	
C-C	2 3/16"	
HGT	4 9/16"	
HD	80A	

Auxiliary Load Spring

Notes:

International continued

34523



Spring Bushing

OD	1 1/2"
ID	3/4"
LG	4"
HD	80A

OEM
47937C1

Notes:

34524



Motor Mount Kit Rear

INCLUDES
 QTY 2 34500
 QTY 2 Bolt 3/4" x 4" G8
 QTY 2 Lock Nut 3/4"
 QTY 4 Flat Washers 3/4"

OEM
 1664728C1
 1664728C2

Notes:

34525



Motor Mount Kit Rear

INCLUDES
 QTY 2 34510
 QTY 2 Bolt 3/4" x 4" G8
 QTY 2 Lock Nut 3/4"
 QTY 4 Flat Washers 3/4"

OEM
 1664730C5
 1664730C7
 20147772C2
 1664729C1
 1664729C2
 1664729C3
 1664729C4
 1664729C5
 1664729C7
 M17445

Notes:

34526



Motor Mount Kit Front

INCLUDES
 QTY 2 34509
 QTY 2 Bolt 3/4" x 3 1/2" G8
 QTY 2 Lock Nut 3/4"
 QTY 4 Flat Washers 3/4"

OEM
 1664723C1
 1664723C2
 1664723C3
 MM55-624C3
 MM55-623C3

Notes:

34527



Torque Rod

ID	2 7/16"
C-C	14 1/2"

OEM

Notes: bushing options 11714 or 13618 / OE does not offer bushing / used with Kenworth and International with modified Hendrickson axles

34528



Cab Mount Kit

OD	3 3/8"
LG	3"
C-C	5"
BH	5/8"
HD	70A

OEM
 3512064C4
 CM55-614C4

Notes:

34529



Motor Mount Kit Rear

WD	4 3/4"
LG	4 7/16"
HGT	3 11/16"
HD	70A

OEM
 3549169C1
 3549169C2

Notes: bracket not included/ reuse original bracket for repair

34530



Hood Swivel Bushing

OD	1 1/2"
ID	3/8"
LG	2 3/16"
HD	70A-71D

OEM

Notes:

34532



Cab Mount Bushing

OD	1 3/16"	OEM
ID	1/2"	
LG	2 1/16"	
HD	70A	

Notes:

34534



Torque Rod Bushing

OD	2 17/32"	OEM
LG	8 1/16"	
THR	1 1/4" - 12 UNF"	
HD	80A	

Notes:

34536



Hood Guide

OD	2 7/16"	OEM
LG	1 11/16"	
THD	5/16" - 18 NC"	

Notes:

34537



Spring Bushing Kit

OD	1 1/2"	OEM 47937C1
ID	3/4"	
LG	4	
HD	80A	

Notes: components not sold separately

34540



Cab Mount Kit

OD	2 7/8"	OEM
ID	1/2"	
LG	3 3/8"	
HD	70A	

INCLUDES
 QTY 2 34516
 QTY 2 Bolt 1/2" x 5" G8
 QTY 2 Lock Nut 1/2"

3444147C91
 3574670C91
 3574671C91
 3589599C91
 3844147C91
 3574678C1
 3574680C1
 CM55-61454

TOOL 18937

Notes:

34545



Radiator Mount

OD	2 1/16"	OEM
ID	1/2"	
LG	1 1/8"	
HD	70A	

Notes:

34552



Cab Mount Bushing

OD	2 7/8"	OEM
ID	11/16"	
LG	3 5/16"	
HD	70A	

Notes:

34555



Torque Rod Assy

LG	8 1/4"	OEM
C-C	25 1/4"	
BC-C	4 3/8"	
BH	5/8"	
THR	1 1/4" - 12 UNF"	

INCLUDES
 QTY 1 13520
 QTY 1 13518

HD62350645
 HUD62350645
 ZAK62350645
 ZJF62350645
 TR50-41645

Notes:

International continued

34556

C-C	23	1/4"
BC-C	4	3/8"
BH		5/8"

INCLUDES
QTY 2 13520

OEM
HD62000590
HD62001590
HUD62000590
HUD62001590
ZAK62000590
ZAK62001590
ZJF62000590
ZJF62001590
924920
942174



Torque Rod Assy

Notes:

34563

C-C	25	3/8"
BC-C	4	7/16"
BH		5/8"

INCLUDES
QTY 2 13521

OEM
3548381C1
4C4Z4612AA
501565C2
IH22
E13989
345-866
TMR533
TR55-418C1



Torque Rod Assy

Notes:

40035

OD	3	7/8"
OD<	2	5/16"
ID	1	5/32"
LG	2	1/16"
HD	80A	

OEM
SAFXB10605
FW99-32605



Fifth Wheel Bushing Kit

Notes: components not sold separately

40074

ID	2	3/8"
C-C	8	1/2"
BH		1/2"
HGT	3	21/64"
HD	70A	

OEM
283071C93
CB2106611XSA
DS-6049



Carrier Bearing Assy

Notes: includes carrier bearing bushing 18002

40075

ID	2	
C-C	7	7/16"
BH		1/2"
HGT	2	25/32"
HD	70A	

OEM
2101211X
2591050C91
283069C93
DS-6048



Carrier Bearing Assy

Notes: includes carrier bearing bushing 18725

83520

OD	2	3/4"
C-C	4	3/8"
BH		5/8"
HD	80A	

OEM
1693061C1
E-4664
20-833PU
R302226
R307639
C879
C879UB
E-2226
E-7639
D423



Easy-Mount Torque Rod Bushing

TOOLS 18551, 18833

Notes: standard - 13520 / no metal sleeve - 13536

83522

OD	2	17/32"
C-C	4	3/8"
BH		5/8"
HD	80A	

OEM
1693060C1
3249322R1
20-832PU
R302225
R307638
C878
C878UB
FL55
E-2225
E-7638



Easy-Mount Torque Rod Bushing

TOOLS 18553, 18833

Notes: easy mount / metal sleeve - 13522 / no metal sleeve - 11003

83596

OD	4	3/8"
C-C	8	1/2"
BH	1	1/16"
HD	80A	

OEM
1691140C91
20-859
R309326
BP-87
BP-88
E-9326
334-831
09-5525
BP200



Easy-Mount Beam End Bushing

TOOL 18542, 13588

Notes: easy mount / standard - 13596 / no shims required - 13607

DESCRIPTION	OEM	PART ID	PAGE
Air Cooler Mount	M200 / M200-70EP / 35-568PU / 50-1440PU / R307448 / E-7448 / D15 / D325 / 329-149U / 329-162U / M13633 / M13633UB / PL1077	11554	147
Beam End Bushing	45900 / 20-810PU / R301341A / R302771 / C862 / C862UB / C871 / E-1341A / E-2771 / E-9512 / D402 / 321-126 / 321-126U / 321-242 / M1726 / 09-5511 / 09-5728 / M1970 / M1970UB / M1988 / EB38000	13553	155
Cab Mount		11519	145
Cab Mount	K066-228 / M601 / M601-70NR / 35-548PU / R307472 / UM1113 / E-7472 / D6 / 329-136U / M17412 / M17412UB / MM96-62401 / PL1015 / PL1015-HT	11520	145
Cab Mount	K066-228 / M601 / M601-70NR / 35-548PU / R307472 / UM1113 / E-7472 / D6 / 329-136U / M17412 / M17412UB / MM96-62401 / PL1015 / PL1015-HT	11523	145
Cab Mount		11527	145
Cab Mount		11529	145
Cab Mount		11531	145
Cab Mount	K174-225	11532	145
Cab Mount	K066-336 / M602-70NR / 35-558PU / R307473 / UM1112 / E-7473 / D30 / 329-135U / M17414 / M17414UB / PL1016	11533	145
Cab Mount	M500-70NR / 35-556PU / R307471 / UM1102 / E-7471 / D27 / 329-128U / M17410 / M17410UB / PL1063 / PL1063-HT	11612	148
Cab Mount	K066-176 / M600 / 35-1363PU / 35-564PU / R307462 / UM1196 / E-7462 / D36 / D5 / D51 / 329-147U / M17392UB / M17417 / M17417UB / PL1009 / PL1136	11705	149
Cab Mount	M501 / 35-569PU / R307506 / E-7506 / D326 / D4 / D540 / 329-144U / 329-163U / M17804UB / PL1070 / PL1070-HT / PL1105 / PL1105-HT	11707	149
Cab Mount	C13-1007	11742	150
Cab Mount	K066-435-3	18938	156
Cab Mount	26732-2	18949	156
Carrier Bearing Assy	210661-1X / CB210661XSA / DS-6049	40074	157
Carrier Bearing Assy	2101211X / DS-6048	40075	157
Center Bushing	K066-184 / R309440 / E-9440 / D150 / 325-160 / 325-160U / 09-7852 / TRB6808 / RS20210 / RS20216	19004	157
Easy-Mount Torque Rod Bushing	227720 / 20-833PU / R302226 / R307639 / C879 / C879UB / E-2226 / E-4664 / E-7639 / D423 / 321-132 / 321-132U / M2070 / 09-5723 / TRB6820 / TRB6820UB / TS38000	83520	157
Easy-Mount Torque Rod Bushing	227710 / 20-832PU / R302225 / R307638 / C878 / C878UB / FL55 / E-2225 / E-7638 / D421 / 321-131 / 321-131U / M2069 / TRB164 / TRB6164 / TS34000 / TS34095	83522	157
Equalizer Bushing		15004	155
Equalizer Bushing		15006	155
Exhaust Bushing	M13-1009	17283	156
Exhaust Bushing	M13-1011	17284	156
Fifth Wheel Bushing	K066-160 / R307451 / E-7451 / D89 / 329-123U / 329-124U / KP119 / KP119UB / PL1037	11515	144
Fuel Pedal Mount		11542	146
Grease Seal Retainer	K207-1085	11737	150
Hood Guide	K179-528 / K179D450 / K179-D450 / 35-555PU / R307467 / UM1104 / E-7467 / D26 / 329-129U / M17402 / M17402UB / M17527 / M17527UB / PL1011	11545	147
Hood Guide	K179-D481	11546	147
Hood Guide	K350-1887	11547	147
Hood Hinge Bushing	66D608 / K066-178 / J5950 / R307464 / E-7464 / D39 / 329-113U / M17333 / M17333UB / PL1068 / A80BL1009	11062	142
Hood Hinge Bushing		11557	148
Hood Hinge Bushing	K066-218 / M300-70NR / 35-553PU / R307466 / UM1194 / E-7466 / D24 / 329-145U / M3841 / M17400 / M17400UB / PL1010	11709	149
Hood Latch	K147-107 / K147C106 / HLK1000	11543	147

DESCRIPTION	OEM	PART ID	PAGE
Hood Latch	374-1295-60 / 379-9344 / HLK1015	11768	152
Hood Latch	L56-0001	12365	153
Hood Latch Assy	680-880-01-60 / HLK1024	11134	143
Motor Mount		11534	146
Motor Mount	K174-555 / K174B456 / 35-551PU / R307470 / UM1190 / E-7470 / D21 / 329-142U / M17408 / M17408UB / PL1014	11535	146
Motor Mount		11536	146
Motor Mount	K066-229 / M700 / 35-549PU / R307469 / UM1157 / E-7469 / D432 / D7 / 329-141U / 329-159U / 329-194U / M17406 / M17406UB / PL1013	11537	146
Motor Mount	K066-247 / K066-282 / K066-320 / M506-70NR / 35-552PU / 35-570PU / R307468 / UM1191 / E-7468 / D22 / D328 / 329-143U / M17404 / M17404UB / PL1012	11539	146
Motor Mount	K066-377 / K066-391 / D111 / KT59-62001	11540	146
Motor Mount	D1310011 / K066-421 / D114	11541	146
Motor Mount	K066-229 / M700 / 35-549PU / R307469 / UM1157 / E-7469 / D432 / D7 / 329-141U / 329-159U / 329-194U / M17406 / M17406UB / PL1013	11613	148
Motor Mount	K066-247 / K066-282 / K066-320 / M506-70NR / 35-552PU / 35-570PU / R307468 / UM1191 / E-7468 / D22 / D328 / 329-143U / 329-164U / M17404 / M17404UB / PL1012	11614	148
Motor Mount	K066-404 / K066-405 / K066-406 / K066-407 / K066-423 / D108 / D113 / KT59-62002 / KT59-62002-HT / MM59-62407	11615	149
Motor Mount	M501 / 50-1431PU / R307506 / UM1693 / E-7506 / D326 / 329-144U / M17804UB / PL1070	12355	153
Motor Mount Kit	D1310011 / K066-377 / K066-391 / K066-421 / D111 / D114 / KT59-62001 / KT59-62001-HW / MM59-62001	11760	151
Motor Mount Kit	K066-247 / K066-282 / K066-320 / M506-70NR / 35-552PU / 35-570PU / R307468 / UM1191 / E-7468 / D22 / D328 / 329-143U / M17404 / M17404UB / PL1012	11761	151
Motor Mount Kit	K066-385 / K066-404 / K066-406 / D108 / D113 / KT59-62002 / KT59-62002-HT / KT59-62002-HW / KT59-62003-HT / MM59-62407	11762	152
Radiator Mount		11548	147
Radiator Tie Rod Bushing	K264-84 / 35-562PU / R307640 / E-7640 / D34 / 329-120U / PL1065	11549	147
Shackle	K209-75 / 35-547 / E484-59 / 330-125 / M1214	11759	151
Shackle	K209-59 / E796-59 / 330-168 / M1838	18601	156
Shackle	K209-82 / K209-87 / 330-168	18602	156
Shifter Bushing Kit	FULK3399 / MS99-63399	11611	148
Shock Absorber Bushing	CA368-6 / COM266 / COM368-6 / K066-266 / 35-539PU / R307474 / SB3UB / E-7474 / D37 / 320-178 / 320-178U / 09-7160 / MH1433 / MH1433UB / PL1028	11550	150
Shock Absorber Bushing	COM266 / COM368-6 / K066-266 / R307474 / E-7474 / 320-178 / 320-178UB / MH1433 / MH1433UB / PL1028	18244	156
Shock Absorber Bushing	73D2002 / 40-340 / R307529 / HB593 / SB1UB / E-7529 / D1 / 320-153 / 320-153U / M695 / M-17526UB / MH1432 / MH1432UB / PL1026	18566	156
Spring Pin Bushing	5295 / K179-378 / B1363-59 / RB161 / TB68 / 327-306 / RB-161 / TB-68 / M16884 / M5212 / MR568 / MTB160 / SP59-11378 / UB16100	11060	142
Spring Pin Bushing	B65-1006 / B65-1017-001 / RB-295 / MR836 / MR836UB / SP59-11006	11753	151
Spring Pin Bushing	5295 / 5296 / B65-1001 / 50-275 / TB68 / 327-434 / 50-275 / TB-68 / M5212 / SP59-11010	11758	151
Spring Pin Bushing	B65-1007 / B65-1012 / RB308 / SP59-11007	11763	152
Spring Pin Bushing	50273AB / B65-6005 / RB328 / RB-328 / SP00-11005	11767	152
Spring Pin Bushing Kit	5295 / 5296 / B65-1005 / K209-75 / 35-547 / B1372-59 / E484-59 / TB68 / 327-434 / 330-125 / TB-68 / M1214 / M5212 / SK59-10000	11757	151
Stabilizer Bar Bushing	CA293 / K066-058 / K066-293 / K066-449 / 35-526PU / 35-572PU / R304669 / R307446A / KW3 / KW3UB / KW6UB / E-4669 / E-7446 / E-7446A / D35 / 320-150 / 320-150U / M3264 / M3838 / KB321 / KB321UB / PL1008 / PL1184	11502	143

DESCRIPTION	OEM	PART ID	PAGE
Stabilizer Bar Bushing	CA293 / K066-058 / K066-293 / K066-449 / 35-526PU / R304669 / R307446A / KW3 / KW3UB / KW6UB / E-4669 / E-7446 / E-7446A / D35 / D35OZ / 320-150 / 320-150U / M3264 / M3838 / KB321 / KB321UB / PL1008 / PL1184	11719	149
Stabilizer Bar Bushing	K066-461 / K066-502-2 / D86 / 320-203 / KB452 / KB452UB / SW59-29461	11734	150
Stabilizer Bar Bushing	C13-1005 / KW08849AC / 320-208	11743	150
Sway Bar Pin Kit	K066-461 / K066-502-2 / K179-531 / K207-1085 / K345-5156 / 35-574 / D86 / 320-203 / 334-1617 / KB452 / KB452UB / SW59-29461	11733	150
Sway Bar Repair Kit	K066-461 / K066-502-2 / K179-531 / K207-1085 / K345-5156 / 35-574 / D86 / 320-203 / 334-1617 / KB452 / KB452UB / SW59-29461	11766	152
Torque Rod		11754	151
Torque Rod Assy	925031 / K195-376 / 945381 / TR59-41376	11080	142
Torque Rod Assy	944270 / K195-375 / 925030 / TR59-41375	11751	151
Torque Rod Assy	K195-472 / K195-474 / TR59-41474	11773	152
Torque Rod Assy	C65-6002 / C65-6009 / 345-884 / 937530 / TR030020010 / R553 / TR00-41009	11792	153
Torque Rod Assy	C65-1008 / C65-1009 / R74 / R74B / TR59-41008	11793	153
Torque Rod Assy		11794	153
Torque Rod Assy	C65-6000-002 / C65-6011-002 / 345-883 / 937561 / R539 / TR00-41600	11795	153
Torque Rod Assy	46661 / MR661 / UR661 / E-2642	12044	153
Torque Rod Assy	C65-6000-001 / C65-6011-001 / 345-882 / 937560 / R537 / TR00-41001	12397	153
Torque Rod Assy	925150 / TR59-41150	13679	155
Torque Rod Assy	32271-102 / 48411-006 / 50376-001 / 62007-365 / E-9394 / E-9409 / 345-734 / 345-792 / 345-815 / TR50-41102	13735	155
Torque Rod Bushing	A80BL7691 / A16-119448 / 47691 / 47691000 / 47691 / 47691 / 20-836PU / R305275 / HS44 / E-5275 / 321-223 / 321-223U / TRB6185 / TRB6185UB / D405 / PL1146A	11004	142
Torque Rod Bushing		11503	143
Torque Rod Bushing		11505	143
Torque Rod Bushing		11506	143
Torque Rod Bushing		11507	143
Torque Rod Bushing		11509	144
Torque Rod Bushing		11510	144
Torque Rod Bushing	932420 / K195-415-13 / 35-505 / E-9324 / 321-335 / 321-335A / TRB6810	11511	144
Torque Rod Bushing	A-2297-K-1052 / A-2297-V-4806 / K066-259 / R309323 / E-9323 / D244 / 321-325 / 321-325U / 09-7241 / TRB6801 / TRB6801UB / RW53000	11512	144
Torque Rod Bushing		11513	144
Torque Rod Bushing	A-2297-K-1052 / A-2297-V-4806 / K066-259 / R309323 / E-9323 / D244 / 321-325 / 321-325U / 09-7241 / TRB6801 / TRB6801UB / RW53000	11514	144
Torque Rod Bushing	227710 / M2069	11556	148
Torque Rod Bushing		11560	148
Torque Rod Bushing		11561	148
Torque Rod Bushing		11715	149
Torque Rod Bushing	836940 / R3010303 / E10303 / E-10303 / 321-369 / TS59-22400	11729	150
Torque Rod Bushing	A-2297-K-1052 / A-2297-V-4806 / K066-259 / 35-501 / R309323 / E-9323 / D244 / 321-325 / 321-325A / 09-7241 / TRB6801 / TRB6801UB / RW53000	11735	150
Torque Rod Bushing		11741	150
Torque Rod Bushing	C13-6002 / K221-5086 / RB-292 / MR830 / SU00-29002	11764	152
Torque Rod Bushing	51879 / C13-6001 / RB-291 / MR828 / SU00-29001	11765	152
Torque Rod Bushing	224993 / 20-850 / R302238 / C870 / E-2238 / D316 / 321-141 / 321-141U / M2068 / 09-5519 / TRB6186 / TRB6186UB / IN35190	13514	154

DESCRIPTION	OEM	PART ID	PAGE
Torque Rod Bushing	224991 / 20-885 / R303411 / RBT207 / E-3411 / D312 / 321-144 / 321-144U / M-3262 / 09-5518 / TRB6260 / TRB6260UB / IN35180	13515	154
Torque Rod Bushing	229610 / 20-831PU / R302228 / R308651 / C883 / C883UB / E-2228 / E-8651 / D422 / 321-133 / 321-133U / M2072 / 09-5721 / TRB6112 / TRB6112UB / TT38000	13518	154
Torque Rod Bushing	227720 / 20-833PU / R302226 / R307639 / C879 / C879UB / E-2226 / E-4664 / E-7639 / D423 / 321-132 / 321-132U / M2070 / 09-5723 / TRB6820 / TRB6820UB / TS38000	13520	154
Torque Rod Bushing	20-836PU / A80BL7691 / ZJF47691L / 47691 / R305275 / 47691 / 47691 / 47691-000 / A16-119448 / HS44 / E-5275 / 321-223 / 321-223U / TRB6185 / TRB6185UB / PL1146 / TS50-22691 / D405	13521	154
Torque Rod Bushing	227710 / 20-832PU / R302225 / R307638 / C878 / C878UB / FL55 / E-2225 / E-7638 / D421 / 321-131 / 321-131U / M2069 / TRB164 / TRB6164UB / TS34000 / TS34095	13522	154
Torque Rod Bushing	227723 / 20-851PU / R303868 / C889 / E-3868 / D424 / 321-265 / 321-265U / TRB6822 / TRB6822UB / TS38750	13528	154
Torque Rod Bushing	229610 / 20-831PU / R302228 / E-2228 / D422 / M2072 / 09-5721 / TRB6112 / TT38000	13533	154
Torque Rod Bushing	227720 / 20-833PU / R302226 / R307639 / C879UB / E-2226 / E-4664 / E-7639 / D423 / 321-132U / M2070 / 09-5723 / TRB6820UB	13536	155
Torque Rod Bushing	E1HT5781EA / 47692 / 47692-000 / 13945-01 / 221394501 / 55-130 / R303362 / R305276 / R208 / E-3362 / E-5276 / 321-162 / 09-2497 / TRB6025 / TH50-22692	14010	155
Torque Rod Bushing		14014	155
Transmission Mount	K221-3941-08	11726	149
Trunnion Bushing	K066-184 / R309440 / E-9440 / D150 / 325-160 / 325-160U / 09-7852 / TRB6808 / RS20210	11500	143
Trunnion Bushing	K066-232 / K066-50 / 35-502 / R307492 / E-7492 / D154 / 325-222 / 325-222U / MKW14 / PL1038	11501	143
Trunnion Bushing		11518	144
Trunnion Bushing	K066-450 / K066-478 / KW28 / 35-572PU / R3010302 / E-10302 / D2001 / D2002 / 320-200 / 320-200A / 320-200U / KB450 / KB450UB / PL1147 / PL1150	11720	149

STEMCO GAFF replacement parts compatible with: KENWORTH® AIRGLIDE 100 SERIES

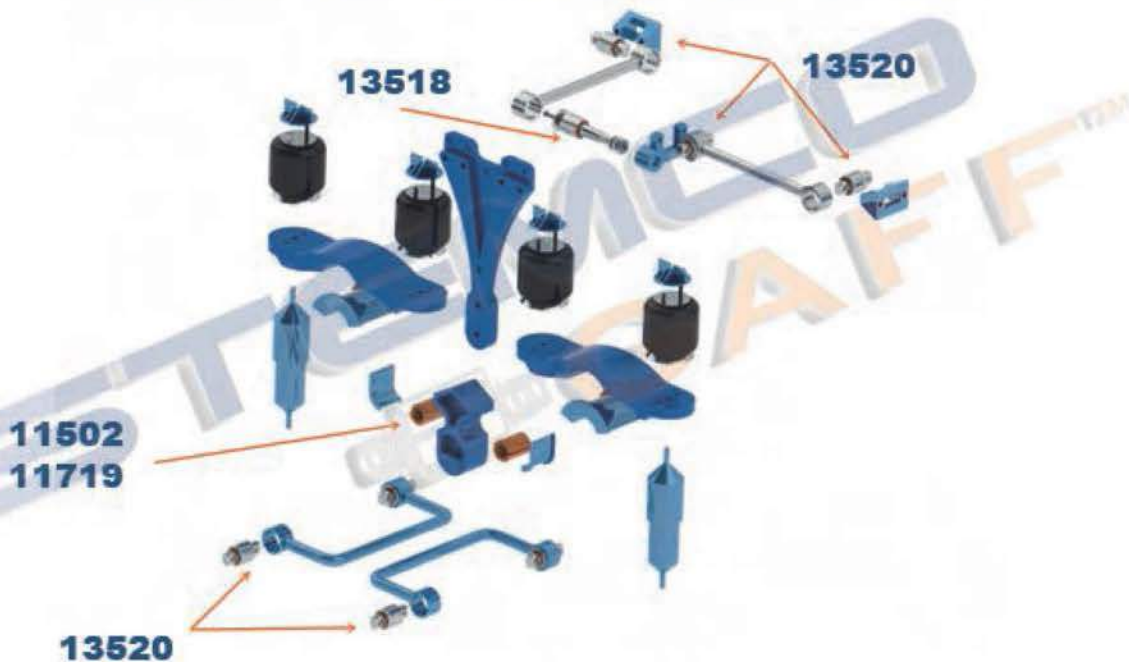

**STEMCO GAFF replacement parts compatible with:
KENWORTH® AIRGLIDE 200 SERIES**



**STEMCO GAFF replacement parts compatible with:
KENWORTH AIRGLIDE 380 SERIES**

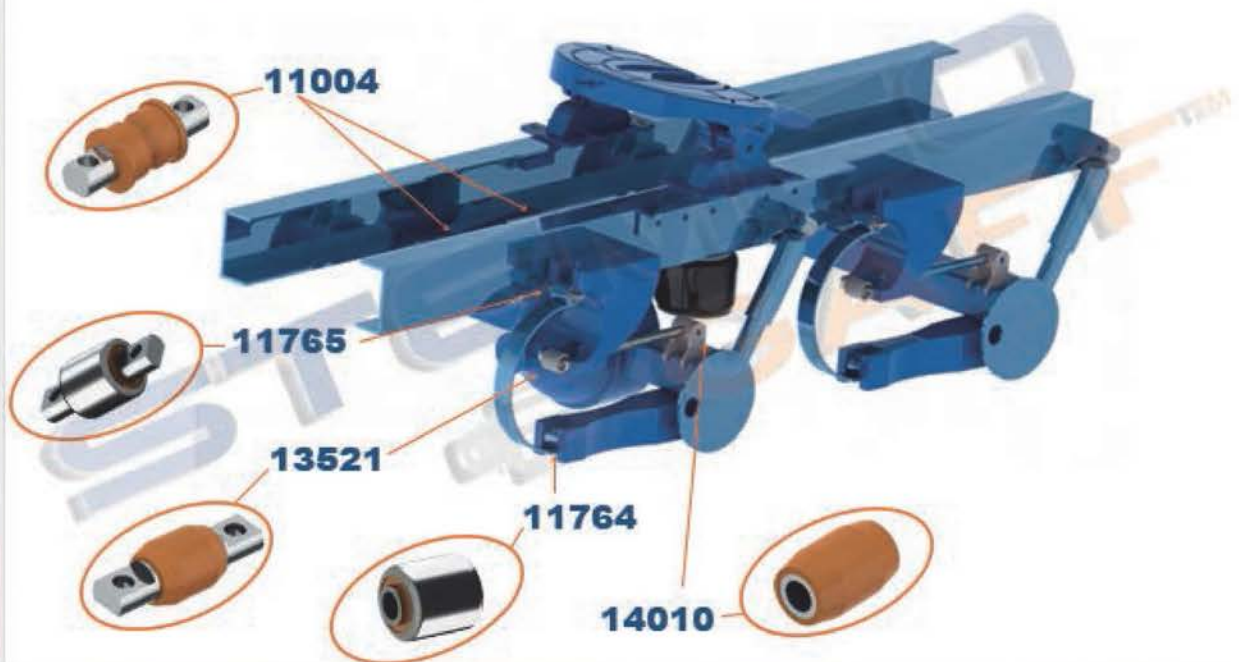

**STEMCO GAFF replacement parts compatible with:
KENWORTH® AIRGLIDE 460 SERIES**

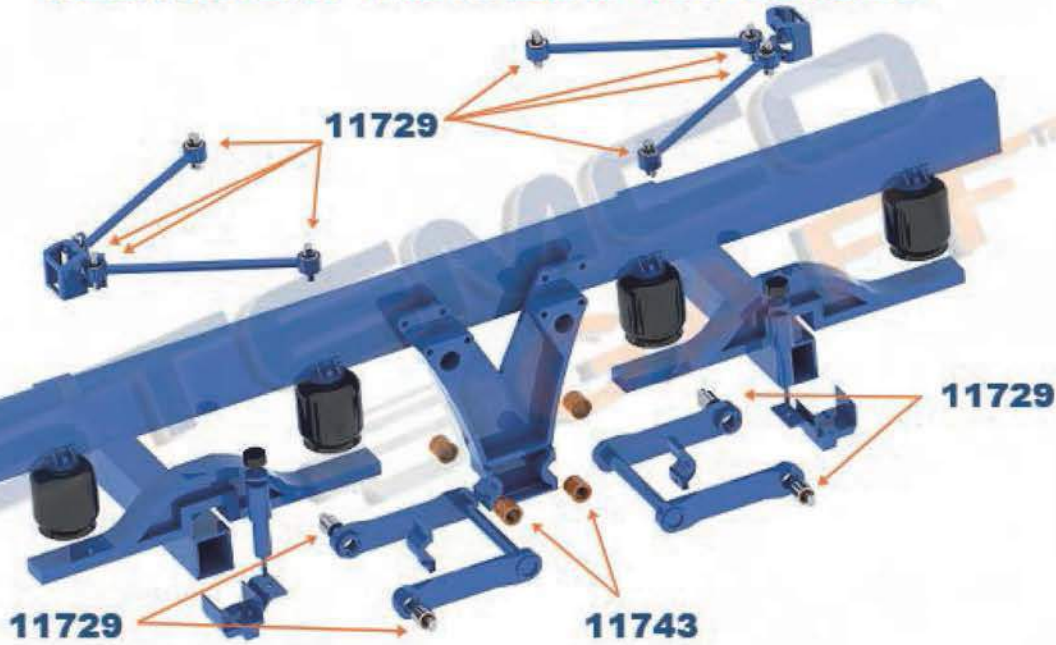

11004



Torque Rod Bushing

OD	2	1/16"
LG	6	5/8"
C-C	4	3/8"
BH		5/8"
HD	80A	

INCLUDED IN:
11078, 11081, 11769

TOOLS 11071, 18836

OEM

- A80BL7691
- A16-119448
- 47691
- 47691000
- 47691
- 47691
- 20-836PU
- R305275
- HS44
- E-5275

Notes: rib style / 11006 - oversized / 12051 - grooved for torque rod with a center rib / 13521 - chamfered

11060



Spring Pin Bushing
Front

OD	1	13/16"
OD<	1	
LG	7	
HD	80A	

OEM

- 5295
- K179-378
- B1363-59
- RB161
- TB68
- 327-306
- RB-161
- TB-68
- M16884
- M5212

Notes: additional tool suggestion 40090

11062



Hood Hinge Bushing

OD	2	1/8"
ID	1	5/16"
LG	2	1/4"
HD	80A	

OEM

- 66D608
- K066-178
- J5950
- R307464
- E-7464
- D39
- 329-113U
- M17333
- M17333UB
- PL1068

Notes:

11080



Torque Rod Assy

LG ²	8	1/16"
C-C	24	
BC-C	4	3/8"
BH		5/8"
HD	80A	

INCLUDES
QTY 1 11754
QTY 1 13520
QTY 1 13518

OEM

- 925031
- K195-376
- 945381
- TR59-41376

Notes:

11134

LG	8 11/16 ~	OEM 680-880-01-60 HLK1024
LG²	4 3/16 ~	
HD	70A-97A	



Hood Latch Assy

Notes: bracket not sold separately

11500

ID	3 1/2 ~	OEM K066-184 R309440 E-9440 D150 325-160 325-160U 09-7852 TRB6808 RS20210
LG	4 1/2 ~	
LG2	4 3/16 ~	
HD	80A	



Trunnion Bushing

Notes: used in 19004

11501

OD	5 ~	OEM K066-232 K066-50 35-502 R307492 E-7492 D154 325-222 325-222U MKW14 PL1038
ID	4 ~	
LG	4 7/8 ~	
HD	80A	



Trunnion Bushing

Notes: compatible with "Big 6" suspensions

11502

OD	2 7/8 ~	OEM CA293 K066-058 K066-293 K066-449 35-526PU 35-572PU R304669 R307446A KW3 KW3UB
ID	2 ~	
LG	4 ~	
HD	90A	



Stabilizer Bar Bushing

Notes: standard / oversized with tabs - 11719

11503

OD	2 3/4 ~	OEM
ID	1 3/4 ~	
LG	2 9/16 ~	
HD	71D	



Torque Rod Bushing

Notes:

11505

OD	2 15/16 ~	OEM
C-C	4 3/8 ~	
BH	5/8 ~	
HD	80A	



Torque Rod Bushing

Notes:

11506

OD	2 7/8 ~	OEM
C-C	4 3/8 ~	
BH	5/8 ~	
HD	80A	



Torque Rod Bushing

Notes:

11507

OD	2 11/16 ~	OEM
C-C	4 3/8 ~	
BH	5/8 ~	
HD	80A	



Torque Rod Bushing

Notes: additional tool suggestions 18833, coming soon 40131

Kenworth continued

11509

OD	3 1/2"	-
C-C	4 3/8"	-
BH	5/8"	-
HD	80A	-

OEM

Torque Rod Bushing

Notes: additional tool suggestions 11731, 18834

11510

OD	3 5/8"	-
C-C	4 3/8"	-
BH	5/8"	-
HD	80A	-

OEM

Torque Rod Bushing

Notes:

11511

OD	3 1/2"	-
C-C	4 3/8"	-
BH	5/8"	-
HD	80A	-

OEM

932420
K195-415-13
35-505
E-9324
321-335
321-335A
TRB6810



Torque Rod Bushing

Notes: Big 6 Suspension / 12 per truck / used in rare, heavy duty applications / additional tool suggestions 11731, 18834

11512

OD	4 1/8"	-
C-C	4 3/8"	-
BH	5/8"	-
HD	80A	-

OEM

A-2297-K-1052
A-2297-V-4806
K066-259
R309323
E-9323
D244
321-325
321-325U
09-7241
TRB6801



Torque Rod Bushing

Notes: pin 2.5" / metal sleeve / Big 6 suspension / no sleeve 11513 / verify dimensions compare to 11514 - pin 1.900" / additional tool suggestions 11732, 18834

11513

OD	4 3/8"	-
C-C	4 3/8"	-
BH	5/8"	-
HD	80A	-

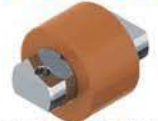
OEM

Torque Rod Bushing

Notes: no sleeve / pin 2.5" / Big 6 Suspension / metal sleeve - 11512

11514

OD	4 1/8"	-
C-C	4 3/8"	-
BH	5/8"	-
HD	80A	-

OEM

A-2297-K-1052
A-2297-V-4806
K066-259
R309323
E-9323
D244
321-325
321-325U
09-7241
TRB6801



Torque Rod Bushing

Notes: pin 1.900" / metal sleeve / Big 6 suspension / verify dimensions compare to no sleeve 11513 or 11512- pin 2.5" / additional tool suggestions 11732, 18834

11515

OD	2 13/16"	-
ID	1 1/16"	-
LG	4 1/8"	-
HD	80A	-

OEM

K066-160
R307451
E-7451
D89
329-123U
329-124U
KP119
KP119UB
PL1037



Fifth Wheel Bushing

Notes: supersedes 11516

11518

OD	2 9/16"	-
ID	2"	-
LG	4"	-
HD	80A	-

OEM

Trunnion Bushing

Notes:

11519



OD	2 7/8 ~
OD<	1 13/16 ~
ID	5/8 ~
LG	1 5/16 ~
HD	80A

OEM

Cab Mount

Notes: no metal bushing / verify dimensions compare to 11520 - metal sleeve

11520



OD	2 7/8 ~
OD<	1 7/8 ~
ID	5/8 ~
LG	1 5/16 ~
HD	80A

OEM

K066-228
M601
M601-70NR
35-548PU
R307472
UM1113
E-7472
D6
329-136U
M17412

Cab Mount
W / Metal Sleeve

Notes: metal bushing stepped design/ verify dimensions compare to 11523 or 11552

11523



OD	2 7/8 ~
OD<	1 13/16 ~
ID	5/8 ~
LG	1 5/16 ~
HD	80A

OEM

K066-228
M601
M601-70NR
35-548PU
R307472
UM1113
E-7472
D6
329-136U
M17412

Cab Mount
W / Metal Sleeve

Notes: metal bushing stepped design / verify dimensions compare to 11523 or 11552 / compatible with Western Star using (2) 11523 with a 12301

11527



OD	2 9/16 ~
OD<	1 9/16 ~
ID	5/8 ~
LG	2 1/16 ~
HD	80A

OEM

Cab Mount

Notes: verify dimensions compare to 11612

11529



OD	2 7/16 ~
OD<	1 9/16 ~
ID	7/8 ~
LG	1 7/8 ~
HD	80A

OEM

Cab Mount

Notes: verify dimensions compare to 11612

11531



OD	2 9/16 ~
OD<	1 1/2 ~
ID	5/8 ~
LG	2 1/8 ~
HD	80A

OEM

Cab Mount
Radiator Mount

Notes: verify dimensions compare to 11612

11532



OD	1 1/8 ~
WD	3 15/16 ~
LG	6 3/4 ~
C-C	4 ~
HD	80A

OEM

K174-225

Cab Mount

Notes:

11533



OD	3 ~
OD<	1 13/16 ~
ID	5/8 ~
LG	1 15/16 ~
HD	80A

OEM

K066-336
M602-70NR
35-558PU
R307473
UM1112
E-7473
D30
329-135U
M17414
M17414UB

Cab Mount

Notes:

Kenworth continued

11534Motor Mount
Rear
No Metal

THK	2	1/2	"
WD	4	1/2	"
LG	2	3/16	"
HGT			
HD	80A		

OEM

Notes:

11535Motor Mount
Rear

THK	2	7/16	"
WD	4	1/2	"
LG	2	3/16	"
HGT			
HD	80A		

OEM

K174-555
K174B456
35-551PU
R307470
UM1190
E-7470
D21
329-142U
M17408
M17408UB

Notes:

11536Motor Mount
Front

OD	3	11/16	"
OD<	2	1/4	"
ID		13/16	"
LG	2	1/2	"
HD	80A		

OEM

Notes:

11537Motor Mount
Front

OD	3	11/16	"
OD<	2	1/16	"
ID		3/4	"
LG	2	1/2	"
HD	80A		

OEM

K066-229
M700
35-549PU
R307469
UM1157
E-7469
D432
D7
329-141U
329-159U

Notes:

11539Motor Mount
Rear

THK	2	9/16	"
WD	2	1/16	"
LG	5	3/4	"
C-C	3		
BH		5/8	"
HD	80A		

INCLUDED IN:
11761**OEM**

K066-247
K066-282
K066-320
M506-70NR
35-552PU
35-570PU
R307468
UM1191
E-7468
D22

Notes: verify dimensions compare to 11614

11540Motor Mount
Rear (Lower)

ID		13/16	"
THK	2	5/8	"
WD	3	1/8	"
LG	7	7/8	"
HD	70A		

INCLUDED IN:
11760**OEM**

K066-377
K066-391
D111
KT59-62001

Notes: used with 11541 / see tech tip 01 577 9022

11541Motor Mount
Rear (Upper)

ID		13/16	"
THK	1	3/16	"
WD	2	3/4	"
LG	4	3/16	"
HD	70A		

INCLUDED IN:
11760**OEM**

D1310011
K066-421
D114

Notes: used with 11540 / see tech tip 01 577 9022

11542

Fuel Pedal Mount

THK	1	5/16	"
WD	1	3/8	"
LG	2	9/16	"
HD	97A		

OEM

Notes:

11543 LG 8 9/16" ~
HD 70A - 97A" ~



Hood Latch

OEM
K147-107
K147C106
HLK1000

Notes:

11545 OD 3 3/16" ~
OD< 1 1/2" ~
LG 5 1/4" ~
THR 1/2" - 13 UNC
HD 80A



Hood Guide

OEM
K179-528
K179D450
K179-D450
35-555PU
R307467
UM1104
E-7467
D26
329-129U
M17402

Notes:

11546 THK 1/4" ~
WD 3 ~
LG 6 9/16" ~



Hood Guide Metal Base

OEM
K179-D481

Notes:

11547 THK 3/8" ~
WD 3 ~
LG 8 5/8" ~



Hood Guide Metal Base

OEM
K350-1887

Notes:

11548 OD 1 5/8" ~
ID 1 1/2" ~
LG 1 3/8" ~
HD 80A



Radiator Mount No Sleeve

OEM

Notes: components not sold separately

11549 OD 1 9/16" ~
OD< 13/16" ~
ID 5/8" ~
LG 13/16" ~
HD 80A



Radiator Tie Rod Bushing No Sleeve

OEM
K264-84
35-562PU
R307640
E-7640
D34
329-120U
PL1065

Notes:

11550 OD 2" ~
OD< 1" ~
ID 5/8" ~
LG 1" ~
HD 80A



Shock Absorber Bushing No Sleeve

OEM
CA368-6
COM266
COM368-6
K066-266
35-539PU
R307474
SB3UB
E-7474
D37
320-178

Notes:

11554 OD 1 1/8" ~
OD< 3/4" ~
ID 3/8" ~
LG 7/8" ~
HD 80A



Air Cooler Mount

OEM
M200
M200-70EP
35-568PU
50-1440PU
R307448
E-7448
D15
D325
329-149U
329-162U

Notes:

Kenworth continued

11556



Torque Rod Bushing

OD	2 11/16"
C-C	4 3/8"
BH	5/8"
HD	80A

OEM
227710
M2069

Notes: verify dimensions compare to 13522 and 83522

11557



Hood Hinge Bushing

OD	1 3/4"
OD<	1 1/8"
ID	1/2"
LG	1 5/16"
HD	80A

OEM

Notes:

11560



Torque Rod Bushing

OD	1 15/16"
ID	1"
LG	3"
HD	80A

OEM

Notes:

11561



Torque Rod Bushing

OD	1 3/4"
ID	1"
LG	3"
HD	80A

OEM

Notes:

11611



Shifter Bushing Kit

OD	1 1/2"
ID	13/16"
LG	2 5/16"
BH	3/4"
HD	90A

OEM
FULK3399
MS99-63399

Notes:

11612



Cab Mount
W / Metal Sleeve
(Lower)

OD	2 5/8"
OD<	1 5/8"
ID	5/8"
LG	2 1/16"
HD	80A

OEM
M500-70NR
35-556PU
R307471
UM1102
E-7471
D27
329-128U
M17410
M17410UB
PL1063

Notes: verify dimensions compare to 11527, 11529 and 11531

11613



Motor Mount
Front

OD	3 13/16"
OD<	2 1/16"
ID	3/4"
LG	2 9/16"
HD	80A

OEM
K066-229
M700
35-549PU
R307469
UM1157
E-7469
D432
D7
329-141U
329-159U

Notes:

11614



Motor Mount
Rear

THK	2 5/16"
WD	2"
LG	5 9/16"
BC-C	3"
BH	5/8"
HD	80A

OEM
K066-247
K066-282
K066-320
M506-70NR
35-552PU
35-570PU
R307468
UM1191
E-7468
D22

Notes: verify dimensions compare to 11539

11615

OD	3 1/2 ~
OD<	2 ~
ID	13/16 ~
LG	2 1/4 ~
HD	70A

OEM
 K066-404
 K066-405
 K066-406
 K066-407
 K066-423
 D108
 D113
 KT59-62002
 KT59-62002-HT
 MM59-62407

INCLUDED IN:
11762



Motor Mount Front

Notes: compatible with K066-404 (Lower) and K066-406 (Upper) / kit not offered by OE / see tech tip 01 577 9021

11705

OD	3 ~
OD<	1 13/16 ~
ID	5/8 ~
LG	2 3/8 ~
HD	80A

OEM
 K066-176
 M600
 35-1363PU
 35-564PU
 R307462
 UM1196
 E-7462
 D36
 D5
 D51



Cab Mount

Notes: used in multiple applications

11707

OD	2 1/2 ~
OD<	1 5/8 ~
ID	5/8 ~
LG	2 ~
HD	80A

OEM
 M501
 35-569PU
 R307506
 E-7506
 D326
 D4
 D540
 329-144U
 329-163U
 M17804UB



Cab Mount

Notes: OD< Chamfered / 12355 - standard / also used as motor mount

11709

OD	1 3/4 ~
OD<	1 3/16 ~
ID	1/2 ~
LG	1 3/8 ~
HD	80A

OEM
 K066-218
 M300-70NR
 35-553PU
 R307466
 UM1194
 E-7466
 D24
 329-145U
 M3841
 M17400



Hood Hinge Bushing

Notes:

11715

OD	4 1/8 ~
C-C	5 1/4 ~
BH	15/16 ~
HD	80A

OEM



Torque Rod Bushing

Notes:

11719

OD	2 7/8 ~
ID	1 15/16 ~
LG	4 ~
HD	90A

OEM
 CA293
 K066-058
 K066-293
 K066-449
 35-526PU
 R304669
 R307446A
 KW3
 KW3UB
 KW6UB



Stabilizer Bar Bushing

Notes: oversized with tabs / 11502 - standard

11720

OD	3 1/16 ~
ID	2 1/8 ~
LG	2 13/16 ~
HD	80A

OEM
 K066-450
 K066-478
 KW28
 35-572PU
 R3010302
 E-10302
 D2001
 D2002
 320-200
 320-200A



Trunnion Bushing

Notes:

11726

OD	1 15/16 ~
ID	5/16 ~
THK	5/16 ~
HD	72D

OEM
 K221-3941-08



Transmission Mount

Notes:

Kenworth continued

11729



Torque Rod Bushing

OD 2 3/4 -
C-C 4 3/8 -
BH 11/16 -
HD 80A

INCLUDED IN:
11773, 11793, 12074,
13634, 31095

TOOLS 18551, 18833

Notes: high articulation bushing

OEM
836940
R3010303
E10303
E-10303
321-369
TS59-22400

11733



Sway Bar Pin Kit

INCLUDES
QTY 1 11736
QTY 2 11737
QTY 1 11734

INCLUDED IN:
11766

Notes:

OEM
K066-461
K066-502-2
K179-531
K207-1085
K345-5156
35-574
D86
320-203
334-1617
KB452

11734



Stabilizer Bar Bushing

OD 3 9/16 -
ID 2 1/8 -
THK 15/32 -
HD 90A

INCLUDED IN:
11733

Notes:

OEM
K066-461
K066-502-2
D86
320-203
KB452
KB452UB
SW59-29461

11735



Torque Rod Bushing

OD 4 1/8 -
C-C 4 3/8 -
BH 3/4 -
HD 80A

Notes: 11512 - smaller BH

OEM
A-2297-K-1052
A-2297-V-4806
K066-259
35-501
R309323
E-9323
D244
321-325
321-325A
09-7241

11737



Grease Seal Retainer
2 Pack

OD 3 1/4 -
ID 1 7/8 -
LG 5/8 -
HD 70A

INCLUDED IN:
11733

Notes:

OEM
K207-1085

11741



Torque Rod Bushing

OD 4 1/8 -
C-C 5 1/4 -
BH 1 -
HD 80A

Notes:

OEM

11742



Cab Mount
(Upper)

ID 1 3/8 -
THK 2 11/16 -
WD 3 1/4 -
LG 4 15/16 -
HD 80A - 71D

Notes: use with 18938

OEM
C13-1007

11743



Stabilizer Bar Bushing

OD 3 7/64 -
ID 2 5/16 -
LG 2 7/8 -
HD 80A

Notes:

OEM
C13-1005
KW08849AC
320-208

11751

C-C	24	~
B C-C	4	3/8
HD	80A	

INCLUDES
 QTY 1 11754
 QTY 2 13520

OEM
 944270
 K195-375
 925030
 TR59-41375



Torque Rod Assy

Notes:

11753

OD	1	3/4	~
C-C	6	5/16	~
HD	80A		

OEM
 B65-1006
 B65-1017-001
 RB-295
 MR836
 MR836UB
 SP59-11006



Spring Pin Bushing

Notes: additional tool suggestion 40090

11754

ID	2	3/4	~
C-C	24		~

INCLUDED IN:
 11080, 11751

OEM



Torque Rod

Notes:

11757

OD	1	3/4	~
THK	1	1/4	~
LG	6	1/4	~
C-C	5	3/4	~
BC-C	4		
HD	80A		

INCLUDES
 QTY 2 11759
 QTY 2 11758
 QTY 4 Bolt 1/2 x 3"
 QTY 4 Lock Nut 1/2"
 QTY 4 Flat Washer 1/2"

OEM
 5295
 5296
 B65-1005
 K209-75
 35-547
 B1372-59
 E484-59
 TB68
 327-434
 330-125



Spring Pin Bushing Kit Shakles & Bushings

Notes: kit not offered by OE

11758

OD	1	3/4	~
C-C	5	3/4	~
HD	80A		

INCLUDED IN:
 11757

OEM
 5295
 5296
 B65-1001
 50-275
 TB68
 327-434
 50-275
 TB-68
 M5212
 SP59-11010



Spring Pin Bushing

TOOL 40090

Notes:

11759

ID	1	1/16	~
THK	1	1/4	~
WD	2		
LG	6	1/4	~
BC-C	4		
BH	1/2		

INCLUDES
 QTY 2 Bolt 1/2 x 3"
 QTY 2 Lock Nut 1/2"
 QTY 2 Flat Washers 1/2"

INCLUDED IN:
 11757

OEM
 K209-75
 35-547
 E484-59
 330-125
 M1214



Shackle Assembly

Notes: components not sold separately

11760

INCLUDES
 QTY 2 11540
 QTY 2 11541
 QTY 2 Bolts 3/4 x 5" G8
 QTY 2 Lock Nuts 3/4"
 QTY 4 Flat Washer 3/4"

OEM
 D1310011
 K066-377
 K066-391
 K066-421
 D111
 D114
 KT59-62001
 KT59-62001-HW
 MM59-62001



Motor Mount Kit Rear

Notes: kit not offered by OE / see tech tip 01 577 9022

11761

INCLUDES
 QTY 2 11539
 QTY 4 Bolt 3/4 x 4" G8
 QTY 4 Lock Nut 3/4"
 QTY 8 Flat Washer 3/4"

OEM
 K066-247
 K066-282
 K066-320
 M506-70NR
 35-552PU
 35-570PU
 R307468
 UM1191
 E-7468
 D22



Motor Mount Kit Rear

Notes: kit not offered by OE

Kenworth continued

11762



Motor Mount Kit
Front

INCLUDES

QTY 2 11615
QTY 2 Bolt 3/4" x 4" G8
QTY 2 Lock Nut 3/4"
QTY 4 Flat Washer 3/4"

OEM

K066-385
K066-404
K066-406
D108
D113
KT59-62002
KT59-62002-HT
KT59-62002-HW
KT59-62003-HT
MM59-62407

Notes: kit not offered by OE / see tech tip 01 577 9021

11763



Spring Pin Bushing

OD 2 1/16"
C-C 6 5/16"
HD 80A

OEM

B65-1007
B65-1012
RB308
SP59-11007

Notes: additional tool suggestion 40093

11764



Torque Rod Bushing

OD 2 3/8"
ID 7/8"
LG 3"
HD 90A

OEM

C13-6002
K221-5086
RB-292
MR830
SU00-29002

Notes:

11765



Torque Rod Bushing

OD 2 3/8"
C-C 4 3/8"
BH 5/8"
HD 90A

OEM

51879
C13-6001
RB-291
MR828
SU00-29001

Notes:

11766



Sway Bar Repair Kit
54 mm & 58mm

INCLUDES

QTY 1 11733
QTY 1 PHM16098

OEM

K066-461
K066-502-2
K179-531
K207-1085
K345-5156
35-574
D86
320-203
334-1617
KB452

Notes: kit not offered by OE

11767



Spring Pin Bushing

OD 1 3/4"
C-C 5 7/16"
HD 80A

OEM

50273AB
B65-6005
RB328
RB-328
SP00-11005

Notes: additional tool suggestion 40090

11768



Hood Latch

LG 10 3/4"
HD 70A - 71D

OEM

374-1295-60
379-9344
HLK1015

Notes:

11773



Torque Rod Assy

C-C 19 3/4"
BC-C 4 3/8"
BH 11/16"
HD 80A

INCLUDES

QTY 1 11770
QTY 2 11729

OEM

K195-472
K195-474
TR59-41474

Notes:

11792

C-C	25	9/16"
BC-C	4	3/8"
BH		5/8"

INCLUDES
QTY 2 13521

OEM
C65-6002
C65-6009
345-884
937530
TR030020010
TMR553
TR00-41009



Torque Rod Assy

Notes:

11793

C-C	20	1/4"
BC-C	4	3/8"
BH		11/16"

INCLUDES
QTY 2 11729

OEM
C65-1008
C65-1009
TMR74
TMR74B
TR59-41008



Torque Rod Assy

Notes:

11794

LG	8	1/16"
C-C	25	
BC-C	4	3/8"
BH		5/8"
THR	1/4"	12 UNF

INCLUDES
QTY 1 13520
QTY 1 13518

OEM



Torque Rod Assy

Notes:

11795

ID	7/8"	
C-C	24	11/16"
BC-C	4	3/8"
BH		5/8"

INCLUDES
QTY 1 13521
QTY 1 14010

OEM
C65-6000-002
C65-6011-002
345-883
937561
TMR539
TR00-41600



Torque Rod Assy

Notes:

12044

C-C	26	
BC-C	4	3/8"
BH		5/8"

INCLUDES
QTY 1 13590
QTY 2 13520

OEM
46661
MR661
UR661
E-2642



Torque Rod Assy
Weldable

Notes: universal torque rod

12355

OD	2	1/2"
OD<	1	5/8"
ID		5/8"
LG	2	
HD		80A

OEM
M501
50-1431PU
R307506
UM1693
E-7506
D326
329-144U
M17804UB
PL1070



Motor Mount

Notes: standard / chamfered - 11707

12365

LG	8	11/16"
HD		70A

OEM
L56-0001



Hood Latch

Notes:

12397

ID	7/8"	
C-C	23	3/4"
BC-C	4	3/8"
BH		5/8"

INCLUDES
QTY 1 13521
QTY 1 14010

OEM
C65-6000-001
C65-6011-001
345-882
937560
TMR537
TR00-41001



Torque Rod Assy

Notes:

Kenworth continued

13514

Torque Rod Bushing

OD	3	-
ID	1 1/8	-
LG	3	1/4
HD	80A	-

OEM
224993
20-850
R302238
C870
E-2238
D316
321-141
321-141U
M2068
09-5519

TOOLS 13585, 18831

Notes: additional tool suggestion 13585

13515

Torque Rod Bushing

OD	3	-
C-C	5 11/16	-
BH	13/16	-
HD	80A	-

OEM
224991
20-885
R303411
RBT207
E-3411
D312
321-144
321-144U
M-3262
09-5518

TOOL 18831

Notes: additional tool suggestion 13585

13518

Torque Rod Bushing

OD	2 3/4	-
LG	8 1/16	-
THR	1 1/2 - 12 UNF	-
HD	80A	-

INCLUDED IN:
11794, 11808, 13657, 13679,
13686, 13694, 13695, 34555

TOOLS 13584, 18833

Notes: metal sleeve/ 13533 - no sleeve / additional tool suggestion 18551, coming soon 40131

OEM
229610
20-831PU
R302228
R308651
C883
C883UB
E-2228
E-8651
D422
321-133

13520

Torque Rod Bushing

OD	2 3/4	-
C-C	4 3/8	-
BH	5/8	-
HD	80A	-

INCLUDED IN:
Several Kits

TOOLS 18551, 18833

Notes: 83520 - easy mount / 13536 - no metal sleeve

OEM
227720
20-833PU
R302226
R307639
C879
C879UB
E-2226
E-4664
E-7639
D423

13521

Torque Rod Bushing

OD	2 1/16	-
LG	6 5/8	-
C-C	4 3/8	-
BH	5/8	-
HD	80A	-

INCLUDED IN:
11153, 11792, 11795, 12397,
34563

TOOLS 11071, 18836

Notes: chamfered / 11004 - rib style / 11006 - oversized / 12051 - grooved for torque rod with a center rib

OEM
20-836PU
A80BL7691
ZJF47691L
47691
R305275
47691
47691
47691-000
A16-119448
HS44

13522

Torque Rod Bushing

OD	2 17/32	-
C-C	4 3/8	-
BH	5/8	-
HD	80A	-

TOOLS 18553, 18833

Notes: metal sleeve / easy mount - 83522 / no sleeve - 11003 / additional tool suggestion coming soon 40131

OEM
227710
20-832PU
R302225
R307638
C878
C878UB
FL55
E-2225
E-7638
D421

13528

Torque Rod Bushing

OD	2 3/4	-
C-C	4 3/8	-
BH	3/4	-
HD	80A	-

INCLUDED IN:
12395, 13701, 13702, 13703

TOOLS 18833, 18551

Notes: additional tool suggestion coming soon 40131

OEM
227723
20-851PU
R303868
C889
E-3868
D424
321-265
321-265U
TRB6822
TRB6822UB

13533

Torque Rod Bushing

OD	2 15/16	-
LG	8 1/16	-
THR	1 1/2 - 12 UNF	-
HD	80A	-

TOOL 18831

Notes: 13518 - metal sleeve

OEM
229610
20-831PU
R302228
E-2228
D422
M2072
09-5721
TRB6112
TT38000

13536



Torque Rod Bushing

OD	2 15/16"
C-C	4 3/8"
BH	5/8"
HD	80A

OEM
227720
20-833PU
R302226
R307639
C879UB
E-2226
E-4664
E-7639
D423
321-132U

TOOL 18831

Notes: 83520 - easy mount / 13520 - metal sleeve

13553



Beam End Bushing

OD	4 3/8"
ID	2 1/2"
LG	5 3/4"
HD	80A

INCLUDED IN:
13587

TOOLS 13563, 13588

OEM
45900
20-810PU
R301341A
R302771
C862
C862UB
C871
E-1341A
E-2771
E-9512

Notes: uncrimped sleeve double bonded bushing / supersedes 13506 / use adapter 13507 for complete repair / additional tool suggestion 13595

13679



Torque Rod Assy

LG ²	8 1/16"
C-C	25"
BC-C	4 3/8"
BH	5/8"
HD	80A

INCLUDES
QTY 1 13680
QTY 1 13518
QTY 1 13520

OEM
925150
TR59-41150

Notes:

13735



Torque Rod Assy

C-C	14 3/8"
BC-C	4 3/8"
BH	5/8"

INCLUDES
QTY 2 13520

OEM
32271-102
48411-006
50376-001
62007-365
E-9394
E-9409
345-734
345-792
345-815
TR50-41102

Notes:

14010



Torque Rod Bushing

OD	2"
ID	7/8"
LG	3"
HD	80A

INCLUDED IN:
11795, 12397

TOOL 18836

OEM
E1HT5781EA
47692
47692-000
13945-01
221394501
55-130
R303362
R305276
R208
E-3362

Notes: additional tool suggestion coming soon 40124

14014



Torque Rod Bushing

OD	2"
ID	1"
LG	3"
HD	80A

OEM

Notes: standard / universal (known as 1-2-3) / 14007- chamfered / additional tool suggestions 18836, coming soon 40124

15004



Equalizer Bushing

OD	3 1/4"
ID	2"
LG	4 1/2"
HD	80A

OEM

Notes:

15006



Equalizer Bushing

OD	4"
ID	2 1/2"
LG	2 1/2"
HD	80A

OEM

Notes:

Kenworth continued

17283



Exhaust Bushing

ID	3/8"
THK	1 9/16"
WD	1 5/8"
LG	3 5/8"
C-C	1 15/16"
HD	70A

OEM
M13-1009

Notes: compatible with T-800

17284



Exhaust Bushing

OD	1 15/16"
ID	15/32"
LG	1 3/16"
HD	70A

OEM
M13-1011

Notes: compatible with W-900

18244



Shock Absorber Bushing

OD	1 13/16"
ID	11/16"
LG	13/16"
HD	80A

OEM
COM266
COM368-6
K066-266
R307474
E-7474
320-178
320-178UB
MH1433
MH1433UB
PL1028

Notes:

18566



Shock Absorber Bushing

OD	1 7/8"
ID	1"
LG	1"
HD	80A

OEM
73D2002
40-340
R307529
HB593
SB1UB
E-7529
D1
320-153
320-153U
M695

Notes:

18601



Shackle

ID	1 1/16"
THK	1 1/4"
WD	1 3/4"
LG	6 7/16"
C-C	4"

OEM
K209-59
E796-59
330-168
M1838

Notes:

18602



Shackle

ID	1 1/16"
THK	1 1/4"
WD	1 3/4"
LG	6 7/16"
C-C	4"

OEM
K209-82
K209-87
330-168

Notes:

18938



Cab Mount
(Lower)

OD	3"
OD<	3/4"
ID	5/8"
LG	3 7/16"
HD	80A

OEM
K066-435-3

Notes: use with 11742

18949



Cab Mount

ID	11/16"
WD	2 1/4"
LG	6 1/16"
HGT	3 11/16"
HD	80A

OEM
26732-2

Notes: compatible with all Kenworth T-2000

Kenworth continued

19004



Center Bushing

OD	5	~
ID	3 1/2	~
LG	8 1/16	~
HD	80A-71D	

OEM
K066-184
R309440
E-9440
D150
325-160
325-160U
09-7852
TRB6808
RS20210
RS20216

Notes: contains 11500 / pre-assembled / some components not sold separately

40074



Carrier Bearing Assy

ID	2 3/8	~
C-C	8 1/2	~
BH	1/2	~
HGT	3 21/64	~
HD	70A	

OEM
210661-1X
CB2106611XSA
DS-6049

Notes: includes carrier bearing bushing 18002

40075



Carrier Bearing Assy

ID	2	~
C-C	7 7/16	~
BH	1/2	~
HGT	2 25/32	~
HD	70A	

OEM
2101211X
DS-6048

Notes: includes carrier bearing bushing 18725

83520



Easy-Mount Torque Rod Bushing

OD	2 3/4	~
C-C	4 3/8	~
BH	5/8	~
HD	80A	

OEM
227720
A-2297-Y-77A
44695
64400-002L
66649-002
1693061C1
1688-227720
227720
02-27720
1117379B000

TOOLS 18551, 18833

Notes: standard - 13520 / no metal sleeve - 13536

83522



Easy-Mount Torque Rod Bushing

OD	2 17/32	~
C-C	4 3/8	~
BH	5/8	~
HD	80A	

OEM
227710
20-832PU
R302225
R307638
C878
C878UB
FL55
E-2225
E-7638
D421

TOOLS 18553, 18833

Notes: easy mount / metal sleeve - 13522 / no metal sleeve - 11003

Mack

DESCRIPTION	OEM	PART ID	PAGE
Air Cooler Mount	20QL37P3 / 40-341	12049	167
Beam End Bushing	5462-10050 / WCM10050 / 60-1535 / R304382A / N120 / N120UB / E-4382A / E-8683 / D441 / 321-229 / 321-229U / M3456 / TRB5713 / PB57-21139	14513	170
Beam End Bushing	5462-11223 / 60-1501 / R304410A / N124 / E-4410A / D448 / 321-231 / 321-231U / M3454 / TRB5703 / PB57-21149	14533	170
Beam End Bushing	24SU21 / R304252 / N111 / D433	31592	171
Bolster Spring Kit	4000-64179037 / HS130 / E-14044 / E-14374 / 334-1727 / 334-1845 / MLC3 / MLC5 / LP50-24179	13626	169

Mack continued

DESCRIPTION	OEM	PART ID	PAGE
Cab Mount	20QL2101 / 40-302 / D143 / 329-169U	12004	163
Cab Mount	30QS3479AM	12052	162
Camshaft Bushing	80AX641 / E-5512 / 02-210	17501	281
Carrier Bearing Assy	203SJ13 / 210661-1X / DS-6049	40074	172
Carrier Bearing Assy	2101211X / DS-6048	40075	172
Easy-Mount Torque Rod Bushing	1688-227720 / 20-833PU / R302226 / R307639 / C879 / C879UB / E-2226 / E-4664 / E-7639 / D423 / 321-132 / 321-132U / M2070 / 09-5723 / TRB6820 / TRB6820UB / TS38000	83520	172
Easy-Mount Torque Rod Bushing	1688-227710 / 20-832PU / R302225 / R307638 / C878 / C878UB / FL55 / E-2225 / E-7638 / D421 / 321-131 / 321-131U / M2069 / TRB164 / TRB6164 / TS34000 / TS34095	83522	172
Equalizer Bushing	10QK260 / 30-1302 / 40-348 / RB187 / RB-187 / M3478 / MR620 / MR620UB / AT80000	13513	169
Equalizer Bushing	10QK268M / R305269 / R309401 / C868 / E-5269 / E-9401 / D425 / 321-225 / 321-225U / 321-245 / 321-245U / 09-5017 / TRB5168 / TRB5168UB / CB27500	13526	169
Fifth Wheel Bushing	3065-BSH109L / 3065-BSH172U / FW99-32109 / FW99-32172	10079	162
Fifth Wheel Bushing	3889-XB0011 / FW51-32011	18215	171
Fifth Wheel Bushing	3889-XB0009 / KP116	18221	171
Fifth Wheel Bushing	3889-XB10605 / FW99-32605	40035	172
Hood Guide	25QM-31 / 35-555PU / R307467 / UM1104 / E-7467 / D26 / 329-129U / M17402 / M17402UB / M17527 / M17527UB / PL1011	11545	162
Hood Hinge Bushing	20QL231P1 / 40-312 / D542 / 329-205U / PL1107	11544	162
Hood Latch	17QM263A / HLK2001	11109	162
Load Pad	25121508 / 10QK365A / 40-322PU / R302917 / R307481 / MP1 / MP10 / E-2917 / E-7481 / D285 / 325-112 / 325-112U / M2110 / 09-7593 / ABP1 / ABP1UB / MA36500	12006	164
Load Pad	10QK372 / 10QK389 / 40-345PU / R303680 / MP6 / MP8 / MP8UB / E-3680 / D284 / 325-114 / 325-124 / M2920 / 09-7586 / 09-7596 / 09-7599 / ABP6 / ABP6UB / ABP8 / MA37200	12009	164
Load Pad	25115012 / 10QK370 / 40-336PU / R302919 / R308667 / MP4 / E-2919 / E-8667 / D288 / 325-113 / 325-113U / M2111 / 09-7595 / ABP4 / ABP4UB / MA37000	12010	164
Load Pad	21036254 / 25125064 / 10QK36B / 10QK36C / 10QK388 / 10QK86B / 40-328 / R302920 / R307480 / MP2 / MP7 / E-2920 / E-7480 / D286 / 325-110 / 325-123 / 325-127 / M2112 / 09-7594 / 09-7598 / ABP2 / ABP2UB / MA36000	12014	164
Load Pad	10QK32BP1 / R303679 / MP5 / E-3679 / D283 / 325-108 / 325-108U / 09-7597 / ABP5 / MA32000	12053	167
Load Pad Kit	25115012 / 21036254 / 10QK36B / 10QK370 / SK50380-HW	12036	165
Load Pad Kit	10QK1065A / 21036254 / 10QK86B / SK50340-HW	12039	166
Load Pad Kit	25121508 / 10QK365A / 10QK372 / 10QK389 / 40-322PU / 40-345PU / MP1 / MP6 / MP8 / MP8UB / E-2917 / E-3680 / E-7481 / D284 / D285 / 325-112U / 325-114 / 325-124 / M2920 / 09-7593 / ABP1UB / ABP6UB / ABP8 / MA36500 / MA37200	12040	166
Motor Mount	20QL118A / 20QL1175 / 40-307PU / R307477 / UM1204 / E-7477 / D60 / 329-109U / M1 / M1UB / PL1017 / PL1017-HT	12000	163
Motor Mount	20QL2110 / 20QL258 / 40-357 / M5 / D-280 / M5UB	12002	163
Motor Mount		12003	163
Motor Mount	20QL1166 / D145 / 329-171U / M3 / M3UB / PL1109	12017	164
Motor Mount	20QL324M / 40-356 / R307641 / UM1219 / E-7641 / D66 / 329-114U / M2 / PL1091	12023	164
Motor Mount	20QL312M2 / D65 / M9UB / PL1131	12046	167
Motor Mount	20QL338M	12372	168
Motor Mount Kit	204SX216 / KT62-62216	12034	165
Motor Mount Kit	204SX389 / KT62-62389	12035	165
Motor Mount Kit	25164809 / 25172757 / 20QL322 / 20QL329 / MM62-62002 / MM62-62322 / MM62-62329	12045	166

DESCRIPTION	OEM	PART ID	PAGE
Motor Mount Kit	20QL312M2 / D065 / D65 / PL1131	12047	167
Overload Cushion	10QK222 / 20-823 / R302232 / R309514 / LC4 / LC4UB / E-2232 / E-9514 / D134 / 325-100 / 325-100U / M2061 / 09-5690 / MLC10 / HC10000	13649	170
Pivot Bushing	2974-1117680B060 / 2974-1117680B070 / 2974-1117680B075 / 321-338 / 321-368 / RD1170 / RD1175 / PB85-360B0	11711	162
Radiator Mount		12001	163
Radiator Mount	25121334 / 20QL295 / 20QL295M / D142 / 329-211 / MM62-62334	12026	165
Radiator Mount	20QL259A / 40-308 / D64 / 329-165U	12032	165
Radiator Mount	20QL1170 / 20QL251 / PB62-65251	12048	167
Radiator Mount	20QL231P1 / 20QL231P12 / 40-312 / 40-354 / D542 / 329-205U / PL1107	18837	171
Rebound Roller Kit	10QK269AM	11747	163
Shifter Bushing Kit	3088-K3399 / MS99-63399	11611	162
Shock Absorber Bushing	14QK136 / 40-340 / R307529 / HB593 / SB1UB / E-7529 / D1 / 320-153 / 320-153U / M695 / M-17526UB / MH1432 / MH1432UB / PL1026	18566	171
Spring Bushing	10QK253M / 171AM8 / 43RU297M / B1424-62 / LNC24MM / RB188 / 327-481 / 334-717 / RB-188 / M5316 / MR622 / SK62-10700	12043	166
Spring Pin Bushing	4QK3370 / 50-275 / TB68 / 327-434 / 50-275 / TB-68 / M5212 / SP59-11010	11758	163
Spring Pin Bushing	10QK254M / 22QK39301 / E315-62 / RB189 / 330-102 / RB-189 / M876 / MR624 / SK62-10600 / SP62-1154M	12041	166
Torque Rod		12054	167
Torque Rod	17QF471M5	13597	169
Torque Rod Assy	25164994 / 17QF455P240 / 945381 / TR59-41376	11080	162
Torque Rod Assy	25164946 / 17QF460P240 / 1RY39307P13 / 5435-947794 / 925030 / TR59-41375	11751	163
Torque Rod Assy	SK27771	12042	166
Torque Rod Assy	25170832 / 17QF460P210 / 17QF473M2 / 17QF474P209 / TR62-413M2	12069	168
Torque Rod Assy	25014582 / 25170831 / 251660077 / 17QF358 / 17QF359 / 17QF460P200 / 17QF473M / TR62-413M3	12070	168
Torque Rod Assy	25170833 / 17QF261P23 / 17QF352M2 / 17QF460P243 / 17QF473M4 / 92883-4 / TR62-41243	12071	168
Torque Rod Assy	25162529 / 17QF251P11 / 17QF463P180 / 17QF464P180 / 1RY48P23 / 345-222 / 943763 / TR62-41180	12072	168
Torque Rod Assy	25174658 / 17QF460P215 / TR62-41215	12073	168
Torque Rod Assy	25160749 / 25164945 / 17QF457P238 / 17QF460P238 / 924970 / 942119 / 943790 / 945240 / TR62-41238	12074	168
Torque Rod Assy	4000-62010455 / TR50-42455	12396	138
Torque Rod Assy	25174706 / 17QF460P220 / 943853 / R547 / TR62-41220	13634	170
Torque Rod Assy	25171605 / 17QF455P243 / 4000-62350615 / TR50-41615	13733	170
Torque Rod Assy	17QF357M / E-9394 / E-9409 / 345-734 / 345-792 / 345-815 / TR50-41102	13735	170
Torque Rod Assy	30SQ4525 / 75-1709 / VT20 / E-8821 / 345-219 / 345-898 / R531 / R63 / TR96-41068	18860	171
Torque Rod Assy	4000-62350645 / TR50-41645	34555	172
Torque Rod Assy	4000-62000590 / 4000-62001590 / 924920 / 942174 / 944160 / 944220 / 948574 / TR50-42590	34556	172
Torque Rod Bushing	47691 / 20-836PU / R305275 / HS44 / E-5275 / D405 / 321-223 / 321-223U / TRB6185 / TRB6185UB / PL1146A	11004	162
Torque Rod Bushing	46735 / 1688-229240 / R302815 / R309518 / C884 / E-2815 / E-9518 / D293 / D293S / 321-136 / 321-136U / 09-5719 / TRB6119 / 38000	12031	165
Torque Rod Bushing	SS-R0035P240 / 321-519 / TRB6199	12051	167
Torque Rod Bushing	1688-227720 / 20-833PU / R302226 / R307639 / C879 / C879UB / E-2226 / E-4664 / E-7639 / D423 / 321-132 / 321-132U / M2070 / 09-5723 / TRB6820 / TRB6820UB / TS38000	13520	169
Torque Rod Bushing	47691 / 20-836PU / R305275 / HS44 / E-5275 / D405 / 321-223 / 321-223U / TRB6185 / TRB6185UB / PL1146 / TS50-22691	13521	169

DESCRIPTION	OEM	PART ID	PAGE
Torque Rod Bushing	1688-227710 / 20-832PU / R302225 / R307638 / C878 / C878UB / FL55 / E-2225 / E-7638 / D421 / 321-131 / 321-131U / M2069 / TRB164 / TRB6164UB / TS34000 / TS34095	13522	169
Torque Rod Bushing	1688-227720 / 20-833PU / R302226 / R307639 / C879UB / E-2226 / E-4664 / E-7639 / D423 / 321-132U / M2070 / 09-5723 / TRB6820UB	13536	169
Torque Rod Bushing	240530 / 321-267 / TS38875	13685	170
Torque Rod Bushing	10QK231 / 3QK2171K15 / 55-134PU / R301964 / R127 / E-8689 / 321-157U / M1751 / TRB6062	15009	170
Torque Rod Bushing	8446-R005422 / E-11763 / 334-1672 / TRK4931 / PB00-26422 / SU99-39115	50033	172
Torque Rod Bushing Kit	7014-TK19089 / R301983 / R001 / R003 / E-1312 / E-1983 / E-9545 / 334-252 / 334-252U / 334-253 / 09-2360 / TRK6008 / TRK6008UB / TH83-22089 / TH83-37997	15064	171
Trunnion Bushing		12005	164
Trunnion Bushing	25154319 / 10QK219P2 / 10QK276 / 40-367PU / R303275A / R307479 / MIB219 / MIB219UB / MIB276 / E-3275A / E-7479 / D62 / 325-118 / 325-118U / 325-120 / 325-120U / M2113 / 09-7579 / 09-7583 / MSB684 / MSB684UB / MA10000	12015	164
Trunnion Bushing	10QK130P1 / R302924A / R307441 / MIB130L / MIB130LUB / E-2924A / E-7441 / D063 / D63 / 325-115 / 325-115U / 09-7581 / MSB506L / MSB506LUB / MA20000	12028	165
Trunnion Bushing	10QK219 / 10QK219P1 / R302921A / R307478 / MIB130S / MIB130SUB / E-2921A / E-7478 / D61 / 325-117 / 325-117U / MSB506S / MSB506SUB / PL1090	12029	165
Trunnion Bushing Kit	25154319 / 10QK219P2 / 10QK276 / SK50341	12037	166
Trunnion Bushing Kit	10QK130P1 / SK50342	12038	166

STEMCO GAFF replacement parts compatible with: MACK® SS34 & 38 SERIES

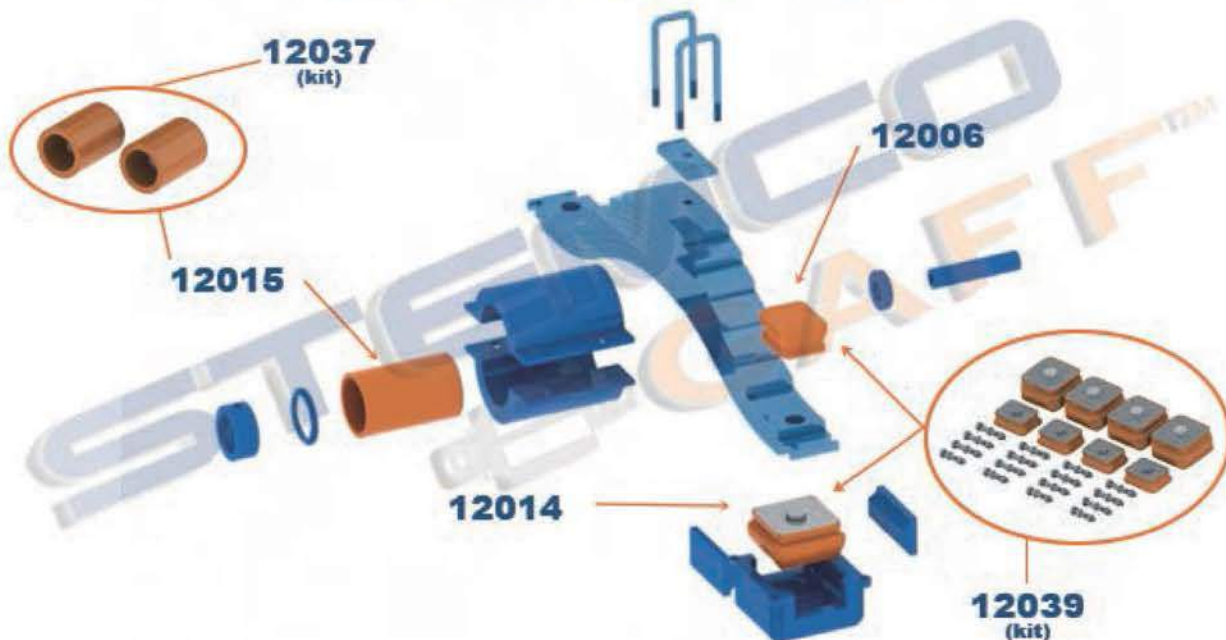

STEMCO GAFF replacement parts compatible with:
MACK® SS50C, SS58C, SS65C-W SERIES

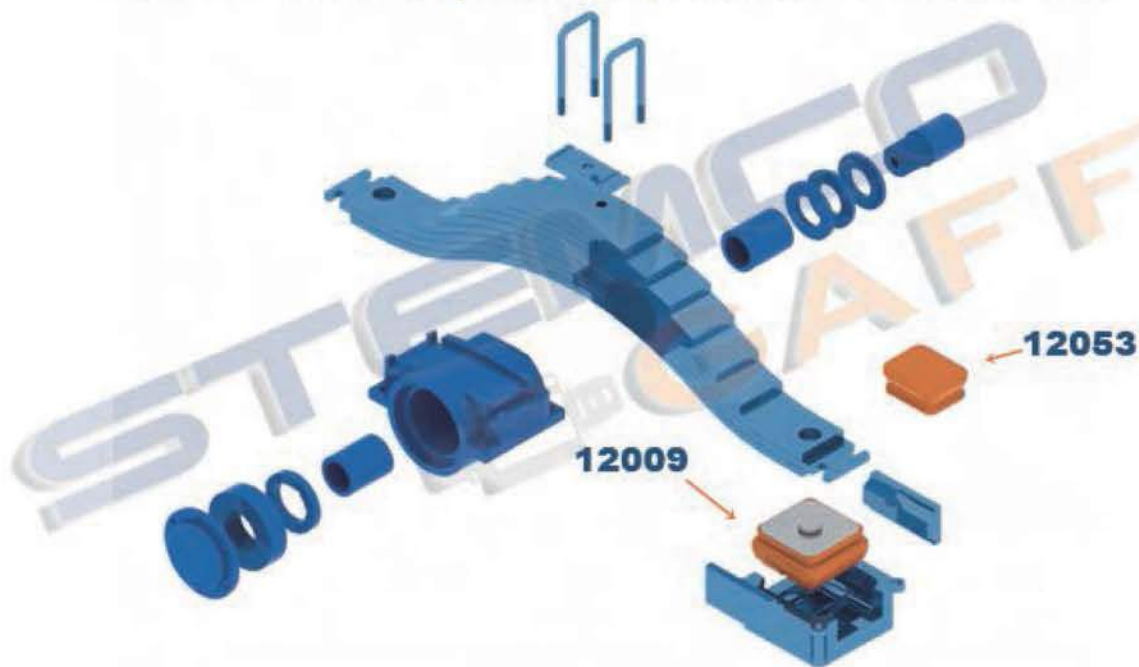

STEMCO GAFF replacement parts compatible with:
MACK® SWS 573 SERIES

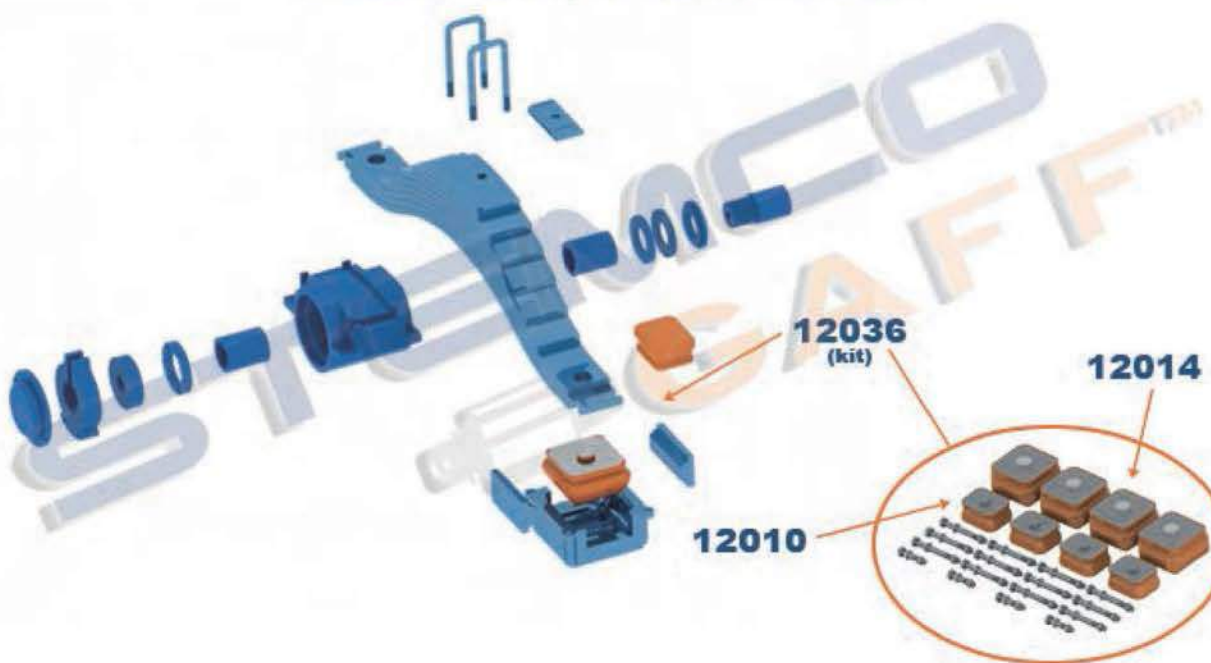

Mack continued

10079

Fifth Wheel Bushing

OD	3 3/16"
ID	1 1/4"
LG	2 11/16"
LG2	2 5/16"
HD	80A

OEM

3065-BSH109L
3065-BSH172U
FW99-32109
FW99-32172

Notes: components not sold separately

11004

Torque Rod Bushing

OD	2 1/16"
LG	6 5/8"
C-C	4 3/8"
BH	5/8"
HD	80A

INCLUDED IN:
11078, 11081, 11769

TOOLS 11071, 18836

OEM

47691
20-836PU
R305275
HS44
E-5275
D405
321-223
321-223U
TRB6185
TRB6185UB

Notes: rib style / 11006 - oversized / 12051 - grooved for torque rod with a center rib / 13521 - chamfered

11080

Torque Rod Assy

LG ²	8 1/16"
C-C	24
BC-C	4 3/8"
BH	5/8"
HD	80A

INCLUDES

QTY 1	11754
QTY 1	13520
QTY 1	13518

OEM

25164994
17QF455P240
945381
TR59-41376

Notes:

11109

Hood Latch Hook

LG	3 13/16"
HD	71D

OEM

17QM263A
HLK2001

Notes:

11544

Hood Hinge Bushing

OD	1 3/4"
OD<	1 1/4"
ID	1/2"
LG	1 1/4"
HD	80A

OEM

20QL231P1
40-312
D542
329-205U
PL1107

Notes:

11545

Hood Guide

OD	3 3/16"
OD<	1 1/2"
LG	5 1/4"
THR	1/2" - 13 UNC
HD	80A

OEM

25QM-31
35-555PU
R307467
UM1104
E-7467
D26
329-129U
M17402
M17402UB
M17527

Notes:

11611

Shifter Bushing Kit

OD	1 1/2"
ID	13/16"
LG	2 5/16"
BH	3/4"
HD	90A

OEM

3088-K3399
MS99-63399

Notes:

11711

Pivot Bushing

OD	5 1/2"
ID	1 1/2"
LG	6 3/4"
HD	80A

OEM

2974-1117680B060
2974-1117680B070
2974-1117680B075
321-338
321-368
RD1170
RD1175
PB85-360B0

Notes:

11747



Rebound Roller Kit

OD	2 1/2	~
ID	9/16	~
LG	3 5/8	~
HD	80A	

OEM
10QK269AM

INCLUDES

QTY 1	Roller
QTY 1	Bolt
QTY 2	Flat Washer
QTY 1	Metal Sleeve
QTY 1	Lock Nut

Notes: components not sold separately

11751



Torque Rod Assy

C-C	24	~
B C-C	4 3/8	~
HD	80A	

OEM
25164946
17QF460P240
1RY39307P13
5435-947794
925030
TR59-41375

INCLUDES

QTY 1	11754
QTY 2	13520

Notes:

11758



Spring Pin Bushing

OD	1 3/4	~
C-C	5 3/4	~
HD	80A	

OEM
4QK3370
50-275
TB68
327-434
50-275
TB-68
M5212
SP59-11010

INCLUDED IN:
11757

TOOL 40090

Notes:

12000



Motor Mount

OD	3 1/4	~
OD<	2	~
ID	3/4	~
LG	1 5/32	~
HD	80A	

OEM
20QL1118A
20QL1175
40-307PU
R307477
UM1204
E-7477
D60
329-109U
M1
M1UB

INCLUDED IN:
12034, 12035

Notes:

12001



Radiator Mount

OD	2 3/8	~
OD<	1 3/8	~
ID	1 1/4	~
ID<	5/8	~
LG	1 5/8	~
HD	80A	

OEM

Notes:

12002



Motor Mount

OD	3 1/2	~
OD<	2 1/4	~
ID	7/8	~
LG	3	~
HD	80A	

OEM
20QL2110
20QL258
40-357
M5
D-280
M5UB

Notes: components not sold separately

12003



Motor Mount Rear

OD	3 1/2	~
ID	1 3/8	~
LG	1 1/16	~
HD	80A	

OEM

Notes:

12004



Cab Mount

OD	2 5/8	~
OD<	1 3/8	~
ID	5/8	~
LG	1 1/2	~
HD	80A	

OEM
20QL2101
FMT4582
40-302
D143
329-169U

Notes: components not sold separately

Mack continued

12005

Trunnion Bushing

OD	4 11/16"	
ID	3 7/16"	
LG	6 1/2"	
HD	80A	

OEM

Notes: superseded by 12015

12006Load Pad
Upper

WD	4 1/2"	
LG	6"	
HGT	2 3/8"	
Dowel	1 3/4"	
HD	80A	

INCLUDED IN:
12039, 12040**OEM**

25121508
10QK365A
40-322PU
R302917
R307481
MP1
MP10
E-2917
E-7481
D285

Notes:

12009Load Pad
Lower

WD	7"	
LG	7"	
HGT	4"	
Dowel	2"	
HD	80A	

INCLUDED IN:
12040**OEM**

10QK372
10QK389
40-345PU
R303680
MP6
MP8
MP8UB
E-3680
D284
325-114

Notes:

12010Load Pad
Upper

WD	5 3/16"	
LG	6 1/2"	
HGT	3"	
Dowel	1 3/4"	
HD	80A	

INCLUDED IN:
12036**OEM**

25115012
10QK370
40-336PU
R302919
R308667
MP4
E-2919
E-8667
D288
325-113

Notes:

12014Load Pad
Lower

WD	6"	
LG	6"	
HGT	3 3/4"	
Dowel	1 3/4"	
HD	80A	

INCLUDED IN:
12036, 12039**OEM**

21036254
25125064
10QK36B
10QK36C
10QK388
10QK86B
40-328
R302920
R307480
MP2

Notes:

12015

Trunnion Bushing

OD	4 11/16"	
ID	3 7/16"	
LG	6 1/4"	
HD	80A	

INCLUDED IN:
12037**OEM**

25154319
10QK219P2
10QK276
40-367PU
R303275A
R307479
MIB219
MIB219UB
MIB276
E-3275A

Notes: supersedes 12005

12017Motor Mount
Front

OD	5 13/16"	
THK	5/8"	
WD	1 1/4"	
HGT	2 7/8"	
HD	80A	

OEM

20QL1166
D145
329-171U
M3
M3UB
PL1109

Notes: single piece

12023Motor Mount
Rear

OD	3 5/8"	
OD<	2 5/16"	
ID	7/8"	
LG	1 15/16"	
HD	80A	

OEM

20QL324M
40-356
R307641
UM1219
E-7641
D66
329-114U
M2
PL1091

Notes:

12026



Radiator Mount

OD	2 1/2"
ID	3 5/8"
LG	2 1/2"
HD	80A

OEM
25121334
20QL295
20QL295M
D142
329-211
MM62-62334

Notes: components not sold separately

12028



Trunnion Bushing

OD	4 7/16"
ID	3 7/16"
LG	8 3/8"
HD	80A

INCLUDED IN:
12038

OEM
10QK130P1
R302924A
R307441
MIB130L
MIB130LUB
E-2924A
E-7441
D063
D63
325-115

Notes:

12029



Trunnion Bushing

OD	4 11/16"
ID	3 7/16"
LG	5 5/8"
HD	80A

OEM
10QK219
10QK219P1
R302921A
R307478
MIB130S
MIB130SUB
E-2921A
E-7478
D61
325-117

Notes:

12031



Torque Rod Bushing

OD	2 3/4"
LG	7"
THR	1 1/2" - 12 UNF
HD	80A

INCLUDED IN:
12042, 12072

OEM
46735
1688-229240
R302815
R309518
C884
E-2815
E-9518
D293
D293S
321-136

Notes:

12032



Radiator Mount

OD	1 7/8"
ID	9/16"
LG	1 13/16"
HD	80A

OEM
20QL259A
40-308
D64
329-165U

Notes: components not sold separately

12034



Motor Mount Kit

INCLUDES
QTY 8 12000
QTY 4 Bolt 3/4" - 16 UNF x 6 1/2" G8
QTY 4 Lock Nut 3/4"
QTY 8 Flat Washer 3/4"
QTY 8 Flat Washer 3 7/16"

OEM
204SX216
KT62-62216

Notes:

12035



Motor Mount Kit Fuller Transmission

INCLUDES
QTY 8 12000
QTY 4 Bolt 3/4" - 16 UNF x 5" G8
QTY 4 Lock Nut 3/4"
QTY 8 Flat Washer 3/4"
QTY 8 Flat Washer 3 7/16"

OEM
204SX389
KT62-62389

Notes: compatible with Fuller Transmission

12036



Load Pad Kit 380/440

INCLUDES
QTY 4 12010
QTY 4 12014
QTY 1 12081 - Bolt Kit
4 - Bolts 3/4" x 4" UNC
12 - Bolts 3/4" x 6" UNF
12 - Lock Nuts 3/4" UNF
16 - Flat Washers 3/4"

OEM
21036254
25115012
10QK36B
10QK370
SK50380-HW

Notes:

Mack continued

12037**INCLUDES**
QTY 2

12015

OEM25154319
10QK219P2
10QK276
SK50341

Trunnion Bushing Kit

Notes:

12038**INCLUDES**
QTY 2

12028

OEM10QK130P1
SK50342

Trunnion Bushing Kit

Notes:

12039**INCLUDES**QTY 4 12006
QTY 4 12014
QTY 1 12083 - Bolt Kit
4 - Bolts 7/8 x 4 UNC
12 - Bolts 7/8 x 5 UNF
12 - Lock Nuts 7/8 UNF
16 - Flat Washers 7/8**OEM**21036254
10QK1065A
10QK86B
SK50340-HWLoad Pad Kit
340

Notes:

12040**INCLUDES**QTY 4 12006
QTY 4 12009
QTY 1 12082 - Bolt Kit
4 - Bolts 7/8 x 4 UNC
12 - Bolts 7/8 x 7 1/2 UNF
12 - Lock Nuts 7/8 UNF
16 - Flat Washers 7/8**OEM**25121508
10QK365A
10QK372
10QK389
40-322PU
40-345PU
MP1
MP6
MP8
MP8UBLoad Pad Kit
380/440

Notes:

12041OD
C-C
HD1 7/8 ~
5 7/16 ~
80A**OEM**10QK254M
22QK39301
E315-62
RB189
330-102
RB-189
M876
MR624
SK62-10600
SP62-1154M

Spring Pin Bushing

Notes:

12042LG
C-C
BC-C
BH
THR7 ~
26 ~
4 3/8 ~
5/8 ~
1 1/2 -12 UNF**OEM**

SK27771

Torque Rod Assy
Weldable

Notes:

INCLUDESQTY 1 13590
QTY 1 13520
QTY 1 12031**12043**OD
ID
C-C
HD1 7/8 ~
1 ~
3 1/2 ~
80A**OEM**10QK253M
171AM8
43RU297M
B1424-62
LNC24MM
RB188
327-481
334-717
RB-188
M5316

Spring Bushing

Notes:

12045WD
C-C
BH
HGT
HD2 1/2 ~
7 1/4 ~
5/8 ~
2 1/2 ~
70A**OEM**25164809
25172757
20QL322
20QL329
MM62-62002
MM62-62322
MM62-62329Motor Mount Kit
Front

Notes:

12046



Motor Mount Front

OD	2 5/8"
ID	1 11/16"
C-C	1 1/16"
HD	70A

INCLUDED IN:
12046

OEM
20QL312M2
D65
M9UB
PL1131

Notes:

12047



Motor Mount Kit Front

OD	2 5/8"
ID	5/8"
C-C	1 1/16"
HD	70A

INCLUDES
QTY 2 12046
QTY 1 Metal Sleeve

OEM
20QL312M2
D065
D65
PL1131

Notes: includes bushing sleeve OE 73RU12254

12048



Radiator Mount

OD	1 5/8"
ID	1"
C-C	1 3/4"
HD	80A

OEM
20QL1170
20QL251
PB62-65251

Notes:

12049



Air Cooler Mount

OD	1 1/4"
ID	3/8"
LG	1 1/16"
HD	70A

OEM
20QL37P3
40-341

Notes:

12051



Torque Rod Bushing

OD	2"
C-C	4 3/8"
BH	5/8"
HD	80A

OEM
SS-R0035P240
321-519
TRB6199

TOOL 18836

Notes: grooved for torque rod with a center rib / 11004 - rib style / 11006 - oversized / 13521 - chamfered / additional tool suggestion 11071

12052



Cab Mount

ID	13/16"
WD	2 1/4"
LG	6"
C-C	4 21/32"
HGT	3 7/8"
HD	70A

OEM
30QS3479AM

Notes:

12053



Load Pad

WD	6 13/64"
LG	7 7/16"
HGT	3 3/4"
DOWEL	1 1/2"
HD	80A

OEM
10QK32BP1
R303679
MP5
E-3679
D283
325-108
325-108U
09-7597
ABP5
MA32000

Notes:

12054



Torque Rod

ID	2 3/4"
C-C	18 1/8"

OEM

Notes:

Mack continued

12069C-C 21 -
BC-C 4 3/8 -
BH 5/8 -**INCLUDES**
QTY 2 13520**OEM**25170832
17QF460P210
17QF473M2
17QF474P209
TR62-413M2

Torque Rod Assy

Notes:

12070C-C 20 -
BC-C 4 3/8 -
BH 5/8 -**INCLUDES**
QTY 2 13520**OEM**25014582
25170831
251660077
17QF358
17QF359
17QF460P200
17QF473M
TR62-413M3

Torque Rod Assy

Notes:

12071C-C 24 3/16 -
BC-C 4 3/8 -
BH 5/8 -**INCLUDES**
QTY 2 13520**OEM**25170833
17QF261P23
17QF352M2
17QF460P243
17QF473M4
92883-4
TR62-41243

Torque Rod Assy

Notes:

12072LG 7 -
C-C 18 -
BC-C 4 3/8 -
BH 5/8 -
THR 1 1/4 -12 UNF**INCLUDES**
QTY 1 13520
QTY 1 12031**OEM**25162529
17QF251P11
17QF463P180
17QF464P180
1RY48P23
S-13292
FTR-42628-100
FTR-4628-180
FTR-4628A-180
345-222

Torque Rod Assy

Notes:

12073C-C 21 1/2 -
BC-C 4 3/8 -
BH 5/8 -**INCLUDES**
QTY 2 13520**OEM**25174658
17QF460P215
TR62-41215

Torque Rod Assy

Notes:

12074C-C 23 3/4 -
BC-C 4 3/8 -
BH 11/16 -**INCLUDES**
QTY 2 11729**OEM**25160749
25164945
17QF457P238
17QF460P238
924970
942119
943790
945240
TR62-41238

Torque Rod Assy

Notes:

12372WD 3 9/16 -
C-C 8 7/8 -
BH 9/16 -
THR 1/2 UNC
HGT 3 17/32 -
HD 70A**OEM**

20QL338M

Motor Mount
Rear

Notes:

12396C-C 17 5/16 -
BC-C 4 3/8 -
BH 5/8 -**INCLUDES**
QTY 2 13520**OEM**4000-62010455
TR50-42455

Torque Rod Assy

Notes:

13513

OD	2 1/2"
ID	1"
LG	4 1/2"
HD	80A



Equalizer Bushing

OEM
10QK260
30-1302
40-348
RB187
RB-187
M3478
MR620
MR620UB
AT80000

Notes: metal sleeve / verify dimensions compare to 13577 - metal sleeve or 10028 - no sleeve / additional tool suggestion 18833, coming soon 40131

13520

OD	2 3/4"
C-C	4 3/8"
BH	5/8"
HD	80A



Torque Rod Bushing

INCLUDED IN:
Several Kits

OEM
1688-227720
20-833PU
R302226
R307639
C879
C879UB
E-2226
E-4664
E-7639
D423

TOOLS 18551, 18833

Notes: 83520 - easy mount / 13536 - no metal sleeve

13521

OD	2 1/16"
LG	6 5/8"
C-C	4 3/8"
BH	5/8"
HD	80A



Torque Rod Bushing

INCLUDED IN:
11153, 11792, 11795, 12397, 34563

OEM
47691
20-836PU
R305275
HS44
E-5275
D405
321-223
321-223U
TRB6185
TRB6185UB

TOOLS 11071, 18836

Notes: chamfered / 11004 - rib style / 11006 - oversized / 12051 - grooved for torque rod with a center rib

13522

OD	2 17/32"
C-C	4 3/8"
BH	5/8"
HD	80A



Torque Rod Bushing

OEM
1688-227710
20-832PU
R302225
R307638
C878
C878UB
FL55
E-2225
E-7638
D421

TOOLS 18553, 18833

Notes: metal sleeve / easy mount - 83522 / no sleeve - 11003 / additional tool suggestion coming soon 40131

13526

OD	2 3/4"
ID	1"
LG	4 5/8"
HD	80A



Equalizer Bushing

OEM
10QK268M
R305269
R309401
C868
E-5269
E-9401
D425
321-225
321-225U
321-245

Notes:

13536

OD	2 15/16"
C-C	4 3/8"
BH	5/8"
HD	80A



Torque Rod Bushing

OEM
1688-227720
20-833PU
R302226
R307639
C879UB
E-2226
E-4664
E-7639
D423
321-132U

TOOL 18831

Notes: 83520 - easy mount / 13520 - metal sleeve

13597

ID	1 7/8"
C-C	22 1/16"



Torque Rod

OEM
17QF471M5

Notes:

13626

BC-C	4 3/4"
THR	1/2"
HD	80A



Bolster Spring Kit

OEM
4000-64179037
HS130
E-14044
E-14374
334-1727
334-1845
MLC3
MLC5
LP50-24179

Notes: 4 kits per truck / recommended to replace set in same repair / don't mix brands

Mack continued

13634 C-C 22 -



Torque Rod Assy

INCLUDES
QTY 2 11729
QTY 1 13629

OEM
25174706
17QF460P220
943853
TMR547
TR62-41220

Notes:

13649 OD 7 -
ID 1 -
LG 4 -
HD 80A



Overload Cushion

OEM
10QK222
20-823
R302232
R309514
LC4
LC4UB
E-2232
E-9514
D134
325-100

Notes:

13685 OD 2 3/4 -
C-C 4 3/8 -
BH 7/8 -
HD 80A



Torque Rod Bushing

INCLUDED IN:
13689, 13700, 13704

OEM
240530
321-267
TS38875

TOOLS 18851, 18833

Notes: additional tool suggestion coming soon 40131

13733 C-C 14 3/8 -
BC-C 4 3/8 -
BH 5/8 -
THR 1 1/2 - 12UNF



Torque Rod Assy

INCLUDES
QTY 1 13520
QTY 1 13518

OEM
25171605
17QF455P243
4000-62350615
TR50-41615

Notes:

13735 C-C 14 3/8 -
BC-C 4 3/8 -
BH 5/8 -



Torque Rod Assy

INCLUDES
QTY 2 13520

OEM
17QF357M
E-9394
E-9409
345-734
345-792
345-815
TR50-41102

Notes:

14513 OD 3 1/2 -
ID 1 1/8 -
LG 5 1/4 -
HD 80A



Beam End Bushing

OEM
5462-10050
WCM10050
60-1535
R304382A
N120
N120UB
E-4382A
E-8683
D441
321-229

Notes: additional tool suggestion 14531

14533 OD 2 13/16 -
ID 1 1/8 -
LG 5 -
HD 80A



Beam End Bushing

OEM
5462-11223
60-1501
R304410A
N124
E-4410A
D448
321-231
321-231U
M3454
TRB5703

Notes: supersedes 14528 / additional tool suggestion 14531

15009 OD 3 1/16 -
OD< 1 13/16 -
ID 1 1/16 -
LG 2 7/8 -
HD 80A



Torque Rod Bushing

INCLUDED IN:
15062

OEM
10QK231
3QK2171K15
55-134PU
R301964
R127
E-8689
321-157U
M1751
TRB6062

Notes:

Mack continued

15064



Torque Rod Bushing Kit

Notes: compatible with Reyco 21B

INCLUDES		
QTY 2	15073	
QTY 1	Bolt 1" - 14 UNF x 7"	
QTY 1	Nut 1" - 14 UNF	
QTY 2	Flat Washers	
	1" x 1/4" THK	

OEM	
7014-TK19089	
R301983	
R001	
R003	
E-1312	
E-1983	
E-9545	
334-252	
334-252U	
334-253	

17501



Camshaft Bushing

Notes:

OD	1 7/8"	
ID	1 1/2"	
LG	1 3/16"	
HD	71D	

OEM	
80AX641	
E-5512	
02-210	

18215



Fifth Wheel Bushing

Notes: no groove / verify dimensions compare to 18094

OD	2"	
ID	1 1/8"	
LG	4 1/4"	
HD	80A	

OEM	
3889-XB0011	
FW51-32011	

18221



Fifth Wheel Bushing

Notes:

OD	3 1/2"	
ID	1 1/4"	
LG	3 3/4"	
HD	80-71A	

OEM	
3889-XB0009	
KP116	

18566



Shock Absorber Bushing

Notes:

OD	1 7/8"	
ID	1"	
LG	1"	
HD	80A	

OEM	
14QK136	
A1601005002	
663400	
401754	
73D2002	
900 08 003	
02-00377	
985211	
90.8003	
90.8004	

18837



Radiator Mount

Notes:

OD	2"	
OD<	1 5/16"	
ID	5/8"	
LG	1 1/4"	
HD	80A	

OEM	
20QL231P1	
20QL231P12	
40-312	
40-354	
D542	
329-205U	
PL1107	

18860



Torque Rod Assy

Notes:

C-C	22 1/8"	
BC-C	4 3/8"	
BH	5/8"	
HD	80A	

INCLUDES	
QTY 1	18859
QTY 2	13520

OEM	
30SQ4525	
75-1709	
VT20	
E-8821	
345-219	
345-898	
TMR531	
TMR63	
TR96-41068	

31592



Beam End Bushing

Notes:

OD	3 7/8"	
ID	2 1/2"	
LG	5 1/4"	
HD	80A	

OEM	
24SU21	
R304252	
N111	
D433	

Mack continued

34555

LG	8 1/4"
C-C	25 1/4"
BC-C	4 3/8"
BH	5/8"
THR	1 1/4" - 12 UNF

INCLUDES
QTY 1 13520
QTY 1 13518

OEM
4000-62350645
TR50-41645



Torque Rod Assy

Notes:

34556

C-C	23 1/4"
BC-C	4 3/8"
BH	5/8"

INCLUDES
QTY 2 13520

OEM
4000-62000590
4000-62001590
924920
942174
944160
944220
948574
TR50-42590



Torque Rod Assy

Notes:

40035

OD	3 7/8"
OD<	2 5/16"
ID	1 5/32"
LG	2 1/16"
HD	80A

OEM
3889-XB10605
FW99-32605



Fifth Wheel Bushing Kit

Notes: components not sold separately

40074

ID	2 3/8"
C-C	8 1/2"
BH	1/2"
HGT	3 21/64"
HD	70A

OEM
203SJ13
210661-1X
DS-6049



Carrier Bearing Assy

Notes: includes carrier bearing bushing 18002

40075

ID	2"
C-C	7 7/16"
BH	1/2"
HGT	2 25/32"
HD	70A

OEM
2101211X
DS-6048



Carrier Bearing Assy

Notes: includes carrier bearing bushing 18725

50033

INCLUDES
QTY 2 34514
QTY 1 Pivot Bolt 7/8" - 16 UNF x 6 G8
QTY 1 Lock Nut 7/8"
QTY 1 Flat Washer 7/8"
QTY 1 Sleeve 1 1/2" x 7/8" x 3"

OEM
8446-R005422
E-11763
334-1672
TRK4931
PB00-26422
SU99-39115



Torque Rod Bushing

Notes: coming soon call tech department

83520

OD	2 3/4"
C-C	4 3/8"
BH	5/8"
HD	80A

OEM
1688-227720
20-833PU
R302226
R307639
C879
C879UB
E-2226
E-4664
E-7639
D423



Easy-Mount Torque Rod Bushing

TOOLS 18551, 18833

Notes: standard - 13520 / no metal sleeve - 13536

83522

OD	2 17/32"
C-C	4 3/8"
BH	5/8"
HD	80A

OEM
1688-227710
20-832PU
R302225
R307638
C878
C878UB
FL55
E-2225
E-7638
D421



Easy-Mount Torque Rod Bushing

TOOLS 18553, 18833

Notes: easy mount / metal sleeve - 13522 / no metal sleeve - 11003

DESCRIPTION	OEM	PART ID	PAGE
Axle Pad	91028039 / N244 / 325-200 / 09-4438 / AW57-10000	14505	184
Axle Pad	91028051 / 60-1507 / N247 / E-2945 / E-8679 / D356 / 325-141 / M1486 / 09-4433 / M8358 / AW57-12000	14509	184
Axle Pad	91028013 / 91028089 / 60-1527 / 60-1546PU / R301330 / R308669 / R308670 / N254 / E-1330 / E-8669 / E-8670 / D231 / D352 / 325-139U / 325-142 / 325-142U / 09-4424 / MTN456 / MTN457 / PL1041	14522	185
Beam End Adapter	496530 / 45000-007 / 1307564B000 / 20-800 / HAK38 / E-2374 / 334-109 / HAK100	13507	182
Beam End Adapter Kit	90001002 / 20-801 / R309420 / HAK44 / E-9420 / 334-127 / 334-467 / 09-5462 / HAK112 / AK38200	13609	183
Beam End Bushing	90008002 / 60-1540PU / N109 / E-2940 / E-8677 / D240 / 325-235U / M2118 / 09-4410 / TRB5721	14504	184
Beam End Bushing	90008131 / 60-1532 / R304255 / R307485 / N119 / N119UB / E-4255 / E-7485 / D235 / 321-227 / 321-227U / M3265 / TRB5710 / TRB5710UB / PL1154	14510	184
Beam End Bushing	90008139 / 60-1535 / R304382A / N120 / N120UB / E-4382A / E-8683 / D441 / 321-229 / 321-229U / M3456 / TRB5713 / PB57-21139	14513	185
Beam End Bushing	90008151 / 60-1539 / R309292 / N320 / E-9292 / D440 / 321-314 / TRB5719	14514	185
Beam End Bushing		14530	186
Beam End Bushing	90008005 / N110 / E-2936 / 321-178 / TRB5712	14532	186
Beam End Bushing	90008149 / 60-1501 / R304410A / N124 / E-4410A / D448 / 321-231 / 321-231U / M3454 / TRB5703 / PB57-21149	14533	186
Beam End Bushing	900-08-006 / R304252 / N111 / D433	31592	186
Center Bushing	90008104 / 60-1502 / R304254 / N115 / E-4254 / 321-228 / TRB5704	14526	185
Center Bushing	90008008 / 900 08 008 / 60-1531PU / R304253 / R308681 / N112 / N112UB / E-4253 / E-8681 / D237 / 321-237 / 321-237U / M3453 / TRB5709 / PL1155	14527	185
Center Bushing	90008148 / 60-1501 / R304410A / N124 / E-4410A / 321-231 / TRB-5703	14529	186
Shock Absorber Bushing	900 08 003 / 40-340 / R307529 / HB593 / SB1UB / E-7529 / D1 / 320-153 / 320-153U / M695 / M-17526UB / MH1432 / MH1432UB / PL1026	18566	186
Suspension Bushing	90008247	50046	186
Suspension Bushing Kit	48100394 / SRK-530	50047	186
Torque Rod Assy	5550317 / 50-1428 / PB33 / E-5083 / 345-211 / 947790 / R520 / TR75-41327	12395	182
Torque Rod Assy	577 50 343 / 50-1437 / PB46 / E-7853 / 345-215 / TR75-41108	12398	182
Torque Rod Bushing	57750252 / M2069	11556	182
Torque Rod Bushing	57750262 / 20-885 / R303411 / RBT207 / E-3411 / D312 / 321-144 / 321-144U / M-3262 / 09-5518 / TRB6260 / TRB6260UB / IN35180	13515	183
Torque Rod Bushing	57750211 / 20-876 / R302816 / C881 / E-13967 / E-2816 / 321-137 / M2088 / 09-5716 / TRB6181 / TH50000	13516	183
Torque Rod Bushing	57750261 / 20-834 / R302814 / R309517 / C880 / E-13964 / E-2814 / E-9517 / D406 / 321-135 / M2087 / TRB6118 / TS49000	13517	183
Torque Rod Bushing	57750233 / 20-831PU / R302228 / R308651 / C883 / C883UB / E-2228 / E-8651 / D422 / 321-133 / 321-133U / M2072 / 09-5721 / TRB6112 / TRB6112UB / TT38000	13518	183
Torque Rod Bushing	57750258 / 20-851PU / R303868 / C889 / E-3868 / D424 / 321-265 / 321-265U / TRB6822 / TRB6822UB / TS38750	13528	183
Torque Rod Bushing	57750233 / 20-831PU / R302228 / E-2228 / D422 / M2072 / 09-5721 / TRB6112 / TT38000	13533	183
Torque Rod Bushing	57750230 / R302227 / C885 / E-2227 / 321-134 / M2071 / 09-5720 / TRB6116 / TT34000	13684	183
Torque Rod End Assy	90044638 / 20-9023 / MR681 / UR681 / E-10317 / 345-681 / 928681 / 09-5426 / R681 / TR76000	13695	184
Trunnion Bushing	91008023 / NP508 / 325-195 / M1489 / 09-4420	14500	184
Trunnion Bushing	91008024 / NP508-1 / 325-218 / 09-4429	14501	184
Trunnion Bushing	91008004 / 91008005 / R304250 / N331 / N332 / E-7443 / 325-204 / 09-4870 / 09-4871	14502	184
Trunnion Bushing	91008022 / 60-1541 / R301332 / R307486 / N215 / N215UB / E-1332 / E-7486 / D232 / 325-137 / 325-137U / M1706 / 09-4422 / TRB5909 / NW30000	14521	185
Trunnion Bushing	91008006 / N211 / E-5080 / 322-146	14523	185
Trunnion Bushing	91008033 / R305081 / N217 / E-5081 / 322-147	14524	185

STEMCO GAFF replacement parts compatible with:
NEWAY® AD-123/246 -6.5, -8.75, -10 SERIES

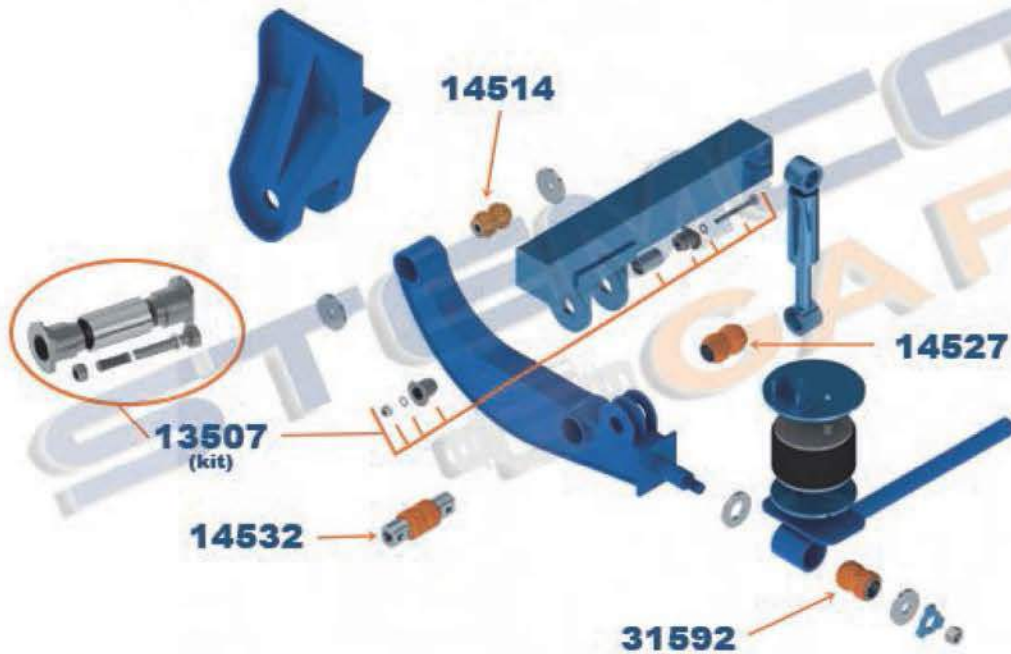

STEMCO GAFF replacement parts compatible with:
NEWAY® AR-41, AR-45, AR-45-1, AR-70-9, -14,
AR-75-6, -9, AR-80 -6.75, -9, -9-WST, AR-85-A,
AR-95-9, -12, -14, -17, SERIES



STEMCO GAFF replacement parts compatible with:
NEWAY® AR-50-US, AR-50-US-F, AR-50-US-F-1,
AR-50-US-F-2, AR-51-US SERIES



STEMCO GAFF replacement parts compatible with:
NEWAY® (AR-90-14, -15, -16, -17)
(AR-92-12, -14, -15, -16, -17, -18) -
(AR-93 -14, -15, -16, -17) - SERIES

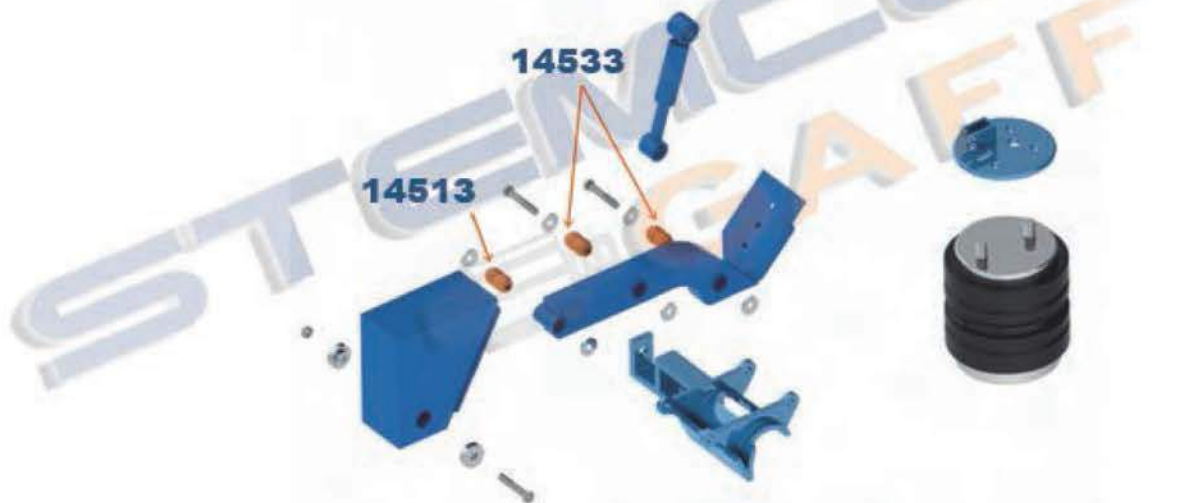

**STEMCO GAFF replacement parts compatible with:
NEWAY® ARD-234-6 SERIES****STEMCO GAFF replacement parts compatible with:
NEWAY® ARD-125, -6, -8, -244-6, -8
ARD-125-6, -244-6 SERIES**

STEMCO GAFF replacement parts compatible with:
NEWAY® ARDST/ARDSTM & L SERIES,
MODELS -123-6, -244-6, -246-6

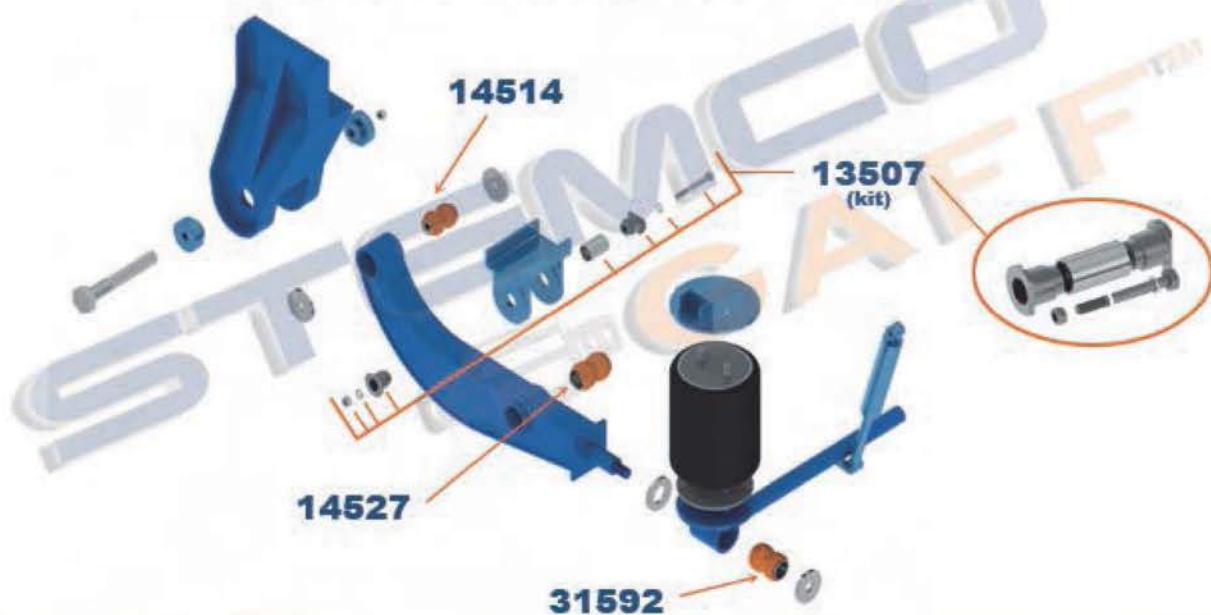

STEMCO GAFF replacement parts compatible with:
NEWAY® ARL-20-D & ARL-20-D-US SERIES

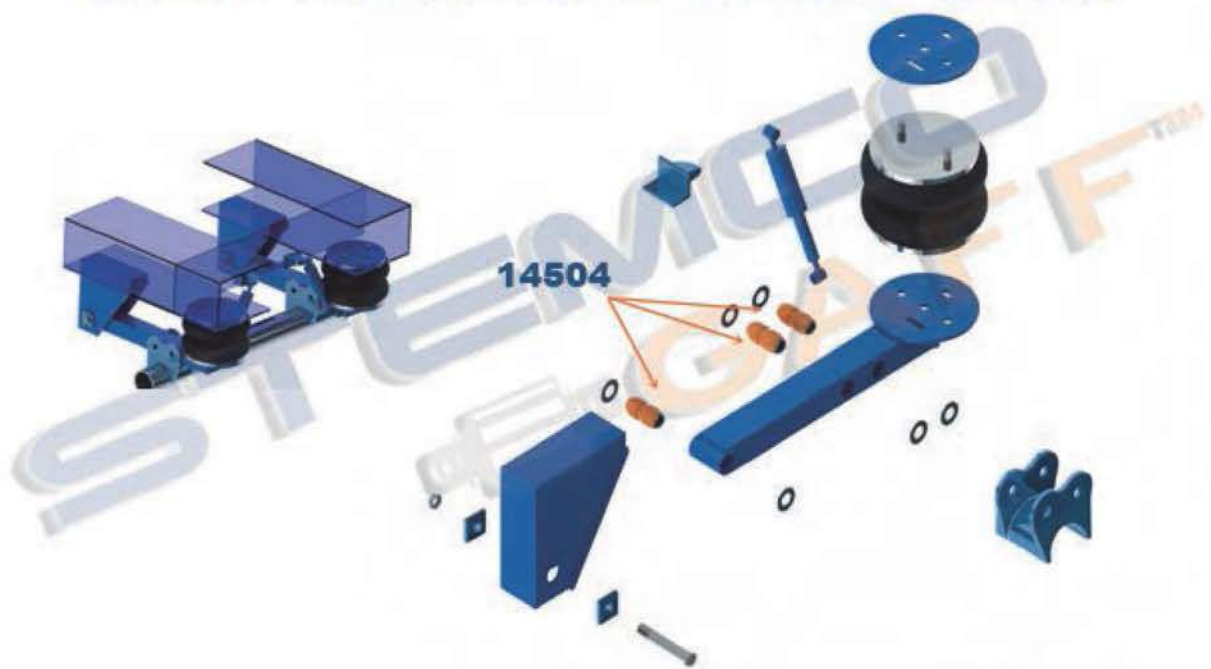

STEMCO GAFF replacement parts compatible with:**NEWAY® ART-500-US,
ART-551-US-1, -2, -3 SERIES****STEMCO GAFF replacement parts compatible with:****NEWAY® ART-500-B, ART-551-B-1, -2, -3 SERIES**

**STEMCO GAFF replacement parts compatible with:
NEWAY® ART-500-US-A SERIES**



**STEMCO GAFF replacement parts compatible with:
NEWAY® ART-505-B, B-1, ART-555-B-1, -2, -3
ART-500-US-A ART-500-B, ART-551-B-1, -2, -3 SERIES**



STEMCO GAFF replacement parts compatible with:
NEWAY® ARU-93-6, -7, -8, -9, -10 SERIES
ARU-92-8, -9, -10, -12 SERIES

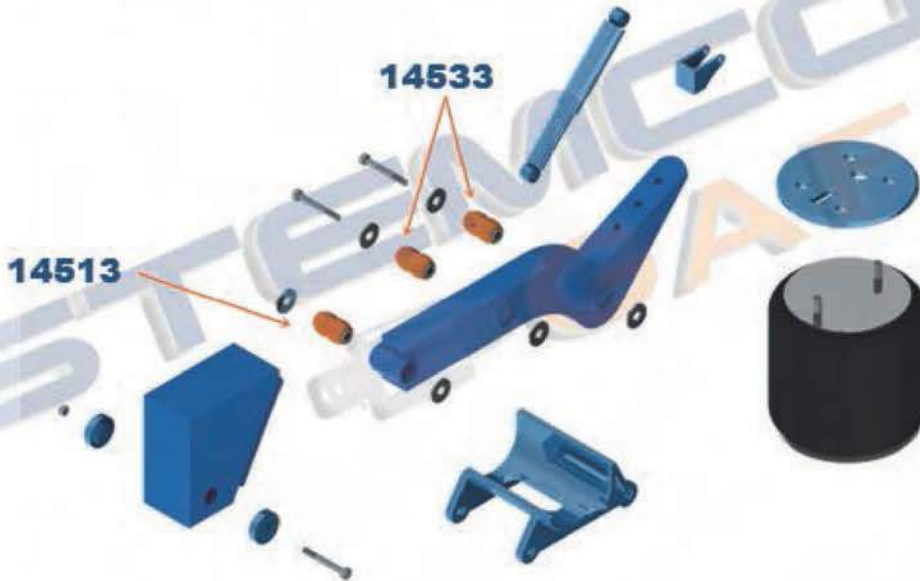

STEMCO GAFF replacement parts compatible with:
NEWAY® RL-196 SERIES



STEMCO GAFF replacement parts compatible with:
NEWAY® RL-196, RL-228-14, -15, -16, -17,
RL-196A SERIES



STEMCO GAFF replacement parts compatible with:
NEWAY® SB-360B-H-DA SERIES
SB360B/500B/600B/660HDA SERIES



STEMCO GAFF replacement parts compatible with:
NEWAY® TRI-AXLE
T/TR8540/8600/8750/8900 SERIES

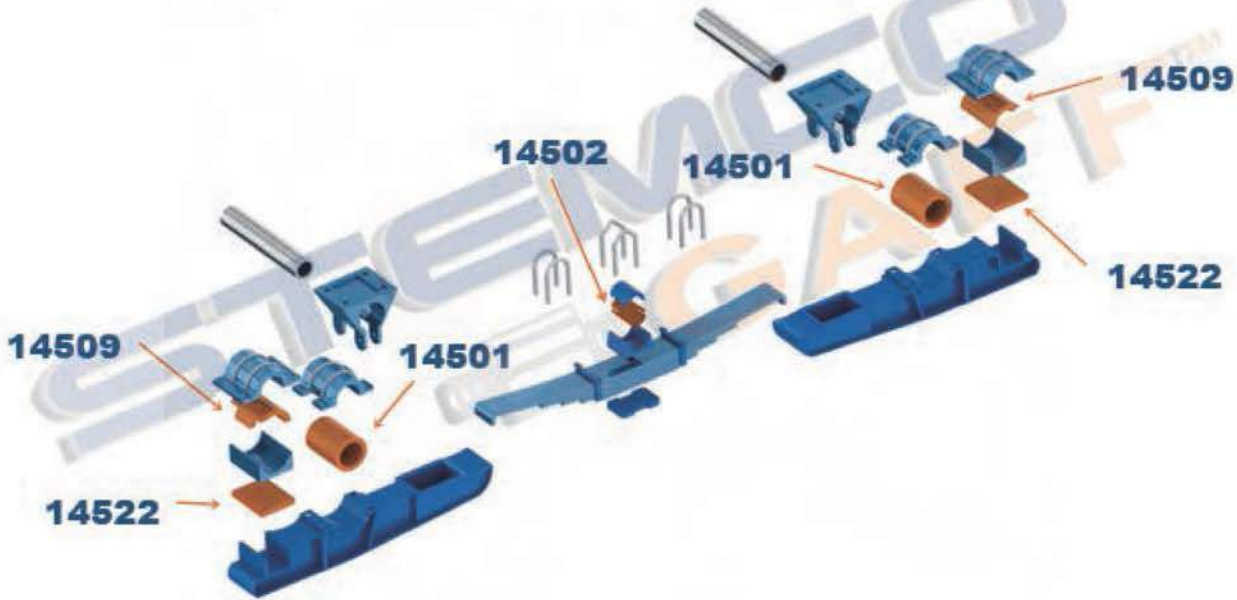

11556



Torque Rod Bushing

OD	2 11/16"
C-C	4 3/8"
BH	5/8"
HD	80A

OEM
57750252
M2069

Notes: verify dimensions compare to 13522 and 83522

12395



Torque Rod Assy

C-C	17 5/16"
BC-C	4 3/8"
BH ⁽¹⁾	5/8"
BH ⁽²⁾	3/4"

INCLUDES
QTY 1 13528
QTY 1 13520

OEM
5550317
50-1428
PB33
E-5083
345-211
947790
TMR520
TR75-41327

Notes:

12398



Torque Rod Assy

C-C	25 9/16"
BC-C	4 3/8"
BH	5/8"

INCLUDES
QTY 2 13520

OEM
577 50 343
50-1437
PB46
E-7853
345-215
TR75-41108

Notes:

13507



Beam End Adapter

OD	3 1/2"
OD<	2 1/2"
LG	8"

INCLUDED IN:
13509, 13574, 13587

OEM
496530
45000-007
1307564B000
20-800
HAK38
E-2374
334-109
HAK100

Notes: used with 13506, 13508, 13553, 13591

13515



OD	3	~
C-C	5 11/16	~
BH	13/16	~
HD	80A	

OEM
57750262
20-885
R303411
RBT207
E-3411
D312
321-144
321-144U
M-3262
09-5518

Torque Rod Bushing

TOOL 18831

Notes: additional tool suggestion 13585

13516



OD	2 3/4	~
ID	1 1/8	~
LG	3 1/4	~
HD	80A	

OEM
57750211
20-876
R302816
C881
E-13967
E-2816
321-137
M2088
09-5716
TRB6181

Torque Rod Bushing

INCLUDED IN:
13688, 13698, 13699

TOOL 18833

Notes: additional tool suggestions 18551, coming soon 40131

13517



OD	2 3/4	~
C-C	5 11/16	~
BH	13/16	~
HD	80A	

OEM
57750261
20-834
R302814
R309517
C880
E-13964
E-2814
E-9517
D406
321-135

Torque Rod Bushing

INCLUDED IN:
13687

TOOL 18833

Notes: additional tool suggestions 18551, coming soon 40131

13518



OD	2 3/4	~
LG	8 1/16	~
THR	1 1/4 - 12 UNF	~
HD	80A	

OEM
57750233
20-831PU
R302228
R308651
C883
C883UB
E-2228
E-8651
D422
321-133

Torque Rod Bushing

INCLUDED IN:
11794, 11808, 13657, 13679,
13686, 13694, 13695, 34555

TOOLS 13584, 18833

Notes: metal sleeve/ 13533 - no sleeve / additional tool suggestion 18551, coming soon 40131

13528



OD	2 3/4	~
C-C	4 3/8	~
BH	3/4	~
HD	80A	

OEM
57750258
20-851PU
R303868
C889
E-3868
D424
321-265
321-265U
TRB6822
TRB6822UB

Torque Rod Bushing

INCLUDED IN:
12395, 13701, 13702, 13703

TOOLS 18833, 18551

Notes: additional tool suggestion coming soon 40131

13533



OD	2 15/16	~
LG	8 1/16	~
THR	1 1/4 - 12 UNF	~
HD	80A	

OEM
57750258

Torque Rod Bushing

TOOL 18831

Notes: 13518 - metal sleeve

13609



OD	3 1/2	~
OD<	1 1/8	~
LG	8 11/16	~
HD	Steel	

OEM
90001002
20-801
R309420
HAK44
E-9420
334-127
334-467
09-5462
HAK112
AK38200

Beam End Adapter Kit

INCLUDED IN:
13566

Notes: supersedes 13540 / for use with 13506

13684



OD	2 3/4	~
LG	6 5/8	~
THR	1 1/4 - UNF	~
HD	80A	

OEM
57750230
R302227
C885
E-2227
321-134
M2071
09-5720
TRB6116
TT34000

Torque Rod Bushing

INCLUDED IN:
13692, 13693

TOOLS 13584, 18833

Notes: additional tool suggestions 18551, coming soon 40131

Neway continued

13695Torque Rod End Assy
27" Rod End

LG	25	7/16"
LG ²	8	1/16"
THR	1 1/4"	12 UNF
HD		80A

INCLUDES

QTY 1	13682
QTY 1	13518

OEM

90044638
20-9023
MR681
UR681
E-10317
345-681
928681
09-5426
TMR681
TR76000

Notes:

14500

Trunnion Bushing

OD	4	1/2"
ID	3	1/2"
LG	8	3/4"
HD		80A

OEM

91008023
NP508
325-195
M1489
09-4420

Notes:

14501

Trunnion Bushing

OD	4	1/2"
ID	3	1/2"
LG	6	3/4"
HD		80A

OEM

91008024
NP508-1
325-218
09-4429

Notes:

14502

Trunnion Bushing

OD	4	1/2"
ID	3	1/2"
LG	6	3/4"
HD		80A - 97A

OEM

91008004
91008005
R304250
N331
N332
E-7443
325-204
09-4870
09-4871

Notes:

14504

Beam End Bushing

OD	2	3/8"
ID	1	1/4"
LG	5	
HD		80A

OEM

90008002
60-1540PU
N109
E-2940
E-8677
D240
325-235U
M2118
09-4410
TRB5721

Notes:

14505

Axle Pad

THK	13/16"	
WD	5	
LG	10	3/8"
HD		80A

OEM

91028039
N244
325-200
09-4438
AW57-10000

Notes:

14509

Axle Pad

THK	5	3/4"
WD	9	
LG		
HD		80A

OEM

91028051
60-1507
N247
E-2945
E-8679
D356
325-141
M1486
09-4433
M8358

Notes:

14510

Beam End Bushing

OD	2	3/8"
ID	1	1/8"
LG	5	
HD		80A

OEM

90008131
60-1532
R304255
R307485
N119
N119UB
E-4255
E-7485
D235
321-227

Notes:

14513



Beam End Bushing

OD	3 1/2"
ID	1 1/8"
LG	5 1/4"
HD	80A

OEM
90008139
 60-1535
 R304382A
 N120
 N120UB
 E-4382A
 E-8683
 D441
 321-229
 321-229U

Notes: additional tool suggestion 14531

14514



Beam End Bushing

OD	3 1/2"
ID	1 1/8"
LG	5
HD	80A

OEM
90008151
 60-1539
 R309292
 N320
 E-9292
 D440
 321-314
 TRB5719

Notes: additional tool suggestion 14531

14521



Trunnion Bushing

OD	5"
ID	4"
LG	8 3/4"
HD	80A

OEM
91008022
 60-1541
 R301332
 R307486
 N215
 N215UB
 E-1332
 E-7486
 D232
 325-137

Notes:

14522



Axle Pad

THK	3/4"
WD	4 1/2"
LG	5 1/8"
HD	80A

OEM
91028013
91028089
 60-1527
 60-1546PU
 R301330
 R308669
 R308670
 N254
 E-1330
 E-866942

Notes:

14523



Trunnion Bushing Lower Half

THK	1 15/16"
WD	3 11/16"
LG	4 1/8"
HD	72D

OEM
91008006
 N211
 E-5080
 322-146

Notes: use with 14524

14524



Trunnion Bushing Lower Half

THK	1 13/16"
WD	3 13/16"
LG	4 1/8"
HD	80A

OEM
91008033
 R305081
 N217
 E-5081
 322-147

Notes: use with 14523

14526



Center Bushing

OD	3 3/8"
ID	2"
LG	5 1/4"
HD	80A

OEM
90008104
 60-1502
 R304254
 N115
 E-4254
 321-228
 TRB5704

Notes: additional tool suggestion 14531

14527



Center Bushing

OD	3 7/8"
ID	2 1/2"
LG	5 3/4"
HD	80A

OEM
90008008
900 08 008
 60-1531PU
 R304253
 R308681
 N112
 N112UB
 E-4253
 E-8681
 D237

Notes:

Neway continued

14529



Center Bushing

OD	2 13/16
ID	1
LG	5 1/8
HD	80A

OEM
90008148
60-1501
R304410A
N124
E-4410A
321-231
TRB-5703

Notes:

14530



Beam End Bushing

OD	3 7/8
ID	2 1/2
LG	2 5/8
HD	80A

OEM

Notes:

14532



Beam End Bushing

OD	3 7/8
C-C	8 1/2
BH	1
HD	80A

OEM
90008005
N110
E-2936
321-178
TRB5712

TOOL 18831

Notes: additional tool suggestion 13588

14533



Beam End Bushing

OD	2 13/16
ID	1 1/8
LG	5
HD	80A

OEM
90008149
60-1501
R304410A
N124
E-4410A
D448
321-231
321-231U
M3454
TRB5703

Notes: supersedes 14528 / additional tool suggestion 14531

18566



Shock Absorber Bushing

OD	1 7/8
ID	1
LG	1
HD	80A

OEM
900 08 003
40-340
R307529
HB593
SB1UB
E-7529
D1
320-153
320-153U
M695

Notes:

31592



Beam End Bushing

OD	3 7/8
ID	2 1/2
LG	5 1/4
HD	80A

OEM
900-08-006
24SU21
R304252
N111
D433

Notes:

50046



Suspension Bushing

OD	5
ID	1 1/8
LG	5
HD	80A

INCLUDED IN:
50047

OEM
90008247

Notes: 2 per axle

50047



Suspension Bushing Kit

INCLUDES

QTY 2	50046
QTY 2	Bolt 1 1/8" - 7UNC x 9 1/2"
QTY 4	Flat Washer 1/2"
QTY 2	Lock Nut 1 1/8" - 7UNC

OEM
48100394
SRK-530

Notes:

DESCRIPTION	OEM	PART ID	PAGE
Air Cooler Mount	13-01633 / 35-568PU / 50-1440PU / R307448 / E-7448 / D15 / D325 / 329-149U / 329-162U / M13633 / M13633UB / PL1077	11554	193
Beam End Bushing	03-01674 / 03-07016 / 50-1421PU / R304775 / R307509 / PB6 / PB6UB / E-4775 / E-7509 / D13 / 320-108 / 320-108U / M1659 / TRB5905 / PL1075	12350	195
Beam End Bushing	03-05101 / 03-07015 / R307841 / PB42 / E-7841 / D58 / 320-132 / TRB5904 / PL1189	12354	195
Beam End Washer	03-01675 / 50-1422PU / R304776 / PB5 / E-4776 / D14 / 334-456 / M1661 / TRB5907 / PL1076	12351	199
Bolster Spring Kit	64179-037 / HS130 / E-14044 / E-14374 / 334-1727 / 334-1845 / MLC3 / MLC5 / LP50-24179	13626	192
Cab Mount	07-03286 / 35-548PU / R307472 / UM1113 / E-7472 / D6 / 329-136U / M17412 / M17412UB / MM96-62401 / PL1015 / PL1015-HT	11520	192
Cab Mount	07-03286 / 35-548PU / R307472 / UM1113 / E-7472 / D6 / 329-136U / M17412 / M17412UB / MM96-62401 / PL1015 / PL1015-HT	11523	192
Cab Mount	05-14794 / 35-1363PU / 35-564PU / R307462 / UM1196 / E-7462 / D36 / D5 / D51 / 329-147U / 329-177U / M17392UB / M17417 / M17417UB / PL1009 / PL1136	11705	194
Cab Mount	05-08968 / 35-569PU / R307506 / E-7506 / D326 / D4 / D540 / 329-144U / 329-163U / M17804UB / PL1070 / PL1070-HT / PL1105 / PL1105-HT	11707	194
Carrier Bearing Assy	210661-1X / CB2106611XSA / DS-6049	40074	200
Carrier Bearing Assy	2101211X / DS-6048	40075	201
Easy-Mount Torque Rod Bushing	227720 / 02-27720 / 20-833PU / R302226 / R307639 / C879 / C879UB / E-2226 / E-4664 / E-7639 / D423 / 321-132 / 321-132U / M2070 / 09-5723 / TRB6820 / TRB6820UB / TS38000	83520	201
Easy-Mount Torque Rod Bushing	227710 / 02-27710 / 20-832PU / R302225 / R307638 / C878 / C878UB / FL55 / E-2225 / E-7638 / D421 / 321-131 / 321-131U / M2069 / TRB164 / TRB6164 / TS34000 / TS34095	83522	201
Exhaust Bushing	M13-1009	17283	199
Exhaust Bushing	M13-1011	17284	199
Exhaust Bushing Kit	14-14656 / PB-B4656 / D82 / 329-214 / EM75-69656	12381	198
Exhaust Mount	14-14656 / PB-14656U / D82 / 329-214 / EM75-69656	12357	196
Hood Bushing	13-03593 / 35-550PU / D16 / 329-161U / HM75-64593	12363	196
Hood Hinge Bushing	J5950 / R307464 / E-7464 / D39 / 329-113U / M17333 / M17333UB / PL1068	11062	192
Hood Hinge Bushing	M300-70NR / 35-553PU / R307466 / UM1194 / E-7466 / D24 / 329-145U / M3841 / M17400 / M17400UB / PL1010	11709	194
Hood Hinge Bushing	13-03440 / 50-1435PU / R307503 / UM1607 / E-7503 / D10 / 329-132U / M17474UB / PL1074	12367	197
Hood Hinge Bushing	13-04154 / HM75-66154	12370	197
Hood Latch	37-41-295-60	11103	192
Hood Latch	K147-107 / HLK1000	11543	193
Hood Latch	63011001 / 23-13857 / L56-0001	12365	197
Hood Mount	13-03510 / D534 / 329-202U / M13351UB / HM75-65510	12359	196
Hood Mount	13-04711 / HM75-65711	12364	197
Load Spring	1037261C001 / 9031221B302 / R309438 / E-9438 / 334-886 / 09-7839 / RD604UB / RS20222	19003	200
Motor Mount	05-08969 / 05-10103 / 05-16401 / 35-549PU / R307469 / UM1157 / E-7469 / D432 / D7 / 329-141U / 329-159U / 329-194U / M17406 / M17406UB / PL1013	11537	192
Motor Mount	05-15646 / 35-552PU / 35-570PU / R307468 / UM1191 / E-7468 / D22 / D328 / 329-143U / M17404 / M17404UB / PL1012	11539	193
Motor Mount	05-08969 / 05-10103 / 05-16401 / 35-549PU / R307469 / UM1157 / E-7469 / D432 / D7 / 329-141U / 329-159U / 329-194U / M17406 / M17406UB / PL1013	11613	193
Motor Mount	05-15646 / 35-552PU / 35-570PU / R307468 / UM1191 / E-7468 / D22 / D328 / 329-143U / 329-164U / M17404 / M17404UB / PL1012	11614	193

DESCRIPTION	OEM	PART ID	PAGE
Motor Mount	K066-405 / K066-407 / K066-423 / D108 / D113 / KT59-62002 / KT59-62002-HT / MM59-62407	11615	194
Motor Mount	05-08968 / 50-1431PU / R307506 / UM1693 / E-7506 / D326 / 329-144U / M17804UB / PL1070	12355	196
Motor Mount	05-10197 / 50-1434PU / R307507 / UM1608 / E-7507 / D9 / 329-151U / M17482UB / PL1018 / PL1018-HT	12356	196
Motor Mount	20-08257 / 20-08867 / 50-1445UB / R308919 / E-8919 / D443 / M20306UB / CM75-61257 / KT75-61257	12360	196
Motor Mount	CB2203-70 / CB2203-77 / CB2203-78 / MR1000 / MM75-62370 / MM75-62370-HT / MM75-62377	12368	197
Motor Mount	CB2203-72 / MR1001 / D83 / MM75-62372 / MM75-62372-HT	12369	197
Motor Mount	05-16919 / 50-1442PU / D17 / 329-191U / M17475UB / PL1111	18102	200
Motor Mount	05-18263 / CB2203-2 / D20 / 329-155U / M17483UB / PL1112	18786	200
Motor Mount Kit	05-15646 / 35-552PU / 35-570PU / R307468 / UM1191 / E-7468 / D22 / D328 / 329-143U / M17404 / M17404UB / PL1012	11761	194
Motor Mount Kit	K066-405 / K066-407 / K066-423 / D108 / D113 / KT59-62002 / KT59-62002-HT / KT59-62002-HW / KT59-62003-HT / MM59-62407	11762	194
Radiator Bushing	07-02552 / 50-1429PU / R307508 / UM1605 / E-7508 / D2 / 329-130U / M17484UB / PL1126 / PL1126-HT	12366	197
Shackle	02-01154 / 50-1412 / E485-75 / 330-116 / M1216	12375	197
Shifter Bushing Kit	FULK3399 / MS99-63399	11611	193
Shock Absorber Bushing	03-04627 / COM266 / 35-539PU / R307474 / SB3UB / E-7474 / D37 / 320-178 / 320-178U / 09-7160 / MH1433 / MH1433UB / PL1028	11550	193
Shock Absorber Bushing	03-04627 / COM266 / R307474 / E-7474 / 320-178 / 320-178UB / MH1433 / MH1433UB / PL1028	18244	200
Shock Absorber Bushing	02-00377 / 40-340 / R307529 / HB593 / SB1UB / E-7529 / D1 / 320-153 / 320-153U / M695 / M-17526UB / MH1432 / MH1432UB / PL1026	18566	200
Shock Absorber Bushing	1T18197A / 12-5-123 / 12-5-123A / 2350908 / 2350908U / SB03-83008	30507	200
Spring Bushing Kit	03AL01 / 03AL1 / 50-1420 / R304773 / PB7 / E-4773 / 334-460 / 334-460U / M1656 / TRK5905 / PB75-29674	12361	196
Spring Bushing Kit	03AL02 / 03AL2 / 41NE1614 / R307840 / PB44 / E-7840 / 334-814 / TRK5904 / PB75-29101	12362	196
Spring Pin Bushing	52296 / RB205 / RB268 / E-8804 / RB-157-OS / RB-205 / RB-268 / MR782 / PB46-26268 / UB20500-OS / 37-41-295-60	11083	192
Spring Pin Bushing	50273AB / B65-6005 / RB328 / RB-328 / SP00-11005	11767	195
Torque Rod Assy	925031 / 945381 / TR59-41376	11080	192
Torque Rod Assy	C65-6002 / C65-6009 / 345-884 / 937530 / TR030020010 / R553 / TR00-41009	11792	195
Torque Rod Assy		11794	195
Torque Rod Assy	C65-6000-002 / C65-6011-002 / 345-883 / 937561 / R539 / TR00-41600	11795	195
Torque Rod Assy	924175 / 03-04327 / C65-6016-000010440 / 50-1428 / PB33 / E-5083 / 345-211 / 947790 / R520 / TR75-41327	12395	198
Torque Rod Assy	C65-6000-001 / C65-6011-001 / 345-882 / 937560 / R537 / TR00-41001	12397	198
Torque Rod Assy	943711 / 03-05108 / 03-05198 / 50-1437 / PB46 / E-7853 / 345-215 / TR75-41108	12398	198
Torque Rod Assy	925150 / TR59-41150	13679	199
Torque Rod Assy	03-04059 / C65-6013 / SS-219-117 / PB15 / E-4771 / 345-210 / TMR518 / TR75-41059	34554	200
Torque Rod Bushing	47691 / 20-836PU / R305275 / HS44 / E-5275 / D405 / 321-223 / 321-223U / TRB6185 / TRB6185UB / PL1146A	11004	192
Torque Rod Bushing	227710 / M2069	11556	193

DESCRIPTION	OEM	PART ID	PAGE
Torque Rod Bushing	836940 / 839310 / R3010303 / E10303 / E-10303 / 321-369 / TS59-22400	11729	194
Torque Rod Bushing	C13-6002 / RB-292 / MR830 / SU00-29002	11764	194
Torque Rod Bushing	C13-6001 / RB-291 / MR828 / SU00-29001	11765	195
Torque Rod Bushing	224993 / 20-850 / R302238 / C870 / E-2238 / D316 / 321-141 / 321-141U / M2068 / 09-5519 / TRB6186 / TRB6186UB / IN35190	13514	198
Torque Rod Bushing	229610 / 02-29610 / 20-831PU / R302228 / R308651 / C883 / C883UB / E-2228 / E-8651 / D422 / 321-133 / 321-133U / M2072 / 09-5721 / TRB6112 / TRB6112UB / TT38000	13518	198
Torque Rod Bushing	227720 / 02-27720 / 20-833PU / R302226 / R307639 / C879 / C879UB / E-2226 / E-4664 / E-7639 / D423 / 321-132 / 321-132U / M2070 / 09-5723 / TRB6820 / TRB6820UB / TS38000	13520	198
Torque Rod Bushing	47691 / 20-836PU / R305275 / HS44 / E-5275 / D405 / 321-223 / 321-223U / TRB6185 / TRB6185UB / PL1146 / TS50-22691	13521	198
Torque Rod Bushing	227710 / 02-27710 / 20-832PU / R302225 / R307638 / C878 / C878UB / FL55 / E-2225 / E-7638 / D421 / 321-131 / 321-131U / M2069 / TRB164 / TRB6164UB / TS34000 / TS34095	13522	199
Torque Rod Bushing	02-27723 / 20-851PU / R303868 / C889 / E-3868 / D424 / 321-265 / 321-265U / TRB6822 / TRB6822UB / TS38750	13528	199
Torque Rod Bushing	02-227720 / 20-833PU / R302226 / R307639 / C879UB / E-2226 / E-4664 / E-7639 / D423 / 321-132U / M2070 / 09-5723 / TRB6820UB	13536	199
Torque Rod Bushing	A80BL1026 / UCA-3754 / 722-00 / 026900 / 12855 / 3-12-35 / 15209 / 31219 / 2530037 / 32460730 / 17012 / 25-708PU / R307453 / R30934 / RB201 / RBT201 / E-7453 / E-934 / 321-175 / 321-175U / M1888 / 09-3344 / TRB6326 / TRB6326UB / PL1119 / D94	14008	199

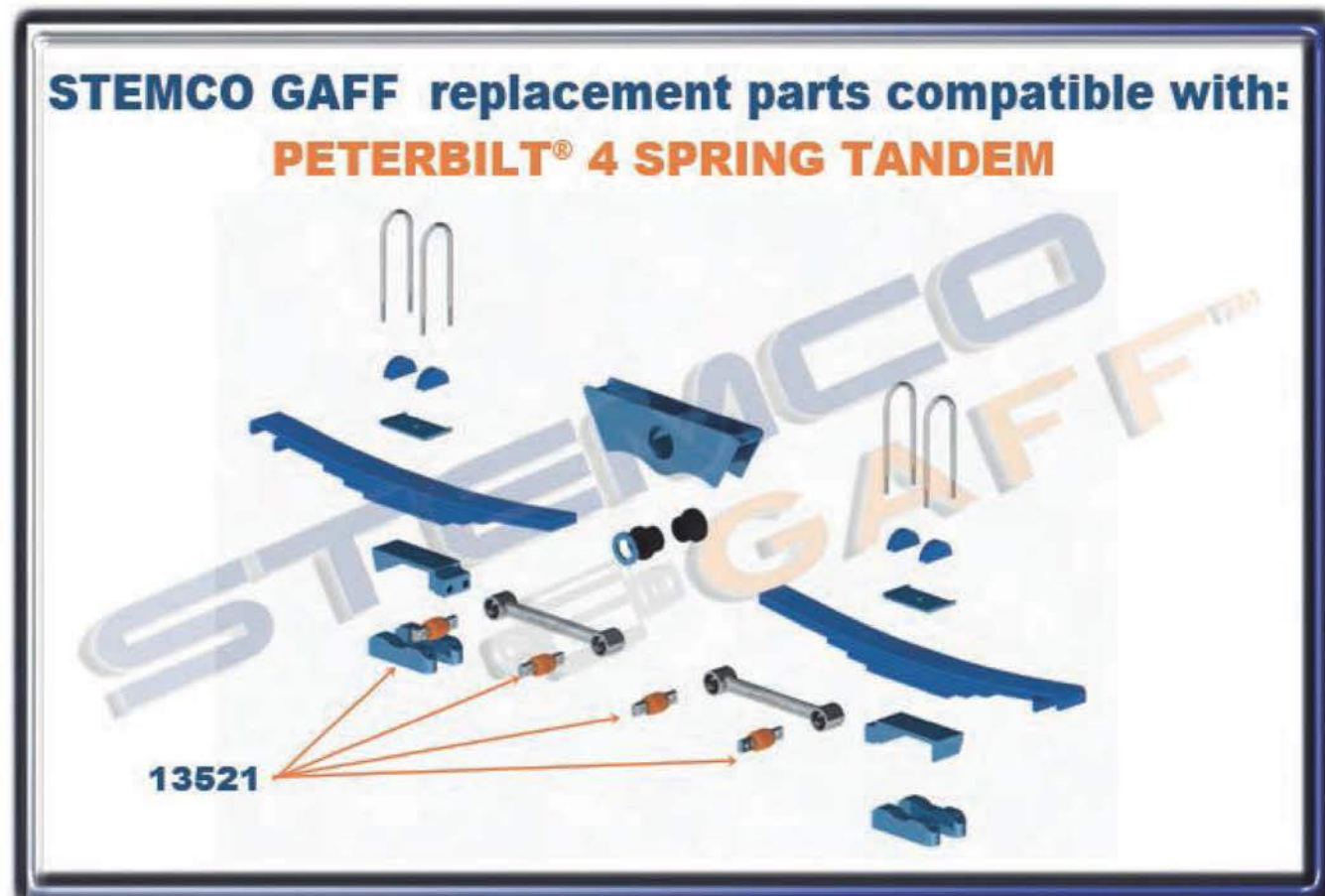

STEMCO GAFF replacement parts compatible with: **PETERBILT® AIR LEAF® SUSPENSION**

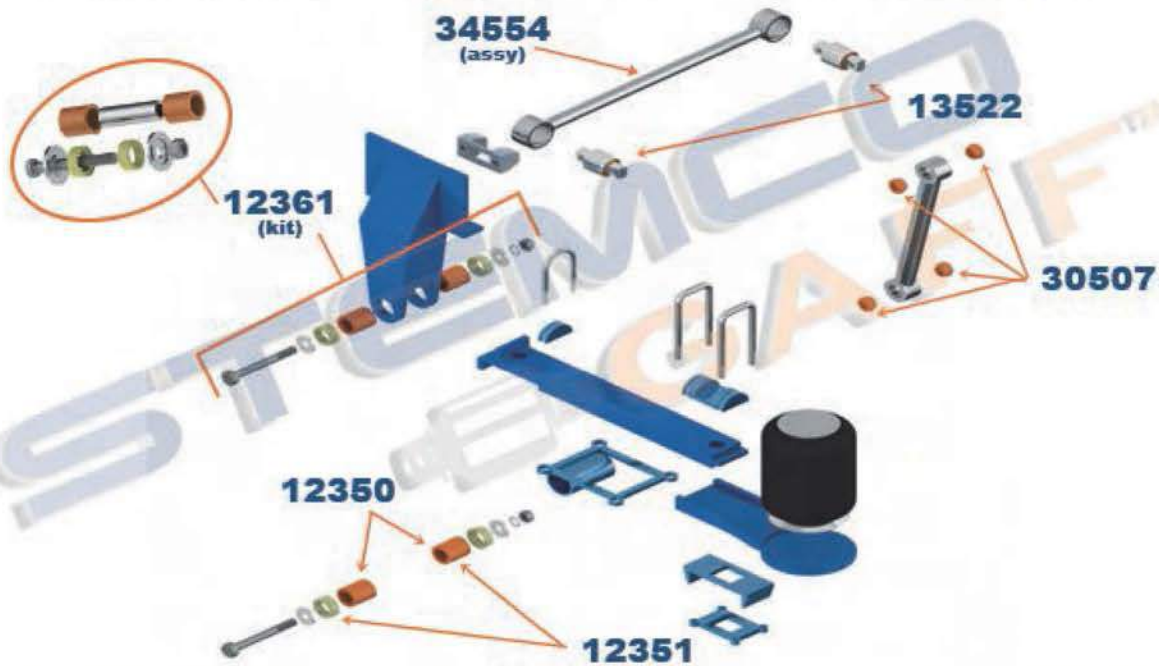

STEMCO GAFF replacement parts compatible with: **PETERBILT® AIR TRAC® SINGLE/TANDEM AXLE REAR AIR SUSPENSION**



**STEMCO GAFF replacement parts compatible with:
PETERBILT® LOW AIR LEAF® SUSPENSION**

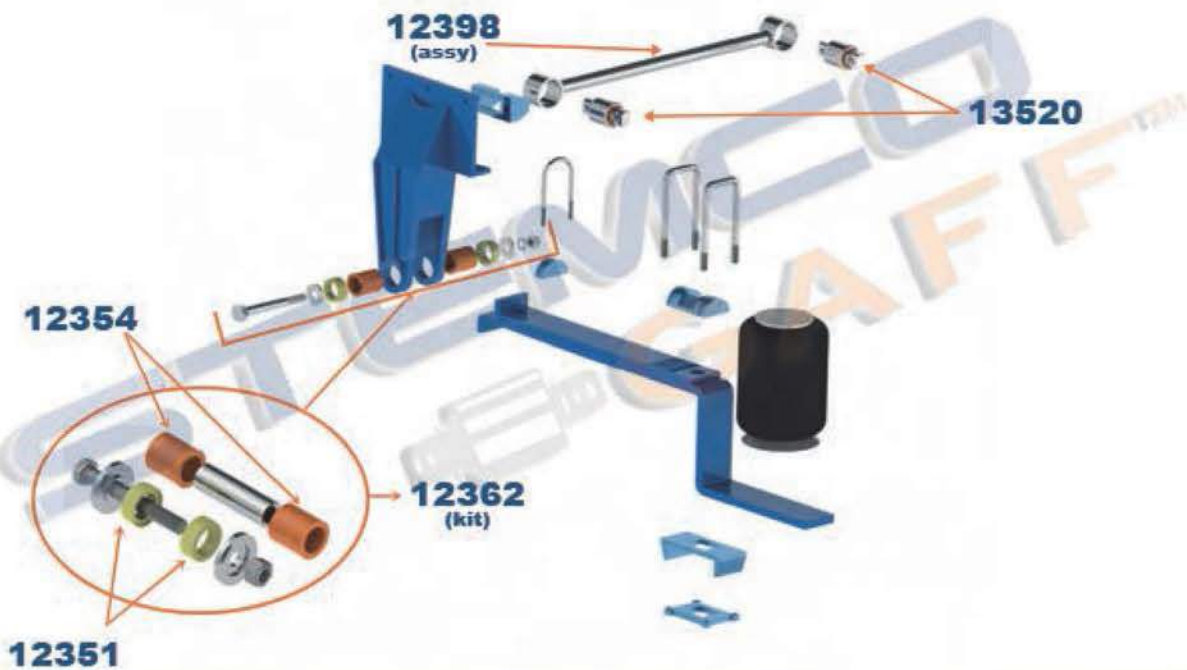

**STEMCO GAFF replacement parts compatible with:
PETERBILT® QUADRAFLEX® 4 SPRING**

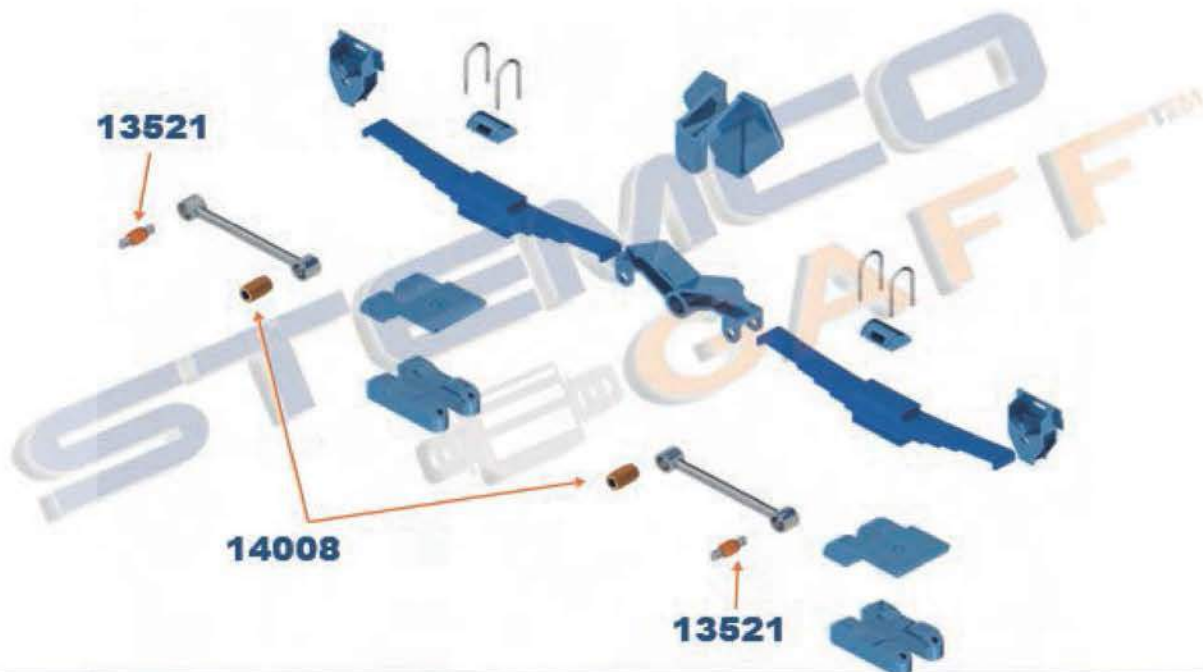

Peterbilt continued

11004



Torque Rod Bushing

OD	2	1/16"
LG	6	5/8"
C-C	4	3/8"
BH		5/8"
HD	80A	

INCLUDED IN:
11078, 11081, 11769

TOOLS 11071, 18836

OEM
47691
20-836PU
R305275
HS44
E-5275
D405
321-223
321-223U
TRB6185
TRB6185UB

Notes: rib style / 11006 - oversized / 12051 - grooved for torque rod with a center rib / 13521 - chamfered

11062



Hood Hinge Bushing

OD	2	1/8"
ID	1	5/16"
LG	2	1/4"
HD	80A	

OEM
J5950
R307464
E-7464
D39
329-113U
M17333
M17333UB
PL1068

Notes:

11080



Torque Rod Assy

LG ²	8	1/16"
C-C	24	
BC-C	4	3/8"
BH		5/8"
HD	80A	

INCLUDES
QTY 1 11754
QTY 1 13520
QTY 1 13518

OEM
925031
945381
TR59-41376

Notes:

11083



Spring Pin Bushing

OD	2	1/2"
LG	7	7/16"
C-C	5	11/16"
BH		7/8"
HD	80A	

OEM
52296
RB205
RB268
E-8804
RB-157-OS
RB-205
RB-268
MR782
PB46-26268
UB20500-OS

TOOL 11069

Notes: anti walk design

11103



Hood Latch
W / Mount

LG	8	9/16"
HD	70A	

INCLUDES
QTY 1 11098

OEM
37-41-295-60

Notes: bracket not sold separately

11520



Cab Mount
W / Metal Sleeve

OD	2	7/8"
OD<	1	7/8"
ID		5/8"
LG	1	5/16"
HD	80A	

OEM
07-03286
35-548PU
R307472
UM1113
E-7472
D6
329-136U
M17412
M17412UB
MM96-62401

Notes: metal bushing stepped design/ verify dimensions compare to 11523 or 11552

11523



Cab Mount
W / Metal Sleeve

OD	2	7/8"
OD<	1	13/16"
ID		5/8"
LG	1	5/16"
HD	80A	

OEM
07-03286
35-548PU
R307472
UM1113
E-7472
D6
329-136U
M17412
M17412UB
MM96-62401

Notes: metal bushing stepped design / verify dimensions compare to 11523 or 11552 / compatible with Western Star using (2) 11523 with a 12301

11537



Motor Mount
Front

OD	3	11/16"
OD<	2	1/16"
ID		3/4"
LG	2	1/2"
HD	80A	

OEM
05-08969
05-10103
05-16401
35-549PU
R307469
UM1157
E-7469
D432
D7
329-141U

Notes:

11539



**Motor Mount
Rear**

THK	2	9/16	~
WD	2	1/16	~
LG	5	3/4	~
C-C	3		~
BH		5/8	~
HD	80A		

INCLUDED IN:
11761

OEM
05-15646
35-552PU
35-570PU
R307468
UM1191
E-7468
D22
D328
329-143U
M17404

Notes: verify dimensions compare to 11614

11543



Hood Latch

LG	8	9/16	~
HD	70A	97A	~

OEM
K147-107
HLK1000

Notes:

11550



**Shock Absorber Bushing
No Sleeve**

OD	2		~
OD<	1		~
ID		5/8	~
LG	1		~
HD	80A		

OEM
03-04627
COM266
35-539PU
R307474
SB3UB
E-7474
D37
320-178
320-178U
09-7160

Notes:

11554



Air Cooler Mount

OD	1	1/8	~
OD<		3/4	~
ID		3/8	~
LG		7/8	~
HD	80A		

OEM
13-01633
35-568PU
50-1440PU
R307448
E-7448
D15
D325
329-149U
329-162U
M13633

Notes:

11556



Torque Rod Bushing

OD	2	11/16	~
C-C	4	3/8	~
BH		5/8	~
HD	80A		

OEM
227710
M2069

Notes: verify dimensions compare to 13522 and 83522

11611



Shifter Bushing Kit

OD	1	1/2	~
ID		13/16	~
LG	2	5/16	~
BH		3/4	~
HD	90A		

OEM
FULK3399
MS99-63399

Notes:

11613



**Motor Mount
Front**

OD	3	13/16	~
OD<	2	1/16	~
ID		3/4	~
LG	2	9/16	~
HD	80A		

OEM
05-08969
05-10103
05-16401
35-549PU
R307469
UM1157
E-7469
D432
D7
329-141U

Notes:

11614



**Motor Mount
Rear**

THK	2	5/16	~
WD	2		~
LG	5	9/16	~
BC-C	3		~
BH		5/8	~
HD	80A		

OEM
05-15646
35-552PU
35-570PU
R307468
UM1191
E-7468
D22
D328
329-143U
329-164U

Notes: verify dimensions compare to 11539

Peterbilt continued

11615Motor Mount
Front

OD	3 1/2	-
OD<	2	-
ID	13/16	-
LG	2 1/4	-
HD	70A	-

INCLUDED IN:
11762

OEM
K066-405
K066-407
K066-423
D108
D113
KT59-62002
KT59-62002-HT
MM59-62407

Notes: compatible with K066-404 (Lower) and K066-406 (Upper) / kit not offered by OE / see tech tip 01 577 9021

11705

Cab Mount

OD	3	-
OD<	1 13/16	-
ID	5/8	-
LG	2 3/8	-
HD	80A	-

OEM
05-14794
35-1363PU
35-564PU
R307462
UM1196
E-7462
D36
D5
D51
329-147U

Notes: used in multiple applications

11707

Cab Mount

OD	2 1/2	-
OD<	1 5/8	-
ID	5/8	-
LG	2	-
HD	80A	-

OEM
05-08968
35-569PU
R307506
E-7506
D326
D4
D540
329-144U
329-163U
M17804UB

Notes: OD< Chamfered / 12355 - standard / also used as motor mount

11709

Hood Hinge Bushing

OD	1 3/4	-
OD<	1 3/16	-
ID	1/2	-
LG	1 3/8	-
HD	80A	-

OEM
M300-70NR
35-553PU
R307466
UM1194
E-7466
D24
329-145U
M3841
M17400
M17400UB

Notes:

11729

Torque Rod Bushing

OD	2 3/4	-
C-C	4 3/8	-
BH	11/16	-
HD	80A	-

INCLUDED IN:
11773, 11793, 12074,
13634, 31095

TOOLS 18551, 18833

OEM
836940
839310
R3010303
E10303
E-10303
321-369
TS59-22400

Notes: high articulation bushing

11761Motor Mount Kit
Rear

INCLUDES
QTY 2 11539
QTY 4 Bolt 3/4" x 4" G8
QTY 4 Lock Nut 3/4"
QTY 8 Flat Washer 3/4"

OEM
05-15646
35-552PU
35-570PU
R307468
UM1191
E-7468
D22
D328
329-143U
M17404

Notes: kit not offered by OE

11762Motor Mount Kit
Front

INCLUDES
QTY 2 11615
QTY 2 Bolt 3/4" x 4" G8
QTY 2 Lock Nut 3/4"
QTY 4 Flat Washer 3/4"

OEM
K066-405
K066-407
K066-423
D108
D113
KT59-62002
KT59-62002-HT
KT59-62002-HW
KT59-62003-HT
MM59-62407

Notes: kit not offered by OE / see tech tip 01 577 9021

11764

Torque Rod Bushing

OD	2 3/8	-
ID	7/8	-
LG	3	-
HD	90A	-

OEM
C13-6002
RB-292
MR830
SU00-29002

Notes:

11765



Torque Rod Bushing

OD	2	3/8	~
C-C	4	3/8	~
BH		5/8	~
HD	90A		

OEM
C13-6001
RB-291
MR828
SU00-29001

Notes:

11767



Spring Pin Bushing

OD	1	3/4	~
C-C	5	7/16	~
HD	80A		

OEM
50273AB
B65-6005
RB328
RB-328
SP00-11005

Notes: additional tool suggestion 40090

11792



Torque Rod Assy

C-C	25	9/16	~
BC-C	4	3/8	~
BH		5/8	~

INCLUDES
QTY 2 13521

OEM
C65-6002
C65-6009
345-884
937530
TR030020010
TMR553
TR00-41009

Notes:

11794



Torque Rod Assy

LG	8	1/16	~
C-C	25		~
BC-C	4	3/8	~
BH		5/8	~
THR	1 1/4	- 12	UNF

INCLUDES
QTY 1 13520
QTY 1 13518

OEM

Notes:

11795



Torque Rod Assy

ID		7/8	~
C-C	24	11/16	~
BC-C	4	3/8	~
BH		5/8	~

INCLUDES
QTY 1 13521
QTY 1 14010

OEM
C65-6000-002
C65-6011-002
345-883
937561
TMR539
TR00-41600

Notes:

12350



Beam End Bushing

OD	2	1/2	~
ID	1	3/4	~
LG	2	5/8	~
HD	90A		

INCLUDED IN:
12361

OEM
03-01674
03-07016
50-1421PU
R304775
R307509
PB6
PB6UB
E-4775
E-7509
D13

Notes:

12351



Beam End Washer

OD	2	5/8	~
ID	1	3/4	~
LG		15/16	~
HD	72D		

INCLUDED IN:
12361, 12362

OEM
03-01675
50-1422PU
R304776
PB5
E-4776
D14
334-456
M1661
TRB5907
PL1076

Notes:

12354



Beam End Bushing

OD	2	1/2	~
ID	1	3/4	~
LG	2	3/8	~
HD	90A		

INCLUDED IN:
12362

OEM
03-05101
03-07015
R307841
PB42
E-7841
D58
320-132
TRB5904
PL1189

Notes:

Peterbilt continued

12355



Motor Mount

OD	2 1/2"
OD<	1 5/8"
ID	5/8"
LG	2"
HD	80A

OEM
05-08968
50-1431PU
R307506
UM1693
E-7506
D326
329-144U
M17804UB
PL1070

Notes: standard / chamfered - 11707

12356



Motor Mount

OD	2 11/16"
OD<	1 9/16"
ID	13/16"
LG	2 7/16"
HD	80A

OEM
05-10197
50-1434PU
R307507
UM1608
E-7507
D9
329-151U
M17482UB
PL1018
PL1018-HT

Notes:

12357



Exhaust Mount

OD	1 5/16"
ID	3/8"
LG	1 1/4"
HD	70A

INCLUDED IN:
12381

OEM
14-14656
PB-14656U
D82
329-214
EM75-69656

Included in 12381

12359



Hood Mount

WD	1 15/16"
LG	3 1/8"
HGT	2 3/8"
HD	70A

OEM
13-03510
D534
329-202U
M13351UB
HM75-65510

Notes:

12360



Motor Mount

OD	3 1/8"
OD<	1 13/16"
ID	5/8"
LG	2 3/4"
HD	80A

OEM
20-08257
20-08867
50-1445UB
R308919
E-8919
D443
M20306UB
CM75-61257
KT75-61257

Notes: components not sold separately / bolts not included

12361



Spring Bushing Kit

OD	2 1/2"
INCLUDES	
QTY 2	12350
QTY 2	12351
QTY 1	Bolt 1" - UNF x 8 1/2" G8
QTY 1	Lock Nut 1" - UNF
QTY 2	Flange Washer 1" x 3 5/16"

OEM
03AL01
03AL1
50-1420
R304773
PB7
E-4773
334-460
334-460U
M1656
TRK5905

Notes:

12362



Spring Bushing Kit

OD	2 1/2"
INCLUDES	
QTY 2	12354
QTY 2	12351
QTY 1	Bolt 1" - UNF x 8" G8
QTY 1	Lock Nut 1" - UNF
QTY 2	Flange Washer 1" x 3 5/16"

OEM
03AL02
03AL2
41NE1614
R307840
PB44
E-7840
334-814
TRK5904
PB75-29101

Notes:

12363



Hood Bushing

OD	1 1/2"
ID	5/8"
LG	1 1/2"
HD	80A

OEM
13-03593
35-550PU
D16
329-161U
HM75-64593

Notes:

12364



Hood Mount

WD	2	-
LG	3	1/8
HGT	2	3/8
HD	80A	-

OEM
13-04711
HM75-65711

Notes:

12365



Hood Latch

LG	8	11/16
HD	70A	-

OEM
63011001
23-13857
L56-0001

Notes:

12366



Radiator Bushing

OD	1	3/16
OD<	1	-
ID	1	5/8
LG	23	3/32
HD	80A	-

OEM
07-02552
50-1429PU
R307508
UM1605
E-7508
D2
329-130U
M17484UB
PL1126
PL1126-HT

Notes:

12367



Hood Hinge Bushing

OD	1	5/16
ID	2	1/2
LG	2	-
HD	80A	-

OEM
13-03440
50-1435PU
R307503
UM1607
E-7503
D10
329-132U
M17474UB
PL1074

Notes:

12368



Motor Mount

OD	2	17/32
ID	2	3/4
LG	2	3/8
HD	80A	-

OEM
CB2203-70
CB2203-77
CB2203-78
MR1000
MM75-62370
MM75-62370-HT
MM75-62377

Notes: components not sold separately

12369



Motor Mount Rear

OD	2	17/32
ID	2	5/8
LG	2	3/8
HD	80A	-

OEM
CB2203-72
MR1001
D83
MM75-62372
MM75-62372-HT

Notes: components not sold separately

12370



Hood Hinge Bushing

OD	1	13/16
ID	1	1/2
LG	6	5/8
HD	80A	-

OEM
13-04154
HM75-66154

Notes:

12375



Shackle

ID	1	1/4
THK	1	-
WD	2	1/4
LG	6	1/16
C-C	3	1/2

OEM
02-01154
50-1412
E485-75
330-116
M1216

Notes:

12381

Exhaust Bushing Kit

OD	1	5/16	--
ID		3/8	--
LG	1	1/4	--
HD		70A	

INCLUDES
QTY 8 12357

OEM
14-14656
PB-B4656
D82
329-214
EM75-69656

Notes:

12395

Torque Rod Assy

C-C	17	5/16	--
BC-C	4	3/8	--
BH ⁽¹⁾		5/8	--
BH ⁽²⁾		3/4	--

INCLUDES
QTY 1 13528
QTY 1 13520

OEM
924175
03-04327
C65-6016-000010440

50-1428
PB33
E-5083
345-211
947790
TMR520

Notes:

12397

Torque Rod Assy

ID		7/8	--
C-C	23	3/4	--
BC-C	4	3/8	--
BH		5/8	--

INCLUDES
QTY 1 13521
QTY 1 14010

OEM
C65-6000-001
C65-6011-001
345-882
937560
TMR537
TR00-41001

Notes:

12398

Torque Rod Assy

C-C	25	9/16	--
BC-C	4	3/8	--
BH		5/8	--

INCLUDES
QTY 2 13520

OEM
943711
03-05108
03-05198
50-1437
PB46
E-7853
345-215
TR75-41108

Notes:

13514

Torque Rod Bushing

OD	3	--
ID	1	1/8
LG	3	1/4
HD		80A

TOOLS 13585, 18831

OEM
224993
20-850
R302238
C870
E-2238
D316
321-141
321-141U
M2068
09-5519

Notes: additional tool suggestion 13585

13518

Torque Rod Bushing

OD	2	3/4
LG	8	1/16
THR	1 1/4	- 12 UNF
HD		80A

INCLUDED IN:
11794, 11808, 13657, 13679,
13686, 13694, 13695, 34555

TOOLS 13584, 18833

OEM
229610
02-29610
20-831PU
R302228
R308651
C883
C883UB
E-2228
E-8651
D422

Notes: metal sleeve/ 13533 - no sleeve / additional tool suggestion 18551, coming soon 40131

13520

Torque Rod Bushing

OD	2	3/4	--
C-C	4	3/8	--
BH		5/8	--
HD		80A	

INCLUDED IN:
Several Kits

TOOLS 18551, 18833

OEM
227720
02-27720
20-833PU
R302226
R307639
C879
C879UB
E-2226
E-4664
E-7639

Notes: 83520 - easy mount / 13536 - no metal sleeve

13521

Torque Rod Bushing

OD	2	1/16	--
LG	6	5/8	--
C-C	4	3/8	--
BH		5/8	--
HD		80A	

INCLUDED IN:
11153, 11792, 11795, 12397,
34563

TOOLS 11071, 18836

OEM
47691
20-836PU
R305275
HS44
E-5275
D405
321-223
321-223U
TRB6185
TRB6185UB

Notes: chamfered / 11004 - rib style / 11006 - oversized / 12051 - grooved for torque rod with a center rib

13522



Torque Rod Bushing

OD	2 17/32"
C-C	4 3/8"
BH	5/8"
HD	80A

OEM
227710
02-27710
20-832PU
R302225
R307638
C878
C878UB
FL55
E-2225
E-7638

TOOLS 18553, 18833

Notes: metal sleeve / easy mount - 83522 / no sleeve - 11003 / additional tool suggestion coming soon 40131

13528



Torque Rod Bushing

OD	2 3/4"
C-C	4 3/8"
BH	3/4"
HD	80A

OEM
02-27723
20-851PU
R303868
C889
E-3868
D424
321-265
321-265U
TRB6822
TRB6822UB

INCLUDED IN:
12395, 13701, 13702, 13703

TOOLS 18833, 18551

Notes: additional tool suggestion coming soon 40131

13536



Torque Rod Bushing

OD	2 15/16"
C-C	4 3/8"
BH	5/8"
HD	80A

OEM
02-227720
20-833PU
R302226
R307639
C879UB
E-2226
E-4664
E-7639
D423
321-132U

TOOL 18831

Notes: 83520 - easy mount / 13520 - metal sleeve

13626



Bolster Spring Kit

BC-C	4 3/4"
THR	1/2"
HD	80A

OEM
64179-037
HS130
E-14044
E-14374
334-1727
334-1845
MLC3
MLC5
LP50-24179

Notes: 4 kits per truck / recommended to replace set in same repair / don't mix brands

13679



Torque Rod Assy

LG ²	8 1/16"
C-C	25
BC-C	4 3/8"
BH	5/8"
HD	80A

OEM
925150
TR59-41150

INCLUDES
QTY 1 13680
QTY 1 13518
QTY 1 13520

Notes:

14008



Torque Rod Bushing

OD	1 15/16"
ID	1
LG	3
HD	80A

OEM
A80BL1026
UCA-3754
722-00
026900
12855
3-12-35
15209
31219
2530037
32460730

TOOL 18836

Notes: chamfered / stepped ends - 14073

17283



Exhaust Bushing

ID	3/8"
THK	1 9/16"
WD	1 5/8"
LG	3 5/8"
C-C	1 15/16"
HD	70A

OEM
M13-1009

Notes: compatible with T-800

17284



Exhaust Bushing

OD	1 15/16"
ID	15/32"
LG	1 3/16"
HD	70A

OEM
M13-1011

Notes: compatible with W-900

Peterbilt continued

18102Motor Mount
Front

OD	3 5/8	--
OD<	2 3/16	--
ID	3/4	--
LG	2 7/16	--
HD	80A	--

OEM
05-16919
50-1442PU
D17
329-191U
M17475UB
PL1111

Notes:

18244

Shock Absorber Bushing

OD	1 13/16	--
ID	11/16	--
LG	13/16	--
HD	80A	--

OEM
03-04627
COM266
R307474
E-7474
320-178
320-178UB
MH1433
MH1433UB
PL1028

Notes:

18566

Shock Absorber Bushing

OD	1 7/8	--
ID	1	--
LG	1	--
HD	80A	--

OEM
02-00377
40-340
R307529
HB593
SB1UB
E-7529
D1
320-153
320-153U
M695

Notes:

18786Motor Mount
Cab Mount

OD	3 7/16	--
OD<	1 15/32	--
ID	15/16	--
LG	2 7/8	--
HD	80A	--

OEM
05-18263
CB2203-2
D20
329-155U
M17483UB
PL1112

Notes: components not sold separately

19003

Load Spring

WD	4 1/8	--
LG	4 5/8	--
HGT	3 3/8	--
HD	80A	--

OEM
1037261C001
9031221B302
R309438
E-9438
334-886
09-7839
RD604UB
RS20222

Notes:

30507

Shock Absorber Bushing

OD	1 15/16	--
ID	1	--
LG	15/16	--
HD	80A	--

OEM
1T18197A
12-5-123
12-5-123A
2350908
2350908U
SB03-83008

Notes:

34554

Torque Rod Assy

C-C	22 7/8	--
BC-C	4 3/8	--
BH	5/8	--
INCLUDES		
QTY 2	13520	

OEM
03-04059
C65-6013
SS-219-117
PB15
E-4771
345-210
TMR518
TR75-41059

Notes:

40074

Carrier Bearing Assy

ID	2 3/8	--
C-C	8 1/2	--
BH	1/2	--
HGT	1/2	--
HD	3 21/64	--
	70A	--

OEM
210661-1X
CB2106611XSA
DS-6049

Notes: includes carrier bearing bushing 18002

Peterbilt continued

40075



Carrier Bearing Assy

ID	2	-
C-C	7	7/16 -
BH		1/2 -
HGT	2	25/32 -
HD	70A	

OEM
2101211X
DS-6048

Notes: includes carrier bearing bushing 18725

83520



Easy-Mount Torque Rod Bushing

OD	2	3/4 -
C-C	4	3/8 -
BH		5/8 -
HD	80A	

OEM
227720
02-27720
20-833PU
R302226
R307639
C879
C879UB
E-2226
E-4664
E-7639

TOOLS 18551, 18833

Notes: standard - 13520 / no metal sleeve - 13536

83522



Easy-Mount Torque Rod Bushing

OD	2	17/32 -
C-C	4	3/8 -
BH		5/8 -
HD	80A	

OEM
227710
02-27710
20-832PU
R302225
R307638
C878
C878UB
FL55
E-2225
E-7638

TOOLS 18553, 18833

Notes: easy mount / metal sleeve - 13522 / no metal sleeve - 11003

Reyco

DESCRIPTION	OEM	PART ID	PAGE
Axle Pad	093400 / 60-1507 / N247 / E-2945 / E-8679 / D356 / 325-141 / M1486 / 09-4433 / M8358 / AW57-12000	14509	211
Axle Pad	091000 / 60-1527 / 60-1546PU / R301330 / R308669 / R308670 / N254 / E-1330 / E-8669 / E-8670 / D231 / D352 / 325-139U / 325-142 / 325-142U / 09-4424 / MTN456 / MTN457 / PL1041	14522	211
Beam End Adapter	14354-01 / 20-802 / R302372 / HAK34 / E-2372 / 334-108 / M2010 / HAK92 / AK34100	13502	210
Beam End Adapter Kit	127000 / 20-801 / R309420 / HAK44 / E-9420 / 334-127 / 334-467 / 09-5462 / HAK112 / AK38200	13609	210
Beam End Bushing	1003 / 14339-01 / 20-810PU / R301341A / R302771 / C862 / C862UB / C871 / E-1341A / E-2771 / E-9512 / D402 / 321-126 / 321-126U / 321-242 / M1726 / 09-5511 / 09-5728 / M1970 / M1970UB / M1988 / EB38000	13553	210
Beam End Bushing	093000 / 60-1540PU / N109 / E-2940 / E-8677 / D240 / 325-235U / M2118 / 09-4410 / TRB5721	14504	211
Beam End Bushing	092600 / N110 / E-2936 / 321-178 / TRB5712	14532	212
Beam End Bushing	13805-01 / R309550 / R251 / E-9550 / 321-270	18956	214
Center Bushing	17212-01 / 20-820 / R301595 / R306980 / R309510 / C867 / C867UB / C888 / E-1595 / E-6980 / E-9510 / D401 / 321-123 / 321-123U / 321-244 / 09-5514 / 09-5621 / M1980 / M1980UB / CB38010 / CB38011	13543	210
Equalizer Bolt	11147-01 / 334-1262 / 09-2836	15059	214
Equalizer Bushing	064200 / 076800 / 25-705PU / R301999A / R307452 / H102 / E-1999A / E-7452 / D95 / 321-176U / M1452 / 09-3351 / TRB5541 / TRB5541UB / EQ53-35234	14000	210
Equalizer Bushing	0770-00 / 65-1905 / R303394A/109 / E-3394A / 321-220 / 09-1218 / TRB5496	14001	210

DESCRIPTION	OEM	PART ID	PAGE
Equalizer Bushing	16095-01 / T3214 / R307712 / E-7712 / 321-193 / 321-268 / 09-2478 / TRB5543	14002	210
Equalizer Bushing	08915-01 / 146282-01 / 55-117 / R302850 / R161 / E-2850 / 321-159 / M2938 / TRB5028 / PL1149	15000	212
Equalizer Bushing	08363-01 / 14713-01 / T-5644 / 55-152PU / R301966 / R303977 / R308654 / R209 / E-3977 / E-8654 / D069 / D69 / 321-152 / 321-191 / 321-191U / M3399 / TRB5029 / PL1148	15001	212
Equalizer Bushing		15004	212
Equalizer Bushing	T-2101 / T-2102 / 55-190PU / R30813 / R308694 / E-813 / E-8691 / E-8694 / 321-149 / 321-149U / M1847 / TRB5004 / TRB5004UB / PL1177	15005	212
Equalizer Bushing		15006	212
Equalizer Bushing	T-5524 / 55-103PU / R301159 / R308653 / R110UB / E-1159 / E-8653 / D59 / 321-146U / M1719 / TRB5066 / EQ83-11000	15016	213
Equalizer Bushing	T-3214 / 55-191PU / R301072 / R308688 / R132 / VV2 / E-8688 / D76 / 321-154U / M1869 / TRB5023	15017	213
Equalizer Bushing	0649-02 / 55-144 / R304827 / TP110 / E-4827 / 321-194 / 321-194U / M1694 / TRB5544 / EQ83-35902	15054	213
Suspension Bushing Kit		15060	214
Torque Rod Bushing	090600 / 25-750PU / RB200 / E-7433 / E-927 / 321177U / D100 / M1818 / 09-2247 / TRB6300	14003	211
Torque Rod Bushing	026900 / 25-708PU / R307453 / R30934 / RB201 / RBT201 / E-7453 / E-934 / D94 / 321-175 / 321-175U / M1888 / 09-3344 / TRB6326 / TRB6326UB / PL1119	14008	211
Torque Rod Bushing	13945-01 / 55-130 / R303362 / R305276 / R208 / E-3362 / E-5276 / 321-162 / 09-2497 / TRB6025 / TH50-22692	14010	211
Torque Rod Bushing	026900 / 25-708PU / R307453 / R30934 / RB201 / RBT201 / E-7453 / E-934 / D94 / 321-175 / 321-175U / M1888 / 09-3344 / TRB6326 / TRB6326UB / PL1119	14073	211
Torque Rod Bushing	T-1842 / 55-128PU / R150UB / E-7521 / E-812 / D72 / 321-158 / 321-158U / M1846 / TRB6002 / TRB6002UB / PL1117	15008	212
Torque Rod Bushing	T-1723 / 55-134PU / R301964 / R127 / E-8689 / 321-157U / M1751 / TRB6062	15009	212
Torque Rod Bushing	T-5493 / 55-132PU / R301160 / R307523 / E-1160 / E-7523 / D71 / 321-145 / 321-145U / M1718 / TRB6008 / TRB6008UB / PL1116	15011	213
Torque Rod Bushing	09729 01 / 09729-01 / 55-129 / 55-129PU / R301980 / R307520 / R129 / R129UB / E-1061 / E-1980 / E-7520 / E-8687 / D73 / 39400016 / 321-153 / 321-153U / M1449 / TRB6004 / TRB6004UB / PL1118 / UB30000	15013	213
Torque Rod Bushing	T-5493 / 55-132PU / R301160 / R307523 / E-1160 / E-7523 / D71 / 321-145 / 321-145U / M1718 / TRB6008 / TRB6008UB / PL1116	15019	213
Torque Rod Bushing	21238-01 / T1842 / 55-11012 / 55-11012PU / E10057 / R3010057 / R150 / R235 / E-10057 / E-9579 / D79 / 321-285 / 321-285U / M3436 / TRB6002 / TH83-37238	15020	213
Torque Rod Bushing	T-2242 / 55-131PU / R301982 / R307522 / R131 / R131UB / E-1982 / E-7522 / D70 / 321-147 / 321-147U / M1845 / TRB6000 / TRB6000UB / PL1115	15051	213
Torque Rod Bushing	T-5493 / 55-132PU / R301160 / R307523 / E-1160 / E-7523 / D71 / 321-145 / 321-145U / M1718 / TRB6008 / TRB6008UB / PL1116	15073	214
Torque Rod Bushing Kit	TK21640 / 55-146 / R309350 / R234 / E9350 / 334-896 / 09-228202 / TRK6002 / TH83-37640	15061	214
Torque Rod Bushing Kit		15062	214
Torque Rod Bushing Kit	TK7302 / 55-11001 / R002 / E-1981 / E-9552 / 334-247 / TH83-22302	15063	214
Torque Rod Bushing Kit	TK18997 / TK19089 / R301983 / R001 / R003 / E-1312 / E-1983 / E-9545 / 334-252 / 334-252U / 334-253 / 09-2360 / TRK6008 / TRK6008UB / TH83-22089 / TH83-37997	15064	214
Trunnion Bushing	091200 / 60-1541 / R301332 / R307486 / N215 / N215UB / E-1332 / E-7486 / D232 / 325-137 / 325-137U / M1706 / 09-4422 / TRB5909 / NW30000	14521	211
Wear Pad	565572 / 56557-002 / 750341 / HS-55 / E-9391 / 334-833 / 09-5097 / MMB985	13524	210

**STEMCO GAFF replacement parts compatible with:
REYCO® 101 SERIES**

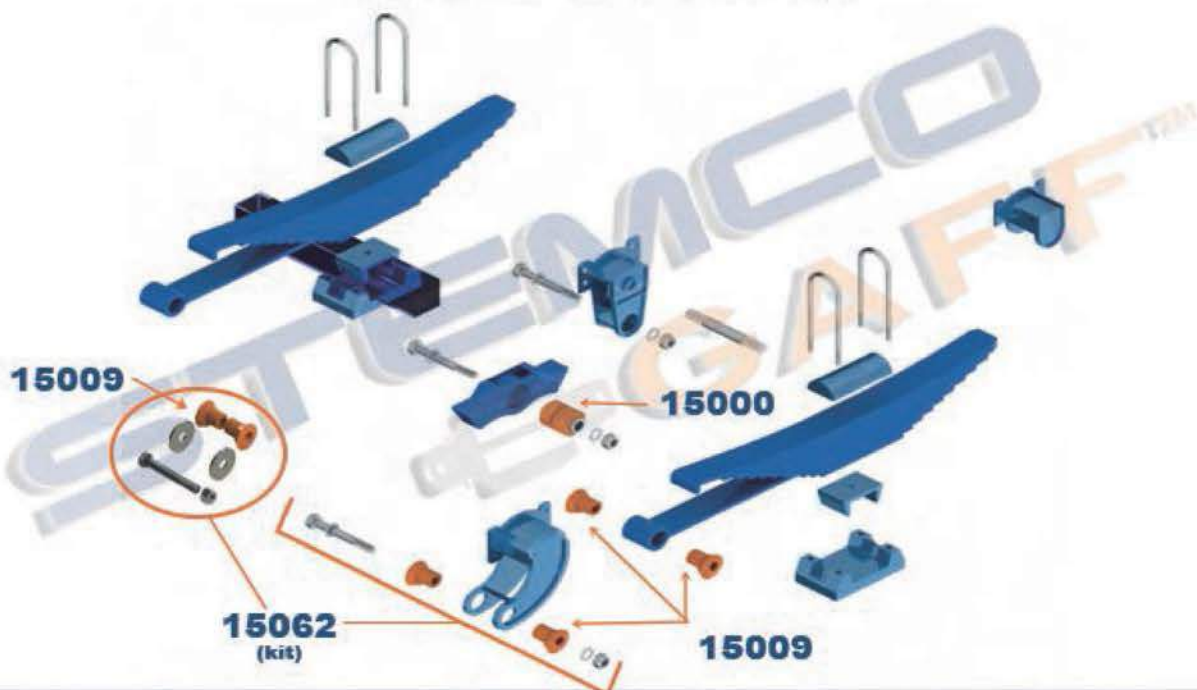

**STEMCO GAFF replacement parts compatible with:
REYCO® 102A SERIES**

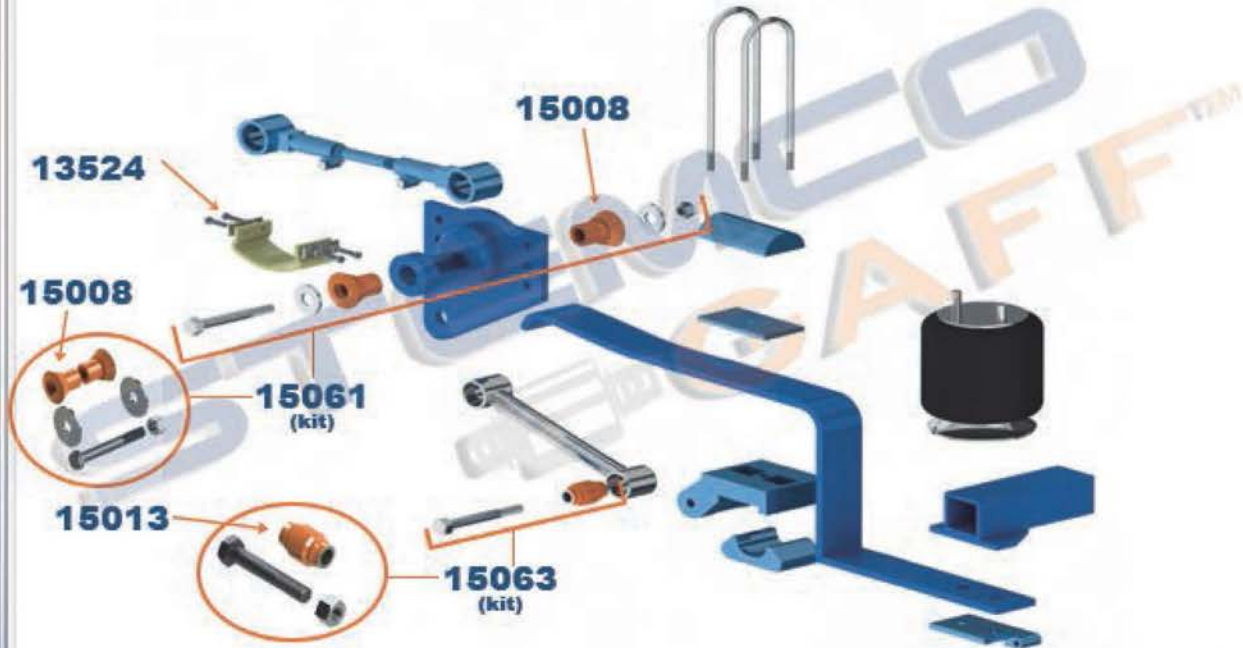
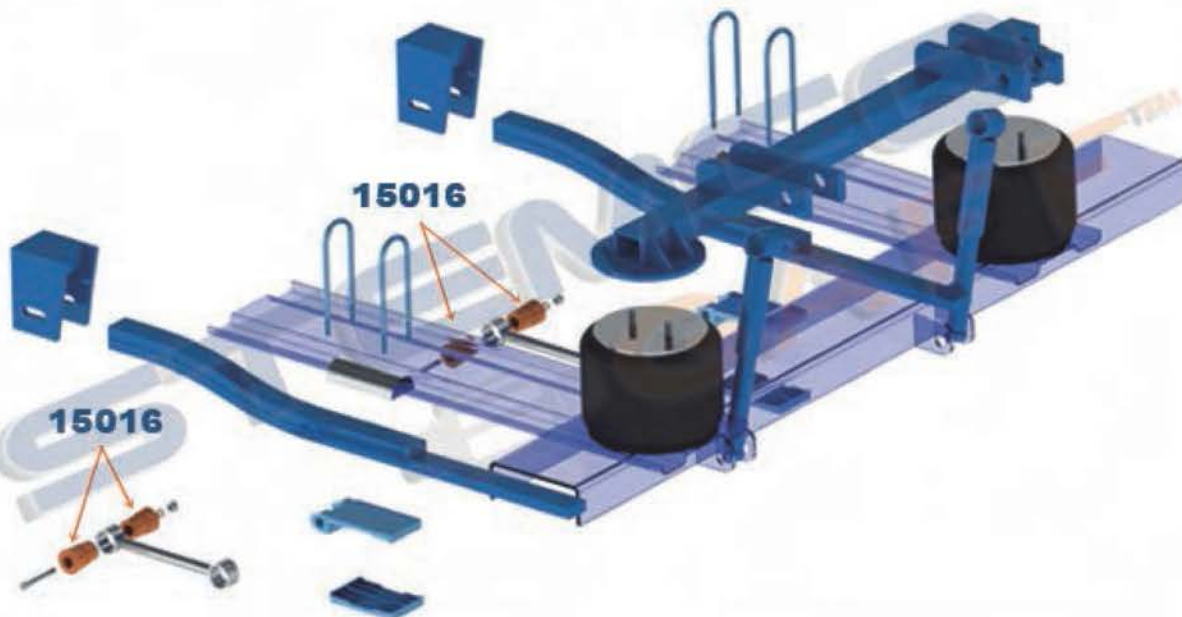

**STEMCO GAFF replacement parts compatible with:
REYCO® 102AR SERIES****STEMCO GAFF replacement parts compatible with:
REYCO® 21AR SERIES**

STEMCO GAFF replacement parts compatible with:
REYCO® 21B WIDESPREAD TANDEM
60" & 72" AXLE SPACING

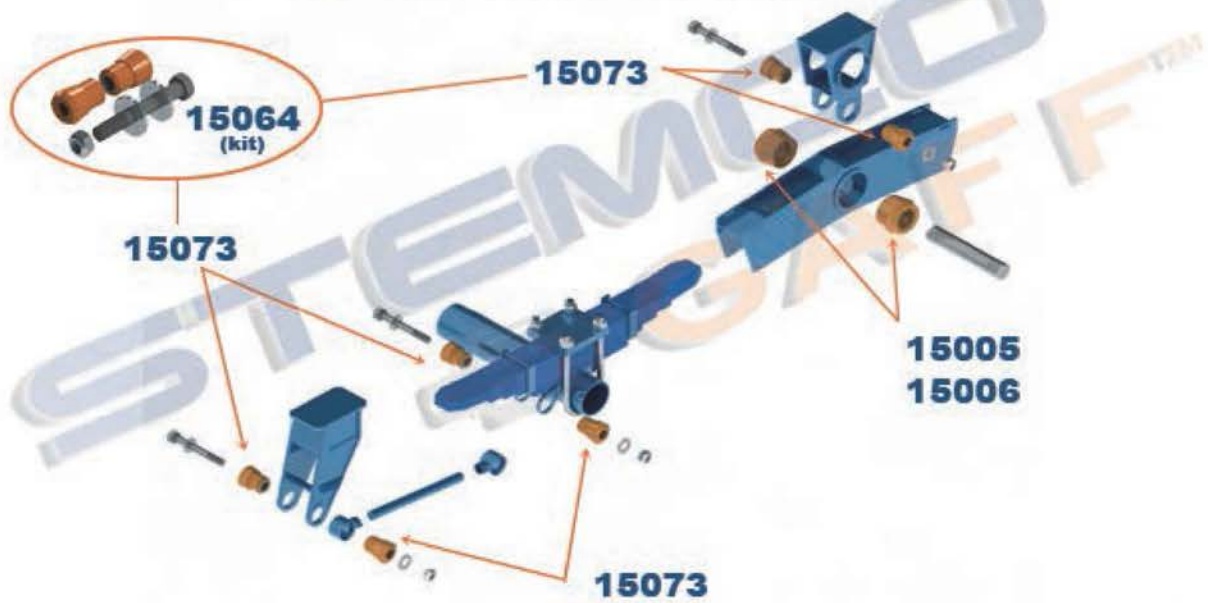

STEMCO GAFF replacement parts compatible with:
REYCO® 73, TANDEM 49" AXLE
SPACING SERIES



STEMCO GAFF replacement parts compatible with:
REYCO® 73, TANDEM 60" & 72"
AXLE SPACING SERIES



STEMCO GAFF replacement parts compatible with:
REYCO® 79KB SERIES

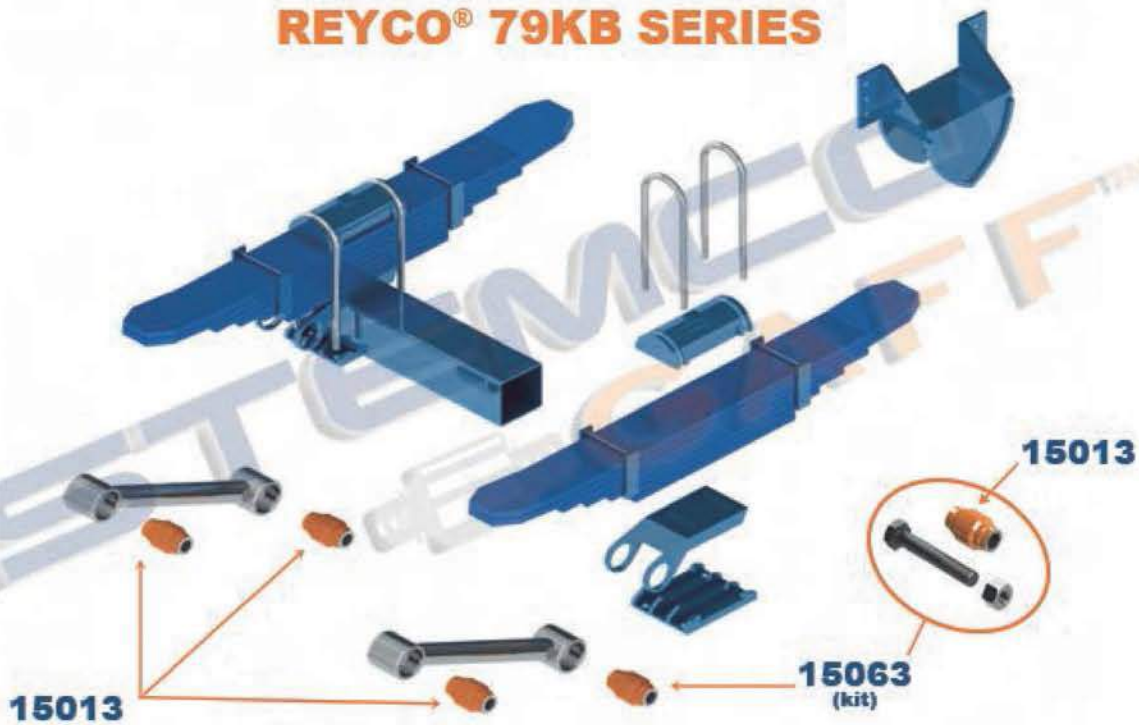

STEMCO GAFF replacement parts compatible with:
REYCO® 83, TANDEM 50", 54", 60", 65½",
72", 97" & 109" AXLE SPACING SERIES



STEMCO GAFF replacement parts compatible with:
REYCO® 86AR AIR SUSPENSION

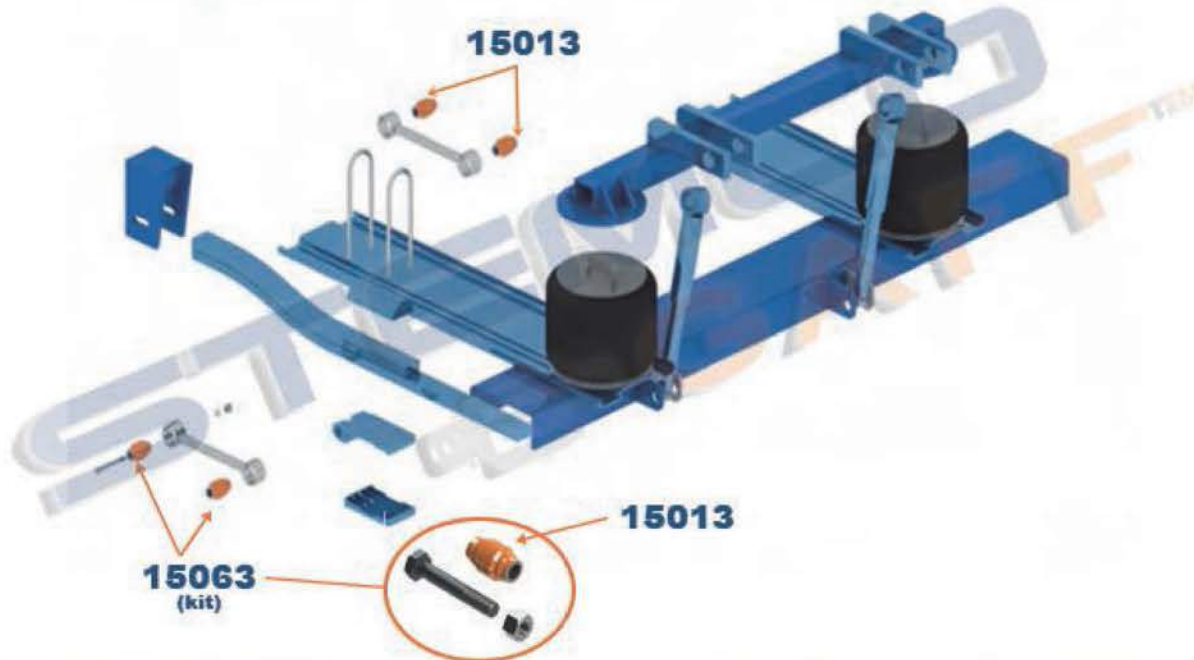

STEMCO GAFF replacement parts compatible with: REYCO®/GRANNING® 101A SERIES

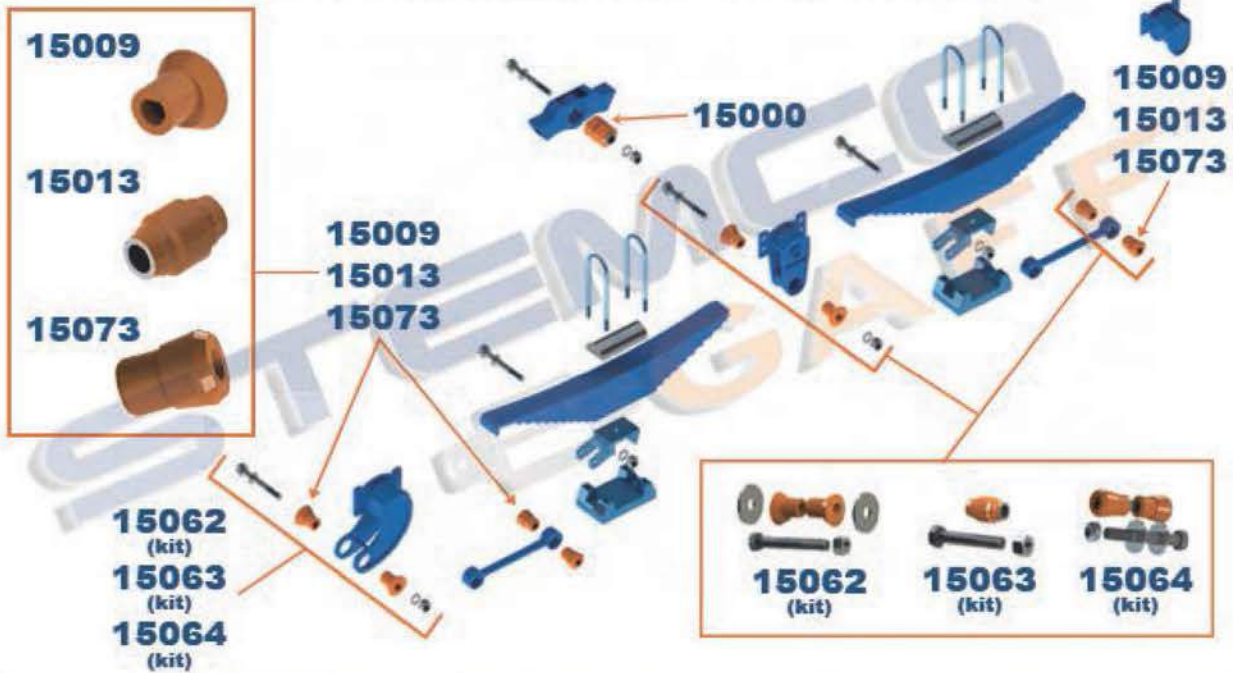

STEMCO GAFF replacement parts compatible with: REYCO®/GRANNING® 19AR/RS1062

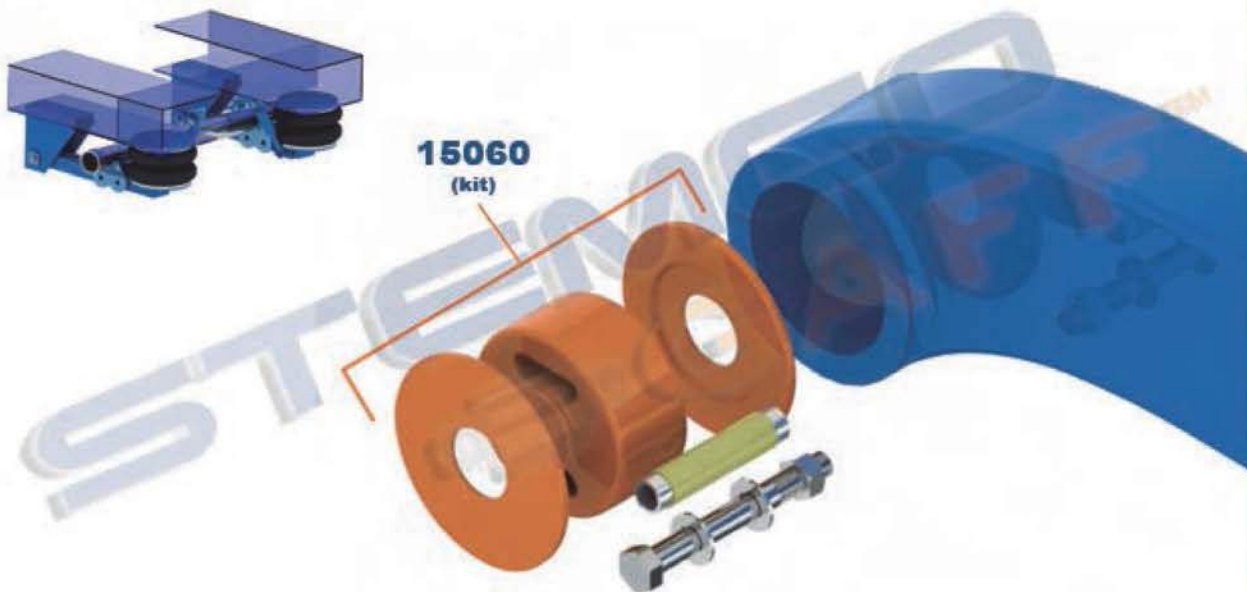

**STEMCO GAFF replacement parts compatible with:
REYCO®/GRANNING® 21B SERIES**

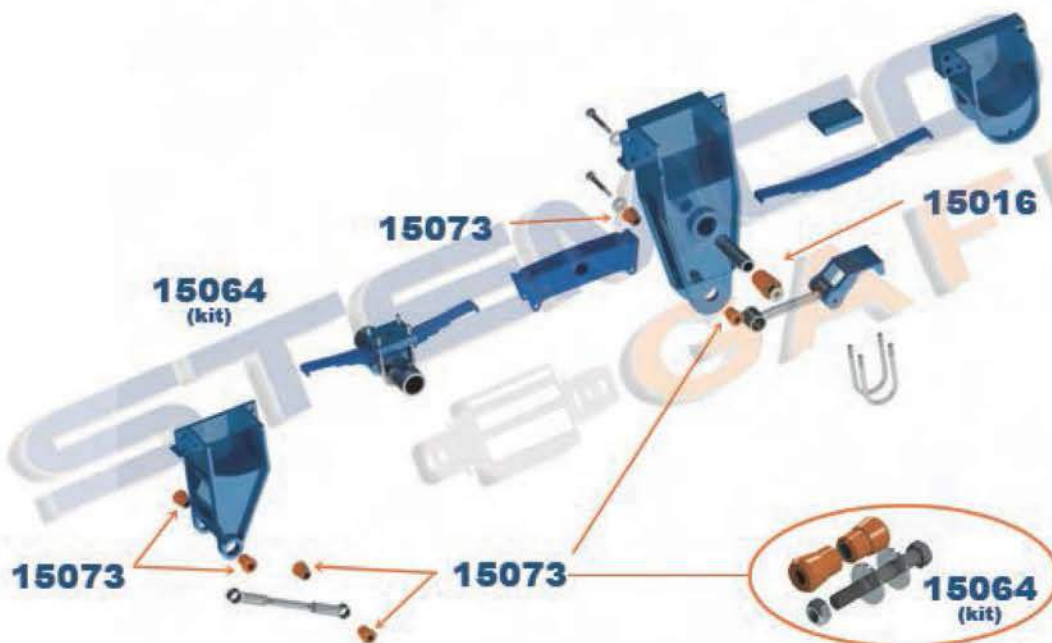

**STEMCO GAFF replacement parts compatible with:
REYCO® TRANSPRO 86/88
HEAVY WEIGHT / SUPER HEAVY WEIGHT**



Reyco continued

13502

OD 3 1/2 -
OD< 2 1/2 -
LG 8 -



Beam End Adapter

INCLUDED IN:
13504

OEM
14354-01
20-802
R302372
HAK34
E-2372
334-108
M2010
HAK92
AK34100

Notes: used with 13501 and 13503

13524

WD 3 -
LG 6 3/4 -
HGT 2 7/8 -
HD 710 -



Wear Pad

OEM
565572
56557-002
750341
HS-55
E-9391
334-833
09-5097
MMB985

Notes:

13543

OD 4 3/4 -
ID 2 1/2 -
LG 12 -
HD 80A -



Center Bushing
Loose Plug

OEM
17212-01
20-820
R301595
R306980
R309510
C867
C867UB
C888
E-1595
E-6980

Notes: standard-loose plug / double bonded-welded plug - 13636 / standard-welded plug - 13505

13553

OD 4 3/8 -
ID 2 1/2 -
LG 5 3/4 -
HD 80A -



Beam End Bushing

INCLUDED IN:
13587

TOOLS 13563, 13588

OEM
1003
14339-01
20-810PU
R301341A
R302771
C862
C862UB
C871
E-1341A
E-2771

Notes: uncrimped sleeve double bonded bushing / supersedes 13506 / use adapter 13507 for complete repair / additional tool suggestion 13595

13609

OD 3 1/2 -
OD< 1 1/8 -
LG 8 11/16 -
HD Steel -



Beam End Adapter Kit

INCLUDED IN:
13566

OEM
127000
20-801
R309420
HAK44
E-9420
334-127
334-467
09-5462
HAK112
AK38200

Notes: supersedes 13540 / for use with 13506

14000

OD 3 5/16 -
LG 3 7/8 -
BH 3/4 -
HD 80A -



Equalizer Bushing

OEM
064200
076800
25-705PU
R301999A
R307452
H102
E-1999A
E-7452
D95
321-176U

Notes:

14001

OD 3 5/16 -
LG 4 7/16 -
BH 3/4 -
HD 80A -



Equalizer Bushing

OEM
0770-00
65-1905
R303394A
TM109
E-3394A
321-220
09-1218
TRB5496

Notes:

14002

OD 3 5/16 -
ID 1 -
LG 4 -
HD 80A -



Equalizer Bushing

OEM
16095-01
T3214
R307712
E-7712
321-193
321-268
09-2478
TRB5543

Notes:

14003



Torque Rod Bushing

OD	2 3/16	~
OD<	1 13/16	~
ID	1 1/4	~
LG	2 3/8	~
HD	90A	

OEM
090600
25-750PU
RB200
E-7433
E-927
321177U
D100
M1818
09-2247
TRB6300

Notes: no inner sleeve flat sides / uses bolt 13015 / 13001- hard poly inner sleeve

14008



Torque Rod Bushing

OD	1 15/16	~
ID	1	~
LG	3	~
HD	80A	

OEM
026900
25-708PU
R307453
R30934
RB201
RBT201
E-7453
E-934
D94
321-175

TOOL 18836

Notes: chamfered / stepped ends - 14073

14010



Torque Rod Bushing

OD	2	~
ID	7/8	~
LG	3	~
HD	80A	

INCLUDED IN:
11795, 12397

OEM
13945-01
55-130
R303362
R305276
R208
E-3362
E-5276
321-162
09-2497
TRB6025

TOOL 18836

Notes: additional tool suggestion coming soon 40124

14073



Torque Rod Bushing

OD	1 15/16	~
ID	1	~
LG	3	~
HD	80A	

OEM
026900
25-708PU
R307453
R30934
RB201
RBT201
E-7453
E-934
D94
321-175

TOOL 18836

Notes: stepped ends / new design / chamfered - 14008

14504



Beam End Bushing

OD	2 3/8	~
ID	1 1/4	~
LG	5	~
HD	80A	

OEM
093000
60-1540PU
N109
E-2940
E-8677
D240
325-235U
M2118
09-4410
TRB5721

Notes:

14509



Axle Pad

THK	3/4	~
WD	5	~
LG	9	~
HD	80A	

OEM
093400
60-1507
N247
E-2945
E-8679
D356
325-141
M1486
09-4433
M8358

Notes:

14521



Trunnion Bushing

OD	5	~
ID	4	~
LG	8 3/4	~
HD	80A	

OEM
091200
60-1541
R301332
R307486
N215
N215UB
E-1332
E-7486
D232
325-137

Notes:

14522



Axle Pad

THK	3/4	~
WD	4 1/2	~
LG	5 1/8	~
HD	80A	

OEM
091000
60-1527
60-1546PU
R301330
R308669
R308670
N254
E-1330
E-8669
E-8670

Notes:

Reyco continued

14532



Beam End Bushing

OD	3 7/8"
C-C	8 1/2"
BH	1"
HD	80A

OEM
092600
N110
E-2936
321-178
TRB5712

TOOL 18831

Notes: additional tool suggestion 13588

15000



Equalizer Bushing

OD	3 1/8"
ID	1 1/4"
LG	4 1/2"
HD	80A

OEM
08915-01
146282-01
55-117
R302850
R161
E-2850
321-159
M2938
TRB5028
PL1149

Notes:

15001



Equalizer Bushing

OD	3 1/8"
ID	1 1/2"
LG	4 1/2"
HD	80A

OEM
08363-01
14713-01
T-5644
55-152PU
R301966
R303977
R308654
R209
E-3977
E-8654

Notes: supersedes 15021

15004



Equalizer Bushing

OD	3 1/4"
ID	2"
LG	4 1/2"
HD	80A

OEM

Notes: chamfered with center groove / verify dimensions compare to 15017 - chamfered inner metal bushing

15005



Equalizer Bushing

OD	4 1/16"
ID	2 3/8"
LG	2 9/16"
HD	80A

OEM
T-2101
T-2102
55-190PU
R30813
R308694
E-813
E-8691
E-8694
321-149
321-149U

Notes:

15006



Equalizer Bushing

OD	4"
ID	2 1/2"
LG	2 1/2"
HD	80A

OEM

Notes:

15008



Torque Rod Bushing

OD	3 1/8"
OD<	1 13/16"
ID	1 1/16"
LG	2 13/16"
HD	80A

INCLUDED IN:
15061

OEM
T-1842
55-128PU
R150UB
E-7521
E-812
D72
321-158
321-158U
M1846
TRB6002

Notes: verify dimensions compare to 15020 - inner sleeve

15009



Torque Rod Bushing

OD	3 1/16"
OD<	1 13/16"
ID	1 1/16"
LG	2 7/8"
HD	80A

INCLUDED IN:
15062

OEM
T-1723
55-134PU
R301964
R127
E-8689
321-157U
M1751
TRB6062

Notes:

15011



Torque Rod Bushing

OD	2 5/16"
OD<	1 13/16"
ID	1"
LG	2 9/16"
HD	80A

OEM
T-5493
 55-132PU
 R301160
 R307523
 E-1160
 E-7523
 D71
 321-145
 321-145U
 M1718

Notes: verify dimensions compare to 15019 or 15073

15013



Torque Rod Bushing

OD	1 15/16"
ID	3 7/8"
LG	3"
HD	80A

INCLUDED IN:
15063

OEM
09729 01
09729-01
 55-129
 55-129PU
 R301980
 R307520
 R129
 R129UB
 E-1061
 E-1980

Notes: additional tool suggestions 18836, coming soon 40124

15016



Equalizer Bushing

OD	3 3/8"
ID	1 5/8"
LG	4 1/2"
HD	80A

OEM
T-5524
 55-103PU
 R301159
 R308653
 R110UB
 E-1159
 E-8653
 D59
 321-146U
 M1719

Notes:

15017



Equalizer Bushing

OD	3 3/16"
ID	2"
LG	3 7/8"
HD	80A

OEM
T-3214
 55-191PU
 R301072
 R308688
 R132
 VV2
 E-8688
 D76
 321-154U
 M1869

Notes: chamfered inner metal bushing / verify dimensions compare to 15004 - chamfered with center groove

15019



Torque Rod Bushing

OD	2 3/8"
OD<	1 13/16"
ID	1"
LG	2 3/4"
HD	80A

OEM
T-5493
 55-132PU
 R301160
 R307523
 E-1160
 E-7523
 D71
 321-145
 321-145U
 M1718

Notes: verify dimensions compare to 15011 or 15073

15020



Torque Rod Bushing

OD	3 1/8"
OD<	1 13/16"
ID	1 1/16"
LG	2 11/16"
HD	80A

OEM
21238-01
T1842
 55-11012
 55-11012PU
 E10057
 R3010057
 R150
 R235
 E-10057
 E-9579

Notes: inner Sleeve / verify dimensions compare to 15008

15051



Torque Rod Bushing

OD	2 3/8"
OD<	1 13/16"
ID	1"
LG	2 13/16"
HD	80A

OEM
T-2242
 55-131PU
 R301982
 R307522
 R131
 R131UB
 E-1982
 E-7522
 D70
 321-147

Notes: supersedes 15010

15054



Equalizer Bushing

OD	3 7/16"
ID	1"
LG	4"
HD	80A

OEM
0649-02
 55-144
 R304827
 TP110
 E-4827
 321-194
 321-194U
 M1694
 TRB5544
 EQ83-35902

Notes:

Reyco continued

15059

OD	2 1/2"
OD<	1 1/2"
LG	7 3/4"
THR	1" - 8" UNC

OEM
11147-01
334-1262
09-2836



Equalizer Bolt

Notes:

15060

OD	6 5/16"
ID	1 1/4"
LG	4 1/2"
HD	80A

OEM

Suspension Bushing Kit

INCLUDES
QTY 1 Bolt 3/8"-14UNF x 7 1/2"
QTY 1 Lock Nut 3/8"-14UNF
QTY 2 Flat Washers
QTY 1 Sleeve

Notes: compatible with Reyco Air-Ride - Dock master

15061

INCLUDES
QTY 2 15008
QTY 1 Bolt 1"-14 x 7 1/2" G8
QTY 1 Lock Nut 1"-14UNF
QTY 2 Flat Washer 3/4"

OEM
TK21640
55-146
R309350
R234
E9350
334-896
09-228202
TRK6002
TH83-37640



Torque Rod Bushing Kit

Notes:

15062

INCLUDES
QTY 2 15009
QTY 1 Bolt 1"-14 x 7 1/2" G8
QTY 1 Lock Nut 1"-14UNF
QTY 2 Flat Washers
1" x 1/4" THK

OEM

Torque Rod Bushing Kit

Notes: offset / compatible with Reyco

15063

INCLUDES
QTY 1 15013
QTY 1 Hex Bolt 3/4"-12 x 5 1/2"
QTY 1 Lock Nut 3/4"-12 UNF

OEM
TK7302
55-11001
R002
E-1981
E-9552
334-247
TH83-22302



Torque Rod Bushing Kit

Notes:

15064

INCLUDES
QTY 2 15073
QTY 1 Bolt 1"-14 UNF x 7"
QTY 1 Nut 1"-14 UNF
QTY 2 Flat Washers
1" x 1/4" THK

OEM
TK18997
TK19089
R301983
R001
R003
E-1312
E-1983
E-9545
334-252
334-252U



Torque Rod Bushing Kit

Notes: compatible with Reyco 21B

15073

OD	2 3/8"
OD<	1 13/16"
ID	1"
LG	3 1/2"
HD	80A

OEM
T-5493
55-132PU
R301160
R307523
E-1160
E-7523
D71
321-145
321-145U
M1718



Torque Rod Bushing

INCLUDED IN:
15064

Notes: verify dimensions compare to 15011 or 15019

18956

OD	3 3/16"
ID	1 1/2"
LG	5 5/8"
HD	80A

OEM
13805-01
R309550
R251
E-9550
321-270



Beam End Bushing

Notes:

Ridewell

DESCRIPTION	OEM	PART ID	PAGE
Beam End Adapter	1307564B000 / 20-800 / HAK38 / E-2374 / 334-109 / HAK100	13507	217
Beam End Bushing	1110594B000 / 20-809PU / R301340 / R309511 / C865 / C865UB / E-1340 / E-9511 / D404 / D404 / 321-120 / 321-120U / M1724 / 09-5501 / M1976 / EB34000	13501	217
Beam End Bushing		13506	217
Beam End Bushing	1116755B000 / 1117564B001 / 20-810PU / R301341A / R302771 / C862 / C862UB / C871 / E-1341A / E-2771 / E-9512 / D402 / 321-126 / 321-126U / 321-242 / M1726 / 09-5511 / 09-5728 / M1970 / M1970UB / M1988 / EB38000	13553	217
Beam End Bushing	1110512B000 / R309439 / E-9439 / 321-284 / 09-7840 / RS20230	19005	218
Beam End Bushing	1110512B000 / R309439 / E-9440 / 321-285 / 334-885 / RS20230	19008	218
Center Bushing	1117558B000 / R301338 / R309520 / 20-816 / C864 / E-1338 / E-9520 / D403 / 321-117 / 321-119 / M1725 / 09-5500 / M1974 / M1978 / CB34012	13500	217
Center Bushing	1100608B000 / 5900582B585 / R309440 / E-9440 / D150 / 325-160 / 325-160U / 09-7852 / TRB6808 / RS20210 / RS20216	19004	218
Easy-Mount Torque Rod Bushing	1117379B000 / 20-833PU / R302226 / R307639 / C879 / C879UB / E-2226 / E-4664 / E-7639 / D423 / 321-132 / 321-132U / M2070 / 09-5723 / TRB6820 / TRB6820UB / TS38000	83520	218
Load Spring	1037326D003 / 9030595D000 / 9031797D000 / R3010677 / R309437 / E-10677 / E-9437 / 334-884 / 334-885 / 09-7838 / TRB603UB / RS20220	19002	218
Load Spring	1037261C002 / 9031211B302 / 9031221B303 / R309438 / E-9438 / 334-886 / 09-7839 / RD604UB / RS20222	19003	218
Pivot Bushing	1117680B060 / 1117680B070 / 1117680B075 / 321-338 / 321-368 / RD1170 / RD1175 / PB85-360B0	11711	217
Torque Rod Assy	130310B000 / MR661 / UR661 / E-2642	12044	217
Trunnion Bushing	1100608B000 / 5900582B585 / R309440 / E-9440 / D150 / 325-160 / 325-160U / 09-7852 / TRB6808 / RS20210	11500	217



**STEMCO GAFF replacement parts compatible with:
RIDEWELL® RCA-235 COMPACT HEAVY DUTY
AIR-RIDE/AIR-LIFT, FOR AUXILIARY AXES**

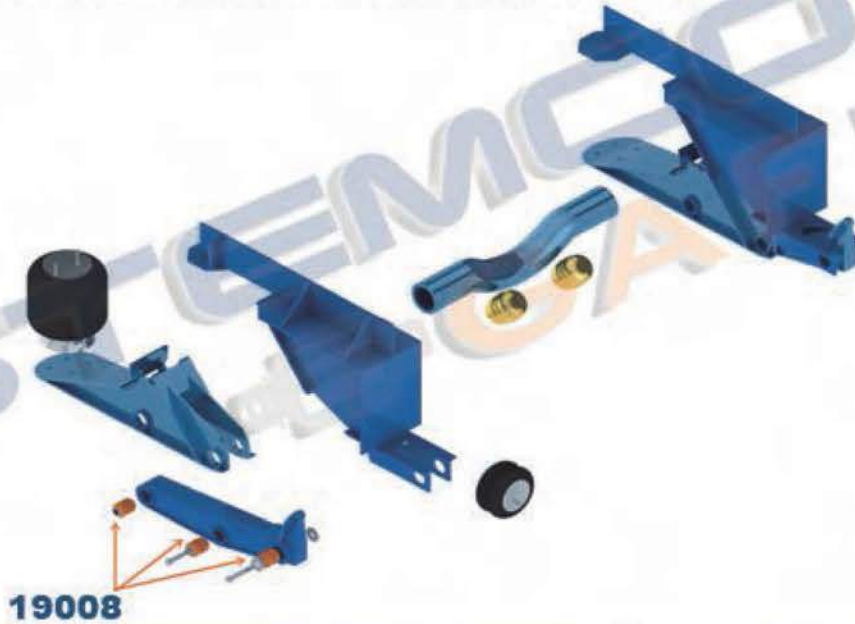

**STEMCO GAFF replacement parts compatible with:
RIDEWELL® OVERSLUNG MONOPIVOT RAR-240,
UNDERSLUNG MONOPIVOT RAR-240 SERIES**

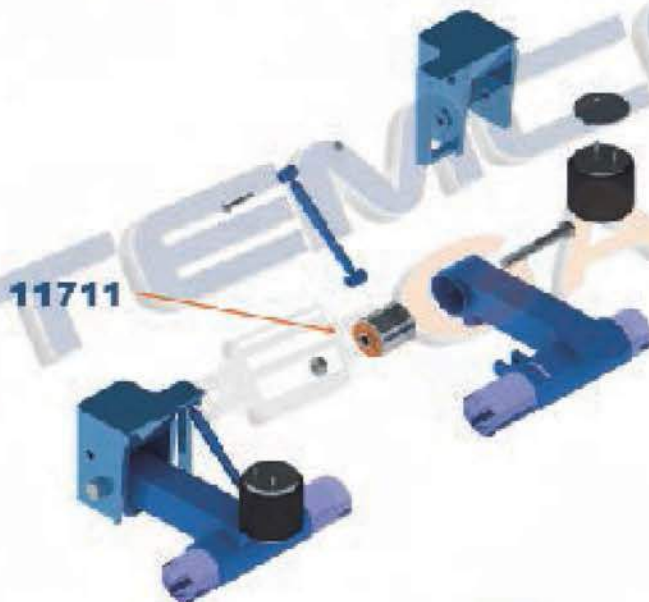

11500



Trunnion Bushing

ID	3 1/2	~
LG	4 1/2	~
LG2	4 3/16	~
HD	80A	

OEM
1100608B000
5900582B585
 R309440
 E-9440
 D150
 325-160
 325-160U
 09-7852
 TRB6808
 RS20210

Notes: used in 19004

11711



Pivot Bushing

OD	5 1/2	~
ID	1 1/2	~
LG	6 3/4	~
HD	80A	

OEM
1117680B060
1117680B070
1117680B075
 321-338
 321-368
 RD1170
 RD1175
 PB85-360B0

Notes:

12044



Torque Rod Assy Weldable

C-C	26	~
BC-C	4 3/8	~
BH	5/8	~

INCLUDES
 QTY 1 13590
 QTY 2 13520

OEM
130310B000
 MR661
 UR661
 E-2642

Notes: universal torque rod

13500



Center Bushing

OD	3 5/8	~
OD<	2 3/4	~
LG	12	~
HD	80A	

INCLUDED IN:
 13503, 13504, 13591

OEM
1117558B000
 R301338
 R309520
 20-816
 C864
 E-1338
 E-9520
 D403
 321-117
 321-119

TOOLS 18543, 18544

Notes: welded plug

13501



Beam End Bushing

OD	4 3/8	~
ID	2 1/2	~
LG	5 1/4	~
HD	80A	

INCLUDED IN:
 13503, 13504

OEM
1110594B000
 20-809PU
 R301340
 R309511
 C865
 C865UB
 E-1340
 E-9511
 D404
 D404

TOOLS 13564, 18541, 18542

Notes: for complete repair use adapter 13502 / additional tool suggestion 13588

13506



Beam End Bushing

OD	4 3/8	~
ID	2 1/2	~
LG	5 3/4	~
HD	80A	

INCLUDED IN:
 13508, 13509, 13566, 13591

OEM

TOOLS 13564, 18541, 18542

Notes: crimped sleeve / only available in kits not sold individually

13507



Beam End Adapter

OD	3 1/2	~
OD<	2 1/2	~
LG	8	~

INCLUDED IN:
 13509, 13574, 13587

OEM
1307564B000
 20-800
 HAK38
 E-2374
 334-109
 HAK100

Notes: used with 13506, 13508, 13553, 13591

13553



Beam End Bushing

OD	4 3/8	~
ID	2 1/2	~
LG	5 3/4	~
HD	80A	

INCLUDED IN:
 13587

OEM
1116755B000
1117564B001
 20-810PU
 R301341A
 R302771
 C862
 C862UB
 C871
 E-1341A
 E-2771

TOOLS 13563, 13588

Notes: uncrimped sleeve double bonded bushing / supersedes 13506 / use adapter 13507 for complete repair / additional tool suggestion 13595

Ridewell continued

19002



WD 4 --
LG 10 --
HGT 7 1/8 --
HD 90A

OEM
1037326D003
9030595D000
9031797D000
R3010677
R309437
E-10677
E-9437
334-884
334-885
09-7838

Load Spring

Notes:

19003



WD 4 1/8 --
LG 4 5/8 --
HGT 3 3/8 --
HD 80A

OEM
1037261C002
9031211B302
9031221B303
R309438
E-9438
334-886
09-7839
RD604UB
RS20222

Load Spring

Notes:

19004



OD 5 --
ID 3 1/2 --
LG 8 1/16 --
HD 80A-71D

OEM
1100608B000
5900582B585
R309440
E-9440
D150
325-160
325-160U
09-7852
TRB6808
RS20210

Center Bushing

Notes: contains 11500 / pre-assembled / some components not sold separately

19005



OD 3 --
ID 1 1/2 --
LG 4 7/16 --
HD 80A

OEM
1110512B000
R309439
E-9439
321-284
09-7840
RS20230

Beam End Bushing

Notes: metal sleeve / 19008 - no sleeve

19008



OD 3 3/16 --
ID 1 1/2 --
LG 4 7/16 --
HD 80A

OEM
1110512B000
R309439
E-9440
321-285
334-885
RS20230

Beam End Bushing

Notes: no sleeve / 19005 - metal sleeve

83520



OD 2 3/4 --
C-C 4 3/8 --
BH 5/8 --
HD 80A

OEM
1117379B000
20-833PU
R302226
R307639
C879
C879UB
E-2226
E-4664
E-7639
D423

Easy-Mount
Torque Rod Bushing

TOOLS 18551, 18833

Notes: standard - 13520 / no metal sleeve - 13536

Sterling Truck

DESCRIPTION	OEM	PART ID	PAGE
Beam End Bushing	NEW 90008139 / WCM 10050 / 60-1535 / R304382A / N120 / N120UB / E-4382A / E-8683 / D441 / 321-229 / 321-229U / M3456 / TRB5713 / PB57-21139	14513	223
Beam End Bushing	HLD90008149 / WCM11223 / 60-1501 / R304410A / N124 / E-4410A / D448 / 321-231 / 321-231U / M3454 / TRB5703 / PB57-21149	14533	223
Cab Mount	A681-891-00-01 / 10-1067PU / CM46-61891	11008	220
Cab Mount	A681-890-00-01 / CM46-61890	11009	220
Cab Mount	HUN 12004 3401 / 35-548PU / R307472 / UM1113 / E-7472 / D6 / 329-136U / M17412 / M17412UB / MM96-62401 / PL1015 / PL1015-HT	11520	222

Sterling Truck continued

DESCRIPTION	OEM	PART ID	PAGE
Cab Mount	HUN 12004 3401 / 35-548PU / R307472 / UM1113 / E-7472 / D6 / 329-136U / M17412 / M17412UB / MM96-62401 / PL1015 / PL1015-HT	11523	223
Cab Mount Kit	A681-890-00-01 / A681-891-00-01 / CM46-61001	11086	221
Carrier Bearing Assy	2101211X / DS-6048	40075	225
Fifth Wheel Bushing	FON BSH 109 L / FON BSH 172U L / FW99-32109 / FW99-32172	10079	220
Fifth Wheel Bushing	HLD XB 0011 / FW51-32011	18215	224
Fifth Wheel Bushing	HLD-XB10605 / FW99-32605	40035	224
Hood Hinge Bushing	J177005 / PL1133	11019	220
Hood Latch	17-14781-000 / HLK2001	11109	222
Motor Mount	J20941-6 / MM46-62416	11065	221
Motor Mount	BCD 26704-1 / BCD 27651-1 / BCD 27651-2 / BCD 27651-3 / BCD 28945-1 / BCD267041 / BCD276511 / BCD276512 / BCD276513 / BCD289451 / MM46-62002	11090	222
Motor Mount	C8TZ6068B / EM-2752	18433	224
Motor Mount Kit	BCD 27651 1 / BCD 27651 2 / BCD 27651 3 / MM46-62651	11073	221
Motor Mount Kit	BCD 26704-1 / BCD 27651-1 / BCD 27651-2 / BCD 27651-3 / BCD 28945-1 / BCD267041 / BCD276511 / BCD276512 / BCD276513 / BCD289451 / MM46-62002	11074	221
Motor Mount Kit	BCD 27330-1 / BCD 288051 / BCD27330 1 / MM46-62001 / MM46-62051 / MM46-62301	11077	221
Motor Mount Kit	J20941-6 / J20941-7 / MM46-62416	11088	221
Motor Mount Kit	BCD 27330 1 / BCD 27330 2 / BCD 28805 1 / BCD273301 / BCD288051 / MM46-62000	11089	222
Pivot Bushing	1117680B060 / 1117680B070 / 321-338 / 321-368 / RD1170 / RD1175 / PB85-360B0	11711	223
Radiator Mount	05-16070-000	11021	221
Radiator Mount	LOR SM10359 / MBT 6805040382 / RM46-63359	11117	222
Radiator Mount	BCD 28847 1 / RM46-63471	11129	222
Torque Rod Assy	IPC 925030 / 925030 / TR59-41375	11751	223
Spring Bushing	16-17769-00 / 680-322-01-05 / 680-322-01-50 / RB211 / RB233 / RB-211 / RB-233 / SP46-52800	11066	221
Spring Bushing		11123	222
Spring Mount	58918-000 / 593461 / 58918-000	18994	224
Spring Pin Bushing	16-14603-000 / 16-17194-000 / 16-17770-000 / 16-18023-000 / RB263 / RB-263 / MR772 / MR772UB / SP46-11023	11094	222
Torque Rod Assy	IPC 924711 / 924711 / R9247 / TR13-41022	13657	223
Torque Rod Assy	HDR 62350 615 / TR50-41615	13733	223
Torque Rod Assy	HDR 62350 645 / TR50-41645	34555	224
Torque Rod Assy	HDR 62001 590 / 924920 / 942174 / 944160 / 944220 / 948574 / TR50-42590	34556	224
Torque Rod Bushing	J-142662	13525	223
Torque Rod Bushing	HDRR005422 / E-11763 / 334-1672 / TRK4931 / PB00-26422 / SU99-39115	50033	225
Torque Rod Bushing Kit	REY TK19089 / R301983 / R001 / R003 / E-1312 / E-1983 / E-9545 / 334-252 / 334-252U / 334-253 / 09-2360 / TRK6008 / TRK6008UB / TH83-22089 / TH83-37997	15064	224
Vibration Mount	LOR CB2202-12 / 67009-3442 / CB2202-12 / 92-7620 / 92-8893 / MS99-62620	18015	224

STEMCO GAFF replacement parts compatible with:
HENDRICKSON® -AIRTEK® / WESTERN STAR® /
FREIGHTLINER® / FORD® / STERLING®

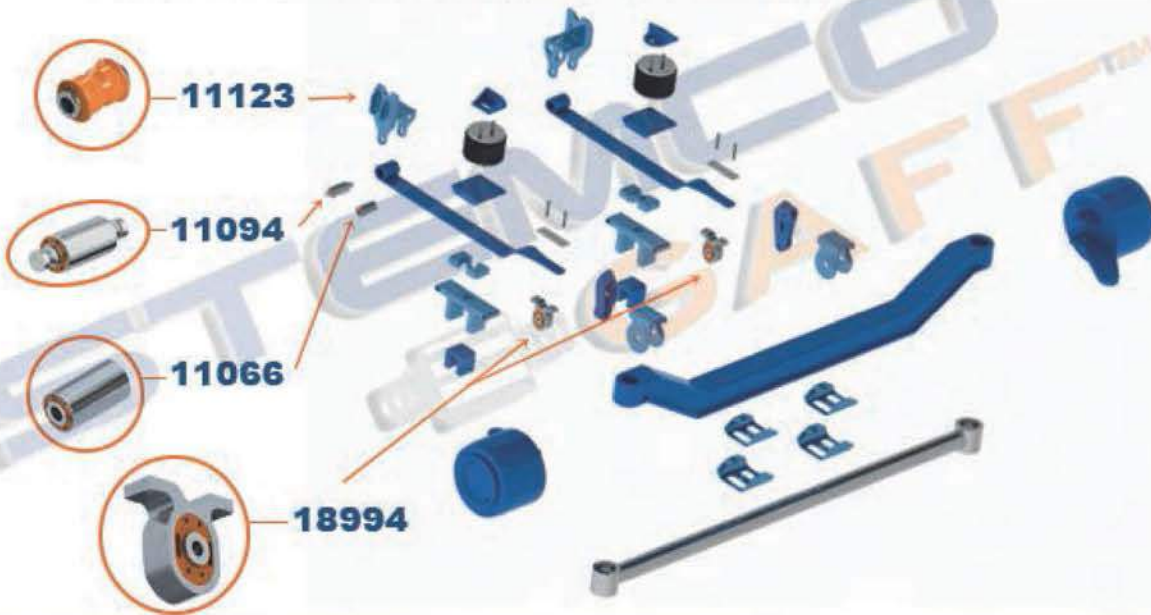

10079



Fifth Wheel Bushing

OD	3 3/16"
ID	1 1/4"
LG	2 11/16"
LG2	2 5/16"
HD	80A

OEM
 FON BSH 109 L
 FON BSH 172U L
 FW99-32109
 FW99-32172

Notes: components not sold separately

11008



Cab Mount
 Front (Lower)

OD	3 3/4"
ID	1 3/16"
LG	1 5/16"
HD	80A

INCLUDED IN:
 11086

OEM
 A681-891-00-01
 10-1067PU
 CM46-61891

Notes: for best value use kit 11086

11009



Cab Mount
 Front (Upper)

OD	3 13/16"
OD<	2 1/2"
ID	1 3/4"
LG	2 9/16"
HD	80A

INCLUDED IN:
 11086

OEM
 A681-890-00-01
 CM46-61890

Notes: for best value use kit 11086

11019



Hood Hinge Bushing

OD	1 3/8"
ID	1/2"
LG	2 3/16"
HD	80A

OEM
 J177005
 PL1133

Notes:

Sterling Truck continued

11021



Radiator Mount

OD	2 15/16"	OEM 05-16070-000
ID	1 11/16"	
LG	1 13/16"	
HD	70A	

Notes: components not sold separately

11065



Motor Mount Rear

OD	1 3/8"	OEM J20941-6 MM46-62416
BH	5/8"	
WD	2 3/8"	
LG	5 3/8"	
C-C	3"	
HD	80A	

INCLUDED IN:
11088

Notes:

11066



Spring Bushing

OD	2 1/4"	OEM 16-17769-00 680-322-01-05 680-322-01-50 RB211 RB233 RB-211 RB-233 SP46-52800
ID	1 13/16"	
LG	4 1/4"	
HD	80A	

Notes:

11073



Motor Mount

THK	1 5/16"	OEM BCD 27651 1 BCD 27651 2 BCD 27651 3 MM46-62651
WD	3 1/4"	
C-C	4"	
BH ⁽¹⁾	1 1/2"	
BH ⁽²⁾	1 7/8"	
HD	80A	

INCLUDED IN:
11074, 11090

Notes: only available in kits not sold individually

11074



Motor Mount Kit Front

WD	3 1/4"	OEM BCD 26704-1 BCD 27651-1 BCD 27651-2 BCD 27651-3 BCD 28945-1 BCD267041 BCD276511 BCD276512 BCD276513 BCD289451
LG	7 1/8"	
C-C	4"	
BH	3/4"	
HD	80A	

INCLUDES
QTY 1 11072
QTY 1 11073

INCLUDED IN:
11090

Notes: components not sold separately

11077



Motor Mount Kit Rear

WD	3"	OEM BCD 27330-1 BCD 288051 BCD27330 1 MM46-62001 MM46-62051 MM46-62301
LG	9 7/8"	
C-C	8 5/16"	
BH	9/16"	
HD	70A	

INCLUDED IN:
11089

Notes: lower mount is round design / components not sold separately / lower mount alternate option 31083 - D shape design special order only

11086



Cab Mount Kit

INCLUDES	11008	OEM A681-890-00-01 A681-891-00-01 CM46-61001
QTY 2	11009	
QTY 2	3/4" x 5" G8	
QTY 2	Lock Nuts 3/4"	
QTY 2	Flat Washers 3/4"	

Notes: kit not offered by OE

11088



Motor Mount Kit Rear

INCLUDES	11065	OEM J20941-6 J20941-7 MM46-62416
QTY 2	3/4" x 4" G8	
QTY 4	Lock Nuts 3/4"	
QTY 8	Flat Washers 3/4"	

Notes: kit not offered by OE

Sterling Truck continued

11089



Motor Mount Kit
Rear

INCLUDES
QTY 2 11077
QTY 2 3/4" X 4 1/2" G8
QTY 2 Lock Nuts 3/4"
QTY 4 Flat Washers 3/4"

OEM
BCD 27330 1
BCD 27330 2
BCD 28805 1
BCD273301
BCD288051
MM46-62000

Notes: kit not offered by OE

11090



Motor Mount
Front

INCLUDES
QTY 1 11074
QTY 2 3/4" X 4 1/2" G8
QTY 2 Lock Nuts 3/4"
QTY 4 Flat Washers 3/4"

OEM
BCD 26704-1
BCD 27651-1
BCD 27651-2
BCD 27651-3
BCD 28945-1
BCD267041
BCD276511
BCD276512
BCD276513
BCD289451

Notes: kit not offered by OE

11094



Spring Pin Bushing

OD 2 1/4"
OD< 1 1/4"
LG 6 7/8"
HD 80A

OEM
16-14603-000
16-17194-000
16-17770-000
16-18023-000
RB263
RB-263
MR772
MR772UB
SP46-11023

Notes:

11109



Hood Latch
Hook

LG 3 13/16"
HD 71D

OEM
17-14781-000
HLK2001

Notes:

11117



Radiator Mount

WD 1 13/16"
LG 3 15/16"
C-C 1 3/4"
BC-C 2 3/8"
THR 3/4" x 1" - UNC
HGT 1 5/8"
HD 80A

OEM
LOR SM10359
MBT 6805040382
RM46-63359
SM1035 9

Notes: verify dimensions compare to 11144

11123



Spring Bushing
Front

OD 2"
ID 1 3/16"
LG 3 1/4"
HD 80A

OEM

Notes: sleeveless bushing for leaf springs / bushing with sleeve is 11133 / compatible with AirTek leaf spring on FLD Columbia

11129



Radiator Mount

TWK 1 1/4"
WD 3 7/8"
LG 4"
C-C 1 1/4"
C-C 1 7/8"
HD 70A

OEM
BCD 28847 1
RM46-63471

Notes: compatible with FLD Century Class

11520



Cab Mount
W / Metal Sleeve

OD 2 7/8"
OD< 1 7/8"
ID 5/8"
LG 1 5/16"
HD 80A

OEM
HUN 12004 3401
35-548PU
R307472
UM1113
E-7472
D6
329-136U
M17412
M17412UB
MM96-62401

Notes: metal bushing stepped design/ verify dimensions compare to 11523 or 11552

Sterling Truck continued

11523



OD	2 7/8 ~
OD<	1 13/16 ~
ID	5/8 ~
LG	1 5/16 ~
HD	80A

OEM
HUN 12004 3401
 35-548PU
 R307472
 UM1113
 E-7472
 D6
 329-136U
 M17412
 M17412UB
 MM96-62401

**Cab Mount
W / Metal Sleeve**

Notes: metal sleeve / supersedes 11519 - standard / verify dimensions compare to 11523 or 11552

11711



OD	5 1/2 ~
ID	1 1/2 ~
LG	6 3/4 ~
HD	80A

OEM
1117680B060
1117680B070
 321-338
 321-368
 RD1170
 RD1175
 PB85-360B0

Pivot Bushing

Notes:

11751



C-C	24 ~
B-C-C	4 3/8 ~
HD	80A

INCLUDES
 QTY 1 11754
 QTY 2 13520

OEM
IPC 925030
 925030
 TR59-41375

Torque Rod Assy

Notes:

13525



OD	3 1/2 ~
C-C	4 3/8 ~
BH	5/8 ~
HD	80A

OEM
J-142662

Torque Rod Bushing

TOOL 18831

Notes:

13657



C-C	22 ~
-----	------

INCLUDES
 QTY 1 13629
 QTY 1 13520
 QTY 1 13518

OEM
IPC 924711
 924711
 TMR9247
 TR13-41022

Torque Rod Assy

Notes:

13733



C-C	14 3/8 ~
BC-C	4 3/8 ~
BH	5/8 ~
THR	1 1/4" - 12UNF

INCLUDES
 QTY 1 13520
 QTY 1 13518

OEM
HDR 62350 615
 TR50-41615

Torque Rod Assy

Notes:

14513



OD	3 1/2 ~
ID	1 1/8 ~
LG	5 1/4 ~
HD	80A

OEM
NEW 90008139
WCM 10050
 60-1535
 R304382A
 N120
 N120UB
 E-4382A
 E-8683
 D441
 321-229

Beam End Bushing

Notes: additional tool suggestion 14531

14533



OD	2 13/16 ~
ID	1 1/8 ~
LG	5
HD	80A

OEM
HLD90008149
WCM11223
 60-1501
 R304410A
 N124
 E-4410A
 D448
 321-231
 321-231U
 M3454

Beam End Bushing

Notes: supersedes 14528 / additional tool suggestion 14531

Sterling Truck continued

15064



Torque Rod Bushing Kit

INCLUDES
 QTY 2 15073
 QTY 1 Bolt 1"-14 UNF x 7"
 QTY 1 Nut 1"-14 UNF
 QTY 2 Flat Washers
 1" x 1/4" THK

OEM
REY TK19089
 R301983
 R001
 R003
 E-1312
 E-1983
 E-9545
 334-252
 334-252U
 334-253

Notes: compatible with Reyco 21B

18015



Vibration Mount

OD	1 7/8	--
OD<	1 5/16	--
ID	1/2	--
LG	2	--
HD	70A	--

OEM
LOR CB2202-12
 67009-3442
 CB2202-12
 92-7620
 92-8893
 MS99-62620

Notes: components not sold separately

18215



Fifth Wheel Bushing

OD	2	--
ID	1 1/8	--
LG	4 1/4	--
HD	80A	--

OEM
HLD XB 0011
 FW51-32011

Notes: no groove / verify dimensions compare to 18094

18433



Motor Mount

ID	13/16	--
THK	2 5/16	--
WD	3 3/16	--
LG	5	--
HD	80A	--

OEM
C8TZ6068B
 EM-2752

Notes:

18994



Spring Mount Rear

ID	13/16	--
WD	2	--
C-C	5	--
HD	80A	--

INCLUDED IN:
 13725

OEM
 58918-000
 593461
 58918-000

Notes:

34555



Torque Rod Assy

LG	8 1/4	--
C-C	25 1/4	--
BC-C	4 3/8	--
BH	5/8	--
THR	1 1/2 - 12 UNF	--

INCLUDES
 QTY 1 13520
 QTY 1 13518

OEM
HDR 62350 645
 TR50-41645

Notes:

34556



Torque Rod Assy

C-C	23 1/4	--
BC-C	4 3/8	--
BH	5/8	--

INCLUDES
 QTY 2 13520

OEM
HDR 62001 590
 924920
 942174
 944160
 944220
 948574
 TR50-42590

Notes:

40035



Fifth Wheel Bushing Kit

OD	3 7/8	--
OD<	2 5/16	--
ID	1 5/32	--
LG	2 1/16	--
HD	80A	--

OEM
HLD-XB10605
 FW99-32605

Notes: components not sold separately

Sterling Truck continued

40075



Carrier Bearing Assy

ID C-C 2 -
BH 7 7/16 -
HGT 1/2 -
HD 2 25/32 -
70A

OEM
2101211X
DS-6048

Notes: includes carrier bearing bushing 18725

50033



Torque Rod Bushing

INCLUDES
QTY 2 34514
QTY 1 Pivot Bolt 7/8 -
16 UNF x 6 G8
QTY 1 Lock Nut 7/8
QTY 1 Flat Washer 7/8
QTY 1 Sleeve 1 1/2 x 3/4 x 3"

OEM
HDDR005422
E-11763
334-1672
TRK4931
PB00-26422
SU99-39115

Notes: coming soon call tech department

Trailers

DESCRIPTION	OEM	PART ID	PAGE
Axle Pad	90.6011 / 15898 / 21092 / 60-1527 / 60-1546PU / R301330 / R308669 / R308670 / N254 / E-1330 / E-8669 / E-8670 / D231 / D352 / 325-139U / 325-142 / 325-142U / 09-4424 / MTN456 / MTN457 / PL1041	14522	232
Beam End Bushing	1027037 / 20-809PU / R301340 / R309511 / C865 / C865UB / E-1340 / E-9511 / D404 / D404 / 321-120 / 321-120U / M1724 / 09-5501 / M1976 / EB34000	13501	230
Beam End Bushing	1027038 / 20-810PU / R301341A / R302771 / C862 / C862UB / C871 / E-1341A / E-2771 / E-9512 / D402 / 321-126 / 321-126U / 321-242 / M1726 / 09-5511 / 09-5728 / M1970 / M1970UB / M1988 / EB38000	13553	230
Beam End Bushing	1090237 / 60-1532 / R304255 / R307485 / N119 / N119UB / E-4255 / E-7485 / D235 / 321-227 / 321-227U / M3265 / TRB5710 / TRB5710UB / PL1154	14510	231
Beam End Bushing	NEW900-08-139 / NW900-08-139 / NEW900-08-139 / 60-1535 / R304382A / N120 / N120UB / E-4382A / E-8683 / D441 / 321-229 / 321-229U / M3456 / TRB5713 / PB57-21139	14513	232
Beam End Bushing	NEW900-08-149 / NW900-08-149 / NEW900-08-149 / 60-1501 / R304410A / N124 / E-4410A / D448 / 321-231 / 321-231U / M3454 / TRB5703 / PB57-21149	14533	232
Camshaft Bushing	382517	17500	233
Camshaft Bushing	381571 / E-1571	17502	233
Camshaft Bushing	700734 / 700762 / E-1567	17505	234
Camshaft Bushing	7-6-17 / E-536	17538	234
Camshaft Bushing	15109	17574	234
Camshaft Bushing	700768 / E-1577A	17668	234
Center Bushing	20-817 / R301339 / R306979 / R309359 / C863 / C877 / C887 / E-1339 / E-6979 / E-9359 / D401 / 321-122 / 321-124 / 321-243 / M1727 / 09-5510 / 09-5512 / 09-5513 / M1972 / M1972UB / CB38012	13505	230
Center Bushing	20600071 / 321-377 / PB99-26071	13539	230
Equalizer Bolt	LXA-0015001 / 15-1204 / FR267 / E-1019 / 334-453A / M1807 / TRS4309	13011	229
Equalizer Bushing	32460848 / 25-705PU / R301999A / R307452 / H102 / E-1999A / E-7452 / D95 / 321-176U / M1452 / 09-3351 / TRB5541 / TRB5541UB / EQ53-35234	14000	230
Equalizer Bushing	3-12-32 / 65-1905 / R303394A/109 / E-3394A / 321-220 / 09-1218 / TRB5496	14001	230
Equalizer Bushing	16571 / 55-103PU / R301159 / R308653 / R110UB / E-1159 / E-8653 / D59 / 321-146U / M1719 / TRB5066 / EQ83-11000	15016	232
Equalizer Bushing	L1025 / 21303 / 3-12-20 / 55-191PU / R301072 / R308688 / R132 / VV2 / E-8688 / D76 / 321-154U / M1869 / TRB5023	15017	232
Equalizer Bushing	0649-02 / 55-144 / R304827 / TP110 / E-4827 / 321-194 / 321-194U / M1694 / TRB5544 / EQ83-35902	15054	233
Equalizer Bushing	SP7165	18700	235
Equalizer Bushing	SP7155	18701	235
Fifth Wheel Bushing	HHXB-0011 / FW51-32011	18215	234
Hinge Bushing Kit	37.3005R / R307518 / E-7518 / D250 / 320-165U / PL1079	18558	234

Trailers continued

DESCRIPTION	OEM	PART ID	PAGE
Pivot Bushing	61610013 / SP1431	18710	236
Pivot Bushing	61610012 / SP1432	18711	236
Shock Absorber Bushing	90.8005 / R307474 / E-7474 / 320-178 / 320-178UB / MH1433 / MH1433UB / PL1028	18244	234
Shock Absorber Bushing	SP7128	18696	235
Shock Absorber Bushing	SP7119	18697	235
Spring Pad	S7096 / 90.6013 / R303582 / R308664 / FR220 / E3582 / E-3582 / E-8664 / D217 / 325-151 / 325-151U / 09-2274 / M9632 / M9632UB / PL1005	13037	230
Suspension Bushing	400329 / R307457 / E-7457 / 320-182 / 320-182U / PL1061	18256	234
Suspension Bushing	90008247	50046	236
Suspension Bushing Kit	SRK-530	50047	236
Torque Rod Bolt	UXA-000016 / E-1018 / 334-566 / TRS3309	13015	229
Torque Rod Bushing	GDH7620-00 / 7620-00 / 25-750PU / R307433 / R30927 / RBT200 / RBT200UB / E-7433 / E-927 / D100 / 321-177 / 321-177U / M1818 / TRB6300 / TRB6300UB / PL1084	13001	229
Torque Rod Bushing	31339 / 25-750PU / RB200 / E-7433 / E-927 / 321177U / D100 / M1818 / 09-2247 / TRB6300	14003	231
Torque Rod Bushing	3-12-6 / 38788 / 3-12-16 / 65-1908 / R30640 / RB202 / E-640 / 321-294 / TRB6332	14004	231
Torque Rod Bushing	12855 / 3-12-35 / 15209 / 31219 / 2530037 / 32460730 / 25-708PU / R307453 / R30934 / RB201 / RBT201 / E-7453 / E-934 / D94 / 321-175 / 321-175U / M1888 / 09-3344 / TRB6326 / TRB6326UB / PL1119	14008	231
Torque Rod Bushing	221394501 / 55-130 / R303362 / R305276 / R208 / E-3362 / E-5276 / 321-162 / 09-2497 / TRB6025 / TH50-22692	14010	231
Torque Rod Bushing	16592 / 25-741PU / H151 / E-7454 / D99 / 321-173U / M1848 / 09-3341 / TRB6330	14011	231
Torque Rod Bushing	12855 / 3-12-35 / 15209 / 31219 / 2530037 / 32460730 / 25-708PU / R307453 / R30934 / RB201 / RBT201 / E-7453 / E-934 / D94 / 321-175 / 321-175U / M1888 / 09-3344 / TRB6326 / TRB6326UB / PL1119	14073	231
Torque Rod Bushing	16640 / 55-128PU / R150UB / E-7521 / E-812 / D72 / 321-158 / 321-158U / M1846 / TRB6002 / TRB6002UB / PL1117	15008	232
Torque Rod Bushing	09729-01 / L1032 / 90.7010 / 0022-00 / A-1712 / 55-129 / 55-129PU / R301980 / R307520 / R129 / R129UB / E-1061 / E-1980 / E-7520 / E-8687 / D73 / 39400016 / 321-153 / 321-153U / M1449 / TRB6004 / TRB6004UB / PL1118 / UB30000	15013	232
Torque Rod Bushing	L1132 / 55-131PU / R301982 / R307522 / R131 / R131UB / E-1982 / E-7522 / D70 / 321-147 / 321-147U / M1845 / TRB6000 / TRB6000UB / PL1115	15051	233
Torque Rod Bushing	SP7111	18689	235
Torque Rod Bushing	SP1324	18690	235
Torque Rod Bushing	SP7109	18691	235
Torque Rod Bushing	SP7110	18692	235
Torque Rod Bushing	KF88-051400	40089	236
Torque Rod Bushing	MTRKIT11126 / RWKIT1126 / E-11763 / 334-1672 / TRK4931 / PB00-26422 / SU99-39115	50033	236
Torque Rod Bushing Kit	GDH7620-00 / 3-69-2 / 7637-00 / 15-1217 / FR266 / H236 / E-1023 / E-9362 / 334-565 / 334-640 / TRK6300 / TRK6300UB / TH47-37900 / TH53-37637	13042	230
Torque Rod Bushing Kit	SB1745 / 55-146 / R309350 / R234 / E9350 / 334-896 / 09-228202 / TRK6002 / TH83-37640	15061	233
Torque Rod Bushing Kit		15062	233
Torque Rod Bushing Kit	L1032 / 55-11001 / R002 / E-1981 / E-9552 / 334-247 / TH83-22302	15063	233
Torque Rod Bushing Kit	REY TK19089 / 7014-TK19089 / TK18997 / TK19089 / REY TK19089 / R301983 / R001 / R003 / E-1312 / E-1983 / E-9545 / 334-252 / 334-252U / 334-253 / 09-2360 / TRK6008 / TRK6008UB / TH83-22089 / TH83-37997™	15064	233
Trunnion Bushing	44.2001 / UXA-000160SPX / R303579 / R308663 / E-3579 / E-8663 / D215 / D218 / 325-150 / 325-150AU / 325-150U / M9626 / M9626UB / PL1004	13009	229
Trunnion Bushing	43.2001 / 385216 / 25-828 / R305216 / R305217 / R307455 / H126 / H126UB / H127 / E-5216 / E-5217 / E-7455 / D97 / 325-107 / 325-107U / 325-122 / 09-3365 / 09-3366 / M12900 / M12900UB / HU10000 / HU10065	14027	231
Trunnion Bushing	42.2001 / 1083483 / 16215 / 60-1541 / R301332 / R307486 / N215 / N215UB / E-1332 / E-7486 / D232 / 325-137 / 325-137U / M1706 / 09-4422 / TRB5909 / NW30000	14521	2312

**STEMCO GAFF replacement parts compatible with:
TRAILMOBILE® PARALLELOGRAM®
SUSPENSION**

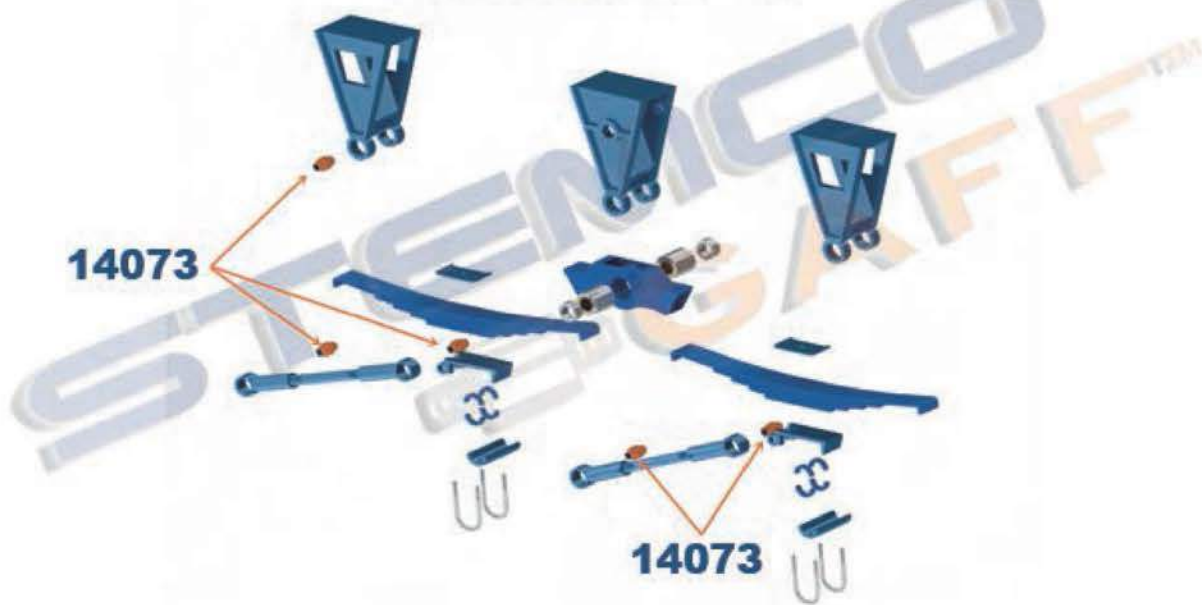

**STEMCO GAFF replacement parts compatible with:
TRAILMOBILE® STANDARD
FOUR SPRING SUSPENSION**

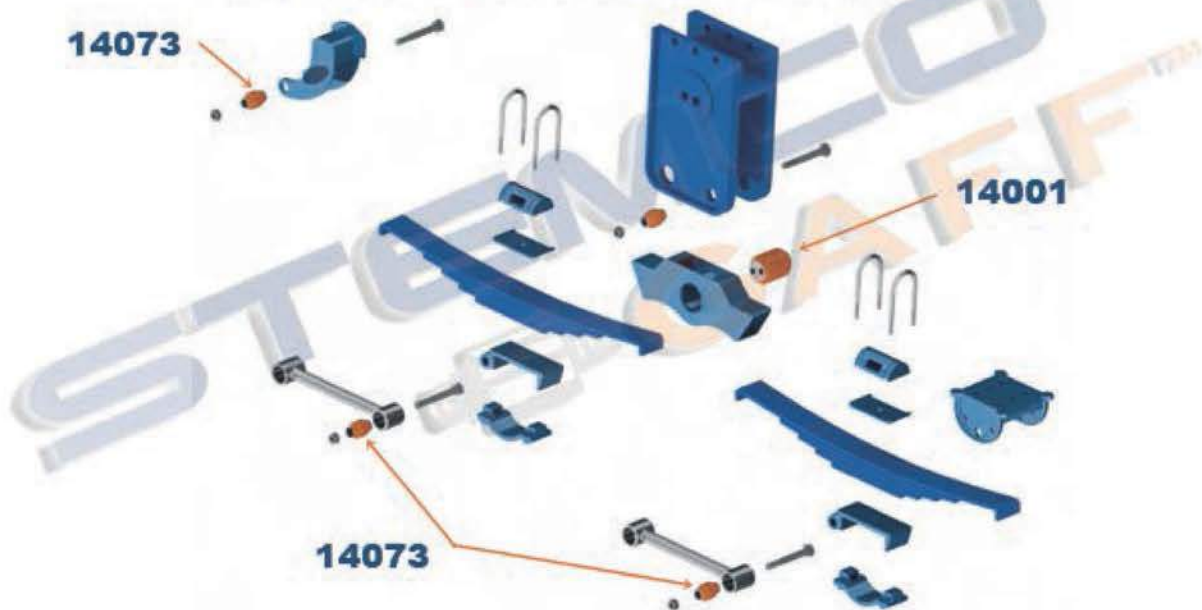

STEMCO GAFF replacement parts compatible with:
TRAILMOBILE® - INTERNATIONAL®
FOUR SPRING SUSPENSION



STEMCO GAFF replacement parts compatible with:
TRAILMOBILE® "SHORT ROCKER"
FOUR SPRING SUSPENSION



STEMCO GAFF replacement parts compatible with: HOLLAND® CBX23 / CBX25 SERIES

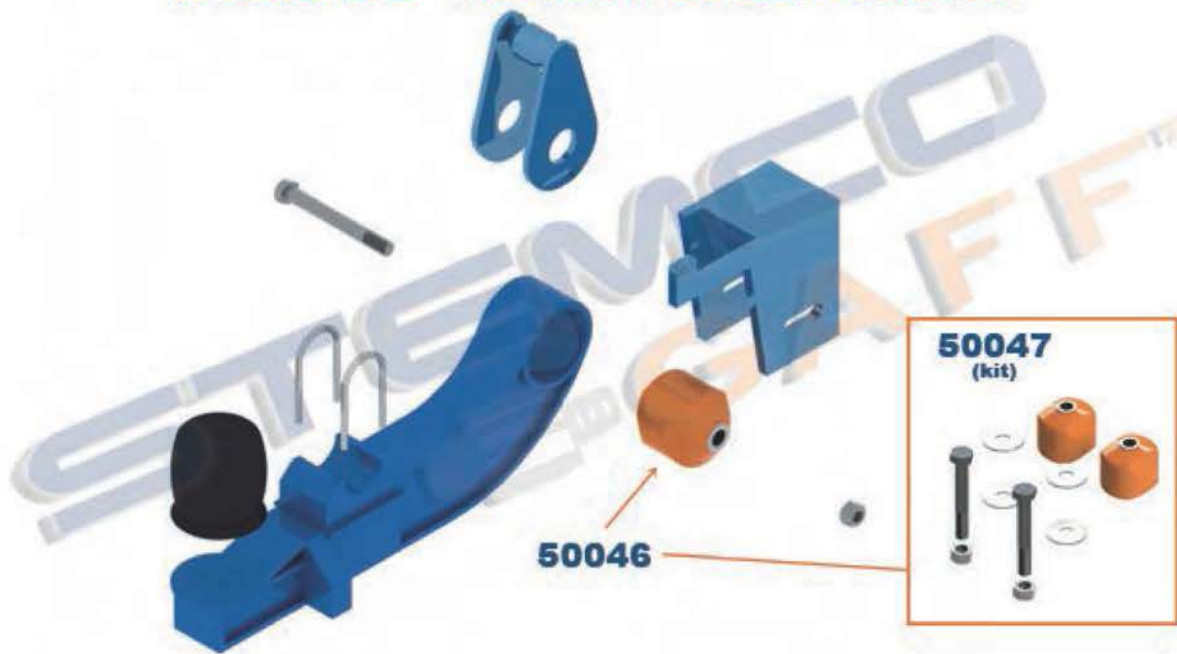

13001



Torque Rod Bushing

OD	2	3/16"
OD<	1	13/16"
ID	1	1/4"
LG	2	3/8"
HD		90A

INCLUDED IN:
13042

OEM
GDH7620-00
7620-00
25-750PU
R307433
R30927
RBT200
RBT200UB
E-7433
E-927
D100

Notes: hard poly inner sleeve

13009



Trunnion Bushing

OD	5	--
ID	4	--
LG	8	1/4"
HD		80A

OEM
44.2001
UXA-000160SPX
R303579
R308663
E-3579
E-8663
D215
D218
325-150
325-150AU

Notes:

13011



Equalizer Bolt

OD	2	--
LG	11	--
THR	1"	14 UNF

INCLUDED IN:
13041

OEM
UXA-0015001
15-1204
FR267
E-1019
334-453A
M1807
TRS4309

Notes: used with 13005 and 13007

13015



Torque Rod Bolt

OD	1	1/4"
LG	7	1/8"
THR	1"	14 UNF

INCLUDED IN:
13042

OEM
UXA-000016
E-1018
334-566
TRS3309

Notes: used with 13001

Trailers continued

13037

Spring Pad

THK	1	-
WD	4 3/4	-
LG	7 5/8	-
HD	80A	-

OEM

S7096
90.6013
R303582
R308664
FR220
E3582
E-3582
E-8664
D217
325-151

Notes:

13042

Torque Rod Bushing Kit

INCLUDES

QTY 2	13001
QTY 1	13015

OEM

GDH7620-00
3-69-2
7637-00
15-1217
FR266
H236
E-1023
E-9362
334-565
334-640

Notes: no tool needed bushing is pressed into the equalizer using the bolt

13501

Beam End Bushing

OD	4 3/8	-
ID	2 1/2	-
LG	5 1/4	-
HD	80A	-

INCLUDED IN:
13503, 13504

TOOLS 13564, 18541, 18542

OEM

1027037
20-809PU
R301340
R309511
C865
C865UB
E-1340
E-9511
D404
D404

Notes: for complete repair use adapter 13502 / additional tool suggestion 13588

13505

Center Bushing

OD	4 3/4	-
OD<	3 1/2	-
LG	12	-
HD	80A	-

INCLUDED IN:
13508, 13548, 13587

TOOLS 13570, 18539, 18540

OEM

Raydan
20-817
R301339
R306979
R309359
C863
C877
C887
E-1339
E-6979

Notes: standard-welded plug / double bonded-welded plug - 13636 / standard-loose plug - 13543

13539

Center Bushing

OD	3 5/8	-
ID	2	-
LG	10 1/16	-
HD	80A	-

OEM

20600071
321-377
PB99-26071

Notes:

13553

Beam End Bushing

OD	4 3/8	-
ID	2 1/2	-
LG	5 3/4	-
HD	80A	-

INCLUDED IN:
13587

TOOLS 13563, 13588

OEM

1027038
Severson
20-810PU
R301341A
R302771
C862
C862UB
C871
E-1341A
E-2771

Notes: uncrimped sleeve double bonded bushing / supersedes 13506 / use adapter 13507 for complete repair / additional tool suggestion 13595

14000

Equalizer Bushing

OD	3 5/16	-
LG	3 7/8	-
BH	3/4	-
HD	80A	-

OEM

32460848
25-705PU
R301999A
R307452
H102
E-1999A
E-7452
D95
321-176U
M1452

Notes:

14001

Equalizer Bushing

OD	3 5/16	-
LG	4 7/16	-
BH	3/4	-
HD	80A	-

OEM

3-12-32
65-1905
R303394A
TM109
E-3394A
321-220
09-1218
TRB5496

Notes:

Trailers continued

14003



Torque Rod Bushing

OD	2 3/16"
OD<	1 13/16"
ID	1 1/4"
LG	2 3/8"
HD	90A

OEM
31339
25-750PU
RB200
E-7433
E-927
321177U
D100
M1818
09-2247
TRB6300

Notes: no inner sleeve flat sides / uses bolt 13015 / 13001- hard poly inner sleeve

14004



Torque Rod Bushing

OD	2 5/16"
ID	1 5/16"
LG	2 3/16"
HD	80A

OEM
3-12-6
38788
3-12-16
65-1908
R30640
RB202
E-640
321-294
TRB6332

Notes:

14008



Torque Rod Bushing

TOOL 18836

OD	1 15/16"
ID	1"
LG	3"
HD	80A

OEM
12855
3-12-35
15209
31219
2530037
32460730
25-708PU
R307453
R30934
RB201

Notes: chamfered / stepped ends - 14073

14010



Torque Rod Bushing

TOOL 18836

OD	2"
ID	7/8"
LG	3"
HD	80A

INCLUDED IN:
11795, 12397

OEM
221394501
55-130
R303362
R305276
R208
E-3362
E-5276
321-162
09-2497
TRB6025

Notes: additional tool suggestion coming soon 40124

14011



Torque Rod Bushing

OD	2 3/16"
OD<	1 3/4"
ID	1"
LG	3 1/8"
HD	80A

OEM
16592
25-741PU
H151
E-7454
D99
321-173U
M1848
09-3341
TRB6330

Notes: additional tool suggestions 18836, coming soon 40124

14027



Trunnion Bushing

OD	5"
ID	4"
LG	9"
HD	90A

OEM
43.2001
385216
25-828
R305216
R305217
R307455
H126
H126UB
H127
E-5216

Notes: standard / chamfered - 14012

14073



Torque Rod Bushing

TOOL 18836

OD	1 15/16"
ID	1"
LG	3"
HD	80A

OEM
12855
3-12-35
15209
31219
2530037
32460730
25-708PU
R307453
R30934
RB201

Notes: stepped ends / new design / chamfered - 14008

14510



Beam End Bushing

OD	2 3/8"
ID	1 1/8"
LG	5"
HD	80A

OEM
1090237
60-1532
R304255
R307485
N119
N119UB
E-4255
E-7485
D235
321-227

Notes:

Trailers continued

14513



Beam End Bushing

OD	3 1/2"
ID	1 1/8"
LG	5 1/4"
HD	80A

OEM
NEW900-08-139
NW900-08-139
NEW900-08-139
60-1535
R304382A
N120
N120UB
E-4382A
E-8683
D441

Notes: additional tool suggestion 14531

14521



Trunnion Bushing

OD	5"
ID	4"
LG	8 3/4"
HD	80A

OEM
42.2001
1083483
16215
60-1541
R301332
R307486
N215
N215UB
E-1332
E-7486

Notes:

14522



Axle Pad

THK	3/4"
WD	4 1/2"
LG	5 1/8"
HD	80A

OEM
90.6011
15898
21092
60-1527
60-1546PU
R301330
R308669
R308670
N254

Notes:

14533



Beam End Bushing

OD	2 13/16"
ID	1 1/8"
LG	5"
HD	80A

OEM
NEW900-08-149
NW900-08-149
NEW900-08-149
60-1501
R304410A
N124
E-4410A
D448
321-231
321-231U

Notes: supersedes 14528 / additional tool suggestion 14531

15008



Torque Rod Bushing

OD	3 1/8"
OD<	1 13/16"
ID	1 1/16"
LG	2 13/16"
HD	80A

INCLUDED IN:
15061

OEM
16640
55-128PU
R150UB
E-7521
E-812
D72
321-158
321-158U
M1846
TRB6002

Notes: verify dimensions compare to 15020 - inner sleeve

15013



Torque Rod Bushing

OD	1 15/16"
ID	7/8"
LG	3"
HD	80A

INCLUDED IN:
15063

OEM
09729-01
L1032
90.7010
0022-00
A-1712
55-129
55-129PU
R301980
R307520
R129

Notes: additional tool suggestions 18836, coming soon 40124

15016



Equalizer Bushing

OD	3 3/8"
ID	1 5/8"
LG	4 1/2"
HD	80A

OEM
16571
55-103PU
R301159
R308653
R110UB
E-1159
E-8653
D59
321-146U
M1719

Notes:

15017



Equalizer Bushing

OD	3 3/16"
ID	2"
LG	3 7/8"
HD	80A

OEM
L1025
21303
3-12-20
55-191PU
R301072
R308688
R132
VV2
E-8688
D76

Notes: chamfered inner metal bushing / verify dimensions compare to 15004 - chamfered with center groove

Trailers continued

15051



Torque Rod Bushing

OD	2 3/8"	OEM
OD<	1 13/16"	L1132
ID	1"	55-131PU
LG	2 13/16"	R301982
HD	80A	R307522
		R131
		R131UB
		E-1982
		E-7522
		D70
		321-147

Notes: supersedes 15010

15054



Equalizer Bushing

OD	3 7/16"	OEM
ID	1"	0649-02
LG	4"	55-144
HD	80A	R304827
		TP110
		E-4827
		321-194
		321-194U
		M1694
		TRB5544
		EQ83-35902

Notes:

15061



Torque Rod Bushing Kit

INCLUDES	OEM
QTY 2 15008	SB1745
QTY 1 Bolt 1"-14 x 7 1/2" G8	55-146
QTY 1 Lock Nut 1"-14UNF	R309350
QTY 2 Flat Washer 3/4"	R234
	E9350
	334-896
	09-228202
	TRK6002
	TH83-37640

Notes:

15062



Torque Rod Bushing Kit

INCLUDES	OEM
QTY 2 15009	
QTY 1 Bolt 1"-14 x 7 1/2" G8	
QTY 1 Lock Nut 1"-14UNF	
QTY 2 Flat Washers 1 x 1/4" THK	

Notes: offset / compatible with Reyco

15063



Torque Rod Bushing Kit

INCLUDES	OEM
QTY 1 15013	L1032
QTY 1 Hex Bolt 7/8"-12 x 5 1/2"	55-11001
QTY 1 Lock Nut 7/8"-12 UNF	R002
	E-1981
	E-9552
	334-247
	TH83-22302

Notes:

15064



Torque Rod Bushing Kit

INCLUDES	OEM
QTY 2 15073	REY TK19089
QTY 1 Bolt 1"-14 UNF x 7"	7014-TK19089
QTY 1 Nut 1" - 14 UNF	TK18997
QTY 2 Flat Washers 1" x 1/4" THK	TK19089
	REY TK19089
	R301983
	R001
	R003
	E-1312
	E-1983

Notes: compatible with Reyco 21B

17500



Camshaft Bushing

OD	2 7/16"	OEM
ID	1 1/2"	382517
LG	1 1/2"	
HD	71D	

Notes:

17502



Camshaft Bushing

OD	2 7/8"	OEM
OD<	2 1/16"	381571
ID	1 5/8"	E-1571
LG	2 7/16"	
HD	71D	

Notes:

Trailers continued

17505

OD	2 3/16"	OEM 700734 700762 E-1567
ID	1 5/8"	
LG	7/8"	
HD	71D	



Camshaft Bushing

Notes:

17538

OD	1 7/8"	OEM 7-6-17 E-536
ID	1 1/2"	
LG	1 1/2"	
HD	71D	



Camshaft Bushing

Notes:

17574

OD	2 3/16"	OEM 15109
ID	1 1/2"	
LG	7/8"	
HD	71D	



Camshaft Bushing

Notes:

17668

OD	2 7/16"	OEM 700768 E-1577A
ID	1 5/8"	
LG	1 1/2"	
HD	71D	



Camshaft Bushing

Notes:

18215

OD	2"	OEM HHXB-0011 FW51-32011
ID	1 1/8"	
LG	4 1/4"	
HD	80A	



Fifth Wheel Bushing

Notes: no groove / verify dimensions compare to 18094

18244

OD	1 13/16"	OEM 90.8005 R307474 E-7474 320-178 320-178UB MH1433 MH1433UB PL1028
ID	1 1/16"	
LG	13/16"	
HD	80A	



Shock Absorber Bushing

Notes:

18256

OD	5 5/8"	OEM 400329 R307457 E-7457 320-182 320-182U PL1061
OD<	4 1/4"	
ID	3 1/4"	
LG	2 7/8"	
HD	80A	



Suspension Bushing

Notes:

18558

OD	4 1/4"	OEM 37.3005R R307518 E-7518 D250 320-165U PL1079
ID	2"	
LG	4 1/2"	
HD	80A	
INCLUDES		
QTY 1	Flat Washer 1/2" x 4 7/16" - 2"	



Hinge Bushing Kit

Notes: components not sold separately

Trailers continued

18689



Torque Rod Bushing

OD	1 11/16"	OEM SP7111
ID	13/16"	
LG	2 1/4"	
HD	80A	

Notes:

18690



Torque Rod Bushing

OD	2 3/8"	OEM SP1324
ID	1 3/16"	
LG	4"	
HD	80A	

Notes:

18691



Torque Rod Bushing

OD	1 11/16"	OEM SP7109
ID	15/16"	
LG	2 1/4"	
HD	80A	

Notes:

18692



Torque Rod Bushing

OD	1 15/16"	OEM SP7110
ID	15/16"	
LG	2 1/4"	
HD	80A	

Notes:

18696



Shock Absorber Bushing

OD	1 13/16"	OEM SP7128
ID	15/16"	
LG	2 5/16"	
HD	80A	

Notes: components not sold separately

18697



Shock Absorber Bushing

OD	1 9/16"	OEM SP7119
ID	15/16"	
LG	2 1/4"	
HD	80A	

Notes: components not sold separately

18700



Equalizer Bushing

OD	2 11/16"	OEM SP7165
ID	1 3/16"	
LG	4 1/8"	
HD	80A	

Notes:

18701



Equalizer Bushing

OD	2 1/4"	OEM SP7155
ID	1 3/16"	
LG	4"	
HD	80A	

Notes:

Trailers continued

18710



Pivot Bushing Inner

OD	5 13/16"
ID	2 1/4"
LG	2"
HD	80A

OEM
61610013
SP1431

Notes:

18711



Pivot Bushing Outer

OD	5 13/16"
ID	2 1/8"
LG	2"
HD	80A

OEM
61610012
SP1432

Notes:

40089



Torque Rod Bushing

OD	2 11/16"
ID	1 1/8"
LG	2 1/4"
HD	80A

OEM
KF88-051400

Notes: ID is tight tolerance of 1.110

50033



Torque Rod Bushing

INCLUDES

QTY 2	34514
QTY 1	Pivot Bolt 7/8" - 16 UNF x 6 G8
QTY 1	Lock Nut 7/8"
QTY 1	Flat Washer 7/8"
QTY 1	Sleeve 1 1/2" x 7/8" x 3"

OEM
MTRKIT11126
RWKIT1126
E-11763
334-1672
TRK4931
PB00-26422
SU99-39115

Notes: coming soon call tech department

50046



Suspension Bushing

OD	5"
ID	1 1/8"
LG	5"
HD	80A

INCLUDED IN:
50047

OEM
90008247

Notes: 2 per axle

50047



Suspension Bushing Kit

INCLUDES

QTY 2	50046
QTY 2	Bolt 1 1/2" - 7UNC x 9 1/2"
QTY 4	Flat Washer 1 1/2"
QTY 2	Lock Nut 1 1/2" - 7UNC

OEM
SRK-530

Notes:

Transit / Coach

DESCRIPTION	OEM	PART ID	PAGE
Beam End Bushing	24SU24 / 60-1540PU / N109 / E-2940 / E-8677 / D240 / 325-235U / M2118 / 09-4410 / TRB5721	14504	240
Bushing Shaft	compatible with SCANIA / compatible with VW	32041	248
Cab Mount	compatible with MERCEDES	31562	244
Carrier Bearing Bushing	compatible with compatible with SCANIA	32040	248
Compressor Mount	compatible with MERCEDES	31595	245
Easy-Mount Torque Rod Bushing	N8800599 / N8884777 / N8888164 / 20-833PU / R302226 / R307639 / C879 / C879UB / E-2226 / E-4664 / E-7639 / D423 / 321-132 / 321-132U / M2070 / 09-5723 / TRB6820 / TRB6820UB / TS38000	83520	251

Transit / Coach continued

DESCRIPTION	OEM	PART ID	PAGE
Equalizer Bushing	020117461 / 020117461U / 30-1302 / 40-348 / RB187 / RB-187 / M3478 / MR620 / MR620UB / AT80000	13513	239
Exhaust Mount	compatible with SCANIA	32013	247
Load Cushion	12G-1-5	18437	240
Load Cushion	compatible with NEOPLAN	18484	241
Load Pad	compatible with MAN	35005	251
Motor Mount	compatible with VW	17285	240
Motor Mount	8G-186-146	18943	242
Motor Mount	8G-18-123	18944	242
Motor Mount	08-18-1008	30516	242
Motor Mount	compatible with MERCEDES	31521	243
Motor Mount	compatible with MERCEDES	31529	243
Motor Mount	compatible with MERCEDES	31545	244
Motor Mount	compatible with MERCEDES	31600	245
Motor Mount	compatible with SCANIA	32010	246
Motor Mount	compatible with SCANIA	32038	248
Motor Mount	compatible with SCANIA	32039	248
Motor Mount	compatible with SCANIA	32042	249
Motor Mount	compatible with MAN	35003	251
Motor Mount	compatible with MAN	35004	251
Overload Pad	compatible with SCANIA	32003	246
Radiator Mount	00-48444	11144	239
Radiator Mount	compatible with VW	31005	242
Radiator Mount	compatible with MERCEDES	31550	244
Radiator Mount	compatible with SCANIA	34545	250
Shifter Linkage Bushing	compatible with MERCEDES	31571	244
Shifter Linkage Bushing	compatible with SCANIA	32025	247
Shifter Linkage Bushing	compatible with SCANIA	32027	247
Shock Absorber Bushing	12L-52 / 50134002 / 401754 / PL1026	18010	240
Shock Absorber Bushing	compatible with NEOPLAN	18483	241
Shock Absorber Bushing	compatible with NEOPLAN	18533	241
Shock Absorber Bushing	compatible with NEOPLAN	18572	241
Shock Absorber Bushing	2350908 / 2350908U / 12-5-123 / 12-5-123A / SB03-83008	30507	242
Shock Absorber Bushing	compatible with MERCEDES	31502	243
Shock Absorber Bushing	compatible with MERCEDES	31578	244
Shock Absorber Bushing	12001005 / 01-153-287 / 12G-1-5	32014	247
Shock Absorber Bushing	compatible with SCANIA	32016	247
Spring Bushing	compatible with MERCEDES	31509	243
Spring Bushing	compatible with MERCEDES	31582	245
Spring Bushing	compatible with MERCEDES	31596	245
Spring Bushing	compatible with SCANIA	32001	246
Spring Bushing	compatible with SCANIA	32002	246
Spring Bushing	compatible with SCANIA	32502	249
Spring Bushing Kit	1353440 / 3765438 / 3769289 / B1163-22 / B1205-43 / B1314-55 / B1435-55 / B1442-55 / E694-55 / IS620 / RNG-OGB / 327-179 / 327-212 / 327-256 / 327-479 / 327-485 / 330-149 / 330-190 / 334-964 / RNG-BM / M1634 / M4794 / M4878 / M5096 / M5352 / MIH14UB / MIS1486 / OGB-RNG / SK00-10500 / SK55-10600 / SK55-10700 / SP55-113C1	19001	242
Stabilizer Bar Bushing	12-J-5-84	18814	241

Transit / Coach continued

DESCRIPTION	OEM	PART ID	PAGE
Stabilizer Bar Bushing	12-J-1-35	18820	241
Stabilizer Bar Bushing	compatible with MERCEDES	31507	243
Stabilizer Bar Bushing	compatible with MERCEDES	31512	243
Stabilizer Bar Bushing	compatible with MERCEDES	31537	244
Stabilizer Bar Bushing	compatible with MERCEDES	31566	244
Stabilizer Bar Bushing	compatible with MERCEDES	31580	245
Stabilizer Bar Bushing	compatible with SCANIA	32000	246
Stabilizer Bar Bushing	compatible with SCANIA	32005	246
Stabilizer Bar Bushing	compatible with SCANIA	32006	246
Stabilizer Bar Bushing	compatible with SCANIA	32028	247
Stabilizer Bar Bushing	compatible with SCANIA	32033	248
Stabilizer Bar Bushing	compatible with SCANIA	32037	248
Stabilizer Bar Bushing	compatible with SCANIA	32046	249
Stabilizer Bar Bushing	compatible with SCANIA	32047	249
Stabilizer Bar Bushing	compatible with SCANIA	32050	249
Stabilizer Bar Bushing	compatible with SCANIA	32053	249
Stabilizer Bar Bushing	compatible with SCANIA	33501	250
Stabilizer Bar Bushing	compatible with MAN	35001	250
Stabilizer Bar Bushing	compatible with MAN	35006	251
Stabilizer Bar Bushing	compatible with MAN	35009	251
Torque Rod	compatible with SCANIA	13629	239
Torque Rod Bushing	N8800599 / N8884777 / N8888164 / 20-833PU / R302226 / R307639 / C879 / C879UB / E-2226 / E-4664 / E-7639 / D423 / 321-132 / 321-132U / M2070 / 09-5723 / TRB6820 / TRB6820UB / TS38000	13520	239
Torque Rod Bushing	12L-5-94 / 20-851PU / R303868 / C889 / E-3868 / D424 / 321-265 / 321-265U / TRB6822 / TRB6822UB / TS38750	13528	239
Torque Rod Bushing	N8800599 / N8884777 / N8888164 / 20-833PU / R302226 / R307639 / C879UB / E-2226 / E-4664 / E-7639 / D423 / 321-132U / M2070 / 09-5723 / TRB6820UB	13536	239
Torque Rod Bushing	020117451 / 020117451U / E-9519 / D410 / 321-320 / 09-5494 / TH85000	13659	240
Torque Rod Bushing	compatible with MAN	18080	240
Torque Rod Bushing	compatible with NEOPLAN	18084	240
Torque Rod Bushing	compatible with NEOPLAN	18435	240
Torque Rod Bushing	B7120411	18865	241
Torque Rod Bushing	6313765 / 6313765 / TS03-85765	18866	241
Torque Rod Bushing	5922276 / 6322757	18930	242
Torque Rod Bushing	compatible with SCANIA	31087	242
Torque Rod Bushing	compatible with MERCEDES	31508	243
Torque Rod Bushing	compatible with MERCEDES	31528	243
Torque Rod Bushing	compatible with MERCEDES	31579	244
Torque Rod Bushing	12-05-1013 / TS03-85013	31601	245
Torque Rod Bushing	12-05-1019 / TS03-85019	31602	245
Torque Rod Bushing	compatible with MAN / compatible with SCANIA / VW	32007	246
Torque Rod Bushing	compatible with SCANIA	32020	247
Torque Rod Bushing	12-05-1002 / TS03-85002	32031	247
Torque Rod Bushing	1958009 / 0550-800	32032	248
Torque Rod Bushing	compatible with SCANIA	32035	248
Torque Rod Bushing	compatible with SCANIA	32048	249
Torque Rod Bushing	compatible with SCANIA	32049	249

Transit / Coach continued

DESCRIPTION	OEM	PART ID	PAGE
Torque Rod Bushing	700701 / 2314759 / 700701U / TH03-85000	33500	250
Torque Rod Bushing	12J-1-133 / 82024 / 5922276 / 5957548 / 6322561 / 6322757 / TH03-82750 / TH03-85001 / TH03-85033	33502	250
Torque Rod Bushing	6-441-1 / 97-9999-2033 / 723330 / 2383283 / 2426422 / 2449224 / 723330A / N22174 / 5922276 / 6322757 / 12J-1-26 / 12J-1-35 / 5922276 / 5957548 / 6322561 / 6322591 / 6322757 / TH03-82725	33503	250
Torque Rod Bushing	2044403 / 2044403A / G1094264 / TH03-83000	33506	250
Torque Rod Bushing	compatible with MAN	35002	250
Torque Rod Bushing	compatible with MAN	35007	251
Torque Rod Bushing	compatible with MAN	35008	251
Wear Shim	compatible with MERCEDES	31588	245

11144



Radiator Mount

WD	1 13/16"
LG	3 15/16"
C-C	1 3/4"
BC-C	2 3/8"
THR	3/8" x 1" -UNC
HGT	2 1/8"
HD	80A

OEM
00-48444

Notes: verify dimensions compare to 11117

13513



Equalizer Bushing

OD	2 1/2"
ID	1"
LG	4 1/2"
HD	80A

OEM
020117461
020117461U
30-1302
40-348
RB187
RB-187
M3478
MR620
MR620UB
AT80000

Notes: metal sleeve / verify dimensions compare to 13577 - metal sleeve or 10028 - no sleeve / additional tool suggestion 18833, coming soon 40131

13520



Torque Rod Bushing

OD	2 3/4"
C-C	4 3/8"
BH	5/8"
HD	80A

INCLUDED IN:
Several Kits

OEM
N8800599
N8884777
N8888164
20-833PU
R302226
R307639
C879
C879UB
E-2226
E-4664

TOOLS 18551, 18833

Notes: easy mount - 83520 / no sleeve - 13536

13528



Torque Rod Bushing

OD	2 3/4"
C-C	4 3/8"
BH	3/4"
HD	80A

INCLUDED IN:
12395, 13701, 13702, 13703

OEM
12L-5-94
20-851PU
R303868
C889
E-3868
D424
321-265
321-265U
TRB6822
TRB6822UB

TOOLS 18833, 18551

Notes: additional tool suggestion coming soon 40131

13536



Torque Rod Bushing

OD	2 15/16"
C-C	4 3/8"
BH	5/8"
HD	80A

OEM
N8800599
N8884777
N8888164
20-833PU
R302226
R307639
C879UB
E-2226
E-4664
E-7639

TOOL 18831

Notes: 83520 - easy mount / 13520 - metal sleeve

13629



Torque Rod

ID	2 3/4"
C-C	22"

INCLUDED IN:
13634, 13657

OEM

Notes: compatible with SCANIA

Transit / Coach continued

13659



Torque Rod Bushing

OD	4 3/8"	
ID	2 1/2"	
LG	4 7/16"	
HD	80A	

OEM
020117451
020117451U
E-9519
D410
321-320
09-5494
TH85000

Notes:

14504



Beam End Bushing

OD	2 3/8"	
ID	1 1/4"	
LG	5"	
HD	80A	

OEM
24SU24
60-1540PU
N109
E-2940
E-8677
D240
325-235U
M2118
09-4410
TRB5721

Notes:

17285



Motor Mount

OD	4"	
OD<	3 1/2"	
ID	1 1/2"	
LG	3"	
HD	70A	

OEM

Notes: compatible with VW

18010



Shock Absorber Bushing

OD	1 1/2"	
ID	3/4"	
LG	15/16"	
HD	80A	

OEM
12L-52
50134002
401754
PL1026

Notes:

18080



Torque Rod Bushing

OD	1 13/16"	
ID	5/8"	
LG	1 7/8"	
HD	80A	

OEM

Notes: compatible with MAN

18084



Torque Rod Bushing

OD	2 1/2"	
ID	1 7/16"	
LG	3"	
HD	80A	

OEM

Notes: compatible with Neoplan

18435



Torque Rod Bushing

OD	2 9/16"	
LG	6 5/16"	
C-C	4 7/8"	
BH	3/4"	
HD	80A	

OEM

Notes: compatible with NeoPlan

18437



Load Cushion

OD	3 11/16"	
THR	1/2" - 13 UNC x 1 1/2"	
HGT	2 13/32"	
HD	80A	

OEM
12G-15

Notes:

Transit / Coach continued

18483



Shock Absorber Bushing

OD	1 1/2"	OEM
ID	3/4"	
LG	1 3/4"	
HD	80A	

Notes: compatible with Neoplan

18484



Load Cushion

OD	4 3/4"	OEM
ID	1 1/2"	
LG	4"	
HD	70A	

Notes: compatible with Neoplan

18533



Shock Absorber Bushing

OD	1 9/16"	OEM
OD<	1 3/8"	
ID	13/16"	
LG	1 3/4"	
HD	80A	

Notes: compatible with Neoplan

18572



Shock Absorber Bushing

OD	7 13/16"	OEM
ID	3 15/16"	
LG	4 3/8"	
HD	80A	

Notes: components not sold separately/ compatible with Neoplan

18814



Stabilizer Bar Bushing

ID	2 3/8"	OEM 12-J-5-84
THK	3 1/6"	
WD	3 5/16"	
LG	1 5/8"	
HD	80A	

Notes:

18820



Stabilizer Bar Bushing

ID	1 7/16"	OEM 12-J-1-35
THK	3 1/8"	
WD	3 3/4"	
LG	5 3/4"	
HD	80A	

Notes:

18865



Torque Rod Bushing

OD	4 5/16"	OEM B7120411
OD<	3 3/16"	
ID	2 1/4"	
LG	2 11/16"	
HD	80A	

Notes:

18866



Torque Rod Bushing

OD	3 11/16"	OEM 6313765 6313765 TS03-85765
C-C	6"	
BH	13/16"	
HD	80A	

Notes:

Transit / Coach continued

18930



Torque Rod Bushing

OD	3 5/8"
ID	2 1/2"
LG	2 1/2"
HD	80A

OEM
5922276
6322757

Notes:

18943



Motor Mount Front

OD	3 9/16"
LG	3 9/16"
HD	80A

OEM
8G-186-146

Notes:

18944



Motor Mount Rear

OD	2 5/8"
ID	4 3/4"
WD	7 1/4"
LG	1 1/8"
HD	80A

OEM
8G-18-123

Notes:

19001



Spring Bushing Kit

OD	1 1/2"
ID	1"
LG	3"
HD	90A

OEM
1353440
3765438
3769289
B1163-22
B1205-43
B1314-55
B1435-55
B1442-55
E694-55
IS620

Notes: components not sold separately

30507



Shock Absorber Bushing

OD	1 15/16"
ID	1"
LG	15/16"
HD	80A

OEM
2350908
2350908U
12-5-123
12-5-123A
SB03-83008

Notes:

30516



Motor Mount Rear

ID	1"
WD	5 15/16"
LG	6 3/4"
HGT	4 1/16"
HD	70A

OEM
08-18-1008

Notes:

31005



Radiator Mount

OD	2 13/16"
LG	3"
THR	10 mm - P1.5
HD	70A

OEM

Notes: compatible with VW

31087



Torque Rod Bushing

OD	2 15/16"
LG	6 3/8"
C-C	5 1/8"
BH	3/4"
HD	80A

OEM

Notes: not offered by OE / additional tool suggestion 18831 / compatible with SCANIA

Transit / Coach continued

31502

OD	1 13/16"	OEM
ID	7/8"	
LG	13/16"	
HD	80A	



Shock Absorber Bushing

Notes: compatible with Mercedes

31507

OD	3 3/8"	OEM
ID	1 3/4"	
LG	5 1/16"	
HD	80A	



Stabilizer Bar Bushing

Notes: compatible with Mercedes

31508

OD	3 5/8"	OEM
ID	2 1/8"	
LG	3 3/8"	
HD	80A	



Torque Rod Bushing

TOOL 18835

Notes: compatible with Mercedes

31509

OD	2 3/8"	OEM
ID	1"	
LG	4 3/8"	
HD	80A	



Spring Bushing

Notes: compatible with Mercedes

31512

OD	3"	OEM
ID	1"	
LG	1 1/16"	
HD	80A	



Stabilizer Bar Bushing

Notes: compatible with Mercedes

31521

WD	4"	OEM
LG	5 3/16"	
HGT	4 13/16"	
HD	80A	



Motor Mount Front

Notes: compatible with Mercedes

31528

OD	3 13/16"	OEM
ID	2 1/8"	
LG	1 5/8"	
HD	80A	



Torque Rod Bushing

Notes: compatible with Mercedes

31529

WD	4 3/16"	OEM
LG	8 5/8"	
HGT	5 1/8"	
HD	80A	



Motor Mount Rear

Notes: compatible with Mercedes

Transit / Coach continued

31537

OD	3 5/8"	-	OEM
ID	2 1/8"		
LG	3 3/8"		
HD	80A		



Stabilizer Bar Bushing

Notes: compatible with Mercedes

31545

WD	4 3/16"	-	OEM
LG	6 15/16"		
HGT	4 3/8"		
HD	80A		



Motor Mount Rear

Notes: compatible with Mercedes

31550

OD	1 3/16"	-	OEM
LG	2 1/4"		
THR	8 mm - P1.25		
HD	80A		



Radiator Mount

Notes: compatible with Mercedes

31562

OD	3 3/8"	-	OEM
ID	13/16"		
HGT	2 5/8"		
HD	70A-71D		



Cab Mount

Notes: components not sold separately / compatible with Mercedes

31566

OD	2 3/4"	-	OEM
ID	1 11/16"		
WD	2 1/4"		
HD	80A		



Stabilizer Bar Bushing

Notes: compatible with Mercedes

31571

OD	2 7/16"	-	OEM
ID	2"		
LG	1 3/8"		
HD	71D		



Shifter Linkage Bushing

Notes: compatible with Mercedes

31578

OD	1 13/16"	-	OEM
OD<	1 1/4"		
ID	3/4"		
LG	7/8"		
HD	71D-80A		



Shock Absorber Bushing

Notes: compatible with Mercedes

31579

OD	3 3/8"	-	OEM
C-C	6"		
BH	13/16"		
HD	80A		



Torque Rod Bushing

TOOL 18835

Notes: compatible with Mercedes

Transit / Coach continued

31580



Stabilizer Bar Bushing

OD	2 1/4"	OEM
ID	7/8"	
LG	2 1/2"	
HD	80A	

Notes: compatible with Mercedes

31582



Spring Bushing

OD	2 5/16"	OEM
ID	7/8"	
LG	3"	
HD	80A	

Notes: compatible with Mercedes

31588



Wear Shim

OD	5 1/4"	OEM
ID	1 11/16"	
LG	3/16"	
HD	71D	

Notes: compatible with Mercedes

31595



Compressor Mount

ID	1 15/16"	OEM
WD	2 7/16"	
LG	2 7/16"	
HGT	2 7/16"	
HD	80A	

Notes: compatible with Mercedes

31596



Spring Bushing

OD	2 7/16"	OEM
ID	1"	
LG	3 1/2"	
HD	80A	

Notes: compatible with Mercedes

31600



Motor Mount

OD	4 1/2"	OEM
ID	5/8"	
LG	3 1/16"	
HD	80A	

Notes: components not sold separately / compatible with Mercedes

31601



Torque Rod Bushing

OD	2 15/16"	OEM
C-C	5 1/8"	12-05-1013
BH	1"	TS03-85013
HD	80A	

TOOL 18831

Notes:

31602



Torque Rod Bushing

OD	3 15/16"	OEM
C-C	6"	12-05-1019
BH	1"	TS03-85019
HD	80A	

Notes:

Transit / Coach continued

32000



Stabilizer Bar Bushing

OD	2 1/4"	OEM
OD<	1 1/2"	
ID	13/16"	
LG	1 9/16"	
HD	80A	

Notes: compatible with SCANIA

32001



Spring Bushing

OD	2 5/8"	OEM
ID	1 1/2"	
LG	4 1/8"	
HD	70A	

Notes: additional tool suggestion 18833 / compatible with SCANIA

32002



Spring Bushing

OD	2 5/8"	OEM
ID	1 3/16"	
LG	4 13/16"	
HD	80A	

Notes: compatible with SCANIA

32003



Overload Pad

WD	2"	OEM
LG	6 1/2"	
HGT	2 7/16"	
HD	80A	

Notes: compatible with SCANIA

32005



Stabilizer Bar Bushing

WD	4 1/4"	OEM
LG	3 15/16"	
HGT	3 3/4"	
HD	80A	

Notes: compatible with SCANIA

32006



Stabilizer Bar Bushing

WD	2 3/4"	OEM
LG	4 3/4"	
HGT	2 9/16"	
HD	80A	

Notes: compatible with SCANIA

32007



Torque Rod Bushing

OD	3 5/16"	OEM
C-C	5 1/8"	
BH	3/4"	
HD	80A	

TOOL 18835

Notes: compatible with MAN SCANIA and VW

32010



Motor Mount Front

OD	4 1/8"	OEM
THR	12 mm - P1.75	
HGT	2 3/8"	
HD	80A	

Notes: compatible with SCANIA

Transit / Coach continued

32013



Exhaust Mount

OD	2 11/16"	OEM
LG	1 3/8"	
THR	1/2" - 13 UNC	
HD	70A	

Notes: compatible with SCANIA

32014



Shock Absorber Bushing

OD	2 3/16"	OEM
ID	13/16"	
HD	80A	

Notes: compatible with

32016



Shock Absorber Bushing

OD	1 3/4"	OEM
ID	7/8"	
LG	15/16"	
HD	80A	

Notes: compatible with SCANIA

32020



Torque Rod Bushing

OD	3 11/16"	OEM
LG	5 13/16"	
THR	22 mm - P1.5	
HD	80A	

TOOL 18834

Notes: compatible with SCANIA

32025



Shifter Linkage Bushing

OD	2 3/8"	OEM
ID	1 5/8"	
LG	2"	
HD	72D	

Notes: compatible with SCANIA

32027



Shifter Linkage Bushing

OD	1 3/8"	OEM
ID	1"	
LG	13/16"	
HD	72D	

Notes: compatible with SCANIA

32028



Stabilizer Bar Bushing

ID	1 7/8"	OEM
LG	4"	
HGT	3 1/8"	
HD	80A	

Notes: compatible with SCANIA

32031



Torque Rod Bushing

OD	2 15/16"	OEM
C-C	4 1/2"	
BH	5/8"	
HD	80A	

TOOL 18831

Notes:

Transit / Coach continued

32032



Torque Rod Bushing

TOOL 18833

Notes: compatible with SCANIA

OD	2 5/8"	OEM
C-C	3 15/16"	
BH	5/8"	
HD	80A	

32033



Stabilizer Bar Bushing

Notes: compatible with SCANIA

OD	2 1/4"	OEM
OD<	1 1/2"	
ID	1 13/16"	
LG	1 3/16"	
HD	80A-71D	

32035



Torque Rod Bushing

TOOL 18834

Notes: compatible with SCANIA

OD	3 3/4"	OEM
ID	1 5/8"	
LG	2 7/8"	
HD	80A	

32037



Stabilizer Bar Bushing

Notes: compatible with SCANIA

ID	1 3/4"	OEM
HGT	3 1/8"	
HD	80A	

32038



Motor Mount Transmission

Notes: compatible with SCANIA

WD	2 7/16"	OEM
LG	12	
THR	12 mm - P1.75	
HD	80A	

32039



Motor Mount Front

Notes: compatible with SCANIA

OD	4"	OEM
THR	12 mm - P1.75	
HGT	2 5/8"	
HD	80A	

32040



Carrier Bearing Bushing

Notes: compatible with SCANIA

OD	6 3/4"	OEM
ID	2 13/16"	
LG	2 3/8"	
HD	80A	

32041



Bushing Shaft

Notes: compatible with SCANIA and VW

OD	1 13/16"	OEM
LG	4 3/8"	
THR	14 mm, 18 mm - P1.5	
HD	Steel	

Transit / Coach continued

32042

WD	2 5/8"	OEM
LG	6 1/2"	
HGT	4 13/16"	
HD	80A	



**Motor Mount
Rear**

Notes: compatible with SCANIA

32046

OD	2 1/2"	OEM
OD<	1 7/16"	
ID	13/16"	
LG	13/16"	
HD	70A	



Stabilizer Bar Bushing

Notes: compatible with SCANIA

32047

ID	2 1/2"	OEM
LG	4 1/8"	
HGT	3 13/16"	
HD	80A	



Stabilizer Bar Bushing

Notes: compatible with SCANIA

32048

OD	3 3/8"	OEM
LG	5 11/16"	
THR	22 mm - P1.5	
HD	80A	



Torque Rod Bushing

TOOL 18835

Notes: compatible with SCANIA

32049

OD	3 3/8"	OEM
LG	6 3/4"	
THR	38.8 mm - P1.5	
HD	80A	



Torque Rod Bushing

TOOL 18835

Notes: compatible with SCANIA

32050

OD	2 3/16"	OEM
OD<	1 1/12"	
ID	7/8"	
LG	1 13/16"	
HD	80A	



Stabilizer Bar Bushing

Notes: compatible with SCANIA

32053

ID	2"	OEM
LG	4"	
HGT	3"	
HD	80A	



Stabilizer Bar Bushing

Notes: compatible with SCANIA

32502

OD	2 9/16"	OEM
ID	1 3/16"	
LG	4"	
HD	70A	
HD	70A	



Spring Bushing

Notes: compatible with SCANIA

Transit / Coach continued

33500



Torque Rod Bushing

OD	3 5/8"
ID	2 7/16"
LG	3 3/16"
HD	80A

OEM
700701
2314759
700701U
TH03-85000

Notes:

33501



Stabilizer Bar Bushing

ID	1 3/4"
THK	2 5/8"
WD	2 3/4"
LG	5"
HD	80A

OEM

Notes: compatible with SCANIA

33502



Torque Rod Bushing

OD	3 5/8"
ID	2 1/2"
LG	2 1/2"
HD	80A

OEM
12J-1-133
82024
5922276
5957548
6322561
6322757
TH03-82750
TH03-85001
TH03-85033

Notes: solid design / 33503 - open design

33503



Torque Rod Bushing

OD	3 3/4"
ID	2 1/2"
LG	2 1/2"
HD	80A

OEM
6-441-1
97-9999-2033
723330
2383283
2426422
2449224
723330A
N22174
5922276
6322757
12J-1-26
12J-1-35
5922276
5957548
6322561

Notes: open design / 33502 - solid design

33506



Torque Rod Bushing

OD	3 1/2"
ID	2 1/2"
LG	3 1/4"
HD	80A

OEM
2044403
2044403A
G1094264
TH03-83000

Notes:

34545



Radiator Mount

OD	2 1/16"
ID	1/2"
LG	1 1/8"
HD	70A

OEM

Notes: compatible with SCANIA

35001



Stabilizer Bar Bushing

OD	2 1/2"
ID	1 3/4"
LG	2"
HD	80A

OEM

Notes: compatible with SCANIA

35002



Torque Rod Bushing

OD	1 29/32"
ID	5/8"
LG	1 27/32"
HD	80A

OEM

Notes: compatible with MAN

Transit / Coach continued

35003



Motor Mount Rear

OD	4 3/16"	OEM
OD<	2 3/4"	
ID	7/8"	
LG	3 5/16"	
HD	80A	

Notes: compatible with MAN

35004



Motor Mount Rear

OD	3 7/16"	OEM
OD<	2 3/4"	
ID	3/4"	
LG	2 13/16"	
HD	80A	

Notes: compatible with MAN

35005



Load Pad

OD	4 3/8"	OEM
ID	1 3/16"	
LG	1 3/4"	
HD	80A	

Notes: compatible with MAN

35006



Stabilizer Bar Bushing

OD	2 15/16"	OEM
ID	1 3/4"	
LG	2 1/16"	
HD	80A	

Notes: compatible with MAN

35007



Torque Rod Bushing

OD	1 7/8"	OEM
ID	5/8"	
LG	1 13/16"	
HD	80A	

Notes: compatible with MAN

35008



Torque Rod Bushing

OD	2 1/2"	OEM
ID	15/16"	
LG	1 11/16"	
HD	80A	

Notes: compatible with MAN

35009



Stabilizer Bar Bushing

OD	2 7/16"	OEM
ID	7/8"	
LG	15/16"	
HD	80A	

Notes: compatible with MAN

83520



Easy-Mount Torque Rod Bushing

OD	2 3/4"	OEM
C-C	4 3/8"	
BH	5/8"	
HD	80A	

TOOLS 18551, 18833

Notes: standard - 13520 / no metal sleeve - 13536

N8800599
N8884777
N8888164
20-833PU
R302226
R307639
C879
C879UB
E-2226
E-4664

DESCRIPTION	OEM	PART ID	PAGE
Alternator Bushing		31014	267
Beam End Bushing	498417 / 20-809PU / R301340 / R309511 / C865 / C865UB / E-1340 / E-9511 / D404 / 321-120 / 321-120U / M1724 / 09-5501 / M1976 / EB34000	13501	260
Beam End Bushing	452836 / 20-810PU / R301341A / R302771 / C862 / C862UB / C871 / E-1341A / E-2771 / E-9512 / D402 / 321-126 / 321-126U / 321-242 / M1726 / 09-5511 / 09-5728 / M1970 / M1970UB / M1988 / EB38000	13553	261
Beam End Bushing	NEW90008139 / WCM10050 / 60-1535 / R304382A / N120 / N120UB / E-4382A / E-8683 / D441 / 321-229 / 321-229U / M3456 / TRB5713 / PB57-21139	14513	263
Beam End Bushing	NEW90008149 / WCM11223 / 60-1501 / R304410A / N124 / E-4410A / D448 / 321-231 / 321-231U / M3454 / TRB5703 / PB57-21149	14533	263
Beam End Bushing Kit	3133712 / R305309 / R309577 / BA49 / BA50 / E-5309 / 334-381 / BA122 / BA122UB / BA123 / EA38000	13566	262
Bolster Spring	1089501 / 1577873 / 3090971 / 8151413 / 20390836 / V1609657 / V1629553 / VT1 / E-8851 / 334-916	12333	260
Bolster Spring Kit	HDR64179037 / HS130 / E-14044 / E-14374 / 334-1727 / 334-1845 / MLC3 / MLC5 / LP50-24179	13626	262
Bolt Kit	3938708 / B1509-50 / 334-832 / BPK100	13555	262
Cab Mount	6793185	12312	259
Cab Mount	66001-3204	12322	260
Cab Mount	80744666	12340	260
Cab Mount	2005774 / 15506936 / R307439 / R308650 / E-7439 / E-8650 / D56 / 329-111U / 329-117U / PL1087 / PL1088	18222	265
Cab Mount		31019	267
Camshaft Bushing	466670 / KC8011 / 382517 / 67358 / 16064 / 27-1191 /	17500	264
Camshaft Bushing	838961 / E-5512 / 02-210	17501	264
Carrier Bearing Assy	210661-1X / DS-6049	40074	274
Carrier Bearing Assy	515697 / 991790A / 2101211X / DS-6048	40075	274
Center Bushing	498403 / R301338 / R309520 / 20-816 / C864 / E-1338 / E-9520 / D403 / 321-117 / 321-119 / M1725 / 09-5500 / M1974 / M1978 / CB34012	13500	260
Center Bushing	452839 / 20-817 / R301339 / R306979 / R309359 / C863 / C877 / C887 / E-1339 / E-6979 / E-9359 / D401 / 321-122 / 321-124 / 321-243 / M1727 / 09-5510 / 09-5512 / 09-5513 / M1972 / M1972UB / CB38012	13505	261
Center Bushing	1714667 / R301594 / C866 / C866U / C866UB / E-1594 / D403 / 321-118 / 321-118U / 09-5620 / CB34010 / CB34011	13537	261
Center Bushing	1714668 / 20-820 / R301595 / R306980 / R309510 / C867 / C867UB / C888 / E-1595 / E-6980 / E-9510 / D401 / 321-123 / 321-123U / 321-244 / 09-5514 / 09-5621 / M1980 / M1980UB / CB38010 / CB38011	13543	261
Compressor Mount		31031	268
Easy-Mount Torque Rod Bushing	8079894 / 35003-0008 / 868331 / 20-832PU / R302225 / R307638 / C878 / C878UB / FL55 / E-2225 / E-7638 / D421 / 321-131 / 321-131U / M2069 / TRB164 / TRB6164 / TS34000 / TS34095	83522	274
End Plug		12334	260
End Plug		31071	270
Equalizer Bushing	35033-0001 / V8027424 / 549331 / 55-191PU / R301072 / R308688 / R132 / VV2 / E-8688 / D76 / 321-154U / M1869 / TRB5023	15017	264
Equalizer Bushing	35033-0005 / 321-241 / 09-7301	15018	264
Exhaust Mount		31008	266
Fan Hood Mount		31026	267
Fifth Wheel Bushing	FNTBSH109L / FNTBSH172U / FW99-32109 / FW99-32172	10079	258
Fifth Wheel Bushing	HOHXB0011 / FW51-32011	18215	265
Fifth Wheel Bushing	HOHXB0009 / KP116	18221	265
Fifth Wheel Bushing	HOHXB10605 / FW99-32605	40035	273
Hood Guide	67117-3235	12310	259
Hood Mount		31012	267

DESCRIPTION	OEM	PART ID	PAGE
Load Pad	683671 / 683672 / 20-824 / 20-826PU / R301598A / R301960 / R309513 / LC1 / LC1UB / LC3 / LC3UB / E-1598A / E-1599A / E-1960 / E-9513 / D135 / 325-101 / 325-103 / 325-104 / 325-104U / M2062 / 09-5532 / 09-5536 / 09-5537 / MLC4 / MLC8 / HC20000	13650	262
Load Pad		31060	269
Load Pad Kit	25115012 / 21036254 / SK50380-HW	12036	258
Load Pad Kit	25121508 / 21036254 / SK50340-HW	12039	259
Motor Mount	3081657 / 12004-0007 / 30-1384PU / R308918 / UM207 / E-8918 / D430 / 329-150U / M20304 / M20304UB / PL1048	10075	258
Motor Mount	04-9009997 / D324 / MM96-62870	12301	259
Motor Mount	12005-0001 / 12005-3207	12304	259
Motor Mount	12005-3208 / 12005-0002	12305	259
Motor Mount	2422749	16009	264
Motor Mount		18067	264
Motor Mount		18070	265
Motor Mount	702727 / 10-1059PU / 75-1759PU / R307440 / E-7440 / D54 / 329-110U / 329-165U / M17348 / M17348UB / PL1086	18232	265
Motor Mount		31021	267
Motor Mount		31040	268
Motor Mount		31086	271
Mount		31059	269
Radiator Mount		31005	266
Radiator Mount		31006	266
Radiator Mount		31007	266
Shackle	8067784	18599	265
Shifter Bushing Kit	FULK3399 / MS99-63399	11611	258
Shock Absorber Bushing	508678 / 401754 / PL1026	18010	264
Shock Absorber Bushing		31002	266
Shock Absorber Bushing		31004	266
Shock Absorber Bushing		31017	267
Shock Absorber Bushing		31054	268
Shock Absorber Bushing		31055	269
Shock Absorber Bushing		31062	269
Shock Absorber Bushing		31063	269
Shock Absorber Bushing		31064	269
Shock Absorber Bushing		31065	270
Spring Bushing		31052	268
Spring Bushing		31074	270
Spring Bushing		31080	270
Spring Bushing	1-362-710	32044	273
Spring Pin Bushing	35003-5005 / 50-275 / TB68 / 327-434 / 50-275 / TB-68 / M5212 / SP59-11010	11758	258
Stabilizer Bar Bushing		12317	259
Stabilizer Bar Bushing		31001	266
Stabilizer Bar Bushing		31037	268
Stabilizer Bar Bushing		31051	268
Stabilizer Bar Bushing		31053	268
Stabilizer Bar Bushing		31056	269
Stabilizer Bar Bushing		31057	269
Stabilizer Bar Bushing		31070	270
Stabilizer Bar Bushing		31072	270
Stabilizer Bar Bushing		31505	272
Stabilizer Bar Bushing		31514	272
Stabilizer Bar Bushing		32037	273

DESCRIPTION	OEM	PART ID	PAGE
Stabilizer Bar Bushing		32053	273
Torque Rod		18859	265
Torque Rod		31097	272
Torque Rod Assy	35801-5012 / MR661 / UR661 / E-2642	12044	259
Torque Rod Assy	HDR62010455 / TR50-42455	12396	260
Torque Rod Assy	HDR62350615 / TR50-41615	13733	263
Torque Rod Assy	32271-102 / 48411-006 / 50376-001 / 62007-365 / E-9394 / E-9409 / 345-734 / 345-792 / 345-815 / TR50-41102	13735	263
Torque Rod Assy	3187322 / 35801-0068 / 3187322 / 35801-0068 / 75-1709 / VT20 / E-8821 / 345-219 / 345-898 / R531 / R63 / TR96-41068	18860	265
Torque Rod Assy	943902 / 8021378 / 8028945 / 8071851 / 8074268 / R308853A / VT19 / E-8853A / 345-216 / 345-862 / TR96-41268	31095	271
Torque Rod Assy	HDR62350645 / TR50-41645	34555	273
Torque Rod Assy	HDR62000590 / HDR62001590 / 924920 / 942174 / 944160 / 944220 / 948574 / TR50-42590	34556	273
Torque Rod Bushing	119569 / FL63 / E-1197 / 322-123 / M1788 / 09-6540	11001	258
Torque Rod Bushing	227710 / 868331 / 3500333201 / M2069	11556	258
Torque Rod Bushing	35801-5016 / 20-831PU / R302228 / R308651 / C883 / C883UB / E-2228 / E-8651 / D422 / 321-133 / 321-133U / M2072 / 09-5721 / TRB6112 / TRB6112UB / TT38000	13518	261
Torque Rod Bushing	35801-5015 / N8800599 / N8884777 / N8888164 / 227720 / 02-27720 / 1688-227720 / 227720 / 1693061C1 / 44695 / 64400-002L / 66649-002 / A-2297-Y-77A / 20-833PU / R302226 / R307639 / C879 / C879UB / E-2226 / E-4664 / E-7639 / D423 / 321-132 / 321-132U / M2070 / 09-5723 / TRB6820 / TRB6820UB / TS38000 / 90.7023 / A80BL1056	13520	261
Torque Rod Bushing	8079894 / 35033-0008 / 868331 / 20-832PU / R302225 / R307638 / C878 / C878UB / FL55 / E-2225 / E-7638 / D421 / 321-131 / 321-131U / M2069 / TRB164 / TRB6164UB / TS34000 / TS34095	13522	261
Torque Rod Bushing	35801-5016 / 20-831PU / R302228 / E-2228 / D422 / M2072 / 09-5721 / TRB6112 / TT38000	13533	261
Torque Rod Bushing	UCA-3754 / 722-00 / 026900 / 12855 / 3-12-35 / 15209 / 31219 / 2530037 / 32460730 / 17012 / A80BL1026 / 25-708PU / R307453 / R30934 / RB201 / RBT201 / E-7453 / E-934 / D94 / 321-175 / 321-175U / M1888 / 09-3344 / TRB6326 / TRB6326UB / PL1119	14008	263
Torque Rod Bushing	A1712 / 34734C1 / 09729 01 / 09729-01 / 09729-01 / L1032 / 90.7010 / A80BL1043 / 0022-00 / A-1712 / 55-129 / 55-129PU / FBG-4989 / R301980 / R307520 / R129 / R129UB / E-1061 / E-1980 / E-7520 / E-8687 / D73 / 39400016 / 321-153 / 321-153U / M1449 / TRB6004 / TRB6004UB / PL1118 / UB30000	15013	264
Torque Rod Bushing		31000	266
Torque Rod Bushing		31016	267
Torque Rod Bushing		31018	267
Torque Rod Bushing		31068	270
Torque Rod Bushing		31069	270
Torque Rod Bushing		31087	271
Torque Rod Bushing		31088	271
Torque Rod Bushing	1620750 / 8152450	31093	271
Torque Rod Bushing	834240 / 321-288 / VO20000	31096	272
Torque Rod Bushing		31579	272
Torque Rod Bushing		32007	272
Torque Rod Bushing	6889513 / 0274-056	32008	272
Torque Rod Bushing	12-05-1002 / TS03-85002	32031	273
Torque Rod Bushing	HDRR005422 / E-11763 / 334-1672 / TRK4931 / PB00-26422 / SU99-39115	50033	274
Torque Rod End Assy	35801-5010 / MR630 / UR630 / E-2638 / 345-620 / 345-630 / 345-738 / 928630 / 09-5422 / RU620 / TR72000	13686	262

DESCRIPTION	OEM	PART ID	PAGE
Torque Rod End Assy	35801-5012 / R3010315 / R302642 / MR660 / MR661 / UR660 / UR661 / E-2642 / 345-660 / 345-661 / 345-741 / 345-742 / 928660 / 928661 / 09-5424 / 09-5431 / RU660 / RU661 / TR75000	13691	262
Torque Rod End Assy	20-9033 / MR680 / UR680 / E-2643 / 345-680 / 928680 / 09-5433 / R680 / TR76000	13694	262
Torque Rod End Assy	35801-5014 / 20-9023 / MR681 / UR681 / E-10317 / 345-681 / 928681 / 09-5426 / R681 / TR76000	13695	263
Torque Rod End Assy	20-9032 / MR690 / UR690 / 345-690 / 928690 / 09-5435 / R690 / TR77000	13696	263
Torque Rod End Assy	35801-5018 / 20-9022 / R302812 / MR691 / UR691 / E-2812 / 345-691 / 928691 / 09-5429 / R691 / TR77000	13697	263
Torsion Spring Mount		12344	260
Trunion Bushing	25154319 / 40-367PU / R303275A / R307479 / MIB219 / MIB219UB / MIB276 / E-3275A / E-7479 / D62 / 325-118 / 325-118U / 325-120 / 325-120U / M2113 / 09-7579 / 09-7583 / MSB684 / MSB684UB / MA10000	12015	258
V-Stay Bushing	1075255 / 1591689 / 3173759	31089	271
V-Stay Bushing		31090	271
V-Stay Bushing		31098	272
V-Stay Repair Kit		31082	271
V-Stay Repair Kit	274069	32009	273
Vertical Drive Bushing	498407A / R301940 / R309515 / C874 / C874UB / E-1940 / E-9515 / D107 / 321-125 / 321-125U / 09-5535 / TRB5170 / HV38000	13592	262
Wear Pad		31049	268

STEMCO GAFF replacement parts compatible with:
VOLVO® CORPORATE AIR RIDE®
SINGLE/TANDEM AXLE AIR SUSPENSION

STEMCO GAFF replacement parts compatible with:
**VOLVO® EXPEDITOR®/ ROAD COMMANDER II®/
WG/WCA/WIA/WHR/WHL/WHE FRONT SUSPENSION**

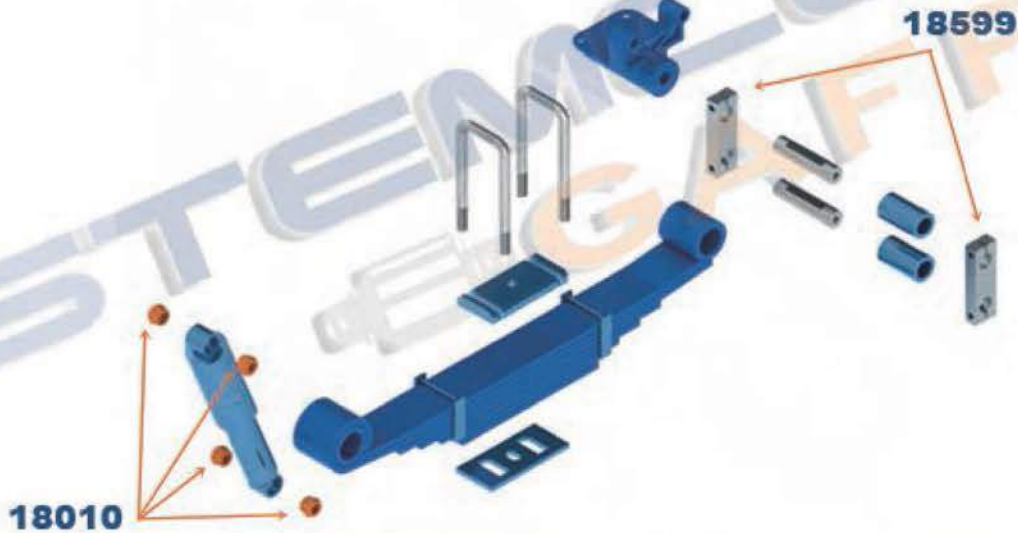

STEMCO GAFF replacement parts compatible with:
VOLVO® SINGLE AXLE REAR SUSPENSION



STEMCO GAFF replacement parts compatible with:
VOLVO® STEEL HANGER
FOUR SPRING TANDEM SUSPENSION

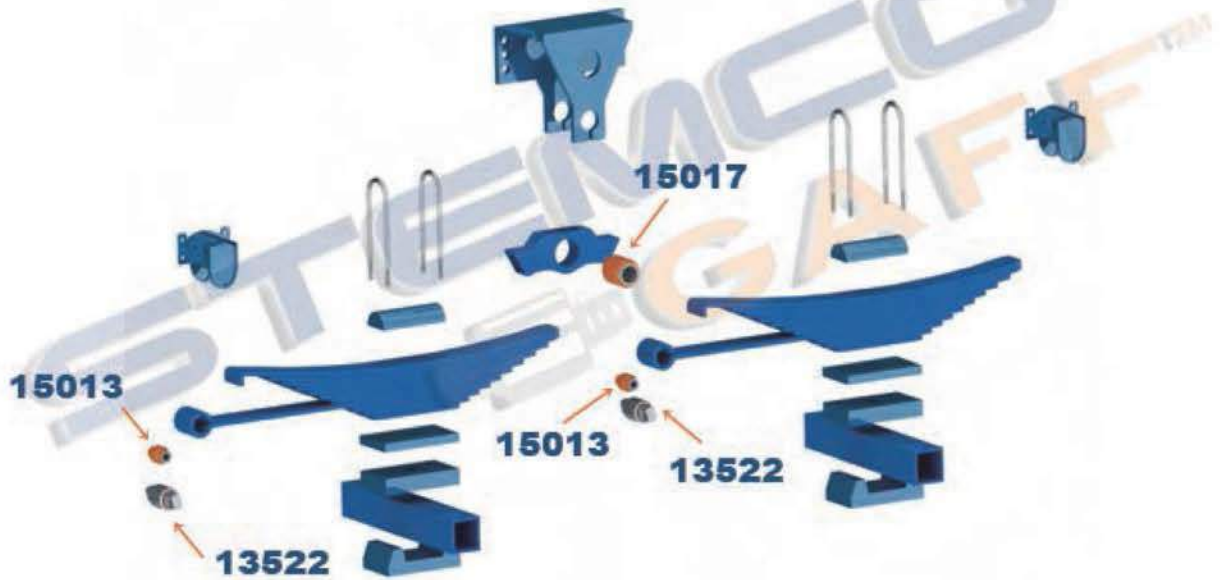

STEMCO GAFF replacement parts compatible with:
VOLVO® T-RIDE® SINGLE POINT,
REAR TANDEM SUSPENSION



10075Motor Mount
Rear

OD	3	-
ID	1	1/2
LG	3	-
HD	80A	-

TOOL 11076

OEM

3081657
12004-0007
30-1384PU
R308918
UM207
E-8918
D430
329-150U
M20304
M20304UB

Notes: with metal sleeve

10079

Fifth Wheel Bushing

OD	3	3/16	-
ID	1	1/4	-
LG	2	11/16	-
LG2	2	5/16	-
HD	80A	-	-

Notes: components not sold separately

OEM

FNTBSH109L
FNTBSH172U
FW99-32109
FW99-32172

11001

Torque Rod Bushing

OD	2	7/16	-
OD<	1	15/16	-
ID	1	5/16	-
LG	1	15/16	-
HD	71D	-	-

OEM

119569
FL63
E-1197
322-123
M1788
09-6540

Notes:

11556

Torque Rod Bushing

OD	2	11/16	-
C-C	4	3/8	-
BH		5/8	-
HD	80A	-	-

Notes: verify dimensions compare to 13522 and 83522

OEM

227710
868331
3500333201
M2069

11611

Shifter Bushing Kit

OD	1	1/2	-
ID		13/16	-
LG	2	5/16	-
BH		3/4	-
HD	90A	-	-

OEM

FULK3399
MS99-63399

Notes:

11758

Spring Pin Bushing

OD	1	3/4	-
C-C	5	3/4	-
HD	80A	-	-

INCLUDED IN:
11757

TOOL 40090

Notes:

OEM

35003-5005
50-275
TB68
327-434
50-275
TB-68
M5212
SP59-11010

12015

Trunnion Bushing

OD	4	11/16	-
ID	3	7/16	-
LG	6	1/4	-
HD	80A	-	-

INCLUDED IN:
12037**OEM**

25154319
40-367PU
R303275A
R307479
MIB219
MIB219UB
MIB276
E-3275A
E-7479
D62

Notes: supersedes 12005

12036Load Pad Kit
380/440**INCLUDES**

QTY 4	12010
QTY 4	12014
QTY 1	12081 - Bolt Kit
	4 - Bolts 7/8" x 4" UNC
	12 - Bolts 1/2" x 6" UNF
	12 - Lock Nuts 1/2" UNF
	16 - Flat Washers 1/2"

OEM

21036254
25115012
SK50380-HW

Notes:

12039



INCLUDES
 QTY 4 12006
 QTY 4 12014
 QTY 1 12083 - Bolt Kit
 4 - Bolts 3/4" x 4" UNC
 12 - Bolts 3/4" x 5" UNF
 12 - Lock Nuts 3/4" UNF
 16 - Flat Washers 3/4"

OEM
 21036254
 25121508
 SK50340-HW

Load Pad Kit 340

Notes:

12044



C-C 26 -
 BC-C 4 3/8 -
 BH 5/8 -

INCLUDES
 QTY 1 13590
 QTY 2 13520

OEM
 35801-5012
 MR661
 UR661
 E-2642

Torque Rod Assy Weldable

Notes: universal torque rod

12301



THK 1 1/4 -
 WD 3 -
 C-C 6 1/4 -
 HD 80A

OEM
 04-9009997
 D324
 MM96-62870

Motor Mount Rear

Notes: compatible with Western Star® uses (1) 12301 with (2) 11523

12304



THK 2 1/16 -
 WD 3 1/2 -
 LG 10 -
 C-C 4 -
 BC-C 8 9/16 -
 BH 5/8 -
 HD 72D - 80A

OEM
 12005-0001
 12005-3207

Motor Mount Front

Notes:

12305



OD 2 13/16 -
 ID 5/8 -
 HGT 1 1/16 -
 HD 80A

OEM
 12005-3208
 12005-0002

Motor Mount Front (Upper)

Notes:

12310



WD 1 7/16 -
 THR 5/16" UNC -
 HGT 3 -
 HD 71D-80A

OEM
 67117-3235

Hood Guide

Notes:

12312



ID 13/16 -
 WD 2 15/16 -
 C-C 6 5/16 -
 HGT 3 1/4 -
 HD 80A

OEM
 6793185

Cab Mount

Notes: compatible with cab 660

12317



ID 1 5/8 -
 WD 2 7/16 -
 LG 2 -
 HGT 2 1/4 -
 HD 71D

OEM

Stabilizer Bar Bushing

Notes:

12322Cab Mount
Rear

OD	2	-
ID	5/8	-
C-C	4	15/16
HGT	2	-
HD	80A	-

OEM
66001-3204

Notes: compatible with cab 660

12333

Bolster Spring

WD	5	1/4	-
LG	8	1/4	-
HGT	5	7/8	-
HD	90A	-	-

OEM
1089501
1577873
3090971
8151413
20390836
V1609657
V1629553
VT1
E-8851
334-916

Notes: 4 per truck / recommended to replace set in same repair / don't mix brands

12334End Plug
Steel

OD	3	5/8	-
----	---	-----	---

OEM

Notes: not offered by OE

12340

Cab Mount

OD	2	43/64	-
ID	1	11/16	-
LG	4	3/16	-
HD	80A	-	-

OEM
80744666

TOOL 40030

Notes:

12344

Torsion Spring Mount

THK	3	7/8	-
WD	4	5/16	-
LG	4	1/8	-
C-C	3	5/16	-
BH	7	7/16	-

OEM

Notes: 2 per truck / compatible with VNL 630

12396

Torque Rod Assy

C-C	17	5/16	-
BC-C	4	3/8	-
BH	5	5/8	-

OEM
HDR62010455
TR50-42455**INCLUDES**
QTY 2 13520

Notes:

13500

Center Bushing

OD	3	5/8	-
OD<	2	3/4	-
LG	12	-	-
HD	80A	-	-

INCLUDED IN:
13503, 13504, 13591

TOOLS 18543, 18544

OEM
498403
R301338
R309520
20-816
C864
E-1338
E-9520
D403
321-117
321-119

Notes: welded plug

13501

Beam End Bushing

OD	4	3/8	-
ID	2	1/2	-
LG	5	1/4	-
HD	80A	-	-

INCLUDED IN:
13503, 13504

TOOLS 13564, 18541, 18542

OEM
498417
20-809PU
R301340
R309511
C865
C865UB
E-1340
E-9511
D404

Notes: for complete repair use adapter 13502 / additional tool suggestion 13588

13505



OD	4 3/4"	~
OD<	3 1/2"	~
LG	12	
HD	80A	

INCLUDED IN:
13508, 13548, 13587

TOOLS 13570, 18539, 18540

OEM
452839
20-817
R301339
R306979
R309359
C863
C877
C887
E-1339

Center Bushing

Notes: standard-welded plug / double bonded-welded plug - 13636 / standard-loose plug - 13543

13518



OD	2 3/4"	~
LG	8 1/16"	~
THR	1 1/4" - 12 UNF	
HD	80A	

INCLUDED IN:
11794, 11808, 13657, 13679, 13686, 13694, 13695, 34555

TOOLS 13584, 18833

OEM
35801-5016
20-831PU
R302228
R308651
C883
C883UB
E-2228
E-8651
D422
321-133

Torque Rod Bushing

Notes: metal sleeve / 13533 - no sleeve / additional tool suggestion 18551, coming soon 40131

13520



OD	2 3/4"	~
C-C	4 3/8"	~
BH	5/8"	~
HD	80A	

INCLUDED IN:
Several Kits

TOOLS 18551, 18833

OEM
35801-5015
N8800599
N8884777
N8888164
227720
02-27720
1688-227720
227720
1693061C1
44695

Torque Rod Bushing

Notes: easy mount - 83520 / no sleeve - 13536

13522



OD	2 17/32"	~
C-C	4 3/8"	~
BH	5/8"	~
HD	80A	

TOOLS 18553, 18833

OEM
8079894
35033-0008
868331
20-832PU
R302225
R307638
C878
C878UB
FL55
E-2225

Torque Rod Bushing

Notes: metal sleeve / easy mount - 83522 / no sleeve - 11003 / additional tool suggestion coming soon 40131

13533



OD	2 15/16"	~
LG	8 1/16"	~
THR	1 1/4" - 12 UNF	
HD	80A	

TOOL 18831

OEM
35801-5016
20-831PU
R302228
E-2228
D422
M2072
09-5721
TRB6112
TT38000

Torque Rod Bushing

Notes: 13518 - metal sleeve

13537



OD	3 5/8"	~
ID	2"	~
LG	10 1/2"	~
HD	80A	

OEM
1714667
R301594
C866
C866U
C866UB
E-1594
D403
321-118
321-118U
09-5620

Center Bushing

Notes: no plug / verify dimensions / compatible with Raydan

13543



OD	4 3/4"	~
ID	2 1/2"	~
LG	12	
HD	80A	

OEM
1714668
20-820
R301595
R306980
R309510
C867
C867UB
C888
E-1595
E-6980

Center Bushing Loose Plug

Notes: standard-loose plug / double bonded-welded plug - 13636 / standard-welded plug - 13505 / additional tool suggestions 13570, 18539, 18540

13553



OD	4 3/8"	~
ID	2 1/2"	~
LG	5 3/4"	~
HD	80A	

INCLUDED IN:
13587

TOOLS 13563, 13588

OEM
452836
20-810PU
R301341A
R302771
C862
C862UB
C871
E-1341A
E-2771
E-9512

Beam End Bushing

Notes: uncrimped sleeve double bonded bushing / supersedes 13506 / use adapter 13507 for complete repair / additional tool suggestion 13595

13555

LG	9 1/2"
THR	1 1/2" - 7 UNC
HD	Steel

INCLUDED IN:
13510

OEM

3938708
B1509-50
334-832
BPK100



Bolt Kit

Notes: for use with 13565

13566**INCLUDES**

QTY 1	13609
QTY 1	13506

OEM

3133712
R305309
R309577
BA49
BA50
E-5309
334-381
BA122
BA122UB
BA123



Beam End Bushing Kit

Notes:

13592

OD	4 1/8"
ID	2"
LG	4"
HD	80A

OEM

498407A
R301940
R309515
C874
C874UB
E-1940
E-9515
D107
321-125
321-125U

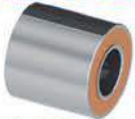

Vertical Drive Bushing

Notes:

13626

BC-C	4 3/4"
THR	1/2"
HD	80A

OEM

HDR64179037
HS130
E-14044
E-14374
334-1727
334-1845
MLC3
MLC5
LP50-24179



Bolster Spring Kit

Notes: 4 kits per truck / recommended to replace set in same repair / don't mix brands

13650

OD	6 3/4"
ID	3 15/16"
THK	3 1/8"
LG	4 1/16"
HD	11 15/16"
	80A

OEM

683671
683672
20-824
20-826PU
R301598A
R301960
R309513
LC1
LC1UB
LC3



Load Pad

Notes:

13686

LG	8 9/16"
LG²	8 1/16"
THR	1 1/2" - 12 UNF
HD	80A

INCLUDES

QTY 1	13681
QTY 1	13518

OEM

35801-5010
MR630
UR630
E-2638
345-620
345-630
345-738
928630
09-5422
TMRU620

Torque Rod End Assy
Tube End

Notes:

13691

LG	25 7/16"
BC-C	4 3/8"
BH	5/8"
HD	80A

INCLUDES

QTY 1	13682
QTY 1	13520

OEM

35801-5012
R3010315
R302642
MR660
MR661
UR660
UR661
E-2642
345-660
345-661

Torque Rod End Assy
27" Rod End

Notes:

13694

LG	33 7/16"
LG²	8 1/16"
THR	1 1/2" - 12 UNF
HD	80A

INCLUDES

QTY 1	13707
QTY 1	13518

OEM

20-9033
MR680
UR680
E-2643
345-680
928680
09-5433
TMR680
TR76000

Torque Rod End Assy
35" Rod End

Notes:

13695



LG 25 7/16"
LG² 8 1/16"
THR 1 1/4"-12 UNF
HD 80A

INCLUDES
QTY 1 13682
QTY 1 13518

OEM
35801-5014
20-9023
MR681
UR681
E-10317
345-681
928681
09-5426
TMR681
TR76000

Torque Rod End Assy
27" Rod End

Notes:

13696



LG 33 7/16"
LG² 7
THR 1 1/4"-12 UNF
HD 80A

INCLUDES
QTY 1 13707
QTY 1 12031

OEM
20-9032
MR690
UR690
345-690
928690
09-5435
TMR690
TR77000

Torque Rod End Assy
35" Rod End

Notes:

13697



LG 25 7/16"
LG² 7
THR 1 1/4"-12 UNF
HD 80A

INCLUDES
QTY 1 13682
QTY 1 12031

OEM
35801-5018
20-9022
R302812
MR691
UR691
E-2812
345-691
928691
09-5429
TMR691

Torque Rod End Assy
27" Rod End

Notes:

13733



C-C 14 3/8"
BC-C 4 3/8"
BH 5/8"
THR 1 1/4"-12UNF

INCLUDES
QTY 1 13520
QTY 1 13518

OEM
HDR62350615
TR50-41615

Torque Rod Assy

Notes:

13735



C-C 14 3/8"
BC-C 4 3/8"
BH 5/8"

INCLUDES
QTY 2 13520

OEM
32271-102
48411-006
50376-001
62007-365
E-9394
E-9409
345-734
345-792
345-815
TR50-41102

Torque Rod Assy

Notes:

14008



OD 1 15/16"
ID 1
LG 3
HD 80A

OEM
UCA-3754
722-00
026900
12855
3-12-35
15209
31219
2530037
32460730
17012

Torque Rod Bushing

TOOL 18836

Notes: chamfered / stepped ends - 14073

14513



OD 3 1/2"
ID 1 1/8"
LG 5 1/4"
HD 80A

OEM
NEW90008139
WCM10050
60-1535
R304382A
N120
N120JB
E-4382A
E-8683
D441
321-229

Beam End Bushing

Notes: additional tool suggestion 14531

14533



OD 2 13/16"
ID 1 1/8"
LG 5
HD 80A

OEM
NEW90008149
WCM11223
60-1501
R304410A
N124
E-4410A
D448
321-231
321-231U
M3454

Beam End Bushing

Notes: supersedes 14528 / additional tool suggestion 14531

15013

OD	1 15/16"
ID	7/8"
LG	3"
HD	80A

INCLUDED IN:
15063
OEM
 A1712
 34734C1
 09729 01
 09729-01
 09729-01
 L1032
 90.701
 A80BL1043
 0022-00
 A-1712

Torque Rod Bushing

Notes: additional tool suggestions 18836, coming soon 40124

15017

OD	3 3/16"
ID	2"
LG	3 7/8"
HD	80A

OEM
 35033-0001
 V8027424
 549331
 55-191PU
 R301072
 R308688
 R132
 VV2
 E-8688
 D76

Equalizer Bushing

Notes: chamfered inner metal bushing / verify dimensions compare to 15004 - chamfered with center groove

15018

OD	3 3/16"
ID	1 1/2"
LG	3 7/8"
HD	80A

OEM
 35033-0005
 321-241
 09-7301

Equalizer Bushing

Notes:

16009

THK	3/4"
WD	2 1/2"
LG	5 1/2"
HD	80A

OEM
 2422749
Motor Mount
Rear

Notes:

17500

OD	2 7/16"
ID	1 1/2"
LG	1 1/2"
HD	71D

OEM
 466670
 KC8011
 382517
 67358
 16064
 27-1191

Camshaft Bushing

Notes:

17501

OD	1 7/8"
ID	1 1/2"
LG	1 3/16"
HD	71D

OEM
 838961
 E-5512
 02-210

Camshaft Bushing

Notes:

18010

OD	1 1/2"
ID	3/4"
LG	15/16"
HD	80A

OEM
 508678
 401754
 PL1026

Shock Absorber Bushing

Notes:

18067

THK	2"
WD	3"
LG	7"
BH	9/16"
THR	9/16" - 12 UNC
HD	80A-72D

OEM

Motor Mount

Notes:

18070



THK	2	-
WD	3	-
LG	7	-
BH	9/16	-
HD	80A-71D	-

OEM

Motor Mount

Notes:

18215



OD	2	-
ID	1 1/8	-
LG	4 1/4	-
HD	80A	-

OEM
HOHXB0011
FW51-32011

Fifth Wheel Bushing

Notes: no groove / verify dimensions compare to 18094

18221



OD	3 1/2	-
ID	1 1/4	-
LG	3 3/4	-
HD	80-71A	-

OEM
HOHXB0009
KP116

Fifth Wheel Bushing

Notes:

18222



OD	2 7/16	-
OD<	1 5/8	-
ID	5/8	-
LG	1 15/16	-
HD	80A	-

OEM
2005774
15506936
R307439
R308650
E-7439
E-8650
D56
329-111U
329-117U
PL1087

Cab Mount

Notes:

18232



OD	3 1/4	-
OD<	2 1/4	-
ID	1 1/16	-
LG	2 5/8	-
HD	80A	-

OEM
702727
10-1059PU
75-1759PU
R307440
E-7440
D54
329-110U
329-165U
M17348
M17348UB

Motor Mount Front

Notes:

18599



ID	1 1/8	-
THK	1	-
WD	2	-
LG	6 5/16	-
C-C	3 11/16	-

OEM
8067784

Shackle

Notes:

18859



ID	2 3/4	-
C-C	22 1/8	-

INCLUDED IN:
18860

OEM

Torque Rod

Notes:

18860



C-C	22 1/8	-
BC-C	4 3/8	-
BH	5/8	-
HD	80A	-

INCLUDES
QTY 1 18859
QTY 2 13520

OEM
3187322
35801-0068
3187322
35801-0068
75-1709
VT20
E-8821
345-219
345-898
TMR531

Torque Rod Assy

Notes:

31000

OD	3 9/16"
C-C	4 15/16"
BH	9/16"
HD	80A

OEM



Torque Rod Bushing

TOOL 18835

Notes:

31001

OD	2 1/8"
ID	9/16"
LG	1 5/8"
HD	70A

OEM



Stabilizer Bar Bushing

Notes:

31002

OD	2 3/8"
ID	1 3/16"
LG	1 1/4"
HD	80A

OEM



Shock Absorber Bushing

Notes:

31004

OD	1 3/4"
ID	5/8"
LG	2 3/16"
HD	80A

OEM



Shock Absorber Bushing

Notes:

31005

OD	2 13/16"
LG	3"
THR	10 mm - P1.5
HD	70A

OEM



Radiator Mount

Notes:

31006

OD	2 3/4"
LG	2 15/16"
THR	10 mm - P1.5
HD	70A

OEM



Radiator Mount

Notes:

31007

OD	2 1/8"
ID	1/2"
LG	1 5/16"
HD	70A

OEM



Radiator Mount

Notes:

31008

OD	1 15/16"
LG	2 3/4"
THR	7/16" - 14 UNC
HD	70A

OEM



Exhaust Mount

Notes:

31012



Hood Mount

OD	15/16"	OEM
LG	1 15/16"	
THR	10 mm - P1.5	
HD	70A	

Notes:

31014



Alternator Bushing

OD	1 1/4"	OEM
ID	9/16"	
LG	1 13/16"	
HD	70A	

Notes:

31016



Torque Rod Bushing

OD	3 5/8"	OEM
ID	2 1/16"	
LG	3 3/8"	
HD	80A	

TOOL 18835

Notes:

31017



Shock Absorber Bushing

OD	2 1/8"	OEM
ID	1"	
LG	1 1/8"	
HD	80A	

Notes:

31018



Torque Rod Bushing

OD	3"	OEM
ID	1 13/16"	
LG	2 13/16"	
HD	80A	

Notes:

31019



Cab Mount

THK	2 3/16"	OEM
WD	4 3/8"	
LG	4 5/8"	
THR	1/2" - 13 UNC	
HD	80A	

Notes:

31021



Motor Mount Rear (Upper)

OD	3 1/8"	OEM
ID	7/8"	
LG	1 11/16"	
HD	80A	

Notes:

31026



Fan Hood Mount

OD	2 5/16"	OEM
ID	1/2"	
LG	2"	
HD	70A	

Notes:

31031

OD	1 1/4"
ID	9/16"
LG	1 13/16"
HD	80A

OEM



Compressor Mount

Notes:

31037

OD	2 1/8"
ID	9/16"
LG	1 5/8"
HD	80A

OEM



Stabilizer Bar Bushing

Notes:

31040

THK	3 7/8"
WD	3 7/16"
LG	5 13/16"
HD	80A

OEM



Motor Mount

Notes:

31049

THK	5/16"
WD	3 5/16"
LG	59 9/16"
HGT	1 1/2"
HD	90A

OEM



Wear Pad Step

Notes:

31051

ID	1 5/8"
THK	2 1/4"
WD	2 3/4"
LG	2 3/8"
HD	90A

OEM



Stabilizer Bar Bushing

Notes:

31052

OD	1 13/16"
ID	13/16"
LG	4 1/2"
HD	80A

OEM



Spring Bushing

Notes:

31053

OD	1 1/2"
ID	5/8"
LG	1 7/8"
HD	80A

OEM



Stabilizer Bar Bushing

Notes:

31054

OD	1 7/16"
ID	1"
LG	7/8"
HD	80A

OEM



Shock Absorber Bushing

Notes:

31055



Shock Absorber Bushing

OD	1 11/16"
ID	5/8"
LG	1 5/8"
HD	80A

OEM

Notes:

31056



Stabilizer Bar Bushing

OD	2"
ID	9/16"
LG	1 5/8"
HD	70A

OEM

Notes:

31057



Stabilizer Bar Bushing

OD	2 1/4"
OD<	1 3/16"
ID	13/16"
LG	1"
HD	80A

OEM

Notes:

31059



Mount Monitor

OD	1 1/8"
ID	1/4"
LG	1 7/8"
HD	70A

OEM

Notes:

31060



Load Pad

THK	2 1/8"
WD	2"
LG	5 3/4"
HD	80A

OEM

Notes:

31062



Shock Absorber Bushing

OD	2 1/2"
ID	1 1/8"
LG	3 15/16"
HD	80A

OEM

Notes:

31063



Shock Absorber Bushing

OD	2 1/2"
ID	1 1/8"
LG	2 5/8"
HD	80A

OEM

Notes:

31064



Shock Absorber Bushing

OD	1 13/16"
ID	5/8"
LG	3 15/16"
HD	80A

OEM

Notes:

31065

OD	1 13/16"
ID	5/8"
LG	1 1/8"
HD	80A

OEM



Shock Absorber Bushing

Notes:

31068

OD	3 5/8"
ID	2 1/16"
LG	3 3/8"
HD	80A

OEM



Torque Rod Bushing

Notes:

31069

OD	3 5/8"
C-C	4 15/16"
BH	9/16"
HD	80A

OEM



Torque Rod Bushing

Notes:

31070

OD	1 13/16"
OD<	1 3/8"
ID	1 1/16"
LG	7/8"
HD	71D

OEM



Stabilizer Bar Bushing

Notes:

31071

OD	4 1/4"
LG	5/8"

OEM

End Plug
Steel

Notes: compatible with V bar on Volvo® T-Ride

31072

ID	1 3/4"
THK	2 3/4"
WD	1 11/16"
LG	2 1/4"
HD	80A

OEM



Stabilizer Bar Bushing

Notes:

31074

OD	1 13/16"
ID	1"
LG	4 1/2"
HD	80A

OEM



Spring Bushing

Notes:

31080

OD	1 13/16"
ID	3/4"
LG	4 1/2"
HD	80A

OEM



Spring Bushing

Notes:

31082



V-Stay Repair Kit

OD	2 13/16"	OEM
ID	1 7/16"	
LG	1 13/16"	
HD	72D	

Notes: compatible with T-Ride Suspension / only available in kits not sold individually / kit not offered by OE

31086



Motor Mount

OD	2 3/8"	OEM
ID	1 1/16"	
LG	5/16"	
HD	80A	

Notes:

31087



Torque Rod Bushing

OD	2 15/16"	OEM
LG	6 3/8"	
C-C	5 1/8"	
BH	3/4"	
HD	80A	

Notes: not offered by OE / additional tool suggestion 18831

31088



Torque Rod Bushing

OD	3 19/32"	OEM
C-C	4 29/32"	
BH	9/16"	
HD	80A	

Notes:

31089



V-Stay Bushing Center Threaded

OD	5 7/16"	OEM
LG	3 3/4"	
C-C	1 5/8"	
BH	9/16"	
THR	9/16" 12 UNC	
HD	80A	

TOOL 31091

Notes:

31090



V-Stay Bushing

OD	2 13/16"	OEM
LG	2 1/16"	
LG2	1 15/16"	
THR	14 mm	
HD	P1.5 x 40 mm	
	80A	

Notes:

31093



Torque Rod Bushing

OD	3 9/16"	OEM
C-C	4 9/16"	
BH	1 1/16"	
HD	80A	

1620750
8152450

Notes:

31095



Torque Rod Assy Angled

C-C	22 5/8"	OEM
BC-C	4 3/8"	
BH	1 1/16"	

INCLUDES

QTY 1	31097
QTY 2	11729

943902
8021378
8028945
8071851
8074268
R308853A
VT19
E-8853A
345-216
345-862

Notes:

31096

OD	2 3/4"
C-C	3 15/16"
BH	1 1/16"
HD	80A

OEM
834240
321-288
VO20000



Torque Rod Bushing

Notes:

31097

ID	2 3/4"
C-C	22 5/8"

OEM

INCLUDED IN:
31095



Torque Rod Angled

Notes: not offered by OE

31098

OD	5 1/2"
LG	2 13/16"
C-C	1 61/64"
BH	3/8"
THR	3/8"
HD	1/4" 24 UNF 80A

OEM

V-Stay Bushing

Notes:

31505

OD	3 3/4"
ID	2"
LG	4"
HD	80A

OEM

Stabilizer Bar Bushing

Notes:

31514

WD	3 1/4"
LG	3 1/8"
HGT	1 9/16"
HD	80A

OEM

Stabilizer Bar Bushing

Notes:

31579

OD	3 3/8"
C-C	6"
BH	13/16"
HD	80A

OEM

Torque Rod Bushing

TOOL 18835

Notes:

32007

OD	3 5/16"
C-C	5 1/8"
BH	3/4"
HD	80A

OEM

Torque Rod Bushing

TOOL 18835

Notes:

32008

OD	3 3/4"
C-C	6"
BH	15/16"
HD	80A

OEM
6889513
0274-056



Torque Rod Bushing

TOOL 18834

Notes:

32009



V-Stay Repair Kit

OD	3 9/16"
THR	3/4" - 16 UNF
HGT	2 7/16"
HD	70A-71D

OEM
274069

TOOL 18834

Notes: components not sold separately

32031



Torque Rod Bushing

OD	2 15/16"
C-C	4 1/2"
BH	5/8"
HD	80A

OEM
12-05-1002
TS03-85002

TOOL 18831

Notes:

32037



Stabilizer Bar Bushing

ID	1 3/4"
HGT	3 1/8"
HD	80A

OEM

Notes:

32044



Spring Bushing

OD	2 11/16"
ID	1 3/16"
LG	4 1/16"
HD	80A

OEM
1-362-710

TOOL 18833

Notes:

32053



Stabilizer Bar Bushing

ID	2"
LG	4"
HGT	3"
HD	80A

OEM

Notes:

34555



Torque Rod Assy

LG	8 1/4"
C-C	25 1/4"
BC-C	4 3/8"
BH	5/8"
THR	1/2" - 12 UNF

OEM
HDR62350645
TR50-41645

INCLUDES
QTY 1 13520
QTY 1 13518

Notes:

34556



Torque Rod Assy

C-C	23 1/4"
BC-C	4 3/8"
BH	5/8"

INCLUDES
QTY 2 13520

OEM
HDR62000590
HDR62001590
924920
942174
944160
944220
948574
TR50-42590

Notes:

40035



Fifth Wheel Bushing Kit

OD	3 7/8"
OD<	2 5/16"
ID	1 5/32"
LG	2 1/16"
HD	80A

OEM
HOHXB10605
FW99-32605

Notes: components not sold separately

40074



Carrier Bearing Assy

ID	2	3/8"
C-C	8	1/2"
BH		1/2"
HGT	3	21/64"
HD	70A	

OEM
210661-1X
DS-6049

Notes: Includes carrier bearing bushing 18002

40075



Carrier Bearing Assy

ID	2	
C-C	7	7/16"
BH		1/2"
HGT	2	25/32"
HD	70A	

OEM
515697
991790A
2101211X
DS-6048

Notes: includes carrier bearing bushing 18725

50033



Torque Rod Bushing

INCLUDES

QTY	2	34514
QTY	1	Pivot Bolt 7/8" - 16 UNF x 6 GB
QTY	1	Lock Nut 7/8"
QTY	1	Flat Washer 7/8"
QTY	1	Sleeve 1 1/2" x 7/8" x 3"

OEM
HDRR005422
E-11763
334-1672
TRK4931
PB00-26422
SU99-39115

Notes:

83522



Easy-Mount Torque Rod Bushing

OD	2	17/32"
C-C	4	3/8"
BH		5/8"
HD	80A	

OEM
868331
8079894
35003-0008
151087-148
44694
44694-000L
1693060C1
3249322R1
227710
1688-227710

TOOLS 18553, 18833

Notes: 13522 - standard / 11003 - no metal sleeve

Watson & Chalin

DESCRIPTION	OEM	PART ID	PAGE
Axle Pad	SP-0040 / SP-0193 / 60-1527 / 60-1546PU / R301330 / R308669 / R308670 / N254 / E-1330 / E-8669 / E-8670 / D231 / D352 / 325-139U / 325-142 / 325-142U / 09-4424 / MTN456 / MTN457 / PL1041	14522	275
Beam End Bushing	10050 / 60-1535 / R304382A / N120 / N120UB / E-4382A / E-8683 / D441 / 321-229 / 321-229U / M3456 / TRB5713 / PB57-21139	14513	275
Beam End Bushing	11223 / 60-1501 / R304410A / N124 / E-4410A / D448 / 321-231 / 321-231U / M3454 / TRB5703 / PB57-21149	14533	275
Control Arm Bushing	19204 / 19682 / PB00-36314	34514	275
Spring Pad	SP-0039 / R303582 / R308664 / FR220 / E3582 / E-3582 / E-8664 / D217 / 325-151 / 325-151U / 09-2274 / M9632 / M9632UB / PL1005	13037	275
Torque Rod Bushing	17012 / 25-708PU / R307453 / R30934 / RB201 / RBT201 / E-7453 / E-934 / D94 / 321-175 / 321-175U / M1888 / 09-3344 / TRB6326 / TRB6326UB / PL1119	14008	275
Torque Rod Bushing	17012 / 25-708PU / R307453 / R30934 / RB201 / RBT201 / E-7453 / E-934 / D94 / 321-175 / 321-175U / M1888 / 09-3344 / TRB6326 / TRB6326UB / PL1119	14073	275
Trunnion Bushing	SP-0192 / 60-1541 / R301332 / R307486 / N215 / N215UB / E-1332 / E-7486 / D232 / 325-137 / 325-137U / M1706 / 09-4422 / TRB5909 / NW30000	14521	275

Watson & Chalin continued

13037



THK 1
WD 4 3/4
LG 7 5/8
HD 80A

OEM
SP-0039
R303582
R308664
FR220
E3582
E-3582
E-8664
D217
325-151
325-151U

Spring Pad

Notes:

14008



OD 1 15/16
ID 1
LG 3
HD 80A

OEM
17012
25-708PU
R307453
R30934
RB201
RBT201
E-7453
E-934
D94
321-175

Torque Rod Bushing

TOOL 18836

Notes: chamfered / 14073 - stepped ends

14073



OD 1 15/16
ID 1
LG 3
HD 80A

OEM
17012
25-708PU
R307453
R30934
RB201
RBT201
E-7453
E-934
D94
321-175

Torque Rod Bushing

TOOL 18836

Notes: stepped ends / new design / chamfered - 14008

14513



OD 3 1/2
ID 1 1/8
LG 5 1/4
HD 80A

OEM
10050
60-1535
R304382A
N120
N120UB
E-4382A
E-8683
D441
321-229
321-229U

Beam End Bushing

Notes: additional tool suggestion 14531

14521



OD 5
ID 4
LG 8 3/4
HD 80A

OEM
SP-0192
60-1541
R301332
R307486
N215
N215UB
E-1332
E-7486
D232
325-137

Trunnion Bushing

Notes:

14522



THK 3/4
WD 4 1/2
LG 5 1/8
HD 80A

OEM
SP-0040
SP-0193
60-1527
60-1546PU
R301330
R308669
R308670
N254
E-1330
E-8669

Axle Pad

Notes:

14533



OD 2 13/16
ID 1 1/8
LG 5
HD 80A

OEM
11223
60-1501
R304410A
N124
E-4410A
D448
321-231
321-231U
M3454
TRB5703

Beam End Bushing

Notes: supersedes 14528 / additional tool suggestion 14531

34514



OD 3
OD< 2 1/4
ID 1 1/2
LG 1 7/16
HD 90A

OEM
19204
19682
PB00-36314

Torque Rod Bushing Green

INCLUDED IN:
50033

Notes: compatible with Arvin Meritor kit 11102

DESCRIPTION	OEM	PART ID	PAGE
Cab Mount	04-9009996 / 12004-3401 / 35-548PU / R307472 / UM1113 / E-7472 / D6 / 329-136U / M17412 / M17412UB / MM96-62401 / PL1015 / PL1015-HT	11520	278
Cab Mount	04-9009996 / 12004-3401 / 35-548PU / R307472 / UM1113 / E-7472 / D6 / 329-136U / M17412 / M17412UB / MM96-62401 / PL1015 / PL1015-HT	11523	278
Cab Mount	04-9009990 / 35-558PU / R307473 / UM1112 / E-7473 / D30 / 329-135U / M17414 / M17414UB / PL1016	11533	278
Cab Mount	66001-3403 / 35-1363PU / 35-564PU / R307462 / UM1196 / E-7462 / D36 / D5 / D51 / 329-147U / 329-177U / M17392UB / M17417 / M17417UB / PL1009 / PL1136	11705	278
Easy-Mount Torque Rod Bushing	35801-5015 / 20-833PU / R302226 / R307639 / C879 / C879UB / E-2226 / E-4664 / E-7639 / D423 / 321-132 / 321-132U / M2070 / 09-5723 / TRB6820 / TRB6820UB / TS38000	83520	280
Hood Latch	17-14781-000 / HLK2001	11109	278
Motor Mount	04-9009997 / 04-9009997 HARD / 12004-3402 / 12004-3402 SOFT / D324 / MM96-62870	12301	278
Motor Mount	12005-0002	12305	278
Motor Mount	12005-3403 / 50-1442PU / D17 / 329-191U / M17475UB / PL1111	18102	279
Radiator Bushing	656-215 / 50-1429PU / R307508 / UM1605 / E-7508 / D2 / 329-130U / M17484UB / PL1126 / PL1126-HT	12366	279
Radiator Mount	05-16070-000	11021	277
Shock Absorber Bushing	985211 / 40-340 / R307529 / HB593 / SB1UB / E-7529 / D1 / 320-153 / 320-153U / M695 / M-17526UB / MH1432 / MH1432UB / PL1026	18566	279
Shock Absorber Bushing	37302-3403 / E-7529 / D322 / 321-324U / PL1139	30545	280
Spring Bushing	16-17769-00 / 680-322-01-05 / 680-322-01-50 / RB211 / RB233 / RB-211 / RB-233 / SP46-52800	11066	277
Spring Bushing		11123	278
Spring Mount	58918-000 / 593461 / 58918-000	18994	280
Spring Pin Bushing	16-14603-000 / 16-17194-000 / 16-17770-000 / 16-18023-000 / RB263 / RB-263 / MR772 / MR772UB / SP46-11023	11094	277
Torque Rod Assy	35801-3441 / 945381 / TR59-41376	11080	277
Torque Rod Assy	35801-0033 / 924711 / R9247 / TR13-41022	13657	279
Torque Rod Bushing	35801-5015 / 20-833PU / R302226 / R307639 / C879 / C879UB / E-2226 / E-4664 / E-7639 / D423 / 321-132 / 321-132U / M2070 / 09-5723 / TRB6820 / TRB6820UB / TS38000	13520	279
Torque Rod Bushing	35801-5016 / 20-831PU / R302228 / E-2228 / D422 / M2072 / 09-5721 / TRB6112 / TT38000	13533	279
Torque Rod Bushing	35801-5015 / 20-833PU / R302226 / R307639 / C879UB / E-2226 / E-4664 / E-7639 / D423 / 321-132U / M2070 / 09-5723 / TRB6820UB	13536	279
Vibration Mount	67009-3442 / MS99-62620	18015	279

STEMCO GAFF replacement parts compatible with: HENDRICKSON®-AIRTEK® / WESTERN STAR® / FREIGHTLINER® / FORD® / STERLING®

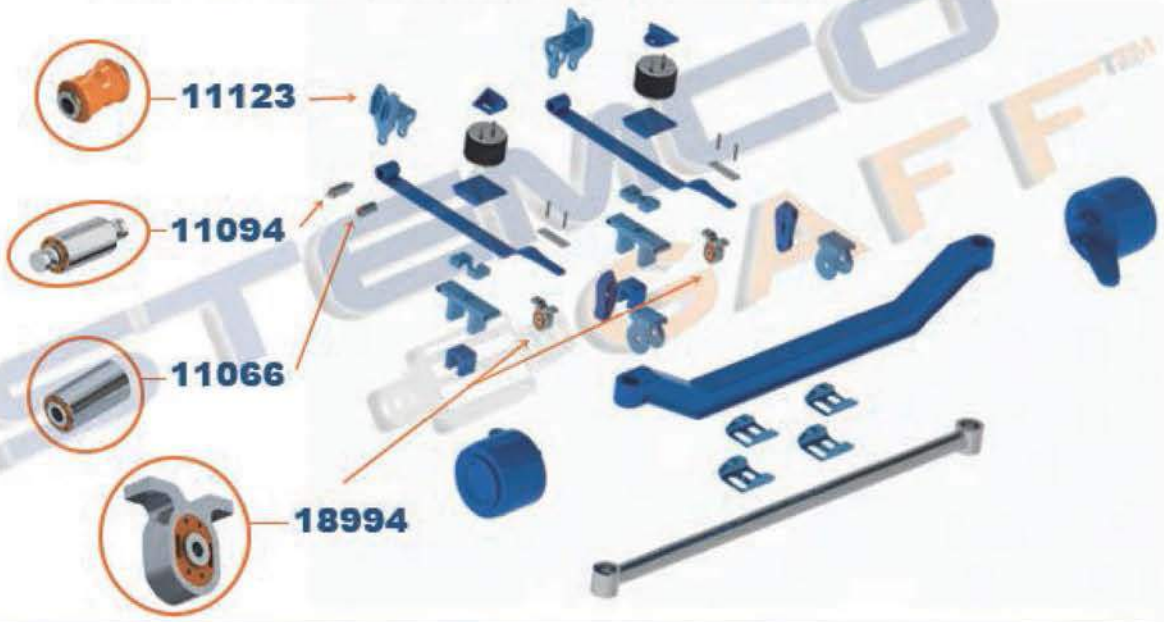

11021



Radiator Mount

OD	2 15/16"
ID	1 11/16"
LG	1 13/16"
HD	70A

OEM
05-16070-000

Notes: components not sold separately

11066



Spring Bushing

OD	2 1/4"
ID	1 13/16"
LG	4 1/4"
HD	80A

OEM
16-17769-00
680-322-01-05
680-322-01-50
RB211
RB233
RB-211
RB-233
SP46-52800

Notes:

11080



Torque Rod Assy

LG ²	8 1/16"
C-C	24
BC-C	4 3/8"
BH	5/8"
HD	80A

INCLUDES
QTY 1 11754
QTY 1 13520
QTY 1 13518

OEM
35801-3441
945381
TR59-41376

Notes:

11094



Spring Pin Bushing

OD	2 1/4"
OD<	1 1/4"
LG	6 7/8"
HD	80A

OEM
16-14603-000
16-17194-000
16-17770-000
16-18023-000
RB263
RB-263
MR772
MR772UB
SP46-11023

Notes:

Western Star continued

11109

LG
HD

3 13/16 ~
71D

OEM
17-14781-000
HLK2001



Hood Latch
Hook

Notes:

11123

OD
ID
LG
HD

2 ~
1 3/16 ~
3 1/4 ~
80A

OEM



Spring Bushing
Front

Notes: sleeveless bushing for leaf springs / bushing with sleeve is 11133 / compatible with AirTek leaf spring on FLD Columbia

11520

OD
OD<
ID
LG
HD

2 7/8 ~
1 7/8 ~
5/8 ~
1 5/16 ~
80A

OEM
04-9009996
12004-3401
35-548PU
R307472
UM1113
E-7472
D6
329-136U
M17412
M17412UB



Cab Mount
W / Metal Sleeve

Notes: metal sleeve / supersedes 11519 - standard / verify dimensions compare to 11523 or 11552

11523

OD
OD<
ID
LG
HD

2 7/8 ~
1 13/16 ~
5/8 ~
1 5/16 ~
80A

OEM
04-9009996
12004-3401
35-548PU
R307472
UM1113
E-7472
D6
329-136U
M17412
M17412UB



Cab Mount
W / Metal Sleeve

Notes: metal bushing stepped design / verify dimensions compare to 11523 or 11552 / compatible with Western Star using (2) 11523 with a 12301

11533

OD
OD<
ID
LG
HD

3 ~
1 13/16 ~
5/8 ~
1 15/16 ~
80A

OEM
04-9009990
35-558PU
R307473
UM1112
E-7473
D30
329-135U
M17414
M17414UB
PL1016



Cab Mount

Notes:

11705

OD
OD<
ID
LG
HD

3 ~
1 13/16 ~
5/8 ~
2 3/8 ~
80A

OEM
68001-3403
35-1363PU
35-564PU
R307462
UM1196
E-7462
D36
D5
D51
329-147U



Cab Mount

Notes: used in multiple applications

12301

THK
WD
C-C
HD

1 1/4 ~
3 ~
6 1/4 ~
80A

OEM
04-9009997
04-9009997 hard
12004-3402
12004-3402 soft
D324
MM96-62870



Motor Mount
Rear

Notes: compatible with Western Star uses (1) 12301 with (2) 11523

12305

OD
ID
HGT
HD

2 13/16 ~
5/8 ~
1 1/16 ~
80A

OEM
12005-0002



Motor Mount
Front (Upper)

Notes:

Western Star continued

12366



Radiator Bushing

OD	1 3/16"
OD<	1
ID	5/8"
LG	23/32"
HD	80A

OEM
656-215
50-1429PU
R307508
UM1605
E-7508
D2
329-130U
M17484UB
PL1126
PL1126-HT

Notes:

13520



Torque Rod Bushing

OD	2 3/4"
C-C	4 3/8"
BH	5/8"
HD	80A

INCLUDED IN:
Several Kits

OEM
35801-5015
20-833PU
R302226
R307639
C879
C879UB
E-2226
E-4664
E-7639
D423

TOOLS 18551, 18833

Notes: 83520 - easy mount / 13536 - no metal sleeve

13533



Torque Rod Bushing

OD	2 15/16"
LG	8 1/16"
THR	1 1/4" - 12 UNF
HD	80A

OEM
35801-5016
20-831PU
R302228
E-2228
D422
M2072
09-5721
TRB6112
TT38000

TOOL 18831

Notes: 13518 - metal sleeve

13536



Torque Rod Bushing

OD	2 15/16"
C-C	4 3/8"
BH	5/8"
HD	80A

OEM
35801-5015
20-833PU
R302226
R307639
C879UB
E-2226
E-4664
E-7639
D423
321-132U

TOOL 18831

Notes: 83520 - easy mount / 13520 - metal sleeve

13657



Torque Rod Assy

C-C	22"
-----	-----

INCLUDES

QTY 1	13629
QTY 1	13520
QTY 1	13518

OEM
35801-0033
924711
TMR9247
TR13-41022

Notes:

18015



Vibration Mount

OD	1 7/8"
OD<	1 5/16"
ID	1/2"
LG	2"
HD	70A

OEM
67009-3442
MS99-62620

Notes: components not sold separately

18102



Motor Mount Front

OD	3 5/8"
OD<	2 3/16"
ID	3/4"
LG	2 7/16"
HD	80A

OEM
12005-3403
50-1442PU
D17
329-191U
M17475UB
PL1111

Notes:

18566



Shock Absorber Bushing

OD	1 7/8"
ID	1"
LG	1"
HD	80A

OEM
985211
40-340
R307529
HB593
SB1UB
E-7529
D1
320-153
320-153U
M695

Notes:

Western Star continued

18994



Spring Mount
Rear

ID	13/16"	OEM
WD	2	58918-000
C-C	5	593461
HD	80A	58918-000

INCLUDED IN:
13725

Notes:

30545



Shock Absorber Bushing

OD	1 15/16"	OEM
ID	15/16"	37302-3403
LG	1 1/8"	E-7529
HD	80A	D322
		321-324U
		PL1139

Notes:

83520



Easy-Mount
Torque Rod Bushing

OD	2 3/4"	OEM
C-C	4 3/8"	35801-5015
BH	5/8"	20-833PU
HD	80A	R302226
		R307639
		C879
		C879UB
		E-2226
		E-4664
		E-7639
		D423

TOOLS 18551, 18833

Notes: standard - 13520 / no metal sleeve - 13536

DISCLAIMER NOTICE:

The use of a manufacturer's name, product number and part description in this catalog is intended to assist our customers in identifying replacement parts. Names referenced in this catalog may be trademarks or trade names of their respective manufacturers or suppliers and are not intended to show affiliation between STEMCO® and the owners of those names.

Every effort has been made to insure the accuracy of the information shown in this catalog. However, STEMCO® assumes no liability for any errors or omissions in the information provided.

Airglide, Air Leaf, and Low Air Leaf are registered trademarks of Paccar Inc. Airtek, Primaax, Firemaax, Intraax, Haulmaax, and HN are registered trademarks of Hendrickson USA, LLC. Arvin Meritor is a registered trademark of Meritor Technology, Inc. Autocar and Xpeditor and the Autocar logo are registered trademarks of Autocar, LLC. Chalmers is a trademark of Chalmers Suspensions International Inc. Chevrolet and GMC are registered trademarks of General Motors LLC. Dana is a registered trademark of Dana Limited Fontaine is a registered trademark of Marmion Highway Technologies LLC. Ford is a registered trademark of Ford Motor Company. Freightliner, Sterling, and Western Star are registered trademarks of Daimler Trucks North America LLC. Fruehauf is a trademark of Aurora Trailer Holding LLC. GAFF is a registered trademark of GAFF INTERNATIONAL, S.A. DE C.V. Hendrickson is a registered trademark of The Boler Company. Hino is a registered trademark of HINO MOTORS SALES U.S.A., INC. a Toyota group company. Hutchens is a trademark of Hutchens Industries Inc. International is a registered trademark of International Truck Intellectual Property Company, LLC. Isuzu is a registered trademark of Isuzu Commercial Truck of America, Inc. Jost is a registered trademark of JOST-WERKE GMBH. Kenworth is a registered trademark of Paccar Inc. Mack is a registered trademark of Mack Trucks, Inc. MAN is a registered trademark of MAN Automotive Imports. Mercedes-Benz is a copyrite of Mercedes-Benz USA, LLC. Mitsubishi is a registered trademark of the Mitsubishi company. Neoplan is a copyrite of MAN Truck & Bus Neway and Holland are registered trademarks of Saf-Holland, Inc. Nissan is a registered trademark of the Nissan Motor Co., Ltd. Peterbilt is a registered trademark of Paccar Inc. Reyco and Granning are registered trademarks of Reyco Granning, LLC. Ridewell is a registered trademark of Ridewell Corporation. Scania is a registered trademark of Scania CV AB. Simplex is a registered trademark of The Holland Group, Inc. Sterling Truck is a registered trademark of Daimler Trucks North America LLC. Trailmobile is a registered trademark of Manac Inc, LLC. Volkswagen is a registered trademark of VOLKSWAGEN AG. Volvo is a registered trademark of Volvo Trademark Holding AG. Watson & Chalin is a trademark of Watson & Chalin Manufacturing, Inc.

APPLICATION Summaries

Brakes

DESCRIPTION	OEM	PART ID	PAGE
Camshaft Bushing	27-1191 / 16064 / 67358 / 382517 / KC8011 / 466670	17500	281
Camshaft Bushing	1225-L-1208 / 281233 / 838961 / B1581 / E-5512 / B8QH2237A / 515147 / 15664483 / C65329 / 1691529C2 / L-166 / 80AX641 / B8600A / 405126 / 02-210	17501	281
Camshaft Bushing	271198 / 32157 / 381571 / AXA-0429-900 / C65380 / L-898 / B8623 / E-1571	17502	282
Camshaft Bushing	11019 / 281233 / M10WJ178 / B2021 / E-661 / 65329 / 405109	17503	282
Camshaft Bushing	1225-B-834 / 28-1241 / 02-242 / 32154 / L-1296	17504	282
Camshaft Bushing	700734 / AXA-0413-900 / L-896 / 700762 / E-1567	17505	282
Camshaft Bushing	1225-R-1058 / 27-1197 / 32161 / E-2361 / 714923 / C66646 / L-1730	17529	283
Camshaft Bushing	1225-N-378 / 11008 / 820183 / 1000035 / B-2021 / 7-6-17 / L-166 / 405126 / E-536	17538	284
Camshaft Bushing	M10WJ107 / M10WJ237X / E-2102 / E-9792A / L-3146 / NL1138 / 405128	17539	284
Camshaft Bushing	A 1225-V-438 / 28-1236 / ACA-3266 / L-752 / 15109	17574	284
Camshaft Bushing	700768 / ACD-2285-900 / L-1191 / E-1577A	17668	284
Camshaft Bushing	M16HD106 / 1008412	17678	285
Camshaft Bushing	28-1238 / 1002248 / 1008412 / R617005	17682	285
Camshaft Bushing	1225-X-804 / 281260 / E-2551 / 714906 / C67018 / L-1641	18439	285
Camshaft Bushing	1225-R-1058 / 27-1197 / E-2361	18991	285
Camshaft Bushing	E-11449 / 02-257 / B-806	18992	285
Coupling	FP99-69426 / 162426 / 162426 / 867499R1	17506	282
Coupling		17507	282
Coupling		17508	282
Coupling		17509	282
Coupling		17510	283
Coupling		17511	283
Coupling		17518	283
Coupling		17519	283
Coupling		17520	283
Coupling		17530	283
Coupling		17531	283
Coupling		17541	284
Coupling		17677	285
Coupling		31515	285
Glad Hand Seal	248579 / E-6858B / D74B / 329-125U / M37378 / GT-2602 / DA9017B / 12-0161 / A80BL2000 / 035010 / 441738 / 16013 / 10017B / 101115B / 36011	17674	284
Glad Hand Seal	248579 / E-6858R / D74R / 329-126U / M37377 / GT-2601 / DA9017R / 12-0162 / A80BL2001 / 035009 / 441737 / 16015 / 10017R / 101115R / 36012	17675	284
Glad Hand Seal	441739 / M314 / GT-2608 / 10029 / 12-0163 / 12-0163 / 441739 / 16012 / 101114 / 101118 / 36010	17676	285
Glad Hand Seal Kit	248579 / D74B / D74R / L-1082	17534	284

17500



Camshaft Bushing

OD 2 7/16"

ID 1 1/2"

LG 1 1/2"

HD 7/16"

OEM

27-1191
16064
67358
382517
KC8011
466670

Notes:

17501



Camshaft Bushing

OD 1 7/8"

ID 1 1/2"

LG 1 3/16"

HD 7/16"

OEM

1225-L-1208
281233
838961
B1581
E-5512
B8QH2237A
515147
15664483
C65329
1691529C2

Notes:

Brakes continued

17502



Camshaft Bushing

OD	2 7/8"
OD<	2 1/16"
ID	1 5/8"
LG	2 7/16"
HD	71D

OEM
271198
32157
381571
AXA-0429-900
C65380
L-898
B8623
E-1571

Notes:

17503



Camshaft Bushing

OD	2
ID	1 1/2"
LG	2
HD	71D

OEM
11019
281233
M10WJ178
B2021
E-661
65329
405109

Notes:

17504



Camshaft Bushing

OD	1 7/8"
ID	1 5/8"
LG	1 1/8"
HD	71D

OEM
1225-B-834
28-1241
02-242
32154
L-1296

Notes:

17505



Camshaft Bushing

OD	2 3/16"
ID	1 5/8"
LG	7/8"
HD	71D

OEM
700734
AXA-0413-900
L-896
700762
E-1567

Notes:

17506



Coupling

OD	2 1/16"
ID	3/4"
THK	7/16"
HD	90A

OEM
FP99-69426
162426
162426
867499R1

Notes: for fuel pump

17507



Coupling

OD	3 1/2"
ID	1 3/16"
THK	1 3/8"
HD	80A

OEM

Notes:

17508



Coupling

WD	13/16"
HGT	1 1/4"
HD	80A

OEM

Notes: components not sold separately

17509



Coupling

OD	3 5/16"
ID	1 1/4"
THK	15/16"
HD	80A

OEM

Notes:

Brakes continued

17510



Coupling

OD	2 15/16"	OEM
ID	1 1/16"	
THK	11/16"	
HD	80A	

Notes:

17511



Coupling

OD	2 7/8"	OEM
ID	1 1/16"	
THK	11/16"	
HD	80A	

Notes:

17518



Coupling

OD	3 1/4"	OEM
ID	1 5/16"	
THK	7/8"	
HD	80A	

Notes:

17519



Coupling

OD	3 7/16"	OEM
ID	1 1/4"	
THK	7/8"	
HD	80A	

Notes:

17520



Coupling

OD	3 3/8"	OEM
ID	1 5/16"	
THK	1 5/16"	
HD	80A	

Notes:

17529



Camshaft Bushing

OD	2 1/2"	OEM
ID	1 1/2"	
LG	1 3/4"	
HD	71D	

Notes:

1225-R-1058
27-1197
32161
E-2361
714923
C66646
L-1730

17530



Coupling

OD	3 3/8"	OEM
ID	1 5/16"	
THK	1 3/8"	
HD	80A	

Notes:

17531



Coupling

OD	3 1/2"	OEM
ID	1 1/4"	
THK	1 1/2"	
HD	80A	

Notes:

Brakes continued

17534



Glad Hand Seal Kit
Blue & Red

OD	1 5/8"
ID	5/8"
THK	3/8"
HD	65A

INCLUDES

QTY 1	17674
QTY 1	17675

OEM

248579
D74B
D74R
L-1082

Notes: fits most applications

17538



Camshaft Bushing

OD	1 7/8"
ID	1 1/2"
LG	1 1/2"
HD	71D

OEM

1225-N-378
11008
820183
1000035
B-2021
7-6-17
L-166
405126
E-536

Notes:

17539



Camshaft Bushing

OD	2 1/2"
ID	1 1/2"
LG	1 3/4"
HD	71D

OEM

M10WJ107
M10WJ237X
E-2102
E-9792A
L-3146
NL1138
405128

Notes:

17541



Coupling

THK	3/4"
WD	7/8"
HGT	13/16"
HD	80A

OEM

Notes: components not sold separately

17574



Camshaft Bushing

OD	2 3/16"
ID	1 1/2"
LG	7/8"
HD	71D

OEM

A 1225-V-438
28-1236
ACA-3266
L-752
15109

Notes:

17668



Camshaft Bushing

OD	2 7/16"
ID	1 5/8"
LG	1 1/2"
HD	71D

OEM

700768
ACD-2285-900
L-1191
E-1577A

Notes:

17674



Glad Hand Seal
Blue

OD	1 5/8"
ID	5/8"
THK	3/8"
HD	65A

INCLUDED IN:

17534

OEM

248579
E-6858B
D74B
329-125U
M37378
GT-2602
DA9017B
12-0162
A80BL2000
035010

Notes: fits most applications

17675



Glad Hand Seal
Red

OD	1 5/8"
ID	5/8"
THK	3/8"
HD	65A

INCLUDED IN:

17534

OEM

248579
E-6858R
D74R
329-126U
M37377
GT-2601
DA9017R
12-0162
A80BL2001
035009

Notes: fits most applications

Brakes continued

17676



**Glad Hand Seal
Black**

OD	1 5/8"
ID	5/8"
THK	3/8"
HD	65A

OEM
441739
M314
GT-2608
10029
12-0163
12-0163
441739
16012
101114
101118

Notes: fits most applications

17677



Coupling

OD	2 7/8"
ID	7/8"
THK	3/4"
HD	80A

OEM

Notes:

17678



Camshaft Bushing

OD	2"
ID	1 5/8"
LG	2"
HD	71D

OEM
M16HD106
1008412

Notes:

17682



Camshaft Bushing

OD	2"
ID	1 5/8"
LG	1 5/16"
HD	71D

OEM
28-1238
1002248
1008412
R617005

Notes:

18439



Camshaft Bushing

OD	1 7/8"
ID	1 1/2"
LG	1 11/16"
HD	71D

OEM
1225-X-804
281260
E-2551
714906
C67018
L-1641

Notes:

18991



Camshaft Bushing

OD	2"
ID	1 1/2"
LG	1"
HD	71D

OEM
1225-R-1058
27-1197
E-2361

Notes:

18992



Camshaft Bushing

OD	2"
ID	1 1/2"
LG	1 1/2"
HD	71D

OEM
E-11449
02-257
B-806

Notes:

31515



Coupling

OD	3 1/16"
ID	1"
THK	11/16"
HD	97A

OEM

Notes:

Bumpers

DESCRIPTION	OEM	PART ID	PAGE
Shock Absorber Bumper	various applications / verify dimensions	18316	286
Trailer & Dock Bumper	various applications / verify dimensions	18009	286
Trailer & Dock Bumper	various applications / verify dimensions	18076	286
Trailer & Dock Bumper	various applications / verify dimensions	18529	286
Trailer & Dock Bumper	various applications / verify dimensions	18550	286
Trailer & Dock Bumper	various applications / verify dimensions	18559	286
Trailer & Dock Bumper	various applications / verify dimensions	18560	287
Trailer & Dock Bumper	various applications / verify dimensions	18848	287
Trailer & Dock Bumper	MS99-65045 / 602035 / various applications / verify dimensions	18905	287
Trailer & Dock Bumper	various applications / verify dimensions	50064	287

18009



THK 3 5/16"
WD 4 1/8"
LG 5 7/8"
BC-C 2 3/8"
BH 9/16"
HD 80A

OEM

Trailer & Dock Bumper

Notes:

18076



THK 3 5/16"
WD 4 1/8"
LG 5 7/8"
BH 9/16"
HD 80A

OEM

Trailer & Dock Bumper
Black

Notes:

18316



OD 2 7/16"
LG 3 15/16"
THR 10 mm - P1.5
HD 65A

OEM

Shock Absorber Bumper

Notes:

18529



THK 4 1/2"
WD 3"
LG 6"
BC-C 2 3/4"
BH 19/32"
HD 80A

OEM

Trailer & Dock
Bumper

Notes:

18550



THK 3 1/2"
WD 3"
LG 6 1/4"
C-C 3 1/2"
BH 5/8"
HD 80A

OEM

Trailer & Dock Bumper
Black

Notes:

18559



OD 1 1/2"
ID 7/16"
LG 3/4"
HD 80A

OEM

Trailer & Dock Bumper

Notes:

Bumpers continued

18560



Trailer & Dock Bumper
Black

Notes:

THK	3 1/4	~
WD	2 3/4	~
LG	6	~
C-C	2 5/8	~
BH	3 9/16	~
HD	80A	~

OEM

18848



Trailer & Dock Bumper

Notes: also available in black 18905

THK	3 5/8	~
WD	5 5/8	~
LG	7 5/8	~
C-C	5 7/16	~
BC-C	3 1/8	~
BH	1/2	~
HD	80A	~

OEM

18905



Trailer & Dock Bumper
Black

Notes: also available in orange 18848

THK	3 5/8	~
WD	5 5/8	~
LG	7 5/8	~
C-C	5 7/16	~
BC-C	3 1/8	~
BH	1/2	~
HD	80A	~

OEM
MS99-65045
602035

50064



Trailer & Dock Bumper

Notes:

WD	3 5/8	~
LG	6 3/16	~
C-C	3 1/2	~
BH	9/16	~
HGT	9 9/16	~
HD	80A	~

OEM

Fifth Wheel & Hinge Bushings

DESCRIPTION	OEM	PART ID	PAGE
Fifth Wheel Bushing	R307445 / E-7445 / D203 / 329-157U / KP109 / KP109UB / PL1002 / BSH-150 / A80BL1064	10002	293
Fifth Wheel Bushing	FON BSH 109 L / 3065-BSH109L / 3065-BSH172U / FON BSH 172U L / FNTBSH109L / FNTBSH172U / FW99-32109 / FW99-32172 / BSH-109-L / BSH-172-U / BSH-LWS-L	10079	293
Fifth Wheel Bushing	PL1130 / ASF-0329-47	10080	293
Fifth Wheel Bushing	K066-160 / R307451 / E-7451 / D89 / 329-123U / 329-124U / KP119 / KP119UB / PL1037 / 90.4003 / XB-1604-5 / A80BL1604-5	11515	293
Fifth Wheel Bushing	R307450 / E-7450 / D90 / 329-104U / KP101 / KP101UB / PL1006 / 90.4004 / XB-0011-2	11517	293
Fifth Wheel Bushing	PL1032 / XB-0012-3	11724	293
Fifth Wheel Bushing	KP105 / RK-03809 / XB-0011-1	18094	293
Fifth Wheel Bushing	HLD XB 0011 / SAFXB0011 / XB0011 / 3889-XB0011 / HHXB-0011 / HOHXB0011 / FW51-32011 / XB-0011	18215	294
Fifth Wheel Bushing	HLD XB 0009 / SAFXB0009 / 3889-XB0009 / HOHXB0009 / KP116 / XB-0009	18221	294
Fifth Wheel Bushing	HLD-XB10605 / SAFXB10605 / 3889-XB10605 / HLD-XB10605 / HOHXB10605 / FW99-32605 / XB-10605	40035	295

Fifth Wheel & Hinge Bushings continued

DESCRIPTION	OEM	PART ID	PAGE
Fifth Wheel Bushing	4100328 / ATP-0328-03	40056	295
Fifth Wheel Bushing		40140	295
Fifth Wheel Bushing		40141	295
Fifth Wheel Mount	PL1144 / 4100358 / ASF-0358-07	10001	293
Fifth Wheel Mount		18351	294
Fifth Wheel Mount	KP127 / SK210525	18708	295
Fifth Wheel Mount	KP126 / SK1259	18709	295
Hinge Bushing	R307517 / E-7517 / 320-164U / PL1021 / 348 / 348A / A80BL3023	18574	294
Hinge Bushing	R307516 / E-7516 / 320-161U / PL1020 / 448 / 448A / A80BL3022	18575	294
Hinge Bushing	R307645 / E-7645 / 320-155 / 320-155U / PL1080 / P205 / P205A	18851	295
Hinge Bushing Kit	536	18333	294
Hinge Bushing Kit	37.3005R / R307518 / E-7518 / D250 / 320-165U / PL1079 / 437 / 437A / A80BL3026	18558	294
Hinge Bushing Kit		18686	294

STEMCO GAFF replacement parts compatible with: FONTAINE® CD 700/ 600 SERIES



Fifth Wheel & Hinge Bushings continued

STEMCO GAFF replacement parts compatible with:
FONTAINE® H-5092 / X-5092 SERIES

This diagram illustrates the replacement parts for the Fontaine H-5092 / X-5092 series. It features two views of a blue fifth wheel component. The top view shows the front of the wheel with a callout '10002' pointing to a bushing on the front axle. The bottom view shows the rear of the wheel with callouts '10002' pointing to bushings on the rear axles. A circular inset labeled '40141 (kit)' shows a set of four bushings and four bolts. A large, semi-transparent watermark 'STEMCO GAFF' is visible in the background.

STEMCO GAFF replacement parts compatible with:
FONTAINE® TPL3000 SERIES

This diagram illustrates the replacement parts for the Fontaine TPL3000 series. It features a top-down view of a blue fifth wheel component. Callouts '10002' point to bushings on the front and rear axles. A circular inset labeled '40141 (kit)' shows a set of four bushings and four bolts. A large, semi-transparent watermark 'STEMCO GAFF' is visible in the background.

Fifth Wheel & Hinge Bushings continued

STEMCO GAFF replacement parts compatible with: FONTAINE® TPL6000/ 7000/ 7000CC SERIES

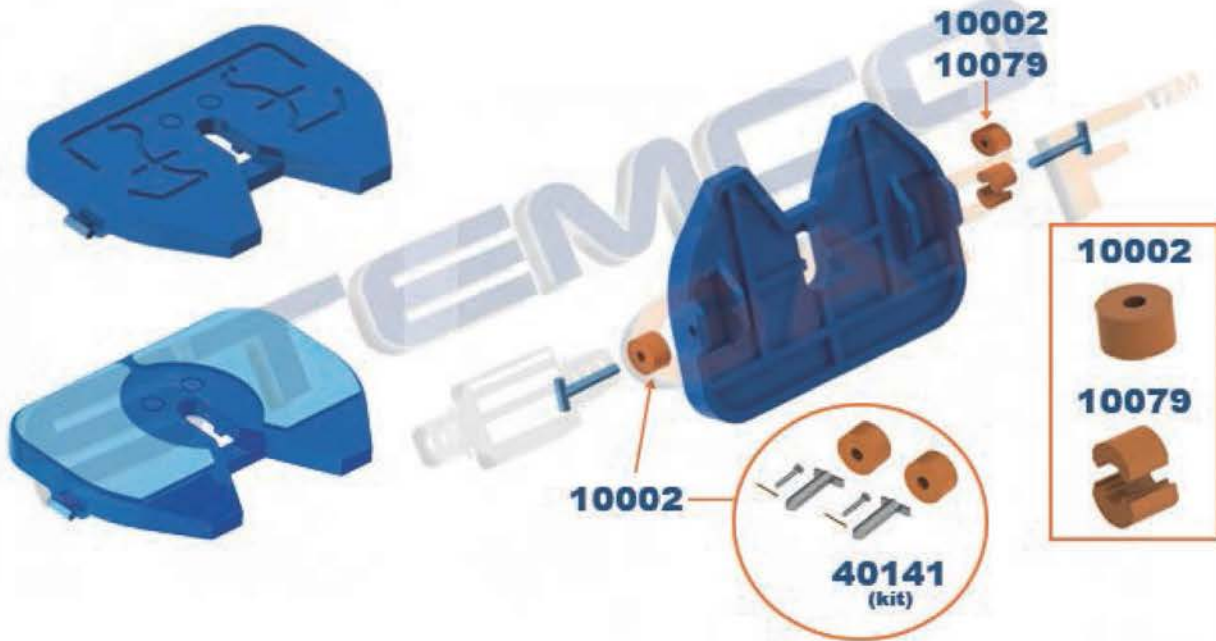

STEMCO GAFF replacement parts compatible with: HOLLAND® FIFTH WHEELS FW17EK & FW3510

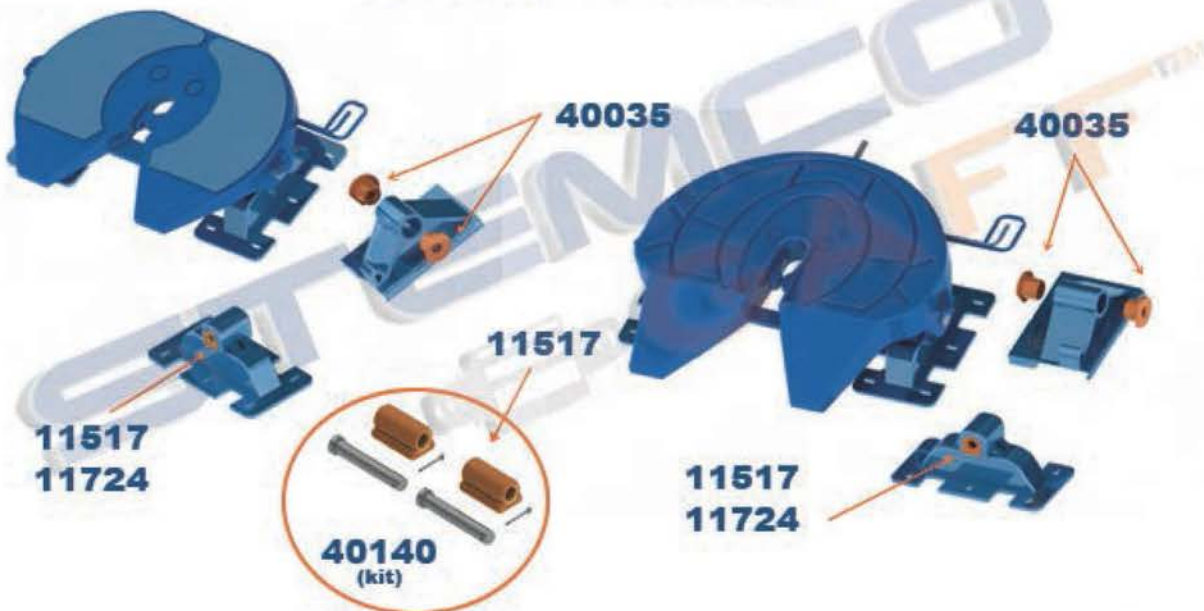

Fifth Wheel & Hinge Bushings continued

STEMCO GAFF replacement parts compatible with:
HOLLAND® FIFTH WHEELS
FW3500 & FW3100

This diagram illustrates the replacement parts for the fifth wheel and hinge bushings of Holland FW3500 and FW3100 models. It features a large blue fifth wheel assembly at the top left and a smaller blue hinge assembly at the bottom right. A circular inset in the upper right shows a kit of four bushings and two pins, labeled '40140 (kit)'. A callout line from the hinge assembly points to a specific bushing labeled '11517'. Another callout line from the fifth wheel assembly points to a bushing labeled '11517' and a pin labeled '11724'. A large, faint watermark 'STEMCO GAFF' is visible in the background.

11517
11724

40140
(kit)

11517

STEMCO GAFF replacement parts compatible with:
HOLLAND FIFTH WHEELS

This diagram illustrates the replacement parts for the fifth wheel and hinge bushings of Holland Fifth Wheels models. It features a large blue fifth wheel assembly at the top and a smaller blue hinge assembly at the bottom. A callout line from the hinge assembly points to a bushing labeled '18215'. Another callout line from the hinge assembly points to a spring labeled '18221'. A third callout line from the hinge assembly points to another bushing labeled '18215'. A large, faint watermark 'STEMCO GAFF' is visible in the background.

18215

18221

18215

Fifth Wheel & Hinge Bushings continued

STEMCO GAFF replacement parts compatible with: HOLLAND® FW070 SERIES



11517

40140
(kit)

11515



11517



11724



18094



STEMCO GAFF replacement parts compatible with: SIMPLEX®, SIMPLEX IIR® & SIMPLEX LITE®

10080



40056

Fifth Wheel & Hinge Bushings continued

10001



Fifth Wheel Mount

THK	5/8"
WD	3 5/8"
LG	10 1/4"
HD	80A

OEM
PL1144
4100358
ASF-0358-07

Notes:

10002



Fifth Wheel Bushing

OD	4"
ID	1 1/4"
LG	2 1/4"
HD	80A

OEM
R307445
E-7445
D203
329-157U
KP109
KP109UB
PL1002
BSH-150
A80BL1064

Notes: included in 40141

10079



Fifth Wheel Bushing

OD	3 3/16"
ID	1 1/4"
LG	2 11/16"
LG2	2 5/16"
HD	80A

OEM
FON BSH 109 L
3065-BSH109L
3065-BSH172U
FON BSH 109 L
FON BSH 172U L
FNTBSH109L
FNTBSH172U
FW99-32109
FW99-32172
BSH-109-L

Notes: components not sold separately

10080



Fifth Wheel Bushing Pad

THK	5/16"
WD	3 5/8"
LG	10"
HD	80A

OEM
PL1130
ASF-0329-47

Notes:

11515



Fifth Wheel Bushing

OD	2 13/16"
ID	1 1/16"
LG	4 1/8"
HD	80A

OEM
K066-160
R307451
E-7451
D89
329-123U
329-124U
KP119
KP119UB
PL1037
90.4003

Notes: supersedes 11516

11517



Fifth Wheel Bushing

ID	1 1/8"
THK	2 5/16"
WD	2 9/16"
LG	4 3/16"
HD	80A - 71D

OEM
R307450
E-7450
D90
329-104U
KP101
KP101UB
PL1006
90.4004
XB-0011-2
A80BL0011

Notes: very popular bushing / hard ID sleeve for ease of install / included in 40140

11724



Fifth Wheel Bushing

ID	1 1/2"
THK	2 5/16"
WD	2 9/16"
LG	4 3/16"
HD	80A

OEM
PL1032
XB-0012-3

Notes:

18094



Fifth Wheel Bushing

OD	2 1/8"
ID	1 1/8"
LG	4 3/8"
HD	80A

OEM
KP105
RK-03809
XB-0011-1

Notes: grooved compatible with Smplex / verify dimensions compare to 18215

Fifth Wheel & Hinge Bushings continued

18215



Fifth Wheel Bushing

OD	2	--
ID	1 1/8	--
LG	4 1/4	--
HD	80A	

OEM
HLD XB 0011
SAFXB0011
XB0011
3889-XB0011
HHXB-0011
HOHXB0011
FW51-32011
XB-0011

Notes: no groove / verify dimensions compare to 18094

18221



Fifth Wheel Bushing

OD	3 1/2	--
ID	1 1/4	--
LG	3 3/4	--
HD	80-71A	

OEM
HLD XB 0009
SAFXB0009
3889-XB0009
HOHXB0009
KP116
XB-0009

Notes:

18333



Hinge Bushing Kit

OD	5	--
ID	2	--
LG	9 3/8	--
HD	80A	

OEM
536

Notes:

18351



Fifth Wheel Mount

THK	1 13/16	--
WD	2 9/16	--
LG	9 11/16	--
HD	80A	

OEM

Notes:

18558



Hinge Bushing Kit

OD	4 1/4	--
ID	2	--
LG	4 1/2	--
HD	80A	

INCLUDES
QTY 1 Flat Washer
1/2" x 4 7/16" - 2"

OEM
37.3005R
R307518
E-7518
D250
320-165U
PL1079
437
437A
A80BL3026

Notes: Notes: components not sold separately

18574



Hinge Bushing Kit

OD	3 1/2	--
ID	2	--
LG	3 1/2	--
HD	80A	

OEM
R307517
E-7517
320-164U
PL1021
348
348A
A80BL3023

Notes:

18575



Hinge Bushing Kit

OD	3 9/16	--
ID	2 1/16	--
LG	1 3/4	--
HD	80A	

OEM
R307516
E-7516
320-161U
PL1020
448
448A
A80BL3022

Notes:

18686



Hinge Bushing kit

OD	2 15/16	--
ID	1 3/16	--
LG	3 7/8	--
HD	71D	

OEM

Notes: components not sold separately

Fifth Wheel & Hinge Bushings continued

18708

THK	5/8"	~
WD	4 1/2"	~
LG	4 1/8"	~
HD	80A	



Fifth Wheel Mount

OEM
KP127
SK210525

Notes:

18709

THK	2 7/8"	~
WD	6 3/8"	~
LG	7 1/32"	~
HD	80A	



Fifth Wheel Mount

OEM
KP126
SK1259

Notes:

18851

OD	4 3/4"	~
ID	2"	~
LG	5 1/4"	~
HD	80A	



Hinge Bushing

OEM
R307645
E-7645
320-155
320-155U
PL1080
P205
P205A

Notes:

40035

OD	3 7/8"	~
OD<	2 5/16"	~
ID	1 5/32"	~
LG	2 1/16"	~
HD	80A	



Fifth Wheel Bushing Kit

OEM
HLD-XB10605
SAFXB10605
3889-XB10605
HLD-XB10605
HOHXB10605
FW99-32605
XB-10605

Notes: components not sold separately

40056

ID	4 1/2"	~
THK	27/32"	~
LG	3 15/16"	~
HD	71D	



Fifth Wheel Bushing

OEM
4100328
ATP-0328-03

Notes:

40140

INCLUDES		OEM
QTY 2	11517	
QTY 2	Pin	
QTY 2	Cotter Pin	



Fifth Wheel Bushing Kit

Notes: all components not sold separately

40141

INCLUDES		OEM
QTY 2	10002	
QTY 2	Pin	
QTY 2	Lock Pin	
QTY 2	Cotter Pin	



Fifth Wheel Bushing Kit

Notes: all components not sold separately

Hood Latches

DESCRIPTION	OEM	PART ID	PAGE
Hood Latch		10024	298
Hood Latch		10510	298
Hood Latch	17-12434-000	11096	298
Hood Latch	8574FL	11097	299
Hood Latch	17-12434-000	11102	299
Hood Latch	680-880-01-60 / 680-880-01-60 / 37-41-295-60	11103	299
Hood Latch	HLK1011 / 17-12435-000	11104	299
Hood Latch	HLK1020 / 17-15553-001	11106	299
Hood Latch	HLK1019 / 17-15553-000	11107	299
Hood Latch	17-14781-000 / 17QM263A / HLK2001	11109	299
Hood Latch	HLK1000 / 315-5402 / K147-107 / K147C106 / K147-107	11543	300
Hood Latch	HLK1015 / 374-1295-60 / 379-9344	11768	300
Hood Latch	315-5401 / 680-880-01-60 / 680-880-01-60 / L56-0001 / 63011001 / 23-13857 / L56-0001	12365	300
Hood Latch Assy	HLN1002 / 315-5101 / 16899930C91 / 1699929C9 / 499523C3	10506	298
Hood Latch Assy	HLK1024 / 17-12438-000 / 680-880-01-60	11134	300

STEMCO GAFF replacement parts compatible with:
FREIGHTLINER® CENTURY CLASS

11107 (assy) Right

11102

11102

11106 (assy) Left

11124

11145

Hood Latches continued

STEMCO GAFF replacement parts compatible with: FREIGHTLINER® FL-120

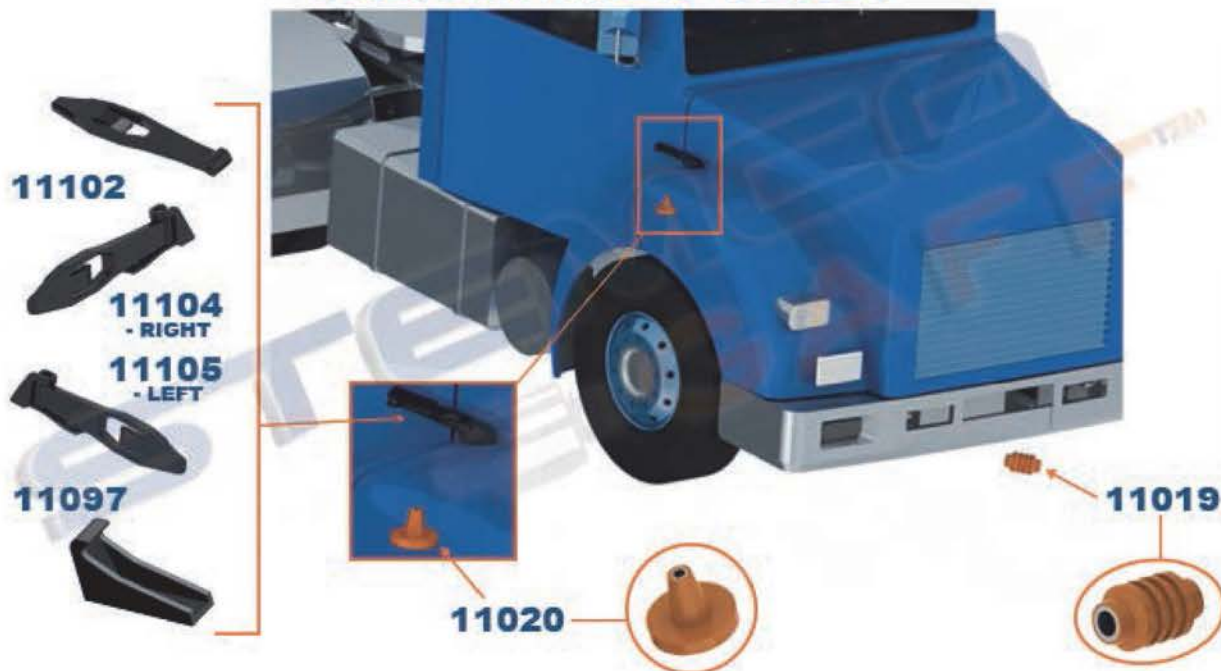

STEMCO GAFF replacement parts compatible with: FREIGHTLINER® HOOD



Hood Latches continued

STEMCO GAFF replacement parts compatible with: FREIGHTLINER® M2 112

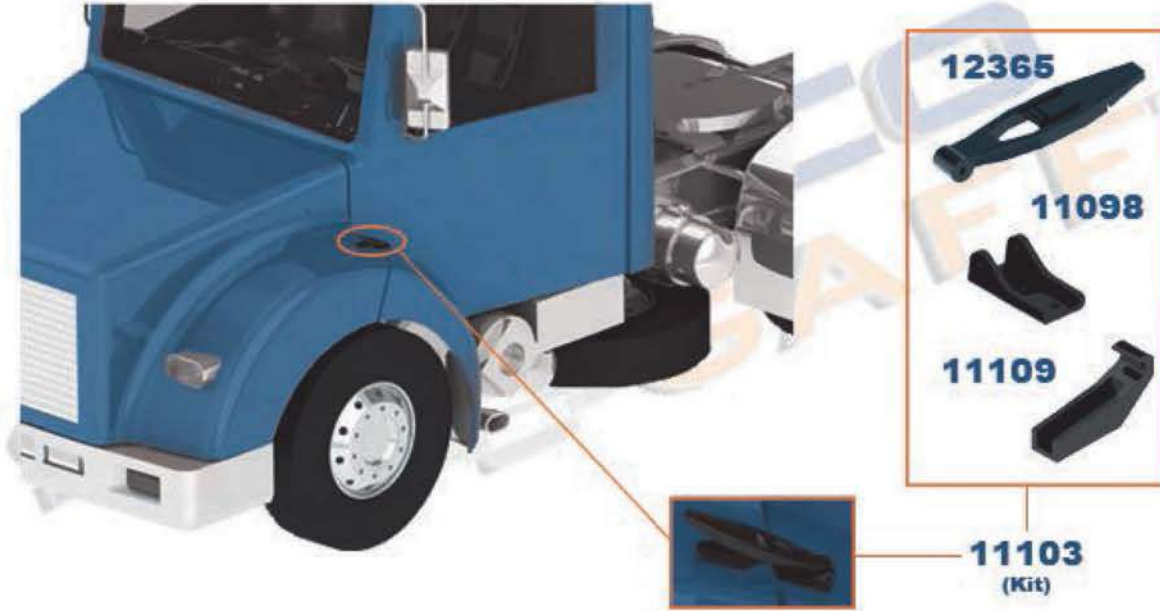

10024

LD
HD

5 7/8
70A

OEM



Hood Latch

Notes: universal hood latch / fits several old trucks battery box covers etc.

10506

LG
HD

8
80A - 97A

OEM

HLN1002
315-5101
16899930C91
1699929C9
499523C3



Hood Latch Assy

Notes: all components not sold separately

10510

LG
HD

8
80A

OEM



Hood Latch

Notes: latch for 10506

11096

LG
HD

5
71D

OEM



Hood Latch
Hook

Notes: for complete repair use with 11102 / component not offered by OE

Hood Latches continued

11097 LG 3 1/2" ~
HD 71D **OEM**
8574FL



Hood Latch Hook

Notes:

11102 LG 10" ~
HD 70A **OEM**
17-12434-000



Hood Latch

Notes: for complete repair use with 11096 / component not offered by OE

11103 LG 8 9/16" ~
HD 70A **OEM**
680-880-01-60
680-880-01-60
37-41-295-60

INCLUDES
QTY 1 11098



Hood Latch W / Mount

Notes: bracket not sold separately

11104 LG 11 1/4" ~
HD 70A **OEM**
HLK1011
17-12435-000



Hood Latch W / Mount Left

Notes: bracket not sold separately

11105 LG 11 1/4" ~
HD 70A **OEM**
HLK1020
17-15553-001



Hood Latch W / Mount Right

Notes: bracket not sold separately

11106 LG 11 4/4" ~
HD 70A **OEM**
HLK1020
17-15553-001



Hood Latch W / Mount Right

Notes: bracket not sold separately

11107 LG 11 1/4" ~
HD 70A **OEM**
HLK1019
17-15553-000



Hood Latch W / Mount Left

Notes: bracket not sold separately

11109 LG 3 13/16" ~
HD 71D **OEM**
17-14781-000
17QM263A
HLK2001



Hood Latch Hook

Notes:

Hood Latches continued

11134 LG 8 11/16" ~
LG² 4 3/16" ~
HD 70A-97A



Hood Latch Assy

OEM
HLK1024
17-12438-000
680-880-01-60

Notes: bracket not sold separately

11543 LG 8 9/16" ~
HD 70A - 97A ~



Hood Latch

OEM
HLK1000
315-5402
K147-107
K147C106
K147-107

Notes:

11768 LG 10 3/4" ~
HD 70A - 71D



Hood Latch

OEM
HLK1015
374-1295-60
379-9344

Notes:

12365 LG 8 11/16" ~
HD 70A



Hood Latch

OEM
315-5401
680-880-01-60
680-880-01-60
L56-0001
63011001
23-13857
L56-0001

Notes:

Reefer Units

DESCRIPTION	OEM	PART ID	PAGE
Snubber Mount	20-91-4043 / 91-4043 / 91-4195	50055	301
Vibration Mount	MS99-39159 / 20-91-4159 / 91-2618 / 91-4159	12380	300
Vibration Mount		18013	300
Vibration Mount		18014	301
Vibration Mount	LOR CB2202-12 / 67009-3442 / MS99-62620 / CB2202-12 / 92-7620 / 92-8893	18015	301
Vibration Mount	20-99-1433 / 99-1433	50053	301
Vibration Mount	MS-62620 / 73-01600-02	50054	301
Vibration Mount	MS99-39709 / 20-91-7709 / 91-1404 / 91-2578 / 91-7709	50056	301

12380 OD 2 5/16" ~
OD< 1 13/16" ~
ID 11/16" ~
LG 1 13/32" ~
HD 60A



Vibration Mount

OEM
MS99-39159
20-91-4159
91-2618
91-4159

Notes:

18013 OD 3" ~
OD< 1 13/16" ~
ID 15/16" ~
LG 1 5/16" ~
HD 70A



Vibration Mount

OEM

Notes:

Reefer Units continued

18014



Vibration Mount

OD	2 1/2"	OEM
OD<	1 13/16"	
ID	15/16"	
LG	13/16"	
HD	70A	

Notes:

18015



Vibration Mount

OD	1 7/8"	OEM
OD<	1 5/16"	
ID	1/2"	
LG	2	
HD	70A	

Notes: components not sold separately

50053



Vibration Mount

OD	3"	OEM
OD<	1 13/16"	
ID	15/16"	
LG	1 5/16"	
HD	70A	

Notes:

50054



Vibration Mount

OD	2 1/2"	OEM
OD<	1 9/16"	
ID	11/16"	
LG	2 7/16"	
HD	60A	

Notes:

50055



Snubber Mount

OD	2 9/16"	OEM
OD<	1 13/16"	
ID	15/16"	
LG	1 1/8"	
HD	90A	

Notes:

50056



Vibration Mount

OD	2 9/16"	OEM
OD<	1 7/16"	
ID	1 1/4"	
ID<	5/8"	
LG	1 7/8"	
HD	60A	

Notes: components not sold separately

Torque Rod

Description	OEM	PART ID	PAGE
Torque Rod		11754	305
Torque Rod		12054	306
Torque Rod		12057	306
Torque Rod	TR6000 / TR70005 / 13590 / 13681 / 13682	12379	307
Torque Rod	TR60000 / TR70005 / 64473-000 / 64474-000	13590	307
Torque Rod	587575 / 58757-005 / 17QF471M5	13597	307
Torque Rod		13629	308

Torque Rod continued

Description	OEM	PART ID	PAGE
Torque Rod		13680	308
Torque Rod		18761	311
Torque Rod		18859	312
Torque Rod		31097	312
Torque Rod		34527	312
Torque Rod Assy	FL39 / 345-212 / 925000 / 943885 / R514 / TR46-41716 / 16-16749-001 / 681-326-6716	11078	304
Torque Rod Assy	35801-3441 / 945381 / 3581270C1 / 925031 / K195-376 / 25164994 / 17QF455P240 / 925031 / TR59-41376	11080	304
Torque Rod Assy	345-868 / 947106 / TR030010040 / TR46-41002 / 16-16749-002 / 16-18972-000 / 681-326-72-16	11081	304
Torque Rod Assy	925050 / R536 / TR46-41000 / 16-15632-000 / 16-18972-000	11152	304
Torque Rod Assy	FL42 / E-8808 / 345-213 / 943886 / R515 / TR46-41316 / 16-16749-000 / 681-326-6316	11153	304
Torque Rod Assy	A13102146A / 925030 / TR59-41375 / 6813262065 / 68-13262-065 / 62000-610 / 1661925C91 / 944270 / K195-375 / 25164946 / 17QF460P240 / 1RY39307P13 / 5435-947794 / IPC 925030	11751	304
Torque Rod Assy	TR59-41474 / K195-472 / K195-474	11773	305
Torque Rod Assy		11777	305
Torque Rod Assy	345-884 / 937530 / TR030020010 / R553 / TR00-41009 / C65-6002 / C65-6009	11792	305
Torque Rod Assy	TMR74 / R74B / TR59-41008 / C65-1008 / C65-1009	11793	305
Torque Rod Assy		11794	305
Torque Rod Assy	345-883 / 937561 / R539 / TR00-41600 / C65-6000-002 / C65-6011-002	11795	305
Torque Rod Assy	SK27771	12042	305
Torque Rod Assy	35801-5012 / MR661 / UR661 / IPC928661 / 66661-000H / 1693537C1 / 46661 / 130310B000 / E-2642	12044	306
Torque Rod Assy	TR62-413M2 / 25170832 / 17QF460P210 / 17QF473M2 / 17QF474P209 / FTR-4537-210 / SS-S0219P210	12069	306
Torque Rod Assy	TR62-413M3 / 3226713 / 25014582 / 25170831 / 251660077 / 17QF358 / 17QF359 / 17QF460P200 / 17QF473M / FTR-4537-200	12070	306
Torque Rod Assy	92883-4 / TR62-41243 / 62000-615 / 25170833 / 17QF261P23 / 17QF352M2 / 17QF460P243 / 17QF473M4	12071	306
Torque Rod Assy	345-222 / 943763 / TR62-41180 / 25162529 / 17QF251P11 / 17QF463P180 / 17QF464P180 / 1RY48P23 / S-13292 / FTR-42628-100 / FTR-4628-180 / FTR-4628A-180	12072	306
Torque Rod Assy	TR62-41215 / 25174658 / 17QF460P215 / S-13291 / FTR-4537-215	12073	306
Torque Rod Assy	924970 / 942119 / 943790 / 945240 / TR62-41238 / 1516350C91 / 1516350C92 / 25160749 / 25164945 / 17QF457P238 / 17QF460P238 / FTR-4537-238 / FTR-4537A-238	12074	307
Torque Rod Assy	50-1428 / PB33 / E-5083 / 345-211 / 947790 / R520 / 5550317 / 924175 / 03-04327 / C65-6016-000010440 / TR75-41327	12395	307
Torque Rod Assy	HDR62010455 / HDR 62010 455 / 62010-455 / HD62010455 / HUD62010455 / ZAK62010455 / ZJF62010455 / 4000-62010455 / TR50-42455	12396	307
Torque Rod Assy	345-882 / 937560 / R537 / TR00-41001 / C65-6000-001 / C65-6011-001	12397	307
Torque Rod Assy	50-1437 / PB46 / E-7853 / 345-215 / 62000-650 / 577 50 343 / 943711 / 03-05108 / 03-05198 / TR75-41108	12398	307
Torque Rod Assy	943853 / R547 / TR62-41220 / 57857006 / 25174706 / 17QF460P220 / 4537-220	13634	308
Torque Rod Assy	35801-0033 / 35801-0033 / 358010-560 / 924711 / R9247 / IPC 924711 / TR13-41022	13657	308
Torque Rod Assy	TR59-41150 / A3580010-635 / S3580001-635 / S3580003-635 / 681-326-70-16 / 62350-635 / 925150	13679	308
Torque Rod Assy	HDR62350615 / HDR 62350 615 / 62350-615 / HD62350615 / HUD62350615 / ZAK62350615 / ZJF62350615 / 25171605 / 17QF455P243 / 4000-62350615 / HDR 62350 615 / TR50-41615	13733	311

Torque Rod continued

Description	OEM	PART ID	PAGE
Torque Rod Assy	E-9394 / E-9409 / 345-734 / 345-792 / 345-815 / TR50-41102 / 32271-102 / 48411-006 / 50376-001 / 62007-365 / 48411006 / 50376001 / 62007365 / 17QF357M	13735	311
Torque Rod Assy	3187322 / 35801-0068 / 75-1709 / VT20 / E-8821 / 30SQ4525 / 345-219 / 345-898 / R531 / R63 / TR96-41068	18860	312
Torque Rod Assy	943902 / 8021378 / 8028945 / 8071851 / 8074268 / R308853A / VT19 / E-8853A / 345-216 / 345-862 / TR96-41268	31095	312
Torque Rod Assy	PB15 / E-4771 / 345-210 / R518 / TR75-41059 / 03-04059 / C65-6013 / SS-219-117	34554	312
Torque Rod Assy	62350-645 / HD62350645 / HUD62350645 / ZAK62350645 / ZJF62350645 / 4000-62350645 / TR50-41645	34555	312
Torque Rod Assy	681-326-2516 / HDR 62001 590 / HDR62000 590 / 62000-590 / 62001-590 / HD62000590 / HD62001590 / HUD62000590 / HUD62001590 / ZAK62000590 / ZAK62001590 / ZJF62000590 / ZJF62001590 / 4000-62000590 / 4000-62001590 / HDR62000590 / HDR62001590 / 924920 / 942174 / 944160 / 944220 / 948574 / TR50-42590	34556	312
Torque Rod Assy	IH22 / E13989 / 345-866 / R533 / TR55-418C1 / 3548381C1 / 4C4Z4612AA / 501565C2	34563	313
Torque Rod End	TR70005 / 13681	13681	308
Torque Rod End	TR60000 / 13682	13682	308
Torque Rod End		13707	311
Torque Rod End		13708	311
Torque Rod End Assy	R301024 / R3010310 / R302639 / MR610 / UR610 / E-10310 / E-2639 / 345-610 / 345-741 / 345-742 / 928610 / IPC928610 / 46610 / 66610-000H / 1693531C1 / 09-5420 / RU610 / TR71000	13683	308
Torque Rod End Assy	35801-5010 / MR630 / UR630 / E-2638 / 345-620 / 345-630 / 345-738 / 928630 / 09-5422 / RU620 / IPC928630 / 46630 / 66630-000H / 1693533C1 / TR72000	13686	309
Torque Rod End Assy	20-9015 / MR640 / E-10313 / E-2810 / 345-640 / M2083 / 09-5809 / R640 / 46640 / 66640-000H / TR82000	13687	309
Torque Rod End Assy	20-9016 / MR650 / E-10314 / E-2811 / E-3169 / 345-640 / 345-650 / 345-740 / M2085 / 09-5804 / R640 / 46650 / 66650-000H / TR84000	13688	309
Torque Rod End Assy		13689	309
Torque Rod End Assy	20-9034 / MR660 / 345-660 / 09-5431 / R660 / 15533801 / 46660 / 66660-000H / 1691033C91 / TR75000	13690	309
Torque Rod End Assy	35801-5012 / R3010315 / R302642 / MR660 / MR661 / UR660 / UR661 / E-2642 / 345-660 / 345-661 / 345-741 / 345-742 / 928660 / 928661 / 09-5424 / 09-5431 / IPC928660 / IPC928661 / 46660 / 46661 / 66660-000H / 66661-000H / 1693536C1 / 1693537C1 / RU660 / RU661 / TR75000	13691	309
Torque Rod End Assy	20-9031 / MR670 / 345-670 / 09-5432 / R670 / 15533803 / 46670 / 66670-000H / 1691035C91 / TR81000	13692	309
Torque Rod End Assy	20-9031 / R302641 / MR671 / E-2641 / 46671 / 345-736 / TR81000	13693	309
Torque Rod End Assy	35801-5014 / 20-9033 / MR680 / UR680 / E-2643 / 345-680 / 928680 / 09-5433 / IPC928680 / 46680 / 66680-000H / 1693542C1 / R680 / TR76000	13694	310
Torque Rod End Assy	35801-5014 / 20-9023 / MR681 / UR681 / E-10317 / 345-681 / 928681 / 09-5426 / IPC928681 / 46681 / 66681-000H / 1693543C1 / 90044638 / R681 / TR76000	13695	310
Torque Rod End Assy	35801-5018 / 20-9032 / MR690 / UR690 / 345-690 / 928690 / 09-5435 / IPC928690 / 46690 / 66690-000H / 1693544C1 / R690 / TR77000	13696	310
Torque Rod End Assy	35801-5018 / 20-9022 / R302812 / MR691 / UR691 / E-2812 / 345-691 / 928691 / IPC928691 / 46691 / 66691-000H / 1693545C1 / 09-5429 / R691 / TR77000	13697	310
Torque Rod End Assy	20-9036 / MR700 / 345-700 / 928700 / 09-5434 / R700 / 15533809 / 46700 / 66700-000H / 1693546C1 / TR85000	13698	310

Torque Rod continued

Description	OEM	PART ID	PAGE
Torque Rod End Assy	20-9026 / MR701 / E-10319 / 345-701 / 928701 / 09-5430 47701 / 15533810 / 46701 / 66701-000H / 1693535C1 / TR85000	13699	310
Torque Rod End Assy	MR766 / E-11784 / 345-612 / 942690 / TR83000 / 56766 / 66766-000H / 1693550C1	13700	310
Torque Rod End Assy	20-9017 / MR767 / E-11748 / 345-794 / 09-5807 / 56767 / 66767-000H / 1693550C1 / TR74000	13701	310
Torque Rod End Assy	345-614 / 928666 / 57046 / 67046-000H	13702	311
Torque Rod End Assy	345-794 / 928665 / 09-5813 / TR78000 / 57047 / 67047-000H / 1693559C1	13703	311
Torque Rod End Assy	345-668 / 928668 / TR79000 / 57048 / 67048-000H	13704	311

11078



Torque Rod Assy

Notes:

C-C	23	13/16"
BC-C	4	3/8"
BH		11/16"
HD	80A	

INCLUDES
QTY 2 11004

OEM
FL39
345-212
925000
943885
TMR514
TR46-41716
16-16749-001
681-326-6716

11080



Torque Rod Assy

Notes:

LG²	8	1/16"
C-C	24	
BC-C	4	3/8"
BH		5/8"
HD	80A	

INCLUDES
QTY 1 11754
QTY 1 13520
QTY 1 13518

OEM
35801-3441
945381
3581270C1
925031
K195-376
25164994
17QF455P240
925031
TR59-41376

11081



Torque Rod Assy

Notes:

C-C	24	5/16"
BC-C	4	3/8"
BH		11/16"
HD	80A	

INCLUDES
QTY 2 11004

OEM
345-868
947106
TR030010040
TR46-41002
16-16749-002
16-18972-000
681-326-72-16

11152



Torque Rod Assy Angled

Notes:

C-C	24	3/16"
BC-C	4	3/8"
BH		5/8"

INCLUDES
QTY 2 13520

OEM
925050
TMR536
TR46-41000
16-15632-000
16-18972-000

11153



Torque Rod Assy

Notes:

C-C	22	7/8"
BC-C	4	3/8"
BH		5/8"

INCLUDES
QTY 2 13521

OEM
FL42
E-8808
345-213
943886
TMR515
TR46-41316
16-16749-000
681-326-6316

11751



Torque Rod Assy

Notes:

C-C	24	
B C-C	4	3/8"
HD	80A	

INCLUDES
QTY 1 11754
QTY 2 13520

OEM
A13102146A
925030
TR59-41375
6813262065
68-13262-065
62000-610
1661925C91
944270
K195-375
25164946

Torque Rod continued

11754



Torque Rod

ID	2	3/4"
C-C	24	"

INCLUDED IN:
11080, 11751

OEM

Notes:

11773



Torque Rod Assy

C-C	19	3/4"
BC-C	4	3/8"
BH		11/16"
HD	80A	"

INCLUDES
QTY 1 11770
QTY 2 11729

OEM
TR59-41474
K195-472
K195-474

Notes:

11777



Torque Rod Assy

C-C	19	3/4"
BC-C	4	3/8"
BH		11/16"
HD	80A	"

INCLUDES
QTY 1 11770
QTY 2 13677

OEM

Notes:

11792



Torque Rod Assy

C-C	25	9/16"
BC-C	4	3/8"
BH		5/8"

INCLUDES
QTY 2 13521

OEM
345-884
937530
TR030020010
TMR553
TR00-41009
C65-6002
C65-6009

Notes:

11793



Torque Rod Assy

C-C	20	1/4"
BC-C	4	3/8"
BH		11/16"

INCLUDES
QTY 2 11729

OEM
TMR74
TMR74B
TR59-41008
C65-1008
C65-1009

Notes:

11794



Torque Rod Assy

LG	8	1/16"
C-C	25	"
BC-C	4	3/8"
BH		5/8"
THR	1 1/4"	-12 UNF

INCLUDES
QTY 1 13520
QTY 1 13518

OEM

Notes:

11795



Torque Rod Assy

ID		7/8"
C-C	24	11/16"
BC-C	4	3/8"
BH		5/8"

INCLUDES
QTY 1 13521
QTY 1 14010

OEM
345-883
937561
TMR539
TR00-41600
C65-6000-002
C65-6011-002

Notes:

12042



Torque Rod Assy
Weldable

LG	7	"
C-C	26	"
BC-C	4	3/8"
BH		5/8"
THR	1 1/2"	-12 UNF

INCLUDES
QTY 1 13590
QTY 1 13520
QTY 1 12031

OEM
SK27771

Notes:

Torque Rod continued

12044



Torque Rod Assy
Weldable

C-C	26	--
BC-C	4	3/8
BH		5/8

INCLUDES

QTY 1	13590
QTY 2	13520

OEM

35801-5012
MR661
UR661
IPC928661
46661
66661-000H
1693537C1
130310B000
E-2642

Notes: universal torque rod

12054



Torque Rod

ID	2	3/4	--
C-C	18	1/8	--

OEM

Notes:

12057



Torque Rod

ID	2	3/4	--
C-C	24	3/8	--

OEM

Notes:

12069



Torque Rod Assy

C-C	21	--
BC-C	4	3/8
BH		5/8

INCLUDES

QTY 2	13520
-------	-------

OEM

TR62-413M2
25170832
17QF460P210
17QF473M2
17QF474P209
FTR-4537-210
SS-S0219P210

Notes:

12070



Torque Rod Assy

C-C	20	--
BC-C	4	3/8
BH		5/8

INCLUDES

QTY 2	13520
-------	-------

OEM

TR62-413M3
3226713
25014582
25170831
251660077
17QF358
17QF359
17QF460P200
17QF473M
FTR-4537-200

Notes:

12071



Torque Rod Assy

C-C	24	3/16	--
BC-C	4	3/8	--
BH		5/8	--

INCLUDES

QTY 2	13520
-------	-------

OEM

92883-4
TR62-41243
62000-615
25170833
17QF261P23
17QF352M2
17QF460P243
17QF473M4

Notes:

12072



Torque Rod Assy

LG	7	--
C-C	18	--
BC-C	4	3/8
BH		5/8
THR	1 1/2	12 UNF

INCLUDES

QTY 1	13520
QTY 1	12031

OEM

345-222
943763
TR62-41180
25162529
17QF251P11
17QF463P180
17QF464P180
1RY48P23
S-13292
FTR-42628-100

Notes:

12073



Torque Rod Assy

C-C	21	1/2	--
BC-C	4	3/8	--
BH		5/8	--

INCLUDES

QTY 2	13520
-------	-------

OEM

TR62-41215
25174658
17QF460P215
S-13291
FTR-4537-215

Notes:

Torque Rod continued

12074



Torque Rod Assy

C-C	23 3/4"	OEM 924970 942119 943790 945240 TR62-41238 1516350C91 1516350C92 25160749 25164945 17QF457P238
BC-C	4 3/8"	
BH	11/16"	

INCLUDES
QTY 2 11729

Notes:

12379



Torque Rod

ID	2 3/4"	OEM TR6000 TR70005 13590 13681 13682
C-C	25 1/2"	

Notes:

12395



Torque Rod Assy

C-C	17 5/16"	OEM 50-1428 PB33 E-5083 345-211 947790 TMR520 5550317 924175 03-04327 C65-6016-
BC-C	4 3/8"	
BH ⁽¹⁾	5/8"	
BH ⁽²⁾	3/4"	

INCLUDES
QTY 1 13528
QTY 1 13520

Notes:

12396



Torque Rod Assy

C-C	17 5/16"	OEM HDR62010455 HDR 62010 455 62010-455 HD62010455 HUD62010455 ZAK62010455 ZJF62010455 4000-62010455 TR50-42455
BC-C	4 3/8"	
BH	5/8"	
INCLUDES QTY 2 13520		

Notes:

12397



Torque Rod Assy

ID	7/8"	OEM 345-882 937560 TMR537 TR00-41001 C65-6000-001 C65-6011-001
C-C	23 3/4"	
BC-C	4 3/8"	
BH	5/8"	

INCLUDES
QTY 1 13521
QTY 1 14010

Notes:

12398



Torque Rod Assy

C-C	25 9/16"	OEM 50-1437 PB46 E-7853 345-215 62000-650 577 50 343 943711 03-05108 03-05198 TR75-41108
BC-C	4 3/8"	
BH	5/8"	
INCLUDES QTY 2 13520		

Notes:

13590



Torque Rod Weldable

ID	2 3/4"	OEM TR60000 TR70005 64473-000 64474-000
C-C	26"	

INCLUDED IN:
12042, 12044

Notes:

13597



Torque Rod

ID	1 7/8"	OEM 587575 58757-005 17QF471M5
C-C	22 1/16"	

Notes:

Torque Rod continued

13629 ID 2 3/4" --
C-C 22 --

OEM

INCLUDED IN:
13634, 13657



Torque Rod

Notes:

13634 C-C 22 --

OEM
943853
TMR547
TR62-41220
57857006
25174706
17QF460P220
4537-220

INCLUDES
QTY 2 11729
QTY 1 13629



Torque Rod Assy

Notes:

13657 C-C 22 --

OEM
35801-0033
35801-0033
358010-560
924711
TMR9247
IPC 924711
TR13-41022

INCLUDES
QTY 1 13629
QTY 1 13520
QTY 1 13518



Torque Rod Assy

Notes:

13679 LG 8 1/16" --
C-C 25 --
BC-C 4 3/8" --
BH 5/8" --
HD 80A

OEM
TR59-41150
A3580010-635
S3580001-635
S3580003-635
681-326-70-16
62350-635
925150

INCLUDES
QTY 1 13680
QTY 1 13518
QTY 1 13520



Torque Rod Assy

Notes:

13680 ID 2 3/4" --
C-C 25 --

OEM

INCLUDED IN:
13679



Torque Rod

Notes:

13681 ID 2 3/4" --
LG 8 9/16" --

OEM
TR70005

INCLUDED IN:
13686, 13687, 13688,
13700, 13701



Torque Rod End
Tube End

Notes:

13682 ID 2 3/4" --
LG 25 7/16" --

OEM
TR60000

INCLUDED IN:
13691, 13693, 13695,
13697, 13699, 13703,
13704



Torque Rod End
Rod End

Notes:

13683 LG 8 9/16" --
BC-C 4 3/8" --
BH 5/8" --
HD 80A

OEM
R301024
R3010310
R302639
MR610
UR610
E-10310
E-2639
345-610
345-741
345-742

INCLUDES
QTY 1 13520
QTY 1 13681



Torque Rod End Assy
Tube End

Notes:

Torque Rod continued

13686



LG	8 9/16"	OEM
LG ²	8 1/16"	35801-5010
THR	1 1/4" - 12 UNF	MR630
HD	80A	UR630

INCLUDES

QTY 1	13681
QTY 1	13518

Torque Rod End Assy
Tube End

Notes:

13687



LG	8 9/16"	OEM
BC-C	5 11/16"	20-9015
BH	13/16"	MR640
HD	80A	E-10313

INCLUDES

QTY 1	13681
QTY 1	13517

Torque Rod End Assy
Tube End

Notes:

13688



ID	1 1/8"	OEM
LG	8 9/16"	20-9016
LG ²	3 1/4"	MR650
HD	80A	E-10314

INCLUDES

QTY 1	13681
QTY 1	13516

Torque Rod End Assy
Tube End

Notes:

13689



LG	33 7/16"	OEM
BC-C	4 3/8"	
BH	7/8"	
HD	80A	

INCLUDES

QTY 1	13707
QTY 1	13685

Torque Rod End Assy
35" Rod End

Notes:

13690



LG	33 7/16"	OEM
BC-C	4 3/8"	20-9034
BH	5/8"	MR660
HD	80A	345-660

INCLUDES

QTY 1	13707
QTY 1	13520

Torque Rod End Assy
35" Rod End

Notes:

13691



LG	25 7/16"	OEM
BC-C	4 3/8"	35801-5012
BH	5/8"	R3010315
HD	80A	R302642

INCLUDES

QTY 1	13682
QTY 1	13520

Torque Rod End Assy
27" Rod End

Notes:

13692



LG	33 7/16"	OEM
LG ²	6 5/8"	20-9031
THR	1 1/4" - 12 UNF	MR670
HD	80A	345-670

INCLUDES

QTY 1	13707
QTY 1	13684

Torque Rod End Assy
35" Rod End

Notes:

13693



LG	25 7/16"	OEM
LG ²	6 5/8"	20-9031
THR	1 1/4" - 12 UNF	R302641
HD	80A	MR671

INCLUDES

QTY 1	13682
QTY 1	13684

Torque Rod End Assy
27" Rod End

Notes:

Torque Rod continued

13694



Torque Rod End Assy
35" Rod End

LG 33 7/16"
LG² 8 1/16"
THR 1 1/4" - 12 UNF
HD 80A

INCLUDES
QTY 1 13707
QTY 1 13518

OEM
35801-5014
20-9033
MR680
UR680
E-2643
345-680
928680
09-5433
IPC928680
46680

Notes:

13695



Torque Rod End Assy
27" Rod End

LG 25 7/16"
LG² 8 1/16"
THR 1 1/4" - 12 UNF
HD 80A

INCLUDES
QTY 1 13682
QTY 1 13518

OEM
35801-5014
20-9023
MR681
UR681
E-10317
345-681
928681
09-5426
IPC928681
46681

Notes:

13696



Torque Rod End Assy
35" Rod End

LG 33 7/16"
LG² 7
THR 1 1/4" - 12 UNF
HD 80A

INCLUDES
QTY 1 13707
QTY 1 12031

OEM
35801-5018
20-9032
MR690
UR690
345-690
928690
09-5435
IPC928690
46690
66690-000H

Notes:

13697



Torque Rod End Assy
27" Rod End

LG 25 7/16"
LG² 7
THR 1 1/4" - 12 UNF
HD 80A

INCLUDES
QTY 1 13682
QTY 1 12031

OEM
35801-5018
20-9022
R302812
MR691
UR691
E-2812
345-691
928691
IPC928691
46691

Notes:

13698



Torque Rod End Assy
36" Rod End

ID 1 1/8"
LG 34 7/16"
LG² 3 1/4"
HD 80A

INCLUDES
QTY 1 13708
QTY 1 13516

OEM
20-9036
MR700
345-700
928700
09-5434
TMR700
15533809
46700
66700-000H
1693546C1

Notes:

13699



Torque Rod End Assy
27" Rod End

ID 1 1/8"
LG 25 7/16"
LG² 3 1/4"
HD 80A

INCLUDES
QTY 1 13682
QTY 1 13516

OEM
20-9026
MR701
E-10319
345-701
928701
09-5430
TMR701
15533810
46701
66701-000H

Notes:

13700



Torque Rod End Assy
Tube End

LG 8 9/16"
BC-C 4 3/8"
BH 7/8"
HD 80A

INCLUDES
QTY 1 13681
QTY 1 13685

OEM
MR766
E-11784
345-612
942690
TR83000
56766
66766-000H
1693550C1

Notes:

13701



Torque Rod End Assy
Tube End

LG 8 9/16"
BC-C 4 3/8"
BH 3/4"
HD 80A

INCLUDES
QTY 1 13681
QTY 1 13528

OEM
20-9017
MR767
E-11748
345-794
09-5807
56767
66767-000H
1693550C1
TR74000

Notes:

Torque Rod continued

13702

LG	33	7/16"
B C-C	4	3/8"
BH		3/4"
HD	80A	

INCLUDES
QTY 1 13702
QTY 1 13528

OEM
345-614
928666
57046
67046-000H



Torque Rod End Assy
35" Rod End

Notes:

13703

LG	25	7/16"
B C-C	4	3/8"
BH		3/4"
HD	80A	

INCLUDES
QTY 1 13682
QTY 1 13528

OEM
345-794
928665
09-5813
TR78000
57047
67047-000H
1693559C1



Torque Rod End Assy
27" Rod End

Notes:

13704

LG	25	7/16"
BC-C	4	3/8"
BH		7/8"
HD	80A	

INCLUDES
QTY 1 13682
QTY 1 13685

OEM
345-668
928668
TR79000
57048
67048-000H



Torque Rod End Assy
27" Rod End

Notes:

13707

ID	2	3/4"
LG	33	7/16"

INCLUDED IN:
13689, 13690, 13692,
13694, 13696, 13702

OEM



Torque Rod End
35" Rod End

Notes:

13708

ID	2	3/4"
LG	34	7/16"

INCLUDED IN:
13698

OEM
13708



Torque Rod End
36" Rod End

Notes:

13733

C-C	14	3/8"
BC-C	4	3/8"
BH		5/8"
THR		1 1/4" - 12UNF

INCLUDES
QTY 1 13520
QTY 1 13518

OEM
HDR62350615
HDR 62350 615
62350-615
HD62350615
HUD62350615
ZAK62350615
ZJF62350615
25171605
17QF455P243
4000-62350615



Torque Rod Assy

Notes:

13735

C-C	14	3/8"
BC-C	4	3/8"
BH		5/8"

INCLUDES
QTY 2 13520

OEM
E-9394
E-9409
32271-102
48411-006
50376-001
62007-365
48411006
50376001
62007365
17QF357M



Torque Rod Assy

Notes:

18761

ID	3	1/2"
C-C		22 11/16"

OEM



Torque Rod

Notes:

Torque Rod continued

18859

ID	2 3/4"	OEM
C-C	22 1/8"	

INCLUDED IN:
18860



Torque Rod

Notes:

18860

C-C	22 1/8"	OEM
BC-C	4 3/8"	
BH	5/8"	
HD	80A	

INCLUDES
QTY 1 18859
QTY 2 13520



Torque Rod Assy

Notes:

31095

C-C	22 5/8"	OEM
BC-C	4 3/8"	
BH	11/16"	

INCLUDES
QTY 1 31097
QTY 2 11729



Torque Rod Assy Angled

Notes:

31097

ID	2 3/4"	OEM
C-C	22 5/8"	

INCLUDED IN:
31095



Torque Rod Angled

Notes: not offered by OE

34527

ID	2 7/16"	OEM
C-C	14 1/2"	



Torque Rod

Notes: bushing options 11714 or 13618 / OE does not offer bushing / used with Kenworth and International with modified Hendrickson axles

34554

C-C	22 7/8"	OEM
BC-C	4 3/8"	
BH	5/8"	

INCLUDES
QTY 2 13520



Torque Rod Assy

Notes:

34555

LG	8 1/4"	OEM
C-C	25 1/4"	
BC-C	4 3/8"	
BH	5/8"	
THR	1 1/4" - 12 UNF	

INCLUDES
QTY 1 13520
QTY 1 13518



Torque Rod Assy

Notes:

34556

C-C	23 1/4"	OEM
BC-C	4 3/8"	
BH	5/8"	

INCLUDES
QTY 2 13520



Torque Rod Assy

Notes:

Torque Rod continued

34563



Torque Rod Assy

C-C 25 3/8 ~
BC-C 4 7/16 ~
BH 5/8 ~

INCLUDES
QTY 2 13521

OEM
IH22
E13989
345-866
TMR533
TR55-418C1
3548381C1
4C4Z4612AA
501565C2

Notes:

Miscellaneous

DESCRIPTION	OEM	PART ID	PAGE
Trailer & Dock Bumper Shelled		50022	326
Battery Dust Cover Black		18054	319
Beam End Bushing		18118	321
Bolt Kit		12081	315
Bolt Kit		12082	315
Bolt Kit		12083	315
Bushing		18096	320
Bushing		18757	324
Bushing	320-80-017	18762	325
Bushing		18526	322
Bushing Magnetic Break Isolator		18086	320
Cab Mount		18079	320
Cab Mount		18081	320
Cab Mount		18113	320
Carrier Bearing Bushing		11772	315
Carrier Bearing Bushing		18000	317
Carrier Bearing Bushing		18002	317
Carrier Bearing Bushing		18725	323
Center Bushing		13636	316
Curtain Roller		18581	322
Exhaust Bushing		18758	325
Flag		18005	317
Flag		18006	317
Flag Angled Rod 5/8, Left		18072	320
Flag No Rod		18008	317
Flag Straight Rod 5/8 Aluminum		18058	319
Flag Thinner Rod 9/16		18060	319
Fuel Tank Cap Gasket		18310	321
Fuel Tank Cap Gasket		18320	322
Fuel Tank Cap Gasket		18688	323
Fuel Tank Gasket		11728	315

Miscellaneous continued

DESCRIPTION	OEM	PART ID	PAGE
Fuel Tank Plug		18045	318
Fuel Tank Plug		18046	318
Load Bushing		18049	319
Motor Mount		16506	316
Motor Mount		16507	316
Motor Mount		16509	316
Motor Mount		16510	317
Motor Mount		32503	325
Oil Cap Bushing		18043	318
Oil Cap Bushing		18044	318
Oil Plug		18290	321
Pivot Bushing		18733	324
Pivot Bushing	O-35A	18750	324
Pump Valve Cover		17516	317
Radiator Mount		18047	318
Radiator Mount Red		18055	319
Seat Bushing		18053	319
Shackle		18598	323
Shifter Bushing Kit		18778	325
Shifter Washer		31520	325
Shock Absorber Bushing		16503	316
Shock Absorber Bushing		16505	316
Shock Absorber Bushing		18004	317
Shock Absorber Bushing		18011	318
Shock Absorber Bushing		18030	318
Shock Absorber Bushing		18034	318
Shock Absorber Bushing		18048	319
Shock Absorber Bushing		18065	319
Shock Absorber Bushing		18100	320
Shock Absorber Sleeve		18240	321
Slide Roller	SP	18822	325
Spring Bushing		16501	316
Spring Bushing		18317	322
Spring Bushing		18318	322
Spring Bushing	C2316270	18753	324
Spring Spacer		18229	321
Spring Spacer		18230	321
Spring Spacer		18730	323
Stabilizer Bar Bushing		18352	322
Suspension Bushing	320-80-15	18705	323
Suspension Bushing		18702	323
Suspension Mount	TC7105	18695	323
Suspension Mount		18699	323
Thrust Washer	Q-70A	18745	324
Thrust Washer	Q-70	18748	324
Torque Rod Bushing	13043	13043	315
Torque Rod Bushing		18233	321
Torque Rod Bushing		18259	321

Miscellaneous continued

DESCRIPTION	OEM	PART ID	PAGE
Torque Rod Bushing	O-37A	18746	324
Torque Rod Bushing	O-46A	18747	324
Torque Rod Bushing	16776	18961	325
Torque Rod Bushing		18568	322
Torque Rod Bushing		18984	325
Trailer & Dock Bumper Solid		50021	326
Valve Seal		18069	320
Wheel Chock		18455	322
Wheel Chock	40095	40095	326

11728



Fuel Tank Gasket

OD	3 9/16"
ID	2 13/16"
THK	5/32"
HD	80A

OEM

Notes:

11772



Carrier Bearing Bushing

ID	3 5/16"
THK	2 1/32"
WD	6 3/4"
LG	6 3/4"
HD	70A

OEM

Notes:

12081



Bolt Kit

INCLUDES

QTY 4	Bolt 3/8" x 4" UNC
QTY 12	Bolt 3/8" x 6" UNF
QTY 12	Lock Nut 3/8" UNF
QTY 16	Flat Washer 3/8"

INCLUDED IN:
12036

OEM

Notes: special order only

12082



Bolt Kit

INCLUDES

QTY 4	Bolt 3/8" x 4" UNC
QTY 12	Bolt 3/8" x 7 1/2" UNF
QTY 12	Lock Nut 3/8" UNF
QTY 16	Flat Washer 3/8"

INCLUDED IN:
12040

OEM

Notes: special order only

12083



Bolt Kit

INCLUDES

QTY 4	Bolt 3/8" x 4" UNC
QTY 12	Bolt 3/8" x 5" UNF
QTY 12	Lock Nut 3/8" UNF
QTY 16	Flat Washer 3/8"

INCLUDED IN:
12039

OEM

Notes: special order only

13043



Torque Rod Bushing Narrow

OD	2 3/16"
OD<	1 13/16"
ID	1 1/4"
LG	2 3/8"
HD	97A - 80A

OEM
13043

Notes: narrow / standard - 13001

Miscellaneous continued

13636



Center Bushing

OD	4 3/4"	~
OD<	3 1/2"	~
ID	2 1/2"	~
LG	12	~
HD	80A	

OEM

Notes: double bonded-welded plug / standard-welded plug - 13505 / standard-loose plug - 13543

14012



Equalizer Bushing

OD	5	~
ID	4	~
LG	9	~
HD	90A	

OEM

Notes: chamfered / standard - 14027

16501



Spring Bushing

OD	1	~
ID	1/2	~
LG	2 15/16	~
HD	80A	

OEM

Notes:

16503



Shock Absorber Bushing

OD	1 5/16"	~
ID	5/8"	~
LG	1 7/16"	~
HD	80A	

OEM

Notes:

16505



Shock Absorber Bushing

OD	1 3/8"	~
ID	11/16"	~
LG	1 5/8"	~
HD	80A	

OEM

Notes:

16506



Motor Mount

WD	2 1/8"	~
LG	4 7/16"	~
HGT	1 5/8"	~
HD	80A	

OEM

Notes:

16507



Motor Mount

WD	1 5/8"	~
LG	5 1/4"	~
HGT	1 1/8"	~
HD	80A	

OEM

Notes: components not sold separately

16509



Motor Mount

WD	2 1/16"	~
LG	3 5/16"	~
HGT	1 7/16"	~
HD	80A	

OEM

Notes:

Miscellaneous continued

16510



Motor Mount

WD	3 7/16"	OEM
LG	4 1/4"	
HGT	2"	
HD	70A	

Notes:

17516



Pump Valve Cover

OD	1 3/8"	OEM
ID	9/16"	
THK	11/16"	
HD	80A	

Notes:

18000



Carrier Bearing Bushing

ID	3 3/16"	OEM
THK	2 3/16"	
WD	5"	
LG	5 3/16"	
HD	70A	

Notes:

18002



Carrier Bearing Bushing

ID	4 7/16"	OEM
THK	2 7/16"	
WD	6 11/16"	
LG	7"	
HD	70A	

Notes: included in 40074

18004



Shock Absorber Bushing

OD	1 1/4"	OEM
ID	7/16"	
LG	13/16"	
HD	80A	

Notes:

18005



Flag
Straight Rod 5/8"

THK	1/8"	OEM
LG	19 7/8"	
HD	90A	

Notes:

18006



Flag
Angled Rod 5/8", Right

THK	1/8"	OEM
LG	19 1/2"	
HD	90A	

Notes:

18008



Flag
No Rod

ID	5/8"	OEM
THK	1/8"	
HD	90A	

Notes:

Miscellaneous continued

18011



Shock Absorber Bushing

OD	1 5/16"
ID	3/8"
LG	3/4"
HD	80A

OEM

Notes:

18030



Radiator Mount

OD	2"
OD<	1 3/8"
ID	9/16"
LG	1 5/8"
HD	80A

OEM

Notes:

18034



Shock Absorber Bushing

OD	2 1/16"
ID	5/8"
LG	13/16"
HD	80A

OEM

Notes:

18043



Oil Cap Bushing

OD	15/16"
ID	5/16"
LG	13/16"
HD	80A

OEM

Notes:

18044



Oil Cap Bushing

OD	1 1/4"
OD<	1"
ID	3/8"
LG	13/16"
HD	70A

OEM

Notes:

18045



Fuel Tank Plug

OD	2 7/16"
OD<	2 1/16"
ID	3/8"
LG	1 5/16"
HD	70A

OEM

Notes:

18046



Fuel Tank Plug

OD	3 7/16"
OD<	3 1/8"
ID	1/2"
LG	1 7/16"
HD	70A

OEM

Notes:

18047



Radiator Mount

OD	1 9/16"
ID	1/2"
LG	1/2"
HD	80A

OEM

Notes:

Miscellaneous continued

18048



Shock Absorber Bushing

OD	1 5/8"	OEM
ID	3/8"	
LG	13/16"	
HD	80A	

Notes:

18049



Load Bushing

OD	5 1/4"	OEM
ID	1/2"	
LG	5 1/2"	
HD	70A	

Notes:

18053



Seat Bushing

OD	1 3/16"	OEM
OD<	7/8"	
ID	1/2"	
LG	1 3/16"	
HD	80A	

Notes:

18054



Battery Dust Cover Black

THK	1"	OEM
WD	2 1/16"	
LG	3 1/16"	
HD	90A	

Notes:

18055



Battery Dust Cover Red

THK	1"	OEM
WD	2 1/16"	
LG	3 1/16"	
HD	90A	

Notes:

18058



Flag Straight Rod 5/8" Aluminum

THK	1/8"	OEM
LG	19 7/8"	
HD	90A	

Notes:

18060



Flag Thiner Rod 9/16"

THK	1/8"	OEM
LG	19 7/8"	
HD	90A	

Notes:

18065



Shock Absorber Bushing

OD	2 1/4"	OEM
ID	1 1/16"	
LG	13/16"	
HD	80A	

Notes:

Miscellaneous continued

18069



Valve Seal

OD	3/4"
OD<	5/8"
ID	3/8"
LG	1/2"
HD	70A

OEM

Notes:

18072



Flag
Angled Rod 5/8", Left

THK	1/8"
LG	19 1/2"
HD	90A

OEM

Notes:

18079



Cab Mount

OD	2 3/4"
ID	1 3/8"
LG	2"
HD	90A

OEM

Notes:

18081



Cab Mount

OD	1 13/16"
ID	3/4"
LG	2 3/16"
HD	80A

OEM

Notes:

18086



Bushing
Magnetic Break Isolator

OD	2 3/4"
OD<	2 3/16"
ID	3/4"
LG	2 3/4"
HD	70A

OEM

Notes: additional tool suggestion 40030

18096



Bushing

OD	1 1/16"
ID	7/16"
LG	3/4"
HD	70A

OEM

Notes:

18100



Shock Absorber Bushing

OD	1 9/16"
OD<	1 5/16"
ID	3/4"
LG	1 3/4"
HD	80A

OEM

Notes:

18113



Cab Mount

OD	1 7/16"
ID	5/8"
LG	2 7/8"
HD	80A

OEM

Notes:

Miscellaneous continued

18118



Beam End Bushing

OD	5 5/16"	OEM
ID	2 1/2"	
LG	5 3/4"	
HD	80A	

Notes:

18229



Spring Spacer

OD	5 1/4"	OEM
ID	3 9/16"	
HGT	15/16"	
HD	97A	

Notes:

18230



Spring Spacer

OD	5 1/4"	OEM
ID	3 9/16"	
HGT	1 1/8"	
HD	71D	

Notes:

18233



Torque Rod Bushing

OD	4 1/8"	OEM
C-C	5 1/4"	
BH	1"	
HD	80A	

Notes:

18240



Shock Absorber Sleeve

OD	1"	OEM
ID	5/8"	
LG	2 3/16"	

Notes:

18259



Torque Rod Bushing

OD	2 3/4"	OEM
OD<	2 7/16"	
ID	1 7/16"	
LG	1 15/16"	
HD	80A	

Notes:

18290



Oil Plug

OD	1 7/8"	OEM
OD<	1 7/16"	
ID	3/4"	
LG	1 7/16"	
HD	80A	

Notes:

18310



Fuel Tank Cap Gasket

OD	3 9/16"	OEM
ID	2 7/8"	
WD	1/8"	
HD	80A	

Notes:

Miscellaneous continued

18317



Spring Bushing

OD	1 13/16"
ID	3/4"
LG	3
HD	80A

OEM

Notes:

18318



Spring Bushing

OD	1 11/16"
ID	5/8"
LG	3
HD	80A

OEM

Notes:

18320



Fuel Tank Cap Gasket

OD	3 9/16"
ID	2 7/8"
THK	1/8"
HD	80A

OEM

Notes:

18352



Stabilizer Bar Bushing

ID	3/4"
WD	1 1/4"
LG	1 9/16"
HGT	1 3/8"
HD	80A

OEM

Notes:

18455



Wheel Chock

THK	5 1/2"
WD	6 5/16"
LG	8 11/16"

OEM

Notes:

18526



Bushing

OD	1 7/8"
ID	1 9/16"
LG	1 3/8"
HD	71D

OEM

Notes:

18568



Torque Rod Bushing

OD	3 1/2"
C-C	4 13/16"
BH	3/4"
HD	80A

OEM

Notes: compatible with Big 6 suspensions

18581



Curtain Roller

OD	1"
LG	1 13/16"
HD	71D

OEM

Notes:

Miscellaneous continued

18598



ID	1	~
THK	1	~
WD	2	~
LG	5	1/4
C-C	3	1/4

OEM

Shackle

Notes:

18688



OD	3	1/2	~
ID	2	3/4	~
THK		3/32	~
HD		80A	

OEM

Fuel Tank Cap Gasket

Notes:

18695



ID	1	7/8	~
THK		7/8	~
WD	3	1/2	~
LG	8	5/16	~
HD	71D		

OEM
TC7105

Suspension Mount

Notes:

18699



OD	4	5/16	~
ID	2	3/8	~
LG	1	1/16	~
HD		80A	

OEM

Suspension Mount

Notes:

18702



OD	1	1/2	~
ID		9/16	~
LG	3		
HD		80A	

OEM

Suspension Bushing

Notes:

18705



OD	2	7/8	~
ID	2	1/4	~
LG	7	15/16	~
HD		80A	

OEM
320-80-15

Suspension Bushing

Notes:

18725



ID	3	1/8	~
WD	2		
LG	5	9/16	~
HGT	5	3/8	~
HD		70A	

OEM

INCLUDED IN:
40075

Carrier Bearing Bushing

Notes: included in 40075

18730



THK		3/16	~
WD	4	5/8	~
LG	5	3/16	~
HGT	2	13/16	~
HD	71D		

OEM

Spring Spacer

Notes:

Miscellaneous continued

18733

OD	3	--
ID	1 3/4	--
LG	5 1/8	--
HD	80A-71D	

OEMPivot Bushing
Free Rotation

Notes:

18745

OD	4 1/16	--
ID	2	--
LG	3/16	--
HD	71D	

OEM
Q-70A

Thrust Washer

Notes:

18746

OD	2 5/16	--
OD<	1 3/4	--
ID	1 1/8	--
LG	1 1/2	--
HD	80A	

OEM
Q-37A

Torque Rod Bushing

Notes:

18747

OD	2 3/4	--
OD<	2 1/4	--
ID	1 1/2	--
LG	1 3/4	--
HD	80A	

OEM
Q-46A

Torque Rod Bushing

Notes:

18748

OD	3 1/2	--
ID	1 3/4	--
LG	3/16	--
HD	71D	

OEM
Q-70

Thrust Washer

Notes:

18750

OD	3 1/4	--
ID	2	--
LG	5 1/4	--
HD	80A-71D	

OEM
Q-35APivot Bushing
Free Rotation

Notes:

18753

OD	2 3/8	--
ID	1 3/16	--
LG	3 1/4	--
HD	80A	

OEM
C2316270

Spring Bushing

Notes:

18757

OD	1 3/8	--
OD<	1 3/16	--
ID	1 1/16	--
LG	1 15/16	--
HD	80A	

OEM

Bushings

Notes:

Miscellaneous continued

18758



Exhaust Bushing

OD	2 11/16"
ID	1 3/16"
LG	3 5/16"
HD	70A

OEM

Notes:

18762



Bushing

OD	4 1/2"
OD<	3 5/16"
ID	2 3/4"
LG	7 7/8"
HD	80A

OEM
320-80-017

Notes:

18778



Shifter Bushing Kit

OD	1 1/2"
ID	13/16"
LG	2 5/16"
HD	80A

OEM

Notes: new

18822



Slide Roller Bus Door

OD	1 13/16"
ID	1/2"
LG	1 13/16"
HD	71D

OEM
SP

Notes:

18961



Torque Rod Bushing

OD	3 1/2"
C-C	5 1/16"
BH	11/16"
HD	80A

OEM
16776

Notes:

18984



Torque Rod Bushing

OD	2 17/32"
ID	7/8"
LG	2 1/2"
HD	80A

OEM

Notes: not offered by OE

31520



Shifter Washer

OD	13/16"
ID	1/4"
LG	1/4"
HD	97A

OEM

Notes:

32503



Motor Mount

THK	3 9/16"
WD	4 3/8"
LG	9 1/16"
HD	80A

OEM

Notes:

Miscellaneous continued

40095



Wheel Check Flaps

THK	7	1/4	-
WD	8	3/8	-
LG	12	-	-
HGT	8	-	-

OEM
40095

Notes:

50021



Trailer & Dock Bumper Solid

THK	3	1/4	-
WD	2	3/4	-
LG	6	-	-
C-C	2	5/8	-
BH	-	9/16	-
HD	90A	-	-

OEM

Notes:

50022



Trailer & Dock Bumper Shelled

THK	3	1/4	-
WD	2	3/4	-
LG	6	-	-
C-C	2	5/8	-
BH	-	9/16	-
HD	90A	-	-

OEM

Notes:

Tools

DESCRIPTION	OEM	PART ID	PAGE
Tool R & I	HT210 / E-9575 / 334-936 / PT50-59307 / S-21307	13581	328
Tool R & I	E-14634 / 334-1655 / TRB5914-T / PT50-59736 / HDR S 24736 / S-24736 / 8446-S24736 / HDR S 24736 / HTS24736 / HT-S-24736 / HDRS24736	13623	328

Related Tools

Tool For	Part Description	Tool Options / Part ID's
10075	Torque Rod Bushing	10076
11004	Torque Rod Bushing	11071, 18836
11005	Spring Pin Bushing	11069
11060	Spring Pin Bushing	40090
11063	Spring Pin Bushing	18836
11075	Cab Mount	11075
11083	Spring Pin Bushing	11069
11507	Torque Rod Bushing	18833, 40131
11509	Torque Rod Bushing	11731, 18834
11511	Torque Rod Bushing	11731, 18834
11512	Torque Rod Bushing	11732, 18834
11514	Torque Rod Bushing	11732, 18834
11714	Torque Rod Bushing	18552, 18833, 40131
11729	Torque Rod Bushing	18551, 18833

Tool For	Part Description	Tool Options / Part ID's
11753	Spring Pin Bushing	40090
11758	Spring Pin Bushing	40090
11763	Spring Pin Bushing	40093
11767	Spring Pin Bushing	40090
11775	Spring Pin Bushing	40093
12051	Torque Rod Bushing	11071, 18836
12340	Cab Mount	40030
13500	Center Bushing	18543, 18544
13501	Beam End Bushing	13564, 13588, 18541, 18542
13505	Center Bushing	13570, 18539, 18540
13506	Beam End Bushing	13564, 13588, 18541, 18542
13510	Suspension Bushing	13581
13513	Equalizer Bushing	18833, 40131

Tools continued

Tool For	Part Description	Tool Options / Part ID's
13514	Torque Rod Bushing	13585, 18831
13515	Torque Rod Bushing	13585, 18831
13516	Torque Rod Bushing	18551, 18833, 40131
13517	Torque Rod Bushing	18551, 18833, 40131
13518	Torque Rod Bushing	13584, 18551, 18833, 40131
13519	Torque Rod Bushing	18051
13520	Torque Rod Bushing	18551, 18833, 40131
13521	Torque Rod Bushing	11071, 18836
13522	Torque Rod Bushing	18553, 18833, 40131
13525	Torque Rod Bushing	18831
13528	Torque Rod Bushing	18551, 18833, 40131
13532	Torque Rod Bushing	18551, 18833, 40131
13533	Torque Rod Bushing	18831
13534	Center Bushing	13570, 18539, 18540
13536	Torque Rod Bushing	18831
13543	Center Bushing	13570, 18539, 18540
13544	Center Bushing	13570, 18540
13545	Beam End Bushing	13569
13546	Beam End Bushing	13569
13553	Beam End Bushing	13563, 13588, 13595
13560	Beam End Bushing	13564, 13588, 18541, 18542
13565	Suspension Bushing	13581
13582	Torque Rod Bushing	11071, 18836
13594	Suspension Bushing	13623
13596	Beam End Bushing	13595
13607	Beam End Bushing	13595
13618	Torque Rod Bushing	18552
13628	Suspension Bushing	13581
13671	Suspension Bushing	13623
13672	Torque Rod Bushing	18836, 11071
13684	Torque Rod Bushing	13584, 18551, 18833, 40131

Tool For	Part Description	Tool Options / Part ID's
13685	Torque Rod Bushing	18551, 18833, 40131
14007	Torque Rod Bushing	18836, 40124
14008	Torque Rod Bushing	18836, 40124
14010	Torque Rod Bushing	18836, 40124
14073	Torque Rod Bushing	18836, 40124
14513	Beam End Bushing	14531
14514	Beam End Bushing	14531
14526	Center Bushing	14531
14533	Beam End Bushing	14531
14532	Beam End Bushing	13588
15013	Torque Rod Bushing	18836, 40124
18086	Break Isolator Bushing	40030
31000	Torque Rod Bushing	18835
31016	Torque Rod Bushing	18835
31087	Torque Rod Bushing	18831
31089	V-Stay Bushing	31091
31508	Torque Rod Bushing	18835
31579	Torque Rod Bushing	18835
31601	Torque Rod Bushing	18831
32001	Spring Bushing	18833
32007	Torque Rod Bushing	18835
32008	Torque Rod Bushing	18834
32009	V-Stay Repair Kit	18834
32020	Torque Rod Bushing	18834
32031	Torque Rod Bushing	18831
32032	Torque Rod Bushing	18833
32035	Torque Rod Bushing	18834
32044	Spring Bushing	18833
32048	Torque Rod Bushing	18835
32049	Torque Rod Bushing	18835
34512	Torque Rod Bushing	18836
34516	Cab Mount	18937
34517	Spring Bushing	18936
34519	Spring Bushing Kit	18936
34540	Cab Mount Kit	19837
50032	Control Arm Bushing Kit	50034
83520	Easy-Mount	18551, 18833
83522	Easy-Mount	18553, 18833
83596	Easy-Mount	18542, 13588

10076



Tool R & I
10075

11068



Tool R & I
11063

11069



Tool R & I
11005, 11083

11071



Tool Install
11004, 13521

11079Tool Install
11075**11730**Tool Install
11729**11731**Tool R & I
11509, 11511**11732**Tool R & I
11512, 11514**13563**Tool Install
13553**13564**Tool Install
13501, 13506**13569**Tool Install
13545, 13546**13570**Tool Install
13505**13572**Tool Install
13596**13581**Tool R & I
13510, 13565, 13628**13584**Tool R & I
13518**13585**Tool R & I
13514**13588**Tool Removal
13506, 13553**13595**Tool Install
13596, 13607**13622**Tool R & I
13599**13623**Tool R & I
13594**14531**Tool Install
14514**18051**Tool Install
13519**18539**Tool Install
13505**18540**Tool Removal
13505

Tools continued

18541



Tool Install
13501, 13506

18542



Tool for R & I
13501, 13506

18543



Tool Install
13500

18544



Tool Removal
13500

18551



Tool for R & I
13520

18552



Tool for R & I
11714

18553



Tool Install
13522

18831



Tool Mount
13514, 13515, 13532,
13533, 13536, 31087,
31601, 32031

18833



Tool Mount 11507, 11714,
11729, 13513, 13516, 13517,
13518, 13520, 13522, 13528,
32001, 32032, 32044

18834



Tool Mount
32008, 32009, 32020, 32035,
32056

18835



Tool Mount
31000, 31016, 31508, 31579,
32007, 32048, 32049, 32055

18836



Tool Mount
11063, 12051, 13521, 14007,
14008, 14010, 14073

18936



Tool Install
34517, 34519

18937



Tool Install
34516

31091



Tool R & I
31089

40030



Tool Install
12340, 18086

40090



Tool Install
11753, 11758,
11060, 11767

40093



Tool Install
11775, 11763

40132



Tool R & I
18821

50034



Tool R & I
50032

Cross Reference

OEM	Brand	Part Id	Page
002200	Transpro	15013	232
0048444	Bluebird	11144	239
004931	Hendrickson	34514	94
0115047000	Freightliner	11018	33
0115047000	Freightliner	11087	36
01153287	MCI	32014	247
0200377	Peterbilt	18566	200
0201154	Peterbilt	12375	197
020117451	Orion	13659	240
020117451U	Orion	13659	240
020117461	Orion	13513	239
020117461U	Orion	13513	239
02210	Dayton Parts	17501	281
02227720	Peterbilt	13536	199
02242	Dayton Parts	17504	282
02257	Dayton Parts	18992	285
0227710	Peterbilt	13522	199
0227710	Peterbilt	83522	201
0227720	Peterbilt	13520	198
0227720	Peterbilt	83520	201
0227723	Peterbilt	13528	199
0229610	Peterbilt	13518	198
026900	Reyco	14008	211
026900	Reyco	14073	211
0274056	Volvo	32008	272
0301674	Peterbilt	12350	195
0301675	Peterbilt	12351	195
0304059	Peterbilt	34554	200
0304327	Peterbilt	12395	198
0304627	Peterbilt	11550	193
0304627	Peterbilt	18244	200
0305101	Peterbilt	12354	195
0305108	Peterbilt	12398	198
0305198	Peterbilt	12398	198
0307015	Peterbilt	12354	195
0307016	Peterbilt	12350	195
035009	Sloan	17675	284
035010	Sloan	17674	284
03AL01	Peterbilt	12361	196
03AL02	Peterbilt	12362	196
03AL1	Peterbilt	12361	196
03AL2	Peterbilt	12362	196
0417003000	Freightliner	30504	45
049009990	Western Star	11533	278
049009996	Western Star	11520	278
049009996	Western Star	11523	278
049009997	Volvo	12301	259
049009997	Western Star	12301	278
049009997HARD	Western Star	12301	278
0508968	Peterbilt	11707	194
0508968	Peterbilt	12355	196
0508969	Peterbilt	11537	192
0508969	Peterbilt	11613	193
0510103	Peterbilt	11537	192
0510103	Peterbilt	11613	193
0510197	Peterbilt	12356	196
0514794	Peterbilt	11705	194
0515646	Peterbilt	11539	193
0515646	Peterbilt	11614	193
0515646	Peterbilt	11761	194
0516070000	Freightliner	11021	34
0516070000	Sterling Truck	11021	221
0516070000	Western Star	11021	277
0516401	Peterbilt	11537	192
0516401	Peterbilt	11613	193
0516919	Peterbilt	18102	200
0518263	Peterbilt	18786	200
0550800	MCI	32032	248
064200	Reyco	14000	210
064902	Reyco	15054	213

OEM	Brand	Part Id	Page
064902	Transpro	15054	233
06664000L	Hendrickson	13500	79
06966000	Hendrickson	13659	89
06969000L	Hendrickson	13501	80
0702552	Peterbilt	12366	197
0703286	Peterbilt	11520	192
0703286	Peterbilt	11523	192
076800	Reyco	14000	210
077000	Reyco	14001	210
08181008	MCI	30516	242
0836301	Reyco	15001	212
086301	Batco	13534	83, 120
0891501	Reyco	15000	212
090600	Reyco	14003	211
091000	Reyco	14522	211
091200	Reyco	14521	211
091218	Batco	14001	210, 230
092247	Batco	14003	55, 100, 211, 231
092274	Batco	13037	54, 230, 275
09228202	Batco	15061	125, 214, 233
092360	Batco	15064	44, 171, 214, 224, 233
092478	Batco	14002	210
092497	Batco	14010	15, 94, 155, 211, 231
092600	Reyco	14532	212
092836	Batco	15059	214
093000	Reyco	14504	211
093341	Batco	14011	100, 231
093344	Batco	14008	55, 100, 199, 211, 231, 263, 275
093344	Batco	14073	55, 102, 211, 231, 275
093351	Batco	14000	55, 100, 210, 230
093365	Batco	14027	101, 231
093366	Batco	14027	101, 231
093400	Reyco	14509	211
094410	Batco	14504	124, 184, 211, 240
094420	Batco	14500	184
094422	Batco	14521	185, 211, 232, 275
094424	Batco	14522	185, 211, 232, 275
094429	Batco	14501	184
094433	Batco	14509	184, 211
094438	Batco	14505	184
094870	Batco	14502	184
094871	Batco	14502	184
095017	Batco	13526	14, 82, 169
095018	Batco	13512	14, 81
095097	Batco	13524	82, 210
095184	Batco	13527	82
095420	Batco	13683	43, 90, 122, 308
095422	Batco	13686	43, 91, 122, 262, 309
095424	Batco	13691	43, 91, 123, 262, 309
095426	Batco	13695	43, 92, 123, 184, 263, 310
095429	Batco	13697	43, 92, 123, 263, 310
095430	Batco	13699	59, 92, 123, 310
095431	Batco	13690	59, 91, 122, 309
095431	Batco	13691	43, 91, 123, 262, 309
095432	Batco	13692	59, 91, 123, 309
095433	Batco	13694	43, 92, 123, 262, 310
095434	Batco	13698	59, 92, 123, 310
095435	Batco	13696	43, 92, 123, 263, 310
095450	Batco	13658	89
095451	Batco	13546	84
095460	Batco	13560	85

Cross Reference continued

OEM	Brand	Part Id	Page
095461	Batco	13610	88, 121
095462	Batco	13609	14, 87, 121, 183, 210
095470	Batco	13544	84
095471	Batco	13545	84, 120
095472	Batco	13547	84, 120
095494	Batco	13659	89, 240
095495	Batco	13610	88, 121
095500	Batco	13500	13, 58, 79, 118, 217, 260
095501	Batco	13501	13, 58, 80, 118, 217, 230, 260
095510	Batco	13505	14, 58, 80, 118, 230, 261
095511	Batco	13553	14, 58, 85, 120, 155, 210, 217, 230, 261
095512	Batco	13505	14, 58, 80, 118, 230, 261
095513	Batco	13505	14, 58, 80, 118, 230, 261
095514	Batco	13543	14, 84, 210, 261
095518	Batco	13515	81, 119, 154, 183
095519	Batco	13514	81, 118, 154, 198
095524	Batco	13607	59, 87, 121
095525	Batco	13596	87
095525	Batco	83596	8, 62, 95, 136
095528	Batco	13607	59, 87, 121
095532	Batco	13650	15, 59, 89, 122, 262
095535	Batco	13592	14, 58, 86, 121, 262
095536	Batco	13650	15, 59, 89, 122, 262
095537	Batco	13650	15, 59, 89, 122, 262
095620	Batco	13537	14, 83, 261
095621	Batco	13543	14, 84, 210, 261
095674	Batco	13562	85
095690	Batco	13649	15, 89, 122, 170
095716	Batco	13516	81, 119, 183
095719	Batco	12031	13, 79, 117, 165
095720	Batco	13684	90, 122, 183
095721	Batco	13518	81, 119, 154, 183, 198, 261
095721	Batco	13533	83, 120, 183, 261, 279
095723	Batco	13520	5, 82, 119, 154, 169, 198, 239, 261, 279
095723	Batco	13536	5, 83, 120, 155, 169, 199, 239, 279
095723	Batco	83520	7, 95, 136, 157, 172, 201, 218, 251, 280
095728	Batco	13553	14, 58, 85, 120, 155, 210, 217, 230, 261
095804	Batco	13688	91, 309
095807	Batco	13701	92, 124, 310
095809	Batco	13687	91, 309
095813	Batco	13703	93, 124, 311
096100	Batco	13601	87, 121
096100	Batco	13721	93, 124
096100	Batco	13722	8, 93, 124
096110	Batco	13625	88
096241	Batco	13542	84, 120
096516	Batco	11005	12, 32, 115
096540	Batco	11001	32, 258
096851	Batco	13577	120
097160	Batco	11550	147, 193
097241	Batco	11512	144
097241	Batco	11514	144
097241	Batco	11735	4, 150
0972901	Batco	15013	94, 125, 213, 232, 264
0972901	Batco	15013	94, 125, 213, 232, 264
0972901	Reyco	15013	213

OEM	Brand	Part Id	Page
097301	Batco	15018	264
097579	Batco	12015	164, 258
097581	Batco	12028	165
097583	Batco	12015	164, 258
097586	Batco	12009	164
097593	Batco	12006	164
097593	Batco	12040	166
097594	Batco	12014	164
097595	Batco	12010	164
097596	Batco	12009	164
097597	Batco	12053	167
097598	Batco	12014	164
097599	Batco	12009	164
097838	Batco	19002	218
097839	Batco	19003	200, 218
097840	Batco	19005	218
097852	Batco	11500	143, 217
097852	Batco	19004	157, 218
1000035	Eaton	17538	284
10017B	Tectran	17674	284
10017R	Tectran	17675	284
1002248	Eaton	17682	285
10029	Haldex	17676	285
1003	Reyco	13553	210
10050	Watson & Chalin	14513	275
1008412	Eaton	17678	285
1008412	Eaton	17682	285
101007PU	Westar	11000	31
101007PU	Westar	11064	34
101010	Westar	11005	12, 32, 115
101059PU	Westar	11085	35
101059PU	Westar	11725	41
101059PU	Westar	18232	61, 265
101067PU	Westar	11008	32, 220
101114	Tectran	17676	285
101115B	Tectran	17674	284
101115R	Tectran	17675	284
101118	Tectran	17676	285
1027037	Page	13501	230
1027038	Page	13553	230
10363	Hendrickson	13545	84
10363	Hendrickson	13586	86
10363000	Hendrickson	13545	84
10363L	Hendrickson	13545	84
10364	Hendrickson	13546	84
10364000	Hendrickson	13546	84
10366	Hendrickson	13544	84
10366000	Hendrickson	13544	84
10366L	Hendrickson	13544	84
1037261C001	Peterbilt	19003	200
1037261C002	Ridewell	19003	218
1037326D003	Ridewell	19002	218
1075255	Volvo	31089	271
1083483	Page	14521	232
1089501	Volvo	12333	260
1090237	Page	14510	231
10QK1065A	Mack	12039	166
10QK130P1	Mack	12028	165
10QK130P1	Mack	12038	166
10QK219	Mack	12029	165
10QK219P1	Mack	12029	165
10QK219P2	Mack	12015	164
10QK219P2	Mack	12037	166
10QK222	Mack	13649	170
10QK231	Mack	15009	170
10QK253M	Mack	12043	166
10QK254M	Mack	12041	166
10QK260	Mack	13513	169
10QK268M	Mack	13526	169
10QK269AM	Mack	11747	163

Cross Reference continued

OEM	Brand	Part Id	Page	OEM	Brand	Part Id	Page
10QK276	Mack	12015	164	1225R1058	Arvin Meritor	18991	6
10QK276	Mack	12037	166	1225R1370	Arvin Meritor	34514	6
10QK32BP1	Mack	12053	167	1225R1370	Arvin Meritor	50032	6
10QK365A	Mack	12006	164	1225X804	Arvin Meritor	18439	6
10QK365A	Mack	12040	166	12387455	GMC	13607	59
10QK36B	Mack	12014	164	12477594	GMC	83596	62
10QK36B	Mack	12036	165	124865R1	International	13501	118
10QK36C	Mack	12014	164	124892R1	International	13553	120
10QK370	Mack	12010	164	124901R91	International	13505	118
10QK370	Mack	12036	165	125123	MCI	30507	242
10QK372	Mack	12009	164	125123A	MCI	30507	242
10QK372	Mack	12040	166	127000	Reyco	13609	210
10QK388	Mack	12014	164	12855	Trailmobile	14008	231
10QK389	Mack	12009	164	12855	Trailmobile	14073	231
10QK389	Mack	12040	166	12G15	MCI	18437	240
10QK86B	Mack	12014	164	12G15	MCI	32014	247
10QK86B	Mack	12039	166	12J1133	MCI	33502	250
1100608B000	Ridewell	11500	217	12J126	MCI	33503	250
1100608B000	Ridewell	19004	218	12J135	MCI	33503	250
11008	Dana	17538	284	12J135	MCI	18820	241
11019	Dana	17503	282	12J584	MCI	18814	241
110222	Hendrickson	13505	80	12L52	MCI	18010	240
110222	Hendrickson	13548	84	12L594	MCI	13528	239
1109569000	Freightliner	11001	32	1301633	Peterbilt	11554	193
1110512B000	Ridewell	19005	218	130310B000	Ridewell	12044	217
1110512B000	Ridewell	19008	218	1303440	Peterbilt	12367	197
1110594B000	Ridewell	13501	217	1303510	Peterbilt	12359	196
11115	Freightliner	11115	38	1303593	Peterbilt	12363	196
11118	Freightliner	11118	39	1304154	Peterbilt	12370	197
1114701	Reyco	15059	214	13043	Stemco Gaff	13043	315
1116755B000	Ridewell	13553	217	1304711	Peterbilt	12364	197
1117379B000	Ridewell	83520	218	1307564B000	Ridewell	13507	217
1117558B000	Ridewell	13500	217	1353440	Bluebird	19001	242
1117564B001	Ridewell	13553	217	13590	Hardware	12379	307
1117680B060	Ridewell	11711	217	1362710	Volvo	32044	273
1117680B060	Sterling Truck	11711	223	13680	Hardware	13680	308
1117680B070	Ridewell	11711	217	13681	Hardware	12379	307
1117680B070	Sterling Truck	11711	223	13681	Hardware	13681	308
1117680B075	Ridewell	11711	217	13682	Hardware	12379	307
11223	Watson & Chalin	14533	275	13682	Hardware	13682	308
1135700	Hutchens	14027	101	13707	Hardware	13707	311
1138983	Mcneilus	13721	93, 124	13708	Hardware	13708	311
1138983	Mcneilus	13722	8, 93, 124	1380501	Reyco	18956	214
119569	Freightliner	11001	32	1394501	Reyco	14010	211
119569	Volvo	11001	258	14003022	International	10004	112
12001005	MCI	32014	247	14003030	International	10505	115
120040007	Volvo	10075	258	14003052	International	10505	115
120043401	Western Star	11520	278	14004200	International	10004	112
120043401	Western Star	11523	278	1414656	Peterbilt	12357	196
120043402	Western Star	12301	278	1414656	Peterbilt	12381	198
120043402SOFT	Western Star	12301	278	1433901	Reyco	13553	210
120050001	Volvo	12304	259	1435401	Reyco	13502	210
120050002	Volvo	12305	259	14628201	Reyco	15000	212
120050002	Western Star	12305	278	1471301	Reyco	15001	212
120053207	Autocar	12304	7	14994568	GMC	18698	61
120053207	Volvo	12304	259	14994876	GMC	18693	61
120053208	Autocar	12305	7	14B656	Dynaflex	12357	196
120053208	Volvo	12305	259	14B656	Dynaflex	12381	198
120053403	Western Star	18102	279	14QK136	Mack	18566	171
120161	Phillips	17674	284	15002	Chalmers	11740	10
120162	Phillips	17675	284	1506314	GMC	18847	62
120163	Phillips	17676	285	151087148	Freightliner	11556	40
120163	Severson	17676	285	151087148	Freightliner	13522	42
12051002	MCI	32031	247	151087148	Freightliner	83522	46
12051013	MCI	31601	245	151087148	Freightliner	11003	32
12051019	MCI	31602	245	15109	Trailmobile	17574	234
1225B834	Arvin Meritor	17504	5	151203PU	Westar	13005	54
1225L1208	Arvin Meritor	17501	5	151204	Westar	13011	54, 229
1225N378	Arvin Meritor	17538	5	151217	Westar	13042	55, 100, 230
1225R1058	Arvin Meritor	17529	5	1515190371	Isuzu	18830	96

Cross Reference continued

OEM	Brand	Part Id	Page
1515190412	Isuzu	18830	96
1515191130	Isuzu	18830	96
1515966C1	International	11739	117
1516350C91	International	12074	117
1516350C92	International	12074	117
15209	Trailmobile	14008	231
15209	Trailmobile	14073	231
15464	Hendrickson	13658	89
15464000	Hendrickson	13658	89
15506936	GMC	18222	61
15506936	Volvo	18222	265
15512196	GMC	40074	62
15533680	GMC	13500	58
15533787	GMC	13553	58
15533801	GMC	13690	59
15533803	GMC	13692	59
15533809	GMC	13698	59
15533810	GMC	13699	59
15624948	GMC	16035	60
15664483	GMC	17501	56
1577873	Volvo	12333	260
15898	Trailmobile	14522	232
1591689	Volvo	31089	271
15963119	GMC	11747	58
16005305	International	12329	118
16012	Tectran	17676	285
16013	Tectran	17674	284
16015	Tectran	17675	284
16064	Dana	17500	281
1607727C1	International	15001	125
1609501	Reyco	14002	210
1610549000	Freightliner	11064	34
1611351000	Freightliner	11002	32
1611872C91	International	13610	121
1611890000	Freightliner	18600	45
1611890001	Freightliner	18600	45
1612302000	Freightliner	18600	45
1612373000	Freightliner	18600	45
1612399000	Freightliner	18600	45
1613470000	Freightliner	18600	45
1613568000	Freightliner	11000	31
1613568000	Freightliner	11064	34
1613962000	Freightliner	11005	32
1614601	Hutchens	14038	102
1614603000	Freightliner	11094	36
1615632000	Freightliner	11152	40
1616412000	Freightliner	11083	35
1616412001	Freightliner	11083	35
1616749000	Freightliner	11153	40
1616749001	Freightliner	11078	35
1616749002	Freightliner	11081	35
1617194000	Freightliner	11094	36
161776900	Freightliner	11066	34
1617770000	Freightliner	11094	36
1618023000	Freightliner	11094	36
1618035000	Freightliner	11005	32
1618035000	Freightliner	11083	35
1618972000	Freightliner	11081	35
1618972000	Freightliner	11152	40
1620750	Volvo	31093	271
16215	Trailmobile	14521	232
1622375C1	International	11747	117
162426	Cummins Engine	17506	282
162426	International	17506	126
16571	Trailmobile	15016	232
16592	Trailmobile	14011	231
1661925C91	International	11751	117
16640	Trailmobile	15008	232
1664223C1	International	19001	127
1664723C1	International	34509	133

OEM	Brand	Part Id	Page
1664723C1	International	34526	134
1664723C2	International	34509	133
1664723C2	International	34526	134
1664723C3	International	34509	133
1664723C3	International	34526	134
1664724C1	International	34509	133
1664724C2	International	34509	133
1664724C3	International	34509	133
1664726C2	International	34507	132
1664728C1	International	34500	132
1664728C1	International	34524	134
1664728C2	International	34500	132
1664728C2	International	34524	134
1664729C1	International	34510	133
1664729C1	International	34525	134
1664729C2	International	34510	133
1664729C2	International	34525	134
1664729C3	International	34510	133
1664729C3	International	34525	134
1664729C4	International	34510	133
1664729C4	International	34525	134
1664729C5	International	34510	133
1664729C5	International	34525	134
1664729C7	International	34510	133
1664729C7	International	34525	134
1664730C5	International	34507	132
1664730C5	International	34510	133
1664730C5	International	34525	134
1664730C7	International	34507	132
1664730C7	International	34510	133
1664730C7	International	34525	134
1671766C1	International	19001	127
1672608C1	International	13656	122
16776	Miscellaneous	18961	325
1680033C1	International	19001	127
1685916C1	International	10026	114
1688227710	Mack	13522	169
1688227710	Mack	83522	172
1688227720	Mack	13520	169
1688227720	Mack	13536	169
1688227720	Mack	83520	172
1688229240	Mack	12031	165
16899930C91	International	10506	115
1691033C91	International	13690	122
1691035C91	International	13692	123
1691140C91	International	83596	136
1691529C2	International	17501	126
1693060C1	International	13522	119
1693060C1	International	83522	136
1693061C1	International	13520	119
1693061C1	International	13536	120
1693061C1	International	83520	136
1693063C1	International	13528	119
1693064C1	International	12031	117
1693065C1	International	13684	122
1693066C1	International	13518	119
1693066C1	International	13533	120
1693069C1	International	13516	119
1693070C1	International	13517	119
1693531C1	International	13683	122
1693533C1	International	13686	122
1693535C1	International	13699	123
1693536C1	International	13691	123
1693537C1	International	12044	117
1693537C1	International	13691	123
1693542C1	International	13694	123
1693543C1	International	13695	123
1693544C1	International	13696	123
1693545C1	International	13697	123
1693546C1	International	13698	123

Cross Reference continued

OEM	Brand	Part Id	Page
1693550C1	International	13700	124
1693550C1	International	13701	124
1693559C1	International	13703	124
1694129C1	International	13685	122
1697129C91	International	11758	117
1697717	International	13607	121
1697717C91	International	13607	121
1699929C9	International	10506	115
17012	Watson & Chalin	14008	275
17012	Watson & Chalin	14073	275
1710	Spicer	40075	6, 17, 46, 62, 96, 136, 157, 172, 201, 225, 274
1712434000	Freightliner	11096	37
1712434000	Freightliner	11102	37
1712435000	Freightliner	11104	37
1712435001	Freightliner	11105	37
1712438000	Freightliner	11134	39
1714667	Volvo/White/GMC	13537	261
1714668	Volvo	13543	261
1714668	Volvo/White/GMC	13543	261
1714781000	Freightliner	11109	38
1714781000	Hino	11109	96
1714781000	Sterling Truck	11109	222
1714781000	Western Star	11109	278
1715553000	Freightliner	11107	38
1715553001	Freightliner	11106	37
171780	Miscellaneous	30517	128
171843	Freightliner	11095	36
171AM8	Mack	12043	166
1721201	Reyco	13543	210
1725756601	Hino	18830	96
17408503	International	10010	112
17QF251P11	Mack	12072	168
17QF261P23	Mack	12071	168
17QF352M2	Mack	12071	168
17QF357M	Mack	13735	170
17QF358	Mack	12070	168
17QF359	Mack	12070	168
17QF455P240	Mack	11080	162
17QF455P243	Mack	13733	170
17QF457P238	Mack	12074	168
17QF460P200	Mack	12070	168
17QF460P210	Mack	12069	168
17QF460P215	Mack	12073	168
17QF460P220	Mack	13634	170
17QF460P238	Mack	12074	168
17QF460P240	Mack	11751	163
17QF460P243	Mack	12071	168
17QF463P180	Mack	12072	168
17QF464P180	Mack	12072	168
17QF471M5	Mack	13597	169
17QF473M	Mack	12070	168
17QF473M2	Mack	12069	168
17QF473M4	Mack	12071	168
17QF474P209	Mack	12069	168
17QM263A	Mack	11109	162
1810	Spicer	40074	6, 8, 17, 46, 62, 136, 157, 172, 200, 274
1811	International	10503	115
1844009000	Freightliner	11110	38
1844009000	Freightliner	11075	35
1844009000	Freightliner	11110	38
1845384000	Freightliner	11110	38
1845384000	Freightliner	11075	35
1845384000	Freightliner	11110	38
19204	Watson & Chalin	34514	275
19279	Hendrickson	13592	86
1958009	MCI	32032	248
19682	Watson & Chalin	34514	275

OEM	Brand	Part Id	Page
19875340	GMC	18760	62
1RY39307P13	Mack	11751	163
1RY48P23	Mack	12072	168
1T18197A	Ford	30507	16
2008257	Peterbilt	12360	196
2008867	Peterbilt	12360	196
20105120	Hendrickson	13665	90
20147772C2	International	34525	134
2014777C2	International	34507	132
2014777C2	International	34510	133
2024801	Hutchens	14027	101
2028153	Arvin Meritor	34514	6
203SJ13	Mack	40074	172
2044403A	GMC/RTS/Nova	33506	250
204SX216	Mack	12034	165
204SX389	Mack	12035	165
20800	Westar	13507	80, 182, 217
20801	Westar	13609	14, 87, 121, 183, 210
20802	Westar	13502	80, 118, 210
20803	Westar	13610	88, 121
20805	Westar	13610	88, 121
20806	Westar	13547	84, 120
20809PU	Westar	13501	13, 58, 80, 118, 217, 230, 260
20810PU	Westar	13553	14, 58, 85, 120, 155, 210, 217, 230, 261
20813	Westar	13545	84, 120
20814	Westar	13546	84
20816	Hendrickson	13500	79
20817	Westar	13505	14, 58, 80, 118, 230, 261
20818	Westar	13544	84
20820	Westar	13543	14, 84, 210, 261
20823	Westar	13649	15, 89, 122, 170
20824	Westar	13650	15, 59, 89, 122, 262
20826PU	Westar	13650	15, 59, 89, 122, 262
20831PU	Westar	13518	81, 119, 154, 183, 198, 261
20831PU	Westar	13533	83, 120, 183, 261, 279
20832PU	Westar	13522	42, 82, 119, 154, 169, 199, 261
20832PU	Westar	83522	46, 95, 136, 157, 172, 201, 274
20833PU	Westar	13520	5, 82, 119, 154, 169, 198, 239, 261, 279
20833PU	Westar	13536	5, 83, 120, 155, 169, 199, 239, 279
20833PU	Westar	83520	7, 95, 136, 157, 172, 201, 218, 251, 280
20834	Westar	13517	81, 119, 183
20836PU	Westar	11004	32, 77, 115, 142, 162, 192
20836PU	Westar	13521	42, 82, 119, 154, 169, 198
20843	Westar	13512	14, 81
20847	Westar	13665	90
20850	Westar	13514	81, 118, 154, 198
20851PU	Westar	13528	83, 119, 154, 183, 199, 239
20859	Westar	13596	87
20859	Westar	83596	8, 62, 95, 136
20860	Westar	13534	83, 120
20860	Westar	13558	85
20861	Westar	13607	59, 87, 121
20876	Westar	13516	81, 119, 183
20885	Westar	13515	81, 119, 154, 183
209015	Westar	13687	91, 309
209016	Westar	13688	91, 309

Cross Reference continued

OEM	Brand	Part Id	Page
209017	Westar	13701	92, 124, 310
209022	Westar	13697	43, 92, 123, 263, 310
209023	Westar	13695	43, 92, 123, 184, 263, 310
209026	Westar	13699	59, 92, 123, 310
209031	Westar	13692	59, 91, 123, 309
209031	Westar	13693	91, 309
209032	Westar	13696	43, 92, 123, 263, 310
209033	Westar	13694	43, 92, 123, 262, 310
209034	Westar	13690	59, 91, 122, 309
209036	Westar	13698	59, 92, 123, 310
20914	Westar	13672	90
20914043	Carrier Corp.	50055	301
20914159	Carrier Corp.	12380	300
20917709	Carrier Corp.	50056	301
20991433	Carrier Corp.	50053	301
20QL1118A	Mack	12000	163
20QL1166	Mack	12017	164
20QL1170	Mack	12048	167
20QL1175	Mack	12000	163
20QL2101	Mack	12004	163
20QL2110	Mack	12002	163
20QL231P1	Mack	11544	162
20QL231P1	Mack	18837	171
20QL231P12	Mack	18837	171
20QL251	Mack	12048	167
20QL258	Mack	12002	163
20QL259A	Mack	12032	165
20QL295	Mack	12026	165
20QL295M	Mack	12026	165
20QL312M2	Mack	12046	167
20QL312M2	Mack	12047	167
20QL322	Mack	12045	166
20QL324M	Mack	12023	164
20QL329	Mack	12045	166
20QL338M	Mack	12372	168
20QL37P3	Mack	12049	167
2101211X	Hino	40075	96
2101211X	International	40075	136
2101211X	Kenworth	40075	157
2101211X	Mack	40075	172
2101211X	Neapco	40075	6, 17, 46, 62, 96, 136, 157, 172, 201, 225, 274
2101211X	Peterbilt	40075	201
2101211X	Spicer	40075	6, 17, 46, 62, 96, 136, 157, 172, 201, 225, 274
2101211X	Sterling Truck	40075	225
2101211X	Volvo/White/GMC	40075	274
2106611X	Arvin Meritor	40074	6
2106611X	Autocar	40074	8
2106611X	Kenworth	40074	157
2106611X	Mack	40074	172
2106611X	Peterbilt	40074	200
2106611X	Spicer	40074	6, 8, 17, 46, 62, 136, 157, 172, 200, 274
2106611X	Volvo/White/GMC	40074	274
21140033	Hendrickson	13610	88
21140034	Hendrickson	13609	87
2114033	Hendrickson	13610	88
2114033L	Hendrickson	13610	88
2114034	Hendrickson	13609	87
211407	Hendrickson	13586	86
2123801	Reyco	15020	213
22200	Hutchens	14011	100
2221405	Therco	11753	151
222606	International	10022	113

OEM	Brand	Part Id	Page
22279000L	Hendrickson	13537	83
22282000L	Hendrickson	13543	84
22904	Westar	13594	87
22QK39301	Mack	12041	166
2313857	Peterbilt	12365	197
233432R91	International	13545	120
2350908U	GMC/RTS/Nova	30507	242
24209000	Hendrickson	13649	89
24SU21	Mack	31592	171
24SU24	MCI	14504	240
2501596C1	International	13601	121
2506180C91	International	13601	121
2506180C91	International	13721	124
2506180C91	International	13722	124
2507714C1	International	14513	125
2507718C1	International	14533	125
25705PU	Westar	14000	55, 100, 210, 230
25706PU	Westar	14038	102
25708PU	Westar	14008	55, 100, 199, 211, 231, 263, 275
25708PU	Westar	14073	55, 102, 211, 231, 275
25741PU	Westar	14011	100, 231
25750PU	Westar	13001	54, 100, 229
25750PU	Westar	14003	55, 100, 211, 231
25828	Westar	14027	101, 231
258892C91	International	13542	120
2591050C91	International	40075	136
25QM31	Mack	11545	162
267322	Kenworth	18949	156
26953000	Hendrickson	13650	89
270203C1	International	18063	126
271191	Bendix	17500	281
271197	Dana	17529	283
271197	Dana	18991	285
281236	Dana	17574	234
281238	Dana	17682	285
281241	Dana	17504	282
283069C93	International	40075	136
283071C93	International	40074	136
283983	Barry Controls	34528	134
286235C2	International	34505	132
286236C2	International	34506	132
294815	Hendrickson	13500	79
29483005	Hendrickson	13656	89
294835	Hendrickson	13505	80
294835	Hendrickson	13548	84
29741117680B060	Mack	11711	162
29741117680B070	Mack	11711	162
29741117680B075	Mack	11711	162
298781	Hendrickson	13553	85
301302	Westar	13513	169, 239
301302	Westar	13577	120
301356PU	Westar	10011	112
301357PU	Westar	10020	31, 113
301358PU	Westar	10026	114
301369PU	Westar	10503	115
301372PU	Westar	10505	115
301373PU	Westar	10014	113
301378PU	Westar	10012	113
301378PU	Westar	10013	113
301379PU	Westar	34505	132
301380PU	Westar	34506	132
301382	Westar	10000	4, 112
301384PU	Westar	10075	12, 114, 258
302001	Energy Suspension	12350	195
302002	Energy Suspension	12351	195
304005	Energy Suspension	12359	196
304011	Energy Suspension	11537	40, 146, 192
304011	Energy Suspension	11613	41, 148, 193

Cross Reference continued

OEM	Brand	Part Id	Page
304015	Energy Suspension	12360	196
304016	Energy Suspension	12364	197
304020	Energy Suspension	12370	197
30437000	Hendrickson	13558	85
30437000L	Hendrickson	13534	83
30437L	Hendrickson	13558	85
3065BSH109L	Mack	10079	162
3065BSH172U	Mack	10079	162
3081657	Volvo	10075	258
3088K3399	Mack	11611	162
3090971	Volvo	12333	260
30QS3479AM	Mack	12052	167
30SQ4525	Mack	18860	171
312002	Energy Suspension	12015	164, 258
31216	Trailmobile	14004	231
31219	Trailmobile	14008	231
31219	Trailmobile	14073	231
31220	Trailmobile	15017	232
31232	Trailmobile	14001	230
31235	Trailmobile	14008	231
31235	Trailmobile	14073	231
3126	Trailmobile	14004	231
3133712	Volvo	13566	262
31339	Trailmobile	14003	231
3155101	Dorman	10506	298
3155401	Dorman	12365	300
3155402	Dorman	11543	300
3173759	Volvo	31089	271
3187322	Autocar	18860	8
3187322	Volvo	18860	265
3187322	Volvo/White/GMC	18860	265
320108	Dayton Parts	12350	195
320108U	Dayton Parts	12350	195
320110	Dayton Parts	16000	59
320132	Dayton Parts	12354	195
320150	Dayton Parts	11502	143
320150	Dayton Parts	11719	149
320150U	Dayton Parts	11502	143
320150U	Dayton Parts	11719	149
320153	Dayton Parts	18566	44, 56, 127, 156, 171, 186, 200, 279
320153U	Dayton Parts	18566	44, 56, 127, 156, 171, 186, 200, 279
320155	Dayton Parts	18851	295
320155U	Dayton Parts	18851	295
320161U	Dayton Parts	18575	294
320164U	Dayton Parts	18574	294
320165U	Dayton Parts	18558	234, 294
320177U	Dayton Parts	11002	32
320178	Dayton Parts	11550	147, 193
320178	Dayton Parts	18244	156, 200, 234
320178U	Dayton Parts	11550	147, 193
320178UB	Dayton Parts	18244	156, 200, 234
320182	Dayton Parts	18256	234
320182U	Dayton Parts	18256	234
320200	Dayton Parts	11720	149
320200A	Dayton Parts	11720	149
320200U	Dayton Parts	11720	149
320203	Dayton Parts	11733	150
320203	Dayton Parts	11734	150
320203	Dayton Parts	11766	152
320208	Dayton Parts	11743	150
32080017	Miscellaneous	18762	325
3208015	Miscellaneous	18705	323
321101	Energy Suspension	11535	146
321103	Energy Suspension	11539	146, 193
321103	Energy Suspension	11614	148, 193
321103	Energy Suspension	11761	151, 194
321104	Energy Suspension	11537	40, 146, 192
321104	Energy Suspension	11613	41, 148, 193

OEM	Brand	Part Id	Page
321117	Dayton Parts	13500	13, 58, 79, 118, 217, 260
321118	Dayton Parts	13537	14, 83, 261
321118U	Dayton Parts	13537	14, 83, 261
321119	Dayton Parts	13500	13, 58, 79, 118, 217, 260
321120	Dayton Parts	13501	13, 58, 80, 118, 217, 230, 260
321120U	Dayton Parts	13501	13, 58, 80, 118, 217, 230, 260
321122	Dayton Parts	13505	14, 58, 80, 118, 230, 261
321123	Dayton Parts	13543	14, 84, 210, 261
321123U	Dayton Parts	13543	14, 84, 210, 261
321124	Dayton Parts	13505	14, 58, 80, 118, 230, 261
321125	Dayton Parts	13592	14, 58, 86, 121, 262
321125U	Dayton Parts	13592	14, 58, 86, 121, 262
321126	Dayton Parts	13553	14, 58, 85, 120, 155, 210, 217, 230, 261
321126U	Dayton Parts	13553	14, 58, 85, 120, 155, 210, 217, 230, 261
321127	Dayton Parts	13560	85
321127U	Dayton Parts	13560	85
321128	Dayton Parts	13544	84
321129	Dayton Parts	13545	84, 120
321131	Dayton Parts	13522	42, 82, 119, 154, 169, 199, 261
321131	Dayton Parts	83522	46, 95, 136, 157, 172, 201, 274
321131U	Dayton Parts	13522	42, 82, 119, 154, 169, 199, 261
321131U	Dayton Parts	83522	46, 95, 136, 157, 172, 201, 274
321132	Dayton Parts	13520	5, 82, 119, 154, 169, 198, 239, 261, 279
321132	Dayton Parts	83520	7, 95, 136, 157, 172, 201, 218, 251, 280
321132U	Dayton Parts	13520	5, 82, 119, 154, 169, 198, 239, 261, 279
321132U	Dayton Parts	13536	5, 83, 120, 155, 169, 199, 239, 279
321132U	Dayton Parts	83520	7, 95, 136, 157, 172, 201, 218, 251, 280
321133	Dayton Parts	13518	81, 119, 154, 183, 198, 261
321133U	Dayton Parts	13518	81, 119, 154, 183, 198, 261
321134	Dayton Parts	13684	90, 122, 183
321135	Dayton Parts	13517	81, 119, 183
321136	Dayton Parts	12031	13, 79, 117, 165
321136U	Dayton Parts	12031	13, 79, 117, 165
321137	Dayton Parts	13516	81, 119, 183
321141	Dayton Parts	13514	81, 118, 154, 198
321141U	Dayton Parts	13514	81, 118, 154, 198
321144	Dayton Parts	13515	81, 119, 154, 183
321144U	Dayton Parts	13515	81, 119, 154, 183
321145	Dayton Parts	15011	213
321145	Dayton Parts	15019	213
321145	Dayton Parts	15073	214
321145U	Dayton Parts	15011	213
321145U	Dayton Parts	15019	213
321145U	Dayton Parts	15073	214
321146U	Dayton Parts	15016	213, 232
321147	Dayton Parts	15051	213, 233
321147U	Dayton Parts	15051	213, 233
321149	Dayton Parts	15005	212
321149U	Dayton Parts	15005	212
321152	Dayton Parts	15001	125, 212
321153	Dayton Parts	15013	94, 125, 213, 232, 264

Cross Reference continued

OEM	Brand	Part Id	Page
321153U	Dayton Parts	15013	94, 125, 213, 232, 264
321154U	Dayton Parts	15017	213, 232, 264
321157U	Dayton Parts	15009	170, 212
321158	Dayton Parts	15008	125, 212, 232
321158U	Dayton Parts	15008	125, 212, 232
321159	Dayton Parts	15000	212
321162	Dayton Parts	14010	15, 94, 155, 211, 231
321173U	Dayton Parts	14011	100, 231
321175	Dayton Parts	14008	55, 100, 199, 211, 231, 263, 275
321175	Dayton Parts	14073	55, 102, 211, 231, 275
321175U	Dayton Parts	14008	55, 100, 199, 211, 231, 263, 275
321175U	Dayton Parts	14073	55, 102, 211, 231, 275
321176U	Dayton Parts	14000	55, 100, 210, 230
321177	Dayton Parts	13001	54, 100, 229
321177U	Dayton Parts	13001	54, 100, 229
321177U	Dyco	14003	55, 100, 211, 231
321178	Dayton Parts	14532	186, 212
321186	Dayton Parts	10000	4, 112
321190	Dayton Parts	13005	54
321190U	Dayton Parts	13005	54
321191	Dayton Parts	15001	125, 212
321191U	Dayton Parts	15001	125, 212
321193	Dayton Parts	14002	210
321194	Dayton Parts	15054	213, 233
321194U	Dayton Parts	15054	213, 233
321195	Dayton Parts	13577	120
321195U	Dayton Parts	13577	120
321220	Dayton Parts	14001	210, 230
321221U	Dayton Parts	14038	102
321223	Dayton Parts	11004	32, 77, 115, 142, 162, 192
321223	Dayton Parts	13521	42, 82, 119, 154, 169, 198
321223U	Dayton Parts	11004	32, 77, 115, 142, 162, 192
321223U	Dayton Parts	13521	42, 82, 119, 154, 169, 198
321225	Dayton Parts	13526	14, 82, 169
321225U	Dayton Parts	13526	14, 82, 169
321227	Dayton Parts	14510	184, 231
321227U	Dayton Parts	14510	184, 231
321228	Dayton Parts	14526	185
321229	Dayton Parts	14513	44, 55, 125, 170, 185, 223, 232, 263, 275
321229U	Dayton Parts	14513	44, 55, 125, 170, 185, 223, 232, 263, 275
321231	Dayton Parts	14529	55, 186
321231	Dayton Parts	14533	44, 125, 170, 186, 223, 232, 263, 275
321231U	Dayton Parts	14533	44, 125, 170, 186, 223, 232, 263, 275
321237	Dayton Parts	14527	125, 185
321237U	Dayton Parts	14527	125, 185
321241	Dayton Parts	15018	264
321242	Dayton Parts	13553	14, 58, 85, 120, 155, 210, 217, 230, 261
321243	Dayton Parts	13505	14, 58, 80, 118, 230, 261
321244	Dayton Parts	13543	14, 84, 210, 261
321245	Dayton Parts	13526	14, 82, 169
321245U	Dayton Parts	13526	14, 82, 169
321246	Dayton Parts	13512	14, 81
321265	Dayton Parts	13528	83, 119, 154, 183, 199, 239

OEM	Brand	Part Id	Page
321265U	Dayton Parts	13528	83, 119, 154, 183, 199, 239
321267	Dayton Parts	13685	122, 170
321268	Dayton Parts	14002	210
321270	Dayton Parts	18956	214
321273	Dayton Parts	18919	10
321273U	Dayton Parts	18919	10
321274	Dayton Parts	18919	10
321274	Dayton Parts	18920	10
321276	Dayton Parts	11739	10, 117
321276U	Dayton Parts	11739	10, 117
321277	Dayton Parts	18921	10
321277U	Dayton Parts	18921	10
321279	Dayton Parts	11714	78
321284	Dayton Parts	19005	218
321285	Dayton Parts	15020	213
321285	Dayton Parts	19008	218
321285U	Dayton Parts	15020	213
321288	Dayton Parts	31096	272
321294	Dayton Parts	14004	231
321314	Dayton Parts	14514	185
321317	Dayton Parts	13658	89
321318	Dayton Parts	13546	84
321320	Dayton Parts	13659	89, 240
321324U	Dayton Parts	30545	280
321325	Dayton Parts	11512	144
321325	Dayton Parts	11514	144
321325	Dayton Parts	11735	4, 150
321325A	Dayton Parts	11735	4, 150
321325U	Dayton Parts	11512	144
321325U	Dayton Parts	11514	144
321335	Dayton Parts	11511	78, 144
321335A	Dayton Parts	11511	78, 144
321338	Dayton Parts	11711	41, 162, 217, 223
321360	Dayton Parts	13582	86, 121
321366	Dayton Parts	13672	90
321368	Dayton Parts	11711	41, 162, 217, 223
321369	Dayton Parts	11729	78, 116, 150, 194
321377	Dayton Parts	13539	230
321387	Dayton Parts	18821	94
321388	Dayton Parts	13627	88
321519	Dayton Parts	12051	167
32154	Eaton	17504	282
32157	Eaton	17502	282
32161	Eaton	17529	283
32174000	Hendrickson	13519	82
32174000	Hendrickson	13525	82
322069C91	International	13514	118
322102	Dayton Parts	13534	83, 120
322102A	Dayton Parts	13534	83, 120
322102A	Dayton Parts	13558	85
322123	Dayton Parts	11001	32, 258
322138	Dayton Parts	11000	31
322138	Dayton Parts	11064	34
322146	Dayton Parts	14523	185
322147	Dayton Parts	14524	185
3226713	Hendrickson	12070	79
32271102	Ford	13735	15
32271102	Hendrickson	13735	93
32271102	International	13735	124
32271102	Kenworth	13735	155
32271102	Volvo	13735	263
323167	Dayton Parts	13512	14, 81
323167U	Dayton Parts	13512	14, 81
324001	Energy Suspension	11545	147, 162
324002	Energy Suspension	11709	149, 194
324102	Energy Suspension	11705	116, 149, 194, 278
32460730	Wabash	14008	231
32460730	Wabash	14073	231
32460848	Wabash	14000	230

Cross Reference continued

OEM	Brand	Part Id	Page
3249322R1	International	11556	116
3249322R1	International	13522	119
3249322R1	International	83522	136
325002	Energy Suspension	11502	143
325002	Energy Suspension	11719	149
325100	Dayton Parts	13649	15, 89, 122, 170
325100U	Dayton Parts	13649	15, 89, 122, 170
325101	Dayton Parts	13650	15, 59, 89, 122, 262
325103	Dayton Parts	13650	15, 59, 89, 122, 262
325104	Dayton Parts	13650	15, 59, 89, 122, 262
325104U	Dayton Parts	13650	15, 59, 89, 122, 262
325107	Dayton Parts	14027	101, 231
325107U	Dayton Parts	14027	101, 231
325108	Dayton Parts	12053	167
325108U	Dayton Parts	12053	167
325110	Dayton Parts	12014	164
325112	Dayton Parts	12006	164
325112U	Dayton Parts	12006	164
325112U	Dayton Parts	12040	166
325113	Dayton Parts	12010	164
325113U	Dayton Parts	12010	164
325114	Dayton Parts	12009	164
325114	Dayton Parts	12040	166
325115	Dayton Parts	12028	165
325115U	Dayton Parts	12028	165
325117	Dayton Parts	12029	165
325117U	Dayton Parts	12029	165
325118	Dayton Parts	12015	164, 258
325118U	Dayton Parts	12015	164, 258
325120	Dayton Parts	12015	164, 258
325120U	Dayton Parts	12015	164, 258
325122	Dayton Parts	14027	101, 231
325123	Dayton Parts	12014	164
325124	Dayton Parts	12009	164
325124	Dayton Parts	12040	166
325127	Dayton Parts	12014	164
325137	Dayton Parts	14521	185, 211, 232, 275
325137U	Dayton Parts	14521	185, 211, 232, 275
325139U	Dayton Parts	14522	185, 211, 232, 275
325141	Dayton Parts	14509	184, 211
325142	Dayton Parts	14522	185, 211, 232, 275
325142U	Dayton Parts	14522	185, 211, 232, 275
325150	Dayton Parts	13009	54, 229
325150AU	Dayton Parts	13009	54, 229
325150U	Dayton Parts	13009	54, 229
325151	Dayton Parts	13037	54, 230, 275
325151U	Dayton Parts	13037	54, 230, 275
325156	Dayton Parts	11740	10
325160	Dayton Parts	11500	143, 217
325160	Dayton Parts	19004	157, 218
325160U	Dayton Parts	11500	143, 217
325160U	Dayton Parts	19004	157, 218
325195	Dayton Parts	14500	184
325200	Dayton Parts	14505	184
325204	Dayton Parts	14502	184
325218	Dayton Parts	14501	184
325222	Dayton Parts	11501	143
325222U	Dayton Parts	11501	143
325235U	Dayton Parts	14504	124, 184, 211, 240
325242	Dayton Parts	13725	93
327179	Dayton Parts	19001	16, 62, 127, 242
327212	Dayton Parts	19001	16, 62, 127, 242
327256	Dayton Parts	19001	16, 62, 127, 242
327306	Dayton Parts	11060	116, 142
327434	Dayton Parts	11757	151
327434	Dayton Parts	11758	13, 58, 79, 117, 151, 163, 258
327479	Dayton Parts	19001	16, 62, 127, 242
327481	Dayton Parts	12043	166
327485	Dayton Parts	19001	16, 62, 127, 242

OEM	Brand	Part Id	Page
327487	Dayton Parts	18600	45
327490	Dayton Parts	18600	45
329104U	Dayton Parts	11517	293
329106U	Dayton Parts	10026	114
329109U	Dayton Parts	12000	163
329110U	Dayton Parts	18232	61, 265
329111U	Dayton Parts	18222	61, 265
329112U	Dayton Parts	10011	112
329113U	Dayton Parts	11062	142, 192
329114U	Dayton Parts	12023	164
329115U	Dayton Parts	11013	33
329116U	Dayton Parts	11085	35
329116U	Dayton Parts	11725	41
329117U	Dayton Parts	18222	61, 265
329119U	Dayton Parts	18063	126
329120U	Dayton Parts	11549	147
329123U	Dayton Parts	11515	144, 293
329124U	Dayton Parts	11515	144, 293
329125U	Dayton Parts	17674	284
329126U	Dayton Parts	17675	284
329128U	Dayton Parts	11612	148
329129U	Dayton Parts	11545	147, 162
329130U	Dayton Parts	12366	197, 279
329132U	Dayton Parts	12367	197
329133U	Dayton Parts	10020	31, 113
329135U	Dayton Parts	11533	145, 278
329136U	Dayton Parts	11520	40, 145, 192, 222, 278
329136U	Dayton Parts	11523	40, 145, 192, 223, 278
329141U	Dayton Parts	11537	40, 146, 192
329141U	Dayton Parts	11613	41, 148, 193
329142U	Dayton Parts	11535	146
329143U	Dayton Parts	11539	146, 193
329143U	Dayton Parts	11614	148, 193
329143U	Dayton Parts	11761	151, 194
329144U	Dayton Parts	11707	41, 149, 194
329144U	Dayton Parts	12355	153, 196
329145U	Dayton Parts	11709	149, 194
329147U	Dayton Parts	11705	116, 149, 194, 278
329149U	Dayton Parts	11554	147, 193
329150U	Dayton Parts	10075	12, 114, 258
329151U	Dayton Parts	12356	196
329155U	Dayton Parts	18786	200
329157U	Dayton Parts	10002	293
329159U	Dayton Parts	11537	40, 146, 192
329159U	Dayton Parts	11613	41, 148, 193
329161U	Dayton Parts	12363	196
329162U	Dayton Parts	11554	147, 193
329163U	Dayton Parts	11707	41, 149, 194
329164U	Dayton Parts	11614	148, 193
329165U	Dayton Parts	12032	165
329165U	Dayton Parts	18232	61, 265
329169U	Dayton Parts	12004	163
329171U	Dayton Parts	12017	164
329177U	Dayton Parts	11705	116, 149, 194, 278
329179U	Dayton Parts	10503	115
329181U	Dayton Parts	10505	115
329187U	Dayton Parts	34505	132
329188U	Dayton Parts	34506	132
329191U	Dayton Parts	18102	200, 279
329194U	Dayton Parts	11537	40, 146, 192
329194U	Dayton Parts	11613	41, 148, 193
329199U	Dayton Parts	11020	33
329202U	Dayton Parts	12359	196
329205U	Dayton Parts	11544	40, 162
329205U	Dayton Parts	18837	45, 171
329211	Dayton Parts	12026	165
329214	Dayton Parts	12357	196
329214	Dayton Parts	12381	198

Cross Reference continued

OEM	Brand	Part Id	Page
330102	Dayton Parts	12041	166
330116	Dayton Parts	12375	197
330123	Dayton Parts	18600	45
330125	Dayton Parts	11757	151
330125	Dayton Parts	11759	151
330149	Dayton Parts	19001	16, 62, 127, 242
330168	Dayton Parts	18601	156
330168	Dayton Parts	18602	156
330190	Dayton Parts	19001	16, 62, 127, 242
334108	Dayton Parts	13502	80, 118, 210
334109	Dayton Parts	13507	80, 182, 217
3341123	Dayton Parts	13610	88, 121
3341134	Dayton Parts	13541	84
334126	Dayton Parts	13610	88, 121
3341262	Dayton Parts	15059	214
334127	Dayton Parts	13609	14, 87, 121, 183, 210
3341272	Dayton Parts	14038	102
334138	Dayton Parts	13547	84, 120
3341576	Dayton Parts	13600	87
3341576	Dayton Parts	13628	88
3341579	Dayton Parts	13604	87
3341597	Dayton Parts	13550	85
3341602	Dayton Parts	13550	85
3341617	Dayton Parts	11733	150
3341617	Dayton Parts	11766	152
3341628	Dayton Parts	13594	87
3341655	Dayton Parts	13623	328
3341672	Dayton Parts	50033	7, 46, 172, 225, 236, 274
3341674	Dayton Parts	50032	6
3341699	Dayton Parts	13604	87
3341720	Dayton Parts	13611	7, 88
3341720	Dayton Parts	13722	8, 93, 124
3341727	Dayton Parts	13626	42, 88, 121, 169, 199, 262
3341810	Dayton Parts	13648	89
3341845	Dayton Parts	13626	42, 88, 121, 169, 199, 262
334247	Dayton Parts	15063	94, 214, 233
334252	Dayton Parts	15064	44, 171, 214, 224, 233
334252U	Dayton Parts	15064	44, 171, 214, 224, 233
334253	Dayton Parts	15064	44, 171, 214, 224, 233
334354	Dayton Parts	13610	88, 121
334381	Dayton Parts	13566	86, 262
334452A	Dayton Parts	13041	55
334453A	Dayton Parts	13011	54, 229
334456	Dayton Parts	12351	195
334460	Dayton Parts	12361	196
334460U	Dayton Parts	12361	196
334467	Dayton Parts	13609	14, 87, 121, 183, 210
334492	Dayton Parts	11064	34
334527	Dayton Parts	13527	82
334565	Dayton Parts	13042	55, 100, 230
334566	Dayton Parts	13015	54, 229
334640	Dayton Parts	13042	55, 100, 230
334658	Dayton Parts	13510	81
334717	Dayton Parts	12043	166
334747	Dayton Parts	30544	129
334814	Dayton Parts	12362	196
334830	Dayton Parts	13607	59, 87, 121
334830U	Dayton Parts	13607	59, 87, 121
334831	Dayton Parts	13596	87
334831	Dayton Parts	83596	8, 62, 95, 136
334832	Dayton Parts	13555	85, 262
334833	Dayton Parts	13524	82, 210
334848	Dayton Parts	13625	88

OEM	Brand	Part Id	Page
334852	Dayton Parts	13601	87, 121
334852	Dayton Parts	13721	93, 124
334852	Dayton Parts	13722	8, 93, 124
334852A	Dayton Parts	13601	87, 121
334852A	Dayton Parts	13721	93, 124
334852A	Dayton Parts	13722	8, 93, 124
334879	Dayton Parts	13665	90
334884	Dayton Parts	19002	218
334885	Dayton Parts	19002	218
334885	Dayton Parts	19008	218
334886	Dayton Parts	19003	200, 218
334896	Dayton Parts	15061	125, 214, 233
334898	Dayton Parts	13542	84, 120
334916	Dayton Parts	12333	260
334936	Dayton Parts	13581	328
334960	Dayton Parts	13562	85
334964	Dayton Parts	19001	16, 62, 127, 242
339102	Dayton Parts	13587	86
34013049	Hendrickson	13566	86
34013050	Hendrickson	13566	86
34013050	Hendrickson	13566	86
34013051	Hendrickson	13562	85
34013054	Hendrickson	13534	83
34013073	Hendrickson	13566	86
34013087L	Hendrickson	13607	87
34013088	Hendrickson	13548	84
34013088	Hendrickson	13596	87
34013088	Hendrickson	83596	95
34013088L	Autocar	83596	8
34013088L	Hendrickson	83596	95
34013097	Hendrickson	13656	89
3401349	Hendrickson	13566	86
3401351L	Hendrickson	13562	85
3401354L	Hendrickson	13534	83
3401387	Hendrickson	13607	87
3401388L	Hendrickson	13548	84
3401388L	Hendrickson	13596	87
3401388L	Hendrickson	83596	95
3444147C91	International	34540	135
345210	Dayton Parts	34554	200, 312
345211	Dayton Parts	12395	182, 198, 307
345212	Dayton Parts	11078	35, 304
345213	Dayton Parts	11153	40, 304
345215	Dayton Parts	12398	79, 182, 198, 307
345216	Dayton Parts	31095	271, 312
345219	Dayton Parts	18860	8, 171, 265, 312
345222	Dayton Parts	12072	168, 306
345610	Dayton Parts	13683	43, 90, 122, 308
345612	Dayton Parts	13700	92, 124, 310
345614	Dayton Parts	13702	93, 311
345620	Dayton Parts	13686	43, 91, 122, 262, 309
345630	Dayton Parts	13686	43, 91, 122, 262, 309
345640	Dayton Parts	13687	91, 309
345640	Dayton Parts	13688	91, 309
345650	Dayton Parts	13688	91, 309
345660	Dayton Parts	13690	59, 91, 122, 309
345660	Dayton Parts	13691	43, 91, 123, 262, 309
345661	Dayton Parts	13691	43, 91, 123, 262, 309
345668	Dayton Parts	13704	93, 311
345670	Dayton Parts	13692	59, 91, 123, 309
345680	Dayton Parts	13694	43, 92, 123, 262, 310
345681	Dayton Parts	13695	43, 92, 123, 184, 263, 310
345690	Dayton Parts	13696	43, 92, 123, 263, 310

Cross Reference continued

OEM	Brand	Part Id	Page
345691	Dayton Parts	13697	43, 92, 123, 263, 310
345700	Dayton Parts	13698	59, 92, 123, 310
345701	Dayton Parts	13699	59, 92, 123, 310
345734	Dayton Parts	13735	15, 93, 124, 155, 170, 263, 311
345736	Dayton Parts	13693	91, 309
345738	Dayton Parts	13686	43, 91, 122, 262, 309
345740	Dayton Parts	13688	91, 309
345741	Dayton Parts	13683	43, 90, 122, 308
345741	Dayton Parts	13691	43, 91, 123, 262, 309
345742	Dayton Parts	13683	43, 90, 122, 308
345742	Dayton Parts	13691	43, 91, 123, 262, 309
345792	Dayton Parts	13735	15, 93, 124, 155, 170, 263, 311
345794	Dayton Parts	13701	92, 124, 310
345794	Dayton Parts	13703	93, 124, 311
345815	Dayton Parts	13735	15, 93, 124, 155, 170, 263, 311
345862	Dayton Parts	31095	271, 312
345866	Dayton Parts	34563	136, 313
345868	Dayton Parts	11081	35, 304
345882	Dayton Parts	12397	153, 198, 307
345883	Dayton Parts	11795	153, 195, 305
345884	Dayton Parts	11792	153, 195, 305
345898	Dayton Parts	18860	8, 171, 265, 312
34734C1	International	15013	125
348	Premier	18574	294
348A	Premier	18574	294
350030008	Volvo	83522	274
3500333201	Volvo	11556	258
350035005	Volvo	11758	258
350330001	Volvo	15017	264
350330005	Volvo	15018	264
350330008	Volvo	13522	261
3512064C4	International	34528	134
351363PU	Westar	11705	116, 149, 194, 278
3514950C1	International	11747	117
3515345C1	International	34515	133
3515345C2	International	34515	133
3525665C1	International	34511	133
3538115C1	International	11005	115
3548381C1	International	34563	136
3549169C1	International	34529	134
3549169C2	International	34529	134
35501	Westar	11735	4, 150
35502	Westar	11501	143
35505	Westar	11511	78, 144
35526PU	Westar	11502	143
35526PU	Westar	11719	149
35539PU	Westar	11550	147, 193
3554205C2	International	34521	133
35547	Westar	11757	151
35547	Westar	11759	151
35548PU	Westar	11520	40, 145, 192, 222, 278
35548PU	Westar	11523	40, 145, 192, 223, 278
35549PU	Westar	11537	40, 146, 192
35549PU	Westar	11613	41, 148, 193
35550PU	Westar	12363	196
35551PU	Westar	11535	146
35552PU	Westar	11539	146, 193
35552PU	Westar	11614	148, 193
35552PU	Westar	11761	151, 194
35553PU	Westar	11709	149, 194
35555PU	Westar	11545	147, 162

OEM	Brand	Part Id	Page
35556PU	Westar	11612	148
35558PU	Westar	11533	145, 278
35562PU	Westar	11549	147
35564PU	Westar	11705	116, 149, 194, 278
35568PU	Westar	11554	147, 193
35569PU	Westar	11707	41, 149, 194
35570PU	Westar	11539	146, 193
35570PU	Westar	11614	148, 193
35570PU	Westar	11761	151, 194
35572PU	Westar	11502	143
35572PU	Westar	11720	149
35574	Westar	11733	150
35574	Westar	11766	152
3574670C91	International	34516	133
3574670C91	International	34540	135
3574671C91	International	34516	133
3574671C91	International	34540	135
3574678C1	International	34516	133
3574678C1	International	34540	135
3574680C1	International	34516	133
3574680C1	International	34540	135
358010033	Autocar	13657	7
358010033	Western Star	13657	279
358010068	Volvo	18860	265
358010068	Volvo/White/GMC	18860	265
358010560	Autocar	13657	7
358013441	Western Star	11080	277
358015010	Volvo/White/GMC	13686	262
358015012	Volvo	12044	259
358015012	Volvo/White/GMC	13691	262
358015014	Volvo/White/GMC	13694	262
358015014	Volvo/White/GMC	13695	263
358015015	Western Star	13520	279
358015015	Western Star	13536	279
358015015	Western Star	83520	280
358015016	Volvo	13533	261
358015016	Volvo/White/GMC	13518	261
358015016	Western Star	13533	279
358015018	Volvo/White/GMC	13696	263
358015018	Volvo/White/GMC	13697	263
358115C1	International	11083	116
3581270C1	International	11080	116
3589599C91	International	34516	133
3589599C91	International	34540	135
36010	Tramec	17676	285
36011	Tramec	17674	284
36012	Tramec	17675	284
3692	Trailmobile	13042	230
373005R	Energy Suspension	18558	234, 294
373023403	Western Star	30545	280
374129560	Kenworth	11768	152
374129560	Peterbilt	11103	192
3765438	GMC	19001	62
3765438	GMC/Chevrolet	19001	242
3769289	GMC/Chevrolet	19001	242
3799344	Kenworth	11768	152
381571	Trailmobile	17502	282
382517	Trailmobile	17500	281
384191C91	International	13517	119
3844147C91	International	34516	133
3844147C91	International	34540	135
385216	Trailmobile	14027	231
38788	Trailmobile	14004	231
3889XB0009	Mack	18221	171
3889XB0011	Mack	18215	171
3889XB10605	Mack	40035	172
3927019	GMC	16000	59
3938708	Volvo	13555	262
39400013	Arvin Meritor	10000	4

Cross Reference continued

OEM	Brand	Part Id	Page
39400016	Dayton Parts	15013	94, 125, 213, 232, 264
3QK2171K15	Mack	15009	170
400062000590	Mack	34556	172
400062001590	Mack	34556	172
400062010455	Mack	12396	168
400062350615	Mack	13733	170
400062350645	Mack	34555	172
400064179037	Mack	13626	169
400329	Hyster	18256	234
40095	Stemco Gaff	40095	326
401754	Dayton Parts	18010	6, 240, 264
401754	International	18566	127
40302	Westar	12004	163
40307PU	Westar	12000	163
40308	Westar	12032	165
40312	Westar	11544	40, 162
40312	Westar	18837	45, 171
40322PU	Westar	12006	164
40322PU	Westar	12040	166
40328	Westar	12014	164
40334	Westar	11714	78
40336PU	Westar	12010	164
40340	Westar	18566	44, 56, 127, 156, 171, 186, 200, 279
40341	Westar	12049	167
40345PU	Westar	12009	164
40345PU	Westar	12040	166
40348	Westar	13513	169, 239
40354	Westar	18837	45, 171
40356	Westar	12023	164
40357	Westar	12002	163
40367PU	Westar	12015	164, 258
405109	Standard Forge	17503	282
405126	Standard Forge	17501	281
405126	Standard Forge	17538	284
405128	Standard Forge	17539	284
4100328	Holland	40056	295
4100358	Holland	10001	293
412587C1	International	10000	112
415015001	Arvin Meritor	18010	6
4170	International	10505	115
41NE1614	Peterbilt	12362	196
422001	Energy Suspension	14521	185, 211, 232, 275
427893R1	International	13650	122
42984R1	International	13650	122
432001	Energy Suspension	14027	101, 231
436149R1	International	10009	112
437	Premier	18558	294
437A	Premier	18558	294
438506C1	International	13515	119
438506C91	International	13515	119
43RU297M	Mack	12043	166
441302C92	International	13553	120
441737	Sloan	17675	284
441738	Sloan	17674	284
441739	Euclid	17676	285
441739	Sloan	17676	285
442001	Energy Suspension	13009	54, 229
44694	Hendrickson	11556	78
44694	Hendrickson	13522	82
44694	Hendrickson	83522	95
44694000L	Hendrickson	13522	82
44694000L	Hendrickson	83522	95
44695	Hendrickson	13520	82
44695	Hendrickson	13536	83
44695	Hendrickson	83520	95
44697	Hendrickson	13518	81
44697	Hendrickson	13533	122
448	Premier	18575	294

OEM	Brand	Part Id	Page
44809	Hendrickson	13684	90
44809000	Hendrickson	13684	90
448A	Premier	18575	294
449713C1	International	10004	112
449713C2	International	10004	112
45000005	Hendrickson	13502	80
45000007	Hendrickson	13507	80
45000011L	Hendrickson	13610	88
45000013	Hendrickson	13502	80
45000013	Hendrickson	13502	80
4500013L	Hendrickson	13502	80
4500013L	Hendrickson	13504	80
452836	Volvo/White/GMC	13553	261
452839	Volvo	13505	261
452839	Volvo/White/GMC	13505	261
4537220	PAI	13634	89, 170, 308
45407	Hendrickson	13560	85
45407000	Hendrickson	13560	85
45407L	Hendrickson	13560	85
45477	Hendrickson	13514	81
45900	Hendrickson	13553	85
45900	Kenworth	13553	155
45900000L	Hendrickson	13553	85
459591C2	International	10014	113
46493000	Hendrickson	13549	85
46610	Hendrickson	13683	90
46630	Hendrickson	13686	91
46640	Hendrickson	13687	91
46650	Hendrickson	13688	91
46660	Hendrickson	13690	91
46660	Hendrickson	13691	91
46661	Hendrickson	12044	79
46661	Hendrickson	13691	91
46661	Kenworth	12044	153
466670	White	17500	281
46670	Hendrickson	13692	91
46671	Hendrickson	13693	91
46680	Hendrickson	13694	92
46681	Hendrickson	13695	92
46690	Hendrickson	13696	92
46691	Hendrickson	13697	92
46700	Hendrickson	13698	92
46701	Hendrickson	13699	92
46734	Hendrickson	13517	81
46735	Hendrickson	12031	79
46735	Mack	12031	165
46736	Hendrickson	13516	81
46868000	Hendrickson	18538	94
470031C2	International	10503	115
471226C1	International	19001	127
471226C1	International	19001	127
471478C1	International	31604	132
471478C2	International	31604	132
472697C1	International	10026	114
47420	Hendrickson	13526	82
47421	Hendrickson	13512	81
476869C1	International	11705	116
47691	Hendrickson	11004	77
47691	Hendrickson	13521	82
47691	Mack	11004	162
47691	Mack	13521	169
47691	Peterbilt	11004	192
47691	Peterbilt	13521	198
47691000	Hendrickson	11004	77
47691000	Hendrickson	13521	82
47692	Hendrickson	14010	94
47692000	Hendrickson	14010	94
476991	Hendrickson	13515	81
479237C1	International	10505	115
47937C1	International	34519	133

Cross Reference continued

OEM	Brand	Part Id	Page
47937C1	International	34523	134
47937C1	International	34537	135
48100394	Neway	50047	186
48401	Hendrickson	13512	81
48402	Hendrickson	13526	82
48411006	Ford	13735	15
48411006	Hendrickson	13735	93
48411006	International	13735	124
48411006	Kenworth	13735	155
48411006	Volvo	13735	263
484891C91	International	13610	121
48883000	Hendrickson	13527	82
48929	Hendrickson	13512	81
48932	Hendrickson	13526	82
48941	Hendrickson	13555	85
48972	Hendrickson	13650	89
48973	Hendrickson	13650	89
48973000	Hendrickson	13650	89
49175005	Hendrickson	13527	82
49175013	Hendrickson	13527	82
49210	Hendrickson	13528	83
493051020	Hino	18830	96
493051110	Hendrickson	18830	94
49377	Hendrickson	13601	87
49377	Hendrickson	13721	93
49377	Hendrickson	13722	93
49377000	Hendrickson	13721	93
49377000	Hendrickson	13601	87
49377000	Hendrickson	13722	93
49395	Hendrickson	13625	88
49395000	Hendrickson	13625	88
49400	Hendrickson	13505	80
49400	Hendrickson	13548	84
49400000	Hendrickson	13505	80
49400000	Hendrickson	13548	84
49600	Hendrickson	13543	84
49600000	Hendrickson	13543	84
496529C91	International	13502	118
496530	Hendrickson	13507	80
497501C2	International	13577	120
498403	Volvo	13500	260
498407A	Volvo/White/GMC	13592	262
498417	Volvo	13501	260
498417	Volvo/White/GMC	13501	260
499523C3	International	10506	115
4C406038AA	Ford	34509	17
4C406038AA	Ford	34526	17
4C4Z4612AA	International	34563	136
4C4Z6038A	Ford	34509	17
4C4Z6038A	Ford	34526	17
4C4Z6068BA	Ford	34529	17
4QK3370	Mack	11758	163
5003323	Spicer	40074	6, 8, 17, 46, 62, 136, 157, 172, 200, 274
50130000	Hendrickson	13665	90
50134002	Orion	18010	240
501412	Westar	12375	197
501420	Westar	12361	196
501421PU	Westar	12350	195
501422PU	Westar	12351	195
501428	Westar	12395	182, 198, 307
501429PU	Westar	12366	197, 279
501431PU	Westar	12355	153, 196
501434PU	Westar	12356	196
501435PU	Westar	12367	197
501437	Westar	12398	79, 182, 198, 307
501440PU	Westar	11554	147, 193
501442PU	Westar	18102	200, 279
501445UB	Westar	12360	196
50150	Hendrickson	13607	87

OEM	Brand	Part Id	Page
50150000	Hendrickson	13607	87
501535C2	International	12329	118
501565C2	International	34563	136
50252	Hendrickson	11758	79
50273AB	Kenworth	11767	152
50273AB	Peterbilt	11767	195
50275	Dayton Parts	11758	13, 58, 79, 117, 151, 163, 258
50275	Westar	11758	13, 58, 79, 117, 151, 163, 258
50275AA	Barry Controls	11540	146
50275AA	Barry Controls	11760	151
503579C1	International	10075	114
503611C1	International	11060	116
503611C2	International	11060	116
50376001	Ford	13735	15
50376001	Hendrickson	13735	93
50376001	International	13735	124
50376001	Kenworth	13735	155
50376001	Volvo	13735	263
503837C1	International	10075	114
507569C91	International	10075	114
508678	Volvo	18010	264
513267C1	International	15008	125
515147	Fruehauf	17501	56
515697	TRW	40075	6, 17, 46, 62, 96, 136, 157, 172, 201, 225, 274
515697	Volvo	40075	274
51879	Kenworth	11765	152
52296	Hendrickson	11083	77
52296	Peterbilt	11083	192
5295	Kenworth	11060	142
5295	Kenworth	11757	151
5295	Kenworth	11758	151
5296	Kenworth	11757	151
5296	Kenworth	11758	151
53099V	International	19001	127
536	Premier	18333	294
537372C91	International	13609	121
5435947794	Mack	11751	163
546210050	Mack	14513	170
546211223	Mack	14533	170
549331	White	15017	264
55103PU	Westar	15016	213, 232
5511001	Westar	15063	94, 214, 233
5511012	Westar	15020	213
5511012PU	Westar	15020	213
55117	Westar	15000	212
55128PU	Westar	15008	125, 212, 232
55129	Westar	15013	94, 125, 213, 232, 264
55129PU	Westar	15013	94, 125, 213, 232, 264
55130	Westar	14010	15, 94, 155, 211, 231
55131PU	Westar	15051	213, 233
55132PU	Westar	15011	213
55132PU	Westar	15019	213
55132PU	Westar	15073	214
55134PU	Westar	15009	170, 212
55144	Westar	15054	213, 233
55146	Westar	15061	125, 214, 233
55152PU	Westar	15001	125, 212
55190PU	Westar	15005	212
55191PU	Westar	15017	213, 232, 264
5550317	Neway	12395	182
5554200Z00	Nissan	18830	96
5554290002	Nissan	18830	96
55542Z2000	Nissan	18830	96
55542Z2001	Nissan	18830	96

Cross Reference continued

OEM	Brand	Part Id	Page
555645C1	International	10009	112
56557002	Hendrickson	13524	82
56557004	Hendrickson	13550	85
565572	Hendrickson	13524	82
565574	Hendrickson	13550	85
566591	Hendrickson	13555	85
56766	Hendrickson	13700	92
56767	Hendrickson	13701	92
56929000	Hendrickson	13550	85
57046	Hendrickson	13702	93
57047	Hendrickson	13703	93
57048	Hendrickson	13704	93
57256000	Hendrickson	11714	78
57750211	Neway	13516	183
57750230	Neway	13684	183
57750233	Neway	13518	183
57750233	Neway	13533	183
57750252	Neway	11556	182
57750258	Neway	13528	183
57750261	Neway	13517	183
57750262	Neway	13515	183
57750343	Neway	12398	182
57857006	Hendrickson	13634	89
57989000	Hendrickson	11747	78
57989000	Hendrickson	13527	82
583955C1	International	10505	115
586121	Fruehauf	14003	55
58648000	Hendrickson	18821	94
58648000	Hendrickson	18821	94
58757005	Hendrickson	13597	87
587575	Hendrickson	13597	87
58918000	Freightliner	18994	45
58918000	Hendrickson	18994	94
5900582B585	Ridewell	11500	217
5900582B585	Ridewell	19004	218
590162C1	International	14504	124
5919	Hendrickson	13505	80
5919	Hendrickson	13548	84
5919000	Hendrickson	13505	80
5922276	MCI	33503	250
5922276	New Flyer	18930	242
5922276	New Flyer	33502	250
5922276	New Flyer	33503	250
593461	Hendrickson	18994	94
593717C91	International	13547	120
5957548	New Flyer	33502	250
5957548	New Flyer	33503	250
598958C1	International	10027	114
598958C2	International	10027	114
601501	Westar	14529	55, 186
601501	Westar	14533	44, 125, 170, 186, 223, 232, 263, 275
601502	Westar	14526	185
601507	Westar	14509	184, 211
601527	Westar	14522	185, 211, 232, 275
601531PU	Westar	14527	125, 185
601532	Westar	14510	184, 231
601535	Westar	14513	44, 55, 125, 170, 185, 223, 232, 263, 275
601539	Westar	14514	185
601540PU	Westar	14504	124, 184, 211, 240
601541	Westar	14521	185, 211, 232, 275
601546PU	Westar	14522	185, 211, 232, 275
602035	Mcneilus	18905	287
60314000	Autocar	13611	7
60314000	Autocar	13722	8
60314000	Hendrickson	13611	88
60314000	Hendrickson	13722	93
60383000	Hendrickson	13627	88

OEM	Brand	Part Id	Page
60383000	Hendrickson	13627	88
60632006	Hendrickson	13604	87
60879	Hendrickson	13721	93
60879	Hendrickson	13722	93
60879000	Hendrickson	13601	87
60879000L	Hendrickson	13721	93
60879000L	Hendrickson	13722	93
60879L	Hendrickson	13721	93
60879L	Hendrickson	13722	93
609612	Hendrickson	13725	93
61610012	York Transport	18711	236
61610013	York Transport	18710	236
62000590	Hendrickson	34556	95
62000610	Hendrickson	11751	78
62000615	Hendrickson	12071	79
62000650	Hendrickson	12398	79
62001590	Hendrickson	34556	95
62007365	Ford	13735	15
62007365	Hendrickson	13735	93
62007365	International	13735	124
62007365	Kenworth	13735	155
62007365	Volvo	13735	263
62010455	Hendrickson	12396	79
62350615	Hendrickson	13733	93
62350635	Hendrickson	13679	90
62350645	Hendrickson	34555	95
63011001	Peterbilt	12365	197
6313765	MCI	18866	241
6313765	New Flyer	18866	241
6322561	New Flyer	33502	250
6322561	New Flyer	33503	250
6322591	New Flyer	33503	250
6322757	MCI	33503	250
6322757	New Flyer	18930	242
6322757	New Flyer	33502	250
6322757	New Flyer	33503	250
64179002	Hendrickson	13626	88
64179004	Autocar	13611	7
64179004	Autocar	13722	8
64179004	Hendrickson	13611	88
64179004	Hendrickson	13722	93
64179037	Hendrickson	13626	88
64179037	Peterbilt	13626	199
641794	Hendrickson	13611	88
641794	Hendrickson	13722	93
64400002L	Hendrickson	13520	82
64400002L	Hendrickson	13536	83
64400002L	Hendrickson	83520	95
64400004L	Hendrickson	13518	81
64400005L	Hendrickson	13528	83
64400007L	Hendrickson	12031	79
64400009L	Hendrickson	13517	81
64400010L	Hendrickson	13516	81
64411	Flxible	33503	250
64473000	Hendrickson	13590	86
64474000	Hendrickson	13590	86
64697	Hendrickson	13582	86
64697000	Hendrickson	13582	86
651905	Westar	14001	210, 230
651908	Westar	14004	231
65329	Haldex	17503	282
656215	Western Star	12366	279
65831000	Hendrickson	13652	89
660013204	Volvo	12322	260
660013403	Western Star	11705	278
663400	Fruehauf	18566	56
66610000H	Hendrickson	13683	90
66630000H	Hendrickson	13686	91
6664	Hendrickson	13500	79
66640000H	Hendrickson	13687	91

Cross Reference continued

OEM	Brand	Part Id	Page
66649002	Hendrickson	13520	82
66649002	Hendrickson	13536	83
66649002	Hendrickson	83520	95
66649004	Hendrickson	13518	81
66649005	Hendrickson	13528	83
66650000H	Hendrickson	13688	91
66660000H	Hendrickson	13690	91
66660000H	Hendrickson	13691	91
66661000H	Hendrickson	12044	79
66661000H	Hendrickson	13691	91
66670000H	Hendrickson	13692	91
66680000H	Hendrickson	13694	92
66681000H	Hendrickson	13695	92
66690000H	Hendrickson	13696	92
66691000H	Hendrickson	13697	92
66700000H	Hendrickson	13698	92
66701000H	Hendrickson	13699	92
66766000H	Hendrickson	13700	92
66767000H	Hendrickson	13701	92
66D608	Kenworth	11062	142
670093442	Western Star	18015	279
67046000H	Hendrickson	13702	93
67047000H	Hendrickson	13703	93
67048000H	Hendrickson	13704	93
671173235	Volvo	12310	259
67358	Haldex	17500	281
6793185	Volvo	12312	259
6803220105	Freightliner	11066	34
6803220150	Freightliner	11066	34
6808800160	Freightliner	11103	37
6808800160	Freightliner	12365	42
6808800160	Hino	11103	96
6808800160	Hino	12365	96
6808800160	Kenworth	11134	143
6808910401	Freightliner	11111	38
6808910401	Freightliner	11111	38
6813250150	Freightliner	11005	32
6813250150	Freightliner	11083	35
6813250250	Freightliner	11005	32
6813262065	Freightliner	11751	41
6813262065	Freightliner	11751	41
6813262516	Freightliner	34556	45
6813266316	Freightliner	11153	40
6813266716	Freightliner	11078	35
6813267016	Freightliner	13679	42
6813267216	Freightliner	11081	35
6818900001	Freightliner	11009	33
6818900001	Freightliner	11086	36
6818910001	Freightliner	11008	32
6818910001	Freightliner	11086	36
683671	Volvo	13650	262
683672	Volvo	13650	262
686924	GMC	13525	58
686924	GMC	18125	61
6889513	Volvo	32008	272
69210000	Hendrickson	13672	90
69210000H	Hendrickson	13672	90
6966	Hendrickson	13659	89
6969	Hendrickson	13501	80
698468R92	International	11716	116
700002	Hendrickson	13587	86
700701	GMC/RTS/Nova	33500	250
700701U	GMC/RTS/Nova	33500	250
700705	Freightliner	11007	32
700705	International	10008	112
700734	Trailmobile	17505	282
700762	Trailmobile	17505	282
700768	Trailmobile	17668	284
701000	Hutchens	14000	100
7014TK19089	Mack	15064	171

OEM	Brand	Part Id	Page
702727	GMC	18232	61
702727	Volvo	18232	265
714906	GMC	18439	61
714923	GMC	17529	61
72200	Hutchens	14008	100
72200	Hutchens	14073	102
723330	GMC	33502	62
723330	GMC	33503	62
723330	GMC/RTS/Nova	33503	250
723330A	GMC/RTS/Nova	33503	250
730160002	Thermo King	50054	301
730731	Hendrickson	13515	81
73D2002	Kenworth	18566	156
750006	PAI	13656	89, 122
750010	PAI	13545	84, 120
750030	PAI	13547	84, 120
750341	PAI	13524	82, 210
750350	PAI	13550	85
750500	PAI	13649	15, 89, 122, 170
750501	PAI	13650	15, 59, 89, 122, 262
750510	PAI	13626	42, 88, 121, 169, 199, 262
750512	PAI	13601	87, 121
750512	PAI	13721	93, 124
750512	PAI	13722	8, 93, 124
751709	Westar	18860	8, 171, 265, 312
751759PU	Westar	18232	61, 265
753997C91	International	10020	113
753997C92	International	10020	113
753997C93	International	10020	113
759832C1	International	13649	122
7617	Trailmobile	17538	284
762000	Hutchens	13001	100
762000	Hutchens	13042	100
762000	Hutchens	14003	100
762000	Trailmobile	13001	229
763700	Trailmobile	13042	230
7807231C1	International	34505	132
780723C1	International	10012	113
780723C7	International	10013	113
790337C1	International	14527	125
800009	Chalmers	18921	10
800010	Chalmers	11739	10
8021378	Volvo	31095	271
8028945	Volvo	31095	271
80446	International	10005	112
80446	International	10007	112
8067784	Volvo	18599	265
8071851	Volvo	31095	271
8074268	Volvo	31095	271
80744666	Volvo	12340	260
8079894	Volvo	13522	261
8079894	Volvo	83522	274
80AX641	Mack	17501	281
815010	Neapco	40075	6, 17, 46, 62, 96, 136, 157, 172, 201, 225, 274
8151413	Volvo	12333	260
8152450	Volvo	31093	271
816010	Neapco	40074	6, 8, 17, 46, 62, 136, 157, 172, 200, 274
820183	Eaton	17538	284
82024	New Flyer	33502	250
834240	Volvo	31096	272
836940	Kenworth	11729	150
836940	Peterbilt	11729	194
838961	Volvo	17501	264
839310	Peterbilt	11729	194
8446R005422	Mack	50033	172
8446S24736	Mack	13623	328

Cross Reference continued

OEM	Brand	Part Id	Page
8574FL	Freightliner	11097	37
867499R1	International	17506	126
868331	Volvo	11556	258
868331	Volvo/White/GMC	13522	261
868331	Volvo/White/GMC	83522	274
868789R91	International	13592	121
89000	Hutchens	14027	101
893059R92	International	13534	120
8G18123	MCI	18944	242
8G186146	MCI	18943	242
90001002	International	13609	121
90001002	Neway	13609	183
90008002	Neway	14504	184
90008003	Neway	18566	186
90008005	Neway	14532	186
90008006	Neway	31592	186
90008008	Neway	14527	185
90008008	Neway	14527	185
90008104	Neway	14526	185
90008131	Neway	14510	184
90008139	Neway	14513	185
90008148	Neway	14529	186
90008149	International	14533	125
90008149	Neway	14533	186
90008151	Neway	14514	185
90008247	Neway	50046	186
90022099	Ottawa	11554	147, 193
90044638	Neway	13695	184
903001	Energy Suspension	13501	13, 58, 80, 118, 217, 230, 260
903002	Energy Suspension	13553	14, 58, 85, 120, 155, 210, 217, 230, 261
9030595D000	Ridewell	19002	218
9031211B302	Ridewell	19003	218
9031221B302	Peterbilt	19003	200
9031221B303	Ridewell	19003	218
9031797D000	Ridewell	19002	218
904003	Energy Suspension	11515	144, 293
904004	Energy Suspension	11517	293
906011	Energy Suspension	14522	185, 211, 232, 275
906013	Energy Suspension	13037	54, 230, 275
907001	Energy Suspension	13522	42, 82, 119, 154, 169, 199, 261
907001	Energy Suspension	83522	46, 95, 136, 157, 172, 201, 274
907010	Energy Suspension	15013	94, 125, 213, 232, 264
907023	Energy Suspension	13520	5, 82, 119, 154, 169, 198, 239, 261, 279
907023	Energy Suspension	13536	5, 83, 120, 155, 169, 199, 239, 279
907023	Energy Suspension	83520	7, 95, 136, 157, 172, 201, 218, 251, 280
907024	Energy Suspension	13522	42, 82, 119, 154, 169, 199, 261
907024	Energy Suspension	83522	46, 95, 136, 157, 172, 201, 274
908003	Energy Suspension	18566	44, 56, 127, 156, 171, 186, 200, 279
908004	Energy Suspension	18566	44, 56, 127, 156, 171, 186, 200, 279
908005	Energy Suspension	11550	147, 193
908005	Energy Suspension	18244	156, 200, 234
909053	Energy Suspension	12357	196
909053	Energy Suspension	12381	198
91008004	Neway	14502	184
91008005	Neway	14502	184
91008006	Neway	14523	185
91008022	Neway	14521	185
91008023	Neway	14500	184

OEM	Brand	Part Id	Page
91008024	Neway	14501	184
91008033	Neway	14524	185
91028013	Neway	14522	185
91028039	Neway	14505	184
91028051	Neway	14509	184
91028089	Neway	14522	185
911404	Thermo King	50056	301
912578	Thermo King	50056	301
912618	Thermo King	12380	300
914043	Thermo King	50055	301
914159	Thermo King	12380	300
914195	Thermo King	50055	301
917709	Thermo King	50056	301
924175	Peterbilt	12395	198
924711	Clevite	13657	7, 223, 279, 308
924920	Clevite	34556	45, 95, 136, 172, 224, 273, 312
924970	Clevite	12074	117, 168, 307
925000	Clevite	11078	35, 304
925030	Clevite	11751	4, 41, 78, 117, 151, 163, 223, 304
925031	Kenworth	11080	142
925031	Peterbilt	11080	192
925050	Clevite	11152	40, 304
925150	Kenworth	13679	155
925150	Peterbilt	13679	199
927620	Thermo King	18015	301
928610	Clevite	13683	43, 90, 122, 308
928630	Clevite	13686	43, 91, 122, 262, 309
928660	Clevite	13691	43, 91, 123, 262, 309
928661	Clevite	13691	43, 91, 123, 262, 309
928665	Clevite	13703	93, 124, 311
928666	Clevite	13702	93, 311
928668	Clevite	13704	93, 311
928680	Clevite	13694	43, 92, 123, 262, 310
928681	Clevite	13695	43, 92, 123, 184, 263, 310
928690	Clevite	13696	43, 92, 123, 263, 310
928691	Clevite	13697	43, 92, 123, 263, 310
928700	Clevite	13698	59, 92, 123, 310
928701	Clevite	13699	59, 92, 123, 310
928834	Clevite	12071	79, 168, 306
928893	Thermo King	18015	301
932244694	Ford	11556	13
932246735	Ford	12031	13
932420	Kenworth	11511	144
937530	Clevite	11792	153, 195, 305
937560	Clevite	12397	153, 198, 307
937561	Clevite	11795	153, 195, 305
942119	Clevite	12074	117, 168, 307
942174	Clevite	34556	45, 95, 136, 172, 224, 273, 312
942690	Clevite	13700	92, 124, 310
943711	Peterbilt	12398	198
943763	Clevite	12072	168, 306
943790	Clevite	12074	117, 168, 307
943853	Clevite	13634	89, 170, 308
943885	Clevite	11078	35, 304
943886	Clevite	11153	40, 304
943902	Volvo	31095	271
944160	Clevite	34556	45, 95, 136, 172, 224, 273, 312
944220	Clevite	34556	45, 95, 136, 172, 224, 273, 312
944270	Kenworth	11751	151

Cross Reference continued

OEM	Brand	Part Id	Page
945240	Clevite	12074	117, 168, 307
945381	Clevite	11080	116, 142, 162, 192, 277, 304
947106	Clevite	11081	35, 304
947790	Clevite	12395	182, 198, 307
948574	Clevite	34556	45, 95, 136, 172, 224, 273, 312
965080R1	International	13500	118
979992033	Flxible	33503	250
985211	Western Star	18566	279
987395A2	International	10011	112
991433	Thermo King	50053	301
991790A	Volvo	40075	274
A0111166000	Freightliner	11013	33
A1225G1437	Arvin Meritor	50031	6
A1225L1416	Arvin Meritor	34514	6
A1225L1416	Arvin Meritor	50032	6
A1225N1522	Arvin Meritor	13599	5
A1225V438	Arvin Meritor	17574	5
A13102146A	Arvin Meritor	11751	4
A1601005002	Freightliner	18566	44
A1610549	Freightliner	11000	31
A1610549	Freightliner	11064	34
A1611351	Freightliner	11002	32
A16119448	Freightliner	11004	32
A16119448	Freightliner	13521	42
A1612301000	Freightliner	18600	45
A1615303000	Freightliner	31624	45
A1615773000	Freightliner	31624	45
A1710464001	Freightliner	11020	33
A1712	Hendrickson	15013	94
A1712	Hendrickson	15063	94
A1712	Transpro	15013	232
A1713666000	Freightliner	11124	39
A1715140000	Freightliner	11145	39
A2297J1050	Arvin Meritor	11716	4
A2297K1052	Arvin Meritor	11735	4
A2297K1052	Kenworth	11512	144
A2297K1052	Kenworth	11514	144
A2297K1052	Kenworth	11735	150
A2297V4806	Arvin Meritor	11735	4
A2297V4806	Kenworth	11512	144
A2297V4806	Kenworth	11514	144
A2297V4806	Kenworth	11735	150
A2297Y77A	Arvin Meritor	13520	5
A2297Y77A	Arvin Meritor	13536	5
A2297Y77A	Arvin Meritor	83520	7
A3580010635	Autocar	13679	8
A6805040382	Freightliner	11144	39
A6805040382	Freightliner	11117	38
A6818900001	Freightliner	11009	33
A6818900001	Freightliner	11086	36
A6818900001	Sterling Truck	11009	220
A6818900001	Sterling Truck	11086	221
A6818910001	Freightliner	11008	32
A6818910001	Freightliner	11086	36
A6818910001	Sterling Truck	11008	220
A6818910001	Sterling Truck	11086	221
A6914	Hendrickson	13510	81
A70BL9995	Severson	12360	196
A80BL0010	Severson	14510	184, 231
A80BL0011	Severson	11517	293
A80BL0013	Severson	10026	114
A80BL0020	Severson	15016	213, 232
A80BL0026	Severson	14001	210, 230
A80BL0160	Severson	13009	54, 229
A80BL0205	Severson	11005	12, 32, 115
A80BL1001	Severson	11502	143
A80BL1001	Severson	11719	149
A80BL1004	Severson	12000	163

OEM	Brand	Part Id	Page
A80BL1005	Severson	18232	61, 265
A80BL1007	Severson	18222	61, 265
A80BL1009	Severson	11062	142, 192
A80BL1019	Severson	12023	164
A80BL1024	Severson	11085	35
A80BL1024	Severson	11725	41
A80BL1025	Severson	14000	55, 100, 210, 230
A80BL1026	Severson	14008	55, 100, 199, 211, 231, 263, 275
A80BL1026	Severson	14073	55, 102, 211, 231, 275
A80BL1029	Severson	13505	14, 58, 80, 118, 230, 261
A80BL1029	Severson	13543	14, 84, 210, 261
A80BL1030	Severson	13592	14, 58, 86, 121, 262
A80BL1031	Severson	13650	15, 59, 89, 122, 262
A80BL1032	Severson	13500	13, 58, 79, 118, 217, 260
A80BL1033	Severson	13501	13, 58, 80, 118, 217, 230, 260
A80BL1034	Severson	13649	15, 89, 122, 170
A80BL1038	Severson	18063	126
A80BL1040	Severson	15008	125, 212, 232
A80BL1040	Severson	15020	213
A80BL1041	Severson	15051	213, 233
A80BL1042	Severson	15011	213
A80BL1042	Severson	15019	213
A80BL1042	Severson	15073	214
A80BL1043	Severson	15013	94, 125, 213, 232, 264
A80BL1046	Severson	12014	164
A80BL1047	Severson	12006	164
A80BL1047	Severson	12040	166
A80BL1048	Severson	12029	165
A80BL1049	Severson	12015	164, 258
A80BL1050	Severson	13005	54
A80BL1050	Severson	13007	54
A80BL1051	Severson	13001	54, 100, 229
A80BL1051	Severson	14003	55, 100, 211, 231
A80BL1052	Severson	14011	100, 231
A80BL1054	Severson	11549	147
A80BL1055	Severson	13522	42, 82, 119, 154, 169, 199, 261
A80BL1055	Severson	83522	46, 95, 136, 157, 172, 201, 274
A80BL1056	Severson	13520	5, 82, 119, 154, 169, 198, 239, 261, 279
A80BL1056	Severson	13536	5, 83, 120, 155, 169, 199, 239, 279
A80BL1056	Severson	83520	7, 95, 136, 157, 172, 201, 218, 251, 280
A80BL1058	Severson	13518	81, 119, 154, 183, 198, 261
A80BL1064	Severson	10002	293
A80BL16045	Severson	11515	144, 293
A80BL2000	Severson	17674	284
A80BL2001	Severson	17675	284
A80BL2052	Severson	12350	195
A80BL2202	Severson	11612	148
A80BL2204	Severson	11545	147, 162
A80BL2205	Severson	12366	197, 279
A80BL2207	Severson	12367	197
A80BL2208	Severson	10020	31, 113
A80BL2212	Severson	11533	145, 278
A80BL2213	Severson	11520	40, 145, 192, 222, 278
A80BL2213	Severson	11523	40, 145, 192, 223, 278
A80BL30041	Severson	11500	143, 217
A80BL30041	Severson	19004	157, 218
A80BL3009	Severson	11501	143

Cross Reference continued

OEM	Brand	Part Id	Page
A80BL3014	Severson	12028	165
A80BL3020	Severson	14027	101, 231
A80BL3022	Severson	18575	294
A80BL3023	Severson	18574	294
A80BL3026	Severson	18558	234, 294
A80BL3030	Severson	14521	185, 211, 232, 275
A80BL3537	Severson	13659	89, 240
A80BL3557	Severson	11537	40, 146, 192
A80BL3557	Severson	11613	41, 148, 193
A80BL3558	Severson	18566	44, 56, 127, 156, 171, 186, 200, 279
A80BL3560	Severson	13553	14, 58, 85, 120, 155, 210, 217, 230, 261
A80BL3561	Severson	15001	125, 212
A80BL3561A	Severson	15000	212
A80BL3590	Severson	11535	146
A80BL3591	Severson	11539	146, 193
A80BL3591	Severson	11614	148, 193
A80BL3591	Severson	11761	151, 194
A80BL3593	Severson	12355	153, 196
A80BL3594	Severson	11709	149, 194
A80BL3596	Severson	11705	116, 149, 194, 278
A80BL5698	Severson	11512	144
A80BL5698	Severson	11514	144
A80BL5698	Severson	11735	4, 150
A80BL6735	Severson	12031	13, 79, 117, 165
A80BL6998	Severson	18786	200
A80BL7691	Severson	11004	32, 77, 115, 142, 162, 192
A80BL7691	Severson	13521	42, 82, 119, 154, 169, 198
A80BL8004	Severson	11554	147, 193
A80BL8007	Severson	10075	12, 114, 258
A80BL8008	Severson	12356	196
A80BL8009	Severson	18921	10
A80BL8010	Severson	11739	10, 117
A80BL8011	Severson	18919	10
A80BL8139	Severson	14513	44, 55, 125, 170, 185, 223, 232, 263, 275
A80BL8149	Severson	14533	44, 125, 170, 186, 223, 232, 263, 275
A80BL8663	Severson	13009	54, 229
A80BL8664	Severson	13037	54, 230, 275
A80BL8666	Severson	14038	102
A80BL8667	Severson	12010	164
A80BL8669	Severson	14522	185, 211, 232, 275
A80BL8670	Severson	14522	185, 211, 232, 275
A80BL8677	Severson	14504	124, 184, 211, 240
A80BL8679	Severson	14509	184, 211
A80BL8681	Severson	14527	125, 185
A80BL8688	Severson	15017	213, 232, 264
A80BL8689	Severson	15009	170, 212
A80BL8691	Severson	15005	212
A80BL8694	Severson	15020	213
A80RD3595	Severson	11550	147, 193
A90BL0105	Severson	11502	143
A90BL0105	Severson	11719	149
A90BL1075	Severson	11002	32
A90BL2366	Severson	11502	143
A90BL2366	Severson	11719	149
ABP1	Automann	12006	164
ABP1UB	Automann	12006	164
ABP1UB	Automann	12040	166
ABP2	Automann	12014	164
ABP2UB	Automann	12014	164
ABP4	Automann	12010	164
ABP4UB	Automann	12010	164
ABP5	Automann	12053	167
ABP6	Automann	12009	164
ABP6UB	Automann	12009	164

OEM	Brand	Part Id	Page
ABP6UB	Automann	12040	166
ABP8	Automann	12009	164
ABP8	Automann	12040	166
ACA3266	Fruehauf	17574	56
ACD2285900	Fruehauf	17668	56
AK34100	Atro	13502	80, 118, 210
AK38200	Atro	13609	14, 87, 121, 183, 210
AK45100	Atro	13610	88, 121
AK50100	Atro	13547	84, 120
AK5045000	Atro	13610	88, 121
AK65100	Atro	13549	85
AM52137	International	10009	112
ASF032947	Holland	10080	293
ASF035807	Holland	10001	293
AT80000	Atro	13513	169, 239
ATP032803	Holland	40056	295
AW5710000	Atro	14505	184
AW5712000	Atro	14509	184, 211
AXA0413900	Fruehauf	17505	56
AXA0429900	Fruehauf	17502	56
AZ1484006	International	30517	128
B11613	Hendrickson	13542	84
B116322	Flagg	19001	16, 62, 127, 242
B120543	Flagg	19001	16, 62, 127, 242
B131455	Flagg	19001	16, 62, 127, 242
B136359	Flagg	11060	116, 142
B137259	Flagg	11757	151
B140846	Flagg	18600	45
B140946	Flagg	18600	45
B142462	Flagg	12043	166
B143555	Flagg	19001	16, 62, 127, 242
B144255	Flagg	19001	16, 62, 127, 242
B144546	Flagg	18600	45
B150950	Flagg	13555	85, 262
B1581	Eaton	17501	281
B2021	Eaton	17503	282
B2021	Eaton	17538	284
B21099	Hendrickson	13648	89
B651001	Kenworth	11758	151
B651005	Kenworth	11757	151
B651006	Kenworth	11753	151
B651007	Kenworth	11763	152
B651012	Kenworth	11763	152
B651017001	Kenworth	11753	151
B656005	Kenworth	11767	152
B656005	Peterbilt	11767	195
B7120411	MCI	18865	241
B806	Sirco	18992	285
B8600A	Sirco	17501	281
B8623	Sirco	17502	282
B8QH2237A	Ford	17501	16
B8QH5873A	Ford	13553	14
BA122	Automann	13566	86, 262
BA122UB	Automann	13566	86, 262
BA123	Automann	13566	86, 262
BA49	Flagg	13566	86, 262
BA50	Flagg	13566	86, 262
BCD267012	Freightliner	11077	35
BCD267012	Freightliner	11089	36
BCD267041	Freightliner	11074	35
BCD267041	Freightliner	11090	36
BCD267041	Freightliner	11074	35
BCD267041	Freightliner	11090	36
BCD267041	Sterling Truck	11074	221
BCD267041	Sterling Truck	11090	222
BCD267041	Sterling Truck	11074	221
BCD267041	Sterling Truck	11090	222
BCD27330	Freightliner	11077	35
BCD273301	Freightliner	11089	36

Cross Reference continued

OEM	Brand	Part Id	Page
BCD273301	Freightliner	11077	35
BCD273301	Freightliner	11077	35
BCD273301	Freightliner	11089	36
BCD273301	Sterling Truck	11089	222
BCD273301	Sterling Truck	11077	221
BCD273301	Sterling Truck	11077	221
BCD273301	Sterling Truck	11089	222
BCD273302	Freightliner	11089	36
BCD273302	Freightliner	11077	35
BCD273302	Freightliner	11077	35
BCD273302	Freightliner	11077	35
BCD273302	Freightliner	11089	36
BCD273302	Sterling Truck	11089	222
BCD274772	Freightliner	11089	36
BCD274772	Freightliner	34525	45
BCD276511	Freightliner	11074	35
BCD276511	Freightliner	11090	36
BCD276511	Freightliner	11074	35
BCD276511	Freightliner	11090	36
BCD276511	Sterling Truck	11074	221
BCD276511	Sterling Truck	11090	222
BCD276511	Sterling Truck	11074	221
BCD276511	Sterling Truck	11090	222
BCD276512	Freightliner	11074	35
BCD276512	Freightliner	11090	36
BCD276512	Freightliner	11074	35
BCD276512	Freightliner	11090	36
BCD276512	Sterling Truck	11074	221
BCD276512	Sterling Truck	11090	222
BCD276512	Sterling Truck	11074	221
BCD276512	Sterling Truck	11090	222
BCD276512	Sterling Truck	11074	221
BCD276512	Sterling Truck	11090	222
BCD276513	Freightliner	11074	35
BCD276513	Freightliner	11090	36
BCD276513	Freightliner	11074	35
BCD276513	Freightliner	11090	36
BCD276513	Sterling Truck	11074	221
BCD276513	Sterling Truck	11090	222
BCD276513	Sterling Truck	11074	221
BCD276513	Sterling Truck	11090	222
BCD276513	Sterling Truck	11074	221
BCD276513	Sterling Truck	11090	222
BCD287211	Freightliner	11129	39
BCD288051	Freightliner	11089	36
BCD288051	Freightliner	11077	35
BCD288051	Freightliner	11089	36
BCD288051	Sterling Truck	11089	222
BCD288051	Sterling Truck	11077	221
BCD288051	Sterling Truck	11089	222
BCD288471	Freightliner	11129	39
BCD288471	Sterling Truck	11129	222
BCD289451	Freightliner	11074	35
BCD289451	Freightliner	11090	36
BCD289451	Freightliner	11074	35
BCD289451	Freightliner	11090	36
BCD289451	Sterling Truck	11074	221
BCD289451	Sterling Truck	11090	222
BCD289451	Sterling Truck	11074	221
BCD289451	Sterling Truck	11090	222
BCD289451	Sterling Truck	11074	221
BF85781A	Ford	17276	15
BF85781B	Ford	17275	15
BJ1769	Freightliner	11075	35
BJ1769	Freightliner	11110	38
BP198	Automann	13607	59, 87, 121
BP198HE	Automann	13607	59, 87, 121
BP198UB	Automann	13607	59, 87, 121
BP200	Automann	13596	87
BP200	Automann	83596	8, 62, 95, 136
BP87	Flagg	13607	59, 87, 121
BP87	Flagg	83596	8, 62, 95, 136
BP88	Flagg	13596	87
BP88	Flagg	83596	8, 62, 95, 136
BPK100	Automann	13555	85, 262
BSH109L	Fontaine	10079	293

OEM	Brand	Part Id	Page
BSH150	Fontaine	10002	293
BSH172U	Fontaine	10079	293
BSHLWSL	Fontaine	10079	293
C131005	Kenworth	11743	150
C131007	Kenworth	11742	150
C136001	Kenworth	11765	152
C136001	Peterbilt	11765	195
C136002	Kenworth	11764	152
C136002	Peterbilt	11764	194
C2000	Automann	13656	89, 122
C2316270	Miscellaneous	18753	324
C2TZ5780B	Ford	19001	16
C2TZ5781A	Ford	19001	16
C3558	Hendrickson	13565	85
C3TZ4613C	Ford	11716	13
C3TZ54599A	Ford	13592	14
C3TZ5899B	Ford	13650	15
C3TZ5A598A	Ford	13592	14
C5TZ3B203B	Ford	17251	15
C651008	Kenworth	11793	153
C651009	Kenworth	11793	153
C65329	Haldex	17501	281
C65380	Haldex	17502	282
C656000001	Kenworth	12397	153
C656000001	Peterbilt	12397	198
C656000002	Kenworth	11795	153
C656000002	Peterbilt	11795	195
C656002	Kenworth	11792	153
C656002	Peterbilt	11792	195
C656009	Kenworth	11792	153
C656009	Peterbilt	11792	195
C656011001	Kenworth	12397	153
C656011001	Peterbilt	12397	198
C656011002	Kenworth	11795	153
C656011002	Peterbilt	11795	195
C656013	Peterbilt	34554	200
C656016000010440	Peterbilt	12395	198
C66646	Haldex	17529	283
C67018	Haldex	18439	285
C862	Flagg	13553	14, 58, 85, 120, 155, 210, 217, 230, 261
C862UB	Flagg	13553	14, 58, 85, 120, 155, 210, 217, 230, 261
C863	Flagg	13505	14, 58, 80, 118, 230, 261
C864	Flagg	13500	13, 58, 79, 118, 217, 260
C865	Flagg	13501	13, 58, 80, 118, 217, 230, 260
C865UB	Flagg	13501	13, 58, 80, 118, 217, 230, 260
C866	Flagg	13537	14, 83, 261
C866U	Flagg	13537	14, 83, 261
C866UB	Flagg	13537	14, 83, 261
C867	Flagg	13543	14, 84, 210, 261
C867UB	Flagg	13543	14, 84, 210, 261
C868	Flagg	13526	14, 82, 169
C870	Flagg	13514	81, 118, 154, 198
C871	Flagg	13553	14, 58, 85, 120, 155, 210, 217, 230, 261
C872	Flagg	13545	84, 120
C873	Flagg	13544	84
C874	Flagg	13592	14, 58, 86, 121, 262
C874UB	Flagg	13592	14, 58, 86, 121, 262
C875	Flagg	13560	85
C876	Dallas Spring	13500	13, 58, 79, 118, 217, 260
C877	Flagg	13505	14, 58, 80, 118, 230, 261
C878	Flagg	13522	42, 82, 119, 154, 169, 199, 261

Cross Reference continued

OEM	Brand	Part Id	Page
C878	Flagg	83522	46, 95, 136, 157, 172, 201, 274
C878UB	Flagg	13522	42, 82, 119, 154, 169, 199, 261
C878UB	Flagg	83522	46, 95, 136, 157, 172, 201, 274
C879	Flagg	13520	5, 82, 119, 154, 169, 198, 239, 261, 279
C879	Flagg	83520	7, 95, 136, 157, 172, 201, 218, 251, 280
C879UB	Flagg	13520	5, 82, 119, 154, 169, 198, 239, 261, 279
C879UB	Flagg	13536	5, 83, 120, 155, 169, 199, 239, 279
C879UB	Flagg	83520	7, 95, 136, 157, 172, 201, 218, 251, 280
C880	Flagg	13517	81, 119, 183
C881	Flagg	13516	81, 119, 183
C883	Flagg	13518	81, 119, 154, 183, 198, 261
C883UB	Flagg	13518	81, 119, 154, 183, 198, 261
C884	Flagg	12031	13, 79, 117, 165
C885	Flagg	13684	90, 122, 183
C886	Flagg	13512	14, 81
C887	Flagg	13505	14, 58, 80, 118, 230, 261
C888	Flagg	13543	14, 84, 210, 261
C889	Flagg	13528	83, 119, 154, 183, 199, 239
C890	Flagg	13627	88
C8TZ6038B	Ford	11022	12
C8TZ6068B	Ford	18433	16
C8TZ6068B	Freightliner	18433	44
C8TZ6068B	Sterling Truck	18433	224
C9HS5872A	Ford	13537	14
C9HS5872A	Ford	13543	14
CA293	Kenworth	11502	143
CA293	Kenworth	11719	149
CA3686	Kenworth	11550	147
CB112110	Freightliner	11544	40
CB112110	Freightliner	18837	45
CB2101211X	Arvin Meritor	40075	6
CB2101211XSA	Arvin Meritor	40075	6
CB2106611XSA	Arvin Meritor	40074	6
CB2106611XSA	International	40074	136
CB2106611XSA	Kenworth	40074	157
CB2106611XSA	Peterbilt	40074	200
CB220212	Lord	18015	44, 224, 279, 301
CB2203105A	Lord	12026	165
CB22032	Peterbilt	18786	200
CB220370	Peterbilt	12368	197
CB220372	Peterbilt	12369	197
CB220377	Peterbilt	12368	197
CB220378	Peterbilt	12368	197
CB27500	Atro	13526	14, 82, 169
CB34010	Atro	13537	14, 83, 261
CB34011	Atro	13537	14, 83, 261
CB34012	Atro	13500	13, 58, 79, 118, 217, 260
CB38010	Atro	13543	14, 84, 210, 261
CB38011	Atro	13543	14, 84, 210, 261
CB38012	Atro	13505	14, 58, 80, 118, 230, 261
CB50000	Atro	13544	84
CB50011	Atro	13544	84
CB65002	Atro	13658	89
CB65011	Atro	13658	89
CBA2465017	Freightliner	11725	41
CBA2465017	Freightliner	11085	35
CBA2465027	International	10016	113

OEM	Brand	Part Id	Page
CBA281050	Freightliner	11707	41
CCB101	Arvin Meritor	40075	6
CHA03	Flagg	11740	10
CHA22	Flagg	18919	10
CHA22UB	Flagg	18919	10
CHA23	Flagg	18920	10
CHA53	Flagg	18921	10
CHA54	Flagg	11739	10, 117
CHA54UB	Flagg	11739	10, 117
CM4661001	Atro	11086	36, 221
CM4661384	Atro	11110	38
CM4661890	Atro	11009	33, 220
CM4661891	Atro	11008	32, 220
CM5561454	Atro	34540	135
CM55614C4	Atro	34528	134
CM55615C2	Atro	34515	133
CM7561257	Atro	12360	196
COAZ5719A	Ford	17251	15
COM266	Kenworth	11550	147
COM266	Kenworth	18244	156
COM266	Peterbilt	11550	193
COM266	Peterbilt	18244	200
COM3686	Kenworth	11550	147
COM3686	Kenworth	18244	156
CS70815	Haldex	11729	78, 116, 150, 194
D063	Dyco	12028	165
D065	Dyco	12047	167
D069	Dyco	15001	125, 212
D0HZ5780B	Ford	19001	16
D1	Dyco	18566	44, 56, 127, 156, 171, 186, 200, 279
D10	Dyco	12367	197
D100	Dyco	13001	54, 100, 229
D100	Dyco	14003	55, 100, 211, 231
D101	Dyco	14038	102
D102	Dyco	11020	33
D107	Dyco	13592	14, 58, 86, 121, 262
D108	Dyco	11615	149, 194
D108	Dyco	11762	152, 194
D111	Dyco	11540	146
D111	Dyco	11760	151
D113	Dyco	11615	149, 194
D113	Dyco	11762	152, 194
D114	Dyco	11541	146
D114	Dyco	11760	151
D13	Dyco	12350	195
D1310011	Barry Controls	11540	146
D1310011	Barry Controls	11760	151
D1310011	Kenworth	11541	146
D1310011	Kenworth	11760	151
D134	Dyco	13649	15, 89, 122, 170
D135	Dyco	13650	15, 59, 89, 122, 262
D14	Dyco	12351	195
D142	Dyco	12026	165
D143	Dyco	12004	163
D145	Dyco	12017	164
D15	Dyco	11554	147, 193
D150	Dyco	11500	143, 217
D150	Dyco	19004	157, 218
D154	Dyco	11501	143
D16	Dyco	12363	196
D17	Dyco	18102	200, 279
D186	Dyco	11739	10, 117
D187	Dyco	18919	10
D187	Dyco	18920	10
D188	Dyco	18921	10
D2	Dyco	12366	197, 279
D20	Dyco	18786	200
D2001	Dyco	11720	149

Cross Reference continued

OEM	Brand	Part Id	Page
D2002	Dyco	11720	149
D2003	Dyco	13601	87, 121
D2003	Dyco	13721	93, 124
D2003	Dyco	13722	8, 93, 124
D203	Dyco	10002	293
D21	Dyco	11535	146
D214	Dyco	13005	54
D214	Dyco	13041	55
D215	Dyco	13009	54, 229
D217	Dyco	13037	54, 230, 275
D218	Dyco	13009	54, 229
D22	Dyco	11539	146, 193
D22	Dyco	11614	148, 193
D22	Dyco	11761	151, 194
D231	Dyco	14522	185, 211, 232, 275
D232	Dyco	14521	185, 211, 232, 275
D235	Dyco	14510	184, 231
D237	Dyco	14527	125, 185
D24	Dyco	11709	149, 194
D240	Dyco	14504	124, 184, 211, 240
D244	Dyco	11512	144
D244	Dyco	11514	144
D244	Dyco	11735	4, 150
D250	Dyco	18558	234, 294
D25364	Hendrickson	13594	87
D26	Dyco	11545	147, 162
D27	Dyco	11612	148
D280	Automann	12002	163
D283	Dyco	12053	167
D284	Dyco	12009	164
D284	Dyco	12040	166
D285	Dyco	12006	164
D285	Dyco	12040	166
D286	Dyco	12014	164
D288	Dyco	12010	164
D293	Dyco	12031	13, 79, 117, 165
D293S	Dyco	12031	13, 79, 117, 165
D2HS5732AA	Ford	13649	15
D30	Dyco	11533	145, 278
D301	Dyco	10505	115
D309	Dyco	34505	132
D310	Dyco	34506	132
D312	Dyco	13515	81, 119, 154, 183
D316	Dyco	13514	81, 118, 154, 198
D322	Dyco	30545	280
D324	Dyco	12301	259, 278
D325	Dyco	11554	147, 193
D326	Dyco	11707	41, 149, 194
D326	Dyco	12355	153, 196
D328	Dyco	11539	146, 193
D328	Dyco	11614	148, 193
D328	Dyco	11761	151, 194
D34	Dyco	11549	147
D35	Dyco	11502	143
D35	Dyco	11719	149
D352	Dyco	14522	185, 211, 232, 275
D356	Dyco	14509	184, 211
D35OZ	Dyco	11719	149
D36	Dyco	11705	116, 149, 194, 278
D37	Dyco	11550	147, 193
D39	Dyco	11062	142, 192
D3HA6038AA	Ford	18694	16
D3HZ6038A	Ford	18694	16
D4	Dyco	11707	41, 149, 194
D40	Dyco	10011	112
D401	Dyco	13505	14, 58, 80, 118, 230, 261
D401	Dyco	13543	14, 84, 210, 261
D402	Dyco	13553	14, 58, 85, 120, 155, 210, 217, 230, 261

OEM	Brand	Part Id	Page
D403	Dyco	13500	13, 58, 79, 118, 217, 260
D403	Dyco	13537	14, 83, 261
D404	Dyco	13501	13, 58, 80, 118, 217, 230, 260
D404	Dyco	13501	13, 58, 80, 118, 217, 230, 260
D405	Dyco	11004	32, 77, 115, 142, 162, 192
D405	Dyco	13521	42, 82, 119, 154, 169, 198
D406	Dyco	13517	81, 119, 183
D41	Dyco	10020	31, 113
D410	Dyco	13659	89, 240
D42	Dyco	10026	114
D421	Dyco	11003	32
D421	Dyco	13522	42, 82, 119, 154, 169, 199, 261
D421	Dyco	83522	46, 95, 136, 157, 172, 201, 274
D422	Dyco	13518	81, 119, 154, 183, 198, 261
D422	Dyco	13533	83, 120, 183, 261, 279
D423	Dyco	13520	5, 82, 119, 154, 169, 198, 239, 261, 279
D423	Dyco	13536	5, 83, 120, 155, 169, 199, 239, 279
D423	Dyco	83520	7, 95, 136, 157, 172, 201, 218, 251, 280
D424	Dyco	13528	83, 119, 154, 183, 199, 239
D425	Dyco	13526	14, 82, 169
D426	Dyco	13512	14, 81
D429	Dyco	11063	34
D430	Dyco	10075	12, 114, 258
D432	Dyco	11537	40, 146, 192
D432	Dyco	11613	41, 148, 193
D433	Dyco	31592	171, 186
D437	Dyco	13577	120
D44	Dyco	18063	126
D440	Dyco	14514	185
D441	Dyco	14513	44, 55, 125, 170, 185, 223, 232, 263, 275
D443	Dyco	12360	196
D448	Dyco	14533	44, 125, 170, 186, 223, 232, 263, 275
D46	Dyco	11005	12, 32, 115
D48	Dyco	11085	35
D48	Dyco	11725	41
D49	Dyco	11000	31
D49	Dyco	11064	34
D4TZ4800G	Ford	40075	17
D4TZ4800J	Ford	40074	17
D5	Dyco	11705	116, 149, 194, 278
D50	Dyco	11002	32
D51	Dyco	11705	116, 149, 194, 278
D53	Dyco	10503	115
D534	Dyco	12359	196
D54	Dyco	18232	61, 265
D540	Dyco	11707	41, 149, 194
D542	Dyco	11544	40, 162
D542	Dyco	18837	45, 171
D56	Dyco	18222	61, 265
D58	Dyco	12354	195
D59	Dyco	15016	213, 232
D6	Dyco	11520	40, 145, 192, 222, 278
D6	Dyco	11523	40, 145, 192, 223, 278
D60	Dyco	12000	163

Cross Reference continued

OEM	Brand	Part Id	Page
D61	Dyco	12029	165
D62	Dyco	12015	164, 258
D63	Dyco	12028	165
D64	Dyco	12032	165
D65	Dyco	12046	167
D65	Dyco	12047	167
D66	Dyco	12023	164
D69	Dyco	15001	125, 212
D7	Dyco	11537	40, 146, 192
D7	Dyco	11613	41, 148, 193
D70	Dyco	15051	213, 233
D70BL1088	Severson	11064	34
D71	Dyco	15011	213
D71	Dyco	15019	213
D71	Dyco	15073	214
D72	Dyco	15008	125, 212, 232
D73	Dyco	15013	94, 125, 213, 232, 264
D74B	Dyco	17534	284
D74B	Dyco	17674	284
D74R	Dyco	17534	284
D74R	Dyco	17675	284
D76	Dyco	15017	213, 232, 264
D79	Dyco	15020	213
D82	Dyco	12357	196
D82	Dyco	12381	198
D83	Dyco	12369	197
D86	Dyco	11733	150
D86	Dyco	11734	150
D86	Dyco	11766	152
D89	Dyco	11515	144, 293
D9	Dyco	12356	196
D90	Dyco	11517	293
D94	Dyco	14008	55, 100, 199, 211, 231, 263, 275
D94	Dyco	14073	55, 102, 211, 231, 275
D95	Dyco	14000	55, 100, 210, 230
D97	Dyco	14027	101, 231
D99	Dyco	14011	100, 231
D9TZ3B283A	Ford	17250	15
DA9017B	HalDEX	17674	284
DA9017R	HalDEX	17675	284
DLS118634	Automann	13541	84
DOHZ570800B	Ford	19001	16
DOHZ6068B	Ford	10075	12
DS6048	Westar	40075	6, 17, 46, 62, 96, 136, 157, 172, 201, 225, 274
DS6049	Westar	40074	6, 8, 17, 46, 62, 136, 157, 172, 200, 274
DT1610	Dyco	13594	87
E10057	Euclid	15020	213
E10057	Meritor	15020	213
E1018	Euclid	13015	54, 229
E1019	Euclid	13011	54, 229
E1020	Euclid	13005	54
E1023	Euclid	13042	55, 100, 230
E1024	Euclid	13041	55
E10302	Euclid	11720	149
E10303	Euclid	11729	78, 116, 150, 194
E10303	Euclid	11729	78, 116, 150, 194
E10309	Euclid	13582	86, 121
E10310	Euclid	13683	43, 90, 122, 308
E10313	Euclid	13687	91, 309
E10314	Euclid	13688	91, 309
E10317	Euclid	13695	43, 92, 123, 184, 263, 310
E10319	Euclid	13699	59, 92, 123, 310
E10322	Euclid	13672	90

OEM	Brand	Part Id	Page
E1061	Euclid	15013	94, 125, 213, 232, 264
E10677	Euclid	19002	218
E10729A	Euclid	13600	87
E10729A	Euclid	13628	88
E10730A	Euclid	13604	87
E11449	Euclid	18992	285
E11496	Euclid	13601	87, 121
E11496	Euclid	13721	93, 124
E11496	Euclid	13722	8, 93, 124
E1159	Euclid	15016	213, 232
E1160	Euclid	15011	213
E1160	Euclid	15019	213
E1160	Euclid	15073	214
E11748	Euclid	13701	92, 124, 310
E11763	Euclid	50033	7, 46, 172, 225, 236, 274
E11784	Euclid	13700	92, 124, 310
E1197	Euclid	11001	32, 258
E12056059	Miscellaneous	33500	250
E1312	Euclid	15064	44, 171, 214, 224, 233
E1330	Euclid	14522	185, 211, 232, 275
E1332	Euclid	14521	185, 211, 232, 275
E1338	Euclid	13500	13, 58, 79, 118, 217, 260
E1339	Euclid	13505	14, 58, 80, 118, 230, 261
E1340	Euclid	13501	13, 58, 80, 118, 217, 230, 260
E1341A	Euclid	13553	14, 58, 85, 120, 155, 210, 217, 230, 261
E13964	Euclid	13517	81, 119, 183
E13967	Euclid	13516	81, 119, 183
E13989	Euclid	34563	136, 313
E14026	Euclid	13627	88
E14044	Euclid	13626	42, 88, 121, 169, 199, 262
E14047	Euclid	13611	7, 88
E14047	Euclid	13722	8, 93, 124
E14347	Euclid	13599	5
E14374	Euclid	13626	42, 88, 121, 169, 199, 262
E14377	Euclid	13594	87
E14634	Euclid	13623	328
E1546	Euclid	13534	83, 120
E1546	Euclid	13558	85
E1567	Euclid	17505	282
E1571	Euclid	17502	282
E1577A	Euclid	17668	284
E1594	Euclid	13537	14, 83, 261
E1595	Euclid	13543	14, 84, 210, 261
E1598A	Euclid	13650	15, 59, 89, 122, 262
E1599A	Euclid	13650	15, 59, 89, 122, 262
E1876	Euclid	18600	45
E1940	Euclid	13592	14, 58, 86, 121, 262
E1960	Euclid	13650	15, 59, 89, 122, 262
E1980	Euclid	15013	94, 125, 213, 232, 264
E1981	Euclid	15063	94, 214, 233
E1982	Euclid	15051	213, 233
E1983	Euclid	15064	44, 171, 214, 224, 233
E1999A	Euclid	14000	55, 100, 210, 230
E1HT5781EA	Ford	14010	15
E1HZ5038A	Ford	11022	12
E2102	Euclid	17539	284
E2225	Euclid	13522	42, 82, 119, 154, 169, 199, 261
E2225	Euclid	83522	46, 95, 136, 157, 172, 201, 274

Cross Reference continued

OEM	Brand	Part Id	Page
E2226	Euclid	13520	5, 82, 119, 154, 169, 198, 239, 261, 279
E2226	Euclid	13536	5, 83, 120, 155, 169, 199, 239, 279
E2226	Euclid	83520	7, 95, 136, 157, 172, 201, 218, 251, 280
E2227	Euclid	13684	90, 122, 183
E2228	Euclid	13518	81, 119, 154, 183, 198, 261
E2228	Euclid	13533	83, 120, 183, 261, 279
E2232	Euclid	13649	15, 89, 122, 170
E2238	Euclid	13514	81, 118, 154, 198
E2361	Euclid	17529	283
E2361	Euclid	18991	285
E2372	Euclid	13502	80, 118, 210
E2374	Euclid	13507	80, 182, 217
E2551	Euclid	18439	285
E2553	Euclid	13544	84
E2554	Euclid	13545	84, 120
E2555	Euclid	13547	84, 120
E2638	Euclid	13686	43, 91, 122, 262, 309
E2639	Euclid	13683	43, 90, 122, 308
E2641	Euclid	13693	91, 309
E2642	Euclid	12044	41, 79, 117, 153, 217, 259, 306
E2642	Euclid	13691	43, 91, 123, 262, 309
E2643	Euclid	13694	43, 92, 123, 262, 310
E2771	Euclid	13553	14, 58, 85, 120, 155, 210, 217, 230, 261
E2810	Euclid	13687	91, 309
E2811	Euclid	13688	91, 309
E2812	Euclid	13697	43, 92, 123, 263, 310
E2814	Euclid	13517	81, 119, 183
E2815	Euclid	12031	13, 79, 117, 165
E2816	Euclid	13516	81, 119, 183
E2850	Euclid	15000	212
E2863	Euclid	13587	86
E2917	Euclid	12006	164
E2917	Euclid	12040	166
E2919	Euclid	12010	164
E2920	Euclid	12014	164
E2921A	Euclid	12029	165
E2924A	Euclid	12028	165
E2936	Euclid	14532	186, 212
E2940	Euclid	14504	124, 184, 211, 240
E2945	Euclid	14509	184, 211
E3086	Euclid	10000	4, 112
E31562	Flagg	12041	166
E3169	Euclid	13688	91, 309
E3275A	Euclid	12015	164, 258
E3296	Euclid	11002	32
E3362	Euclid	14010	15, 94, 155, 211, 231
E3394A	Euclid	14001	210, 230
E3411	Euclid	13515	81, 119, 154, 183
E3540A	Euclid	11000	31
E3540A	Euclid	11064	34
E3579	Euclid	13009	54, 229
E3582	Euclid	13037	54, 230, 275
E3582	Euclid	13037	54, 230, 275
E3679	Euclid	12053	167
E3680	Euclid	12009	164
E3680	Euclid	12040	166
E3770	Euclid	13541	84
E3784	Euclid	13577	120
E3868	Euclid	13528	83, 119, 154, 183, 199, 239

OEM	Brand	Part Id	Page
E3977	Euclid	15001	125, 212
E3HZ5A646A	Ford	13609	14
E4253	Euclid	14527	125, 185
E4254	Euclid	14526	185
E4255	Euclid	14510	184, 231
E4382A	Euclid	14513	44, 55, 125, 170, 185, 223, 232, 263, 275
E4410A	Euclid	14529	55, 186
E4410A	Euclid	14533	44, 125, 170, 186, 223, 232, 263, 275
E4664	Euclid	13520	5, 82, 119, 154, 169, 198, 239, 261, 279
E4664	Euclid	13536	5, 83, 120, 155, 169, 199, 239, 279
E4664	Euclid	83520	7, 95, 136, 157, 172, 201, 218, 251, 280
E4669	Euclid	11502	143
E4669	Euclid	11719	149
E4677A	Euclid	18919	10
E4678A	Euclid	18919	10
E4685	Euclid	11740	10
E4771	Euclid	34554	200, 312
E4773	Euclid	12361	196
E4775	Euclid	12350	195
E4776	Euclid	12351	195
E4827	Euclid	15054	213, 233
E48459	Flagg	11757	151
E48459	Flagg	11759	151
E48575	Flagg	12375	197
E4HZ5872A	Ford	13526	14
E4HZ5873A	Ford	13512	14
E5080	Euclid	14523	185
E5081	Euclid	14524	185
E5083	Euclid	12395	182, 198, 307
E5216	Euclid	14027	101, 231
E5217	Euclid	14027	101, 231
E5269	Euclid	13526	14, 82, 169
E5270	Euclid	13512	14, 81
E5275	Euclid	11004	32, 77, 115, 142, 162, 192
E5275	Euclid	13521	42, 82, 119, 154, 169, 198
E5276	Euclid	14010	15, 94, 155, 211, 231
E53046	Flagg	18600	45
E5309	Euclid	13566	86, 262
E536	Euclid	17538	284
E5512	Euclid	17501	281
E6121	Euclid	13510	81
E6122	Euclid	13542	84, 120
E640	Euclid	14004	231
E661	Euclid	17503	282
E6616	Euclid	16000	59
E6858B	Euclid	17674	284
E6858R	Euclid	17675	284
E69455	Flagg	19001	16, 62, 127, 242
E6979	Euclid	13505	14, 58, 80, 118, 230, 261
E6980	Euclid	13543	14, 84, 210, 261
E7426	Euclid	11739	10, 117
E7427	Euclid	18919	10
E7430	Euclid	11013	33
E7431	Euclid	11085	35
E7431	Euclid	11725	41
E7432	Euclid	13005	54
E7433	Euclid	13001	54, 100, 229
E7433	Euclid	14003	55, 100, 211, 231
E7439	Euclid	18222	61, 265
E7440	Euclid	18232	61, 265
E7441	Euclid	12028	165

Cross Reference continued

OEM	Brand	Part Id	Page
E7443	Euclid	14502	184
E7445	Euclid	10002	293
E7446	Euclid	11502	143
E7446	Euclid	11719	149
E7446A	Euclid	11502	143
E7446A	Euclid	11719	149
E7448	Euclid	11554	147, 193
E7450	Euclid	11517	293
E7451	Euclid	11515	144, 293
E7452	Euclid	14000	55, 100, 210, 230
E7453	Euclid	14008	55, 100, 199, 211, 231, 263, 275
E7453	Euclid	14073	55, 102, 211, 231, 275
E7454	Euclid	14011	100, 231
E7455	Euclid	14027	101, 231
E7457	Euclid	18256	234
E7462	Euclid	11705	116, 149, 194, 278
E7464	Euclid	11062	142, 192
E7466	Euclid	11709	149, 194
E7467	Euclid	11545	147, 162
E7468	Euclid	11539	146, 193
E7468	Euclid	11614	148, 193
E7468	Euclid	11761	151, 194
E7469	Euclid	11537	40, 146, 192
E7469	Euclid	11613	41, 148, 193
E7470	Euclid	11535	146
E7471	Euclid	11612	148
E7472	Euclid	11520	40, 145, 192, 222, 278
E7472	Euclid	11523	40, 145, 192, 223, 278
E7473	Euclid	11533	145, 278
E7474	Euclid	11550	147, 193
E7474	Euclid	18244	156, 200, 234
E7477	Euclid	12000	163
E7478	Euclid	12029	165
E7479	Euclid	12015	164, 258
E7480	Euclid	12014	164
E7481	Euclid	12006	164
E7481	Euclid	12040	166
E7482	Euclid	10011	112
E7483	Euclid	10026	114
E7484	Euclid	10020	31, 113
E7485	Euclid	14510	184, 231
E7486	Euclid	14521	185, 211, 232, 275
E7492	Euclid	11501	143
E7503	Euclid	12367	197
E7506	Euclid	11707	41, 149, 194
E7506	Euclid	12355	153, 196
E7507	Euclid	12356	196
E7508	Euclid	12366	197, 279
E7509	Euclid	12350	195
E7516	Euclid	18575	294
E7517	Euclid	18574	294
E7518	Euclid	18558	234, 294
E7520	Euclid	15013	94, 125, 213, 232, 264
E7521	Euclid	15008	125, 212, 232
E7522	Euclid	15051	213, 233
E7523	Euclid	15011	213
E7523	Euclid	15019	213
E7523	Euclid	15073	214
E7529	Euclid	18566	44, 56, 127, 156, 171, 186, 200, 279
E7529	Euclid	30545	280
E7621	Euclid	14038	102
E7638	Euclid	13522	42, 82, 119, 154, 169, 199, 261
E7638	Euclid	83522	46, 95, 136, 157, 172, 201, 274

OEM	Brand	Part Id	Page
E7639	Euclid	13520	5, 82, 119, 154, 169, 198, 239, 261, 279
E7639	Euclid	13536	5, 83, 120, 155, 169, 199, 239, 279
E7639	Euclid	83520	7, 95, 136, 157, 172, 201, 218, 251, 280
E7640	Euclid	11549	147
E7641	Euclid	12023	164
E7644	Euclid	18063	126
E7645	Euclid	18851	295
E7712	Euclid	14002	210
E7766	Euclid	11739	10, 117
E7767	Euclid	18921	10
E7840	Euclid	12362	196
E7841	Euclid	12354	195
E7853	Euclid	12398	79, 182, 198, 307
E79659	Flagg	18601	156
E812	Euclid	15008	125, 212, 232
E813	Euclid	15005	212
E8650	Euclid	18222	61, 265
E8651	Euclid	13518	81, 119, 154, 183, 198, 261
E8653	Euclid	15016	213, 232
E8654	Euclid	15001	125, 212
E8663	Euclid	13009	54, 229
E8664	Euclid	13037	54, 230, 275
E8666	Euclid	14038	102
E8667	Euclid	12010	164
E8669	Euclid	14522	185, 211, 232, 275
E8670	Euclid	14522	185, 211, 232, 275
E8677	Euclid	14504	124, 184, 211, 240
E8679	Euclid	14509	184, 211
E8681	Euclid	14527	125, 185
E8683	Euclid	14513	44, 55, 125, 170, 185, 223, 232, 263, 275
E8687	Euclid	15013	94, 125, 213, 232, 264
E8688	Euclid	15017	213, 232, 264
E8689	Euclid	15009	170, 212
E8691	Euclid	15005	212
E8694	Euclid	15005	212
E8701	Euclid	18919	10
E8702	Euclid	18920	10
E8795	Euclid	18600	45
E8796	Euclid	18600	45
E8799	Euclid	18600	45
E8800	Euclid	18600	45
E8804	Euclid	11005	12, 32, 115
E8804	Euclid	11083	35, 77, 116, 192
E8808	Euclid	11153	40, 304
E8821	Euclid	18860	8, 171, 265, 312
E8851	Euclid	12333	260
E8853A	Euclid	31095	271, 312
E8917	Euclid	18921	10
E8918	Euclid	10075	12, 114, 258
E8919	Euclid	12360	196
E927	Euclid	13001	54, 100, 229
E927	Euclid	14003	55, 100, 211, 231
E9292	Euclid	14514	185
E9323	Euclid	11512	144
E9323	Euclid	11514	144
E9323	Euclid	11735	4, 150
E9324	Euclid	11511	78, 144
E9325	Euclid	13607	59, 87, 121
E9326	Euclid	13596	87
E9326	Euclid	83596	8, 62, 95, 136
E9327	Euclid	13665	90
E934	Euclid	14008	55, 100, 199, 211, 231, 263, 275

Cross Reference continued

OEM	Brand	Part Id	Page
E934	Euclid	14073	55, 102, 211, 231, 275
E9350	Euclid	15061	125, 214, 233
E9359	Euclid	13505	14, 58, 80, 118, 230, 261
E9359	Euclid	13656	89, 122
E9361	Euclid	13041	55
E9362	Euclid	13042	55, 100, 230
E9391	Euclid	13524	82, 210
E9394	Euclid	13735	15, 93, 124, 155, 170, 263, 311
E9395	Euclid	11714	78
E9395	Euclid	11003	32
E9395	Euclid	11714	78
E9401	Euclid	13526	14, 82, 169
E9409	Euclid	13735	15, 93, 124, 155, 170, 263, 311
E9410	Euclid	13601	87, 121
E9410	Euclid	13721	93, 124
E9410	Euclid	13722	8, 93, 124
E9416	Euclid	13625	88
E9419	Euclid	13560	85
E9420	Euclid	13609	14, 87, 121, 183, 210
E9421	Euclid	13610	88, 121
E9432A	Euclid	13527	82
E9437	Euclid	19002	218
E9438	Euclid	19003	200, 218
E9439	Euclid	19005	218
E9440	Euclid	11500	143, 217
E9440	Euclid	19004	157, 218
E9440	Euclid	19008	218
E9472	Euclid	14038	102
E9473	Euclid	14038	102
E9510	Euclid	13543	14, 84, 210, 261
E9511	Euclid	13501	13, 58, 80, 118, 217, 230, 260
E9512	Euclid	13553	14, 58, 85, 120, 155, 210, 217, 230, 261
E9513	Euclid	13650	15, 59, 89, 122, 262
E9514	Euclid	13649	15, 89, 122, 170
E9515	Euclid	13592	14, 58, 86, 121, 262
E9517	Euclid	13517	81, 119, 183
E9518	Euclid	12031	13, 79, 117, 165
E9519	Euclid	13659	89, 240
E9520	Euclid	13500	13, 58, 79, 118, 217, 260
E9545	Euclid	15064	44, 171, 214, 224, 233
E9550	Euclid	18956	214
E9552	Euclid	15063	94, 214, 233
E9566	Euclid	13512	14, 81
E9575	Euclid	13581	328
E9579	Euclid	15020	213
E9792A	Euclid	17539	284
E9874	Euclid	11063	34
EA38000	Atro	13566	86, 262
EA50000	Atro	13586	86
EB27500	Atro	13512	14, 81
EB34000	Atro	13501	13, 58, 80, 118, 217, 230, 260
EB38000	Atro	13553	14, 58, 85, 120, 155, 210, 217, 230, 261
EB45000	Atro	13560	85
EB50000	Atro	13545	84, 120
EB5021013	Atro	13607	59, 87, 121
EB65000	Atro	13546	84
EE14003053	International	10503	115
EKT4746	PAI	13533	83, 120, 183, 261, 279

OEM	Brand	Part Id	Page
EM2752	Westar	18433	16, 44, 224
EM7569656	Atro	12357	196
EM7569656	Atro	12381	198
EQ4735900	Atro	13041	55
EQ5335118	Atro	14038	102
EQ5335234	Atro	14000	55, 100, 210, 230
EQ8311000	Atro	15016	213, 232
EQ8335902	Atro	15054	213, 233
F2UA5781CD	Ford	17275	15
F2UZ5781CD	Ford	17275	15
F2VZ5K486A	Ford	17251	15
F81A5781BA	Ford	17275	15
F81A5781CA	Ford	17276	15
FBG4482	PAI	12015	164, 258
FBG4989	PAI	15013	94, 125, 213, 232, 264
FH4Z5560B	Ford	11758	13
FIM4678	PAI	12049	167
FL39	Flagg	11078	35, 304
FL42	Flagg	11153	40, 304
FL5	Flagg	11000	31
FL5	Flagg	11064	34
FL55	Flagg	13522	42, 82, 119, 154, 169, 199, 261
FL55	Flagg	83522	46, 95, 136, 157, 172, 201, 274
FL6	Flagg	11002	32
FL63	Flagg	11001	32, 258
FMM4644	PAI	12023	164
FMM4676	PAI	12000	163
FMT4582	PAI	12004	163
FMT4679	PAI	12002	163
FMT4805	PAI	18837	45, 171
FMT4806	PAI	12032	165
FMT4992	PAI	12045	166
FMT4993	PAI	12045	166
FNTBSH109L	Volvo	10079	258
FNTBSH172U	Volvo	10079	258
FONBSH109L	Freightliner	10079	31
FONBSH109L	Sterling Truck	10079	220
FONBSH172UL	Sterling Truck	10079	220
FP9969426	Atro	17506	282
FR220	Flagg	13037	54, 230, 275
FR263	Flagg	13005	54
FR264	Flagg	13041	55
FR266	Flagg	13042	55, 100, 230
FR267	Flagg	13011	54, 229
FRK0510030	Arvin Meritor	50032	6
FSI2010	PAI	12009	164
FSI2010	PAI	12040	166
FSI4730	PAI	12014	164
FSI4811	PAI	12006	164
FSI4811	PAI	12040	166
FSI4910	PAI	12010	164
FTR42628100	PAI	12072	168, 306
FTR4537200	PAI	12070	79, 168, 306
FTR4537210	PAI	12069	168, 306
FTR4537215	PAI	12073	168, 306
FTR4537238	PAI	12074	117, 168, 307
FTR4537A238	PAI	12074	117, 168, 307
FTR4628180	PAI	12072	168, 306
FTR4628A180	PAI	12072	168, 306
FULK3399	Freightliner	11611	40
FULK3399	International	11611	116
FULK3399	Kenworth	11611	148
FULK3399	Peterbilt	11611	193
FULK3399	Volvo	11611	258
FW5132011	Atro	18215	44, 126, 171, 224, 234, 265, 294

Cross Reference continued

OEM	Brand	Part Id	Page
FW9932109	Atro	10079	31, 162, 220, 258, 293
FW9932172	Atro	10079	31, 162, 220, 258, 293
FW9932605	Atro	40035	46, 136, 172, 224, 273, 295
G1094264	GMC/RTS/Nova	33506	250
GDH762000	Great Dane	13001	229
GDH762000	Great Dane	13042	230
GT2601	Globtech	17675	284
GT2602	Globtech	17674	284
GT2608	Globtech	17676	285
H102	Flagg	14000	55, 100, 210, 230
H126	Flagg	14027	101, 231
H126UB	Flagg	14027	101, 231
H127	Flagg	14027	101, 231
H151	Flagg	14011	100, 231
H227	Flagg	14038	102
H236	Flagg	13042	55, 100, 230
HAK100	Automann	13507	80, 182, 217
HAK112	Automann	13609	14, 87, 121, 183, 210
HAK114	Automann	13610	88, 121
HAK124	Automann	13547	84, 120
HAK34	Flagg	13502	80, 118, 210
HAK38	Flagg	13507	80, 182, 217
HAK44	Flagg	13609	14, 87, 121, 183, 210
HAK45	Flagg	13610	88, 121
HAK50	Flagg	13547	84, 120
HAK92	Automann	13502	80, 118, 210
HB593	Flagg	18566	44, 56, 127, 156, 171, 186, 200, 279
HB88510	SKF	40075	6, 17, 46, 62, 96, 136, 157, 172, 201, 225, 274
HB88512A	Federal Mogul	40074	6, 8, 17, 46, 62, 136, 157, 172, 200, 274
HB88512AHD	Federal Mogul	40074	6, 8, 17, 46, 62, 136, 157, 172, 200, 274
HBK100	Automann	13534	83, 120
HBK100	Automann	13558	85
HBK38	Flagg	13534	83, 120
HBK38	Flagg	13558	85
HC10000	Atro	13649	15, 89, 122, 170
HC20000	Atro	13650	15, 59, 89, 122, 262
HCK100	Automann	13587	86
HCK340LP	International	13504	118
HCK380	Flagg	13587	86
HD62000590	International	34556	136
HD62001590	International	34556	136
HD62010455	International	12396	118
HD62350615	International	13733	124
HD62350645	International	34555	135
HD64179037	International	13626	121
HDR62000590	Freightliner	34556	45
HDR62000590	Volvo	34556	273
HDR62001590	Freightliner	34556	45
HDR62001590	Sterling Truck	34556	224
HDR62001590	Volvo	34556	273
HDR62010455	Freightliner	12396	42
HDR62010455	Volvo	12396	260
HDR62350615	Freightliner	13733	43
HDR62350615	Sterling Truck	13733	223
HDR62350615	Volvo	13733	263
HDR62350645	Freightliner	34555	45
HDR62350645	Sterling Truck	34555	224
HDR62350645	Volvo	34555	273
HDR64179037	Freightliner	13626	42
HDR64179037	Volvo	13626	262
HDRR005422	Freightliner	50033	46

OEM	Brand	Part Id	Page
HDRR005422	Sterling Truck	50033	225
HDRR005422	Volvo	50033	274
HDRS24736	Freightliner	13623	328
HDRS24736	Sterling Truck	13623	328
HDRS24736	Volvo	13623	328
HE1140	Dallas Spring	13562	85
HHXB0011	Stoughton	18215	234
HLD90008149	Freightliner	14533	44
HLD90008149	Sterling Truck	14533	223
HLDXB0009	Freightliner	18221	44
HLDXB0011	Freightliner	18215	44
HLDXB0011	Sterling Truck	18215	224
HLDXB10605	Freightliner	40035	46
HLDXB10605	Sterling Truck	40035	224
HLK1000	Automann	11543	147, 193, 300
HLK1011	Automann	11104	37, 299
HLK1012	Automann	11105	37, 299
HLK1015	Automann	11768	152, 300
HLK1019	Automann	11107	38, 299
HLK1020	Automann	11106	37, 299
HLK1024	Automann	11134	39, 143, 300
HLK2001	Automann	11109	38, 96, 162, 222, 278, 299
HLK2005	Automann	11124	39
HLN1002	Automann	10506	31, 115, 298
HM7564593	Atro	12363	196
HM7565510	Atro	12359	196
HM7565711	Atro	12364	197
HM7566154	Atro	12370	197
HOHXB0009	Volvo	18221	265
HOHXB0011	Volvo	18215	265
HOHXB10605	Volvo	40035	273
HR1HB0S41	Freightliner	11063	34
HR1HBUS41	Freightliner	11063	34
HS10000	Atro	13601	87, 121
HS10000	Atro	13721	93, 124
HS10000	Atro	13722	8, 93, 124
HS102	Flagg	18821	94
HS11000	Atro	13625	88
HS115K	Flagg	13725	93
HS130	Flagg	13626	42, 88, 121, 169, 199, 262
HS41	Flagg	13665	90
HS44	Flagg	11004	32, 77, 115, 142, 162, 192
HS44	Flagg	13521	42, 82, 119, 154, 169, 198
HS55	Flagg	13524	82, 210
HS56	Flagg	13601	87, 121
HS56	Flagg	13721	93, 124
HS56	Flagg	13722	8, 93, 124
HS65	Flagg	13527	82
HS73	Flagg	13582	86, 121
HS79	Flagg	13672	90
HS82	Flagg	13550	85
HS83	Flagg	13550	85
HS99	Flagg	13611	7, 88
HS99	Flagg	13722	8, 93, 124
HT207	Flagg	13510	81
HT207	Flagg	13565	85
HT210	Flagg	13581	328
HT212	Flagg	13542	84, 120
HT245	Flagg	13600	87
HT245	Flagg	13628	88
HT249	Flagg	13594	87
HT258	Flagg	13648	89
HTS24736	Stoughton	13623	328
HTS24736	Trailmobile	13623	328
HU10000	Atro	14027	101, 231
HU10065	Atro	14027	101, 231

Cross Reference continued

OEM	Brand	Part Id	Page	OEM	Brand	Part Id	Page
HUD62000590	International	34556	136	K066266	Kenworth	18244	156
HUD62001590	International	34556	136	K066282	Kenworth	11539	146
HUD62010455	International	12396	118	K066282	Kenworth	11614	148
HUD62350615	International	13733	124	K066282	Kenworth	11761	151
HUD62350645	International	34555	135	K066293	Kenworth	11502	143
HUN120043401	Freightliner	11520	40	K066293	Kenworth	11719	149
HUN120043401	Freightliner	11523	40	K066320	Kenworth	11539	146
HUN120043401	Sterling Truck	11520	222	K066320	Kenworth	11614	148
HUN120043401	Sterling Truck	11523	223	K066320	Kenworth	11761	151
HV38000	Atro	13592	14, 58, 86, 121, 262	K066336	Kenworth	11533	145
IH14	Flagg	30544	129	K066377	Kenworth	11540	146
IH22	Flagg	34563	136, 313	K066377	Kenworth	11760	151
IH5	Flagg	13577	120	K066385	Kenworth	11762	152
IH9	Flagg	10000	4, 112	K066391	Kenworth	11540	146
IN35180	Atro	13515	81, 119, 154, 183	K066391	Kenworth	11760	151
IN35190	Atro	13514	81, 118, 154, 198	K066404	Kenworth	11615	149
IPC924711	Sterling Truck	13657	223	K066404	Kenworth	11762	152
IPC925030	Sterling Truck	11751	223	K066405	Kenworth	11615	149
IPC928610	Freightliner	13683	43	K066405	Peterbilt	11615	194
IPC928630	Freightliner	13686	43	K066405	Peterbilt	11762	194
IPC928660	Freightliner	13691	43	K066406	Kenworth	11615	149
IPC928661	Freightliner	12044	41	K066406	Kenworth	11762	152
IPC928661	Freightliner	13691	43	K066407	Kenworth	11615	149
IPC928680	Freightliner	13694	43	K066407	Peterbilt	11615	194
IPC928681	Freightliner	13695	43	K066407	Peterbilt	11762	194
IPC928690	Freightliner	13696	43	K066421	Kenworth	11541	146
IPC928691	Freightliner	13697	43	K066421	Kenworth	11760	151
IS620	Flagg	19001	16, 62, 127, 242	K066423	Kenworth	11615	149
J142662	Freightliner	13525	42	K066423	Peterbilt	11615	194
J142662	Sterling Truck	13525	223	K066423	Peterbilt	11762	194
J177005	Freightliner	11019	33	K0664353	Kenworth	18938	156
J177005	Sterling Truck	11019	220	K066449	Kenworth	11502	143
J185961	Lord	12045	166	K066449	Kenworth	11719	149
J185972	Lord	12045	166	K066450	Kenworth	11720	149
J209413	Freightliner	11065	34	K066461	Kenworth	11733	150
J209413	Freightliner	11088	36	K066461	Kenworth	11734	150
J209416	Freightliner	11065	34	K066461	Kenworth	11766	152
J209416	Freightliner	11088	36	K066478	Kenworth	11720	149
J209416	Sterling Truck	11065	221	K06650	Kenworth	11501	143
J209416	Sterling Truck	11088	221	K0665022	Kenworth	11733	150
J209417	Freightliner	11088	36	K0665022	Kenworth	11734	150
J209417	Sterling Truck	11088	221	K0665022	Kenworth	11766	152
J5950	Peterbilt	11062	192	K147107	Kenworth	11543	147
J61982	Freightliner	11537	40	K147107	Peterbilt	11543	193
J61982	Freightliner	11613	41	K147C106	Kenworth	11543	147
J621041	Freightliner	10020	31	K174225	Kenworth	11532	145
J621049	Freightliner	10020	31	K174555	Kenworth	11535	146
J6256136	Lord	30504	45	K174B456	Kenworth	11535	146
J71651	Freightliner	11520	40	K179378	Kenworth	11060	142
J71651	Freightliner	11523	40	K179528	Kenworth	11545	147
K066058	Kenworth	11502	143	K179531	Kenworth	11733	150
K066058	Kenworth	11719	149	K179531	Kenworth	11766	152
K066160	Kenworth	11515	144	K179D450	Kenworth	11545	147
K066176	Kenworth	11705	149	K179D450	Kenworth	11545	147
K066178	Kenworth	11062	142	K179D481	Kenworth	11546	147
K066184	Kenworth	11500	143	K195375	Kenworth	11751	151
K066184	Kenworth	19004	157	K195376	Kenworth	11080	142
K066218	Kenworth	11709	149	K19541513	Kenworth	11511	144
K066228	Kenworth	11520	145	K195472	Kenworth	11773	152
K066228	Kenworth	11523	145	K195474	Kenworth	11773	152
K066229	Kenworth	11537	146	K2071085	Kenworth	11733	150
K066229	Kenworth	11613	148	K2071085	Kenworth	11737	150
K066232	Kenworth	11501	143	K2071085	Kenworth	11766	152
K066247	Kenworth	11539	146	K20959	Kenworth	18601	156
K066247	Kenworth	11614	148	K20975	Kenworth	11757	151
K066247	Kenworth	11761	151	K20975	Kenworth	11759	151
K066259	Kenworth	11512	144	K20982	Kenworth	18602	156
K066259	Kenworth	11514	144	K20987	Kenworth	18602	156
K066259	Kenworth	11735	150	K221394108	Kenworth	11726	149
K066266	Kenworth	11550	147	K2215086	Kenworth	11764	152

Cross Reference continued

OEM	Brand	Part Id	Page
K26484	Kenworth	11549	147
K3399	Fuller	11611	40, 116, 148, 162, 193, 258
K3399	Fuller	11611	40, 116, 148, 162, 193, 258
K3455156	Kenworth	11733	150
K3455156	Kenworth	11766	152
K3501887	Kenworth	11547	147
KB321	Automann	11502	143
KB321	Automann	11719	149
KB321UB	Automann	11502	143
KB321UB	Automann	11719	149
KB450	Automann	11720	149
KB450UB	Automann	11720	149
KB452	Automann	11733	150
KB452	Automann	11734	150
KB452	Automann	11766	152
KB452UB	Automann	11733	150
KB452UB	Automann	11734	150
KB452UB	Automann	11766	152
KB920	Hd Plus	11729	78, 116, 150, 194
KC8011	Unibond	17500	281
KF88051400	Fuwa	40089	236
KIT11126	Arvin Meritor	50033	7
KIT111262	Arvin Meritor	50032	6
KIT11201	Arvin Meritor	13599	5
KIT11300	Arvin Meritor	50032	6
KP101	Automann	11517	293
KP101UB	Automann	11517	293
KP105	Automann	18094	293
KP109	Automann	10002	293
KP109UB	Automann	10002	293
KP116	Automann	18221	44, 127, 171, 265, 294
KP119	Automann	11515	144, 293
KP119UB	Automann	11515	144, 293
KP126	Automann	18709	295
KP127	Automann	18708	295
KT5962001	Atro	11540	146
KT5962001	Atro	11760	151
KT5962001HW	Atro	11760	151
KT5962002	Atro	11615	149, 194
KT5962002	Atro	11762	152, 194
KT5962002HT	Atro	11615	149, 194
KT5962002HT	Atro	11762	152, 194
KT5962002HW	Atro	11762	152, 194
KT5962003HT	Atro	11762	152, 194
KT6262216	Atro	12034	165
KT6262389	Atro	12035	165
KT7561257	Atro	12360	196
KW08849AC	Kenworth	11743	150
KW28	Kenworth	11720	149
KW3	Flagg	11502	143
KW3	Flagg	11719	149
KW3UB	Flagg	11502	143
KW3UB	Flagg	11719	149
KW6UB	Flagg	11502	143
KW6UB	Flagg	11719	149
L1025	Dana	15017	232
L1032	Dana	15013	232
L1032	Dana	15063	233
L1082	Leland	17534	284
L1132	Dana	15051	233
L1191	Leland	17668	284
L1296	Leland	17504	282
L1641	Leland	18439	285
L166	Leland	17501	281
L166	Leland	17538	284
L1730	Leland	17529	283
L3146	Leland	17539	284

OEM	Brand	Part Id	Page
L560001	Kenworth	12365	153
L560001	Peterbilt	12365	197
L752	Leland	17574	5
L896	Leland	17505	282
L898	Leland	17502	282
LC1	Flagg	13650	15, 59, 89, 122, 262
LC1UB	Flagg	13650	15, 59, 89, 122, 262
LC3	Flagg	13650	15, 59, 89, 122, 262
LC3UB	Flagg	13650	15, 59, 89, 122, 262
LC4	Flagg	13649	15, 89, 122, 170
LC4UB	Flagg	13649	15, 89, 122, 170
LNC24MM	Flagg	12043	166
LORCB220212	Freightliner	18015	44
LORCB220212	Sterling Truck	18015	224
LORJ209416	Freightliner	11065	34
LORJ209416	Freightliner	11088	36
LORJ209417	Freightliner	11065	34
LORJ209417	Freightliner	11088	36
LORSB33310017A	Freightliner	11008	32
LORSB33310017A	Freightliner	11086	36
LORSB33310017B	Freightliner	11009	33
LORSB33310017B	Freightliner	11086	36
LORSM10359	Freightliner	11117	38
LORSM10359	Sterling Truck	11117	222
LORSS3310017	Freightliner	11018	33
LORSS3310017	Freightliner	11087	36
LORSS3310018	Freightliner	11018	33
LORSS3310018	Freightliner	11087	36
LP1924002	Atro	11740	10
LP5024000	Atro	13601	87, 121
LP5024000	Atro	13721	93, 124
LP5024000	Atro	13722	8, 93, 124
LP5024179	Atro	13626	42, 88, 121, 169, 199, 262
LP5024974	Atro	13611	7, 88
LP5024974	Atro	13722	8, 93, 124
M1	Automann	12000	163
M10WJ107	Dana	17539	284
M10WJ178	Dana	17503	282
M10WJ237X	Dana	17539	284
M1214	Automann	11757	151
M1214	Automann	11759	151
M1216	Automann	12375	197
M12900	Automann	14027	101, 231
M12900UB	Automann	14027	101, 231
M1306	Automann	18600	45
M131009	Kenworth	17283	156
M131009	Peterbilt	17283	199
M131011	Kenworth	17284	156
M131011	Peterbilt	17284	199
M13351UB	Automann	12359	196
M13633	Automann	11554	147, 193
M13633UB	Automann	11554	147, 193
M1449	BWP	15013	94, 125, 213, 232, 264
M1452	BWP	14000	55, 100, 210, 230
M14712	Automann	13542	84, 120
M1486	BWP	14509	184, 211
M1489	BWP	14500	184
M1634	Automann	19001	16, 62, 127, 242
M1656	BWP	12361	196
M1659	BWP	12350	195
M1661	BWP	12351	195
M16884	Automann	11060	116, 142
M1694	BWP	15054	213, 233
M16HD106	Dana	17678	285
M1706	BWP	14521	185, 211, 232, 275
M1718	BWP	15011	213
M1718	BWP	15019	213
M1718	BWP	15073	214

Cross Reference continued

OEM	Brand	Part Id	Page
M1719	BWP	15016	213, 232
M1724	BWP	13501	13, 58, 80, 118, 217, 230, 260
M1725	BWP	13500	13, 58, 79, 118, 217, 260
M1726	BWP	13553	14, 58, 85, 120, 155, 210, 217, 230, 261
M1727	BWP	13505	14, 58, 80, 118, 230, 261
M17328	Automann	11013	33
M17328UB	Automann	11013	33
M17330	Automann	11725	41
M17330UB	Automann	11085	35
M17330UB	Automann	11725	41
M17331	Automann	11020	33
M17331UB	Automann	11020	33
M17333	Automann	11062	142, 192
M17333UB	Automann	11062	142, 192
M17348	Automann	18232	61, 265
M17348UB	Automann	18232	61, 265
M17392UB	Automann	11705	116, 149, 194, 278
M17400	Automann	11709	149, 194
M17400UB	Automann	11709	149, 194
M17402	Automann	11545	147, 162
M17402UB	Automann	11545	147, 162
M17404	Automann	11539	146, 193
M17404	Automann	11614	148, 193
M17404	Automann	11761	151, 194
M17404UB	Automann	11539	146, 193
M17404UB	Automann	11614	148, 193
M17404UB	Automann	11761	151, 194
M17406	Automann	11537	40, 146, 192
M17406	Automann	11613	41, 148, 193
M17406UB	Automann	11537	40, 146, 192
M17406UB	Automann	11613	41, 148, 193
M17408	Automann	11535	146
M17408UB	Automann	11535	146
M17410	Automann	11612	148
M17410UB	Automann	11612	148
M17412	Automann	11520	40, 145, 192, 222, 278
M17412	Automann	11523	40, 145, 192, 223, 278
M17412UB	Automann	11520	40, 145, 192, 222, 278
M17412UB	Automann	11523	40, 145, 192, 223, 278
M17414	Automann	11533	145, 278
M17414UB	Automann	11533	145, 278
M17417	Automann	11705	116, 149, 194, 278
M17417UB	Automann	11705	116, 149, 194, 278
M17434	Automann	10026	114
M17434UB	Automann	10026	114
M17445	Automann	34507	132
M17445	Automann	34510	133
M17445	Automann	34525	45, 134
M17474UB	Automann	12367	197
M17475UB	Automann	18102	200, 279
M17482UB	Automann	12356	196
M17483UB	Automann	18786	200
M17484UB	Automann	12366	197, 279
M1751	BWP	15009	170, 212
M17526UB	Automann	18566	44, 56, 127, 156, 171, 186, 200, 279
M17527	Automann	11545	147, 162
M17527UB	Automann	11545	147, 162
M17804UB	Automann	11707	41, 149, 194
M17804UB	Automann	12355	153, 196
M1788	BWP	11001	32, 258
M1807	BWP	13011	54, 229
M1818	BWP	13001	54, 100, 229

OEM	Brand	Part Id	Page
M1818	BWP	14003	55, 100, 211, 231
M1838	Automann	18601	156
M1845	BWP	15051	213, 233
M1846	BWP	15008	125, 212, 232
M1847	BWP	15005	212
M1848	BWP	14011	100, 231
M1869	BWP	15017	213, 232, 264
M1888	BWP	14008	55, 100, 199, 211, 231, 263, 275
M1888	BWP	14073	55, 102, 211, 231, 275
M1970	Automann	13553	14, 58, 85, 120, 155, 210, 217, 230, 261
M1970UB	Automann	13553	14, 58, 85, 120, 155, 210, 217, 230, 261
M1972	Automann	13505	14, 58, 80, 118, 230, 261
M1972UB	Automann	13505	14, 58, 80, 118, 230, 261
M1974	Automann	13500	13, 58, 79, 118, 217, 260
M1976	Automann	13501	13, 58, 80, 118, 217, 230, 260
M1978	Automann	13500	13, 58, 79, 118, 217, 260
M1980	Automann	13543	14, 84, 210, 261
M1980UB	Automann	13543	14, 84, 210, 261
M1988	Automann	13553	14, 58, 85, 120, 155, 210, 217, 230, 261
M1990HE	Automann	13545	84, 120
M1UB	Automann	12000	163
M2	Automann	12023	164
M200	Kenworth	11554	147
M20070EP	Kenworth	11554	147
M2010	BWP	13502	80, 118, 210
M203021	Automann	31604	132
M203031	Automann	18694	16
M20304	Automann	10075	12, 114, 258
M20304UB	Automann	10075	12, 114, 258
M20306UB	Automann	12360	196
M20307	Automann	10503	115
M20307UB	Automann	10503	115
M20309	Automann	10505	115
M20309UB	Automann	10505	115
M2061	BWP	13649	15, 89, 122, 170
M2062	BWP	13650	15, 59, 89, 122, 262
M2068	BWP	13514	81, 118, 154, 198
M2069	BWP	11556	13, 40, 78, 116, 148, 182, 193, 258
M2069	BWP	13522	42, 82, 119, 154, 169, 199, 261
M2069	BWP	83522	46, 95, 136, 157, 172, 201, 274
M2070	BWP	13520	5, 82, 119, 154, 169, 198, 239, 261, 279
M2070	BWP	13536	5, 83, 120, 155, 169, 199, 239, 279
M2070	BWP	83520	7, 95, 136, 157, 172, 201, 218, 251, 280
M2071	BWP	13684	90, 122, 183
M2072	BWP	13518	81, 119, 154, 183, 198, 261
M2072	BWP	13533	83, 120, 183, 261, 279
M2083	BWP	13687	91, 309
M2085	BWP	13688	91, 309
M2087	BWP	13517	81, 119, 183
M2088	BWP	13516	81, 119, 183
M2110	BWP	12006	164
M2111	BWP	12010	164
M2112	BWP	12014	164
M2113	BWP	12015	164, 258

Cross Reference continued

OEM	Brand	Part Id	Page
M2118	BWP	14504	124, 184, 211, 240
M2135	BWP	10000	4, 112
M2850	BWP	11000	31
M2850	BWP	11064	34
M2857	BWP	11002	32
M2920	BWP	12009	164
M2920	BWP	12040	166
M2938	BWP	15000	212
M2966	BWP	13610	88, 121
M3	Automann	12017	164
M30070NR	Kenworth	11709	149
M30070NR	Peterbilt	11709	194
M302500	Arvin Meritor	34514	6
M314	BWP	17676	285
M3262	BWP	13515	81, 119, 154, 183
M3264	BWP	11502	143
M3264	BWP	11719	149
M3265	BWP	14510	184, 231
M3399	BWP	15001	125, 212
M3436	BWP	15020	213
M3453	BWP	14527	125, 185
M3454	BWP	14533	44, 125, 170, 186, 223, 232, 263, 275
M3456	BWP	14513	44, 55, 125, 170, 185, 223, 232, 263, 275
M3472	BWP	11003	32
M3478	BWP	13513	169, 239
M3478	BWP	13577	120
M3483	BWP	14038	102
M37377	BWP	17675	284
M37378	BWP	17674	284
M3784	BWP	13512	14, 81
M3838	BWP	11502	143
M3838	BWP	11719	149
M3841	BWP	11709	149, 194
M3UB	Automann	12017	164
M46730	Automann	30504	45
M4794	Automann	19001	16, 62, 127, 242
M4878	Automann	19001	16, 62, 127, 242
M5	Dyco	12002	163
M50070NR	Kenworth	11612	148
M501	Kenworth	11707	149
M501	Kenworth	12355	153
M50670NR	Kenworth	11539	146
M50670NR	Kenworth	11614	148
M50670NR	Kenworth	11761	151
M5096	Automann	19001	16, 62, 127, 242
M5212	Automann	11060	116, 142
M5212	Automann	11757	151
M5212	Automann	11758	13, 58, 79, 117, 151, 163, 258
M5284	Automann	18600	45
M5286	Automann	18600	45
M5316	Automann	12043	166
M5352	Automann	19001	16, 62, 127, 242
M5358	Automann	18600	45
M5UB	Automann	12002	163
M600	Kenworth	11705	149
M601	Kenworth	11520	145
M601	Kenworth	11523	145
M60170NR	Kenworth	11520	145
M60170NR	Kenworth	11523	145
M60270NR	Kenworth	11533	145
M695	BWP	18566	44, 56, 127, 156, 171, 186, 200, 279
M700	Kenworth	11537	146
M700	Kenworth	11613	148
M8358	Automann	14509	184, 211
M876	Automann	12041	166

OEM	Brand	Part Id	Page
M9626	Automann	13009	54, 229
M9626UB	Automann	13009	54, 229
M9632	Automann	13037	54, 230, 275
M9632UB	Automann	13037	54, 230, 275
M9UB	Automann	12046	167
MA10000	Atro	12015	164, 258
MA20000	Atro	12028	165
MA32000	Atro	12053	167
MA36000	Atro	12014	164
MA36500	Atro	12006	164
MA36500	Atro	12040	166
MA37000	Atro	12010	164
MA37200	Atro	12009	164
MA37200	Atro	12040	166
MBT6805040382	Sterling Truck	11117	222
MBTA6805040382	Freightliner	11117	38
MC806960	Mitsubishi	18830	96
MC81266	Mitsubishi	18830	96
MC812666	Mitsubishi	18830	96
MH1432	Automann	18566	44, 56, 127, 156, 171, 186, 200, 279
MH1432UB	Automann	18566	44, 56, 127, 156, 171, 186, 200, 279
MH1433	Automann	11550	147, 193
MH1433	Automann	18244	156, 200, 234
MH1433UB	Automann	11550	147, 193
MH1433UB	Automann	18244	156, 200, 234
MHS225K	Automann	13611	7, 88
MHS225K	Automann	13722	8, 93, 124
MHS736	Automann	13628	88
MHS79K	Automann	13527	82
MIB130L	Flagg	12028	165
MIB130LUB	Flagg	12028	165
MIB130S	Flagg	12029	165
MIB130SUB	Flagg	12029	165
MIB219	Flagg	12015	164, 258
MIB219UB	Flagg	12015	164, 258
MIB276	Flagg	12015	164, 258
MIH14UB	Automann	19001	16, 62, 127, 242
MIH52	Automann	30544	129
MIS1486	Automann	19001	16, 62, 127, 242
MK336202	Mitsubishi	18830	96
MK633449	Mitsubishi	18830	96
MKW14	Automann	11501	143
MLC10	Automann	13649	15, 89, 122, 170
MLC11	Automann	11740	10
MLC2	Automann	13625	88
MLC3	Automann	13626	42, 88, 121, 169, 199, 262
MLC4	Automann	13650	15, 59, 89, 122, 262
MLC5	Automann	13626	42, 88, 121, 169, 199, 262
MLC8	Automann	13650	15, 59, 89, 122, 262
MM4662000	Atro	11089	36, 222
MM4662001	Atro	11077	35, 221
MM4662002	Atro	11074	35, 221
MM4662002	Atro	11090	36, 222
MM4662003	Atro	11018	33
MM4662003	Atro	11087	36
MM4662051	Atro	11077	35, 221
MM4662301	Atro	11077	35, 221
MM4662416	Atro	11065	34, 221
MM4662416	Atro	11088	36, 221
MM5562004	Atro	34510	133
MM5562005	Atro	34525	45, 134
MM55620C7	Atro	34507	132
MM55623C3	Atro	34509	17, 133
MM55623C3	Atro	34526	17, 134
MM55624C3	Atro	34509	17, 133
MM55624C3	Atro	34526	17, 134

Cross Reference continued

OEM	Brand	Part Id	Page
MM55626C2	Atro	34507	132
MM55629C7	Atro	34510	133
MM5962001	Atro	11760	151
MM5962407	Atro	11615	149, 194
MM5962407	Atro	11762	152, 194
MM6262002	Atro	12045	166
MM6262322	Atro	12045	166
MM6262329	Atro	12045	166
MM6262334	Atro	12026	165
MM7562370	Atro	12368	197
MM7562370HT	Atro	12368	197
MM7562372	Atro	12369	197
MM7562372HT	Atro	12369	197
MM7562377	Atro	12368	197
MM9662401	Atro	11520	40, 145, 192, 222, 278
MM9662401	Atro	11523	40, 145, 192, 223, 278
MM9662870	Atro	12301	259, 278
MMB985	Automann	13524	82, 210
MNW900081395	Fruehauf	14513	55
MNW90008148S	Fruehauf	14529	55
MP1	Flagg	12006	164
MP1	Flagg	12040	166
MP10	Flagg	12006	164
MP2	Flagg	12014	164
MP4	Flagg	12010	164
MP5	Flagg	12053	167
MP6	Flagg	12009	164
MP6	Flagg	12040	166
MP7	Flagg	12014	164
MP8	Flagg	12009	164
MP8	Flagg	12040	166
MP8UB	Flagg	12009	164
MP8UB	Flagg	12040	166
MR1000	Peterbilt	12368	197
MR1001	Peterbilt	12369	197
MR568	Automann	11060	116, 142
MR596	Automann	11063	34
MR610	Flagg	13683	43, 90, 122, 308
MR620	Automann	13513	169, 239
MR620UB	Automann	13513	169, 239
MR622	Automann	12043	166
MR624	Automann	12041	166
MR630	Flagg	13686	43, 91, 122, 262, 309
MR640	Flagg	13687	91, 309
MR642	Automann	17275	15
MR650	Flagg	13688	91, 309
MR656	Automann	11005	12, 32, 115
MR656UB	Automann	11005	12, 32, 115
MR660	Flagg	13690	59, 91, 122, 309
MR660	Flagg	13691	43, 91, 123, 262, 309
MR661	Flagg	12044	41, 79, 117, 153, 217, 259, 306
MR661	Flagg	13691	43, 91, 123, 262, 309
MR664	Automann	11005	12, 32, 115
MR670	Flagg	13692	59, 91, 123, 309
MR671	Flagg	13693	91, 309
MR680	Flagg	13694	43, 92, 123, 262, 310
MR681	Flagg	13695	43, 92, 123, 184, 263, 310
MR690	Flagg	13696	43, 92, 123, 263, 310
MR691	Flagg	13697	43, 92, 123, 263, 310
MR700	Flagg	13698	59, 92, 123, 310
MR701	Flagg	13699	59, 92, 123, 310

OEM	Brand	Part Id	Page
MR766	Flagg	13700	92, 124, 310
MR767	Flagg	13701	92, 124, 310
MR772	Automann	11094	13, 36, 77, 222, 277
MR772UB	Automann	11094	13, 36, 77, 222, 277
MR782	Automann	11083	35, 77, 116, 192
MR828	Automann	11765	152, 195
MR830	Automann	11764	152, 194
MR836	Automann	11753	151
MR836UB	Automann	11753	151
MS4629002	Atro	11118	39
MS62620	Atro	50054	301
MS9939159	Atro	12380	300
MS9939709	Atro	50056	301
MS9962620	Atro	18015	44, 224, 279, 301
MS9963399	Atro	11611	40, 116, 148, 162, 193, 258
MS9965045	Atro	18905	287
MSB506L	Automann	12028	165
MSB506LUB	Automann	12028	165
MSB506S	Automann	12029	165
MSB506SUB	Automann	12029	165
MSB684	Automann	12015	164, 258
MSB684UB	Automann	12015	164, 258
MTB160	Automann	11060	116, 142
MTB170	Automann	18600	45
MTN456	Automann	14522	185, 211, 232, 275
MTN457	Automann	14522	185, 211, 232, 275
MTRKIT11126	Aurora Trailer	50033	236
N109	Flagg	14504	124, 184, 211, 240
N110	Flagg	14532	186, 212
N111	Flagg	31592	171, 186
N112	Flagg	14527	125, 185
N112UB	Flagg	14527	125, 185
N115	Flagg	14526	185
N119	Flagg	14510	184, 231
N119UB	Flagg	14510	184, 231
N120	Flagg	14513	44, 55, 125, 170, 185, 223, 232, 263, 275
N120UB	Flagg	14513	44, 55, 125, 170, 185, 223, 232, 263, 275
N124	Flagg	14529	55, 186
N124	Flagg	14533	44, 125, 170, 186, 223, 232, 263, 275
N211	Flagg	14523	185
N215	Flagg	14521	185, 211, 232, 275
N215UB	Flagg	14521	185, 211, 232, 275
N217	Flagg	14524	185
N22174	GMC/RTS/Nova	33503	250
N244	Flagg	14505	184
N247	Flagg	14509	184, 211
N254	Flagg	14522	185, 211, 232, 275
N320	Flagg	14514	185
N331	Flagg	14502	184
N332	Flagg	14502	184
N8800599	GMC/RTS/Nova	13520	239
N8800599	GMC/RTS/Nova	13536	239
N8800599	GMC/RTS/Nova	83520	251
N8884777	GMC/RTS/Nova	13520	239
N8884777	GMC/RTS/Nova	13536	239
N8884777	GMC/RTS/Nova	83520	251
N8888164	GMC/RTS/Nova	13520	239
N8888164	GMC/RTS/Nova	13536	239
N8888164	GMC/RTS/Nova	83520	251
NA47000	Atro	13577	120
NEW90008139	Aurora Trailer	14513	232
NEW90008139	Freightliner	14513	44
NEW90008139	Sterling Truck	14513	223

Cross Reference continued

OEM	Brand	Part Id	Page
NEW90008139	Volvo	14513	263
NEW90008139	Wabash	14513	232
NEW90008149	Aurora Trailer	14533	232
NEW90008149	Volvo	14533	263
NEW90008149	Wabash	14533	232
NL1138	New Life	17539	284
NP508	Neway	14500	184
NP5081	Neway	14501	184
NW30000	Atro	14521	185, 211, 232, 275
NW90008139	Stoughton	14513	232
NW90008149	Stoughton	14533	232
O35A	Miscellaneous	18750	324
O37A	Miscellaneous	18746	324
O46A	Miscellaneous	18747	324
OGBRNG	Automann	19001	16, 62, 127, 242
OGBRNG	Automann	18600	45
P205	Premier	18851	295
P205A	Premier	18851	295
PB0026422	Atro	50033	7, 46, 172, 225, 236, 274
PB0036314	Atro	34514	6, 94, 275
PB14656U	Peterbilt	12357	196
PB15	Flagg	34554	200, 312
PB33	Flagg	12395	182, 198, 307
PB42	Flagg	12354	195
PB44	Flagg	12362	196
PB46	Flagg	12398	79, 182, 198, 307
PB4626268	Atro	11083	35, 77, 116, 192
PB5	Flagg	12351	195
PB5026648	Atro	18821	94
PB5036000	Atro	13628	88
PB5036100	Atro	13600	87
PB5036321	Atro	13594	87
PB5036914	Atro	13510	81
PB5721139	Atro	14513	44, 55, 125, 170, 185, 223, 232, 263, 275
PB5721149	Atro	14533	44, 125, 170, 186, 223, 232, 263, 275
PB6	Flagg	12350	195
PB6265251	Atro	12048	167
PB6UB	Flagg	12350	195
PB7	Flagg	12361	196
PB7529101	Atro	12362	196
PB7529674	Atro	12361	196
PB85360B0	Atro	11711	41, 162, 217, 223
PB9926071	Atro	13539	230
PB9936012	Atro	18711	236
PB9936013	Atro	18710	236
PBB4656	Peterbilt	12381	198
PL1002	Atro	10002	293
PL1003	Atro	11085	35
PL1003	Atro	11725	41
PL1004	Atro	13009	54, 229
PL1005	Atro	13037	54, 230, 275
PL1006	Atro	11517	293
PL1008	Atro	11502	143
PL1008	Atro	11719	149
PL1009	Atro	11705	116, 149, 194, 278
PL1010	Atro	11709	149, 194
PL1011	Atro	11545	147, 162
PL1012	Atro	11539	146, 193
PL1012	Atro	11614	148, 193
PL1012	Atro	11761	151, 194
PL1013	Atro	11537	40, 146, 192
PL1013	Atro	11613	41, 148, 193
PL1014	Atro	11535	146
PL1015	Atro	11520	40, 145, 192, 222, 278

OEM	Brand	Part Id	Page
PL1015	Atro	11523	40, 145, 192, 223, 278
PL1015HT	Atro	11520	40, 145, 192, 222, 278
PL1015HT	Atro	11523	40, 145, 192, 223, 278
PL1016	Atro	11533	145, 278
PL1017	Atro	12000	163
PL1017HT	Atro	12000	163
PL1018	Atro	12356	196
PL1018HT	Atro	12356	196
PL1020	Atro	18575	294
PL1021	Atro	18574	294
PL1026	Atro	18010	6, 240, 264
PL1026	Atro	18566	44, 56, 127, 156, 171, 186, 200, 279
PL1028	Atro	11550	147, 193
PL1028	Atro	18244	156, 200, 234
PL1032	Atro	11724	293
PL1037	Atro	11515	144, 293
PL1038	Atro	11501	143
PL1041	Atro	14522	185, 211, 232, 275
PL1046	Atro	11739	10, 117
PL1047	Atro	18919	10
PL1048	Atro	10075	12, 114, 258
PL1049	Atro	18921	10
PL1051	Atro	11020	33
PL1052	Atro	11013	33
PL1053	Atro	11002	32
PL1054	Atro	11000	31
PL1054	Atro	11064	34
PL1055	Atro	10503	115
PL1061	Atro	18256	234
PL1063	Atro	11612	148
PL1063HT	Atro	11612	148
PL1065	Atro	11549	147
PL1068	Atro	11062	142, 192
PL1070	Atro	11707	41, 149, 194
PL1070	Atro	12355	153, 196
PL1070HT	Atro	11707	41, 149, 194
PL1074	Atro	12367	197
PL1075	Atro	12350	195
PL1076	Atro	12351	195
PL1077	Atro	11554	147, 193
PL1079	Atro	18558	234, 294
PL1080	Atro	18851	295
PL1084	Atro	13001	54, 100, 229
PL1085	Atro	13005	54
PL1086	Atro	18232	61, 265
PL1087	Atro	18222	61, 265
PL1088	Atro	18222	61, 265
PL1090	Atro	12029	165
PL1091	Atro	12023	164
PL1104	Atro	10505	115
PL1105	Atro	11707	41, 149, 194
PL1105HT	Atro	11707	41, 149, 194
PL1107	Atro	11544	40, 162
PL1107	Atro	18837	45, 171
PL1109	Atro	12017	164
PL1110	Atro	10020	31, 113
PL1111	Atro	18102	200, 279
PL1112	Atro	18786	200
PL1113	Atro	10026	114
PL1114	Atro	18063	126
PL1115	Atro	15051	213, 233
PL1116	Atro	15011	213
PL1116	Atro	15019	213
PL1116	Atro	15073	214
PL1117	Atro	15008	125, 212, 232

Cross Reference continued

OEM	Brand	Part Id	Page
PL1118	Atro	15013	94, 125, 213, 232, 264
PL1119	Atro	14008	55, 100, 199, 211, 231, 263, 275
PL1119	Atro	14073	55, 102, 211, 231, 275
PL1126	Atro	12366	197, 279
PL1126HT	Atro	12366	197, 279
PL1130	Atro	10080	293
PL1131	Atro	12046	167
PL1131	Atro	12047	167
PL1133	Atro	11019	33, 220
PL1136	Atro	11705	116, 149, 194, 278
PL1139	Atro	30545	280
PL1144	Atro	10001	293
PL1146	Atro	13521	42, 82, 119, 154, 169, 198
PL1146A	Atro	11004	32, 77, 115, 142, 162, 192
PL1147	Atro	11720	149
PL1148	Atro	15001	125, 212
PL1149	Atro	15000	212
PL1150	Atro	11720	149
PL1154	Atro	14510	184, 231
PL1155	Atro	14527	125, 185
PL1177	Atro	15005	212
PL1184	Atro	11502	143
PL1184	Atro	11719	149
PL1189	Atro	12354	195
PT5059307	Atro	13581	328
PT5059736	Atro	13623	328
Q70	Miscellaneous	18748	324
Q70A	Miscellaneous	18745	324
R001	Flagg	15064	44, 171, 214, 224, 233
R002	Flagg	15063	94, 214, 233
R003	Flagg	15064	44, 171, 214, 224, 233
R005422	Meritor	50033	7, 46, 172, 225, 236, 274
R110UB	Flagg	15016	213, 232
R127	Flagg	15009	170, 212
R129	Flagg	15013	94, 125, 213, 232, 264
R129UB	Flagg	15013	94, 125, 213, 232, 264
R131	Flagg	15051	213, 233
R131UB	Flagg	15051	213, 233
R132	Flagg	15017	213, 232, 264
R150	Flagg	15020	213
R150UB	Flagg	15008	125, 212, 232
R161	Flagg	15000	212
R208	Flagg	14010	15, 94, 155, 211, 231
R209	Flagg	15001	125, 212
R210600	Meritor	17251	15
R210608	Meritor	16000	59
R234	Flagg	15061	125, 214, 233
R235	Flagg	15020	213
R251	Flagg	18956	214
R3010057	Meritor	15020	213
R301020	Meritor	13005	54
R301024	Meritor	13683	43, 90, 122, 308
R3010302	Meritor	11720	149
R3010303	Meritor	11729	78, 116, 150, 194
R3010310	Meritor	13683	43, 90, 122, 308
R3010315	Meritor	13691	43, 91, 123, 262, 309
R3010677	Meritor	19002	218
R301072	Meritor	15017	213, 232, 264
R3010729A	Meritor	13565	85
R3010729A	Meritor	13628	88

OEM	Brand	Part Id	Page
R3010730A	Meritor	13604	87
R3011496	Meritor	13721	93, 124
R3011496	Meritor	13722	8, 93, 124
R301159	Meritor	15016	213, 232
R301160	Meritor	15011	213
R301160	Meritor	15019	213
R301160	Meritor	15073	214
R301330	Meritor	14522	185, 211, 232, 275
R301332	Meritor	14521	185, 211, 232, 275
R301338	Meritor	13500	13, 58, 79, 118, 217, 260
R301339	Meritor	13505	14, 58, 80, 118, 230, 261
R301340	Meritor	13501	13, 58, 80, 118, 217, 230, 260
R301341A	Meritor	13553	14, 58, 85, 120, 155, 210, 217, 230, 261
R301546	Meritor	13534	83, 120
R301546	Meritor	13558	85
R301594	Meritor	13537	14, 83, 261
R301595	Meritor	13543	14, 84, 210, 261
R301598A	Meritor	13650	15, 59, 89, 122, 262
R301940	Meritor	13592	14, 58, 86, 121, 262
R301960	Meritor	13650	15, 59, 89, 122, 262
R301964	Meritor	15009	170, 212
R301966	Meritor	15001	125, 212
R301980	Meritor	15013	94, 125, 213, 232, 264
R301982	Meritor	15051	213, 233
R301983	Meritor	15064	44, 171, 214, 224, 233
R301999A	Meritor	14000	55, 100, 210, 230
R302225	Meritor	13522	42, 82, 119, 154, 169, 199, 261
R302225	Meritor	83522	46, 95, 136, 157, 172, 201, 274
R302226	Meritor	13520	5, 82, 119, 154, 169, 198, 239, 261, 279
R302226	Meritor	13536	5, 83, 120, 155, 169, 199, 239, 279
R302226	Meritor	83520	7, 95, 136, 157, 172, 201, 218, 251, 280
R302227	Meritor	13684	90, 122, 183
R302228	Meritor	13518	81, 119, 154, 183, 198, 261
R302228	Meritor	13533	83, 120, 183, 261, 279
R302232	Meritor	13649	15, 89, 122, 170
R302238	Meritor	13514	81, 118, 154, 198
R302372	Meritor	13502	80, 118, 210
R302553	Meritor	13544	84
R302554	Meritor	13545	84, 120
R302555	Meritor	13547	84, 120
R302639	Meritor	13683	43, 90, 122, 308
R302641	Meritor	13693	91, 309
R302642	Meritor	13691	43, 91, 123, 262, 309
R302771	Meritor	13553	14, 58, 85, 120, 155, 210, 217, 230, 261
R302812	Meritor	13697	43, 92, 123, 263, 310
R302814	Meritor	13517	81, 119, 183
R302815	Meritor	12031	13, 79, 117, 165
R302816	Meritor	13516	81, 119, 183
R302850	Meritor	15000	212
R302862	Meritor	13504	80, 118
R302917	Meritor	12006	164
R302919	Meritor	12010	164
R302920	Meritor	12014	164
R302921A	Meritor	12029	165
R302924A	Meritor	12028	165
R303275A	Meritor	12015	164, 258

Cross Reference continued

OEM	Brand	Part Id	Page
R303296	Meritor	11002	32
R303362	Meritor	14010	15, 94, 155, 211, 231
R303394A	Meritor	14001	210, 230
R303411	Meritor	13515	81, 119, 154, 183
R303540A	Meritor	11000	31
R303540A	Meritor	11064	34
R303579	Meritor	13009	54, 229
R303582	Meritor	13037	54, 230, 275
R303679	Meritor	12053	167
R303680	Meritor	12009	164
R303784	Meritor	13577	120
R303795	Meritor	12329	118
R303868	Meritor	13528	83, 119, 154, 183, 199, 239
R303977	Meritor	15001	125, 212
R304250	Meritor	14502	184
R304252	Meritor	31592	171, 186
R304253	Meritor	14527	125, 185
R304254	Meritor	14526	185
R304255	Meritor	14510	184, 231
R304382A	Meritor	14513	44, 55, 125, 170, 185, 223, 232, 263, 275
R304410A	Meritor	14529	55, 186
R304410A	Meritor	14533	44, 125, 170, 186, 223, 232, 263, 275
R304669	Meritor	11502	143
R304669	Meritor	11719	149
R304677A	Meritor	18919	10
R304678A	Meritor	18920	10
R304685	Meritor	11740	10
R304773	Meritor	12361	196
R304775	Meritor	12350	195
R304776	Meritor	12351	195
R304827	Meritor	15054	213, 233
R305081	Meritor	14524	185
R305216	Meritor	14027	101, 231
R305217	Meritor	14027	101, 231
R305269	Meritor	13526	14, 82, 169
R305270	Meritor	13512	14, 81
R305275	Meritor	11004	32, 77, 115, 142, 162, 192
R305275	Meritor	13521	42, 82, 119, 154, 169, 198
R305276	Meritor	14010	15, 94, 155, 211, 231
R305309	Meritor	13566	86, 262
R306121	Meritor	13565	85
R306122	Meritor	13542	84, 120
R30640	Meritor	14004	231
R306979	Meritor	13505	14, 58, 80, 118, 230, 261
R306980	Meritor	13543	14, 84, 210, 261
R307426	Meritor	11739	10, 117
R307427	Meritor	18919	10
R307430	Meritor	11013	33
R307431	Meritor	11725	41
R307432	Meritor	13005	54
R307433	Meritor	13001	54, 100, 229
R307439	Meritor	18222	61, 265
R307440	Meritor	18232	61, 265
R307441	Meritor	12028	165
R307445	Meritor	10002	293
R307446A	Meritor	11502	143
R307446A	Meritor	11719	149
R307448	Meritor	11554	147, 193
R307450	Meritor	11517	293
R307451	Meritor	11515	144, 293
R307452	Meritor	14000	55, 100, 210, 230
R307453	Meritor	14008	55, 100, 199, 211, 231, 263, 275

OEM	Brand	Part Id	Page
R307453	Meritor	14073	55, 102, 211, 231, 275
R307455	Meritor	14027	101, 231
R307457	Meritor	18256	234
R307462	Meritor	11705	116, 149, 194, 278
R307464	Meritor	11062	142, 192
R307466	Meritor	11709	149, 194
R307467	Meritor	11545	147, 162
R307468	Meritor	11539	146, 193
R307468	Meritor	11614	148, 193
R307468	Meritor	11761	151, 194
R307469	Meritor	11537	40, 146, 192
R307469	Meritor	11613	41, 148, 193
R307470	Meritor	11535	146
R307471	Meritor	11612	148
R307472	Meritor	11520	40, 145, 192, 222, 278
R307472	Meritor	11523	40, 145, 192, 223, 278
R307473	Meritor	11533	145, 278
R307474	Meritor	11550	147, 193
R307474	Meritor	18244	156, 200, 234
R307477	Meritor	12000	163
R307478	Meritor	12029	165
R307479	Meritor	12015	164, 258
R307480	Meritor	12014	164
R307481	Meritor	12006	164
R307483	Meritor	10026	114
R307484	Meritor	10020	31, 113
R307485	Meritor	14510	184, 231
R307486	Meritor	14521	185, 211, 232, 275
R307492	Meritor	11501	143
R307503	Meritor	12367	197
R307506	Meritor	11707	41, 149, 194
R307506	Meritor	12355	153, 196
R307507	Meritor	12356	196
R307508	Meritor	12366	197, 279
R307509	Meritor	12350	195
R307516	Meritor	18575	294
R307517	Meritor	18574	294
R307518	Meritor	18558	234, 294
R307520	Meritor	15013	94, 125, 213, 232, 264
R307522	Meritor	15051	213, 233
R307523	Meritor	15011	213
R307523	Meritor	15019	213
R307523	Meritor	15073	214
R307529	Meritor	18566	44, 56, 127, 156, 171, 186, 200, 279
R307621	Meritor	14038	102
R307638	Meritor	13522	42, 82, 119, 154, 169, 199, 261
R307638	Meritor	83522	46, 95, 136, 157, 172, 201, 274
R307639	Meritor	13520	5, 82, 119, 154, 169, 198, 239, 261, 279
R307639	Meritor	13536	5, 83, 120, 155, 169, 199, 239, 279
R307639	Meritor	83520	7, 95, 136, 157, 172, 201, 218, 251, 280
R307640	Meritor	11549	147
R307641	Meritor	12023	164
R307644	Meritor	18063	126
R307645	Meritor	18851	295
R307712	Meritor	14002	210
R307766	Meritor	11739	10, 117
R307767	Meritor	18921	10
R307840	Meritor	12362	196
R307841	Meritor	12354	195
R30813	Meritor	15005	212
R308650	Meritor	18222	61, 265

Cross Reference continued

OEM	Brand	Part Id	Page
R308651	Meritor	13518	81, 119, 154, 183, 198, 261
R308653	Meritor	15016	213, 232
R308654	Meritor	15001	125, 212
R308663	Meritor	13009	54, 229
R308664	Meritor	13037	54, 230, 275
R308666	Meritor	14038	102
R308667	Meritor	12010	164
R308669	Meritor	14522	185, 211, 232, 275
R308670	Meritor	14522	185, 211, 232, 275
R308681	Meritor	14527	125, 185
R308688	Meritor	15017	213, 232, 264
R308694	Meritor	15005	212
R308701	Meritor	18919	10
R308702	Meritor	18920	10
R308804	Meritor	11005	12, 32, 115
R308853A	Meritor	31095	271, 312
R308917	Meritor	18921	10
R308918	Meritor	10075	12, 114, 258
R308919	Meritor	12360	196
R30927	Meritor	13001	54, 100, 229
R309292	Meritor	14514	185
R309323	Meritor	11512	144
R309323	Meritor	11514	144
R309323	Meritor	11735	4, 150
R309325	Meritor	13607	59, 87, 121
R309326	Meritor	13596	87
R309326	Meritor	83596	8, 62, 95, 136
R30934	Meritor	14008	55, 100, 199, 211, 231, 263, 275
R30934	Meritor	14073	55, 102, 211, 231, 275
R309350	Meritor	15061	125, 214, 233
R309359	Meritor	13505	14, 58, 80, 118, 230, 261
R309395	Meritor	11714	78
R309401	Meritor	13526	14, 82, 169
R309410	Meritor	13721	93, 124
R309410	Meritor	13722	8, 93, 124
R309416	Meritor	13625	88
R309419	Meritor	13560	85
R309420	Meritor	13609	14, 87, 121, 183, 210
R309421	Meritor	13610	88, 121
R309432	Meritor	13527	82
R309437	Meritor	19002	218
R309438	Meritor	19003	200, 218
R309439	Meritor	19005	218
R309439	Meritor	19008	218
R309440	Meritor	11500	143, 217
R309440	Meritor	19004	157, 218
R309510	Meritor	13543	14, 84, 210, 261
R309511	Meritor	13501	13, 58, 80, 118, 217, 230, 260
R309513	Meritor	13650	15, 59, 89, 122, 262
R309514	Meritor	13649	15, 89, 122, 170
R309515	Meritor	13592	14, 58, 86, 121, 262
R309517	Meritor	13517	81, 119, 183
R309518	Meritor	12031	13, 79, 117, 165
R309520	Meritor	13500	13, 58, 79, 118, 217, 260
R309550	Meritor	18956	214
R309566	Meritor	13512	14, 81
R309577	Meritor	13566	86, 262
R617005	Meritor	17682	285
RB1570S	Dayton Parts	11083	35, 77, 116, 192
RB161	Dayton Parts	11060	116, 142
RB161	Flagg	11060	116, 142
RB164	SRI	13522	42, 82, 119, 154, 169, 199, 261

OEM	Brand	Part Id	Page
RB164	SRI	83522	46, 95, 136, 157, 172, 201, 274
RB175	Dayton Parts	11063	34
RB187	Dayton Parts	13513	169, 239
RB187	Flagg	13513	169, 239
RB188	Dayton Parts	12043	166
RB188	Flagg	12043	166
RB189	Dayton Parts	12041	166
RB189	Flagg	12041	166
RB198	Dayton Parts	17275	15
RB198	Flagg	17275	15
RB200	Flagg	14003	55, 100, 211, 231
RB201	Flagg	14008	55, 100, 199, 211, 231, 263, 275
RB201	Flagg	14073	55, 102, 211, 231, 275
RB202	Flagg	14004	231
RB205	Dayton Parts	11005	12, 32, 115
RB205	Dayton Parts	11083	35, 77, 116, 192
RB205	Flagg	11005	12, 32, 115
RB205	Flagg	11083	35, 77, 116, 192
RB205U	Dayton Parts	11005	12, 32, 115
RB205UB	Flagg	11005	12, 32, 115
RB211	Dayton Parts	11066	12, 34, 77, 221, 277
RB211	Flagg	11066	12, 34, 77, 221, 277
RB233	Dayton Parts	11066	12, 34, 77, 221, 277
RB233	Flagg	11066	12, 34, 77, 221, 277
RB234	Dayton Parts	11005	12, 32, 115
RB234	Flagg	11005	12, 32, 115
RB235	Flagg	11005	12, 32, 115
RB253	Dayton Parts	34511	133
RB253	Flagg	34511	133
RB260	Flagg	11005	12, 32, 115
RB263	Dayton Parts	11094	13, 36, 77, 222, 277
RB263	Flagg	11094	13, 36, 77, 222, 277
RB268	Dayton Parts	11005	12, 32, 115
RB268	Dayton Parts	11083	35, 77, 116, 192
RB268	Flagg	11005	12, 32, 115
RB268	Flagg	11083	35, 77, 116, 192
RB291	Dayton Parts	11765	152, 195
RB292	Dayton Parts	11764	152, 194
RB295	Dayton Parts	11753	151
RB299	Automann	18821	94
RB308	Dayton Parts	11763	152
RB328	Dayton Parts	11767	152, 195
RB328	Flagg	11767	152, 195
RBT200	Flagg	13001	54, 100, 229
RBT200UB	Flagg	13001	54, 100, 229
RBT201	Flagg	14008	55, 100, 199, 211, 231, 263, 275
RBT201	Flagg	14073	55, 102, 211, 231, 275
RBT207	Flagg	13515	81, 119, 154, 183
RD1170	Automann	11711	41, 162, 217, 223
RD1175	Automann	11711	41, 162, 217, 223
RD604UB	Automann	19003	200, 218
RDW1117680B060	Freightliner	11711	41
RDW1117680B070	Freightliner	11711	41
REYTK19089	Freightliner	15064	44
REYTK19089	Sterling Truck	15064	224
RK03809	Holland	18094	293
RM4663359	Atro	11117	38, 222
RM4663471	Atro	11129	39, 222
RM55638C2	Atro	31604	132
RNGBM	Dayton Parts	19001	16, 62, 127, 242
RNGOGB	Flagg	19001	16, 62, 127, 242
RNKBM	Dayton Parts	18600	45
RNKOGB	Flagg	18600	45
RS20210	Atro	11500	143, 217
RS20210	Atro	19004	157, 218

Cross Reference continued

OEM	Brand	Part Id	Page
RS20216	Atro	19004	157, 218
RS20220	Atro	19002	218
RS20222	Atro	19003	200, 218
RS20230	Atro	19005	218
RS20230	Atro	19008	218
RW53000	Atro	11512	144
RW53000	Atro	11514	144
RW53000	Atro	11735	4, 150
RWKIT1126	Stoughton	50033	236
S11613	Hendrickson	13542	84
S13291	Newstar	12073	168, 306
S13292	Newstar	12072	168, 306
S20681	Hendrickson	13541	84
S20924	Hendrickson	13604	87
S20924	Hendrickson	13673	90
S20925	Hendrickson	13604	87
S20925	Hendrickson	13673	90
S21052	Hendrickson	13604	87
S21099	Hendrickson	13648	89
S21166	Hendrickson	13628	88
S21307	Hendrickson	13581	328
S23319	Hendrickson	13673	90
S23320	Hendrickson	13594	87
S24679	Hendrickson	13604	87
S24691	Hendrickson	13600	87
S24691	Hendrickson	13628	88
S24736	Hendrickson	13623	328
S26321	Hendrickson	13594	87
S3580001635	Autocar	13679	8
S3580003635	Autocar	13679	8
S6914	Hendrickson	13510	81
S6914	Hendrickson	13565	85
S7020	Dallas Spring	15020	213
S7096	Dallas Spring	13037	230
S7147	Dallas Spring	15020	213
SAFXB0009	International	18221	127
SAFXB0011	International	18215	126
SAFXB10605	International	40035	136
SB0383008	Atro	30507	16, 56, 127, 200, 242
SB1745	Load Guard	15061	233
SB1UB	Flagg	18566	44, 56, 127, 156, 171, 186, 200, 279
SB3UB	Flagg	11550	147, 193
SD905	Newstar	34509	17, 133
SD905	Newstar	34526	17, 134
SK0010500	Atro	19001	16, 62, 127, 242
SK1259	Jost	18709	295
SK210525	Jost	18708	295
SK27771	Atro	12042	166, 305
SK50340HW	Atro	12039	166, 259
SK50341	Atro	12037	166
SK50342	Atro	12038	166
SK50380HW	Atro	12036	165, 258
SK5510600	Atro	19001	16, 62, 127, 242
SK5510700	Atro	19001	16, 62, 127, 242
SK5910000	Atro	11757	151
SK6210600	Atro	12041	166
SK6210700	Atro	12043	166
SK80268	Atro	13601	87, 121
SK80340	Atro	13504	80, 118
SK80380	Atro	13587	86
SK80382	Atro	13548	84
SM10359	Lord	11117	38, 222
SP	Miscellaneous	18822	325
SP0011005	Atro	11767	152, 195
SP0039	Watson & Chalin	13037	275
SP0040	Watson & Chalin	14522	275
SP0192	Watson & Chalin	14521	275

OEM	Brand	Part Id	Page
SP0193	Watson & Chalin	14522	275
SP1324	York Transport	18690	235
SP1431	York Transport	18710	236
SP1432	York Transport	18711	236
SP2106611X	Freightliner	40074	46
SP4311198	Atro	17275	15
SP4611023	Atro	11094	13, 36, 77, 222, 277
SP4652800	Atro	11066	12, 34, 77, 221, 277
SP55113C1	Atro	19001	16, 62, 127, 242
SP5552600	Atro	34511	133
SP5911006	Atro	11753	151
SP5911007	Atro	11763	152
SP5911010	Atro	11758	13, 58, 79, 117, 151, 163, 258
SP5911378	Atro	11060	116, 142
SP621154M	Atro	12041	166
SP651979	Dana	16000	59
SP7109	York Transport	18691	235
SP7110	York Transport	18692	235
SP7111	York Transport	18689	235
SP7119	York Transport	18697	235
SP7128	York Transport	18696	235
SP7155	York Transport	18701	235
SP7165	York Transport	18700	235
SRK530	Neway	50047	186
SS219117	Peterbilt	34554	200
SSB3310017	Freightliner	11018	33
SSB3310017	Freightliner	11087	36
SSB3310018	Freightliner	11018	33
SSB3310018	Freightliner	11087	36
SSR0035P240	Mack	12051	167
SSS0219P210	Roadleveler	12069	168, 306
SU0029001	Atro	11765	152, 195
SU0029002	Atro	11764	152, 194
SU5029383	Atro	13627	88
SU9939113	Atro	50031	6
SU9939114	Atro	50032	6
SU9939115	Atro	50033	7, 46, 172, 225, 236, 274
SU9939116	Atro	50032	6
SW5929461	Atro	11733	150
SW5929461	Atro	11734	150
SW5929461	Atro	11766	152
T11723	Reyco	15009	212
T1842	Reyco	15020	213
T1842	Reyco	15008	212
T2101	Reyco	15005	212
T2102	Reyco	15005	212
T2242	Reyco	15051	213
T3214	Reyco	14002	210
T3214	Reyco	15017	213
T5493	Reyco	15011	213
T5493	Reyco	15019	213
T5493	Reyco	15073	214
T5524	Reyco	15016	213
T5644	Reyco	15001	212
T5711	Hutchens	14027	101
TALAA5872A	Ford	13505	14
TAR411041	Ford	17279	16
TB68	Dayton Parts	11060	116, 142
TB68	Dayton Parts	11757	151
TB68	Dayton Parts	11758	13, 58, 79, 117, 151, 163, 258
TB68	Flagg	11060	116, 142
TB68	Flagg	11757	151
TB68	Flagg	11758	13, 58, 79, 117, 151, 163, 258
TB73	Dayton Parts	18600	45
TB73	Flagg	18600	45
TC7105	Miscellaneous	18695	323

Cross Reference continued

OEM	Brand	Part Id	Page
TD105	Uro	19001	16, 62, 127, 242
TD188	Uro	12043	166
TD5510	Uro	34511	133
TD551442	Uro	19001	16, 62, 127, 242
TD5520	Uro	19001	16, 62, 127, 242
TD6210	Uro	12041	166
TDACCB101	Freightliner	40075	46
TH0382725	Atro	33503	62, 250
TH0382750	Atro	33502	62, 250
TH0383000	Atro	33506	250
TH0385000	Atro	33500	250
TH0385001	Atro	33502	62, 250
TH0385033	Atro	33502	62, 250
TH1922010	Atro	11739	10, 117
TH1922128	Atro	18919	10
TH1922129	Atro	18920	10
TH4737900	Atro	13042	55, 100, 230
TH50000	Atro	13516	81, 119, 183
TH5022692	Atro	14010	15, 94, 155, 211, 231
TH5337637	Atro	13042	55, 100, 230
TH8322089	Atro	15064	44, 171, 214, 224, 233
TH8322302	Atro	15063	94, 214, 233
TH8337238	Atro	15020	213
TH8337640	Atro	15061	125, 214, 233
TH8337997	Atro	15064	44, 171, 214, 224, 233
TH85000	Atro	13659	89, 240
TK18997	Reyco	15064	214
TK19089	Reyco	15064	214
TK21640	Reyco	15061	214
TK7302	Reyco	15063	214
TM109	Flagg	14001	210, 230
TM38000	Atro	12031	13, 79, 117, 165
TMR514	Automann	11078	35, 304
TMR515	Automann	11153	40, 304
TMR518	Automann	34554	200, 312
TMR520	Automann	12395	182, 198, 307
TMR531	Automann	18860	8, 171, 265, 312
TMR533	Automann	34563	136, 313
TMR536	Automann	11152	40, 304
TMR537	Automann	12397	153, 198, 307
TMR539	Automann	11795	153, 195, 305
TMR547	Automann	13634	89, 170, 308
TMR553	Automann	11792	153, 195, 305
TMR63	Automann	18860	8, 171, 265, 312
TMR640	Automann	13687	91, 309
TMR640	Automann	13688	91, 309
TMR660	Automann	13690	59, 91, 122, 309
TMR670	Automann	13692	59, 91, 123, 309
TMR680	Automann	13694	43, 92, 123, 262, 310
TMR681	Automann	13695	43, 92, 123, 184, 263, 310
TMR690	Automann	13696	43, 92, 123, 263, 310
TMR691	Automann	13697	43, 92, 123, 263, 310
TMR700	Automann	13698	59, 92, 123, 310
TMR701	Automann	13699	59, 92, 123, 310
TMR74	Automann	11793	153, 305
TMR74B	Automann	11793	153, 305
TMR9247	Automann	13657	7, 223, 279, 308
TMRU610	Automann	13683	43, 90, 122, 308
TMRU620	Automann	13686	43, 91, 122, 262, 309
TMRU660	Automann	13691	43, 91, 123, 262, 309
TMRU661	Automann	13691	43, 91, 123, 262, 309
TP110	Flagg	15054	213, 233

OEM	Brand	Part Id	Page
TR0041001	Atro	12397	153, 198, 307
TR0041009	Atro	11792	153, 195, 305
TR0041600	Atro	11795	153, 195, 305
TR030010040	Clevite	11081	35, 304
TR030020010	Clevite	11792	153, 195, 305
TR1341022	Atro	13657	7, 223, 279, 308
TR4641000	Atro	11152	40, 304
TR4641002	Atro	11081	35, 304
TR4641316	Atro	11153	40, 304
TR4641716	Atro	11078	35, 304
TR5041102	Atro	13735	15, 93, 124, 155, 170, 263, 311
TR5041615	Atro	13733	43, 93, 124, 170, 223, 263, 311
TR5041645	Atro	34555	45, 95, 135, 172, 224, 273, 312
TR5042455	Atro	12396	42, 79, 118, 168, 260, 307
TR5042590	Atro	34556	45, 95, 136, 172, 224, 273, 312
TR55418C1	Atro	34563	136, 313
TR5941008	Atro	11793	153, 305
TR5941150	Atro	13679	8, 42, 90, 155, 199, 308
TR5941375	Atro	11751	4, 41, 78, 117, 151, 163, 223, 304
TR5941376	Atro	11080	116, 142, 162, 192, 277, 304
TR5941474	Atro	11773	152, 305
TR6000	Atro	12379	307
TR60000	Atro	13590	86, 307
TR60000	Atro	13682	308
TR6241180	Atro	12072	168, 306
TR6241215	Atro	12073	168, 306
TR6241220	Atro	13634	89, 170, 308
TR6241238	Atro	12074	117, 168, 307
TR6241243	Atro	12071	79, 168, 306
TR62413M2	Atro	12069	168, 306
TR62413M3	Atro	12070	79, 168, 306
TR70005	Atro	12379	307
TR70005	Atro	13590	86, 307
TR70005	Atro	13681	308
TR71000	Atro	13683	43, 90, 122, 308
TR72000	Atro	13686	43, 91, 122, 262, 309
TR74000	Atro	13701	92, 124, 310
TR75000	Atro	13690	59, 91, 122, 309
TR75000	Atro	13691	43, 91, 123, 262, 309
TR7541059	Atro	34554	200, 312
TR7541108	Atro	12398	79, 182, 198, 307
TR7541327	Atro	12395	182, 198, 307
TR76000	Atro	13694	43, 92, 123, 262, 310
TR76000	Atro	13695	43, 92, 123, 184, 263, 310
TR77000	Atro	13696	43, 92, 123, 263, 310
TR77000	Atro	13697	43, 92, 123, 263, 310
TR78000	Atro	13703	93, 124, 311
TR79000	Atro	13704	93, 311
TR81000	Atro	13692	59, 91, 123, 309
TR81000	Atro	13693	91, 309
TR82000	Atro	13687	91, 309
TR83000	Atro	13700	92, 124, 310
TR84000	Atro	13688	91, 309
TR85000	Atro	13698	59, 92, 123, 310
TR85000	Atro	13699	59, 92, 123, 310
TR9641068	Atro	18860	8, 171, 265, 312
TR9641268	Atro	31095	271, 312

Cross Reference continued

OEM	Brand	Part Id	Page
TRB164	Automann	13522	42, 82, 119, 154, 169, 199, 261
TRB164	Automann	83522	46, 95, 136, 157, 172, 201, 274
TRB5004	Automann	15005	212
TRB5004UB	Automann	15005	212
TRB5023	Automann	15017	213, 232, 264
TRB5028	Automann	15000	212
TRB5029	Automann	15001	125, 212
TRB5031	Automann	18821	94
TRB5066	Automann	15016	213, 232
TRB5168	Automann	13526	14, 82, 169
TRB5168UB	Automann	13526	14, 82, 169
TRB5169	Automann	13577	120
TRB5169UB	Automann	13577	120
TRB5170	Automann	13592	14, 58, 86, 121, 262
TRB5384	Automann	13005	54
TRB5384UB	Automann	13005	54
TRB5496	Automann	14001	210, 230
TRB5541	Automann	14000	55, 100, 210, 230
TRB5541UB	Automann	14000	55, 100, 210, 230
TRB5542	Automann	14038	102
TRB5543	Automann	14002	210
TRB5544	Automann	15054	213, 233
TRB5703	Automann	14533	44, 125, 170, 186, 223, 232, 263, 275
TRB5703	Automann	14529	55, 186
TRB5704	Automann	14526	185
TRB5709	Automann	14527	125, 185
TRB5710	Automann	14510	184, 231
TRB5710UB	Automann	14510	184, 231
TRB5712	Automann	14532	186, 212
TRB5713	Automann	14513	44, 55, 125, 170, 185, 223, 232, 263, 275
TRB5719	Automann	14514	185
TRB5721	Automann	14504	124, 184, 211, 240
TRB5904	Automann	12354	195
TRB5905	Automann	12350	195
TRB5906	Automann	11000	31
TRB5906	Automann	11064	34
TRB5906UB	Automann	11000	31
TRB5906UB	Automann	11064	34
TRB5907	Automann	12351	195
TRB5909	Automann	14521	185, 211, 232, 275
TRB5911	Automann	13512	14, 81
TRB5911UB	Automann	13512	14, 81
TRB5912	Automann	13565	85
TRB5912	Automann	13600	87
TRB5914T	Automann	13623	328
TRB5914UB	Automann	13594	87
TRB6000	Automann	15051	213, 233
TRB6000UB	Automann	15051	213, 233
TRB6002	Automann	15008	125, 212, 232
TRB6002	Automann	15020	213
TRB6002UB	Automann	15008	125, 212, 232
TRB6004	Automann	15013	94, 125, 213, 232, 264
TRB6004UB	Automann	15013	94, 125, 213, 232, 264
TRB6008	Automann	15011	213
TRB6008	Automann	15019	213
TRB6008	Automann	15073	214
TRB6008UB	Automann	15011	213
TRB6008UB	Automann	15019	213
TRB6008UB	Automann	15073	214
TRB6025	Automann	14010	15, 94, 155, 211, 231
TRB603UB	Automann	19002	218
TRB6062	Automann	15009	170, 212
TRB6112	Automann	13518	81, 119, 154, 183, 198, 261

OEM	Brand	Part Id	Page
TRB6112	Automann	13533	83, 120, 183, 261, 279
TRB6112UB	Automann	13518	81, 119, 154, 183, 198, 261
TRB6116	Automann	13684	90, 122, 183
TRB6118	Automann	13517	81, 119, 183
TRB6119	Automann	12031	13, 79, 117, 165
TRB6164	Automann	11003	32
TRB6164	Automann	83522	46, 95, 136, 157, 172, 201, 274
TRB6164UB	Automann	13522	42, 82, 119, 154, 169, 199, 261
TRB6165	Automann	11714	78
TRB6175	Automann	13672	90
TRB6181	Automann	13516	81, 119, 183
TRB6185	Automann	11004	32, 77, 115, 142, 162, 192
TRB6185	Automann	13521	42, 82, 119, 154, 169, 198
TRB6185UB	Automann	11004	32, 77, 115, 142, 162, 192
TRB6185UB	Automann	13521	42, 82, 119, 154, 169, 198
TRB6186	Automann	13514	81, 118, 154, 198
TRB6186UB	Automann	13514	81, 118, 154, 198
TRB6199	Automann	12051	167
TRB6205	Automann	13627	88
TRB6260	Automann	13515	81, 119, 154, 183
TRB6260UB	Automann	13515	81, 119, 154, 183
TRB6300	Automann	13001	54, 100, 229
TRB6300	Automann	14003	55, 100, 211, 231
TRB6300UB	Automann	13001	54, 100, 229
TRB6303	Automann	11002	32
TRB6326	Automann	14008	55, 100, 199, 211, 231, 263, 275
TRB6326	Automann	14073	55, 102, 211, 231, 275
TRB6326UB	Automann	14008	55, 100, 199, 211, 231, 263, 275
TRB6326UB	Automann	14073	55, 102, 211, 231, 275
TRB6327	Automann	18919	10
TRB6328	Automann	18919	10
TRB6328UB	Automann	18919	10
TRB6330	Automann	14011	100, 231
TRB6332	Automann	14004	231
TRB6801	Automann	11512	144
TRB6801	Automann	11514	144
TRB6801	Automann	11735	4, 150
TRB6801UB	Automann	11512	144
TRB6801UB	Automann	11514	144
TRB6801UB	Automann	11735	4, 150
TRB6808	Automann	11500	143, 217
TRB6808	Automann	19004	157, 218
TRB6810	Automann	11511	78, 144
TRB6820	Automann	13520	5, 82, 119, 154, 169, 198, 239, 261, 279
TRB6820	Automann	83520	7, 95, 136, 157, 172, 201, 218, 251, 280
TRB6820UB	Automann	13520	5, 82, 119, 154, 169, 198, 239, 261, 279
TRB6820UB	Automann	13536	5, 83, 120, 155, 169, 199, 239, 279
TRB6820UB	Automann	83520	7, 95, 136, 157, 172, 201, 218, 251, 280
TRB6822	Automann	13528	83, 119, 154, 183, 199, 239
TRB6822UB	Automann	13528	83, 119, 154, 183, 199, 239
TRB8640	Automann	10000	4, 112
TRB8644	Automann	11739	10, 117
TRB8644UB	Automann	11739	10, 117

Cross Reference continued

OEM	Brand	Part Id	Page
TRB8645	Automann	18921	10
TRB8645UB	Automann	18921	10
TRK4931	Automann	50033	7, 46, 172, 225, 236, 274
TRK5384HD	Automann	13041	55
TRK5384UB	Automann	13041	55
TRK5542	Automann	14038	102
TRK5542UB	Automann	14038	102
TRK5904	Automann	12362	196
TRK5905	Automann	12361	196
TRK5912	Automann	13510	81
TRK6002	Automann	15061	125, 214, 233
TRK6008	Automann	15064	44, 171, 214, 224, 233
TRK6008UB	Automann	15064	44, 171, 214, 224, 233
TRK6300	Automann	13042	55, 100, 230
TRK6300UB	Automann	13042	55, 100, 230
TRS3309	Automann	13015	54, 229
TRS4309	Automann	13011	54, 229
TS0385002	Atro	32031	247, 273
TS0385013	Atro	31601	245
TS0385019	Atro	31602	245
TS0385765	Atro	18866	241
TS34000	Atro	13522	42, 82, 119, 154, 169, 199, 261
TS34000	Atro	83522	46, 95, 136, 157, 172, 201, 274
TS34095	Atro	13522	42, 82, 119, 154, 169, 199, 261
TS34095	Atro	83522	46, 95, 136, 157, 172, 201, 274
TS38000	Atro	13520	5, 82, 119, 154, 169, 198, 239, 261, 279
TS38000	Atro	83520	7, 95, 136, 157, 172, 201, 218, 251, 280
TS38750	Atro	13528	83, 119, 154, 183, 199, 239
TS38875	Atro	13685	122, 170
TS45000	Atro	18830	94, 96
TS49000	Atro	13517	81, 119, 183
TS5022210	Atro	13672	90
TS5022256	Atro	11714	78
TS5022691	Atro	13521	42, 82, 119, 154, 169, 198
TS5922400	Atro	11729	78, 116, 150, 194
TSHS73	International	13582	121
TSR234	International	15061	125
TT34000	Atro	13684	90, 122, 183
TT38000	Atro	13518	81, 119, 154, 183, 198, 261
TT38000	Atro	13533	83, 120, 183, 261, 279
TT5022697	Atro	13582	86, 121
TWAA5872A	Ford	13500	13
TWAA5873A	Ford	13501	13
UB16100	Atro	11060	116, 142
UB20500	Atro	11005	12, 32, 115
UB20500OS	Atro	11083	35, 77, 116, 192
UB30000	Atro	15013	94, 125, 213, 232, 264
UCA0472	Fruehauf	14000	55
UCA3754	Fruehauf	14008	55
UCA3754	Fruehauf	14073	55
UCD005635001	Fruehauf	13037	54
UCD5635001	Fruehauf	13037	54
UM1102	Flagg	11612	148
UM1104	Flagg	11545	147, 162
UM1112	Flagg	11533	145, 278
UM1113	Flagg	11520	40, 145, 192, 222, 278

OEM	Brand	Part Id	Page
UM1113	Flagg	11523	40, 145, 192, 223, 278
UM1157	Flagg	11537	40, 146, 192
UM1157	Flagg	11613	41, 148, 193
UM1190	Flagg	11535	146
UM1191	Flagg	11539	146, 193
UM1191	Flagg	11614	148, 193
UM1191	Flagg	11761	151, 194
UM1194	Flagg	11709	149, 194
UM1196	Flagg	11705	116, 149, 194, 278
UM1204	Flagg	12000	163
UM1219	Flagg	12023	164
UM1313	Flagg	10026	114
UM1328	Flagg	10020	31, 113
UM1605	Flagg	12366	197, 279
UM1607	Flagg	12367	197
UM1608	Flagg	12356	196
UM1693	Flagg	12355	153, 196
UM207	Flagg	10075	12, 114, 258
UM324	Flagg	11085	35
UR610	Flagg	13683	43, 90, 122, 308
UR630	Flagg	13686	43, 91, 122, 262, 309
UR660	Flagg	13691	43, 91, 123, 262, 309
UR661	Flagg	12044	41, 79, 117, 153, 217, 259, 306
UR661	Flagg	13691	43, 91, 123, 262, 309
UR680	Flagg	13694	43, 92, 123, 262, 310
UR681	Flagg	13695	43, 92, 123, 184, 263, 310
UR690	Flagg	13696	43, 92, 123, 263, 310
UR691	Flagg	13697	43, 92, 123, 263, 310
UXA000004	Fruehauf	13005	54
UXA000004900	Fruehauf	13041	55
UXA000011	Fruehauf	13001	54
UXA000011900	Fruehauf	13042	55
UXA000011900	Fruehauf	13042	55
UXA000016	Fruehauf	13015	54
UXA000016	Wabash	13015	229
UXA000160	Fruehauf	13009	54
UXA000160SP1	Fruehauf	13009	54
UXA000160SPX	Fruehauf	13009	54
UXA000160SPX	Wabash	13009	229
UXA0004900	Fruehauf	13041	55
UXA0011	Fruehauf	14003	55
UXA0015001	Fruehauf	13011	54
UXA0015001	Wabash	13011	229
UXA0160	Fruehauf	13009	54
V1609657	Volvo	12333	260
V1629553	Volvo	12333	260
V8027424	Volvo	15017	264
VO20000	Atro	31096	272
VT1	Flagg	12333	260
VT19	Flagg	31095	271, 312
VT20	Flagg	18860	8, 171, 265, 312
VT21	Flagg	11714	78
VV2	Flagg	15017	213, 232, 264
W300861	Ford	11005	12
WC10050	International	14513	125
WCM10050	Freightliner	14513	44
WCM10050	Mack	14513	170
WCM10050	Sterling Truck	14513	223
WCM10050	Volvo	14513	263
WCM11223	Freightliner	14533	44
WCM11223	Sterling Truck	14533	223

Cross Reference continued

OEM	Brand	Part Id	Page
WCM11223	Volvo	14533	263
XB0009	Holland	18221	294
XB0011	Holland	18215	294
XB0011	International	18215	126
XB00111	Holland	18094	293
XB00112	Holland	11517	293
XB00123	Holland	11724	293
XB10605	Holland	40035	295
XB16045	Holland	11515	293
ZAK60879L	International	13601	121
ZAK60879L	International	13721	124

OEM	Brand	Part Id	Page
ZAK60879L	International	13722	124
ZAK62000590	International	34556	136
ZAK62001590	International	34556	136
ZAK62010455	International	12396	118
ZAK62350615	International	13733	124
ZAK62350645	International	34555	135
ZJF47691L	International	13521	119
ZJF62000590	International	34556	136
ZJF62001590	International	34556	136
ZJF62010455	International	12396	118
ZJF62350615	International	13733	124
ZJF62350645	International	34555	135

Watch for these new parts. Coming Soon

OEM	Competitor Name	PART ID
16571	Trailer	14087
09-3382		14082
0650-00	Reyco / Trailer	12408
07-05861	Peterbilt	12371
13-03096	Peterbilt	12410
13-04164	Peterbilt	11805
13-04391	Peterbilt	12409
13-04726	Peterbilt	12409
13-04727	Peterbilt	11128
18-47463-000	Freightliner	14087
18-47463-000	Sterling Trucks	14087
18-47463-000	Western Star	14087
25-755		13740
30240-2	Hendrickson	15075
321-146U		13740
325-119U		11808
329-103U		11807
329-137U		11806
329-138U		11805
329-161U		15075
35-559PU	Western Star	10504
47927C1		15075
55-102PU		15076
55-103PU		14087
814-00 H800A; H900	Hutchens	14087
ANB50	Bumpers	20423
BCD 26704-01	Sterling Trucks	11072
BCD 26704-1	Freightliner	11072
BCD 274772	Freightliner	31083
BCD 28945-1	Freightliner	11072
BCD 28945-1	Sterling Trucks	11072
BCD28805	Freightliner	31083
CB38065		13740
E-1159		15075
E-1159		15076
E-3976		15075
E-4813		14082
E-5227		14087
E-7456		14087
E-7459		11808
E-746		11806
E-7461		11806
E-7490		11807
E-8653		15075
E-8653		15076
E-8665		14087

OEM	Competitor Name	PART ID
E-9555		15075
EM75-61001		11804
EM75-69001-HT		11810
EM75-69096		12371
EM75-69096-HT		12371
EQ022		14082
EQ83-11000		15076
EQ83-35000		14082
H118		14087
HM75-64726		12409
HM75-66164		12410
K066-269	Kenworth	11807
K066-360	Kenworth	11805
K363-275	Kenworth	11806
K363-409	Kenworth	11808
K366-474	Kenworth	11808
M13-6001	Kenworth	11810
M1719		15076
M203075		12408
M203075UB		12408
MM46-62051		31083
MM46-62451		11072
MS99-65100	Bumpers	20423
N4751001 T800	Kenworth	11804
PL1044		11808
PL1062		11805
PL1064		11807
PL1066		11806
R110		15075
R110		15076
R110UB		15075
R110UB		15076
R233		15075
RM75-63861		12408
SK83-31000		15075
T-5524 21B	Reyco	15075
T-5524 21B	Reyco	15076
TK18998 21B	Reyco	14082
TK18998 21B	Reyco	15075
TP100		15076
TP100		15075
TRK5066		15075
TRK5066UB		15076
UM1114		11807
UM1114		15075

Index

Part ID	Description	Page
10000	Torque Rod Bushing	4, 112
10001	Fifth Wheel Mount	293
10002	Fifth Wheel Bushing	293
10004	Cab Mount	112
10005	Cab Mount	112
10007	Cab Mount	112
10008	Cab Mount Front	112
10009	Cab Mount Rear	112
10010	Cab Mount Front	112
10011	Radiator Mount	112
10012	Radiator Mount	113
10013	Radiator Mount	113
10014	Radiator Mount	113
10016	Radiator Mount	113
10017	Motor Mount	113
10020	Motor Mount Front (Lower)	31, 113
10021	Motor Mount Front (Upper)	113
10022	Motor Mount Front	113
10024	Hood Latch	298, 114
10025	Hood Hinge Bushing	114
10026	Hood Guide	114
10027	Hood Packing Pad	114
10028	Equalizer Bushing	114
10032	Motor Mount	114
10074	Spring Bushing	114
10075	Motor Mount Rear	12, 114, 258
10076	Tool R & I	327
10079	Fifth Wheel Bushing	31, 162, 220, 258, 293
10080	Fifth Wheel Bushing Pad	293
10503	Motor Mount Front	115
10505	Motor Mount Front	115
10506	Hood Latch Assy	31, 115, 298
10507	Hood Pin	115
10508	Radiator Tie Rod Bushing	115
10510	Hood Latch	115, 298
11000	Equalizer Bushing	31
11001	Torque Rod Bushing	32, 258
11002	Torque Rod Bushing	32
11003	Torque Rod Bushing	32
11004	Torque Rod Bushing	32, 77, 115, 142, 162, 192
11005	Spring Pin Bushing	12, 32, 115
11006	Torque Rod Bushing	32
11007	Cab Mount	32
11008	Cab Mount Front (Lower)	32, 220
11009	Cab Mount (Upper)	33, 220
11012	Cab Mount	33
11013	Motor Mount Rear	33
11014	Motor Mount Rear	33
11015	Motor Mount Front	33
11018	Motor Mount	33
11019	Hood Hinge Bushing	33, 220
11020	Hood Guide Bushing	33
11021	Radiator Mount	34, 221, 277

Part ID	Description	Page
11022	Motor Mount	12
11023	Cab Mount Front	34
11054	Motor Mount	34
11056	Hood Hinge Bushing	34
11060	Spring Pin Bushing Front	116, 142
11062	Hood Hinge Bushing	142, 192
11063	Spring Pin Bushing	34
11064	Equalizer Bushing	34
11065	Motor Mount Rear	34, 221
11066	Spring Bushing	12, 34, 77, 221, 277
11068	Tool R & I	327
11069	Tool R & I	327
11070	Fuel Tank Cap Gasket	35
11071	Tool Install	327
11073	Motor Mount	221
11074	Motor Mount Kit	35, 221
11075	Cab Mount	35
11077	Motor Mount Kit Rear	35, 221
11078	Torque Rod Assy	35, 304
11079	Tool Install	328
11080	Torque Rod Assy	116, 142, 162, 192, 277, 304
11081	Torque Rod Assy	35, 304
11083	Spring Pin Bushing	35, 77, 116, 192
11085	Motor Mount Kit Rear	35
11086	Cab Mount Kit	36, 221
11087	Motor Mount Kit Front	36
11088	Motor Mount Kit Rear	36, 221
11089	Motor Mount Kit Rear	36, 222
11090	Motor Mount Front	36, 222
11092	Cab Mount Kit	36
11094	Spring Pin Bushing	13, 36, 77, 222, 277
11095	Motor Mount Upper	36
11096	Hood Latch	37, 298
11097	Hood Latch	37, 299
11098	Hood Hinge	37
11102	Hood Latch	37, 299
11103	Hood Latch W/ Mount	37, 96, 192, 299
11104	Hood Latch W/ Mount Left	37, 299
11105	Hood Latch W/ Mount Right	37, 299
11106	Hood Latch W/ Mount Right	37, 299
11107	Hood Latch W/ Mount Left	38, 299
11109	Hood Latch Hook	38, 96, 162, 222, 278, 299
11110	Cab Mount Kit	38
11111	Cab Mount	38
11112	Motor Mount	38
11113	Motor Mount Kit	38
11115	Transmission Bushing	38
11117	Radiator Mount	38, 222
11118	Clutch Bar Bushing	39
11120	Fuel Tank Gasket	39
11123	Spring Bushing	39, 78, 222, 278

Part ID	Description	Page
11124	Hood Guide	39
11129	Radiator Mount	39, 222
11134	Hood Latch Assembly	39, 143, 300
11144	Radiator Mount	39, 239
11145	Hood Guide	39
11152	Torque Rod Assy	40, 304
11153	Torque Rod Assy	40, 304
11500	Trunnion Bushing	143, 217
11501	Trunnion Bushing	143
11502	Stabilizer Bar Bushing	143
11503	Torque Rod Bushing	143
11505	Torque Rod Bushing	143
11506	Torque Rod Bushing	143
11507	Torque Rod Bushing	143
11509	Torque Rod Bushing	78, 144
11510	Torque Rod Bushing	144
11511	Torque Rod Bushing	78, 144
11512	Torque Rod Bushing	144
11513	Torque Rod Bushing	144
11514	Torque Rod Bushing	144
11515	Fifth Wheel Bushing	144, 293
11517	Fifth Wheel Bushing	293
11518	Trunnion Bushing	144
11519	Cab Mount	145
11520	Cab Mount W/ Metal Sleeve	40, 145, 192, 222, 278
11523	Cab Mount W/ Metal Sleeve	40, 145, 192, 223, 278
11527	Cab Mount	145
11529	Cab Mount	145
11531	Cab Mount Radiator Mount	145
11532	Cab Mount	145
11533	Cab Mount	145, 278
11534	Motor Mount Rear No Metal	146
11535	Motor Mount	146
11536	Motor Mount Front	146
11537	Motor Mount	40, 146, 192
11539	Motor Mount Rear	146, 193
11540	Motor Mount Kit Rear (Lower)	146
11541	Motor Mount Rear (Upper)	146
11542	Fuel Pedal Mount	146
11543	Hood Latch	147, 193, 300
11544	Hood Hinge Bushing	40, 162
11545	Hood Guide	147, 162
11546	Hood Guide Metal Base	147
11547	Hood Guide Metal Base	147
11548	Radiator Mount No Sleeve	147
11549	Radiator Tie Rod Bushing	147
11550	Shock Absorber Bushing	147, 193
11554	Air Cooler Mount	147, 193
11556	Torque Rod Bushing	13, 40, 78, 116, 148, 182, 193, 258
11557	Hood Hinge Bushing	148
11560	Torque Rod Bushing	148

Index continued

Part ID	Description	Page
11561	Torque Rod Bushing	148
11611	Shifter Bushing Kit	40, 116, 148, 162, 193, 258
11612	Cab Mount W/ Metal Sleeve	148
11613	Motor Mount Front	41, 148, 193
11614	Motor Mount Rear	148, 193
11615	Motor Mount	149, 194
11705	Cab Mount	116, 149, 194, 278
11707	Cab Mount	41, 149, 194
11709	Hood Hinge Bushing	149, 194
11711	Pivot Bushing	41, 162, 217, 223
11714	Torque Rod Bushing	78
11715	Torque Rod Bushing	149
11716	Torque Rod Bushing	4, 13, 116
11719	Stabilizer Bar Bushing	149
11720	Trunnion Bushing	149
11724	Fifth Wheel Bushing	293
11725	Motor Mount Front	41
11726	Transmission Mount	149
11728	Fuel Tank Gasket	315
11729	Torque Rod Bushing	78, 116, 150, 194
11730	Tool Install	328
11731	Tool R & I	328
11732	Tool R & I	328
11733	Sway Bar Pin Kit	150
11734	Stabilizer Bar Bushing	150
11735	Torque Rod Bushing	4, 150
11737	Grease Seal Retainer, 2 Pack	150
11739	Torque Rod Bushing	10, 117
11740	Load Spring	10
11741	Torque Rod Bushing	150
11742	Cab Mount (Upper)	150
11743	Stabilizer Bar Bushing	150
11747	Rebound Roller Kit	58, 78, 117, 163
11751	Torque Rod Assy	4, 41, 78, 117, 151, 163, 223, 304
11753	Spring Pin Bushing	151
11754	Torque Rod	151, 305
11757	Spring Pin Bushing Kit - Shackles & Bushings	151
11758	Spring Pin Bushing	13, 58, 79, 117, 151, 163, 258
11759	Shackle Assembly	151
11760	Motor Mount Kit Rear	151
11761	Motor Mount Kit Rear	151, 194
11762	Motor Mount Kit Front	152, 194
11763	Spring Pin Bushing	152
11764	Torque Rod Bushing	152, 194
11765	Torque Rod Bushing	152, 195
11766	Sway Bar Repair Kit 54mm & 58mm	152
11767	Spring Pin Bushing	152, 195
11768	Hood Latch	152, 300

Part ID	Description	Page
11772	Carrier Bearing Bushing	315
11773	Torque Rod Assy	152, 305
11775	Spring Pin Bushing	41
11777	Torque Rod Assy	41, 305
11792	Torque Rod Assy	153, 195, 305
11793	Torque Rod Assy	153, 305
11794	Torque Rod Assy	153, 195, 305
11795	Torque Rod Assy	153, 195, 305
12000	Motor Mount	163
12001	Radiator Mount	163
12002	Motor Mount	163
12003	Motor Mount Rear	163
12004	Cab Mount	163
12005	Trunnion Bushing	164
12006	Load Pad Upper	164
12009	Load Pad Lower	164
12010	Load Pad Upper	164
12014	Load Pad Lower	164
12015	Trunnion Bushing	164, 258
12017	Motor Mount Front	164
12023	Motor Mount Rear	164
12026	Radiator Mount	165
12028	Trunnion Bushing	165
12029	Trunnion Bushing	165
12031	Torque Rod Bushing	13, 79, 117, 165
12032	Radiator Mount	165
12034	Motor Mount Kit	165
12035	Motor Mount Kit	165
12036	Load Pad Kit	165, 258
12037	Trunnion Bushing Kit	166
12038	Trunnion Bushing Kit	166
12039	Load Pad Kit	166, 259
12040	Load Pad Kit	166
12041	Spring Pin Bushing	166
12042	Torque Rod Assy Weldable	166, 305
12043	Spring Bushing	166
12044	Torque Rod Assy Weldable	41, 79, 117, 153, 217, 259, 306
12045	Motor Mount Kit Front	166
12046	Motor Mount Front	167
12047	Motor Mount Kit	167
12048	Radiator Mount	167
12049	Air Cooler Mount	167
12051	Torque Rod Bushing	167
12052	Cab Mount	167
12053	Load Pad	167
12054	Torque Rod	117, 167, 306
12057	Torque Rod	306
12069	Torque Rod Assy	168, 306
12070	Torque Rod Assy	79, 168, 306
12071	Torque Rod Assy	79, 168, 306
12072	Torque Rod Assy	168, 306
12073	Torque Rod Assy	168, 306

Part ID	Description	Page
12074	Torque Rod Assy	117, 168, 307
12081	Bolt Kit	315
12082	Bolt Kit	315
12083	Bolt Kit	315
12301	Motor Mount Rear	259, 278
12304	Motor Mount Front	7, 259
12305	Motor Mount Front (Upper)	7, 259, 278
12310	Hood Guide	259
12312	Cab Mount	259
12317	Stabilizer Bar Bushing	259
12322	Cab Mount Rear	260
12323	Motor Mount	13
12329	Sway Bar Bushing	118
12333	Bolster Spring	260
12334	End Plug Steel	260
12340	Cab Mount	260
12344	Torsion Spring Mount	42, 260
12350	Beam End Bushing	195
12351	Beam End Washer	195
12354	Beam End Bushing	195
12355	Motor Mount	153, 196
12356	Motor Mount	196
12357	Exhaust Mount	196
12359	Hood Mount	196
12360	Motor Mount	196
12361	Spring Bushing Kit	196
12362	Spring Bushing Kit	196
12363	Hood Bushing	196
12364	Hood Mount	197
12365	Hood Latch	42, 96, 153, 197, 300
12366	Radiator Bushing	197, 279
12367	Hood Hinge Bushing	197
12368	Motor Mount	197
12369	Motor Mount Rear	197
12370	Hood Hinge Bushing	197
12372	Motor Mount Rear	168
12375	Shackle	197
12379	Torque Rod	307
12380	Vibration Mount	300
12381	Exhaust Bushing Kit	198
12395	Torque Rod Assy	182, 198, 307
12396	Torque Rod Assy	42, 79, 118, 168, 260, 307
12397	Torque Rod Assy	153, 198, 307
12398	Torque Rod Assy	79, 182, 198, 307
13001	Torque Rod Bushing	54, 100, 229
13005	Equalizer Bushing	54
13007	Equalizer Bushing Narrow	54
13009	Trunnion Bushing	54, 229
13010	Spring Pad	54
13011	Equalizer Bolt	54, 229
13015	Torque Rod Bolt	54, 229
13037	Spring Pad	54, 230, 275

Index continued

Part ID	Description	Page
13041	Equalizer Bushing Kit	55
13042	Torque Rod Bushing Kit	55, 100, 230
13043	Torque Rod Bushing	315
13500	Center Bushing	13, 58, 79, 118, 217, 260
13501	Beam End Bushing	13, 58, 80, 118, 217, 230, 260
13502	Beam End Adapter	80, 118, 210
13503	Beam Bushing Kit	80
13504	Beam Bushing Kit	80, 118
13505	Center Bushing	14, 58, 80, 118, 230, 261
13506	Beam End Bushing	80, 217
13507	Beam End Adapter	80, 182, 217
13508	Beam Bushing Kit	80
13510	Suspension Bushing	81
13511	Spring Bushing	81
13512	Spring Bushing	14, 81
13513	Equalizer Bushing	169, 239
13514	Torque Rod Bushing	81, 118, 154, 198
13515	Torque Rod Bushing	81, 119, 154, 183
13516	Torque Rod Bushing	81, 119, 183
13517	Torque Rod Bushing	81, 119, 183
13518	Torque Rod Bushing	81, 119, 154, 183, 198, 261
13519	Torque Rod Bushing	82
13520	Torque Rod Bushing	5, 82, 119, 154, 169, 198, 239, 261, 279
13521	Torque Rod Bushing	42, 82, 119, 154, 169, 198
13522	Torque Rod Bushing	42, 82, 119, 154, 169, 199, 261
13524	Wear Pad	82, 210
13525	Torque Rod Bushing	42, 58, 82, 223
13526	Equalizer Bushing	14, 82, 169
13527	Rebound Roller Kit	82
13528	Torque Rod Bushing	83, 119, 154, 183, 199, 239
13531	Beam End Bushing Kit	83
13532	Torque Rod Bushing	83, 154
13533	Torque Rod Bushing	83, 120, 183, 261, 279
13534	Center Bushing	83, 120
13536	Torque Rod Bushing	5, 83, 120, 155, 169, 199, 239, 279
13537	Center Bushing	14, 83, 261
13538	Center Bushing	83
13539	Center Bushing	230
13541	Inner Bushing Sleeve	84
13542	Wear Shims	84, 120
13543	Center Bushing Loose Plug	14, 84, 210, 261

Part ID	Description	Page
13544	Center Bushing	84
13545	Beam End Bushing	84, 120
13546	Beam End Bushing	84
13547	Beam End Adapter	84, 120
13548	Beam Bushing Kit	84
13549	Beam End Adapter	85
13550	Wear Pad	85
13553	Beam End Bushing	14, 58, 85, 120, 155, 210, 217, 230, 261
13555	Bolt Kit	85, 262
13558	Center Bushing Kit	85
13560	Beam End Bushing	85
13562	Beam End Bushing Kit	85
13563	Tool Install	328
13564	Tool Install	328
13565	Suspension Bushing	85
13566	Beam End Bushing Kit	86, 262
13569	Tool Install	328
13570	Tool Install	328
13572	Tool Install	328
13574	Beam End Bushing Kit	86
13577	Equalizer Bushing	120
13581	Tool R & I	328
13582	Torque Rod Bushing	86, 121
13584	Tool R & I	328
13585	Tool R & I	328
13586	Beam End Bushing Kit	86
13587	Beam Bushing Kit	86
13588	Tool Removal	328
13590	Torque Rod Weldable	86, 307
13591	Beam End Bushing Kit	86
13592	Torque Rod Bushing	14, 58, 86, 121, 262
13594	Suspension Bushing	87
13595	Tool Install	328
13596	Beam End Bushing	87
13597	Torque Rod	87, 169, 307
13599	Pivot Bushing Kit	5
13600	Suspension Bushing	87
13601	Bolster Spring	87, 121
13604	Eccentric Washer - Bolt Kit	87
13607	Beam End Bushing Kit	59, 87, 121
13609	Beam End Adapter Kit	14, 87, 121, 183, 210
13610	Beam End Adapter Kit	88, 121
13611	Auxiliary Load Spring	7, 88
13618	Torque Rod Bushing	88
13622	Tool R & I	328
13623	Tool R & I	328
13625	Auxiliary Load Spring	88
13626	Bolster Spring Kit	42, 88, 121, 169, 199, 262
13627	Torque Rod Bushing	88
13628	Suspension Bushing	88

Part ID	Description	Page
13629	Torque Rod	88, 121, 239, 308
13634	Torque Rod Assy	89, 170, 308
13636	Center Bushing	316
13648	Wear Shim	89
13649	Overload Cushion	15, 89, 122, 170
13650	Load Pad	15, 59, 89, 122, 262
13652	Torque Rod Bushing	89
13656	Center Bushing	89, 122
13657	Torque Rod Assy	7, 223, 279, 308
13658	Center Bushing	89
13659	Torque Rod Bushing	89, 240
13662	Beam Bushing Kit	90
13665	Alignment Shim	90
13671	Suspension Bushing	90
13672	Torque Rod Bushing	90
13673	Eccentric Washer, Bolt Kit	90
13679	Torque Rod Assy	8, 42, 90, 155, 199, 308
13680	Torque Rod	308
13681	Torque Rod End	308
13682	Torque Rod End	308
13683	Torque Rod End Assy	43, 90, 122, 308
13684	Torque Rod Bushing	90, 122, 183
13685	Torque Rod Bushing	122, 170
13686	Torque Rod End Assy Tube End	43, 91, 122, 262, 309
13687	Torque Rod End Assy Tube End	91, 309
13688	Torque Rod End Assy Tube End	91, 309
13689	Torque Rod End Assy 35 Rod End	91, 309
13690	Torque Rod End Assy 35 Rod End	59, 91, 122, 309
13691	Torque Rod End Assy 27 Rod End	43, 91, 123, 262, 309
13692	Torque Rod End Assy 35 Rod End	59, 91, 123, 309
13693	Torque Rod End Assy 27 Rod End	91, 309
13694	Torque Rod End Assy 35 Rod End	43, 92, 123, 262, 310
13695	Torque Rod End Assy 27 Rod End	43, 92, 123, 184, 263, 310
13696	Torque Rod End Assy 35 Rod End	43, 92, 123, 263, 310
13697	Torque Rod End Assy 27 Rod End	43, 92, 123, 263, 310
13698	Torque Rod End Assy 36 Rod End	59, 92, 123, 310
13699	Torque Rod End Assy 27 Rod End	59, 92, 123, 310
13700	Torque Rod End Assy Tube End	92, 124, 310
13701	Torque Rod End Assy Tube End	92, 124, 310
13702	Torque Rod End Assy 35 Rod End	93, 311
13703	Torque Rod End Assy 27 Rod End	93, 124, 311
13704	Torque Rod End Assy 27 Rod End	93, 311

Index continued

Part ID	Description	Page
13707	Torque Rod End Assy 35 Rod End	311
13708	Torque Rod End Assy 36 Rod End	311
13721	Bolster Spring Pair	93, 124
13722	Bolster Spring Kit	8, 93, 124
13725	Spring Mount Kit Rear	93
13733	Torque Rod Assy	43, 93, 124, 170, 223, 263, 311
13735	Torque Rod Assy	15, 93, 124, 155, 170, 263, 311
14000	Equalizer Bushing	55, 100, 210, 230
14001	Equalizer Bushing	210, 230
14002	Equalizer Bushing	210
14003	Torque Rod Bushing	55, 100, 211, 231
14004	Torque Rod Bushing	231
14007	Torque Rod Bushing	100
14008	Torque Rod Bushing	55, 100, 199, 211, 231, 263, 275
14010	Torque Rod Bushing	15, 94, 155, 211, 231
14011	Torque Rod Bushing	100, 231
14012	Equalizer Bushing	316
14014	Torque Rod Bushing	100, 155
14015	Torque Rod Bushing	101
14016	Torque Rod Bushing	101
14017	Torque Rod Bushing	101
14022	Equalizer Bushing	101
14026	Torque Rod Bushing	101
14027	Trunnion Bushing	101, 231
14029	Torque Rod Bushing	101
14030	Torque Rod Bushing	101
14031	Torque Rod Bushing	102
14038	Equalizer Bushing	102
14071	Torque Rod Bushing	102
14072	Equalizer Bushing	102
14073	Torque Rod Bushing	55, 102, 211, 231, 275
14500	Trunnion Bushing	184
14501	Trunnion Bushing	184
14502	Trunnion Bushing	184
14503	Trunnion Bushing	102
14504	Beam End Bushing	124, 184, 211, 240
14505	Axle Pad	184
14509	Axle Pad	184, 211
14510	Beam End Bushing	184, 231
14513	Beam End Bushing	44, 55, 125, 170, 185, 223, 232, 263, 275
14514	Beam End Bushing	185
14521	Trunnion Bushing	185, 211, 232, 275
14522	Axle Pad	185, 211, 232, 275
14523	Trunnion Bushing Lower Half	185
14524	Trunnion Bushing Lower Half	185

Part ID	Description	Page
14526	Center Bushing	185
14527	Center Bushing	125, 185
14529	Center Bushing	55, 186
14530	Beam End Bushing	186
14531	Tool Install	328
14532	Beam End Bushing	186, 212
14533	Beam End Bushing	44, 125, 170, 186, 223, 232, 263, 275
15000	Equalizer Bushing	212
15001	Equalizer Bushing	125, 212
15004	Equalizer Bushing	155, 212
15005	Equalizer Bushing	212
15006	Equalizer Bushing	155, 212
15008	Torque Rod Bushing	125, 212, 232
15009	Torque Rod Bushing	170, 212
15011	Torque Rod Bushing	213
15013	Torque Rod Bushing	94, 125, 213, 232, 264
15016	Equalizer Bushing	213, 232
15017	Equalizer Bushing	213, 232, 264
15018	Equalizer Bushing	264
15019	Torque Rod Bushing	213
15020	Torque Rod Bushing	213
15051	Torque Rod Bushing	213, 233
15054	Equalizer Bushing	213, 233
15059	Equalizer Bolt	214
15060	Suspension Bushing Kit	125, 214
15061	Torque Rod Bushing Kit	125, 214, 233
15062	Torque Rod Bushing Kit	214, 233
15063	Torque Rod Bushing Kit	94, 214, 233
15064	Torque Rod Bushing Kit	44, 171, 214, 224, 233
15073	Torque Rod Bushing	214
16000	Stabilizer Bar Bushing	59
16002	Spring Bushing	59
16003	Spring Bushing	60
16004	Spring Pad	60
16005	Spring Pad	60
16006	Lower Shock	60
16007	Overload Cushion	60
16009	Motor Mount	264
16032	Spring Bushing	60
16034	Spring Bushing	60
16035	Motor Mount	60
16501	Spring Bushing	316
16503	Shock Absorber Bushing	316
16505	Shock Absorber Bushing	316
16506	Motor Mount	316
16507	Motor Mount	316
16509	Motor Mount	316
16510	Motor Mount	317
17250	Stabilizer Bar Bushing	15
17251	Stabilizer Bar Bushing	15
17257	Motor Mount	126

Part ID	Description	Page
17272	Stabilizer Bar Bushing	126
17273	Stabilizer Bar Bushing	126
17275	Spring Bushing	15
17276	Spring Bushing	15
17279	Stabilizer Bar Bushing	16
17283	Exhaust Bushing	156, 199
17284	Exhaust Bushing	156, 199
17285	Motor Mount	16, 240
17500	Camshaft Bushing	233, 264, 281
17501	Camshaft Bushing	5, 16, 56, 61, 126, 171, 264, 281
17502	Camshaft Bushing	56, 233, 282
17503	Camshaft Bushing	282
17504	Camshaft Bushing	5, 282
17505	Camshaft Bushing	56, 234, 282
17506	Coupling	126, 282
17507	Coupling	282
17508	Coupling	282
17509	Coupling	282
17510	Coupling	283
17511	Coupling	283
17516	Pump Valve Cover	317
17518	Coupling	283
17519	Coupling	283
17520	Coupling	283
17529	Camshaft Bushing	5, 61, 283
17530	Coupling	283
17531	Coupling	283
17534	Glad Hand Seal Kit	284
17538	Camshaft Bushing	5, 234, 284
17539	Camshaft Bushing	284
17541	Coupling	284
17574	Camshaft Bushing	5, 56, 234
17668	Camshaft Bushing	56, 234, 284
17674	Glad Hand Seals Blue	284
17675	Glad Hand Seal Red	284
17676	Glad Hand Seal Black	285
17677	Coupling	285
17678	Camshaft Bushing	285
17682	Camshaft Bushing	285
18000	Carrier Bearing Bushing	317
18002	Carrier Bearing Bushing	317
18004	Shock Absorber Bushing	317
18005	Flag Straight Rod 5/8	317
18006	Flag Angled Rod 5/8, Right	317
18008	Flag No Rod	317
18009	Trailer & Dock Bumper	286
18010	Shock Absorber Bushing	6, 240, 264
18011	Shock Absorber Bushing	318
18013	Vibration Mount	300
18014	Vibration Mount	301
18015	Vibration Mount	44, 224, 279, 301
18030	Radiator Mount	318
18034	Shock Absorber Bushing	318

Index continued

Part ID	Description	Page
18043	Oil Cap Bushing	318
18044	Oil Cap Bushing	318
18045	Fuel Tank Plug	318
18046	Fuel Tank Plug	318
18047	Radiator Mount	318
18048	Shock Absorber Bushing	319
18049	Load Bushing	319
18051	Tool Install	328
18053	Seat Bushing	319
18054	Battery Dust Cover Black	319
18055	Radiator Mount Red	319
18058	Flag Straight Rod 5/8 Aluminum	319
18060	Flag Thinner Rod 9/16	319
18063	Radiator Mount	126
18065	Shock Absorber Bushing	319
18067	Motor Mount	264
18069	Valve Seal	320
18070	Motor Mount	265
18072	Flag Angled Rod 5/8, Left	320
18076	Trailer & Dock Bumper Black	286
18079	Cab Mount	320
18080	Torque Rod Bushing	240
18081	Cab Mount	320
18084	Torque Rod Bushing	240
18086	Bushing Magnetic Break Isolator	320
18094	Fifth Wheel Bushing	293
18096	Bushing	320
18100	Shock Absorber Bushing	320
18102	Motor Mount	200, 279
18103	Cab Mount	126
18113	Cab Mount	320
18118	Beam End Bushing	321
18125	Transmission Mount	61
18215	Fifth Wheel Bushing	44, 126, 171, 224, 234, 265, 294
18221	Fifth Wheel Bushing	44, 127, 171, 265, 294
18222	Cab Mount	61, 265
18229	Spring Spacer	321
18230	Spring Spacer	321
18232	Motor Mount	61, 265
18233	Torque Rod Bushing	321
18240	Shock Absorber Sleeve	321
18244	Shock Absorber Bushing	156, 200, 234
18256	Suspension Bushing	234
18259	Torque Rod Bushing	321
18290	Oil Plug	321
18310	Fuel Tank Cap Gasket	321
18316	Shock Absorber Bumper	286
18317	Spring Bushing	322
18318	Spring Bushing	322
18320	Fuel Tank Cap Gasket	322
18333	Hinge Bushing Kit	294
18351	Fifth Wheel Mount	294

Part ID	Description	Page
18352	Stabilizer Bar Bushing	322
18433	Motor Mount	16, 44, 224
18435	Torque Rod Bushing	240
18437	Load Cushion	240
18439	Camshaft Bushing	6, 61, 285
18455	Wheel Chock	322
18483	Shock Absorber Bushing	241
18484	Load Cushion	241
18526	Bushing	322
18529	Trailer & Dock Bumper	286
18533	Shock Absorber Bushing	241
18538	Torque Rod Mount	94
18539	Tool Install	328
18540	Tool Removal	328
18541	Tool Install	329
18542	Tool For R & I	329
18543	Tool Install	329
18544	Tool Removal	329
18550	Trailer & Dock Bumper	286
18551	Tool For R & I	329
18552	Tool For R & I	329
18553	Tool Install	329
18558	Hinge Bushing Kit	234, 294
18559	Trailer & Dock Bumper	286
18560	Trailer & Dock Bumper	287
18566	Shock Absorber Bushing	44, 56, 127, 156, 171, 186, 200, 279
18568	Torque Rod Bushing	322
18572	Shock Absorber Bushing	241
18574	Hinge Bushing	294
18575	Hinge Bushing	294
18581	Curtain Roller	322
18598	Shackle	323
18599	Shackle	265
18600	Shackle	45
18601	Shackle	156
18602	Shackle	156
18686	Hinge Bushing Kit	294
18688	Fuel Tank Cap Gasket	323
18689	Torque Rod Bushing	235
18690	Torque Rod Bushing	235
18691	Torque Rod Bushing	235
18692	Torque Rod Bushing	235
18693	Torque Rod Bushing	61
18694	Motor Mount	16
18695	Suspension Mount	323
18696	Shock Absorber Bushing	235
18697	Shock Absorber Bushing	235
18698	Suspension Mount	61
18699	Suspension Mount	323
18700	Equalizer Bushing	235
18701	Equalizer Bushing	235
18702	Suspension Bushing	323

Part ID	Description	Page
18705	Suspension Bushing	323
18708	Fifth Wheel Mount	295
18709	Fifth Wheel Mount	295
18710	Pivot Bushing Inner	236
18711	Pivot Bushing Outer	236
18725	Carrier Bearing Bushing	323
18730	Spring Spacer	323
18733	Pivot Bushing	324
18745	Thrust Washer	324
18746	Torque Rod Bushing	324
18747	Torque Rod Bushing	324
18748	Thrust Washer	324
18750	Pivot Bushing	324
18753	Spring Bushing	324
18757	Bushing	324
18758	Exhaust Bushing	325
18760	Cab Mount	62
18761	Torque Rod	311
18762	Bushing	325
18778	Shifter Bushing Kit	325
18786	Motor Mount	200
18814	Stabilizer Bar Bushing	241
18820	Stabilizer Bar Bushing	241
18821	Pivot Bushing	94
18822	Slide Roller Bus Door	325
18830	Torque Rod Bushing	94, 96
18831	Tool Mount	329
18833	Tool Mount	329
18834	Tool Mount	329
18835	Tool Mount	329
18836	Tool Mount	329
18837	Radiator Mount	45, 171
18847	Motor Mount	62
18848	Trailer & Dock Bumper	287
18851	Hinge Bushing	295
18859	Torque Rod	265, 312
18860	Torque Rod Assy	8, 171, 265, 312
18865	Torque Rod Bushing	241
18866	Torque Rod Bushing	241
18905	Trailer & Dock Bumper	287
18919	Torque Rod Bushing	10
18920	Torque Rod Bushing	10
18921	Torque Rod Bushing	10
18930	Torque Rod Bushing	242
18936	Tool Install	329
18937	Tool Install	329
18938	Cab Mount (Lower)	156
18943	Motor Mount Front	242
18944	Motor Mount	242
18949	Cab Mount	156
18956	Beam End Bushing	214
18961	Torque Rod Bushing	325
18984	Torque Rod Bushing	325
18991	Camshaft Bushing	6, 285

Index continued

Part ID	Description	Page
18992	Camshaft Bushing	285
18994	Spring Mount Rear	16, 45, 94, 224, 280
19001	Spring Bushing Kit	16, 62, 127, 242
19002	Load Spring	218
19003	Load Spring	200, 218
19004	Center Bushing	157, 218
19005	Beam End Bushing	218
19008	Beam End Bushing	218
30500	Motor Mount	127
30503	Motor Mount Rear	127
30504	Exhaust Mount	45
30505	Torque Rod Bushing	127
30506	Torque Rod Bushing	127
30507	Shock Absorber Bushing	16, 56, 127, 200, 242
30508	Load Pad	128
30509	Motor Mount Rear Upper	128
30510	Motor Mount Rear Upper	128
30511	Compressor Mount	128
30513	Radiator Mount	128
30515	Suspension Mount	128
30516	Motor Mount Rear	128, 242
30517	Motor Mount Front Lower	128
30518	Motor Mount Front Upper	129
30520	Radiator Mount	129
30522	Shock Absorber Bushing	129
30539	Shock Absorber Bushing	129
30544	Spring Pad	129
30545	Shock Absorber Bushing	280
30557	Shock Absorber Bushing	129
31000	Torque Rod Bushing	266
31001	Stabilizer Bar Bushing	266
31002	Shock Absorber Bushing	266
31004	Shock Absorber Bushing	266
31005	Radiator Mount	242, 266
31006	Radiator Mount	266
31007	Radiator Mount	266
31008	Exhaust Mount	266
31012	Hood Mount	267
31014	Alternator Bushing	267
31016	Torque Rod Bushing	267
31017	Shock Absorber Bushing	267
31018	Torque Rod Bushing	267
31019	Cab Mount	267
31021	Motor Mount Rear Upper	267
31026	Fan Hood Mount	267
31031	Compressor Mount	268
31037	Stabilizer Bar Bushing	268
31040	Motor Mount	268
31049	Wear Pad Step	268
31051	Stabilizer Bar Bushing	268
31052	Spring Bushing	268
31053	Stabilizer Bar Bushing	268

Part ID	Description	Page
31054	Shock Absorber Bushing	268
31055	Shock Absorber Bushing	269
31056	Stabilizer Bar Bushing	269
31057	Stabilizer Bar Bushing	269
31059	Mount Monitor	269
31060	Load Pad	269
31062	Shock Absorber Bushing	269
31063	Shock Absorber Bushing	269
31064	Shock Absorber Bushing	269
31065	Shock Absorber Bushing	270
31068	Torque Rod Bushing	270
31069	Torque Rod Bushing	270
31070	Stabilizer Bar Bushing	270
31071	End Plug Steel	270
31072	Stabilizer Bar Bushing	270
31074	Spring Bushing	270
31080	Spring Bushing	270
31082	V-Stay Repair Kit	271
31086	Motor Mount	271
31087	Torque Rod Bushing	242, 271
31088	Torque Rod Bushing	271
31089	V-Stay Bushing Center Threaded	271
31090	V-Stay Bushing	271
31091	Tool R & I	329
31093	Torque Rod Bushing	271
31095	Torque Rod Assy Angled	271, 312
31096	Torque Rod Bushing	272
31097	Torque Rod Angled	272, 312
31098	V-Stay Bushing	272
31502	Shock Absorber Bushing	243
31505	Stabilizer Bar Bushing	272
31507	Stabilizer Bar Bushing	243
31508	Torque Rod Bushing	243
31509	Spring Bushing	243
31512	Stabilizer Bar Bushing	243
31514	Stabilizer Bar Bushing	272
31515	Coupling	285
31520	Shifter Washer	325
31521	Motor Mount Front	243
31524	Exhaust Mount	129
31528	Torque Rod Bushing	243
31529	Motor Mount Rear	243
31537	Stabilizer Bar Bushing	244
31539	Fan Hood Mount	129
31545	Motor Mount Rear	244
31546	Stabilizer Bar Bushing	130
31547	Stabilizer Bar Bushing	130
31548	Stabilizer Bar Bushing	130
31550	Radiator Mount	244
31551	Bushing Kit	130
31552	Radiator Mount	130
31553	Stabilizer Bar Bushing	130
31554	Spring Bushing	130
31556	Bearing Washer	130

Part ID	Description	Page
31560	Alternator Bushing	131
31561	Shifter Linkage Bushing	131
31562	Cab Mount	244
31564	Stabilizer Bar Bushing	131
31565	Stabilizer Bar Bushing	131
31566	Stabilizer Bar Bushing	244
31567	Stabilizer Bar Bushing	131
31570	Stabilizer Bar Bushing	131
31571	Shifter Linkage Bushing	244
31578	Shock Absorber Bushing	244
31579	Torque Rod Bushing	244, 272
31580	Stabilizer Bar Bushing	245
31581	Shock Absorber Bushing	131
31582	Spring Bushing	245
31583	Stabilizer Bar Bushing	131
31588	Wear Shim	245
31592	Beam End Bushing	171, 186
31594	Stabilizer Bar Bushing	132
31595	Compressor Mount	245
31596	Spring Bushing	245
31598	Wear Pad	132
31600	Motor Mount	245
31601	Torque Rod Bushing	245
31602	Torque Rod Bushing	245
31604	Radiator Mount	132
31609	Stabilizer Bar Bushing	132
31624	Deflector Pad	45
32000	Stabilizer Bar Bushing	246
32001	Spring Bushing	246
32002	Spring Bushing	246
32003	Overload Pad	246
32005	Stabilizer Bar Bushing	246
32006	Stabilizer Bar Bushing	246
32007	Torque Rod Bushing	246, 272
32008	Torque Rod Bushing	272
32009	V-Stay Repair Kit	273
32010	Motor Mount Front	246
32013	Exhaust Mount	247
32014	Shock Absorber Bushing	247
32016	Shock Absorber Bushing	247
32020	Torque Rod Bushing	247
32025	Shifter Linkage Bushing	247
32027	Shifter Linkage Bushing	247
32028	Stabilizer Bar Bushing	247
32031	Torque Rod Bushing	247, 273
32032	Torque Rod Bushing	248
32033	Stabilizer Bar Bushing	248
32035	Torque Rod Bushing	248
32037	Stabilizer Bar Bushing	248, 273
32038	Motor Mount Transmission	248
32039	Motor Mount Front	248
32040	Carrier Bearing Bushing	248
32041	Bushing Shaft	248
32042	Motor Mount Rear	249

Part ID	Description	Page
32044	Spring Bushing	273
32046	Stabilizer Bar Bushing	249
32047	Stabilizer Bar Bushing	249
32048	Torque Rod Bushing	249
32049	Torque Rod Bushing	249
32050	Stabilizer Bar Bushing	249
32053	Stabilizer Bar Bushing	249, 273
32502	Spring Bushing	249
32503	Motor Mount	325
33500	Torque Rod Bushing	250
33501	Stabilizer Bar Bushing	250
33502	Torque Rod Bushing	62, 250
33503	Torque Rod Bushing	62, 250
33506	Torque Rod Bushing	250
34500	Motor Mount Kit	132
34505	Motor Mount Front	132
34506	Motor Mount Front	132
34507	Motor Mount Upper	132
34509	Motor Mount Front	17, 133
34510	Motor Mount Kit Rear	133
34511	Spring Bushing	133
34512	Torque Rod Bushing	133
34514	Torque Rod Bushing Green	6, 94, 275
34515	Cab Mount	133
34516	Cab Mount	133
34519	Spring Bushing Kit	133
34521	Auxiliary Load Spring	133
34523	Spring Bushing	134
34524	Motor Mount Kit Rear	134
34525	Motor Mount Kit Rear	45, 134
34526	Motor Mount Kit Front	17, 134
34527	Torque Rod	134, 312
34528	Cab Mount Kit	134

Part ID	Description	Page
34529	Motor Mount Kit Rear	17, 134
34530	Hood Swivel Bushing	134
34532	Cab Mount Bushing	135
34534	Torque Rod Bushing	135
34536	Hood Guide	135
34537	Spring Bushing Kit	135
34540	Cab Mount Bushing Kit	135
34545	Radiator Mount	135, 250
34552	Cab Mount Bushing	135
34554	Torque Rod Assy	200, 312
34555	Torque Rod Assy	45, 95, 135, 172, 224, 273, 312
34556	Torque Rod Assy	45, 95, 136, 172, 224, 273, 312
34563	Torque Rod Assy	136, 313
35001	Stabilizer Bar Bushing	250
35002	Torque Rod Bushing	250
35003	Motor Mount Rear	251
35004	Motor Mount Rear	251
35005	Load Pad	251
35006	Stabilizer Bar Bushing	251
35007	Torque Rod Bushing	251
35008	Torque Rod Bushing	251
35009	Stabilizer Bar Bushing	251
40030	Tool Install	329
40035	Fifth Wheel Bushing	46, 136, 172, 224, 273, 295
40056	Fifth Wheel Bushing	295
40074	Carrier Bearing	6, 8, 17, 46, 62, 136, 157, 172, 200, 274

Part ID	Description	Page
40075	Carrier Bearing	6, 17, 46, 62, 96, 136, 157, 172, 201, 225, 274
40089	Torque Rod Bushing	236
40090	Tool Install	329
40093	Tool Install	329
40095	Wheel Chock Flaps	326
40132	Tool R & I	329
40140	Fifth Wheel Bushing Kit	295
40141	Fifth Wheel Bushing Kit	295
50021	Trailer & Dock Bumper Solid	326
50022	Trailer & Dock Bumper Shelled	326
50031	Torque Rod Bushing	6
50032	Control Arm Bushing Kit	6
50033	Torque Rod Bushing	7, 46, 172, 225, 236, 274
50034	Tool R & I	329
50046	Suspension Bushing	186, 236
50047	Suspension Bushing Kit	186, 236
50053	Vibration Mount	301
50054	Vibration Mount	301
50055	Snubber Mount	301
50056	Vibration Mount	301
50064	Trailer & Dock Bumper	287
83520	Easy-Mount Torque Rod Bushing	7, 95, 136, 157, 172, 201, 218, 251, 280
83522	Easy-Mount Torque Rod Bushing	46, 95, 136, 157, 172, 201, 274
83596	Easy-Mount Beam End Bushing	8, 62, 95, 136

New Product Request

OEM Part Number	
Description	
How many would be used per year?	Image / Sketch
Vehicle – Make / Model / Application	
Serial Number	

STEMCO

SUSPENSION PRODUCTS™

STEMCO is the manufacturer of high quality suspension products for the commercial vehicle industry.

STEMCO GAFF® offers an extensive coverage of high performance polyurethane replacement parts for the Commercial Truck's rubber undercarriage system.

Product Features

The exclusive and unique formulations GAFF® uses; highly increases the lifetime of the damping and vibration absorption systems of the vehicle.

What Makes Our Products Different?

The Commercial Vehicle market has for many years been using rubber. However, our highly engineered polyurethane offers greater benefits compared to rubber, GAFF® Polyurethane has increased durability and performance for freight, passenger and industry suspension systems in general.

- GAFF® Polyurethane is resistant to chemicals, petroleum products, such as oil, grease, ultraviolet rays, and ozone.
- The products are more durable and resistant compared to rubber based products.
- GAFF® Polyurethane has an exceptional chemical stability, high elasticity and resilience.

Benefits

- Increases the lifespan of the suspension system.
- Reduces maintenance costs.
- Increases profitability of the vehicle, by reducing the amount of downtime.

GUIDE TO THIS CATALOG

This catalog was designed to simplify the identification process and selection of STEMCO GAFF® Polyurethane Mounts and Suspension Parts.

- Cross reference table for compatible parts by BRAND part number with reference to the page with the corresponding "Clip".
- "Clip" of each product lists the compatible OEM reference for that section and related Brand numbers for reference.
- Summaries reference a variety of original equipment manufacturers "OEM" compatible parts. The OEM numbers referenced in orange are applicable to that corresponding application; crosses referenced in blue are also comparable.
- Several Kit options may sometimes not be offered in kit by OEM, but individual parts appear as crosses to our Kit for best value and convenience.



STEMCO®

A Higher Standard of Performance.™

an EnPro Industries company

Making the Roadways Safer®

STEMCO
KAISER™

QWIKKIT™



PLUSKIT™

King Pin Kits, Spring Pins
and Bushings

STEMCO
EQUIPMENT™

Aligner



Balancer

AXLE · PRO · EQUIPMENT
APE

STEMCO
GAFF™



Torque
Rods



Carrier Bearing
Assembly



Suspension
Bushing Kits



Load Pads
& Kits



Mounts



Bushings



Miscellaneous



Hood Latches

BFGoodrich	Tire Size	Mile	Kilometer	Mile (No Trip Feature)	Kilometer (No Trip Feature)
DR434	11R22.5	600-1467	600-0290	600-5467	600-4290
DR444	11R22.5	600-1503	600-0313	600-5503	600-4313
TR134	11R24.5	600-1489	600-0304	600-5489	600-4304
Bridgestone	Tire Size	Mile	Kilometer	Mile (No Trip Feature)	Kilometer (No Trip Feature)
L312	445/65R22.5	600-1460	600-0286	600-5460	600-4286
L317	10.00R20	600-1497	600-0309	600-5497	600-4309
L317	11.00R20	600-1483	600-0300	600-5483	600-4300
L317	11.00R22	600-1461	600-0286	600-5461	600-4286
L317	11R22.5	600-1496	600-0308	600-5496	600-4308
L317	11R24.5	600-1473	600-0294	600-5473	600-294
L317	1200R24NHS	600-1425	600-0264	600-5425	600-4264
L317	12R22.5	600-1482	600-0299	600-5482	600-4299
L355	12.00R24	600-1435	600-0270	600-5435	600-4270
M711	11R22.5	600-1502	600-0312	600-5502	600-4312
M711	11R24.5	600-1479	600-0297	600-5479	600-4297
M711	12R22.5	600-1485	600-0302	600-5485	600-4302
M711	255/70R22.5	600-1568	600-0353	600-5568	600-4353
M711	285/75R24.5	600-1502	600-0312	600-5502	600-4312
M711	295/75R22.5	600-1518	600-0322	600-5518	600-4322
M711WB	385/65R22.5	600-1492	600-0306	600-5492	600-4306
M711WB	425/65R22.5	600-1471	600-0293	600-5471	600-4293
M716	215/75R17.5	600-1692	600-0430	600-5692	600-4430
M716	265/70R19.5	600-1613	600-0381	600-5613	600-4381
M716	265/75R22.5	600-1545	600-0339	600-5545	600-4339
M716	285/70R19.5	600-1595	600-0370	600-5595	600-4370
M720	285/75R24.5	600-1502	600-0312	600-5502	600-4312
M720	295/75R22.5	600-1518	600-0322	600-5518	600-4322
M724F	8.25-20	600-1499	600-0310	600-5499	600-4310
M724F	225/70R19.5	600-1647	600-0402	600-5647	600-4402
M724F	245/70R19.5	600-1629	600-0391	600-5629	600-4391
M724F	8R19.5	600-1622	600-0386	600-5622	600-4386
M725	11R22.5	600-1499	600-0310	600-5499	600-4310
M725	11R24.5	600-1476	600-0296	600-5476	600-4296
M725	285/75R24.5	600-1499	600-0310	600-5499	600-4310
M725	295/75R22.5	600-1514	600-0320	600-5514	600-4320
M726	11R22.5	600-1499	600-0310	600-1499	600-0310
M726	11R24.5	600-1476	600-0296	600-1476	600-0296
M726	255/70R22.5	600-1564	600-0351	600-1564	600-0351
M726	265/75R22.5	600-1548	600-0341	600-1548	600-0341
M726	285/75R24.5	600-1499	600-0310	600-1499	600-0310
M726	295/75R22.5	600-1514	600-0320	600-1514	600-0320
M726F	9R22.5	600-1542	600-0337	600-5542	600-4337
M726F	10R22.5	600-1519	600-0323	600-5519	600-4323
M774	11R22.5	600-1490	600-0304	600-5490	600-4304
M774	11R24.5	600-1468	600-0291	600-5468	600-4291
M774	12R22.5	600-1480	600-0298	600-5480	600-4298
M840	10.00R20	600-1497	600-0309	600-5497	600-4309
M840	11.00R20	600-1481	600-0299	600-5481	600-4299
M840	11.00R22	600-1465	600-0289	600-5465	600-4289
M840	11R22.5	600-1498	600-0310	600-5498	600-4310
M840	12.00R20	600-1467	600-0290	600-5467	600-4290
M840	12.00R24	600-1436	600-0271	600-5436	600-4271
M843	11R22.5	600-1495	600-0307	600-5495	600-4307
M843	11R24.5	600-1473	600-0294	600-5473	600-4294

Bridgestone... (cont'd)	Tire Size	Mile	Kilometer	Mile (No Trip Feature)	Kilometer (No Trip Feature)
M843	12R22.5	600-1484	600-0301	600-5484	600-4301
M843	12R24.5	600-1463	600-0287	600-5463	600-4287
M843	315/80R22.5	600-1485	600-0302	600-5485	600-4302
M844F	385/65R22.5	600-1491	600-0305	600-5491	600-4305
M844F	425/65R22.5	600-1469	600-0291	600-5469	600-4291
M844F	445/65R22.5	600-1458	600-0284	600-5458	600-4284
M857	11.00R24	600-1450	600-0279	600-5450	600-4279
M857	11R24.5	600-1482	600-0299	600-5482	600-4299
M857	12.00R24	600-1444	600-0276	600-5444	600-4276
M857	12R22.5	600-1491	600-0305	600-5491	600-4305
M857	445/65R19.5	600-1493	600-0307	600-5493	600-4307
R180	10R17.5	600-1626	600-0389	600-5626	600-4389
R180	9R17.5	600-1637	600-0396	600-5637	600-4396
R184	215/75R17.5	600-1690	600-0429	600-5690	600-4429
R184	235/75R17.5	600-1668	600-0415	600-5668	600-4415
R187	10.00R15	600-1585	600-0364	600-5585	600-4364
R187	8.25R15	600-1637	600-0396	600-5637	600-4396
R187	8R19.5	600-1628	600-0390	600-5628	600-4390
R187F	225/70R19.5	600-1651	600-0405	600-5651	600-4405
R187F	245/70R19.5	600-1633	600-0394	600-5633	600-4394
R192	12R22.5	600-1488	600-0303	600-5488	600-4303
R192	305/70R22.5	600-1529	600-0328	600-5529	600-4328
R194	11R22.5	600-1513	600-0319	600-5513	600-4319
R194	11R24.5	600-1489	600-0304	600-5489	600-4304
R194	275/70R22.5	600-1529	600-0328	600-5529	600-4328
R194	285/75R24.5	600-1513	600-0319	600-5513	600-4319
R194	295/75R22.5	600-1529	600-0328	600-5529	600-4328
R194F	255/70R22.5	600-1580	600-0361	600-5580	600-4361
R194F	295/75R22.5	600-1529	600-0328	600-5529	600-4328
R194FE	295/75R22.5	600-1529	600-0328	600-5529	600-4328
R194WB	385/65R22.5	600-1492	600-0306	600-5492	600-4306
R194WB	425/65R22.5	600-1470	600-0292	600-5470	600-4292
R196	11R22.5	600-1509	600-0316	600-5509	600-4316
R196	11R24.5	600-1485	600-0302	600-5485	600-4302
R196	285/75R24.5	600-1507	600-0315	600-5507	600-4315
R196	295/75R22.5	600-1526	600-0327	600-5526	600-4327
R226	11R22.5	600-1509	600-0316	600-5509	600-4316
R226	11R24.5	600-1482	600-0299	600-5482	600-4299
R226	285/75R24.5	600-1505	600-0314	600-5505	600-4314
R226	295/75R22.5	600-1522	600-0324	600-5522	600-4324
R227	11R22.5	600-1509	600-0316	600-5509	600-4316
R227	11R24.5	600-1485	600-0302	600-5485	600-4302
R227	275/80R22.5	600-1525	600-0326	600-5525	600-4326
R227	285/75R24.5	600-1509	600-0316	600-5509	600-4316
R227	295/75R22.5	600-1525	600-0326	600-5525	600-4326
R250	9.00R20	600-1526	600-0327	600-5526	600-4327
R250	10.00R20	600-1507	600-0315	600-5507	600-4315
R250	11.00R20	600-1495	600-0307	600-5495	600-4307
R250	11.00R22	600-1471	600-0293	600-5471	600-4293
R250	12.00R20	600-1470	600-0292	600-5470	600-4292
R250	265/70R19.5	600-1615	600-0382	600-5615	600-4382
R250F	9R22.5	600-1550	600-0341	600-5550	600-4341
R250F	10R22.5	600-1526	600-0327	600-5526	600-4327
R250F	11R22.5	600-1509	600-0316	600-5509	600-4316
R250F	11R24.5	600-1485	600-0302	600-5485	600-4302

Bridgestone... (cont'd)	Tire Size	Mile	Kilometer	Mile (No Trip Feature)	Kilometer (No Trip Feature)
R250F	12R22.5	600-1492	600-0306	600-5492	600-4306
R250F	245/70R19.5	600-1631	600-0392	600-5631	600-4392
R250F	245/75R22.5	600-1563	600-0350	600-5563	600-4350
R250F	265/75R22.5	600-1548	600-0341	600-5548	600-4341
R250F	285/75R24.5	600-1508	600-0316	600-5508	600-4316
R250F	295/75R22.5	600-1523	600-0325	600-5523	600-4325
R250F	295/80R22.5	600-1505	600-0314	600-5505	600-4314
R270SD	285/75R24.5	600-1505	600-0314	600-5505	600-4314
R270SD	295/75R22.5	600-1522	600-0324	600-5522	600-4324
R293	11R22.5	600-1509	600-0316	600-5509	600-4316
R293	11R24.5	600-1485	600-0302	600-5485	600-4302
R294	215/75R17.5	600-1692	600-0430	600-5692	600-4430
R294	255/70R22.5	600-1574	600-0357	600-5574	600-4357
R294	265/70R19.5	600-1616	600-0383	600-5616	600-4383
R294	275/70R22.5	600-1554	600-0344	600-5554	600-4344
R294	305/75R24.5	600-1493	600-0307	600-5493	600-4307
R294	315/80R22.5	600-1495	600-0307	600-5495	600-4307
R296	11R22.5	600-1503	600-0313	600-5503	600-4313
R296	11R24.5	600-1481	600-0299	600-5481	600-4299
R296	315/80R22.5	600-1491	600-0305	600-5491	600-4305
R299	285/75R24.5	600-1508	600-0316	600-5508	600-4316
R299	295/75R22.5	600-1523	600-0325	600-5523	600-4325
Continental	Tire Size	Mile	Kilometer	Mile (No Trip Feature)	Kilometer (No Trip Feature)
HT63	215/75R17.5	600-1690	600-0429	600-5690	600-4429
HSR	275/80R22.5	600-1526	600-0327	600-5526	600-4327
Dayton	Tire Size	Mile	Kilometer	Mile (No Trip Feature)	Kilometer (No Trip Feature)
Radial Drive Deep Skid	11R22.5	600-1502	600-0312	600-5502	600-4312
Radial Drive Deep Skid	11R24.5	600-1479	600-0297	600-5479	600-4297
Radial Drive Deep Skid	285/75R24.5	600-1502	600-0312	600-5502	600-4312
Radial Drive Deep Skid	295/75R22.5	600-1518	600-0322	600-5518	600-4322
Radial Highway Service	11R22.5	600-1513	600-0319	600-5513	600-4319
Radial Highway Service	11R24.5	600-1489	600-0304	600-5489	600-4304
Radial Highway Service	285/75R24.5	600-1513	600-0319	600-5513	600-4319
Radial Highway Service	295/75R22.5	600-1529	600-0328	600-5529	600-4328
Radial Rib All Position	10.00R20	600-1509	600-0316	600-5509	600-4316
Radial Rib All Position	11R22.5	600-1509	600-0316	600-5509	600-4316
Radial Rib All Position	11R24.5	600-1485	600-0302	600-5485	600-4302
Radial Rib All Position	285/75R24.5	600-1508	600-0316	600-5508	600-4316
Radial Rib All Position	295/75R22.5	600-1523	600-0325	600-5523	600-4325
Dunlop	Tire Size	Mile	Kilometer	Mile (No Trip Feature)	Kilometer (No Trip Feature)
SP131	285/75R24.5	600-1512	600-0318	600-5512	600-4318
SP181	11R22.5	600-1512	600-0318	600-5512	600-4318
SP831	11R24.5	600-1483	600-0300	600-5483	600-4300
Firestone	Tire Size	Mile	Kilometer	Mile (No Trip Feature)	Kilometer (No Trip Feature)
FD663	10R22.5	600-1519	600-0323	600-5519	600-4323
FD663	11R22.5	600-1502	600-0312	600-5502	600-4312
FD663	11R24.5	600-1479	600-0297	600-5479	600-4297
FD663	12R22.5	600-1489	600-0304	600-5489	600-4304
FD663	285/75R24.5	600-1502	600-0312	600-5502	600-4312
FD663	295/75R22.5	600-1518	600-0322	600-5518	600-4322
FS400	315/80R22.5	600-1496	600-0308	600-5496	600-4308

Firestone... (cont'd)	Tire Size	Mile	Kilometer	Mile (No Trip Feature)	Kilometer (No Trip Feature)
FS507	11R22.5	600-1509	600-0316	600-5509	600-4316
FS507	11R24.5	600-1485	600-0302	600-5485	600-4302
FS507	285/75R24.5	600-1508	600-0316	600-5508	600-4316
FS507	295/75R22.5	600-1523	600-0325	600-5523	600-4325
FS567	11R22.5	600-1509	600-0316	600-5509	600-4316
FS567	11R24.5	600-1485	600-0302	600-5485	600-4302
FS567	285/75R24.5	600-1508	600-0316	600-5508	600-4316
FS567	295/75R22.5	600-1523	600-0325	600-5523	600-4325
FS590	11R22.5	600-1509	600-0316	600-5509	600-4316
FS590	11R24.5	600-1485	600-0302	600-5485	600-4302
FS590	285/75R24.5	600-1509	600-0316	600-5509	600-4316
FS590	295/75R22.5	600-1525	600-0326	600-5525	600-4326
FT455	11R22.5	600-1513	600-0319	600-5513	600-4319
FT455	11R24.5	600-1489	600-0304	600-5489	600-4304
FT455	285/75R24.5	600-1510	600-0317	600-5510	600-4317
FT455	295/75R22.5	600-1529	600-0328	600-5529	600-4328
HP3000	315/80R22.5	600-1497	600-0309	600-5497	600-4309
POWER DRIVE	8.25-20	600-1531	600-0330	600-5531	600-4330
POWER DRIVE	9.00-20	600-1507	600-0315	600-5507	600-4315
POWER DRIVE	10.00-20	600-1494	600-0307	600-5494	600-4307
POWER DRIVE	11.00-20	600-1477	600-0297	600-5477	600-4297
POWER DRIVE	11-22.5	600-1494	600-0307	600-5494	600-4307
RIB DUPLEX	15-22.5	600-1502	600-0312	600-5502	600-4312
RIB DUPLEX	16.5-22.5	600-1487	600-0302	600-5487	600-4302
RIB DUPLEX	18-22.5	600-1471	600-0292	600-5471	600-4292
S. A. TRACTION DPLX	14-17.5	600-1585	600-0363	600-5585	600-4363
S. A. TRACTION DPLX	15-19.5	600-1534	600-0332	600-5534	600-4332
S. A. TRACTION DPLX	15-22.5	600-1494	600-0307	600-5494	600-4307
S. A. TRACTION DPLX	18-19.5	600-1497	600-0309	600-5497	600-4309
S. A. TRACTION DPLX	18-22.5	600-1462	600-0287	600-5462	600-4287
S. A. TRACTION ND	8.25-20	600-1528	600-0328	600-5528	600-4328
S. A. TRACTION ND	9.00-20	600-1512	600-0318	600-5512	600-4318
S. A. TRACTION ND	10.00-20	600-1494	600-0307	600-5494	600-4307
S. A. TRACTION ND	11.00-20	600-1487	600-0302	600-5487	600-4302
Steeltex Radial RS4	225/75R16 LT	600-1721	600-0448	600-5721	600-4448
T546 PSD	9.00R20	600-1522	600-0324	600-5522	600-4324
T546 PSD	10.00R20	600-1507	600-0315	600-5507	600-4315
T559	9.00R20	600-1529	600-0328	600-5529	600-4328
T559	9R22.5	600-1551	600-0342	600-5551	600-4342
T559	10.00R20	600-1505	600-0314	600-5505	600-4314
T559	10R22.5	600-1529	600-0328	600-5529	600-4328
T559	11R22.5	600-1510	600-0317	600-5510	600-4317
T559	11R24.5	600-1486	600-0302	600-5486	600-4302
T575	11.00R20	600-1493	600-0307	600-5493	600-4307
T575	11.00R22	600-1471	600-0293	600-5471	600-4293
T575	12R22.5	600-1493	600-0307	600-5493	600-4307
T575	255/70R22.5	600-1574	600-0357	600-5574	600-4357
T819	10.00R20	600-1507	600-0315	600-5507	600-4315
T819	11.00R20	600-1493	600-0307	600-5493	600-4307
T819	11.00R22	600-1470	600-0292	600-5470	600-4292
T819	11R22.5	600-1505	600-0314	600-5505	600-4314
T819	11R24.5	600-1482	600-0299	600-5482	600-4299
T819	12.00R20	600-1469	600-0291	600-5469	600-4291
T819	315/80R22.5	600-1492	600-0306	600-5492	600-4306
T831	10.00R20	600-1497	600-0309	600-5497	600-4309



Firestone... (cont'd)	Tire Size	Mile	Kilometer	Mile (No Trip Feature)	Kilometer (No Trip Feature)
T831	11.00R20	600-1483	600-0300	600-5483	600-4300
T831	11R22.5	600-1496	600-0308	600-5496	600-4308
T831	11R24.5	600-1472	600-0293	600-5472	600-4293
T831	12R22.5	600-1482	600-0299	600-5482	600-4299
T839	385/65R22.5	600-1495	600-0307	600-5495	600-4307
T839	425/65R22.5	600-1472	600-0293	600-5472	600-4293
T839	445/65R22.5	600-1460	600-0286	600-5460	600-4286
TRANSPORT 1	8.25-20	600-1546	600-0339	600-5546	600-4339
TRANSPORT 1	9.00-20	600-1523	600-0325	600-5523	600-4325
TRANSPORT 1	10.00-20	600-1507	600-0315	600-5507	600-4315
TRANSPORT 1	10-22.5	600-1523	600-0325	600-5523	600-4325
TRANSPORT 1	11.00-20	600-1497	600-0309	600-5497	600-4309
TRANSPORT 1	11-22.5	600-1507	600-0315	600-5507	600-4315
TRANSPORT 1	11-24.5	600-1484	600-0301	600-5484	600-4301
TRANSPORT DPLX	14-17.5	600-1588	600-0366	600-5588	600-4366
TRANSPORT DPLX	15-19.5	600-1543	600-0337	600-5543	600-4337
TRANSPORT RIB TR	10.00-20	600-1504	600-0313	600-5504	600-4313
TRANSPORT RIB TR	11-22.5	600-1507	600-0315	600-5507	600-4315
UT2000	12R22.5	600-1491	600-0305	600-5491	600-4305
XR4	10R17.5HC	600-1607	600-0377	600-5607	600-4377
General	Tire Size	Mile	Kilometer	Mile (No Trip Feature)	Kilometer (No Trip Feature)
Ameri LP70	255-70R22.5	600-1575	600-0358	600-5575	600-4358
D460	11R24.5	600-1481	600-0299	600-5481	600-4299
D460	295/75R22.5	600-1519	600-0323	600-5519	600-4323
General Rib ST	295/75R22.5	600-1526	600-0327	600-5526	600-4327
S370	11R22.5	600-1508	600-0316	600-5508	600-4316
Goodyear	Tire Size	Mile	Kilometer	Mile (No Trip Feature)	Kilometer (No Trip Feature)
G104	255/70R22.5	600-1579	600-0360	600-5579	600-4360
G114	215/75R17.5	600-1690	600-0429	600-5690	600-4429
G114	235/75R17.5	600-1664	600-0412	600-5664	600-4412
G114	255/70R22.5	600-1579	600-0360	600-5579	600-4360
G114LT	10.00R15TR	600-1579	600-0360	600-5579	600-4360
G114LT	10R17.5 H	600-1626	600-0389	600-5626	600-4389
G114LT	11R17.5HC	600-1580	600-0361	600-5580	600-4361
G114LT	8.25R15TR	600-1633	600-0394	600-5633	600-4394
G114LT	9R17.5HC	600-1633	600-0394	600-5633	600-4394
G124	10.00R20	600-1505	600-0314	600-5505	600-4314
G124	10R22.5	600-1519	600-0323	600-5519	600-4323
G124	11.00R20	600-1488	600-0303	600-5488	600-4303
G124	11R22.5	600-1505	600-0314	600-5505	600-4314
G124	11R24.5	600-1482	600-0299	600-5482	600-4299
G124	12R22.5	600-1488	600-0303	600-5488	600-4303
G124	245/75R22.5	600-1564	600-0351	600-5564	600-4351
G124	255/70R22.5	600-1572	600-0356	600-5572	600-4356
G124	265/70R19.5	600-1615	600-0382	600-5615	600-4382
G124	265/75R22.5	600-1544	600-0338	600-5544	600-4338
G124	285/75R24.5	600-1503	600-0313	600-5503	600-4313
G124	295/75R22.5	600-1518	600-0322	600-5518	600-4322
G124	9.00R20	600-1519	600-0323	600-5519	600-4323
G124	9R22.5	600-1545	600-0339	600-5545	600-4339
G124-LH	11R22.5	600-1505	600-0314	600-5505	600-4314
G124-LH	11R24.5	600-1482	600-0299	600-5482	600-4299
G124-LH	285/75R24.5	600-1503	600-0313	600-5503	600-4313

Goodyear... (cont'd)	Tire Size	Mile	Kilometer	Mile (No Trip Feature)	Kilometer (No Trip Feature)
G124-LH	295/75R22.5	600-1518	600-0322	600-5518	600-4322
G124LT	225/70R19.5	600-1651	600-0405	600-5651	600-4405
G124LT	245/70R19.5	600-1635	600-0395	600-5635	600-4395
G133LT	8R19.5	600-1635	600-0395	600-5635	600-4395
G133LT	LT215/85R16	600-1695	600-0432	600-5695	600-4432
G133LT	LT225/75R16	600-1719	600-0447	600-5719	600-4447
G133LT	LT235/85R16	600-1683	600-0425	600-5683	600-4425
G133LT	LT245/75R16	600-1683	600-0425	600-5683	600-4425
G143	11R22.5	600-1498	600-0310	600-5498	600-4310
G143	11R24.5	600-1475	600-0295	600-5475	600-4295
G149RSA	11R22.5	600-1507	600-0315	600-5507	600-4315
G152	B305/85R22.5	600-1485	600-0302	600-5485	600-4302
G159	11.00R20	600-1490	600-0304	600-5490	600-4304
G159	255/70R22.5	600-1575	600-0358	600-5575	600-4358
G159	265/70R19.5	600-1620	600-0385	600-5620	600-4385
G159	365/80R20	600-1489	600-0304	600-5489	600-4304
G159	9.00R20	600-1523	600-0325	600-5523	600-4325
G159-22	10R22.5	600-1525	600-0326	600-5525	600-4326
G159-22	12R22.5	600-1490	600-0304	600-5490	600-4304
G159-22	245/75R22.5	600-1569	600-0354	600-5569	600-4354
G159-22	265/75R22.5	600-1544	600-0338	600-5544	600-4338
G159-22	275/70R22.5	600-1560	600-0348	600-5560	600-4348
G159-22	9R22.5	600-1548	600-0341	600-5548	600-4341
G159A	11R22.5	600-1507	600-0315	600-5507	600-4315
G159A	11R24.5	600-1483	600-0300	600-5483	600-4300
G159A	275/80R22.5	600-1523	600-0325	600-5523	600-4325
G159A	285/75R24.5	600-1509	600-0316	600-5509	600-4316
G159A	295/75R22.5	600-1521	600-0324	600-5521	600-4324
G159A-Metro	10.00R20	600-1507	600-0315	600-5507	600-4315
G159A-Metro	11R22.5	600-1507	600-0315	600-5507	600-4315
G159A-Metro	11R24.5	600-1483	600-0300	600-5483	600-4300
G159A-Metro	275/80R22.5	600-1523	600-0325	600-5523	600-4325
G159A-Metro	285/75R24.5	600-1509	600-0316	600-5509	600-4316
G159A-Metro	295/75R22.5	600-1523	600-0325	600-5523	600-4325
G159LT	225/70R19.5	600-1657	600-0408	600-5657	600-4408
G159LT	245/70R19.5	600-1639	600-0397	600-5639	600-4397
G159LT	8.75R16.5	600-1731	600-0455	600-5731	600-4455
G159LT	8R19.5	600-1637	600-0396	600-5637	600-4396
G159LT	LT215/85R16	600-1695	600-0432	600-5695	600-4432
G159LT	LT225/75R16	600-1721	600-0448	600-5721	600-4448
G159LT	LT235/85R16	600-1688	600-0427	600-5688	600-4427
G159LT	LT245/75R16	600-1688	600-0427	600-5688	600-4427
G164RTD	10.00R20	600-1503	600-0313	600-5503	600-4313
G164RTD	11R22.5	600-1503	600-0313	600-5503	600-4313
G164RTD	11R24.5	600-1480	600-0298	600-5480	600-4298
G164RTD	285/75R24.5	600-1504	600-0313	600-5504	600-4313
G164RTD	295/75R22.5	600-1519	600-0323	600-5519	600-4323
G167	11.00R20	600-1486	600-0302	600-5486	600-4302
G167	12R22.5	600-1486	600-0302	600-5486	600-4302
G167A	11R22.5	600-1501	600-0311	600-5501	600-4311
G167A	11R24.5	600-1478	600-0297	600-5478	600-4297
G167A	285/75R24.5	600-1499	600-0310	600-5499	600-4310
G167A	295/75R22.5	600-1515	600-0320	600-5515	600-4320
G171LT	8R19.5	600-1629	600-0391	600-5629	600-4391
G171LT	LT215/85R16	600-1686	600-0426	600-5686	600-4426

Goodyear... (cont'd)	Tire Size	Mile	Kilometer	Mile (No Trip Feature)	Kilometer (No Trip Feature)
G171LT	LT235/85R16	600-1681	600-0423	600-5681	600-4423
G175	11R24.5	600-1473	600-0294	600-5473	600-4294
G177	10.00R20	600-1497	600-0309	600-5497	600-4309
G177	11.00R20	600-1481	600-0299	600-5481	600-4299
G177	11.00R22	600-1460	600-0286	600-5460	600-4286
G177	11R22.5	600-1497	600-0309	600-5497	600-4309
G177	11R24.5	600-1474	600-0295	600-5474	600-4295
G177	12.00R24	600-1425	600-0264	600-5425	600-4264
G177	12R22.5	600-1481	600-0299	600-5481	600-4299
G177	12R24.5	600-1460	600-0286	600-5460	600-4286
G178SS	385/65R22.5	600-1489	600-0304	600-5489	600-4304
G178SS	425/65R22.5	600-1468	600-0291	600-5468	600-4291
G178SS	445/65R22.5	600-1455	600-0282	600-5455	600-4282
G186	10.00R20	600-1503	600-0313	600-5503	600-4313
G186	10R22.5	600-1521	600-0324	600-5521	600-4324
G186	11R22.5	600-1503	600-0313	600-5503	600-4313
G186	11R24.5	600-1480	600-0298	600-5480	600-4298
G186	9.00R20	600-1521	600-0324	600-5521	600-4324
G244MSD	11.00R22	600-1462	600-0287	600-5462	600-4287
G244MSD	11R22.5	600-1501	600-0311	600-5501	600-4311
G244MSD	11R24.5	600-1478	600-0297	600-5478	600-4297
G244MSD	12R22.5	600-1483	600-0300	600-5483	600-4300
G286	10.00R20	600-1501	600-0311	600-5501	600-4311
G286	11.00R20	600-1489	600-0304	600-5489	600-4304
G286	11.00R22	600-1467	600-0290	600-5467	600-4290
G286	11.00R24	600-1447	600-0278	600-5447	600-4278
G286	11R22.5	600-1502	600-0312	600-5502	600-4312
G286	11R24.5	600-1479	600-0297	600-5479	600-4297
G286	12.00R24	600-1435	600-0270	600-5435	600-4270
G286	12R22.5	600-1489	600-0304	600-5489	600-4304
G286	12R24.5	600-1467	600-0290	600-5467	600-4290
G286	14.00R20	600-1434	600-0269	600-5434	600-4269
G286	315/80R22.5	600-1490	600-0304	600-5490	600-4304
G286HSS	315/80R22.5	600-1489	600-0304	600-5489	600-4304
G286SS	385/65R22.5	600-1496	600-0308	600-5496	600-4308
G286SS	425/65R22.5	600-1475	600-0295	600-5475	600-4295
G286SS	445/65R22.5	600-1461	600-0286	600-5461	600-4286
G291	285/70R19.5	600-1599	600-0372	600-5599	600-4372
G291	315/80R22.5	600-1497	600-0309	600-5497	600-4309
G291	8.5R17.5	600-1666	600-0414	600-5666	600-4414
G291LT	8R17.5LT	600-1683	600-0425	600-5683	600-4425
G302FED	11R22.5	600-1501	600-0311	600-5501	600-4311
G302FED	11R24.5	600-1478	600-0297	600-5478	600-4297
G302FED	285/75R24.5	600-1503	600-0313	600-5503	600-4313
G302FED	295/75R22.5	600-1510	600-0317	600-5510	600-4317
G314	11R22.5	600-1512	600-0318	600-5512	600-4318
G314	11R24.5	600-1488	600-0303	600-5488	600-4303
G314	285/75R24.5	600-1514	600-0320	600-5514	600-4320
G314	295/75R22.5	600-1529	600-0328	600-5529	600-4328
G328	11R22.5	600-1499	600-0310	600-5499	600-4310
G328	11R24.5	600-1476	600-0296	600-5476	600-4296
G328	285/75R24.5	600-1501	600-0311	600-5501	600-4311
G328	295/75R22.5	600-1515	600-0320	600-5515	600-4320
G357	11R22.5	600-1509	600-0316	600-5509	600-4316
G357	11R24.5	600-1485	600-0302	600-5485	600-4302

Goodyear... (cont'd)	Tire Size	Mile	Kilometer	Mile (No Trip Feature)	Kilometer (No Trip Feature)
G357	285/75R24.5	600-1509	600-0316	600-5509	600-4316
G357	295/75R22.5	600-1525	600-0326	600-5525	600-4326
G362	11R22.5	600-1501	600-0311	600-5501	600-4311
G362	11R24.5	600-1478	600-0297	600-5478	600-4297
G362	285/75R24.5	600-1501	600-0311	600-5501	600-4311
G362	295/75R22.5	600-1515	600-0320	600-5515	600-4320
G372 LHD	11R22.5	600-1499	600-0310	600-5499	600-4310
G372 LHD	11R24.5	600-1476	600-0296	600-5476	600-4296
G372 LHD	285/75R24.5	600-1497	600-0309	600-5497	600-4309
G372 LHD	295/75R22.5	600-1512	600-0318	600-5512	600-4318
G386	1200R20	600-1478	600-0297	600-5478	600-4297
G391	295/80R22.5	600-1509	600-0316	600-5509	600-4316
G391	315/80R22.5	600-1496	600-0308	600-5496	600-4308
G397LHS	11R22.5	600-1508	600-0316	600-5508	600-4316
G397LHS	11R24.5	600-1485	600-0302	600-5485	600-4302
G397LHS	285/75R24.5	600-1509	600-0316	600-5509	600-4316
G397LHS	295/75R22.5	600-1525	600-0326	600-5525	600-4326
G647RSS	225/70R19.5	600-1655	600-0407	600-5655	600-4407
G647RSS	225/75R16	600-1719	600-0447	600-5719	600-4447
G670RV	225/70R19.5	600-1659	600-0410	600-5659	600-4410
G670RV	245/70R19.5	600-1641	600-0398	600-5641	600-4398
Intercity Cruiser	B315/80R22.5	600-1490	600-0304	600-5490	600-4304
Marathon	205/75R14	600-1811	600-0504	600-5811	600-4504
RHS	315/80R22.5	600-1495	600-0307	600-5495	600-4307
UELP	285/75R24.5	600-1510	600-0317	600-5510	600-4317
WINGAPR	11R22.5	600-1508	600-0316	600-5508	600-4316
WINGAPR	11R24.5	600-1484	600-0301	600-5484	600-4301
WINGAPR	285/75R24.5	600-1510	600-0317	600-5510	600-4317
WINGAPR	295/75R22.5	600-1525	600-0326	600-5525	600-4326
WINGDTR	11R22.5	600-1503	600-0313	600-5503	600-4313
WINGDTR	11R24.5	600-1480	600-0298	600-5480	600-4298
WINGDTR	285/75R24.5	600-1504	600-0313	600-5504	600-4313
WINGDTR	295/75R22.5	600-1519	600-0323	600-5519	600-4323
Kelly	Tire Size	Mile	Kilometer	Mile (No Trip Feature)	Kilometer (No Trip Feature)
KDA	11R22.5	600-1501	600-0311	600-5501	600-4311
KSA	285/75R24.5	600-1510	600-0317	600-5510	600-4317
KT	255/70R22.5	600-1575	600-0358	600-5575	600-4358
KT	295/75R22.5	600-1527	600-0328	600-5527	600-4328
KTSA	11R22.5	600-1508	600-0316	600-5508	600-4316
Kumho	Tire Size	Mile	Kilometer	Mile (No Trip Feature)	Kilometer (No Trip Feature)
945A	11R24.5	600-1481	600-0299	600-5481	600-4299
961	255/70R22.5	600-1577	600-0359	600-5577	600-4359
Michelin	Tire Size	Mile	Kilometer	Mile (No Trip Feature)	Kilometer (No Trip Feature)
DR434	10.00R20	600-1503	600-0313	600-5503	600-4313
DR434	10R22.5	600-1522	600-0324	600-5522	600-4324
DR434	11.00R20	600-1492	600-0306	600-5492	600-4306
DR434	11.00R22	600-1467	600-0290	600-5467	600-4290
DR434	11R22.5	600-1504	600-0313	600-5504	600-4313
DR434	11R24.5	600-1480	600-0298	600-5480	600-4298
DR434	275/80R22.5	600-1519	600-0323	600-5519	600-4323
DR434	275/80R24.5	600-1503	600-0313	600-5503	600-4313
DR434	9.00R20	600-1523	600-0325	600-5523	600-4325

Michelin...(cont'd)	Tire Size	Mile	Kilometer	Mile (No Trip Feature)	Kilometer (No Trip Feature)
DR444	11R22.5	600-1503	600-0313	600-5503	600-4313
DR444	11R24.5	600-1478	600-0297	600-5478	600-4297
DR444	275/80R22.5	600-1518	600-0322	600-5518	600-4322
DR444	275/80R24.5	600-1502	600-0312	600-5502	600-4312
DR665	10.00R20	600-1499	600-0310	600-5499	600-4310
DR665	11R22.5	600-1502	600-0312	600-5502	600-4312
DR665	11R24.5	600-1478	600-0297	600-5478	600-4297
Energy XTA	235/75R17.5	600-1679	600-0422	600-5679	600-4422
Energy XTA	245/70R17.5	600-1679	600-0421	600-5679	600-4421
Energy XTA	265/70R19.5	600-1619	600-0385	600-5619	600-4385
Energy XTA	385/65R22.5	600-1501	600-0311	600-5501	600-4311
ST220	11R22.5	600-1509	600-0316	600-5509	600-4316
ST220	11R24.5	600-1485	600-0302	600-5485	600-4302
ST230	10.00R20	600-1508	600-0316	600-5508	600-4316
ST230	10R22.5	600-1528	600-0328	600-5528	600-4328
ST230	11.00R20	600-1497	600-0309	600-5497	600-4309
ST230	11.00R22	600-1472	600-0293	600-5472	600-4293
ST230	11R22.5	600-1512	600-0318	600-5512	600-4318
ST230	11R24.5	600-1485	600-0302	600-5485	600-4302
ST230	12R22.5	600-1496	600-0308	600-5496	600-4308
ST230	255/70R22.5	600-1576	600-0358	600-5576	600-4358
ST230	275/80R22.5	600-1526	600-0327	600-5526	600-4327
ST230	315/80R22.5	600-1496	600-0308	600-5496	600-4308
ST230	9.00R20	600-1528	600-0328	600-5528	600-4328
ST234	11R22.5	600-1512	600-0318	600-5512	600-4318
ST234	11R24.5	600-1485	600-0302	600-5485	600-4302
ST234	275/80R22.5	600-1526	600-0327	600-5526	600-4327
ST234	275/80R24.5	600-1509	600-0316	600-5509	600-4316
ST234	315/80R22.5	600-1496	600-0308	600-5496	600-4308
ST565	10.00R20	600-1506	600-0315	600-5506	600-4315
ST565	11.00R20	600-1495	600-0308	600-5495	600-4308
ST565	11.00R22	600-1471	600-0292	600-5471	600-4292
ST565	11R22.5	600-1509	600-0316	600-5509	600-4316
ST565	11R24.5	600-1485	600-0302	600-5485	600-4302
ST565	385/65R22.5	600-1499	600-0310	600-5499	600-4310
ST565	425/65R22.5	600-1473	600-0294	600-5473	600-4294
ST565	445/65R22.5	600-1462	600-0287	600-5462	600-4287
TR134	11R22.5	600-1513	600-0319	600-5513	600-4319
TR134	11R24.5	600-1489	600-0304	600-5489	600-4304
TR134	275/80R22.5	600-1534	600-0332	600-5534	600-4332
TR134	275/80R24.5	600-1515	600-0320	600-5515	600-4320
X One XDA	445/50R22.5	600-1523	600-0325	600-5523	600-4325
X One XDA-HT	455/55R22.5	600-1497	600-0309	600-5497	600-4309
X One XTA	445/50R22.5	600-1534	600-0332	600-5534	600-4332
X One XTE	445/50R22.5	600-1530	600-0329	600-5530	600-4329
X One XTE	455/55R22.5	600-1504	600-0313	600-5504	600-4313
XD2	255/70R22.5	600-1567	600-0352	600-5567	600-4352
XD2	285/70R19.5	600-1592	600-0368	600-5592	600-4368
XD4	11R22.5	600-1501	600-0311	600-5501	600-4311
XD4	11R24.5	600-1480	600-0298	600-5480	600-4298
XD4	275/80R22.5	600-1516	600-0321	600-5516	600-4321
XD4	275/80R24.5	600-1501	600-0311	600-5501	600-4311
XDA	275/70R22.5	600-1550	600-0342	600-5550	600-4342
XDA	305/75R24.5	600-1490	600-0304	600-5490	600-4304
XDA2	11R22.5	600-1502	600-0312	600-5502	600-4312

Michelin...(cont'd)	Tire Size	Mile	Kilometer	Mile (No Trip Feature)	Kilometer (No Trip Feature)
XDA2	11R24.5	600-1480	600-0298	600-5480	600-4298
XDA2	255/70R22.5	600-1566	600-0352	600-5566	600-4352
XDA2	275/80R22.5	600-1519	600-0323	600-5519	600-4323
XDA2	275/80R24.5	600-1502	600-0312	600-5502	600-4312
XDA-HT	11R22.5	600-1501	600-0311	600-5501	600-4311
XDA-HT	11R24.5	600-1480	600-0298	600-5480	600-4298
XDA-HT	275/80R22.5	600-1515	600-0320	600-5515	600-4320
XDA-HT	275/80R24.5	600-1501	600-0311	600-5501	600-4311
XDE A/T	11R22.5	600-1500	600-0311	600-5500	600-4311
XDE A/T	11R24.5	600-1476	600-0296	600-5476	600-4296
XDE A/T	12R22.5	600-1489	600-0304	600-5489	600-4304
XDE M/S	10R22.5	600-1523	600-0325	600-5523	600-4325
XDE M/S	11R22.5	600-1504	600-0313	600-5504	600-4313
XDE M/S	11R24.5	600-1479	600-0297	600-5479	600-4297
XDE M/S	12R22.5	600-1489	600-0304	600-5489	600-4304
XDE M/S	225/70R19.5	600-1647	600-0402	600-5647	600-4402
XDE M/S	235/80R22.5	600-1559	600-0348	600-5559	600-4348
XDE M/S	245/70R19.5	600-1624	600-0388	600-5624	600-4388
XDE M/S	255/80R22.5	600-1544	600-0338	600-5544	600-4338
XDE M/S	275/80R22.5	600-1520	600-0323	600-5520	600-4323
XDE M/S	9R22.5	600-1547	600-0340	600-5547	600-4340
XDE1	215/75R17.5	600-1690	600-0429	600-5690	600-4429
XDE1	245/70R17.5	600-1671	600-0417	600-5671	600-4417
XDE2(Eur)	245/70R19.5	600-1628	600-0390	600-5671	600-4390
XDHT	11R22.5	600-1502	600-0312	600-5502	600-4312
XDHT	11R24.5	600-1479	600-0298	600-5479	600-4298
XDHT	275/80R22.5	600-1517	600-0321	600-5517	600-4321
XDHT	275/80R24.5	600-1502	600-0312	600-5502	600-4312
XDL	10.00R20	600-1495	600-0308	600-5495	600-4308
XDL	12.00R24	600-1425	600-0264	600-5425	600-4264
XDN	11R22.5	600-1505	600-0314	600-5505	600-4314
XDN	11R24.5	600-1481	600-0299	600-5481	600-4299
XDN	275/80R22.5	600-1521	600-0324	600-5521	600-4324
XDN	275/80R24.5	600-1506	600-0315	600-5506	600-4315
XDN	315/80R22.5	600-1489	600-0304	600-5489	600-4304
XDN GRIP	12R22.5	600-1489	600-0304	600-5489	600-4304
XDR	30.00R51	600-1183	600-0114	600-5183	600-4114
XDR	37.00R57	600-1154	600-096	600-5154	600-496
XDS	11R22.5	600-1503	600-0312	600-5503	600-4312
XDS	11R24.5	600-1479	600-0298	600-5479	600-4298
XDS	12R22.5	600-1491	600-0305	600-5491	600-4305
XDU	235/80R22.5	600-1562	600-0349	600-5562	600-4349
XDU	255/80R22.5	600-1548	600-0341	600-5548	600-4341
XDY	315/80R22.5	600-1489	600-0304	600-5489	600-4304
XDY-2	11R22.5	600-1501	600-0311	600-5501	600-4311
XDY-2	11R24.5	600-1476	600-0296	600-5476	600-4296
XDY-2	12R24.5	600-1465	600-0289	600-5465	600-4289
XKD1	24.00R35	600-1242	600-0151	600-5242	600-4151
XKD1	27.00R49	600-1198	600-0123	600-5198	600-4123
XKD1	53/80R63	600-1141	600-088	600-5141	600-488
XL	11.00R16	600-1543	600-0338	600-5543	600-4338
XL	11.00R20	600-1487	600-0303	600-5487	600-4303
XL	14.00R20	600-1424	600-0264	600-5424	600-4264
XL	14.5R20	600-1484	600-0301	600-5484	600-4301
XL	14.75/80R20	600-1466	600-0289	600-5466	600-4289

Michelin...(cont'd)	Tire Size	Mile	Kilometer	Mile (No Trip Feature)	Kilometer (No Trip Feature)
XL	15.5/80R20	600-1451	600-0280	600-5451	600-4280
XL	16.00R20	600-1395	600-0245	600-5395	600-4245
XL	9.00R16	600-1584	600-0363	600-5584	600-4363
XL TT	11.00R20	600-1487	600-0303	600-5487	600-4303
XL TT	9.00R20	600-1518	600-0322	600-5518	600-4322
XM+S4	10.00R20	600-1507	600-0315	600-5507	600-4315
XM+S4	10R22.5	600-1523	600-0325	600-5523	600-4325
XM+S4	11R22.5	600-1504	600-0313	600-5504	600-4313
XM+S4	11R24.5	600-1481	600-0299	600-5481	600-4299
XM+S4	275/80R22.5	600-1520	600-0323	600-5520	600-4323
XM+S4	9.00R20	600-1524	600-0325	600-5524	600-4325
XM+S4	9R22.5	600-1549	600-0341	600-5549	600-4341
XML	12.00R20	600-1472	600-0293	600-5472	600-4293
XML	14.00R20	600-1424	600-0263	600-5424	600-4263
XML	325/85R16	600-1543	600-0338	600-5543	600-4338
XML	395/85R20	600-1449	600-0279	600-5449	600-4279
XPS RIB	7.50R16	600-1663	600-0412	600-5663	600-4412
XPS RIB	8.75R16.5	600-1724	600-0450	600-5724	600-4450
XPS RIB	9.50R16.5	600-1695	600-0432	600-5695	600-4432
XPS RIB	LT215/85R16	600-1692	600-0430	600-5692	600-4430
XPS RIB	LT225/75R16	600-1720	600-0447	600-5720	600-4447
XPS RIB	LT235/85R16	600-1663	600-0412	600-5663	600-4412
XPS TRAC	7.50R16	600-1661	600-0411	600-5661	600-4411
XPS TRAC	LT215/85R16	600-1688	600-0427	600-5688	600-4427
XPS TRAC	LT235/85R16	600-1659	600-0410	600-5659	600-4410
XRV	225/70R19.5	600-1659	600-0410	600-5659	600-4410
XRV	235/80R22.5	600-1567	600-0353	600-5567	600-4353
XRV	245/70R19.5	600-1633	600-0394	600-5633	600-4394
XRV	255/80R22.5	600-1550	600-0342	600-5550	600-4342
XT-1	11R22.5	600-1515	600-0320	600-5515	600-4320
XT-1	11R24.5	600-1489	600-0304	600-5489	600-4304
XT-1	275/80R22.5	600-1530	600-0329	600-5530	600-4329
XT-1	275/80R24.5	600-1515	600-0320	600-5515	600-4320
XT-1	445/50R22.5	600-1532	600-0330	600-5532	600-4330
XTA	10.00R15	600-1585	600-0364	600-5585	600-4364
XTA	215/75R17.5	600-1689	600-0428	600-5689	600-4428
XTA	7.50R15	600-1698	600-0433	600-5698	600-4433
XTA	8.25R15	600-1641	600-0398	600-5641	600-4398
XTA	9R17.5	600-1637	600-0396	600-5637	600-4396
XTE2	235/75R17.5	600-1674	600-0419	600-5674	600-4419
XTE2	385/65R22.5	600-1498	600-0310	600-5498	600-4310
XTE2	425/65R22.5	600-1472	600-0293	600-5472	600-4293
XTE2	445/65R22.5	600-1461	600-0286	600-5461	600-4286
XTY	275/70R22.5	600-1554	600-0344	600-5554	600-4344
XTY2	275/70R22.5	600-1551	600-0342	600-5551	600-4342
XZ2	12R22.5	600-1496	600-0308	600-5496	600-4308
XZA	10.00R20	600-1508	600-0315	600-5508	600-4315
XZA	10R17.5	600-1622	600-0386	600-5622	600-4386
XZA	11.00R20	600-1493	600-0306	600-5493	600-4306
XZA	12.00R20	600-1477	600-0296	600-5477	600-4296
XZA	225/70R19.5	600-1657	600-0408	600-5657	600-4408
XZA	265/70R19.5	600-1616	600-0382	600-5616	600-4382
XZA	285/70R19.5	600-1600	600-0373	600-5600	600-4373
XZA	295/80R22.5	600-1507	600-0315	600-5507	600-4315
XZA	305/70R19.5	600-1580	600-0361	600-5580	600-4361

Michelin...(cont'd)	Tire Size	Mile	Kilometer	Mile (No Trip Feature)	Kilometer (No Trip Feature)
XZA	305/75R24.5	600-1495	600-0308	600-5495	600-4308
XZA	365/80R20	600-1484	600-0301	600-5484	600-4301
XZA	8.5R17.5	600-1669	600-0415	600-5669	600-4415
XZA	8R19.5	600-1627	600-0390	600-5627	600-4390
XZA	9.00R20	600-1528	600-0328	600-5528	600-4328
XZA (Eur)	285/70R19.5	600-1600	600-0373	600-5600	600-4373
XZA1 (Eur)	275/70R22.5	600-1554	600-0344	600-5554	600-4344
XZA1 (Eur)	275/80R22.5	600-1523	600-0325	600-5523	600-4325
XZA1 (Eur)	295/80R22.5	600-1508	600-0315	600-5508	600-4315
XZA1 (Eur)	315/80R22.5	600-1495	600-0307	600-5495	600-4307
XZA-1+	11R22.5	600-1509	600-0316	600-5509	600-4316
XZA-1+	11R24.5	600-1485	600-0302	600-5485	600-4302
XZA-1+	275/80R22.5	600-1524	600-0326	600-5524	600-4326
XZA-1+	275/80R24.5	600-1509	600-0316	600-5509	600-4316
XZA2	11R22.5	600-1510	600-0317	600-5510	600-4317
XZA2	11R24.5	600-1485	600-0302	600-5485	600-4302
XZA2	275/80R22.5	600-1526	600-0327	600-5526	600-4327
XZA2	275/80R24.5	600-1509	600-0316	600-5509	600-4316
XZA4 (G20)	14.00R20	600-1430	600-0267	600-5430	600-4267
XZE	10R22.5	600-1525	600-0326	600-5525	600-4326
XZE	11R22.5	600-1509	600-0316	600-5509	600-4316
XZE	11R24.5	600-1484	600-0300	600-5484	600-4300
XZE	12R22.5	600-1494	600-0307	600-5494	600-4307
XZE	225/70R19.5	600-1654	600-0407	600-5654	600-4407
XZE	235/80R22.5	600-1564	600-0350	600-5564	600-4350
XZE	245/70R19.5	600-1628	600-0390	600-5628	600-4390
XZE	255/70R22.5	600-1574	600-0357	600-5574	600-4357
XZE	255/80R22.5	600-1546	600-0339	600-5546	600-4339
XZE	275/80R22.5	600-1523	600-0325	600-5523	600-4325
XZE	275/80R24.5	600-1509	600-0316	600-5509	600-4316
XZE	9R22.5	600-1551	600-0342	600-5551	600-4342
XZE1	215/75R17.5	600-1693	600-0431	600-5693	600-4431
XZE1	245/70R17.5	600-1674	600-0419	600-5674	600-4419
XZE2(Eur)	295/80R22.5	600-1506	600-0315	600-5506	600-4315
XZL	11.00R20	600-1489	600-0304	600-5489	600-4304
XZL	14.00R20	600-1424	600-0263	600-5424	600-4263
XZL	16.00R20	600-1397	600-0246	600-5397	600-4246
XZL	24R21	600-1384	600-0238	600-5384	600-4238
XZL	365/85R20	600-1466	600-0290	600-5466	600-4290
XZL	395/85R20	600-1449	600-0279	600-5449	600-4279
XZL	9.00R16	600-1579	600-0360	600-5579	600-4360
XZL (wb)	445/65R22.5	600-1457	600-0284	600-5457	600-4284
XZL MPT	335/80R20	600-1517	600-0321	600-5517	600-4321
XZL MPT	365/80R20	600-1487	600-0303	600-5487	600-4303
XZT	225/70R19.5	600-1652	600-0405	600-5652	600-4405
XZT	245/70R19.5	600-1628	600-0390	600-5628	600-4390
XZT	265/70R19.5	600-1611	600-0380	600-5611	600-4380
XZT	285/70R19.5	600-1595	600-0370	600-5595	600-4370
XZU	11R22.5	600-1504	600-0313	600-5504	600-4313
XZU2	10.00R20	600-1504	600-0313	600-5504	600-4313
XZU2	12R22.5	600-1490	600-0305	600-5490	600-4305
XZU2	275/70R22.5	600-1552	600-0343	600-5552	600-4343
XZU2	305/70R22.5	600-1534	600-0332	600-5534	600-4332
XZY	10.00R20	600-1506	600-0315	600-5506	600-4315
XZY	11.00R20	600-1491	600-0305	600-5491	600-4305

Michelin... (cont'd)	Tire Size	Mile	Kilometer	Mile (No Trip Feature)	Kilometer (No Trip Feature)
XZY	11.00R22	600-1468	600-0291	600-5468	600-4291
XZY	11.00R24	600-1449	600-0279	600-5449	600-4279
XZY	12.00R20	600-1473	600-0294	600-5473	600-4294
XZY	12.00R24	600-1436	600-0271	600-5436	600-4271
XZY	7.50R16	600-1663	600-0412	600-5663	600-4412
XZY	8.25R20	600-1553	600-0344	600-5553	600-4344
XZY (wb)	385/65R22.5	600-1497	600-0309	600-5497	600-4309
XZY (wb)	425/65R22.5	600-1472	600-0293	600-5472	600-4293
XZY (wb)	445/65R19.5	600-1494	600-0307	600-5494	600-4307
XZY (wb)	445/65R22.5	600-1461	600-0286	600-5461	600-4286
XZY-1	315/80R22.5	600-1491	600-0305	600-5491	600-4305
XZY-1S	315/80R22.5	600-1491	600-0305	600-5491	600-4305
XZY-2	11R22.5	600-1504	600-0313	600-5504	600-4313
XZY-2	11R24.5	600-1481	600-0299	600-5481	600-4299
XZY-2	12R22.5	600-1490	600-0305	600-5490	600-4305
XZY-2	12R24.5	600-1467	600-0290	600-5467	600-4290
XZY-2	315/80R22.5	600-1491	600-0305	600-5491	600-4305
XZY-2S	315/80R22.5	600-1491	600-0305	600-5491	600-4305
Sumitomo	Tire Size	Mile	Kilometer	Mile (No Trip Feature)	Kilometer (No Trip Feature)
ST727	10.00R15	600-1584	600-0363	600-5584	600-4363
Toyo	Tire Size	Mile	Kilometer	Mile (No Trip Feature)	Kilometer (No Trip Feature)
M120Z	10R22.5	600-1527	600-0328	600-5527	600-4328
Yokohama	Tire Size	Mile	Kilometer	Mile (No Trip Feature)	Kilometer (No Trip Feature)
RY103	295/75R22.5	600-1526	600-0327	600-5526	600-4327
RY103	315/80R22.5	600-1497	600-0309	600-5497	600-4309
RY112A	11R22.5	600-1512	600-0318	600-5512	600-4318
TY303	11R24.5	600-1478	600-0297	600-5478	600-4297
TY517	11R24.5	600-1478	600-0297	600-5478	600-4297

Program Your Profits



DataTrac Pro Shown Actual Size

Never Miss A Sale!

Stock one programmable part number, lowering inventory and increasing inventory turns.

Program over 2,500 specific tire models and sizes to ensure customer gets reliable mileage information



FEATURES AND BENEFITS

Program Your Revolutions

To program the DataTrac Pro, all you need to know is the tire make, model and size. Refer to the chart (on back) for the most popular tires and the corresponding revolutions that you will program into the DataTrac Pro.

How it Works

The Program Part Screen on the Programmer provides you with three programming options for the DataTrac Pro: Revolutions, Units and Preset.

Revolutions - This option allows you to program the revolutions per mile or kilometer into the DataTrac Pro that corresponds with the particular tire brand, make and model. Programming the three digit revolu-

tions into the DataTrac Pro ensures you will always have the part number your customer needs.

Units - This option allows you to program the DataTrac Pro with the required unit of measure, as well as select the trip function if needed. You choose from mile, mile trip, kilometer, or kilometer trip and program exactly what your customer needs.

Preset - With this option you can program a specific preset mileage point to correspond with a customer's need or wants. In the past, customer request's for preset hubo mileage meant lead times. Not with DataTrac Pro. Program preset mileage with the touch of a button and make sure you always have what your customer needs.

Accuracy - To ensure accurate calibration, we have worked with the engineering staffs of all major tire manufacturers. We have compiled fleet data on more than 2,500 tire models and sizes. With DataTrac Pro you can stock one part number and program it to fit any of the 2,500 tire models and sizes with the touch of a button.



STEMCO®

A Higher Standard of Performance.™

an EnPro Industries company

STEMCO Hubodometer Application Guide

Table of Contents

Tire Make/Model Listing

BFGoodrich.....	Page 1
Bridgestone.....	Page 1
Continental.....	Page 4
Cooper.....	Page 4
Dayton.....	Page 4
Dunlop.....	Page 4
Firestone.....	Page 4
General.....	Page 6
Goodyear.....	Page 6
Kelly.....	Page 10
Kumho.....	Page 10
Michelin.....	Page 11
Sumitomo.....	Page 16
Toyo.....	Page 16
Yokohama.....	Page 16
Popular Hubodometer Brackets and Hub Caps.....	Page 18
STEMCO Hubodometer Installation Instructions.....	Page 19
Brackets by Part Number.....	Page 20
Brackets by Bolt Circle Diameter.....	Page 21

	Tire Size	Stemco Mechanical Hubo Miles	Stemco Mechanical Hubo KM	Veeder-root P/N Miles	Veeder-root P/N KM	DataTrac Miles	DataTrac KM	REV - Mile DataTrac Pro*	REV - KM DataTrac Pro*
BFGoodrich									
DR434	11R22.5	650-0583	650-0526	777717-468	777727-294	600-1467	600-0290	467	290
DR444	11R22.5	650-0602	650-0539	777717-500	777727-312	600-1503	600-0313	503	313
TR134	11R24.5	650-0593	650-0534	777717-490	777727-306	600-1489	600-0304	489	304
Bridgestone									
L312	445/65R22.5	650-0581	650-0525	777717-465	777727-294	600-1460	600-0286	460	286
L317	10.00R20	650-0595	650-0537	777717-494	777727-306	600-1497	600-0309	497	309
L317	11.00R20	650-0591	650-0532	777717-484	777727-300	600-1483	600-0300	483	300
L317	11.00R22	650-0581	650-0525	777717-465	777727-294	600-1461	600-0286	461	286
L317	11R22.5	650-0595	650-0535	777717-490	777727-306	600-1496	600-0308	496	308
L317	11R24.5	650-0583	650-0528	777717-468	777727-294	600-1473	600-0294	473	294
L317	1200R24NHS	NA	650-0519	777717-424	777727-273	600-1425	600-0264	425	264
L317	12R22.5	650-0587	650-0532	777717-475	777727-300	600-1482	600-0299	482	299
L355	12.00R24	650-0576	650-0521	777717-433	NA	600-1435	600-0270	435	270
M711	11R22.5	650-0598	650-0537	777717-500	777727-312	600-1502	600-0312	502	312
M711	11R24.5	650-0587	650-0528	777717-475	777727-294	600-1479	600-0297	479	297
M711	12R22.5	650-0591	650-0532	777717-484	777727-300	600-1485	600-0302	485	302
M711	255/70R22.5	650-0640	650-0549	777717-572	777727-350	600-1568	600-0353	568	353
M711	285/75R24.5	650-0598	650-0537	777717-500	777727-310	600-1502	600-0312	502	312
M711	295/75R22.5	650-0608	650-0541	777717-514	777727-326	600-1518	600-0322	518	322
M711WB	385/65R22.5	650-0593	650-0535	777717-490	777727-306	600-1492	600-0306	492	306
M711WB	425/65R22.5	650-0583	650-0528	777717-475	777727-294	600-1471	600-0293	471	293
M716	215/75R17.5	650-0677	650-0571	777717-686	777727-424	600-1692	600-0430	692	430
M716	265/70R19.5	650-0630	650-0559	777717-612	777727-381	600-1613	600-0381	613	381
M716	265/75R22.5	650-0617	650-0548	777717-539	777727-333	600-1545	600-0339	545	339
M716	285/70R19.5	650-0629	650-0552	777717-588	777727-366	600-1595	600-0370	595	370
M720	285/75R24.5	650-0598	650-0537	777717-500	777727-310	600-1502	600-0312	502	312
M720	295/75R22.5	650-0608	650-0541	777717-514	777727-326	600-1518	600-0322	518	322
M724F	8.25-20	650-0598	650-0537	777717-500	777727-310	600-1499	600-0310	499	310
M724F	225/70R19.5	650-0634	650-0563	777717-637	777727-400	600-1647	600-0402	647	402
M724F	245/70R19.5	650-0633	650-0561	777717-624	777727-392	600-1629	600-0391	629	391
M724F	8R19.5	650-0631	650-0559	777717-624	777727-381	600-1622	600-0386	622	386
M725	11R22.5	650-0598	650-0537	777717-500	777727-310	600-1499	600-0310	499	310
M725	11R24.5	650-0584	650-0528	777717-475	777727-294	600-1476	600-0296	476	296
M725	285/75R24.5	650-0598	650-0537	777717-500	777727-310	600-1499	600-0310	499	310
M725	295/75R22.5	650-0606	650-0541	777717-514	777727-316	600-1514	600-0320	514	320
M726	11R22.5	650-0598	650-0537	777717-500	777727-310	600-1499	600-0310	499	310
M726	11R24.5	650-0584	650-0528	777717-475	777727-294	600-1476	600-0296	476	296
M726	255/70R22.5	650-0622	650-0549	777717-572	777727-350	600-1564	600-0351	564	351
M726	265/75R22.5	650-0617	650-0665	777717-546	777727-343	600-1548	600-0341	548	341
M726	285/75R24.5	650-0595	650-0537	777717-494	777727-306	600-1499	600-0310	499	310
M726	295/75R22.5	650-0605	650-0541	777717-510	777727-316	600-1514	600-0320	514	320

	Tire Size	Stemco Mechanical Hubo Miles	Stemco Mechanical Hubo KM	Veeder-root P/N Miles	Veeder-root P/N KM	DataTrac Miles	DataTrac KM	REV - Mile DataTrac Pro*	REV - KM DataTrac Pro*
M726F	9R22.5	650-0616	650-0548	777717-539	777727-333	600-1542	600-0337	542	337
M726F	10R22.5	650-0608	650-0542	777717-514	777727-326	600-1519	600-0323	519	323
M774	11R22.5	650-0593	650-0534	777717-484	777727-306	600-1490	600-0304	490	304
M774	11R24.5	650-0583	650-0526	777717-465	777727-294	600-1468	600-0291	468	291
M774	12R22.5	650-0587	650-0528	777717-475	777727-300	600-1480	600-0298	480	298
M840	10.00R20	650-0595	650-0537	777717-494	777727-306	600-1497	600-0309	497	309
M840	11.00R20	650-0587	650-0532	777717-484	777727-300	600-1481	600-0299	481	299
M840	11.00R22	650-0671	650-0526	777717-465	777727-294	600-1465	600-0289	465	289
M840	11R22.5	650-0598	650-0537	777717-494	777727-306	600-1498	600-0310	498	310
M840	12.00R20	650-0583	650-0526	777717-465	777727-294	600-1467	600-0290	467	290
M840	12.00R24	650-0576	650-0521	777717-433	NA	600-1436	600-0271	436	271
M840	275/70R22.5	650-0617	650-0665	777717-546	777727-343	600-1548	600-0341	548	341
M843	11R22.5	650-0595	650-0535	777717-490	777727-306	600-1495	600-0307	495	307
M843	11R24.5	650-0583	650-0528	777717-468	777727-294	600-1473	600-0294	473	294
M843	12R22.5	650-0591	650-0532	777717-484	777727-300	600-1484	600-0301	484	301
M843	12R24.5	650-0671	650-0525	777717-465	777727-294	600-1463	600-0287	463	287
M843	315/80R22.5	650-0591	650-0532	777717-484	777727-300	600-1485	600-0302	485	302
M844F	385/65R22.5	650-0593	650-0534	777717-490	777727-306	600-1491	600-0305	491	305
M844F	425/65R22.5	650-0583	650-0526	777717-468	777727-294	600-1469	600-0291	469	291
M844F	445/65R22.5	650-0581	650-0525	777717-465	777727-294	600-1458	600-0284	458	284
M857	11.00R24	650-0579	650-0523	777717-450	777727-294	600-1450	600-0279	450	279
M857	11R24.5	650-0587	650-0532	777717-484	777727-300	600-1482	600-0299	482	299
M857	12.00R24	650-0670	650-0521	777717-441	777727-273	600-1444	600-0276	444	276
M857	12R22.5	650-0593	650-0534	777717-490	777727-306	600-1491	600-0305	491	305
M857	445/65R19.5	650-0595	650-0535	777717-494	777727-306	600-1493	600-0307	493	307
R180	10R17.5	650-0631	NA	777717-624	777727-392	600-1626	600-0389	626	389
R180	9R17.5	650-0673	650-0561	777717-637	777727-392	600-1637	600-0396	637	396
R184	215/75R17.5	650-0677	650-0571	777717-686	777727-424	600-1690	600-0429	690	429
R184	235/75R17.5	650-0704	NA	777717-676	777727-416	600-1668	600-0415	668	415
R187	10.00R15	650-0627	650-0552	777717-588	777727-359	600-1585	600-0364	585	364
R187	8.25R15	650-0633	650-0561	777717-637	777727-392	600-1637	600-0396	637	396
R187	8R19.5	650-0633	650-0561	777717-624	777727-392	600-1628	600-0390	628	390
R187F	225/70R19.5	650-0634	650-0563	777717-650	777727-400	600-1651	600-0405	651	405
R187F	245/70R19.5	650-0633	650-0561	777717-624	777727-392	600-1633	600-0394	633	394
R192	12R22.5	650-0593	650-0534	777717-484	777727-300	600-1488	600-0303	488	303
R192	305/70R22.5	650-0613	650-0664	777717-525	777727-326	600-1529	600-0328	529	328
R194	11R22.5	650-0605	650-0541	777717-510	777727-316	600-1513	600-0319	513	319
R194	11R24.5	650-0593	650-0534	777717-484	777727-300	600-1489	600-0304	489	304
R194	275/70R22.5	650-0613	650-0545	777717-525	777727-326	600-1529	600-0328	529	328
R194	285/75R24.5	650-0605	650-0541	777717-510	777727-316	600-1513	600-0319	513	319
R194	295/75R22.5	650-0613	650-0545	777717-525	777727-326	600-1529	600-0328	529	328
R194F	255/70R22.5	650-0627	650-0552	777717-572	777727-359	600-1580	600-0361	580	361
R194F	295/75R22.5	650-0613	650-0545	777717-525	777727-326	600-1529	600-0328	529	328
R194FE	295/75R22.5	650-0613	650-0545	777717-525	777727-326	600-1529	600-0328	529	328

	Tire Size	Stemco Mechanical Hubo Miles	Stemco Mechanical Hubo KM	Veeder-root P/N Miles	Veeder-root P/N KM	DataTrac Miles	DataTrac KM	REV - Mile DataTrac Pro*	REV - KM DataTrac Pro*
R194WB	385/65R22.5	650-0593	650-0535	777717-490	777727-306	600-1492	600-0306	492	306
R194WB	425/65R22.5	650-0583	650-0526	777717-468	777727-294	600-1470	600-0292	470	292
R195	295/75R22.5	650-0613	650-0545	777717-520	777727-326	600-1529	600-0328	529	328
R195F	11R22.5	650-0605	650-0541	777717-514	777727-316	600-1514	600-0320	514	320
R196	11R22.5	650-0601	650-0539	777717-510	777727-316	600-1509	600-0316	509	316
R196	11R24.5	650-0591	650-0532	777717-484	777727-300	600-1485	600-0302	485	302
R196	285/75R24.5	650-0601	650-0539	777717-510	777727-312	600-1507	600-0315	507	315
R196	295/75R22.5	650-0610	650-0545	777717-520	777727-326	600-1526	600-0327	526	327
R226	11R22.5	650-0601	650-0539	777717-510	777727-316	600-1509	600-0316	509	316
R226	11R24.5	650-0587	650-0532	777717-484	777727-300	600-1482	600-0299	482	299
R226	285/75R24.5	650-0601	650-0539	777717-500	777727-310	600-1505	600-0314	505	314
R226	295/75R22.5	650-0610	650-0545	777717-520	777727-326	600-1522	600-0324	522	324
R227	11R22.5	650-0601	650-0539	777717-510	777727-316	600-1509	600-0316	509	316
R227	11R24.5	650-0591	650-0532	777717-484	777727-300	600-1485	600-0302	485	302
R227	275/80R22.5	650-0610	650-0545	777717-520	777727-326	600-1525	600-0326	525	326
R227	285/75R24.5	650-0601	650-0539	777717-510	777727-316	600-1509	600-0316	509	316
R227	295/75R22.5	650-0610	650-0545	777717-520	777727-326	600-1525	600-0326	525	326
R250	9.00R20	650-0610	650-0545	777717-520	777727-326	600-1526	600-0327	526	327
R250	10.00R20	650-0601	650-0539	777717-510	777727-312	600-1507	600-0315	507	315
R250	11.00R20	650-0595	650-0535	777717-490	777727-306	600-1495	600-0307	495	307
R250	11.00R22	650-0583	650-0528	777717-468	777727-294	600-1471	600-0293	471	293
R250	12.00R20	650-0583	650-0526	777717-465	777727-294	600-1470	600-0292	470	292
R250	265/70R19.5	650-0630	650-0559	777717-612	777727-381	600-1615	600-0382	615	382
R250F	9R22.5	650-0617	650-0665	777717-546	777727-343	600-1550	600-0341	550	341
R250F	10R22.5	650-0610	650-0545	777717-520	777727-326	600-1526	600-0327	526	327
R250F	11R22.5	650-0601	650-0539	777717-510	777727-316	600-1509	600-0316	509	316
R250F	11R24.5	650-0591	650-0532	777717-484	777727-300	600-1485	600-0302	485	302
R250F	12R22.5	650-0593	650-0535	777717-490	777727-306	600-1492	600-0306	492	306
R250F	245/70R19.5	650-0633	650-0601	777717-624	777727-392	600-1631	600-0392	631	392
R250F	245/75R22.5	650-0622	650-0666	777717-572	777727-350	600-1563	600-0350	563	350
R250F	265/75R22.5	650-0617	650-0665	777717-546	777727-343	600-1548	600-0341	548	341
R250F	285/75R24.5	650-0601	650-0539	777717-510	777727-312	600-1508	600-0316	508	316
R250F	295/75R22.5	650-0610	650-0545	777717-520	777727-326	600-1523	600-0325	523	325
R250F	295/80R22.5	650-0601	650-0539	777717-500	777727-310	600-1505	600-0314	505	314
R260F	295/75R22.5	650-0610	650-0545	777717-514	777727-326	600-1518	600-0322	518	322
R270SD	285/75R24.5	650-0601	650-0539	777717-500	777727-312	600-1505	600-0314	505	314
R270SD	295/75R22.5	650-0610	650-0542	777717-520	777727-326	600-1522	600-0324	522	324
R293	11R22.5	650-0601	650-0539	777717-510	777727-316	600-1509	600-0316	509	316
R293	11R24.5	650-0591	650-0532	777717-484	777727-300	600-1485	600-0302	485	302
R294	215/75R17.5	650-0677	650-0571	777717-686	777727-424	600-1692	600-0430	692	430
R294	255/70R22.5	650-0626	650-0549	777717-572	777727-359	600-1574	600-0357	574	357
R294	265/70R19.5	650-0630	650-0559	777717-612	777727-381	600-1616	600-0383	616	383
R294	275/70R22.5	650-0618	650-0665	777717-550	777727-343	600-1554	600-0344	554	344
R294	305/75R24.5	650-0595	650-0535	777717-490	777727-306	600-1493	600-0307	493	307

	Tire Size	Stemco Mechanical Hubo Miles	Stemco Mechanical Hubo KM	Veeder-root P/N Miles	Veeder-root P/N KM	DataTrac Miles	DataTrac KM	REV - Mile DataTrac Pro*	REV - KM DataTrac Pro*
R294	315/80R22.5	650-0595	650-0535	777717-490	777727-306	600-1495	600-0307	495	307
R296	11R22.5	650-0605	650-0539	777717-500	777727-312	600-1503	600-0313	503	313
R296	11R24.5	650-0587	650-0532	777717-484	777727-300	600-1481	600-0299	481	299
R296	315/80R22.5	650-0593	650-0535	777717-490	777727-306	600-1491	600-0305	491	305
R299	285/75R24.5	650-0601	650-0539	777717-510	777727-316	600-1508	600-0316	508	316
R299	295/75R22.5	650-0610	650-0545	777717-520	777727-326	600-1523	600-0325	523	325
S169T	455/50R22.5	650-0610	650-0545	777717-520	777727-326	600-1525	600-0326	525	326
Continental									
HT63	215/75R17.5	650-0677	650-0571	777717-700	777727-433	600-1690	600-0429	690	429
HSR	275/80R22.5	650-0610	650-0545	777717-520	777727-326	600-1526	600-0327	526	327
Cooper									
CSD444	11R22.5	650-0598	650-0537	777717-500	777727-311	600-1501	600-0311	501	311
Dayton									
Radial Drive Deep Skid	11R22.5	650-0598	650-0537	777717-500	777727-312	600-1502	600-0312	502	312
Radial Drive Deep Skid	11R24.5	650-0587	650-0528	777717-475	777727-297	600-1479	600-0297	479	297
Radial Drive Deep Skid	285/75R24.5	650-0598	650-0537	777717-500	777727-312	600-1502	600-0312	502	312
Radial Drive Deep Skid	295/75R22.5	650-0608	650-0542	777717-514	777727-326	600-1518	600-0322	518	322
Radial Highway Service	11R22.5	650-0605	650-0541	777717-510	777727-316	600-1513	600-0319	513	319
Radial Highway Service	11R24.5	650-0593	650-0534	777717-484	777727-300	600-1489	600-0304	489	304
Radial Highway Service	285/75R24.5	650-0605	650-0541	777717-510	777727-316	600-1513	600-0319	513	319
Radial Highway Service	295/75R22.5	650-0613	650-0545	777717-520	777727-326	600-1529	600-0328	529	328
Radial Rib All Position	10.00R20	650-0601	650-0539	777717-510	777727-316	600-1509	600-0316	509	316
Radial Rib All Position	11R22.5	650-0601	650-0539	777717-510	777727-316	600-1509	600-0316	509	316
Radial Rib All Position	11R24.5	650-0593	650-0532	777717-484	777727-300	600-1485	600-0302	485	302
Radial Rib All Position	285/75R24.5	650-0601	650-0539	777717-510	777727-316	600-1508	600-0316	508	316
Radial Rib All Position	295/75R22.5	650-0610	650-0545	777717-520	777727-326	600-1523	600-0325	523	325
Dunlop									
SP131	285/75R24.5	650-0605	650-0539	777717-510	777727-316	600-1512	600-0318	512	318
SP181	11R22.5	650-0605	650-0541	777717-510	777727-316	600-1512	600-0318	512	318
SP831	11R24.5	650-0591	650-0532	777717-484	777727-300	600-1483	600-0300	483	300
Firestone									
FD663	10R22.5	650-0608	650-0542	777717-514	777727-326	600-1519	600-0323	519	323
FD663	11R22.5	650-0601	650-0537	777717-500	777727-310	600-1502	600-0312	502	312
FD663	11R24.5	650-0587	650-0528	777717-475	777727-294	600-1479	600-0297	479	297
FD663	12R22.5	650-0593	650-0534	777717-484	777727-300	600-1489	600-0304	489	304
FD663	285/75R24.5	650-0601	650-0539	777717-500	777727-312	600-1502	600-0312	502	312
FD663	295/75R22.5	650-0608	650-0541	777717-514	777727-316	600-1518	600-0322	518	322

	Tire Size	Stemco Mechanical Hubo Miles	Stemco Mechanical Hubo KM	Veeder-root P/N Miles	Veeder-root P/N KM	DataTrac Miles	DataTrac KM	REV - Mile DataTrac Pro*	REV - KM DataTrac Pro*
FS400	315/80R22.5	650-0595	650-0537	777717-494	777727-306	600-1496	600-0308	496	308
FS507	11R22.5	650-0601	650-0539	777717-510	777727-316	600-1509	600-0316	509	316
FS507	11R24.5	650-0597	650-0537	777717-484	777727-300	600-1485	600-0302	485	302
FS507	285/75R24.5	650-0601	650-0539	777717-510	777727-316	600-1508	600-0316	508	316
FS507	295/75R22.5	650-0610	650-0545	777717-520	777727-326	600-1523	600-0325	523	325
FS567	11R22.5	650-0601	650-0539	777717-510	777727-316	600-1509	600-0316	509	316
FS567	11R24.5	650-0597	650-0537	777717-484	777727-300	600-1485	600-0302	485	302
FS567	285/75R24.5	650-0601	650-0539	777717-510	777727-316	600-1508	600-0316	508	316
FS567	295/75R22.5	650-0610	650-0545	777717-520	777727-326	600-1523	600-0325	523	325
FS590	11R22.5	650-0601	650-0539	777717-510	777727-316	600-1509	600-0316	509	316
FS590	11R24.5	650-0597	650-0537	777717-484	777727-300	600-1485	600-0302	485	302
FS590	285/75R24.5	650-0601	650-0539	777717-510	777727-316	600-1509	600-0316	509	316
FS590	295/75R22.5	650-0610	650-0545	777717-520	777727-326	600-1525	600-0326	525	326
FT455	11R22.5	650-0605	650-0541	777717-510	777727-316	600-1513	600-0319	513	319
FT455	11R24.5	650-0593	650-0534	777717-484	777727-300	600-1489	600-0304	489	304
FT455	285/75R24.5	650-0601	650-0539	777717-510	777727-316	600-1510	600-0317	510	317
FT455	295/75R22.5	650-0613	650-0545	777717-520	777727-326	600-1529	600-0328	529	328
HP3000	315/80R22.5	650-0595	650-0537	777717-494	777727-306	600-1497	600-0309	497	309
POWER DRIVE	8.25-20	650-0613	650-0664	777717-539	777727-333	600-1531	600-0330	531	330
POWER DRIVE	9.00-20	650-0601	650-0539	777717-510	777727-316	600-1507	600-0315	507	315
POWER DRIVE	10.00-20	650-0595	650-0537	777717-494	777727-306	600-1494	600-0307	494	307
POWER DRIVE	11.00-20	650-0584	650-0532	777717-490	777727-306	600-1477	600-0297	477	297
POWER DRIVE	11-22.5	650-0595	650-0537	777717-494	777727-306	600-1494	600-0307	494	307
RIB DUPLEX	15-22.5	650-0598	650-0539	777717-510	777727-316	600-1502	600-0312	502	312
RIB DUPLEX	16.5-22.5	650-0593	650-0534	777717-484	777727-300	600-1487	600-0302	487	302
RIB DUPLEX	18-22.5	650-0583	650-0528	777717-468	777727-294	600-1471	600-0292	471	292
S. A. TRACTION DPLX	14-17.5	650-0627	650-0552	777717-588	777727-366	600-1585	600-0363	585	363
S. A. TRACTION DPLX	15-19.5	650-0613	650-0548	777717-539	777727-333	600-1534	600-0332	534	332
S. A. TRACTION DPLX	15-22.5	650-0595	650-0537	777717-494	777727-306	600-1494	600-0307	494	307
S. A. TRACTION DPLX	18-19.5	650-0595	650-0537	777717-500	777727-310	600-1497	600-0309	497	309
S. A. TRACTION DPLX	18-22.5	650-0671	650-0526	777717-465	777727-294	600-1462	600-0287	462	287
S. A. TRACTION ND	8.25-20	650-0610	650-0664	777717-520	777727-326	600-1528	600-0328	528	328
S. A. TRACTION ND	9.00-20	650-0605	650-0541	777717-510	777727-316	600-1512	600-0318	512	318
S. A. TRACTION ND	10.00-20	650-0595	650-0537	777717-494	777727-306	600-1494	600-0307	494	307
S. A. TRACTION ND	11.00-20	650-0593	650-0534	777717-484	777727-300	600-1487	600-0302	487	302
Steeltex Radial RS4	225/75R16 LT	650-0695	650-0578	777717-714	777727-441	600-1721	600-0448	721	448
T546 PSD	9.00R20	650-0610	650-0545	777717-520	777727-326	600-1522	600-0324	522	324
T546 PSD	10.00R20	650-0601	650-0539	777717-510	777727-312	600-1507	600-0315	507	315
T559	9.00R20	650-0613	650-0545	777717-520	777727-326	600-1529	600-0328	529	328
T559	9R22.5	650-0618	650-0665	777717-546	777727-343	600-1551	600-0342	551	342
T559	10.00R20	650-0601	650-0539	777717-510	777727-316	600-1505	600-0314	505	314
T559	10R22.5	650-0613	650-0545	777717-520	777727-326	600-1529	600-0328	529	328
T559	11R22.5	650-0601	650-0539	777717-510	777727-316	600-1510	600-0317	510	317
T559	11R24.5	650-0593	650-0532	777717-484	777727-300	600-1486	600-0302	486	302

	Tire Size	Stemco Mechanical Hubo Miles	Stemco Mechanical Hubo KM	Veeder-root P/N Miles	Veeder-root P/N KM	DataTrac Miles	DataTrac KM	REV - Mile DataTrac Pro*	REV - KM DataTrac Pro*
T575	11.00R20	650-0595	650-0535	777717-490	777727-306	600-1493	600-0307	493	307
T575	11.00R22	650-0583	650-0528	777717-468	777727-294	600-1471	600-0293	471	293
T575	12R22.5	650-0595	650-0535	777717-490	777727-306	600-1493	600-0307	493	307
T575	255/70R22.5	650-0626	650-0549	777717-572	777727-359	600-1574	600-0357	574	357
T819	10.00R20	650-0601	650-0539	777717-510	777727-316	600-1507	600-0315	507	315
T819	11.00R20	650-0595	650-0535	777717-490	777727-306	600-1493	600-0307	493	307
T819	11.00R22	650-0583	650-0526	777717-468	777727-294	600-1470	600-0292	470	292
T819	11R22.5	650-0601	650-0539	777717-510	777727-316	600-1505	600-0314	505	314
T819	11R24.5	650-0587	650-0532	777717-484	777727-300	600-1482	600-0299	482	299
T819	12.00R20	650-0583	650-0526	777717-468	777727-294	600-1469	600-0291	469	291
T819	315/80R22.5	650-0595	650-0535	777717-490	777727-306	600-1492	600-0306	492	306
T831	10.00R20	650-0595	650-0537	777717-494	777727-306	600-1497	600-0309	497	309
T831	11.00R20	650-0591	650-0532	777717-484	777727-300	600-1483	600-0300	483	300
T831	11R22.5	650-0598	650-0537	777717-490	777727-306	600-1496	600-0308	496	308
T831	11R24.5	650-0583	650-0528	777717-468	777727-294	600-1472	600-0293	472	293
T831	12R22.5	650-0587	650-0532	777717-484	777727-300	600-1482	600-0299	482	299
T839	385/65R22.5	650-0595	650-0535	777717-490	777727-306	600-1495	600-0307	495	307
T839	425/65R22.5	650-0583	650-0528	777717-468	777727-294	600-1472	600-0293	472	293
T839	445/65R22.5	650-0581	650-0525	777717-465	777727-294	600-1460	600-0286	460	286
TRANSPORT 1	8.25-20	650-0616	650-0548	777717-546	777727-343	600-1546	600-0339	546	339
TRANSPORT 1	9.00-20	650-0605	650-0541	777717-520	777727-326	600-1523	600-0325	523	325
TRANSPORT 1	10.00-20	650-0595	650-0537	777717-510	777727-316	600-1507	600-0315	507	315
TRANSPORT 1	10-22.5	650-0608	650-0545	777717-520	777727-326	600-1523	600-0325	523	325
TRANSPORT 1	11.00-20	650-0591	650-0532	777717-494	777727-306	600-1497	600-0309	497	309
TRANSPORT 1	11-22.5	650-0595	650-0537	777717-510	777727-316	600-1507	600-0315	507	315
TRANSPORT 1	11-24.5	650-0583	650-0528	777717-484	777727-300	600-1484	600-0301	484	301
TRANSPORT DPLX	14-17.5	650-0627	650-0552	777717-588	777727-366	600-1588	600-0366	588	366
TRANSPORT DPLX	15-19.5	650-0616	650-0548	777717-546	777727-333	600-1543	600-0337	543	337
TRANSPORT RIB TR	10.00-20	650-0601	650-0539	777717-500	777727-310	600-1504	600-0313	504	313
TRANSPORT RIB TR	11-22.5	650-0595	650-0537	777717-510	777727-316	600-1507	600-0315	507	315
UT2000	12R22.5	650-0593	650-0534	777717-490	777727-306	600-1491	600-0305	491	305
XR4	10R17.5HC	650-0630	650-0554	777717-612	777727-381	600-1607	600-0377	607	377

General

Ameri LP70	255-70R22.5	650-0672	650-0549	777717-572	777727-359	600-1575	600-0358	575	358
D460	11R24.5	650-0587	650-0532	777717-475	777727-294	600-1481	600-0299	481	299
D460	295/75R22.5	650-0608	650-0542	777717-510	777727-326	600-1519	600-0323	519	323
General Rib ST	295/75R22.5	650-0610	650-0545	777717-520	777727-326	600-1526	600-0327	526	327
S370	11R22.5	650-0601	650-0539	777717-500	777727-312	600-1508	600-0316	508	316

Goodyear

G104	255/70R22.5	650-0627	650-0552	777717-579	777727-359	600-1579	600-0360	579	360
G114	215/75R17.5	650-0677	650-0571	777717-686	777727-424	600-1690	600-0429	690	429
G114	235/75R17.5	650-0704	NA	NA	777727-416	600-1664	600-0412	664	412

	Tire Size	Stemco Mechanical Hubo Miles	Stemco Mechanical Hubo KM	Veeder-root P/N Miles	Veeder-root P/N KM	DataTrac Miles	DataTrac KM	REV - Mile DataTrac Pro*	REV - KM DataTrac Pro*
G114	255/70R22.5	650-0627	650-0552	777717-572	777727-359	600-1579	600-0360	579	360
G114LT	10.00R15TR	650-0627	650-0552	777717-572	777727-359	600-1579	600-0360	579	360
G114LT	10R17.5 H	650-0631	NA	777717-612	777727-381	600-1626	600-0389	626	389
G114LT	11R17.5HC	650-0627	650-0552	777717-572	777727-359	600-1580	600-0361	580	361
G114LT	8.25R15TR	650-0633	650-0561	777717-624	777727-392	600-1633	600-0394	633	394
G114LT	9R17.5HC	650-0633	650-0561	777717-624	777727-392	600-1633	600-0394	633	394
G124	10.00R20	650-0601	650-0539	777717-500	777727-310	600-1505	600-0314	505	314
G124	10R22.5	650-0608	650-0542	777717-514	777727-326	600-1519	600-0323	519	323
G124	11.00R20	650-0593	650-0534	777717-484	777727-300	600-1488	600-0303	488	303
G124	11R22.5	650-0601	650-0539	777717-500	777727-310	600-1505	600-0314	505	314
G124	11R24.5	650-0587	650-0532	777717-475	777727-300	600-1482	600-0299	482	299
G124	12R22.5	650-0593	650-0534	777717-484	777727-300	600-1488	600-0303	488	303
G124	245/75R22.5	650-0622	650-0549	777717-572	777727-350	600-1564	600-0351	564	351
G124	255/70R22.5	650-0622	650-0549	777717-572	777727-359	600-1572	600-0356	572	356
G124	265/70R19.5	650-0630	650-0559	777717-612	777727-381	600-1615	600-0382	615	382
G124	265/75R22.5	650-0616	650-0548	777717-539	777727-343	600-1544	600-0338	544	338
G124	285/75R24.5	650-0601	650-0539	777717-500	777727-310	600-1503	600-0313	503	313
G124	295/75R22.5	650-0608	650-0542	777717-514	777727-326	600-1518	600-0322	518	322
G124	9.00R20	650-0608	650-0542	777717-520	777727-326	600-1519	600-0323	519	323
G124	9R22.5	650-0617	650-0548	777717-539	777727-343	600-1545	600-0339	545	339
G124-LH	11R22.5	650-0601	650-0539	777717-500	777727-310	600-1505	600-0314	505	314
G124-LH	11R24.5	650-0587	650-0532	777717-475	777727-300	600-1482	600-0299	482	299
G124-LH	285/75R24.5	650-0601	650-0539	777717-500	777727-310	600-1503	600-0313	503	313
G124-LH	295/75R22.5	650-0608	650-0542	777717-514	777727-326	600-1518	600-0322	518	322
G124LT	225/70R19.5	650-0634	650-0563	777717-650	777727-400	600-1651	600-0405	651	405
G124LT	245/70R19.5	650-0633	650-0561	777717-637	777727-392	600-1635	600-0395	635	395
G133LT	8R19.5	650-0633	650-0561	777717-637	777727-393	600-1635	600-0395	635	395
G133LT	LT215/85R16	650-0677	650-0571	777717-686	777727-424	600-1695	600-0432	695	432
G133LT	LT225/75R16	650-0695	650-0578	777717-728	777727-450	600-1719	600-0447	719	447
G133LT	LT235/85R16	650-0690	650-0567	777717-676	777727-424	600-1683	600-0425	683	425
G133LT	LT245/75R16	650-0690	650-0567	777717-676	777727-424	600-1683	600-0425	683	425
G143	11R22.5	650-0595	650-0537	777717-500	777727-310	600-1498	600-0310	498	310
G143	11R24.5	650-0584	650-0528	777717-475	777727-294	600-1475	600-0295	475	295
G149RSA	11R22.5	650-0601	650-0539	777717-500	777727-316	600-1507	600-0315	507	315
G152	B305/85R22.5	650-0593	650-0532	777717-484	777727-300	600-1485	600-0302	485	302
G159	11.00R20	650-0593	650-0534	777717-490	777727-300	600-1490	600-0304	490	304
G159	255/70R22.5	650-0672	650-0549	777717-572	777727-359	600-1575	600-0358	575	358
G159	265/70R19.5	650-0631	650-0559	777717-612	777727-381	600-1620	600-0385	620	385
G159	365/80R20	650-0593	650-0534	777717-484	777727-300	600-1489	600-0304	489	304
G159	9.00R20	650-0610	650-0545	777717-520	777727-326	600-1523	600-0325	523	325
G159-22	10R22.5	650-0610	650-0545	777717-520	777727-326	600-1525	600-0326	525	326
G159-22	12R22.5	650-0593	650-0534	777717-484	777727-300	600-1490	600-0304	490	304
G159-22	245/75R22.5	650-0640	650-0549	777717-572	777727-350	600-1569	600-0354	569	354
G159-22	265/75R22.5	650-0616	650-0548	777717-539	777727-343	600-1544	600-0338	544	338

	Tire Size	Stemco Mechanical Hubo Miles	Stemco Mechanical Hubo KM	Veeder-root P/N Miles	Veeder-root P/N KM	DataTrac Miles	DataTrac KM	REV - Mile DataTrac Pro*	REV - KM DataTrac Pro*
G159-22	275/70R22.5	650-0618	650-0665	777717-572	777727-343	600-1560	600-0348	560	348
G159-22	9R22.5	650-0617	650-0665	777717-546	777727-343	600-1548	600-0341	548	341
G159A	11R22.5	650-0601	650-0539	777717-510	777727-312	600-1507	600-0315	507	315
G159A	11R24.5	650-0591	650-0532	777717-484	777727-300	600-1483	600-0300	483	300
G159A	275/80R22.5	650-0610	650-0545	777717-520	777727-326	600-1523	600-0325	523	325
G159A	285/75R24.5	650-0601	650-0539	777717-510	777727-316	600-1509	600-0316	509	316
G159A	295/75R22.5	650-0608	650-0545	777717-514	777727-326	600-1521	600-0324	521	324
G159A-Metro	10.00R20	650-0601	650-0539	777717-510	777727-312	600-1507	600-0315	507	315
G159A-Metro	11R22.5	650-0601	650-0539	777717-510	777727-312	600-1507	600-0315	507	315
G159A-Metro	11R24.5	650-0591	650-0532	777717-484	777727-300	600-1483	600-0300	483	300
G159A-Metro	275/80R22.5	650-0610	650-0545	777717-520	777727-326	600-1523	600-0325	523	325
G159A-Metro	285/75R24.5	650-0601	650-0539	777717-510	777727-316	600-1509	600-0316	509	316
G159A-Metro	295/75R22.5	650-0610	650-0545	777717-514	777727-326	600-1523	600-0325	523	325
G159LT	225/70R19.5	650-0634	650-0563	777717-650	777727-400	600-1657	600-0408	657	408
G159LT	245/70R19.5	650-0673	650-0561	777717-637	777727-392	600-1639	600-0397	639	397
G159LT	8.75R16.5	NA	650-0580	777717-728	777727-450	600-1731	600-0455	731	455
G159LT	8R19.5	650-0673	650-0561	777717-637	777727-392	600-1637	600-0396	637	396
G159LT	LT215/85R16	650-0677	650-0571	777717-686	777727-424	600-1695	600-0432	695	432
G159LT	LT225/75R16	650-0695	650-0578	777717-714	777727-441	600-1721	600-0448	721	448
G159LT	LT235/85R16	650-0690	650-0567	777717-686	777727-424	600-1688	600-0427	688	427
G159LT	LT245/75R16	650-0690	650-0567	777717-686	777727-424	600-1688	600-0427	688	427
G164RTD	10.00R20	650-0601	650-0539	777717-510	777727-312	600-1503	600-0313	503	313
G164RTD	11R22.5	650-0601	650-0539	777717-510	777727-312	600-1503	600-0313	503	313
G164RTD	11R24.5	650-0587	650-0532	777717-475	777727-294	600-1480	600-0298	480	298
G164RTD	285/75R24.5	650-0601	650-0539	777717-500	777727-310	600-1504	600-0313	504	313
G164RTD	295/75R22.5	650-0608	650-0542	777717-514	777727-326	600-1519	600-0323	519	323
G167	11.00R20	650-0593	650-0532	777717-484	777727-300	600-1486	600-0302	486	302
G167	12R22.5	650-0593	650-0532	777717-484	777727-300	600-1486	600-0302	486	302
G167A	11R22.5	650-0598	650-0537	777717-500	777727-310	600-1501	600-0311	501	311
G167A	11R24.5	650-0584	650-0528	777717-475	777727-300	600-1478	600-0297	478	297
G167A	285/75R24.5	650-0598	650-0537	777717-500	777727-310	600-1499	600-0310	499	310
G167A	295/75R22.5	650-0605	650-0541	777717-514	777727-326	600-1515	600-0320	515	320
G169	275/70R22.5	650-0619	650-0665	777717-550	777727-343	600-1558	600-0347	558	347
G171LT	8R19.5	650-0633	650-0561	777717-624	777727-392	600-1629	600-0391	629	391
G171LT	LT215/85R16	650-0690	650-0567	777717-676	777727-424	600-1686	600-0426	686	426
G171LT	LT235/85R16	650-0688	650-0567	777717-676	777727-416	600-1681	600-0423	681	423
G175	11R24.5	650-0584	650-0528	777717-475	777727-294	600-1473	600-0294	473	294
G177	10.00R20	650-0595	650-0537	777717-494	777727-306	600-1497	600-0309	497	309
G177	11.00R20	650-0587	650-0532	777717-484	777727-300	600-1481	600-0299	481	299
G177	11.00R22	650-0581	650-0525	777717-465	777727-294	600-1460	600-0286	460	286
G177	11R22.5	650-0595	650-0537	777717-494	777727-306	600-1497	600-0309	497	309
G177	11R24.5	650-0584	650-0528	777717-475	777727-294	600-1474	600-0295	474	295
G177	12.00R24	NA	650-0519	777717-424	777727-273	600-1425	600-0264	425	264
G177	12R22.5	650-0587	650-0532	777717-484	777727-300	600-1481	600-0299	481	299

	Tire Size	Stemco Mechanical Hubo Miles	Stemco Mechanical Hubo KM	Veeder-root P/N Miles	Veeder-root P/N KM	DataTrac Miles	DataTrac KM	REV - Mile DataTrac Pro*	REV - KM DataTrac Pro*
G177	12R24.5	650-0581	650-0525	777717-465	777727-294	600-1460	600-0286	460	286
G178SS	385/65R22.5	650-0593	650-0534	777717-490	777727-306	600-1489	600-0304	489	304
G178SS	425/65R22.5	650-0583	650-0526	777717-465	777727-294	600-1468	600-0291	468	291
G178SS	445/65R22.5	650-0579	650-0523	777717-465	777727-294	600-1455	600-0282	455	282
G186	10.00R20	650-0601	650-0537	777717-500	777727-310	600-1503	600-0313	503	313
G186	10R22.5	650-0608	650-0545	777717-514	777727-326	600-1521	600-0324	521	324
G186	11R22.5	650-0601	650-0537	777717-500	777727-310	600-1503	600-0313	503	313
G186	11R24.5	650-0587	650-0528	777717-475	777727-300	600-1480	600-0298	480	298
G186	9.00R20	650-0608	650-0545	777717-514	777727-326	600-1521	600-0324	521	324
G244MSD	11.00R22	650-0583	650-0526	777717-465	777727-294	600-1462	600-0287	462	287
G244MSD	11R22.5	650-0598	650-0537	777717-500	777727-310	600-1501	600-0311	501	311
G244MSD	11R24.5	650-0584	650-0528	777717-475	777727-300	600-1478	600-0297	478	297
G244MSD	12R22.5	650-0591	650-0532	777717-484	777727-300	600-1483	600-0300	483	300
G286	10.00R20	650-0598	650-0537	777717-500	777727-310	600-1501	600-0311	501	311
G286	11.00R20	650-0593	650-0534	777717-484	777727-300	600-1489	600-0304	489	304
G286	11.00R22	650-0583	650-0526	777717-465	777727-294	600-1467	600-0290	467	290
G286	11.00R24	650-0579	NA	777717-450	777727-294	600-1447	600-0278	447	278
G286	11R22.5	650-0598	650-0537	777717-500	777727-310	600-1502	600-0312	502	312
G286	11R24.5	650-0587	650-0528	777717-475	777727-294	600-1479	600-0297	479	297
G286	12.00R24	650-0576	650-0521	777717-433	777727-294	600-1435	600-0270	435	270
G286	12R22.5	650-0593	650-0534	777717-484	777727-300	600-1489	600-0304	489	304
G286	12R24.5	650-0583	650-0526	777717-465	777727-294	600-1467	600-0290	467	290
G286	14.00R20	650-0576	650-0521	777717-433	777727-294	600-1434	600-0269	434	269
G286	315/80R22.5	650-0593	650-0535	777717-490	777727-306	600-1490	600-0304	490	304
G286HSS	315/80R22.5	650-0593	650-0535	777717-490	777727-306	600-1489	600-0304	489	304
G286SS	385/65R22.5	650-0595	650-0535	777717-290	777727-306	600-1496	600-0308	496	308
G286SS	425/65R22.5	650-0584	650-0528	777717-475	777727-294	600-1475	600-0295	475	295
G286SS	445/65R22.5	650-0581	650-0525	777717-465	777727-294	600-1461	600-0286	461	286
G291	285/70R19.5	650-0629	NA	777717-588	777727-366	600-1599	600-0372	599	372
G291	315/80R22.5	650-0595	650-0537	777717-494	777727-310	600-1497	600-0309	497	309
G291	8.5R17.5	650-0704	NA	777717-676	777727-416	600-1666	600-0414	666	414
G291LT	8R17.5LT	650-0690	650-0567	777717-676	777727-424	600-1683	600-0425	683	425
G302FED	11R24.5	650-0584	650-0528	777717-475	777727-294	600-1478	600-0297	478	297
G302FED	285/75R24.5	650-0601	650-0537	777717-500	777727-310	600-1503	600-0313	503	313
G302FED	295/75R22.5	650-0608	650-0541	777717-510	777727-316	600-1510	600-0317	510	317
G314	11R22.5	650-0605	650-0541	777717-510	777727-312	600-1512	600-0318	512	318
G314	11R24.5	650-0593	650-0534	777717-484	777727-300	600-1488	600-0303	488	303
G314	285/75R24.5	650-0605	650-0541	777717-510	777727-316	600-1514	600-0320	514	320
G314	295/75R22.5	650-0613	650-0545	777717-520	777727-326	600-1529	600-0328	529	328
G328	11R22.5	650-0598	650-0537	777717-500	777727-310	600-1499	600-0310	499	310
G328	11R24.5	650-0584	650-0528	777717-475	777727-294	600-1476	600-0296	476	296
G328	285/75R24.5	650-0598	650-0537	777717-500	777727-310	600-1501	600-0311	501	311
G328	295/75R22.5	650-0605	650-0541	777717-514	777727-326	600-1515	600-0320	515	320
G357	11R22.5	650-0601	650-0539	777717-510	777727-316	600-1509	600-0316	509	316

	Tire Size	Stemco Mechanical Hubo Miles	Stemco Mechanical Hubo KM	Veeder-root P/N Miles	Veeder-root P/N KM	DataTrac Miles	DataTrac KM	REV - Mile DataTrac Pro*	REV - KM DataTrac Pro*
G357	11R24.5	650-0591	650-0532	777717-484	777727-300	600-1485	600-0302	485	302
G357	285/75R24.5	650-0601	650-0539	777717-510	777727-316	600-1509	600-0316	509	316
G357	295/75R22.5	650-0610	650-0545	777717-520	777727-326	600-1525	600-0326	525	326
G362	11R22.5	650-0598	650-0537	777717-500	777727-310	600-1501	600-0311	501	311
G362	11R24.5	650-0584	650-0528	777717-475	777727-300	600-1478	600-0297	478	297
G362	285/75R24.5	650-0598	650-0537	777717-500	777727-310	600-1501	600-0311	501	311
G362	295/75R22.5	650-0605	650-0541	777717-514	777727-326	600-1515	600-0320	515	320
G372 LHD	11R22.5	650-0598	650-0537	777717-500	777727-310	600-1499	600-0310	499	310
G372 LHD	11R24.5	650-0584	650-0528	777717-475	777727-300	600-1476	600-0296	476	296
G372 LHD	285/75R24.5	650-0598	650-0537	777717-500	777727-310	600-1497	600-0309	497	309
G372 LHD	295/75R22.5	650-0605	650-0541	777717-514	777727-316	600-1512	600-0318	512	318
G386	1200R20	650-0584	650-0528	777717-475	777727-300	600-1478	600-0297	478	297
G391	295/80R22.5	650-0601	650-0539	777717-510	777727-316	600-1509	600-0316	509	316
G391	315/80R22.5	650-0595	650-0537	777717-494	777727-310	600-1496	600-0308	496	308
G397LHS	11R22.5	650-0601	650-0539	777717-510	777727-316	600-1508	600-0316	508	316
G397LHS	11R24.5	650-0591	650-0532	777717-484	777727-300	600-1485	600-0302	485	302
G397LHS	285/75R24.5	650-0601	650-0539	777717-510	777727-316	600-1509	600-0316	509	316
G397LHS	295/75R22.5	650-0610	650-0545	777717-520	777727-326	600-1525	600-0326	525	326
G647RSS	225/70R19.5	650-0634	650-0563	777717-650	777727-400	600-1655	600-0407	655	407
G647RSS	225/75R16	650-0695	650-0578	777717-728	777727-450	600-1719	600-0447	719	447
G670RV	225/70R19.5	650-0675	NA	777717-650	777727-400	600-1659	600-0410	659	410
G670RV	245/70R19.5	650-0673	650-0563	777717-637	777727-400	600-1641	600-0398	641	398
GT11	P225/70R15	650-0699	650-0589	777717-775	777727-475	600-1772	600-0480	772	480
Intercity Cruiser	B315/80R22.5	650-0595	650-0534	777717-490	777727-300	600-1490	600-0304	490	304
Marathon	205/75R14	650-0700	650-0603	777717-806	777727-500	600-1811	600-0504	811	504
RHS	315/80R22.5	650-0595	650-0537	777717-494	777727-310	600-1495	600-0307	495	307
G286 Supersingle	425/65R22.5	650-0584	650-0528	777717-475	777727-294	600-1475	600-0295	475	295
UJELP	285/75R24.5	650-0601	650-0539	777717-510	777727-316	600-1510	600-0317	510	317
WINGAPR	11R22.5	650-0601	650-0539	777717-510	777727-316	600-1508	600-0316	508	316
WINGAPR	11R24.5	650-0591	650-0532	777717-484	777727-300	600-1484	600-0301	484	301
WINGAPR	285/75R24.5	650-0601	650-0539	777717-510	777727-316	600-1510	600-0317	510	317
WINGAPR	295/75R22.5	650-0610	650-0545	777717-520	777727-326	600-1525	600-0326	525	326
WINGDTR	11R24.5	650-0587	650-0532	777717-475	777727-300	600-1480	600-0298	480	298
WINGDTR	285/75R24.5	650-0601	650-0539	777717-500	777727-310	600-1504	600-0313	504	313
WINGDTR	295/75R22.5	650-0608	650-0542	777717-520	777727-326	600-1519	600-0323	519	323
Kelly									
KDA	11R22.5	650-0598	650-0537	777717-500	777727-311	600-1501	600-0311	501	311
KSA	285/75R24.5	650-0601	650-0539	777717-510	777727-316	600-1510	600-0317	510	317
KT	255/70R22.5	650-0627	650-0549	777717-572	777727-359	600-1575	600-0358	575	358
KT	295/75R22.5	650-0610	650-0545	777717-520	777727-326	600-1527	600-0328	527	328
KTSA	11R22.5	650-0601	650-0539	777717-510	777727-316	600-1508	600-0316	508	316
Kumho									

	Tire Size	Stemco Mechanical Hubo Miles	Stemco Mechanical Hubo KM	Veeder-root P/N Miles	Veeder-root P/N KM	DataTrac Miles	DataTrac KM	REV - Mile DataTrac Pro*	REV - KM DataTrac Pro*
945A	11R24.5	650-0587	650-0532	777717-484	777727-300	600-1481	600-0299	481	299
Michelin									
961	255/70R22.5	650-0627	650-0552	777717-572	777727-359	600-1577	600-0359	577	359
DR434	10.00R20	650-0601	650-0539	777717-500	777727-312	600-1503	600-0313	503	313
DR434	10R22.5	650-0608	650-0545	777717-520	777727-326	600-1522	600-0324	522	324
DR434	11.00R20	650-0595	650-0535	777717-490	777727-306	600-1492	600-0306	492	306
DR434	11.00R22	650-0583	650-0526	777717-468	777727-306	600-1467	600-0290	467	290
DR434	11R22.5	650-0601	650-0537	777717-500	777727-310	600-1504	600-0313	504	313
DR434	11R24.5	650-0587	650-0528	777717-475	777727-300	600-1480	600-0298	480	298
DR434	275/80R22.5	650-0610	650-0545	777717-520	777727-326	600-1519	600-0323	519	323
DR434	275/80R24.5	650-0601	650-0537	777717-500	777727-310	600-1503	600-0313	503	313
DR434	9.00R20	650-0610	650-0545	777717-520	777727-326	600-1523	600-0325	523	325
DR444	11R22.5	650-0601	650-0539	777717-500	777727-310	600-1503	600-0313	503	313
DR444	11R24.5	650-0584	650-0532	777717-475	777727-297	600-1478	600-0297	478	297
DR444	275/80R22.5	650-0608	650-0542	777717-514	777727-326	600-1518	600-0322	518	322
DR444	275/80R24.5	650-0598	650-0537	777717-500	777727-312	600-1502	600-0312	502	312
DR665	10.00R20	650-0598	650-0537	777717-500	777727-310	600-1499	600-0310	499	310
DR665	11R22.5	650-0598	650-0537	777717-500	777727-312	600-1502	600-0312	502	312
DR665	11R24.5	650-0584	650-0532	777717-475	777727-297	600-1478	600-0297	478	297
Energy XTA	235/75R17.5	650-0676	650-0567	777717-676	777727-416	600-1679	600-0422	679	422
Energy XTA	245/70R17.5	650-0676	650-0567	777717-676	777727-416	600-1679	600-0421	679	421
Energy XTA	265/70R19.5	650-0631	650-0559	777717-612	777727-381	600-1619	600-0385	619	385
Energy XTA	385/65R22.5	650-0598	650-0537	777717-500	777727-311	600-1501	600-0311	501	311
ST220	11R22.5	650-0601	650-0539	777717-510	777727-316	600-1509	600-0316	509	316
ST220	11R24.5	650-0591	650-0532	777717-484	777727-300	600-1485	600-0302	485	302
ST230	10.00R20	650-0601	650-0539	777717-510	777727-316	600-1508	600-0316	508	316
ST230	10R22.5	650-0610	650-0545	777717-520	777727-326	600-1528	600-0328	528	328
ST230	11.00R20	650-0595	650-0537	777717-494	777727-310	600-1497	600-0309	497	309
ST230	11.00R22	650-0584	650-0528	777717-468	777727-294	600-1472	600-0293	472	293
ST230	11R22.5	650-0601	650-0539	777717-510	777727-316	600-1512	600-0318	512	318
ST230	11R24.5	650-0591	650-0532	777717-484	777727-300	600-1485	600-0302	485	302
ST230	12R22.5	650-0595	650-0537	777717-494	777727-306	600-1496	600-0308	496	308
ST230	255/70R22.5	650-0672	650-0549	777717-572	777727-359	600-1576	600-0358	576	358
ST230	275/80R22.5	650-0610	650-0545	777717-520	777727-326	600-1526	600-0327	526	327
ST230	315/80R22.5	650-0595	650-0535	777717-494	777727-306	600-1496	600-0308	496	308
ST230	9.00R20	650-0613	650-0545	777717-520	777727-326	600-1528	600-0328	528	328
ST234	11R22.5	650-0601	650-0539	777717-510	777727-316	600-1512	600-0318	512	318
ST234	11R24.5	650-0591	650-0532	777717-484	777727-300	600-1485	600-0302	485	302
ST234	275/80R22.5	650-0610	650-0545	777717-520	777727-326	600-1526	600-0327	526	327
ST234	275/80R24.5	650-0601	650-0539	777717-510	777727-316	600-1509	600-0316	509	316
ST234	315/80R22.5	650-0595	650-0537	777717-494	777727-310	600-1496	600-0308	496	308
ST565	10.00R20	650-0601	650-0539	777717-510	777717-316	600-1506	600-0315	506	315
ST565	11.00R20	650-0595	650-0535	777717-494	777727-306	600-1495	600-0308	495	308

	Tire Size	Stemco Mechanical Hubo Miles	Stemco Mechanical Hubo KM	Veeder-root P/N Miles	Veeder-root P/N KM	DataTrac Miles	DataTrac KM	REV - Mile DataTrac Pro*	REV - KM DataTrac Pro*
ST565	11.00R22	650-0584	650-0528	777717-468	777727-294	600-1471	600-0292	471	292
ST565	11R22.5	650-0601	650-0539	777717-510	777727-316	600-1509	600-0316	509	316
ST565	11R24.5	650-0591	650-0532	777717-484	777727-300	600-1485	600-0302	485	302
ST565	385/65R22.5	650-0598	650-0537	777717-500	777727-310	600-1499	600-0310	499	310
ST565	425/65R22.5	650-0584	650-0528	777717-468	777727-294	600-1473	600-0294	473	294
ST565	445/65R22.5	650-0583	650-0526	777717-465	777727-294	600-1462	600-0287	462	287
TR134	11R22.5	650-0605	650-0541	777717-510	777727-316	600-1513	600-0319	513	319
TR134	11R24.5	650-0593	650-0534	777717-490	777727-300	600-1489	600-0304	489	304
TR134	275/80R22.5	650-0613	650-0664	777717-539	777727-333	600-1534	600-0332	534	332
TR134	275/80R24.5	650-0605	650-0541	777717-514	777727-316	600-1515	600-0320	515	320
X One XDA	445/50R22.5	650-0610	650-0545	777717-525	777727-326	600-1523	600-0325	523	325
X One XDA-HT	455/55R22.5	650-0595	650-0535	777717-494	777727-306	600-1497	600-0309	497	309
X One XTA	445/50R22.5	650-0613	650-0664	777717-539	777727-333	600-1534	600-0332	534	332
X One XTE	445/50R22.5	650-0613	650-0664	777717-525	777727-326	600-1530	600-0329	530	329
X One XTE	455/55R22.5	650-0601	650-0537	777717-500	777727-310	600-1504	600-0313	504	313
XD2	255/70R22.5	650-0640	650-0549	777717-572	777727-350	600-1567	600-0352	567	352
XD2	285/70R19.5	650-0629	NA	777717-588	777727-366	600-1592	600-0368	592	368
XD4	11R22.5	650-0598	650-0537	777717-500	777727-310	600-1501	600-0311	501	311
XD4	11R24.5	650-0587	650-0528	777717-475	777727-294	600-1480	600-0298	480	298
XD4	275/80R22.5	650-0605	650-0541	777717-510	777727-316	600-1516	600-0321	516	321
XD4	275/80R24.5	650-0598	650-0537	777717-500	777727-310	600-1501	600-0311	501	311
XDA	275/70R22.5	650-0617	650-0665	777717-546	777727-343	600-1550	600-0342	550	342
XDA	305/75R24.5	650-0595	650-0534	777717-490	777727-300	600-1490	600-0304	490	304
XDA2	11R22.5	650-0598	650-0537	777717-500	777727-310	600-1502	600-0312	502	312
XDA2	11R24.5	650-0587	650-0528	777717-475	777727-294	600-1480	600-0298	480	298
XDA2	255/70R22.5	650-0626	650-0549	777717-572	777727-350	600-1566	600-0352	566	352
XDA2	275/80R22.5	650-0605	650-0541	777717-510	777727-326	600-1519	600-0323	519	323
XDA2	275/80R24.5	650-0598	650-0537	777717-500	777727-310	600-1502	600-0312	502	312
XDA-HT	11R22.5	650-0598	650-0537	777717-500	777727-311	600-1501	600-0311	501	311
XDA-HT	11R24.5	650-0587	650-0528	777717-475	777727-300	600-1480	600-0298	480	298
XDA-HT	275/80R22.5	650-0605	650-0541	777717-514	777727-316	600-1515	600-0320	515	320
XDA-HT	275/80R24.5	650-0598	650-0537	777717-500	777727-311	600-1501	600-0311	501	311
XDE A/T	11R22.5	650-0598	650-0537	777717-500	777727-311	600-1500	600-0311	500	311
XDE A/T	11R24.5	650-0584	650-0528	777717-475	777727-294	600-1476	600-0296	476	296
XDE A/T	12R22.5	650-0593	650-0534	777717-490	777727-300	600-1489	600-0304	489	304
XDE M/S	10R22.5	650-0610	650-0545	777717-525	777727-326	600-1523	600-0325	523	325
XDE M/S	11R22.5	650-0601	650-0537	777717-500	777727-310	600-1504	600-0313	504	313
XDE M/S	11R24.5	650-0587	650-0528	777717-475	777727-300	600-1479	600-0297	479	297
XDE M/S	12R22.5	650-0593	650-0534	777717-490	777727-300	600-1489	600-0304	489	304
XDE M/S	225/70R19.5	650-0634	650-0563	777717-637	777727-400	600-1647	600-0402	647	402
XDE M/S	235/80R22.5	650-0622	NA	777717-550	777727-350	600-1559	600-0348	559	348
XDE M/S	245/70R19.5	650-0631	650-0559	777717-624	777727-381	600-1624	600-0388	624	388
XDE M/S	255/80R22.5	650-0616	650-0548	777717-546	777727-333	600-1544	600-0338	544	338
XDE M/S	275/80R22.5	650-0608	650-0545	777717-514	777727-326	600-1520	600-0323	520	323

	Tire Size	Stemco Mechanical Hubo Miles	Stemco Mechanical Hubo KM	Veeder-root P/N Miles	Veeder-root P/N KM	DataTrac Miles	DataTrac KM	REV - Mile DataTrac Pro*	REV - KM DataTrac Pro*
XDE M/S	9R22.5	650-0617	650-0548	777717-546	777727-343	600-1547	600-0340	547	340
XDE1	215/75R17.5	650-0677	650-0571	777717-686	777727-424	600-1690	600-0429	690	429
XDE1	245/70R17.5	650-0676	650-0567	777717-676	777727-416	600-1671	600-0417	671	417
XDE2(Eur)	245/70R19.5	650-0633	650-0561	777717-624	777727-392	600-1628	600-0390	628	390
XDHT	11R22.5	650-0598	650-0537	777717-500	777727-312	600-1502	600-0312	502	312
XDHT	11R24.5	650-0587	650-0528	777717-475	777727-294	600-1479	600-0298	479	298
XDHT	275/80R22.5	650-0608	650-0541	777717-510	777727-326	600-1517	600-0321	517	321
XDHT	275/80R24.5	650-0598	650-0537	777717-500	777727-312	600-1502	600-0312	502	312
XDL	10.00R20	650-0595	650-0535	777717-494	777727-306	600-1495	600-0308	495	308
XDL	12.00R24	650-0570	650-0519	777717-424	NA	600-1425	600-0264	425	264
XDN	11R22.5	650-0601	650-0537	777717-500	777727-310	600-1505	600-0314	505	314
XDN	11R24.5	650-0587	650-0528	777717-475	777727-294	600-1481	600-0299	481	299
XDN	275/80R22.5	650-0608	650-0545	777717-514	777727-326	600-1521	600-0324	521	324
XDN	275/80R24.5	650-0601	650-0539	777717-510	777727-316	600-1506	600-0315	506	315
XDN	315/80R22.5	650-0593	650-0534	777717-484	777727-300	600-1489	600-0304	489	304
XDN GRIP	12R22.5	650-0593	650-0534	777717-484	777727-300	600-1489	600-0304	489	304
XDR	30.00R51	NA	650-0505	NA	NA	600-1183	600-0114	183	114
XDR	33.00R51	NA	NA	NA	NA	600-1175	600-0108	175	108
XDR	37.00R57	650-0509	650-0503	NA	NA	600-1154	600-0096	154	96
XDR	40.00R57	NA	NA	NA	NA	600-1148	600-0092	148	92
XDS	11R22.5	650-0601	650-0537	777717-500	777727-310	600-1503	600-0312	503	312
XDS	11R24.5	650-0587	650-0528	777717-475	777727-300	600-1479	600-0298	479	298
XDS	12R22.5	650-0593	650-0534	777717-490	777727-306	600-1491	600-0305	491	305
XDU	235/80R22.5	650-0622	650-0666	777717-572	777727-350	600-1562	600-0349	562	349
XDU	255/80R22.5	650-0617	650-0665	777717-546	777727-343	600-1548	600-0341	548	341
XDY	315/80R22.5	650-0593	650-0534	777717-484	777727-300	600-1489	600-0304	489	304
XDY-2	11R22.5	650-0598	650-0537	777717-500	777727-311	600-1501	600-0311	501	311
XDY-2	11R24.5	650-0584	650-0528	777717-475	777727-294	600-1476	600-0296	476	296
XDY-2	12R24.5	650-0671	650-0526	777717-465	777727-294	600-1465	600-0289	465	289
XKB	55/80R63	NA	NA	NA	NA	600-1139	600-0086	139	86
XKD1	24.00R35	650-0517	650-0508	NA	NA	600-1242	600-0151	242	151
XKD1	27.00R49	NA	NA	NA	NA	600-1198	600-0123	198	123
XKD1	53/80R63	NA	NA	NA	NA	600-1141	600-088	141	88
XL	11.00R16	650-0616	650-0548	777717-546	777727-333	600-1543	600-0338	543	338
XL	11.00R20	650-0593	650-0534	777717-484	777727-300	600-1487	600-0303	487	303
XL	14.00R20	650-0576	650-0519	777717-424	NA	600-1424	600-0264	424	264
XL	14.5R20	650-0593	650-0532	777717-484	777727-300	600-1484	600-0301	484	301
XL	14.75/80R20	650-0583	650-0526	777717-465	777727-294	600-1466	600-0289	466	289
XL	15.5/80R20	650-0579	650-0523	777717-450	777727-294	600-1451	600-0280	451	280
XL	16.00R20	650-0565	650-0515	777717-400	777727-245	600-1395	600-0245	395	245
XL	9.00R16	650-0627	650-0552	777717-588	777727-366	600-1584	600-0363	584	363
XL TT	11.00R20	650-0593	650-0534	777717-484	777727-300	600-1487	600-0303	487	303
XL TT	9.00R20	650-0608	650-0542	777717-514	777727-326	600-1518	600-0322	518	322
XM+S4	10.00R20	650-0601	650-0539	777717-510	777727-312	600-1507	600-0315	507	315

	Tire Size	Stemco Mechanical Hubo Miles	Stemco Mechanical Hubo KM	Veeder-root P/N Miles	Veeder-root P/N KM	DataTrac Miles	DataTrac KM	REV - Mile DataTrac Pro*	REV - KM DataTrac Pro*
XM+S4	10R22.5	650-0610	650-0545	777717-525	777727-326	600-1523	600-0325	523	325
XM+S4	11R22.5	650-0601	650-0537	777717-500	777727-310	600-1504	600-0313	504	313
XM+S4	11R24.5	650-0587	650-0532	777717-475	777727-300	600-1481	600-0299	481	299
XM+S4	275/80R22.5	650-0608	650-0545	777717-514	777727-326	600-1520	600-0323	520	323
XM+S4	9.00R20	650-0610	650-0545	777717-520	777727-326	600-1524	600-0325	524	325
XM+S4	9R22.5	650-0618	650-0665	777717-550	777727-343	600-1549	600-0341	549	341
XML	12.00R20	650-0583	650-0528	777717-468	777727-294	600-1472	600-0293	472	293
XML	14.00R20	650-0570	650-0519	777717-424	777727-273	600-1424	600-0263	424	263
XML	325/85R16	650-0616	650-0548	777717-546	777727-333	600-1543	600-0338	543	338
XML	395/85R20	650-0579	650-0523	777717-450	777727-294	600-1449	600-0279	449	279
XPS RIB	7.50R16	650-0704	NA	NA	777727-416	600-1663	600-0412	663	412
XPS RIB	8.75R16.5	650-0687	650-0578	777717-728	777727-450	600-1724	600-0450	724	450
XPS RIB	9.50R16.5	650-0677	650-0571	777717-686	777727-424	600-1695	600-0432	695	432
XPS RIB	LT215/85R16	650-0677	650-0571	777717-686	777727-424	600-1692	600-0430	692	430
XPS RIB	LT225/75R16	650-0695	650-0578	777717-728	777727-450	600-1720	600-0447	720	447
XPS RIB	LT235/85R16	650-0704	NA	NA	777727-416	600-1663	600-0412	663	412
XPS TRAC	7.50R16	650-0675	NA	NA	777727-416	600-1661	600-0411	661	411
XPS TRAC	LT215/85R16	650-0690	650-0567	777717-686	777727-424	600-1688	600-0427	688	427
XPS TRAC	LT235/85R16	650-0675	NA	777717-650	777727-400	600-1659	600-0410	659	410
XRV	225/70R19.5	650-0675	NA	777717-650	777727-400	600-1659	600-0410	659	410
XRV	235/80R22.5	650-0640	650-0549	777717-572	777727-350	600-1567	600-0353	567	353
XRV	245/70R19.5	650-0633	650-0561	777717-624	777727-392	600-1633	600-0394	633	394
XRV	255/80R22.5	650-0617	650-0665	777717-546	777727-343	600-1550	600-0342	550	342
XSM	26.5R25	650-0658	NA	777717-300	NA	600-1295	600-0183	295	183
XT-1	11R22.5	650-0605	650-0541	777717-510	777727-312	600-1515	600-0320	515	320
XT-1	11R24.5	650-0593	650-0534	777717-484	777727-300	600-1489	600-0304	489	304
XT-1	275/80R22.5	650-0613	650-0664	777717-520	777727-326	600-1530	600-0329	530	329
XT-1	275/80R24.5	650-0605	650-0541	777717-510	777727-312	600-1515	600-0320	515	320
XT-1	445/50R22.5	650-0613	650-0664	777717-539	777727-333	600-1532	600-0330	532	330
XTA	10.00R15	650-0627	650-0552	777717-588	777727-366	600-1585	600-0364	585	364
XTA	215/75R17.5	650-0690	650-0567	777717-686	777727-424	600-1689	600-0428	689	428
XTA	7.50R15	650-0691	650-0571	777717-700	777727-433	600-1698	600-0433	698	433
XTA	8.25R15	650-0673	650-0563	777717-637	777727-400	600-1641	600-0398	641	398
XTA	9R17.5	650-0673	650-0561	777717-637	777727-392	600-1637	600-0396	637	396
XTE2	235/75R17.5	650-0676	650-0567	777717-676	777727-416	600-1674	600-0419	674	419
XTE2	385/65R22.5	650-0598	650-0537	777717-500	777727-310	600-1498	600-0310	498	310
XTE2	425/65R22.5	650-0583	650-0528	777717-468	777727-294	600-1472	600-0293	472	293
XTE2	445/65R22.5	650-0581	650-0525	777717-465	777727-294	600-1461	600-0286	461	286
XTL	20.5R25	NA	650-0519	777717-416	777727-245	600-1419	600-0260	419	260
XTY	275/70R22.5	650-0618	650-0665	777717-550	777727-343	600-1554	600-0344	554	344
XTY2	275/70R22.5	650-0618	650-0665	777717-546	777727-343	600-1551	600-0342	551	342
XZ2	12R22.5	650-0595	650-0535	777717-490	777727-306	600-1496	600-0308	496	308
XZA	10.00R20	650-0601	650-0539	777717-510	777727-312	600-1508	600-0315	508	315
XZA	10R17.5	650-0631	650-0559	777717-624	777727-381	600-1622	600-0386	622	386

	Tire Size	Stemco Mechanical Hubo Miles	Stemco Mechanical Hubo KM	Veeder-root P/N Miles	Veeder-root P/N KM	DataTrac Miles	DataTrac KM	REV - Mile DataTrac Pro*	REV - KM DataTrac Pro*
XZA	11.00R20	650-0595	650-0535	777717-490	777727-306	600-1493	600-0306	493	306
XZA	12.00R20	650-0584	650-0528	777717-475	777727-294	600-1477	600-0296	477	296
XZA	225/70R19.5	650-0634	650-0563	777717-650	777727-416	600-1657	600-0408	657	408
XZA	265/70R19.5	650-0630	650-0559	777717-612	777727-381	600-1616	600-0382	616	382
XZA	285/70R19.5	650-0629	650-0554	777717-600	777727-381	600-1600	600-0373	600	373
XZA	295/80R22.5	650-0601	650-0539	777717-500	777727-312	600-1507	600-0315	507	315
XZA	305/70R19.5	650-0627	650-0552	777717-588	777727-359	600-1580	600-0361	580	361
XZA	305/75R24.5	650-0595	650-0535	777717-484	777727-300	600-1495	600-0308	495	308
XZA	365/80R20	650-0591	650-0532	777717-484	777727-300	600-1484	600-0301	484	301
XZA	8.5R17.5	650-0704	NA	777717-676	777727-416	600-1669	600-0415	669	415
XZA	8R19.5	650-0633	650-0561	777717-624	777727-392	600-1627	600-0390	627	390
XZA	9.00R20	650-0610	650-0545	777717-520	777727-326	600-1528	600-0328	528	328
XZA (Eur)	285/70R19.5	650-0629	650-0554	777717-600	777727-381	600-1600	600-0373	600	373
XZA1 (Eur)	275/70R22.5	650-0618	650-0665	777717-546	777727-343	600-1554	600-0344	554	344
XZA1 (Eur)	275/80R22.5	650-0610	650-0545	777717-520	777727-326	600-1523	600-0325	523	325
XZA1 (Eur)	295/80R22.5	650-0601	650-0539	777717-510	777727-316	600-1508	600-0315	508	315
XZA1 (Eur)	315/80R22.5	650-0595	650-0535	777717-490	777727-306	600-1495	600-0307	495	307
XZA-1+	11R22.5	650-0601	650-0539	777717-510	777727-312	600-1509	600-0316	509	316
XZA-1+	11R24.5	650-0591	650-0532	777717-484	777727-300	600-1485	600-0302	485	302
XZA-1+	275/80R22.5	650-0610	650-0545	777717-520	777727-326	600-1524	600-0326	524	326
XZA-1+	275/80R24.5	650-0601	650-0539	777717-510	777727-312	600-1509	600-0316	509	316
XZA2	11R22.5	650-0601	650-0539	777717-510	777727-316	600-1510	600-0317	510	317
XZA2	11R24.5	650-0591	650-0532	777717-484	777727-300	600-1485	600-0302	485	302
XZA2	275/80R22.5	650-0610	650-0545	777717-520	777727-326	600-1526	600-0327	526	327
XZA2	275/80R24.5	650-0601	650-0539	777717-510	777727-316	600-1509	600-0316	509	316
XZA4 (G20)	14.00R20	650-0576	650-0519	777717-433	777727-273	600-1430	600-0267	430	267
XZE	10R22.5	650-0610	650-0545	777717-520	777727-326	600-1525	600-0326	525	326
XZE	11R22.5	650-0605	650-0539	777717-510	777727-312	600-1509	600-0316	509	316
XZE	11R24.5	650-0591	650-0532	777717-484	777727-300	600-1484	600-0300	484	300
XZE	12R22.5	650-0595	650-0537	777717-490	777727-306	600-1494	600-0307	494	307
XZE	225/70R19.5	650-0634	650-0563	777717-650	777727-400	600-1654	600-0407	654	407
XZE	235/80R22.5	650-0622	650-0549	777717-572	777727-350	600-1564	600-0350	564	350
XZE	245/70R19.5	650-0633	650-0561	777717-624	777727-392	600-1628	600-0390	628	390
XZE	255/70R22.5	650-0626	650-0549	777717-572	777727-359	600-1574	600-0357	574	357
XZE	255/80R22.5	650-0616	650-0548	777717-539	777727-343	600-1546	600-0339	546	339
XZE	275/80R22.5	650-0613	650-0664	777717-520	777727-326	600-1523	600-0325	523	325
XZE	275/80R24.5	650-0605	650-0541	777717-510	777727-316	600-1509	600-0316	509	316
XZE	9R22.5	650-0618	650-0665	777717-546	777727-343	600-1551	600-0342	551	342
XZE1	215/75R17.5	650-0677	650-0571	777717-686	777727-424	600-1693	600-0431	693	431
XZE1	245/70R17.5	650-0676	650-0567	777717-676	777727-416	600-1674	600-0419	674	419
XZE2(Eur)	295/80R22.5	650-0601	650-0539	777717-510	777727-316	600-1506	600-0315	506	315
XZL	11.00R20	650-0593	650-0534	777717-490	777727-300	600-1489	600-0304	489	304
XZL	14.00R20	NA	650-0519	777717-424	777727-273	600-1424	600-0263	424	263
XZL	16.00R20	650-0565	NA	777717-392	777727-245	600-1397	600-0246	397	246

	Tire Size	Stemco Mechanical Hubo Miles	Stemco Mechanical Hubo KM	Veeder-root P/N Miles	Veeder-root P/N KM	DataTrac Miles	DataTrac KM	REV - Mile DataTrac Pro*	REV - KM DataTrac Pro*
XZL	24R21	650-0560	650-0515	777717-381	777727-245	600-1384	600-0238	384	238
XZL	365/85R20	650-0583	650-0526	777717-468	777727-294	600-1466	600-0290	466	290
XZL	395/85R20	650-0579	650-0523	777717-450	777727-294	600-1449	600-0279	449	279
XZL	9.00R16	650-0627	650-0552	777717-572	777727-359	600-1579	600-0360	579	360
XZL (wb)	445/65R22.5	650-0581	650-0525	777717-465	777727-294	600-1457	600-0284	457	284
XZL MPT	335/80R20	650-0608	650-0542	777717-514	777727-326	600-1517	600-0321	517	321
XZL MPT	365/80R20	650-0593	650-0534	777717-484	777727-300	600-1487	600-0303	487	303
XZT	225/70R19.5	650-0634	650-0563	777717-650	777727-400	600-1652	600-0405	652	405
XZT	245/70R19.5	650-0633	650-0561	777717-624	777727-392	600-1628	600-0390	628	390
XZT	265/70R19.5	650-0630	650-0559	777717-612	777727-381	600-1611	600-0380	611	380
XZT	285/70R19.5	650-0629	650-0552	777717-588	777727-366	600-1595	600-0370	595	370
XZU	11R22.5	650-0601	650-0539	777717-500	777727-310	600-1504	600-0313	504	313
XZU2	10.00R20	650-0601	650-0539	777717-500	777727-310	600-1504	600-0313	504	313
XZU2	12R22.5	650-0593	650-0534	777717-484	777727-306	600-1490	600-0305	490	305
XZU2	275/70R22.5	650-0618	650-0665	777717-546	777727-343	600-1552	600-0343	552	343
XZU2	305/70R22.5	650-0613	650-0664	777717-539	777727-333	600-1534	600-0332	534	332
XZY	10.00R20	650-0601	650-0539	777717-500	777727-310	600-1506	600-0315	506	315
XZY	11.00R20	650-0593	650-0535	777717-490	777727-306	600-1491	600-0305	491	305
XZY	11.00R22	650-0583	650-0526	777717-465	777727-294	600-1468	600-0291	468	291
XZY	11.00R24	650-0579	650-0523	777717-450	777727-294	600-1449	600-0279	449	279
XZY	12.00R20	650-0583	650-0528	777717-468	777727-294	600-1473	600-0294	473	294
XZY	12.00R24	650-0576	650-0521	777717-433	777727-273	600-1436	600-0271	436	271
XZY	7.50R16	650-0704	NA	777717-676	777727-416	600-1663	600-0412	663	412
XZY	8.25R20	650-0618	650-0665	777717-546	777727-343	600-1553	600-0344	553	344
XZY (wb)	385/65R22.5	650-0595	650-0537	777717-494	777727-306	600-1497	600-0309	497	309
XZY (wb)	425/65R22.5	650-0583	650-0528	777717-468	777727-294	600-1472	600-0293	472	293
XZY (wb)	445/65R19.5	650-0595	650-0535	777717-494	777727-306	600-1494	600-0307	494	307
XZY (wb)	445/65R22.5	650-0581	650-0525	777717-465	777727-294	600-1461	600-0286	461	286
XZY-1	315/80R22.5	650-0595	650-0535	777717-490	777727-306	600-1491	600-0305	491	305
XZY-1S	315/80R22.5	650-0595	650-0535	777717-490	777727-306	600-1491	600-0305	491	305
XZY-2	11R22.5	650-0601	650-0539	777717-500	777727-310	600-1504	600-0313	504	313
XZY-2	11R24.5	650-0587	650-0532	777717-484	777727-300	600-1481	600-0299	481	299
XZY-2	12R22.5	650-0593	650-0534	777717-490	777727-306	600-1490	600-0305	490	305
XZY-2	12R24.5	650-0583	650-0526	777717-465	777727-294	600-1467	600-0290	467	290
XZY-2	315/80R22.5	650-0595	650-0535	777717-490	777727-306	600-1491	600-0305	491	305
XZY-2S	315/80R22.5	650-0595	650-0535	777717-490	777727-306	600-1491	600-0305	491	305
Sumitomo									
ST727	10.00R15	650-0627	650-0552	777717-588	777727-366	600-1584	600-0363	584	363
Toyo									
M120Z	10R22.5	650-0610	650-0545	777717-520	777727-326	600-1527	600-0328	527	328
Yokohama									

	Tire Size	Stemco Mechanical Hubo Miles	Stemco Mechanical Hubo KM	Veeder-root P/N Miles	Veeder-root P/N KM	DataTrac Miles	DataTrac KM	REV - Mile DataTrac Pro*	REV - KM DataTrac Pro*
MY507	11R24.5	650-0584	650-0528	777717-475	777727-294	600-1476	600-0296	476	296
RY103	295/75R22.5	650-0610	650-0545	777717-520	777727-326	600-1526	600-0327	526	327
RY103	315/80R22.5	650-0595	650-0537	777717-500	777727-310	600-1497	600-0309	497	309
RY112A	11R22.5	650-0605	650-0541	777717-514	777727-326	600-1512	600-0318	512	318
TY303	11R24.5	650-0584	650-0528	777717-475	777727-300	600-1478	600-0297	478	297
TY303	255/70R22.5	650-0640	650-0549	777717-572	777727-350	600-1569	600-0354	569	354
TY517	11R24.5	650-0584	650-0528	777717-475	777727-300	600-1478	600-0297	478	297

Hubodometer® Specifications

Popular Hubodometers® (in popularity order)



Part Number	RPM	Blank Tenths Part Number	Part Number	RPKM
650-0610	522	650-0611	650-0637	310
650-0598	500	650-0600	650-0632	300
650-0613	532	650-0614	650-0639	315
650-0601	504	650-0602	650-0645	324
650-0609	513	650-0608	650-0641	320
650-0587	480	650-0638	650-0649	357

Popular Hubodometer® Brackets (in popularity order)

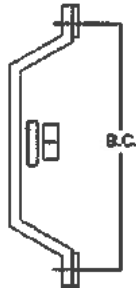

Part Number	Bolt Circle Diameter	Stud Size	Height
610-0065 □	5-1/2	5/16	3-1/2
610-0006	7	5/8	1-11/16
610-0007	7	3/4	1-11/16
610-0011 □	5-1/2 - 7-1/2	1/2	1-3/4
610-0024	5-1/2	5/16 - 18 Thrd.	4-1/2
610-0002	5-1/2	5/8	1-11/16
610-0003	6-3/8 - 6-1/2	1/2 - 9/16	1-11/16
610-0005	7-1/4	9/16	1-11/16

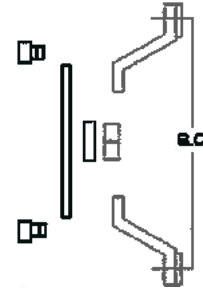

□ Fits 4009 hubcap.

□ Universal Mount

Hubo Bracket for Sentinel® and PSI Hub Caps

STEMCO Part No.	Bolt Circle Diameter	Stud Size	Height	Hub Cap Part No.
610-0084	6-3/4	5/16	5	4195
610-0085	5-1/2	5/16	4	4009
610-0090	-	-	1-7/8	4351

*Bracket mounts on top of window ring w/4 replacement screws included w/bracket.

Hubodometer® Hub Caps - For Trailer Installations



Hub cap Includes Gasket	Gasket Part No.	Bolt Circle Diameter	Number of Holes	Bolt Diameter	Aluminum Equivalent
640-8001	641-0005	5-1/2	6	5/16	347-4009
640-8002	641-0017	5-1/2	5	5/16	347-4013
640-8003	330-3077	6-1/4 x 8 UN(M)			347-4076

Accessories

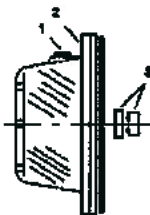

Description	Part No.
1-Pipe plug with O-ring	641-8001
2-Supporting hub cap flange 5 hole	641-8002
6 hole	641-8003
3-Hubodometer® mounting washer & nut	641-8004

For additional Hubodometer® information, refer to www.stemco.com.

Note: 610-0085 is obsolete. Please use 610-0028 (5 1/2 bolt circle; 5/16 stud size; 5" height; 4009 hub cap).

STEMCO HUBODOMETER®

INSTALLATION INSTRUCTIONS

1. Mount Hubodometer® to face of hub cap or bracket.
2. Use washer under locknut.
3. Use 15-ft lbs. of torque to tighten locknut.
DO NOT USE AIR IMPACT WRENCH.
DO NOT EXCEED 15-ft. lbs. OF TORQUE.
4. If necessary, use strap wrench to hold Hubodometer® while tightening.
5. **DO NOT USE PAINTS, SOLVENTS OR THINNERS ON THE HUBODOMETER® FACE, GRILAMID HUB CAP OR HUBODOMETER® HUB CAP WINDOW.**

The recommended torque for the 3/8" pipe plug for aluminum hub caps is 9 ft.-lbs. A suitable sealant may be used on the pipe plug threads if desired. On Grilamid hub caps with plastic fill plug and o-ring, tighten to torque not to exceed 10 ft.-lbs.

The proper oil level for the Stemco Hubodometer® window is indicated by the inside protruding ledge of the window. (See drawing.)

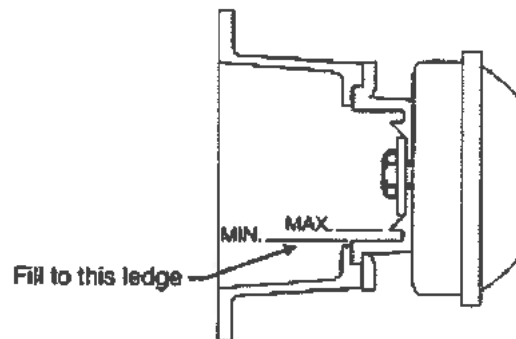

Note: 610-0085 is obsolete. Please use 610-0028 (5 ½ bolt circle; 5/16 stud size; 5" height; 4009 hub cap.

STEMCO BRACKETS AND ACCESSORIES

BRACKETS BY PART NUMBER

Part Number	Bolt Circle Diameter	Stud Size	Height	Style
610-0004	5-1/4	1/2	1-11/16	A
610-0002*	5-1/2	5/8	1-11/16	A
610-0003*	6-3/8-6-1/2	1/2-9/16	1-11/16	A
610-0005*	7-1/4	9/16	1-11/16	A
610-0006*	7	5/8	1-11/16	A
610-0007*	7	3/4	1-11/16	A
610-0008	7-1/2	5/8	1-9/16	A
610-0009	7-1/2	5/8	3-11/16	A
610-0010	8-5/8	5/8	3-7/16	A
610-0011*	5-1/2-7-1/2	1/2	1-3/4	Ø
610-0012	4.292	29/64	1-3/4	Ø
610-0013	5-1/2	7/16	4	A
610-0014	7-5/8	5/8	4-3/8	A
610-0015	2-1/2-6-1/2	9/16	1-1/8	CØ
610-0016	2-1/2-6-1/2	5/16-3/4	1-1/8	CØ
610-0017	5-7/32	5/8	1-11/16	A
610-0019	5-11/16	7/16	1-9/16	A
610-0021	5-1/16-5-5/16	7/16-20 Thrd.	1-3/8	B
610-0022	3-9/16	1/2	1/2	A
610-0023	3-13/16	1/2	1	A
610-0024*	5-1/2	5/16-18 Thrd.	4-1/2	Ø
610-0025	2-1/2-9	3/16	1-11/16	Ø
610-0026	4-3/8	1/2-20 Thrd.	1-1/2	B
610-0033	8-3/8	5/8	1-5/8	A
610-0039	5-5/16	1/2-20 Thrd.	1-1/2	B
610-0045	4-1/8	1/2	1-11/16	A
610-0058	6-1/2	1/2	4-1/2	A
610-0059	4	9/16	1-1/2	AØ
610-0065*	5-1/2	5/16	3-1/2	AØ
610-0066	6-1/2	5/8	5-1/4	A
610-0067	6-7/8	7/16	3-1/4	Ø
610-0079	7-1/4	3/4	1-11/16	A
610-0081	8-1/2	5/8	6	A
610-0084*	6-3/4	5/16	5	DØ
610-0085*	5-1/2	5/16	4	AØ

To measure bolt circle diameter (on axles with an even number of studs)

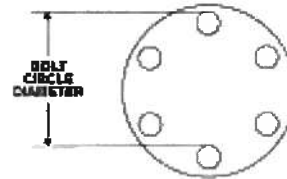

(on axles with an odd number of studs)

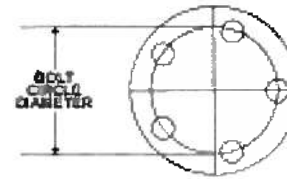

Style A and Style B are for axles with an even number of studs.
Style C for the odd number of studs.

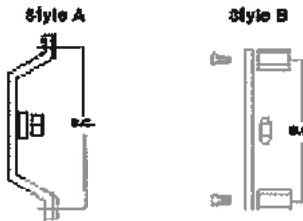

UNIVERSAL MOUNT

Can be assembled in direction to fit most drive axles. The standard kit (to 5-1/2" to 7-3/4" bolt circles and 1/2" stud size).

Part No.

- 610-0011 1 - Axle
- 3 - Clamp
- 3 - Washer
- 4 - Nut
- 8 - Rivets



Popular Brackets

- Universal Mount
- Mercedes (16-Stud Axle Flange)
- Car Mount Bracket (4-Stud Wheels)
- Truck Mount Bracket (8-Stud Wheels)
- Bracket mounts over trailer hub cap; Round plate with standoffs.
For replacement standoffs, order 841-0022 (pg. of 3)
- TMK-80; completely adjustable
- For golf carts
- Fits over the 4808 hub cap
- Fits over the 4882 hub cap
- Fits bolt on Propar hub cap
- For use with P&I system

Style C



Style D

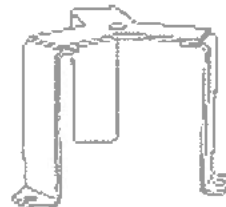

Note: 610-0085 is obsolete. Please use 610-0028 (5 1/2 bolt circle; 5/16 stud size; 5" height; 4009 hub cap).

STEMCO BRACKETS AND ACCESSORIES

BRACKETS BY BOLT CIRCLE DIAMETER

Bolt Circle Diameter	Stud Size	Height	Style	Part Number
2-1/2-6-1/2	5/16	1-1/8	CØ	610-0016
2-1/2-6-1/2	9/16	1-1/8	CØ	610-0015
3-9/16	1/2	1/2	A	610-0022
3-15/16	1/2	1	A	610-0023
4	9/16	1-1/2	AØ	610-0059
4-1/8	1/2	1-11/16	A	610-0045
4-2/2	29/64	1-3/4	Ø	610-0012
4-3/8	1/2-20 Thrd.	1-1/2	B	610-0026
4-1/2-B	3/16	1-11/16	Ø	610-0025
5-1/16-5-5/16	7/16-20 Thrd.	1-3/8	B	610-0021
5-7/32-5-1/4	5/8	1-11/16	A	610-0017
5-1/4	1/2	1-11/16	A	610-0001
5-1/2-7-1/2	1/2	1-3/4	Ø	610-0011*
5-5/16	1/2-20 Thrd.	1-1/2	B	610-0039
5-1/2	5/16	3-1/2	AØ	610-0055*
5-1/2	5/16	4	AØ	610-0085*
5-1/2	5/16-18 Thrd.	4-1/2	Ø	610-0024*
5-1/2	7/16	4	A	610-0013
5-1/2	5/8	1-11/16	A	610-0002*
5-11/16	7/16	1-9/16	A	610-0019
6-3/8-6-1/2	1/2-9/16	1-11/16	A	610-0003*
6-1/2	1/2	4-1/2	A	610-0058
6-1/2	5/8	5-1/4	A	610-0066
6-3/4	5/16	5	DØ	610-0084*
6-7/8	7/16	3-1/4	Ø	610-0067
7	5/8	1-11/16	A	610-0006*
7	3/4	1-11/16	A	610-0007*
7-1/4	9/16	1-11/16	A	610-0005*
7-1/4	3/4	1-11/16	A	610-0079
7-1/2	5/8	1-9/16	A	610-0008
7-1/2	5/8	3-11/16	A	610-0009
7-5/8	5/8	4-3/8	A	610-0014
8-1/2	5/8	6	A	610-0081
8-3/8	5/8	1-5/8	A	610-0033
8-5/8	5/8	5-7/16	A	610-0010

- Ø Universal Mount
- Ø Mercedes (18-Stub Axle Flange)
- Ø Car Mount Bracket (6-Stub Wheels)
- Ø Trunk Mount Bracket (6-Stub Wheels)
- Ø Bracket mounts over trailer hub cap; Round plate with standoffs. For replacement standoffs, order 641-0022 (pkg. of 3)
- Ø TMR-90: completely adjustable
- Ø For golf carts
- Ø Fits over the 4009 hub cap
- Ø Fits over the 4082 hub cap
- Ø Fits bolt on Proper hub cap
- Ø For use with PSI system

ACCESSORIES

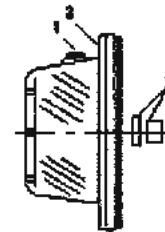

* Popular Brackets



640-0001



640-0003

Description	Part No.
1-Pipe plug with O-ring	641-0031
2-Supporting hub cap flange & hole	641-0002
6 hole	641-0003
6 hole - 6" BC	641-0026
3-Hubodometer mounting washer & nut	641-0004
Replacement Standoffs for 610-0024 bracket (pkg of 3)	641-0022

FOR TRAILER INSTALLATIONS

Hub Caps (supplied with gasket)

Part No.	Gasket Part No.	Bolt Circle Diameter	Number Of Holes	Bolt Diameter	Aluminum Equivalent
640-0001	641-0005	5-1/2	5	5/16	347-4009
640-0002	641-0017	5-1/2	5	5/16	347-4013
640-0003	330-3077	Proper Screen Cap			347-4073
Hubo Window to fit all Hub Caps with 3-1/2" Windows					349-6117

Note: 610-0085 is obsolete. Please use 610-0028 (5 1/2 bolt circle; 5/16 stud size; 5" height; 4009 hub cap.

MANUFACTURING & OPERATIONS: A GLOBAL PRESENCE



A COMMITMENT TO EXCELLENCE

Founded in 1951, STEMCO, which stands for Specialized Truck Equipment Manufacturing Company, offers a diverse line of long-life, safety-focused products for the commercial vehicle market. In recent years, STEMCO has deployed an adjacency strategy to broaden our offering with products and solutions that fall within our focus on making the roadways safer.

Our commercial vehicle solutions are classified into four major groups:

- **Wheel end components** — Including seals, spindle fasteners, bearings, hub caps and mileage counters
- **Suspension products** — Including king pins, spring pins, bushings, polyurethane components, air springs and heavy-duty shop equipment
- **Brake products** — Including brake shoes, friction, automatic brake adjusters, new lined wheel kits, and brake drums
- **Innovative tire and mileage solutions** — Including the BAT RF® technology, TrailerTail® and the Aeris® tire inflation product lines

Throughout our expanding portfolio of products and solutions, one thing remains constant: Our dedication to the commercial vehicle industry and holding ourselves to A Higher Standard of Performance.™

STEMCO is an EnPro Industries, Inc. (NYSE: NPO) company. EnPro Industries, Inc. is a leader in sealing products, metal polymer and filament wound bearings, components and service for reciprocating compressors, diesel and dual-fuel engines and other engineered products for use in critical applications by industries worldwide.

A HISTORY OF INNOVATION

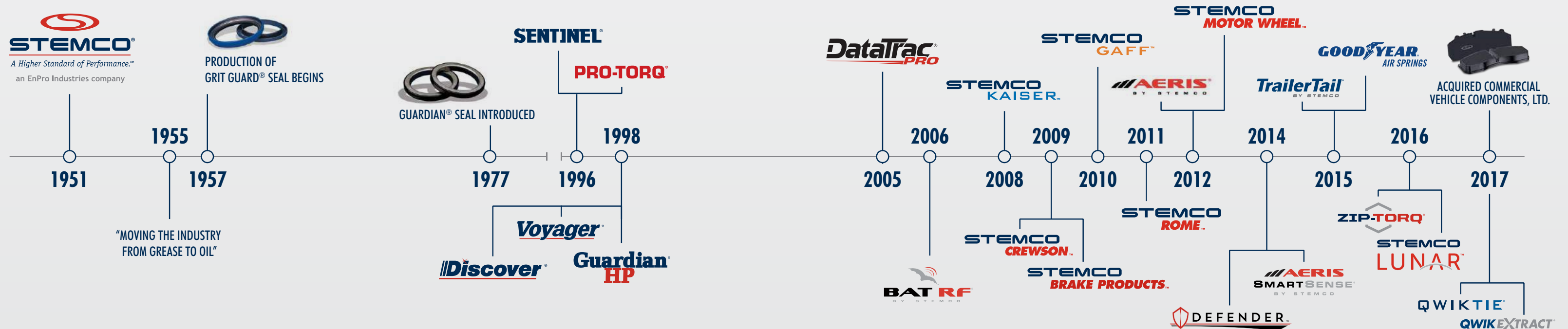

LEAN ENTERPRISE

Focused on maximizing value and quality for our customers. Some elements of our lean manufacturing include:

- Waste elimination
- Continuous improvement
- 48-Hour order turnaround
- 24+ inventory turns
- 8 ISO 9000 facilities

ISO/TS 16949

Automotive industry quality management certification for continual improvement, defect prevention and reduction of waste.

EXCELLENCE IN SAFETY

Three times in the last five years, EnPro Industries was named one of America's Safest Companies by *EHS Today*.

TESTING CAPABILITIES

80 Wheel End Dynamics Stands

- 580 rpm, + offset

Contamination Simulator

- Slurry, water, saltwater

Pinion Seal Tester

- 3000 rpm, + offset

Instron

- 30,000 lb load capability

Engineering Modeling & Analysis Tools

- SOLIDWORKS
- CATIA
- AutoCAD
- ANSYS

Environmental Dynamics

- Cold & hot temperature
- Vibration & impact

Other Machines

- Bearing testers
- Material testing
- Axle nut testing
- Wheel end monitoring
- Custom test setups
- Custom machine building
- Dynamometer
- SAE wear testing
- FAST test
- Accelerated king pin durability test



**STEMCO PRODUCT SEGMENTS:
DEVELOPING SUPERIOR SOLUTIONS**



**STEMCO
WHEEL END™**

STEMCO has provided the commercial vehicle market with world-class components and systems since 1951, and provided the technology to move the industry from hard-pack grease to oil. STEMCO is well known for high-performance wheel seals, hub caps, bearings, spindle fasteners and mileage counters. STEMCO engineers wheel end solutions designed to meet the performance expectations of almost every fleet in an effort to help improve safety and reduce operating costs.



**STEMCO
BRAKE PRODUCTS™**

YOUR STARTING POINT FOR STOPPING POWER

For over 60 years, STEMCO has supplied only the highest-quality wheel end components to the commercial vehicle market. By offering application-specific, high-performance braking solutions, as well as industry-unique products and processes like CentriFuse® and Crewson™, STEMCO Brake Products™ is providing an answer to the question: "How do I get quieter, safer, brake systems that run cooler and last longer?"



STEMCO PRODUCT SEGMENTS: DEVELOPING SUPERIOR SOLUTIONS

STEMCO
INNOVATIVE TIRE & MILEAGE SOLUTIONS | **ITMS™**

**MAXIMIZING PROFITABILITY THROUGH
TECHNOLOGICAL INNOVATION**

Innovative Tire and Mileage Solutions (ITMS)
ITMS focuses on improving fuel economy and increasing tire life. The Aeris® advanced automatic tire inflation system keeps commercial trailer tires properly inflated using air pressure from the trailer's braking system. BAT RF® by STEMCO uses advanced RF-enabled electronic sensors and readers, information management tools, and alert mechanisms to provide companies with tire inflation and other data that they can use to optimize tire life and fuel economy. TrailerTail® rear fairings reduce drag and turbulence at the back of the trailer, increasing fuel economy by up to 5.5%, or up to 10% or more when combined with our EcoSkirt™ trailer skirt.



STEMCO
SUSPENSION PRODUCTS™

HIGH-PERFORMANCE PARTS: SUPERIOR SUSPENSION SOLUTIONS

STEMCO has over 50 years of experience providing the longest lasting, easiest to install no-ream steering knuckle king pins, spring pins and bushings. The QwikKit® king pin kit is easy to install, and its spiral steel bushing outperforms and outlasts the competition. The new QWIKTIE® tie rod assembly optimizes both safety and productivity by fitting more than 80% of straight tie rod assemblies on the market. With superior mechanical and chemical properties, STEMCO GAFF® polyurethane offers high-performance replacement parts for the rubber undercarriage system. The Axle Pro Equipment™ (APE) provides a revolutionary solution to enhance axle eyes. Replacing king pins is made safer and faster with our new QwikExtract® king pin removal system. The addition of Goodyear® SuperCushion® air springs adds a new dimension of performance, durability, and safety to our suspension product line.



WHEN IT COMES TO TRAINING WE HOLD OURSELVES TO A HIGHER STANDARD

INDUSTRY-BEST WARRANTY SERVICEABLE, AFFORDABLE & FLEXIBLE



BRAKE PRODUCTS TRAINING

- Foundation basics
- Brake balance
- Automatic brake adjusters
- Troubleshooting and inspection

STEMCO CREWSON.

STEMCO BRAKE PRODUCTS.

STEMCO MOTOR WHEEL.

SUSPENSION PRODUCTS TRAINING

- King pin replacement for QwikKit® and Plus Kit™
- Complete break down and rebuild training
- Polyurethane components
- Troubleshooting and inspection

STEMCO KAISER.

STEMCO GAFF™

INNOVATIVE TIRE AND MILEAGE SOLUTIONS TRAINING

- Tire inflation management
- Mileage management
- Tire pressure monitoring
- Asset tracking

STEMCO INNOVATIVE TIRE & MILEAGE SOLUTIONS | ITMS.

WHEEL END PRODUCTS TRAINING

- Techniques to make seals last longer
- Single nut and double nut
- Adjustment procedures
- Proper fill rates
- Troubleshooting and inspection

STEMCO WHEEL END.



PLATINUM PERFORMANCE PLUS SYSTEMS

- Lower your operating costs, reduce downtime and increase revenue
- Light Weight and Tire Inflation Platinum Performance Systems help improve fuel efficiency performance
- The Aftermarket's best warranty solutions include three- and five-year packages with unlimited mileage
- Choose our five-year OEM Plus package, or add additional STEMCO components and extend the limited parts and labor warranty to seven years.

AFTERMARKET PACKAGES

PLATINUM PERFORMANCE SYSTEM™

- Guardian® HP or Discover® Seal
- Pro-Torq® or Zip-Torq® Axle Fastener
- Defender™ Sentinel® or Sentinel® Hub Cap
- STEMCO Bearings

3 Year

PLATINUM PLUS PERFORMANCE SYSTEM™

- Guardian® HP or Discover® Seal
- Zip-Torq® Axle Fastener
- Defender™ Sentinel® Hub Cap
- STEMCO Bearings

5 Year

OEM PACKAGES

PLATINUM PLUS PERFORMANCE SYSTEM™

- Guardian® HP or Discover® Seal
- Pro-Torq® or Zip-Torq® Axle Fastener
- Sentinel® Hub Cap
- STEMCO Bearings

5 Year

PLATINUM PLUS PERFORMANCE SYSTEM™

- Discover® Seal
- Pro-Torq® or Zip-Torq® Axle Fastener
- Sentinel® Hub Cap
- STEMCO Bearings

5 Year

PLATINUM PLUS 7 PERFORMANCE SYSTEM™

TIRE INFLATION

- Aeris® Automatic Tire Inflation System
- Guardian® HP or Discover® Seal
- Pro-Torq® or Zip-Torq® Axle Fastener
- Sentinel® Hub Cap
- STEMCO Bearings

7 Year

PLATINUM PLUS 7 PERFORMANCE SYSTEM™

LIGHT WEIGHT

- STEMCO CentriFuse® Drum and Hub Assembly
- STEMCO Crewson™ Automatic Brake Adjuster
- Guardian® HP or Discover® Seal
- Pro-Torq® or Zip-Torq® Axle Fastener
- Sentinel® Hub Cap
- STEMCO Bearings

7 Year

Proud Member of:





INNOVATION, TRAINING & TRUST: A HIGHER STANDARD OF PERFORMANCE

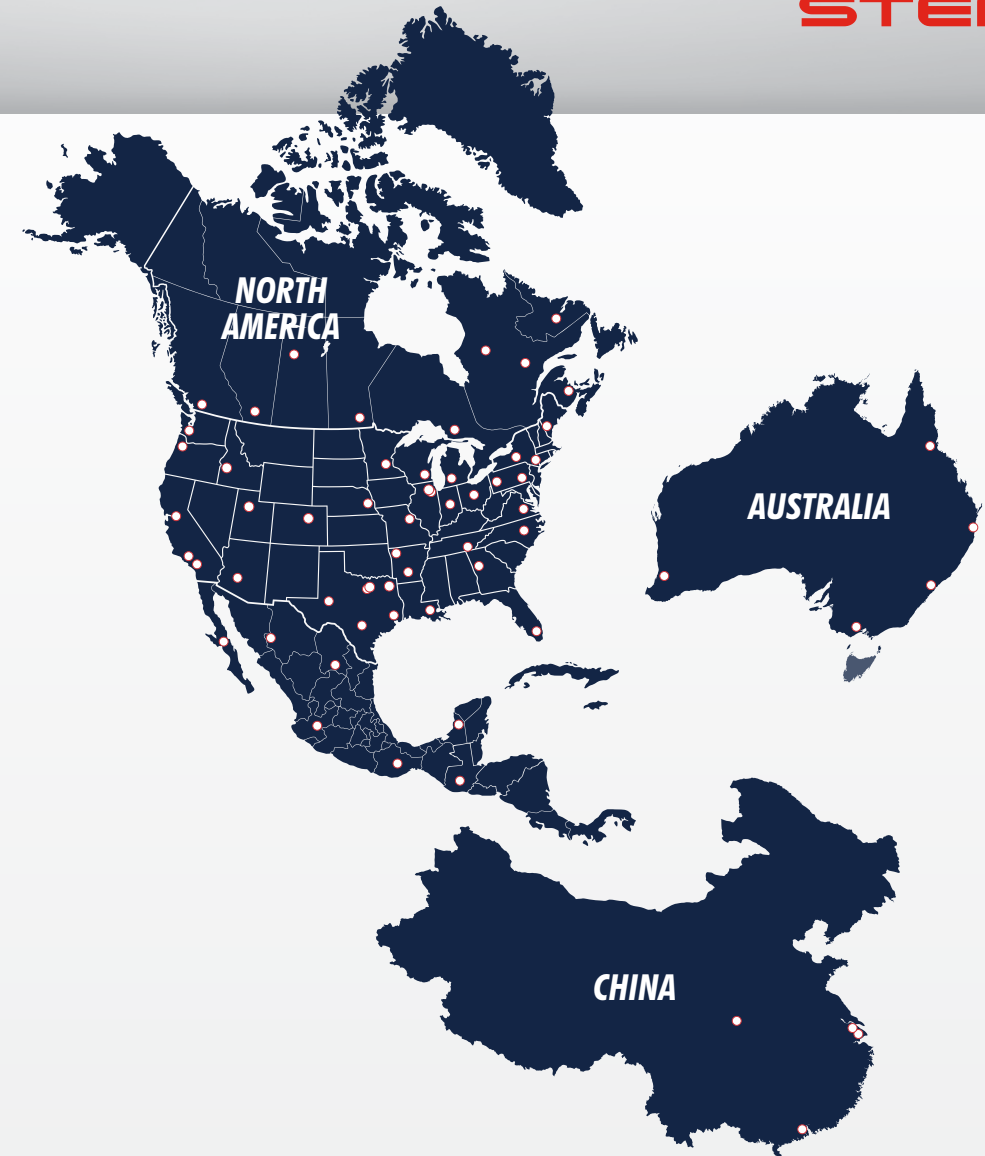

STEMCO'S THREE AREAS OF FOCUS

- Focused innovation—developing superior product technologies
- Training and support
- Trust

WHAT DIFFERENTIATES STEMCO

- Targeted focus on the commercial vehicle market
- Focus/knowledge on end-user customers
- Training and troubleshooting
- Relationships with OEM partners and distributor partners
- Original equipment and aftermarket expertise
- New product innovation
- 25 new products in the last nine years
- One of the largest sales teams in the industry

MANUFACTURING LOCATIONS

- Longview, TX
- Rome, GA
- Berea, KY
- Millington, MI
- Chattanooga, TN
- Suzhou, China
- San Luis Potosi, Mexico
- Shanghai, China

CENTRAL DISTRIBUTION CENTERS

- Berea, KY
- Mississauga, ON, Canada
- San Luis Potosi, Mexico
- Sydney, Australia
- Shanghai, China

OUR MISSION AT STEMCO IS TO MAKE THE ROADWAYS SAFER. WE DO THAT WITH OUR HIGH-QUALITY PRODUCTS AND HANDS-ON TRAINING.



Making the Roadways Safer®

an EnPro Industries company

Get durability, performance and value with air springs for truck, trailer, bus and cab seat applications.

Goodyear Air Springs offer:

- Bright yellow Mylar tag – easy identification
- Superior load cushioning – reduced in-transit damage
- Improved driver comfort and reduced driver fatigue
- Long life performance through advanced engineering



GOODYEAR
AIR SPRINGS

GOODYEAR
AIR SPRINGS

TWO NAMES YOU TRUST, ONE
REMARKABLE
PRODUCT LINE



STEMCO[®]
A Higher Standard of Performance.[™]
an EnPro Industries company

The quality you trust, now from the leader in roadway safety.

STEMCO is now the official manufacturer of Goodyear[®] Air Spring products, including Super Cushion[®] rolling lobe and bellows air springs, sleeve and custom designed air springs. Designed to reduce driver fatigue, component wear and downtime, Goodyear[®] Air Spring products lead the industry in comfort and performance.

GOODYEAR
AIR SPRINGS

TABLE OF CONTENTS

AIR SPRING PRODUCT INFORMATION	PAGE
Air Suspension Features and Benefits.....	A1
Super-Cushion® Air Springs for Trucks, Trailers, & Buses.....	A2
Components of Super-Cushion® Air Springs.....	A3
Unique Product Identification System.....	A4
How to Choose the Correct Replacement Air Spring.....	A5
Air Spring Identification.....	A6-A7
Air Spring Installation.....	A8-A9
Air Suspension Vehicle Maintenance Checklist.....	A10
Selected Non-warrantable Conditions.....	A11-A13
 NEW ADDITIONS	
2014 New Air Spring Additions.....	A14
 IDENTIFICATION & APPLICATION INFORMATION	
Bellows.....	1-30
Rolling Lobe.....	31-107
Sleeve.....	108-119
FLEX MEMBER INDEX	121-124
FIRESTONE FLEX MEMBER CROSS REFERENCE	125-126
PISTON INDEX	
Pistons for Rolling Lobe Air Springs.....	127-130
CROSS REFERENCE INFORMATION	
Competitors to Super-Cushion®	131-140
DISCONTINUED PARTS	141
TERMS AND CONDITIONS	143-145



AIR SUSPENSION FEATURES & BENEFITS

Greater level of isolation...

- * Reduces need for electrical and instrument maintenance.
- * Reduces cab and body damage.
- * Reduces axle, transmission and tire wear.
- * Reduces downtime.
- * Extends trailer life.
- * Reduces driver fatigue.

For the owner-operator, air suspension...

- * Improves isolation in both loaded and unloaded conditions.
- * Broadens types of loads available for transport, including electronic equipment where air suspensions are required by the shipper.
- * Greater driver comfort.
- * Increased resale value.
- * Protects hinges, lights, rivets, and all trailer hardware.

Reasons for increased air suspension usage:

- * Suspension manufacturers have built in a greater degree of durability, longer warranty periods.
- * Increased need for greater axle excursion.

SUPER-CUSHION®

Air Springs for Trucks, Trailers and Buses

Super-Cushion® air springs for trucks, trailers buses, and cab & seat springs protect cargo, provide constant-level hauling, and deliver long, trouble-free service.

Super-Cushion® air springs give your trucks, trailers and buses a new high in productivity and long life. They offer a quiet, cushioned ride. Truck, trailer and bus bodies last longer than with steel springs because there is less vibration. The driver rides in greater comfort, becomes less fatigued and stays more alert. Plus cargo has better protection from shock and vibration. Whenever you want to add an axle, Super-Cushion® air springs fit right in.

Super-Cushion® air springs, when used with leveling valves, also maintain consistent trim regardless of the load. That means clearance heights remain constant, and that trailer floors are flush with loading dock floors for ease of loading and unloading.

For driver comfort, load cushioning, and long life for your trucks, trailers, bus, and cab and seat springs specify Goodyear Engineered Products Super-Cushion® air springs.



Components Of Super-Cushion[®] Air Springs

ROLLING LOBE AIR SPRING (1R DESIGN)

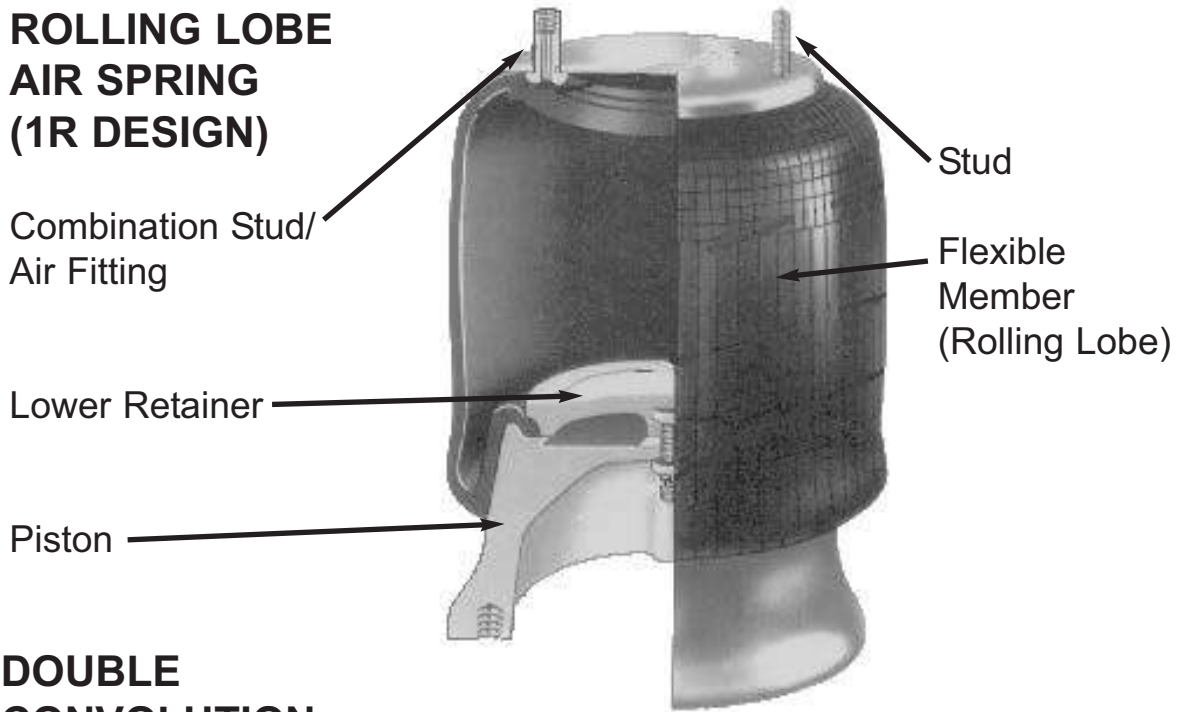

DOUBLE CONVOLUTION AIR SPRING (2B DESIGN)

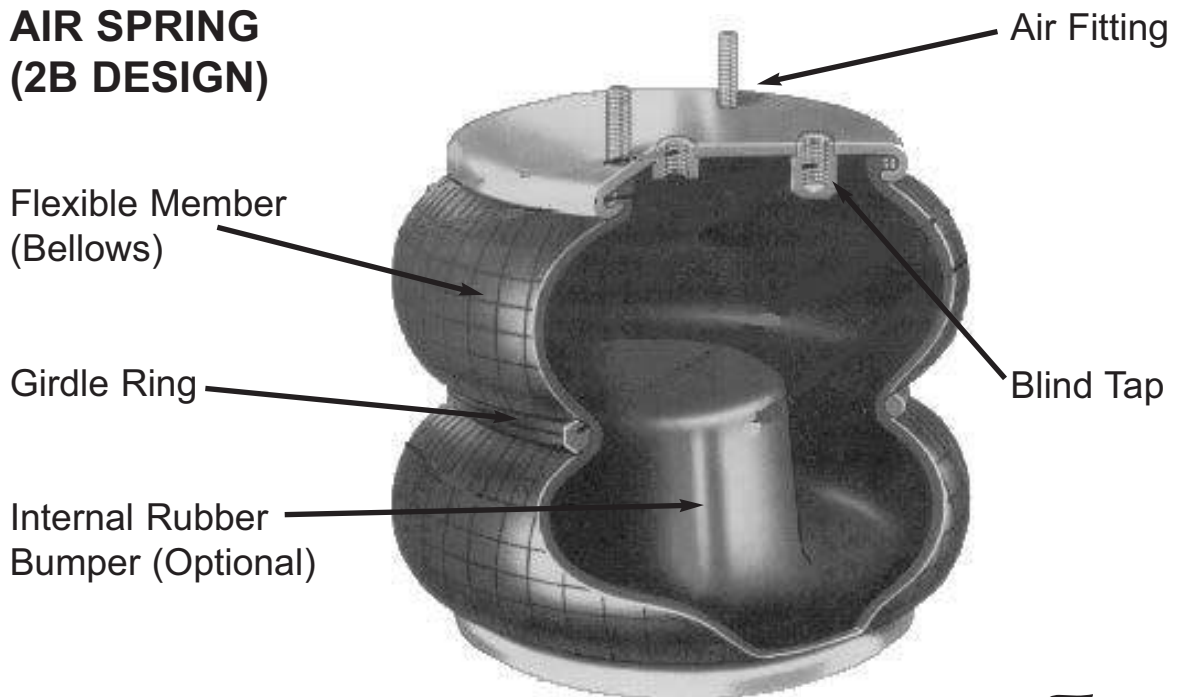

Unique Product Identification System

The Super-Cushion® air spring assembly part number consists of the Product Description and the Assembly Number. Elements of this system are shown in the following example for ordering a 2B12-300 Assembly:

2 B 12 - 300

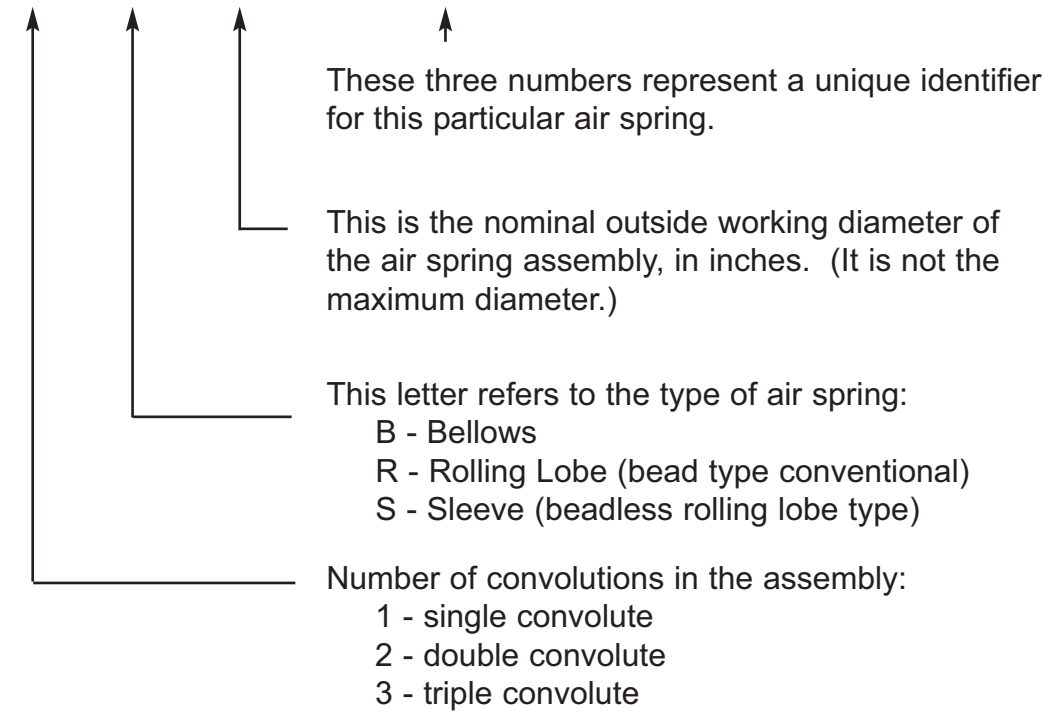

How to Choose the Correct Replacement Air Spring

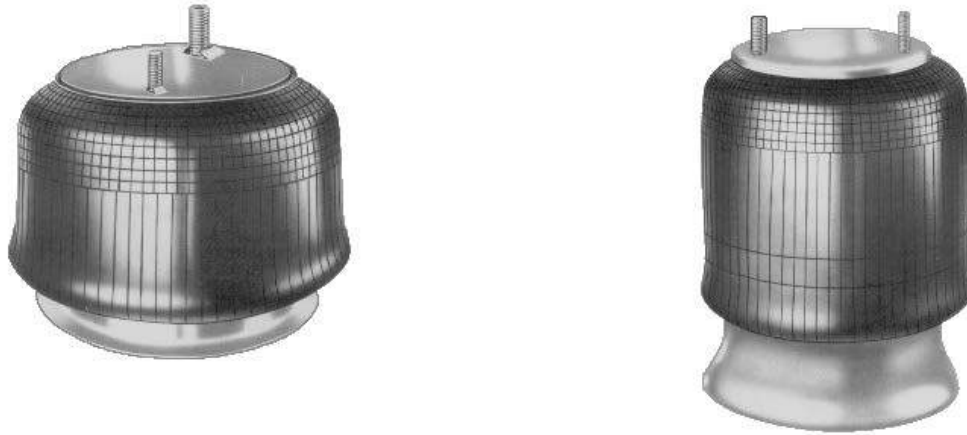

Many air springs appear to be similar in design and size at first glance. However, differences in the manufacturing techniques used for similar looking air springs may create substantial differences in operating dimensions. Specifically, the inflated (or operating) diameters of seemingly identical air springs will vary depending on the angle of the reinforcing fabric used in the flexible member.

For example, air spring models 1R12-092 and 1R13-039 appear very similar when first examined. However, the 1R12-092 model will inflate (operate) on vehicle at approximately 12" diameter, while the 1R13-039 model will operate at 13" diameter. In a substitution of the 1R13-039 air spring for the 1R12-092 in a truck trailer suspension, the larger air spring inflated diameter would most likely rub on another suspension component (such as a tire, shock absorber, or bracket) and cause failure within a few miles.

Air springs with interference type failures will not be considered for warranty claims. Be sure to select the correct replacement!

To select the proper Goodyear Engineered Products Super-Cushion® replacement air spring, use the procedure on the next page.

CAUTION: Numbers molded on the rubber bag (flexible member) are **NOT** the assembly part numbers. Bags with the same numbers are used with different combinations of top and bottom metals. They may or may not have an internal rubber bumper.

Air Spring Identification

1. Start with the original equipment or aftermarket part number. It is usually located on a label affixed to the top plate of the air spring. If it is a Goodyear Engineered Products part number, simply double check the product photo in the main body of the catalog. If you have an O.E. number or a Firestone number look in the cross-reference section.

2. If the O.E. part number or aftermarket part number is unknown you should begin your search with the bellows number. The number is molded into the rubber part of the air spring. Once identified you can narrow down the choices in the Flexible Members Index section.

3. Measure the width of the top plate and make a note of the bolt pattern or taps.

4. Measure the width of the piston or bottom bead plate and make a note how the bolt pattern is oriented compared to the bolts on the top plate (Inline or Rotated). The view of this orientation should appear as if you are looking directly through a clear drinking glass from the top to bottom. This is how the catalog illustrations are drawn.

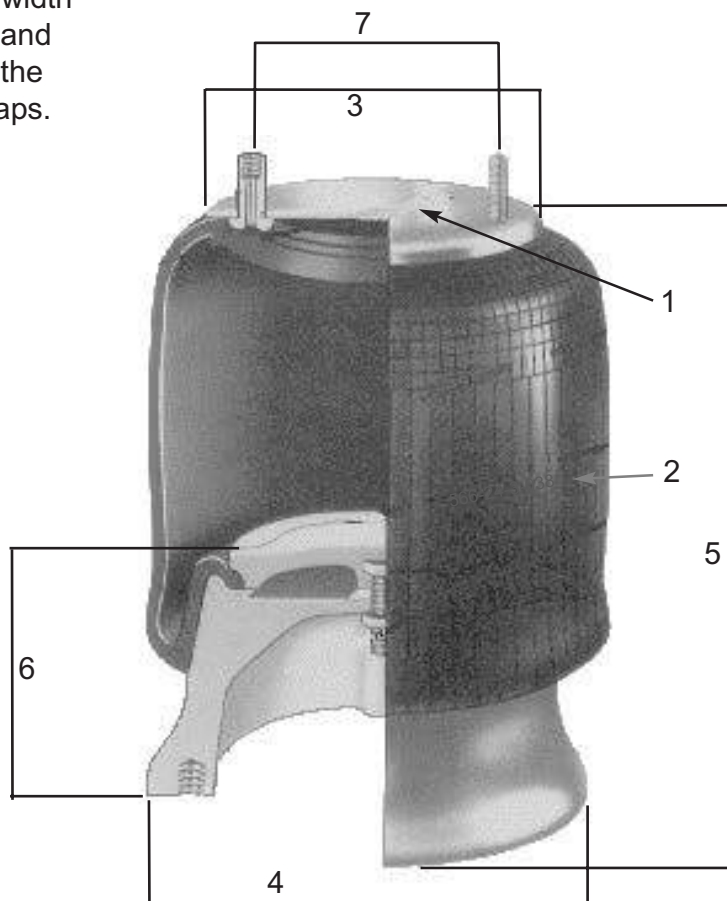

5. Measure the height of the air spring with no air pressure from the top plate to the bottom of the piston. This is the extended height.

6. Compress the bag as far as possible with no air pressure and measure the height. This is the compressed height or minimum height.

7. Measure the distance from center to center of each bolt on the top and bottom of the air spring.



2B DESIGN



3B DESIGN

NOTES:

If the air spring you are replacing has studs (retainers) attached to the top or bottom plate, and the Goodyear Engineered Products Super-Cushion® air spring is identical except that it has recessed, blind taps, use the optional shoulder studs 578-92-9-056. (Pictured to the right.) Screw these into the plate using Loctite #271, or equivalent, thread lock to insure that the studs do not loosen in service.

If you wish to use cap screws or your own bolts to attach air springs with recessed blind nuts to the suspension, the screw must have 3/8-16 threads and must extend no more than 0.562" into the blind taps. Deeper penetration will cause the new air spring to leak and it cannot be repaired satisfactorily.

Air springs with damaged blind taps cannot be considered for warranty claims.

SHOULDER STUD

578-92-9-056

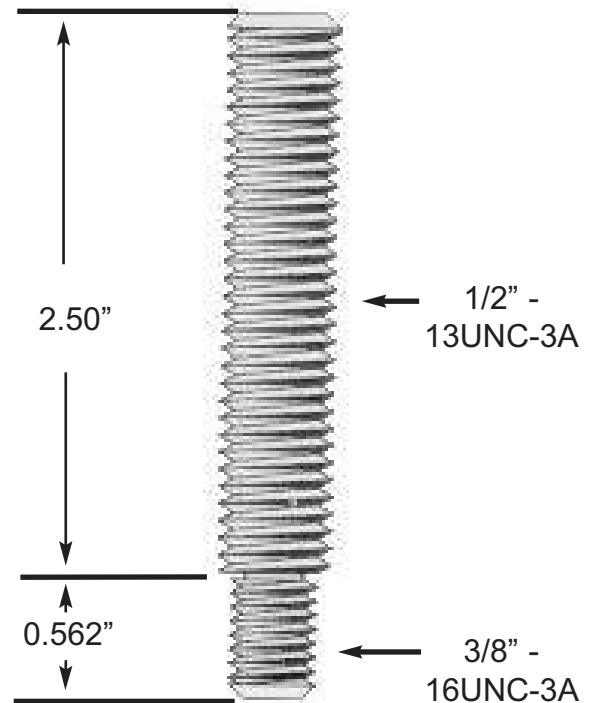

Air Spring Installation

Before you start installing air springs, make sure you have all the necessary tools and equipment to perform the repair safely. Familiarize yourself with the suspension on which you are performing the repair by reviewing the manufacturer's service guide.

If you are in doubt about something, ask for assistance from a qualified suspension specialist, the suspension manufacturer or the air spring manufacturer; it can save you a lot of time and aggravation later in the job.

Here are important tips to remember when installing a new unit:

**When disconnecting the leveling valve linkage, check for bent or broken linkage; if you find any, replace the damaged parts.

**Check shock absorbers for possible replacement. There are usually two warning signs indicating a worn shock. If it can be easily compressed or extended, it is time for a new unit. Also, if the vehicle has just been brought in for service, the shock should be warm to the touch. If not, it needs to be replaced. Remember, proper shock maintenance is one of the keys to long air spring life.

**Once the air lines are disconnected, check the line for cracks or damage. Also check for loose fittings, and replace any worn components.

**Some times the cause of air spring failure is visible and/or readily apparent; other times it is not. When it is not, inspect the air spring after you have removed it to determine the cause of failure and then correct the root cause of the problem.

**With the air spring removed, other parts of the air suspension become more accessible. Check for wear or damage of the frame hangers, trailing arm bushings, torque rods, the trailing arms and the air spring mounts. Again, replace components where necessary.

**Also check the area around the air spring mounting to ensure there are not any obstacles or sharp edges that can damage the new air spring.

**Before installing the new unit, clean the air spring mounting plates to ensure proper attachment to the suspension.

**Always use new attaching bolts for the installation. Old bolts should never be reused since they may fail.

**Check the leveling arm for proper operation. Under load, the leveling arm should move from the neutral position up to the intake position. This lets air into the springs, which brings the arm back to the neutral position. When the load is removed, the leveling arm should move down to the exhaust position. That opens the exhaust valve, allowing air to escape until the arm returns to the neutral position.

Air Spring Installation

NOTES

Add Shoulder Stud #578-92-9-056 where required.

SAFETY & LONGEVITY RULES

1. Use Goodyear Engineered Products Flexible Members on Goodyear Engineered Product Pistons Only.
2. Replace ALL air springs on each axle instead of just one.

Following Rule 1 will prevent component failure due to interference with other suspension parts or other truck/trailer components.

Following Rule 2 will give equal riding heights & bounce response to insure a stable and safer ride.

Any old air spring assemblies which are still serviceable could be carried

AIR SPRING TORQUE REQUIREMENTS

The following values are considered to be the maximum allowable torque for the designated mounting hardware.

Maximum Torque (ft. lbs.)

3/8" - UNC BLIND TAPS	25
1/2" - UNC BOLT OR STUD	25
3/4" - UNC STUD	55
3/4" - UNF COMBO STUD	50

AIR FITTINGS

1/4" NPTF	20
1/2" NPTF	20
3/4" NPTF	20

Air springs failing due to overtorquing will not be considered for warranty claims.

Air Suspension Maintenance Vehicle Check-List

- * Check air lines and fittings for leaks: rubbing on air spring.
- * Check proper clearance around air spring when inflated. Generally, a minimum of 1-1/2" will allow for the increased diameter which occurs in heavy jounce.
- * Periodically, check suspension for proper ride height. This dimension should be maintained +/- 1/4" to protect the springs and shocks from over-extension or frequent bottoming out of the suspension.
- * When doing routine vehicle maintenance, block up the suspension and check for irregular wear or material build-up on the flexmember. Clean, if necessary, using a non-petroleum based cleaning solution.
- * Check rolling lobe piston for material build-up. Hardened debris on the piston will shorten spring life and should be removed as part of your regular maintenance.
- * Check shock absorbers for any signs of leaking hydraulic fluid, broken end connections, worn bushings or cylinders, and over extension.
- * Periodically, check nuts and bolts for proper torque. See manufacturer's manual for specific recommendations.
- * Check height control valve to see that it is functioning properly. Clean or replace, if necessary. A properly maintained valve will save hundreds of dollars in unneeded maintenance expense.

Routine inspection of all of the above, according to a pre-determined mileage maintenance schedule will extend the life of your vehicle and reduce your overall maintenance expense.

SELECTED NON-WARRANTABLE CONDITIONS

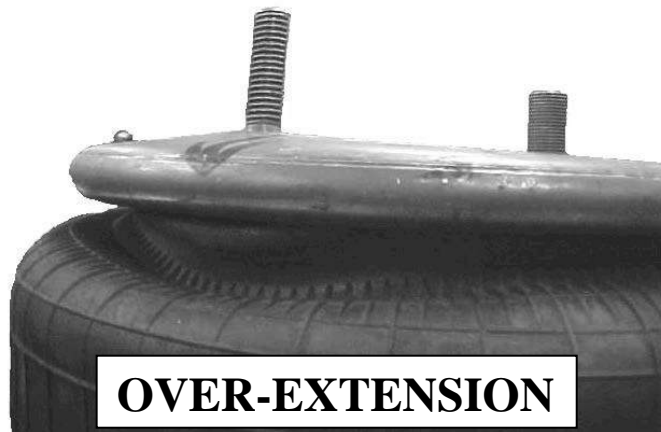

Over-Extension

- Eventual tearing away of the bellows from the top plate or the bottom piston.
- The top plate may appear convex.
- Commonly seen on lift axle applications, particularly on trucks and tractors used in severe on/off road service such as construction, logging, or quarrying.
- Results from operation of the air spring beyond its rated maximum extended height or long-term operation at or near its maximum extended height.

Possible causes:

- Improper restraint of the downward travel of the axle that allows the air spring to operate beyond its rated maximum extended height.
- The ride position is too high due to improper adjustment or improper functioning of the leveling valve.
 - Can result in long-term operation of the air spring at or near its rated maximum extended height.
- Shock absorbers are not functioning properly, are missing or are improperly sized.
- Incorrect air spring for application (too short).

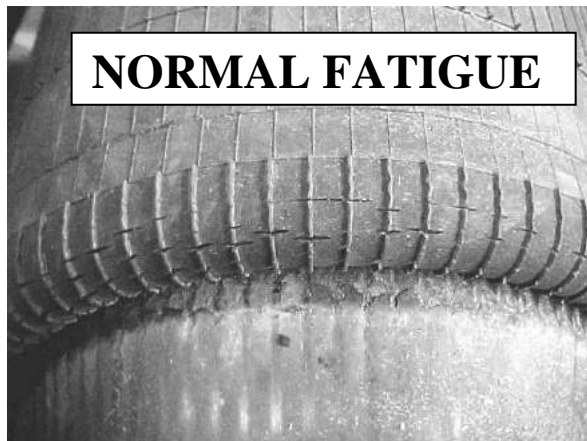

Normal Cycle Fatigue

- Fatigue cracks will appear on the outer surface of the rubber as a normal part of the ageing process.
- Minor cracks are not ordinarily a cause for removal.
- The air spring will still function properly provided there is no air leakage.

SELECTED NON-WARRANTABLE CONDITIONS



DAMAGE FROM CHEMICALS

Rubber Damage from Chemicals

- Grease and oil are common examples that can cause this condition after prolonged contact with the rubber flexible member.

Possible causes:

- Excessive oil in the air supply.
- Excessive greasing of universal joints.
- Excessive greasing of the fifth wheel.
- Leaking seals in suspension components.
- Use of petroleum based cleaners on the air spring (use only soap and water for cleaning).

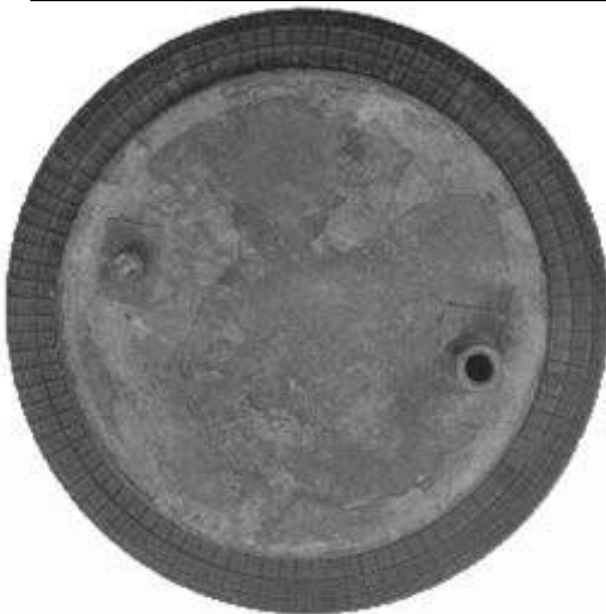

Corrosion and Impacts

- Deterioration of the top plate or piston.

Possible causes:

- Chemical exposure.
- Road debris being flung into the piston causing a crack.
- Pitting from salt.
- Excessive oil or water in the air supply.
- Build-up of debris on the piston, top plate, or girdle hoops (keep clean with soap and water).

CORROSION & IMPACTS

SELECTED NON-WARRANTABLE CONDITIONS



External Abrasion

- A hole rubbed into the side of the bellows.

Possible causes:

- Bellows contact with components on the vehicle (such as air lines).
- Road dirt and debris.
- Worn or failed parts in the suspension.
 - Worn bushing
 - Broken shock
 - misalignment
- Leak or pinch in air line causing spring to be under-inflated.

New Air Springs

<u>New part number</u>	<u>Type</u>	<u>New part number</u>	<u>Type</u>
1B5-510	Bellows	1S4-187	Sleeve
1B12-322	Bellows	1S4-205	Sleeve
1R8-009	Rolling Lobe	1S5-157	Sleeve
1R8-031	Rolling Lobe	1S5-175	Sleeve
1R8-041	Rolling Lobe	1S5-176	Sleeve
1R9-071	Rolling Lobe	1S5-186	Sleeve
1R10-165	Rolling Lobe	1S6-036	Sleeve
1R10-171	Rolling Lobe	1S6-641	Sleeve
1R11-109	Rolling Lobe	1S8-003	Sleeve
1R11-176	Rolling Lobe	2B14-362	Sleeve
1R11-207	Rolling Lobe	2B7-540	Sleeve
1R11-209	Rolling Lobe	2B7-541	Sleeve
1R12-212	Rolling Lobe	3B12-337	Sleeve
1R12-377	Rolling Lobe	3B14-453	Sleeve
1R12-406	Rolling Lobe	3B14-456	Sleeve
1R12-507	Rolling Lobe	3B14-462	Sleeve
1R12-535	Rolling Lobe	3B14-463	Sleeve
1R12-539	Rolling Lobe		
1R12-540	Rolling Lobe		
1R12-545	Rolling Lobe		
1R12-592	Rolling Lobe		
1R12-593	Rolling Lobe		
1R12-645	Rolling Lobe		
1R12-663	Rolling Lobe		
1R12-1047	Rolling Lobe		
1R12-1048	Rolling Lobe		
1R12-1049	Rolling Lobe		
1R13-149	Rolling Lobe		
1R13-235	Rolling Lobe		
1R13-237	Rolling Lobe		
1R13-239	Rolling Lobe		
1R14-117	Rolling Lobe		
1R14-151	Rolling Lobe		
1R14-155	Rolling Lobe		
1R14-164	Rolling Lobe		
1R14-176	Rolling Lobe		
1R14-179	Rolling Lobe		
1R14-198	Rolling Lobe		
1R14-201	Rolling Lobe		
1R14-222	Rolling Lobe		
1R14-232	Rolling Lobe		
1R14-236	Rolling Lobe		
1R14-240	Rolling Lobe		

AIR SPRING BELLOWS

Part No.	Side View With Extended And Compressed Height	Upper Mounting View	Lower Mounting View	Manufacturer Numbers
1B5-510 Flexmember 579-91-3-501		ASC-92-8-109 	ASB-92-6-045 	
1B8-564 Flexmember 579-91-3-532		ASC-92-8-171 	ASB-92-6-055 	
1B12-301 Flexmember 578-91-3-301		ASA-92-8-002 	ASA-92-6-002 	Conti 64595 FS330-11468 FIRESTONE 7009 W013587009 NEWAY 905-57-002 TRIANGLE 4468 TRP AS70090
1B12-305 Flexmember 578-91-3-301		ASA-92-8-006 	ASA-92-6-002 	FIRESTONE 6920 7043 W013586920 W013587043
1B12-306 Flexmember 578-91-3-301		ASA-92-8-002 	ASA-92-6-002 	

- - Bolt or Stud 1/2-13 or 1/2-20
- ⊗ - Air Fitting - 1/4 NPTF
- ⊙ - Stud - 3/4-10
- ⊕ - Tapped Hole on Top Retainers 3/8-16, on Pistons - 1/2-13
- ⊗ - Air Fitting - 1/2 NPTF or 3/8 NPTF
- ⊙ - Combination Stud Air Fitting Stud - 3/4-16; Air Fitting - 1/4 NPTF

AIR SPRING BELLOWS

Part No.	Side View With Extended And Compressed Height	Upper Mounting View	Lower Mounting View	Manufacturer Numbers
1B12-313 <u>Flexmember</u> 578-91-3-301		ASA-92-8-002 	ASA-92-6-002 	Conti 64596 FS330-11474 FIRESTONE W013587008
1B12-322 <u>Flexmember</u> 578-91-3-301		ASB-92-8-164 	ASA-92-6-002 	
1B14-350 <u>Flexmember</u> 578-91-3-351		ASA-92-8-028 	ASA-92-6-013 	Conti 64523 FS530-14442 FIRESTONE 7103 W013587103 PEERLESS 0550-00015 TRIANGLE 4442 TRP AS71030
1B14-351 <u>Flexmember</u> 578-91-3-351		ASA-92-8-028 	ASA-92-6-013 	AMERICAN CARRIER 8003007 Conti 64524 64525 FS530-14446 FS530-14447 FIRESTONE 7105 W013587104 W013587105 TRIANGLE 4447 TRP AS71050
1B14-358 <u>Flexmember</u> 578-91-3-352		ASA-92-8-031 	ASA-92-6-015 	Conti 64521 FS530-14339 DAYTON 354-7112 FIRESTONE 7112 W013587112 INTL/ NAVISTAR 554782C1 LOAD GUARD SC2012 NEWAY 905-57-026 905-57-028 905-57-041 AR-1834 RIDEWELL 1003587112C S-3364-C TRIANGLE 4339

- - Bolt or Stud 1/2-13 or 1/2-20
- ⊗ - Air Fitting - 1/4 NPTF
- ⊙ - Stud - 3/4-10
- ⊕ - Tapped Hole on Top Retainers 3/8-16, on Pistons - 1/2-13
- ⊗ - Air Fitting - 1/2 NPTF or 3/8 NPTF
- ⊙ - Combination Stud Air Fitting Stud - 3/4-16; Air Fitting - 1/4 NPTF

AIR SPRING BELLOWS

Part No.	Side View With Extended And Compressed Height	Upper Mounting View	Lower Mounting View	Manufacturer Numbers
1B14-373 Flexmember 578-91-3-351		ASA-92-8-174 	ASA-92-6-056 	
2B6-530 Flexmember 579-923-510		ASC-92-8-154 	ASB-92-6-051 	
2B6-535 Flexmember 579-92-3-515		ASC-92-8-175 	ASA-92-6-052 	Conti 66094 FD110-15766 LOADAIR P10-754U
2B7-540 Flexmember 579-92-3-525		ASA-92-8-114 	ASB-92-6-049 	
2B7-541 Flexmember 579-92-3-525		ASC-92-8-171 	ASB-92-6-049 	

- - Bolt or Stud 1/2-13 or 1/2-20
- ⊗ - Air Fitting - 1/4 NPTF
- ⊙ - Stud - 3/4-10
- ◐ - Tapped Hole on Top Retainers 3/8-16, on Pistons - 1/2-13
- ⊗ - Air Fitting - 1/2 NPTF or 3/8 NPTF
- ⊗ - Combination Stud Air Fitting Stud - 3/4-16; Air Fitting - 1/4 NPTF

AIR SPRING BELLOWS

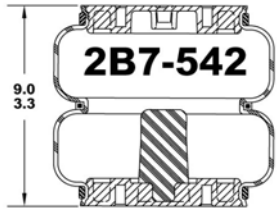
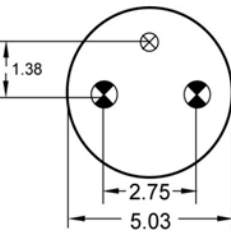
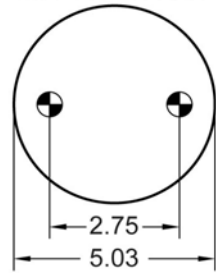
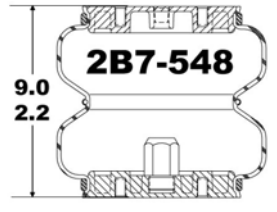
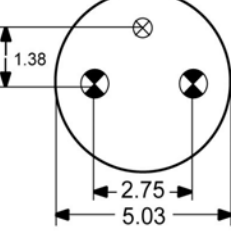
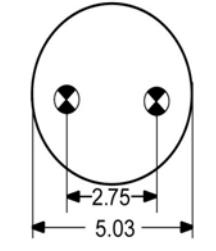
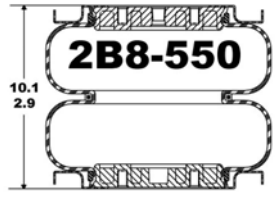
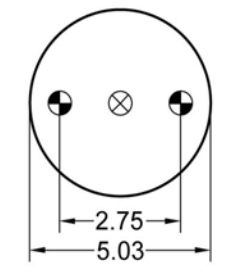
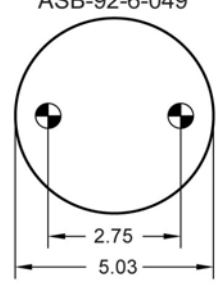
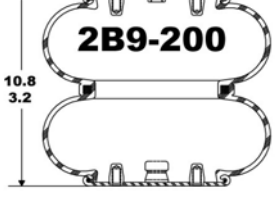
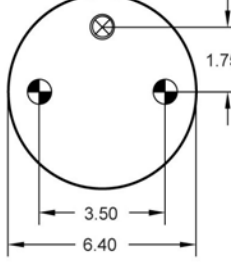
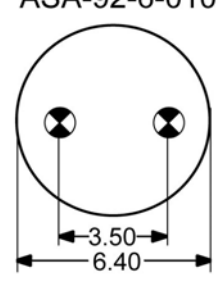
Part No.	Side View With Extended And Compressed Height	Upper Mounting View	Lower Mounting View	Manufacturer Numbers
2B7-542 Flexmember 579-923-525		ASC-92-8-171 	ASB-92-6-058 	
2B7-548 Flexmember 579-92-3-526		ASC-92-8-171 	ASC-92-6-122 	Conti 67667 FD110-17A775 <u>HENDRICKSON</u> 5079 TRP ASC7750
2B8-550 Flexmember 579-92-3-530		ASA-92-8-114 	ASB-92-6-049 	<u>AMERICAN CARRIER</u> 8003006 Conti 64601 FD120-20509 <u>FIRESTONE</u> 7325 W013587325 <u>MACK TRUCK</u> 227QS32 57QK1113 <u>TRIANGLE</u> 4509 <u>WATSON & CHALIN</u> AS-0030
2B9-200 Flexmember 578-92-3-202		ASA-92-8-016 	ASA-92-6-010 	Conti 64267 FD200-19320 DAYTON 354-6910 DINA A-8127-19 <u>FIRESTONE</u> 6910 W013586910 <u>GRANNING</u> 1371 HDA PMABG-6910B HENDRICKSON 45843-3 B-8768 INT'L/ <u>NAVISTAR</u> 554783C1 <u>LOAD GUARD</u> SC2011 MASA 227138412 <u>PREVOST</u> 63-0173 <u>R & S TRUCK & BODY</u> 1027405 <u>RIDEWELL</u> 1003586910C S-4512-C <u>TAURUS</u> AS218-6910 <u>TRIANGLE</u> 4320 TRP AS69100 <u>WATSON & CHALIN</u> AS-0001

- - Bolt or Stud 1/2-13 or 1/2-20
- ⊗ - Air Fitting - 1/4 NPTF
- ⊗ - Stud - 3/4-10
- - Tapped Hole on Top Retainers 3/8-16, on Pistons - 1/2-13
- ⊗ - Air Fitting - 1/2 NPTF or 3/8 NPTF
- ⊗ - Combination Stud Air Fitting Stud - 3/4-16; Air Fitting - 1/4 NPTF

AIR SPRING BELLOWS

Part No.	Side View With Extended And Compressed Height	Upper Mounting View	Lower Mounting View	Manufacturer Numbers
2B9-201 Flexmember 578-92-3-202		ASA-92-8-016 	ASA-92-6-010 	Conti 64515 FD200-19499 DAYTON 354-6902 FIRESTONE 6935 W013586935 FLEETRITE 2B9-491 FREIGHTLINER 16-14318-000 GRANNING 4848 HDA PMABG-6902B HENDRICKSON B-2630 INT'L/ NAVISTAR 554784C1 LOAD GUARD SC2010 MASA 227004001 R & S TRUCK & BODY 1027505 RIDEWELL S-1728-C SAUR AXLES (SAS) P50-733A (LIFT SUSPENSIONS INC. 200042 TAURUS AS218-6902 TRIANGLE 4310 4499 TRP AS69350
2B9-206 Flexmember 578-92-3-202		ASA-92-8-040 	ASA-92-6-010 	Conti 64510 FD200-19315 DAYTON 354-6905 E-Z RIDE 8030120 FIRESTONE 6905 W013586905 HENDRICKSON 45843-1 B-3518 B-5270 INT'L/ NAVISTAR 1685175C1 LOAD GUARD SC2071 RIDEWELL 1003586905C S-2845-C TAURUS AS218-6905 TRIANGLE 4315 TRP AS69050 WATSON & CHALIN AS-0020
2B9-210 Flexmember 578-92-3-202		ASA-92-8-040 	ASA-92-6-010 	Conti 64511 FD200-19362 FIRESTONE 6908 W013586908 TRIANGLE 4362 TRP AS69080 WATSON & CHALIN AS-0035
2B9-216 Flexmember 578-92-3-202		ASA-92-8-060 .750-14 NPTF 	ASA-92-6-010 	DINA AZ-8127-19 PREVOST 63-0174 TRAILERS DE MONTERREY 73312B

- - Bolt or Stud 1/2-13 or 1/2-20
- ⊗ - Air Fitting - 1/4 NPTF
- ⊗ - Stud - 3/4-10
- ⊙ - Tapped Hole on Top Retainers 3/8-16, on Pistons - 1/2-13
- ⊗ - Air Fitting - 1/2 NPTF or 3/8 NPTF
- ⊗ - Combination Stud Air Fitting Stud - 3/4-16; Air Fitting - 1/4 NPTF

AIR SPRING BELLOWS

Part No.	Side View With Extended And Compressed Height	Upper Mounting View	Lower Mounting View	Manufacturer Numbers	
2B9-218 Flexmember 578-92-3-206		ASA-92-8-113 	ASA-92-6-010 	Conti 64553 FD200-25453 FIRESTONE 6927 W013586927 INTL/ NAVISTAR 1685176C1 LOAD GUARD SC2072 REYCO 12906-01 12906-02	TAURUS AS218-6927 TRIANGLE 4453 TRP AS69270
2B9-225 Flexmember 578-92-3-202		ASA-92-8-117 	ASA-92-6-044 	FIRESTONE 6928 W013586928 TTX 1999408	
2B9-229 Flexmember 578-92-3-211		ASA-92-8-113 	ASA-92-6-077 	Conti 64517 FD200-19505 FD200-22706 FIRESTONE 6897 W013586897 FLEETRITE 2B9-490 TRIANGLE 4505 TRP AS68860 AS68970	WATSON & CHALIN AS-0058
2B9-230 Flexmember 578-92-3-202		ASA-92-8-113 	ASA-92-6-044 	Conti 64513 FD200-19450 FIRESTONE 6940 W013586940 TRIANGLE 4450 TRP AS69400	
2B9-239 Flexmember 578-92-3-211		ASA-92-8-016 	ASA-92-6-010 	Conti 64509 FD200-19310 FIRESTONE 6902 W013586902 RIDEWELL 1003586902C TRP AS69020 WATSON & CHALIN AS-0002	

- - Bolt or Stud 1/2-13 or 1/2-20
- ⊗ - Air Fitting - 1/4 NPTF
- ⊙ - Stud - 3/4-10
- ⊖ - Tapped Hole on Top Retainers 3/8-16, on Pistons - 1/2-13
- ⊗ - Air Fitting - 1/2 NPTF or 3/8 NPTF
- ⊗ - Combination Stud Air Fitting Stud - 3/4-16; Air Fitting - 1/4 NPTF

AIR SPRING BELLOWS

Part No.	Side View With Extended And Compressed Height	Upper Mounting View	Lower Mounting View	Manufacturer Numbers
2B9-240 Flexmember 578-92-3-202		ASB-92-9-151 	ASB-92-9-151 	FIRESTONE 7119 W013587119 MCI 12C-1-36 PREVOST 63-0166
2B9-244 Flexmember 578-92-3-202		ASA-92-8-172 	ASA-92-6-044 	
2B9-245 Flexmember 578-92-3-202		ASA-92-8-113 	ASA-92-6-108 	Conti 64519 FD200-19510 FIRESTONE 7788 W013587788 TRIANGLE 4510 WATSON & CHALIN AS-0088
2B9-246 Flexmember 578-92-3-211		ASA-92-8-172 	ASA-92-6-108 	Conti 64514 FD200-19452 FIRESTONE 6932 W013586932 RIDEWELL 1003586932C TRIANGLE 4452
2B9-250 Flexmember 578-92-3-206		ASA-92-8-040 	ASA-92-6-010 	Conti 64549 FD200-25426 FIRESTONE 6943 W013586943 LOAD GUARD SC2122 NEWAY 905-57-237 SUSPENSIONS INC. 200835 TRIANGLE 4426 TRP AS69430 WATSON & CHALIN AS-0041

- - Bolt or Stud 1/2-13 or 1/2-20
- ⊗ - Air Fitting - 1/4 NPTF
- ⊗ - Stud - 3/4-10
- ⊗ - Tapped Hole on Top Retainers 3/8-16, on Pistons - 1/2-13
- ⊗ - Air Fitting - 1/2 NPTF or 3/8 NPTF
- ⊗ - Combination Stud Air Fitting Stud - 3/4-16; Air Fitting - 1/4 NPTF

AIR SPRING BELLOWS

Part No.	Side View With Extended And Compressed Height	Upper Mounting View	Lower Mounting View	Manufacturer Numbers
2B9-251 Flexmember 578-92-3-206		ASA-92-8-040 	ASA-92-6-010 	Conti 64552 FD200-25429 FIRESTONE 6948 W013586948 LOAD GUARD SC2123 RIDEWELL 1003586948C TRIANGLE 4429 TRP AS69480
2B9-252 Flexmember 578-92-3-206		ASA-92-8-172 	ASA-92-6-044 	Conti 64554 FD200-19448 FD200-25454 FIRESTONE 6944 W013586944 HISTEER 10302 LOAD GUARD SC2124 SUSPENSIONS INC. 200118 TRIANGLE 4448 TRP AS69440
2B9-253 Flexmember 578-92-3-206		ASA-92-8-040 	ASA-92-6-010 	Conti 64550 FD200-25427 FIRESTONE 6945 W013586945 LOAD GUARD SC2125 RIDEWELL 1003586945C TRIANGLE 4427 TRP AS69450
2B9-254 Flexmember 578-92-3-206		ASA-92-8-172 	ASA-92-6-010 	Conti 64555 FD200-25463 FIRESTONE 6946 W013586946 LOAD GUARD SC2126 RIDEWELL 1003586946C SUSPENSIONS INC. 200180 TRIANGLE 4463 TRP AS69460
2B9-255 Flexmember 578-92-3-206		ASA-92-8-016 	ASA-92-6-010 	Conti 64551 FD200-25428 DAYTON 354-6947 FIRESTONE 6947 W013586947 HENDRICKSON B-8701 LOAD GUARD SC2127 RIDEWELL 1003586947C TRIANGLE 4428 TRP AS69470

- - Bolt or Stud 1/2-13 or 1/2-20
- ⊗ - Air Fitting - 1/4 NPTF
- ⊙ - Stud - 3/4-10
- ⊖ - Tapped Hole on Top Retainers 3/8-16, on Pistons - 1/2-13
- ⊗ - Air Fitting - 1/2 NPTF or 3/8 NPTF
- ⊙ - Combination Stud Air Fitting Stud - 3/4-16; Air Fitting - 1/4 NPTF

AIR SPRING BELLOWS

Part No.	Side View With Extended And Compressed Height	Upper Mounting View	Lower Mounting View	Manufacturer Numbers
2B9-265 Flexmember 578-92-3-206		ASA-92-8-270 	ASA-92-6-044 	Conti 64512 FD200-19448 FIRESTONE W013586941
2B9-266 Flexmember 578-92-3-208		ASA-92-8-292 	ASA-92-6-044 	Conti 64554 FD200-25-454 FD200-25454 FIRESTONE W013586944 HISTEER 10307 TRIANGLE 4454 TRP AS69440
2B9-270 Flexmember 578-92-3-206		ASA-92-8-298 	ASA-92-6-010 	RIDEWELL 1002B09270G
2B9-280 Flexmember 578-92-3-211		ASA-92-8-172 	ASA-92-6-044 	Conti 64512 FD200-19448 FIRESTONE 6941 W013586941 HISTEER 10302 TRIANGLE 4448 TRP AS69410
2B9-288 Flexmember 578-92-3-211		ASA-92-8-016 	ASA-92-6-010 	Conti 64516 FD200-19504 FIRESTONE 6926 W013586926 TRP AS69260

- - Bolt or Stud 1/2-13 or 1/2-20
- ⊗ - Air Fitting - 1/4 NPTF
- ⊙ - Stud - 3/4-10
- ⊕ - Tapped Hole on Top Retainers 3/8-16, on Pistons - 1/2-13
- ⊗ - Air Fitting - 1/2 NPTF or 3/8 NPTF
- ⊙ - Combination Stud Air Fitting Stud - 3/4-16; Air Fitting - 1/4 NPTF

AIR SPRING BELLOWS

Part No.	Side View With Extended And Compressed Height	Upper Mounting View	Lower Mounting View	Manufacturer Numbers
2B9-296 Flexmember 578-923-211		ASA-92-8-113 	ASA-92-6-125 	
2B9-606 Flexmember 578-923-211		ASA-92-8-040 	ASA-92-6-010 	
2B9-607 Flexmember 578-923-208		ASA-92-8-270 	ASA-92-6-010 	
2B9-611 Flexmember 578-923-211		ASA-92-8-270 	ASA-92-6-134 	
2B9-614 Flexmember 578-9-23-211		ASA-92-8-270 	ASA-92-6-134 	

- - Bolt or Stud 1/2-13 or 1/2-20
- ⊗ - Air Fitting - 1/4 NPTF
- ⊙ - Stud - 3/4-10
- ⊕ - Tapped Hole on Top Retainers 3/8-16, on Pistons - 1/2-13
- ⊗ - Air Fitting - 1/2 NPTF or 3/8 NPTF
- ⊙⊗ - Combination Stud Air Fitting Stud - 3/4-16; Air Fitting - 1/4 NPTF

AIR SPRING BELLOWS

Part No.	Side View With Extended And Compressed Height	Upper Mounting View	Lower Mounting View	Manufacturer Numbers	
2B10-226 <u>Flexmember</u> 578-92-3-250		ASA-92-8-113 	ASA-92-6-010 	Conti 67705 FD200-19713 FD200-22524 FIRESTONE 7795 W013587795 HENDRICKSON B-14486 TRIANGLE 4524	
2B12-300 <u>Flexmember</u> 578-92-3-309		ASA-92-8-003 	ASA-92-6-001 	Conti 64283 FD330-22327 DAYTON 354-7424 FIRESTONE 7424 W013587424 HDA PMABG-7424B INTL/ NAVISTAR 554785C1 LOAD GUARD SC2024	NEWAY 905-57-014 TC-144-2 R & S TRUCK & BODY 1090215 SAUR AXLES (SAS) P10-755 TAURUS AS214-7424 TRIANGLE 4327 WATSON & CHALIN AS-0009
2B12-304 <u>Flexmember</u> 578-92-3-309		ASA-92-8-005 	ASA-92-6-006 	Conti 64501 FD330-22500 FIRESTONE 7344 W013587344 FLXIBLE 6-336-13 6-336-5 SMOOTH RIDE P10-755C	
2B12-305 <u>Flexmember</u> 578-92-3-310		ASA-92-8-026 	ASA-92-6-002 	Conti 64531 FD330-22323 FD330-30323 DAYTON 354-7443 FIRESTONE 7443 W013587443 GRANNING 1218 1589 INTL/	NAVISTAR 554786C1 LOAD GUARD SC2026 RIDEWELL 1003587443C S-2683-C TRIANGLE 4323 WATSON & CHALIN AS-0027

- - Bolt or Stud 1/2-13 or 1/2-20
- ⊗ - Air Fitting - 1/4 NPTF
- - Stud - 3/4-10
- ◐ - Tapped Hole on Top Retainers 3/8-16, on Pistons - 1/2-13
- ⊗ - Air Fitting - 1/2 NPTF or 3/8 NPTF
- ⊗ - Combination Stud Air Fitting Stud - 3/4-16; Air Fitting - 1/4 NPTF

AIR SPRING BELLOWS

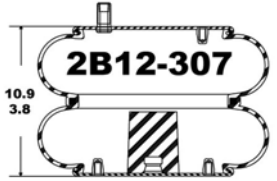
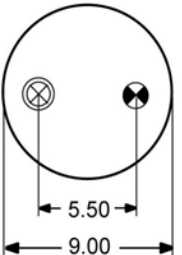
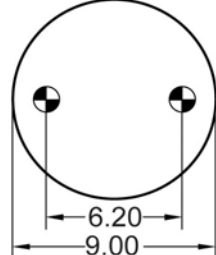
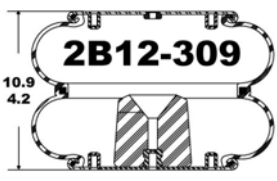
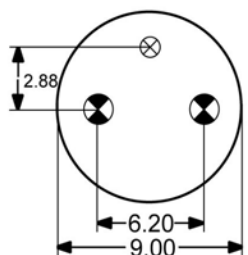
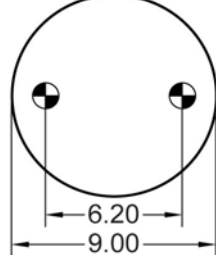
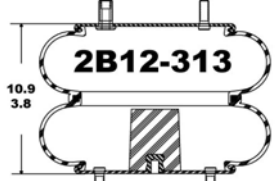
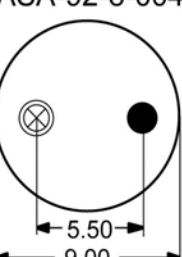
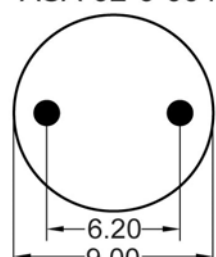
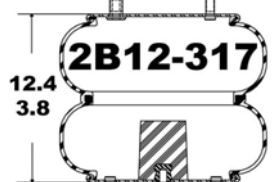
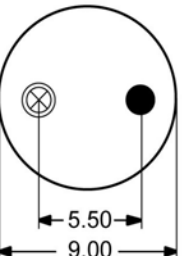
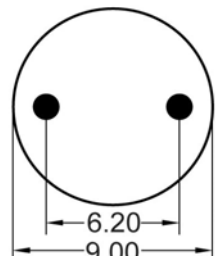
Part No.	Side View With Extended And Compressed Height	Upper Mounting View	Lower Mounting View	Manufacturer Numbers
2B12-307 Flexmember 578-92-3-309		ASA-92-8-017 	ASA-92-6-002 	Conti 64488 FD330-22318 FIRESTONE 7403 W013587403 GRANNING 2725 HDA PMABG-7403B HENDRICKSON B-1159 B-2883 INT'L/ NAVISTAR 554000C1 R & S TRUCK & BODY 1040201 1090201 RIDEWELL S-4302-C SUSPENSIONS INC. 200448 TRIANGLE 4318 WATSON &
2B12-309 Flexmember 578-92-3-309		ASA-92-8-002 	ASA-92-6-002 	Conti 64270 FD330-22313 DAYTON 354-7400 FAB TEK 40080 FIRESTONE 7400 W013587400 FREIGHTLINER 16-10769-000 GMC 693230 GRANNING 2726 HDA PMABG-7400B HENDRICKSON C-1013 INT'L/ NAVISTAR 554788C1 LOAD GUARD SC2020 MASA 227002002 NEWAY 905-57-016 TC-144-4 R & S TRUCK & BODY 1027519 RIDEWELL 1003587400C S-788-C TAURUS AS214-7400 TRIANGLE 4313 WATSON & CHALIN AS-0003
2B12-313 Flexmember 578-92-3-309		ASA-92-8-004 	ASA-92-6-004 	Conti 64494 FD330-22364 DAYTON 354-7405 FIRESTONE 7405 W013587405 HUTCHENS IND. 10384-01 INT'L/ NAVISTAR 1685177C1 LOAD GUARD SC2073 SUSPENSIONS INC. 200981 TAURUS AS214-7405 TRIANGLE 4364
2B12-317 Flexmember 578-92-3-310		ASA-92-8-004 	ASA-92-6-004 	Conti 64539 FD330-30502 FIRESTONE 7499 W013587499 SUSPENSIONS INC. 201602 TRIANGLE 4502

- - Bolt or Stud 1/2-13 or 1/2-20
- ⊗ - Air Fitting - 1/4 NPTF
- ⊙ - Stud - 3/4-10
- ◐ - Tapped Hole on Top Retainers 3/8-16, on Pistons - 1/2-13
- ⊗ - Air Fitting - 1/2 NPTF or 3/8 NPTF
- ⊙ - Combination Stud Air Fitting Stud - 3/4-16; Air Fitting - 1/4 NPTF

AIR SPRING BELLOWS

Part No.	Side View With Extended And Compressed Height	Upper Mounting View	Lower Mounting View	Manufacturer Numbers
2B12-318 Flexmember 578-92-3-309		ASA-92-8-006 	ASA-92-6-002 	FIRESTONE 7185 W013587185
2B12-319 Flexmember 578-92-3-309		ASA-92-8-005 	ASA-92-6-004 	Conti 64497 FD330-22367 DAYTON 354-7409 FIRESTONE 7409 W013587409 INT'L/ NAVISTAR 1685178C1 LOAD GUARD SC2074 TAURUS AS214-7409 TRIANGLE 4367
2B12-320 Flexmember 578-92-3-309		ASA-92-8-003 	ASA-92-6-004 	Conti 64489 FD330-22334 DAYTON 354-7437 FIRESTONE 7401 7437 W013587401 W013587437 GMC 2076095 711954 HDA PMABG-7401B INT'L/ NAVISTAR 554789C1 LOAD GUARD SC2025 NEWAY 905-57-015 TC-144-3A RIDEWELL 1003587437C 1006587437C S-3363-C TRIANGLE 4334 4337 VOLVO 2076095 WATSON & CHALIN AS-0014
2B12-324 Flexmember 578-92-3-310		ASA-92-8-017 	ASA-92-6-002 	Conti 64532 FD330-30340 FD330-30513 DAYTON 354-7447 E-Z RIDE 8030150 FIRESTONE 7447 7790 W013587447 W013587790 HENDRICKSON 1475 B-6242 INT'L/ NAVISTAR 554790C1 LOAD GUARD SC2028 TRIANGLE 4340 4513

- - Bolt or Stud 1/2-13 or 1/2-20
- ⊗ - Air Fitting - 1/4 NPTF
- ⊗ - Stud - 3/4-10
- ⊙ - Tapped Hole on Top Retainers 3/8-16, on Pistons - 1/2-13
- ⊗ - Air Fitting - 1/2 NPTF or 3/8 NPTF
- ⊗ - Combination Stud Air Fitting Stud - 3/4-16; Air Fitting - 1/4 NPTF

AIR SPRING BELLOWS

Part No.	Side View With Extended And Compressed Height	Upper Mounting View	Lower Mounting View	Manufacturer Numbers
2B12-340 Flexmember 578-92-3-309		ASB-92-9-153 	ASB-92-8-153 	FIRESTONE 7124 W013587124 MCI 12C-3-52 PREVOST 63-0185
2B12-345 Flexmember 578-92-3-315		ASA-92-8-005 	ASA-92-6-002 	Conti 64597 FD331-26514 FIRESTONE 7545 W013587545 HENDRICKSON 1796 TRIANGLE 4514 WATSON & CHALIN AS-0087-1F
2B12-346 Flexmember 578-92-3-315		ASA-92-8-005 	ASA-92-6-002 	Conti 64599 FD331-26-541 FD331-26541 FIRESTONE 7550 W013587550 HISTEER 10315 TRIANGLE 4541 WATSON & CHALIN AS-0087
2B12-402 Flexmember 578-92-3-310		ASA-92-8-005 	ASA-92-6-002 	Conti 64534 FD330-30370 DAYTON 354-7446 FIRESTONE 7446 W013587446 HDA PMABG-7446B HENDRICKSON B-3798 INT'L/ NAVISTAR 554791C1 LOAD GUARD SC2027 R & S TRUCK & BODY 1082914 SILENT DRIVE AS-7446 TRIANGLE 4370 WATSON & CHALIN AS-0005
2B12-406 Flexmember 578-92-3-309		ASA-92-8-005 	ASA-92-6-002 	Conti 64268 FD330-22331 DAYTON 354-7410 FIRESTONE 7410 W013587410 FREIGHTLINER 16-11378-000 INT'L/ NAVISTAR 554792C1 LOAD GUARD SC2023 TAURUS AS214-7410 TRIANGLE 4331 TRP AS74100

- - Bolt or Stud 1/2-13 or 1/2-20
- ⊗ - Air Fitting - 1/4 NPTF
- ⊙ - Stud - 3/4-10
- (with horizontal line) - Tapped Hole on Top Retainers 3/8-16, on Pistons - 1/2-13
- ⊗ (with horizontal line) - Air Fitting - 1/2 NPTF or 3/8 NPTF
- ⊙ (with horizontal line) - Combination Stud Air Fitting Stud - 3/4-16; Air Fitting - 1/4 NPTF

AIR SPRING BELLOWS

Part No.	Side View With Extended And Compressed Height	Upper Mounting View	Lower Mounting View	Manufacturer Numbers	
2B12-410 Flexmember 578-92-3-309		ASA-92-8-017 	ASA-92-6-004 	Conti 64492 FD330-22346 DAYTON 354-7404 FIRESTONE 7404 W013587404 HENDRICKSON B-1345 B-5468 INTL/ NAVISTAR 554793C1	LOAD GUARD SC2022 TAURUS AS214-7404 TRIANGLE 4346
2B12-411 Flexmember 578-92-3-309		ASA-92-8-088 	ASA-92-6-006 	Conti 64500 FD330-22472 DAYTON 354-7181 FIRESTONE 7181 W013587181 FRUEHAUF UAB-5620 UCC-3054-1 INTL/ NAVISTAR 554794C1	LOAD GUARD SC2018 TAURUS AS214-7181 TRIANGLE 4472
2B12-412 Flexmember 578-92-3-309		ASA-92-8-088 	ASA-92-6-038 	Conti 64499 FD330-22471 DAYTON 354-7183 FIRESTONE 7183 W013587183 FRUEHAUF UCA-0112 UCA-0112B INTL/ NAVISTAR 554795C1	LOAD GUARD SC2019 TAURUS AS214-7183 TRIANGLE 4471
2B12-416 Flexmember 578-92-3-315		ASA-92-8-002 	ASA-92-6-002 	Conti 64533 FD330-30369 FIRESTONE 7444 W013587444 HENDRICKSON B-9830 TRIANGLE 4369	
2B12-424 Flexmember 578-92-3-309		ASA-92-8-006 	ASA-92-6-002 	TRAILERS DE MONTERREY 73312A	

- - Bolt or Stud 1/2-13 or 1/2-20
- ⊗ - Air Fitting - 1/4 NPTF
- ⊙ - Stud - 3/4-10
- ⊕ - Tapped Hole on Top Retainers 3/8-16, on Pistons - 1/2-13
- ⊗ - Air Fitting - 1/2 NPTF or 3/8 NPTF
- ⊗ - Combination Stud Air Fitting Stud - 3/4-16; Air Fitting - 1/4 NPTF

AIR SPRING BELLOWS

Part No.	Side View With Extended And Compressed Height	Upper Mounting View	Lower Mounting View	Manufacturer Numbers
2B12-425 Flexmember 578-92-3-309		ASA-92-8-002 	ASA-92-6-002 	Conti 64493 FD330-22363 E-Z RIDE 8030190 FIRESTONE 7180 W013587180 INT'L/ NAVISTAR 1685179C1 LOAD GUARD SC2075 NEWAY 570-07-180 PEERLESS 0550-00001 RIDEWELL 1003587180C S-4538-C TAURUS AS214-7180 TRIANGLE 4363
2B12-426 Flexmember 578-92-3-309		ASA-92-8-003 	ASA-92-6-002 	Conti 64495 FD330-22365 DAYTON 354-7406 FIRESTONE 7406 W013587406 INT'L/ NAVISTAR 1685180C1 LOAD GUARD SC2076 RIDEWELL 1003587406C S-3159-C TAURUS AS214-7406 TRIANGLE 4365
2B12-427 Flexmember 578-92-3-309		ASA-92-8-004 	ASA-92-6-002 	Conti 64491 FD330-22343 DAYTON 354-7429 FIRESTONE 7429 W013587429 INT'L/ NAVISTAR 1685181C1 KWIK-LOK / TODCO CP-5223 LOAD GUARD SC2077 TAURUS AS214-7429 TRIANGLE 4343
2B12-428 Flexmember 578-92-3-310		ASA-92-8-002 	ASA-92-6-002 	Conti 64536 FD330-30372 FIRESTONE 7473 W013587473 INT'L/ NAVISTAR 1685182C1 LOAD GUARD SC2078 RIDEWELL 1003587473C TRIANGLE 4372
2B12-429 Flexmember 578-92-3-309		ASA-92-8-006 .750-14 NPTF 	ASA-92-6-002 	Conti 66300 FD330-22780 FIRESTONE 7184 W013587184





- - Bolt or Stud 1/2-13 or 1/2-20
- ⊗ - Air Fitting - 1/4 NPTF
- ⊙ - Stud - 3/4-10
- ⊖ - Tapped Hole on Top Retainers 3/8-16, on Pistons - 1/2-13
- ⊗ - Air Fitting - 1/2 NPTF or 3/8 NPTF
- ⊙ - Combination Stud Air Fitting Stud - 3/4-16; Air Fitting - 1/4 NPTF

AIR SPRING BELLOWS

Part No.	Side View With Extended And Compressed Height	Upper Mounting View	Lower Mounting View	Manufacturer Numbers
2B12-432 Flexmember 578-92-3-309		ASA-92-8-005 	ASA-92-6-001 	Conti 4465 64498 FD330-22368 FD330-22465 FIRESTONE 7423 W013587423 INT'L/ NAVISTAR 1681750C1 LOAD GUARD SC2101 TRIANGLE 4368
2B12-434 Flexmember 578-92-3-310		ASA-92-8-017 	ASA-92-6-002 	Conti 64535 FD330-30371 FD330-30464 FIRESTONE 7472 W013587472 HENDRICKSON 36514-5 B-12514-005 INT'L/ NAVISTAR 1681751C1 LOAD GUARD SC2128 SAUR AXLES (SAS) PB10-784 TRIANGLE 4371 4464
2B12-440 Flexmember 578-92-3-315		ASA-92-8-005 	ASA-92-6-004 	Conti 64284 FD331-26480 FIRESTONE 7555 W013587555 HENDRICKSON 20018 REYCO 18813-01 20018-01 TRIANGLE 4480 TRP AS75550
2B12-446 Flexmember 578-92-3-310		ASA-92-8-002 	ASA-92-6-002 	Conti 64533 FD330-30369 FIRESTONE 7444 W013587444 HENDRICKSON B-9830 TRIANGLE 4369
2B12-463 Flexmember 578-92-3-309		ASA-92-8-257 	ASA-92-6-002 	Conti 64502 FD330-22540 FIRESTONE 6850 W013586850 RIDEWELL 1003586850C TRP AS68500

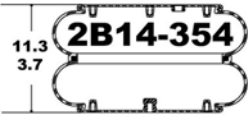
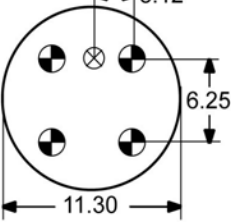
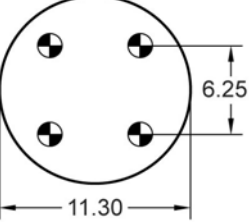
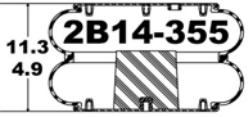
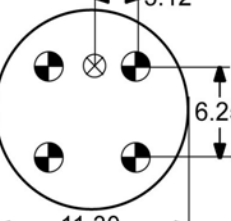
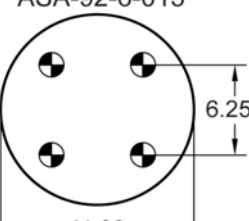
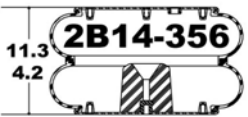
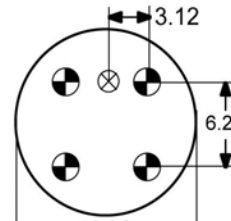
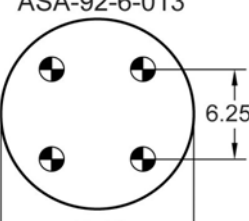
- - Bolt or Stud 1/2-13 or 1/2-20
- ⊗ - Air Fitting - 1/4 NPTF
- ⊙ - Stud - 3/4-10
- ◐ - Tapped Hole on Top Retainers 3/8-16, on Pistons - 1/2-13
- ⊗ - Air Fitting - 1/2 NPTF or 3/8 NPTF
- ⊗ - Combination Stud Air Fitting Stud - 3/4-16; Air Fitting - 1/4 NPTF

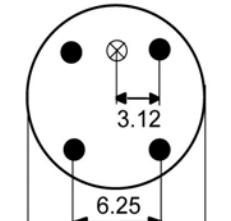
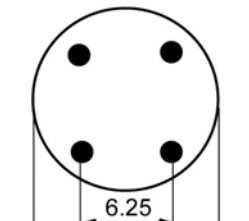
AIR SPRING BELLOWS

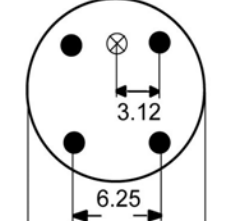
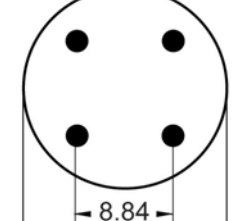
Part No.	Side View With Extended And Compressed Height	Upper Mounting View	Lower Mounting View	Manufacturer Numbers	
2B14-354 <u>Flexmember</u> 578-92-3-353		ASA-92-8-028 	ASA-92-6-013 	Conti 64548 FD530-22374 DAYTON 354-7145 FIRESTONE 7145 W013587145 INT'L/ NAVISTAR 554796C1 LOAD GUARD SC2016	MACK TRUCK 57QL239 RIDEWELL 1003587145C S-4540-C TRIANGLE 4374 VOLVO 35203-0005 35203-3204
2B14-355 <u>Flexmember</u> 578-92-3-353		ASA-92-8-028 	ASA-92-6-013 	AMERICAN CARRIER 8003005 Conti 64546 FD530-22342 DAYTON 354-7146 FIRESTONE 7146 W013587146 INT'L/ NAVISTAR 554797C1	LOAD GUARD SC2017 NEWAY 905-57-039 AR-1520 RIDEWELL 1003587146C TRIANGLE 4342
2B14-356 <u>Flexmember</u> 578-92-3-353		ASA-92-8-028 	ASA-92-6-013 	Conti 64545 FD530-22321 FIRESTONE 7136 W013587136 GRANNING 1626 HDA PMABG-7136B HENDRICKSON B-1080 INT'L/	NAVISTAR 554798C1 LOAD GUARD SC2014 R & S TRUCK & BODY 1027556 RIDEWELL 1003587136C TRIANGLE 4321 WATSON & CHALIN AS-0004
2B14-359 <u>Flexmember</u> 578-92-3-353		ASA-92-8-031 	ASA-92-6-015 	Conti 64544 FD530-22316 FIRESTONE 7140 W013587140 GRANNING 1015 HDA PMABG-7140B HENDRICKSON B-3184 INT'L/	NAVISTAR 554799C1 LOAD GUARD SC2015 R & S TRUCK & BODY 1090214 RIDEWELL 1003587140C TRIANGLE 4316 WATSON & CHALIN AS-0008
2B14-360 <u>Flexmember</u> 578-92-3-353		ASA-92-8-031 	ASA-92-6-015 	Conti 64543 FD530-22311 DAYTON 354-7135 FIRESTONE 7135 W013587135 HENDRICKSON B-12514-014 INT'L/ NAVISTAR 554800C1	LOAD GUARD SC2013 NEWAY 905-57-001 PEZZANI AR-21-A RIDEWELL 1003587135C S-1326-C TRIANGLE 4311 TRUCKSTELL 63641 63644

- - Bolt or Stud 1/2-13 or 1/2-20
- ⊗ - Air Fitting - 1/4 NPTF
- ⊙ - Stud - 3/4-10
- ⊕ - Tapped Hole on Top Retainers 3/8-16, on Pistons - 1/2-13
- ⊗ - Air Fitting - 1/2 NPTF or 3/8 NPTF
- ⊙ - Combination Stud Air Fitting Stud - 3/4-16; Air Fitting - 1/4 NPTF

AIR SPRING BELLOWS

Part No.	Side View With Extended And Compressed Height	Upper Mounting View	Lower Mounting View	Manufacturer Numbers
2B14-362 Flexmember 566-92-3-356		ASA-92-8-028 	ASA-92-6-013 	FIRESTONE 6800
2B14-363 Flexmember 578-92-3-356		ASA-92-8-030 	ASA-92-6-013 	
2B14-365 Flexmember 578-92-3-356		ASA-92-8-046 	ASA-92-6-014 	Conti 64590 FD530-30451 DAYTON 354-6801 E-Z RIDE 8030160 FIRESTONE 6801 W013586801 HENDRICKSON B-2734 INT'L/ NAVISTAR 1685183C1 LOAD GUARD SC2079 RIDEWELL 1003586801C TRIANGLE 4451 TRP AS68010 WATSON & CHALIN AS-0021
2B14-366 Flexmember 578-92-3-353		ASA-92-8-100 	ASA-92-6-015 	Conti 64589 FD530-30449 DAYTON 354-6803 FIRESTONE 6803 W013586803 HENDRICKSON B-6412 LOAD GUARD SC2129 TRIANGLE 4449 TRP AS68030
2B14-367 Flexmember 578-92-3-353		ASA-92-8-049 	ASA-92-6-043 	Conti 64547 FD530-22345 DAYTON 354-7123 FIRESTONE 7123 7133 W013587123 W013587133 INT'L/ NAVISTAR 1685184C1 KWIK-LOK / TODCO 53671 LOAD GUARD SC2080 TRIANGLE 4345

- - Bolt or Stud 1/2-13 or 1/2-20
- ⊗ - Air Fitting - 1/4 NPTF
- ⊙ - Stud - 3/4-10
- ⊕ - Tapped Hole on Top Retainers 3/8-16, on Pistons - 1/2-13
- ⊗ - Air Fitting - 1/2 NPTF or 3/8 NPTF
- ⊗ - Combination Stud Air Fitting Stud - 3/4-16; Air Fitting - 1/4 NPTF

AIR SPRING BELLOWS

Part No.	Side View With Extended And Compressed Height	Upper Mounting View	Lower Mounting View	Manufacturer Numbers
2B14-383 Flexmember 578-92-3-356		ASA-92-8-174 	ASA-92-6-118 	Conti 64604 FD530-35530 FIRESTONE 7557 W013587557 HISTEER 10316 REYCO 19983-01 TRIANGLE 4530 WATSON & CHALIN AS-0089
2B14-462 Flexmember 578-92-3-356		ASA-92-8-030 	ASA-92-6-013 	Conti 64593 FD530-30532 FD530-35720 FIRESTONE 6805 W013586805 RIDEWELL 1003586805C TRP AS68050
2B14-469 Flexmember 566-23-8-329		ASA-92-8-352 	ASA-92-6-016 	NEWAY 905-57-257
2B14-470 Flexmember 578-92-3-356		ASA-92-8-031 	ASA-92-6-015 	Conti 64606 FD530-35544 FIRESTONE 7782 W013587782 TRIANGLE 4544 WATSON & CHALIN AS-0032
2B14-473 Flexmember 578-92-3-353		ASA-92-8-046 	ASA-92-6-014 	

- - Bolt or Stud 1/2-13 or 1/2-20
- ⊗ - Air Fitting - 1/4 NPTF
- ⊙ - Stud - 3/4-10
- ⊖ - Tapped Hole on Top Retainers 3/8-16, on Pistons - 1/2-13
- ⊗ - Air Fitting - 1/2 NPTF or 3/8 NPTF
- ⊙ - Combination Stud Air Fitting Stud - 3/4-16; Air Fitting - 1/4 NPTF

AIR SPRING BELLOWS

Part No.	Side View With Extended And Compressed Height	Upper Mounting View	Lower Mounting View	Manufacturer Numbers
2B14-476 <u>Flexmember</u> 578-92-3-356		ASA-92-8-352 	ASA-92-6-016 	Conti 64605 FD530-35543 FIRESTONE 6799 W013586799 NEWAY 905-57-203 TRP AS67990 WATSON & CHALIN AS-0034
2B14-479 <u>Flexmember</u> 578-923-356		ASA-92-8-030 	ASA-92-6-013 	
3B12-300 <u>Flexmember</u> 578-93-3-100		ASA-92-8-017 	ASA-92-6-002 	Conti 64562 FT330-29431 FT330-29469 DAYTON 354-8008 FIRESTONE 8008 8025 W013588008 W013588025 HENDRICKSON B-11637 LOAD GUARD SC2130 RIDEWELL 1003588008C TRIANGLE 4431 4469 WATSON & CHALIN AS-0019
3B12-301 <u>Flexmember</u> 578-93-3-100		ASA-92-8-002 	ASA-92-6-002 	Conti 64563 FT330-29432 FT330-29498 FIRESTONE 8010 8030 W013588010 W013588030 LOAD GUARD SC2119 RIDEWELL 1003588010C 1003588030C S-5844-C TRIANGLE 4432
3B12-303 <u>Flexmember</u> 578-93-3-100		ASA-92-8-005 	ASA-92-6-002 	Conti 64285 FT330-29434 FIRESTONE 8018 W013588018 HISTEER 10303 LOAD GUARD SC2131 TRIANGLE 4434 WATSON & CHALIN AS-0075

- - Bolt or Stud 1/2-13 or 1/2-20
- ⊗ - Air Fitting - 1/4 NPTF
- ⊙ - Stud - 3/4-10
- ◐ - Tapped Hole on Top Retainers 3/8-16, on Pistons - 1/2-13
- ⊗ - Air Fitting - 1/2 NPTF or 3/8 NPTF
- ⊗ - Combination Stud Air Fitting Stud - 3/4-16; Air Fitting - 1/4 NPTF

AIR SPRING BELLOWS

Part No.	Side View With Extended And Compressed Height	Upper Mounting View	Lower Mounting View	Manufacturer Numbers
3B12-304 Flexmember 578-93-3-100		ASA-92-8-002 	ASA-92-6-000 	Conti 64568 FT330-29503 FIRESTONE 8006 W013588006 LOAD GUARD SC2132 SUSPENSIONS INC. 200620 TRIANGLE 4430 4503
3B12-305 Flexmember 578-93-3-100		ASA-92-8-006 .750-14 NPTF 	ASA-92-6-002 	
3B12-310 Flexmember 578-93-3-100		ASA-92-8-005 	ASA-92-6-002 	Conti 64565 FT330-29466 FIRESTONE 8027 W013588027 SILENT DRIVE AS-8025 AS-8027 SUSPENSIONS INC. 200117 TRIANGLE 4466
3B12-312 Flexmember 578-93-3-100		ASA-92-8-005 	ASA-92-6-035 	Conti 64571 FT330-29508 FT330-29525 FIRESTONE 8033 W013588033 HENDRICKSON B-14487 LOAD GUARD SC2784 TRIANGLE 4508 4525
3B12-315 Flexmember 578-93-3-100		ASA-92-8-017 	ASA-92-6-111 	Conti 64573 FT330-29547

- - Bolt or Stud 1/2-13 or 1/2-20
- ⊗ - Air Fitting - 1/4 NPTF
- ⊙ - Stud - 3/4-10
- ◐ - Tapped Hole on Top Retainers 3/8-16, on Pistons - 1/2-13
- ⊗ - Air Fitting - 1/2 NPTF or 3/8 NPTF
- ⊗ - Combination Stud Air Fitting Stud - 3/4-16; Air Fitting - 1/4 NPTF

AIR SPRING BELLOWS

Part No.	Side View With Extended And Compressed Height	Upper Mounting View	Lower Mounting View	Manufacturer Numbers
3B12-319 Flexmember 578-93-3-100		ASA-92-8-017 	ASA-92-6-002 	Conti 64560 FT330-29413 FIRESTONE 8032 W013588032 HENDRICKSON B-12405 S-12405 TRIANGLE 4413 WATSON & CHALIN AS-0048
3B12-322 Flexmember 578-93-3-103		ASA-92-8-230 	ASA-92-6-110 	FIRESTONE 8042 W013588042 HENDRICKSON 1015 NEWAY 905-57-236
3B12-323 Flexmember 578-93-3-103		ASA-92-8-367 	ASA-92-6-110 	FIRESTONE 8043 W013588043 HENDRICKSON S-14795
3B12-324 Flexmember 578-93-3-100		ASA-92-8-159 	ASA-92-6-002 	WATSON & CHALIN AS-0048-2G
3B12-325 Flexmember 578-93-3-103		ASA-92-8-363 	ASA-92-6-106 	FIRESTONE 8048 W013588048

- - Bolt or Stud 1/2-13 or 1/2-20
- ⊗ - Air Fitting - 1/4 NPTF
- ⊙ - Stud - 3/4-10
- ◐ - Tapped Hole on Top Retainers 3/8-16, on Pistons - 1/2-13
- ⊗ - Air Fitting - 1/2 NPTF or 3/8 NPTF
- ⊗ - Combination Stud Air Fitting Stud - 3/4-16; Air Fitting - 1/4 NPTF

AIR SPRING BELLOWS

Part No.	Side View With Extended And Compressed Height	Upper Mounting View	Lower Mounting View	Manufacturer Numbers
3B12-326 Flexmember 578-93-3-103		ASA-92-8-364 	ASA-92-6-106 	FIRESTONE 8047 W013588047
3B12-328 Flexmember 578-93-3-100		ASA-92-8-017 	ASA-92-6-111 	Conti 64572 FT330-29546 FIRESTONE 7994 W013587994 TRIANGLE 4546 WATSON & CHALIN AS-0019-1F
3B12-329 Flexmember 578-93-3-100		ASA-92-8-159 	ASA-92-6-111 	Conti 64573 FT330-29547 FIRESTONE 7990 W013587990 W013587995 TRIANGLE 4547 WATSON & CHALIN AS-0048-1F
3B12-335 Flexmember 578-93-3-100		ASA-92-8-005 	ASA-92-6-111 	Conti 64570 FT330-29520 FT330-29723 FIRESTONE 7996 W013587996 GRANNING 8221 TRIANGLE 4520
3B12-337 Flexmember 578-93-3-104		ASA-92-8-406 	ASA-92-6-110 	

- - Bolt or Stud 1/2-13 or 1/2-20
- ⊗ - Air Fitting - 1/4 NPTF
- ⊙ - Stud - 3/4-10
- ◐ - Tapped Hole on Top Retainers 3/8-16, on Pistons - 1/2-13
- ⊗ - Air Fitting - 1/2 NPTF or 3/8 NPTF
- ⊙ - Combination Stud Air Fitting Stud - 3/4-16; Air Fitting - 1/4 NPTF

AIR SPRING BELLOWS

Part No.	Side View With Extended And Compressed Height	Upper Mounting View	Lower Mounting View	Manufacturer Numbers
3B12-338 <u>Flexmember</u> 578-93-3-100	<p>18.0 5.1</p> <p>3B12-338</p>	ASA-92-8-331 <p>5.50 9.00</p>	ASA-92-6-002 <p>6.20 9.00</p>	
3B12-342 <u>Flexmember</u> 578-93-3-100	<p>18.0 4.5</p> <p>3B12-342</p>	ASA-92-8-431 <p>6.20 9.00</p>	ASA-92-6-002 <p>6.20 9.00</p>	WATSON & CHALIN AS-0048-3G
3B12-347 <u>Flexmember</u> 578-93-3-103	<p>19.0 4.5</p> <p>3B12-347</p>	ASA-92-8-367 <p>6.20 10.30</p>	ASA-92-6-121 <p>6.20 10.30</p>	
3B12-415 <u>Flexmember</u> 578-93-3-105	<p>19.5 4.6</p> <p>3B12-415</p>	ASA-92-8-017 <p>5.50 9.00</p>	ASA-92-6-002 <p>6.20 9.00</p>	Conti 66522 FT330-29554 FIRESTONE 8038 W013588038 HISTEER 10313
3B12-416 <u>Flexmember</u> 578-93-3-105	<p>19.5 4.6</p> <p>3B12-416</p>	ASA-92-8-005 <p>6.20 9.00</p>	ASA-92-6-002 <p>6.20 9.00</p>	FIRESTONE 8039 W013588039 HISTEER 10303

- - Bolt or Stud 1/2-13 or 1/2-20
- ⊗ - Air Fitting - 1/4 NPTF
- ⊙ - Stud - 3/4-10
- ⊕ - Tapped Hole on Top Retainers 3/8-16, on Pistons - 1/2-13
- ⊗ - Air Fitting - 1/2 NPTF or 3/8 NPTF
- ⊙ - Combination Stud Air Fitting Stud - 3/4-16; Air Fitting - 1/4 NPTF

AIR SPRING BELLOWS

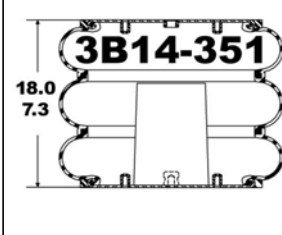
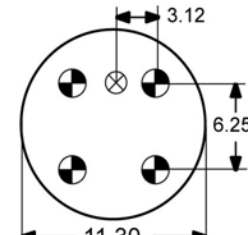
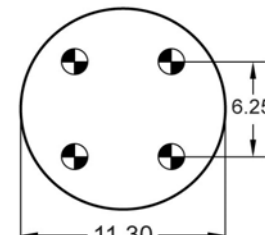
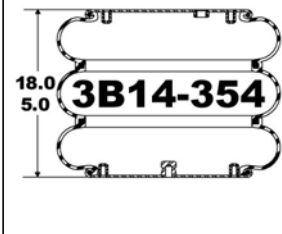
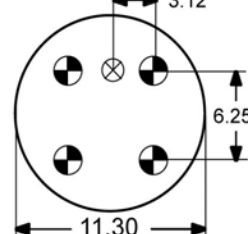
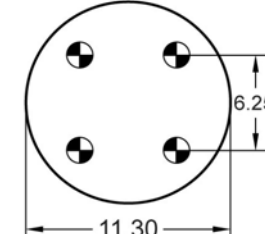
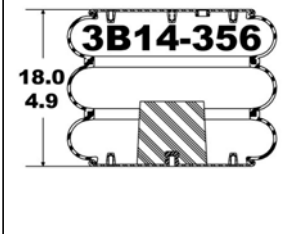
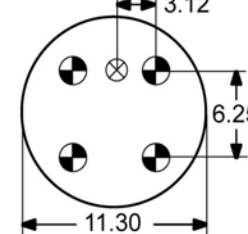
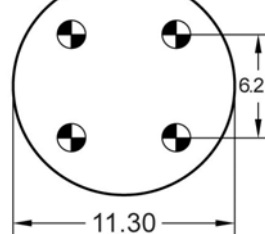
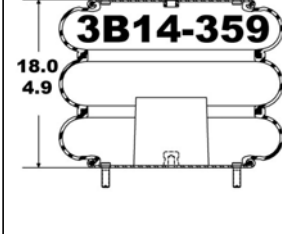
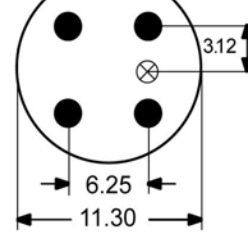
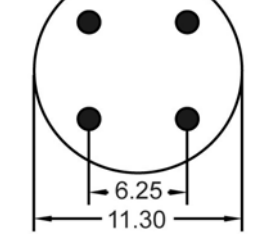
Part No.	Side View With Extended And Compressed Height	Upper Mounting View	Lower Mounting View	Manufacturer Numbers
3B14-351 Flexmember 578-93-3-350		ASA-92-8-028 	ASA-92-6-013 	
3B14-354 Flexmember 578-93-3-350		ASA-92-8-028 	ASA-92-6-013 	Conti 64506 FT530-32336 E-Z RIDE 8030170 FIRESTONE 7808 W013587808 INT'L/ NAVISTAR 554801C1 LOAD GUARD SC2031 PEERLESS 0550-00030 RIDEWELL 1003587808C S-4830-C TRIANGLE 4336 TRUCKSTELL 63640
3B14-356 Flexmember 578-93-3-350		ASA-92-8-028 	ASA-92-6-013 	Conti 64504 FT530-32329 DAYTON 354-7798 FIRESTONE 7798 W013587798 GRANNING 1613 HDA PMABG-7798B INT'L/ NAVISTAR 554802C1 LOAD GUARD SC2029 TRIANGLE 4329 4436 WATSON & CHALIN AS-0006
3B14-359 Flexmember 578-93-3-350		ASA-92-8-031 	ASA-92-6-015 	Conti 64503 FT530-32325 DAYTON 354-7818 E-Z RIDE 8030180 FIRESTONE 7816 7818 W013587816 W013587818 GRANNING 1014 1476 HENDRICKSON B-6861 INT'L/ NAVISTAR 554803C1 LOAD GUARD SC2032 RIDEWELL 1003587818C 1003587839C S-2685-C TRIANGLE 4325 4437 WATSON & CHALIN AS-0025 AS-0033

- - Bolt or Stud 1/2-13 or 1/2-20
- ⊗ - Air Fitting - 1/4 NPTF
- ⊙ - Stud - 3/4-10
- ◐ - Tapped Hole on Top Retainers 3/8-16, on Pistons - 1/2-13
- ⊗ - Air Fitting - 1/2 NPTF or 3/8 NPTF
- ⊙ - Combination Stud Air Fitting Stud - 3/4-16; Air Fitting - 1/4 NPTF

AIR SPRING BELLOWS

Part No.	Side View With Extended And Compressed Height	Upper Mounting View	Lower Mounting View	Manufacturer Numbers
3B14-360 <u>Flexmember</u> 578-93-3-350		ASA-92-8-031 	ASA-92-6-015 	Conti 64505 FT530-32333 DAYTON 354-7800 FIRESTONE 7800 W013587800 GRANNING 4514 HOLLAND HITCH 4514 INT'L/ NAVISTAR 554804C1 LOAD GUARD SC2030 RIDEWELL 1003587800C S-1505-C TRIANGLE 4333 4439
3B14-361 <u>Flexmember</u> 578-93-3-350		ASA-92-8-030 	ASA-92-6-013 	
3B14-364 <u>Flexmember</u> 578-93-3-350		ASA-92-8-100 	ASA-92-6-015 	Conti 64581 FT530-35455 HENDRICKSON B-7100 TRIANGLE 4455
3B14-365 <u>Flexmember</u> 578-93-3-350		ASA-92-8-100 	ASA-92-6-015 	
3B14-367 <u>Flexmember</u> 578-93-3-350		ASA-92-8-100 	ASA-92-6-050 	Conti 64583 FT530-35457 DAYTON 354-7847 HENDRICKSON B-8874 TRIANGLE 4457

- - Bolt or Stud 1/2-13 or 1/2-20
- ⊗ - Air Fitting - 1/4 NPTF
- ⊙ - Stud - 3/4-10
- ⊕ - Tapped Hole on Top Retainers 3/8-16, on Pistons - 1/2-13
- ⊗ - Air Fitting - 1/2 NPTF or 3/8 NPTF
- ⊙ - Combination Stud Air Fitting Stud - 3/4-16; Air Fitting - 1/4 NPTF

AIR SPRING BELLOWS

Part No.	Side View With Extended And Compressed Height	Upper Mounting View	Lower Mounting View	Manufacturer Numbers
3B14-450 Flexmember 556-33-8-335		ASA-92-8-028 	ASA-92-6-013 	FIRESTONE W013587845
3B14-451 Flexmember 578-93-3-335		ASA-92-8-100 	ASA-92-6-015 	Conti 64582 FT530-35456 FIRESTONE 7846 W013587846 HENDRICKSON S-7853 TRIANGLE 4456
3B14-452 Flexmember 578-93-3-335		ASA-92-8-174 	ASA-92-6-056 	Conti 64580 FT530-35441 FIRESTONE 7850 W013587850 HISTER 10301 SUSPENSIONS INC. 200177 TRIANGLE 4441 WATSON & CHALIN AS-0086
3B14-453 Flexmember 578-33-8-335		ASA-92-8-028 	ASA-92-6-013 	Conti 64576 FT530-35436 FIRESTONE 7838 W013587838
3B14-455 Flexmember 556-33-8-335 OBSOLETE		ASA-92-8-031 	ASA-92-6-113 	

- - Bolt or Stud 1/2-13 or 1/2-20
- ⊗ - Air Fitting - 1/4 NPTF
- ⊙ - Stud - 3/4-10
- ⊕ - Tapped Hole on Top Retainers 3/8-16, on Pistons - 1/2-13
- ⊗ - Air Fitting - 1/2 NPTF or 3/8 NPTF
- ⊙⊗ - Combination Stud Air Fitting Stud - 3/4-16; Air Fitting - 1/4 NPTF

AIR SPRING BELLOWS

Part No.	Side View With Extended And Compressed Height	Upper Mounting View	Lower Mounting View	Manufacturer Numbers
3B14-456 Flexmember 578-33-8-335		ASA-92-8-031 	ASA-92-6-015 	FIRESTONE 7839
3B14-457 Flexmember 556-33-8-335		ASA-92-8-100 	ASA-92-6-015 	Conti 64581 FT530-35455 FIRESTONE 7843 W013587843
3B14-459 Flexmember 556-33-8-335		ASA-92-8-100 	ASA-92-6-050 	Conti 64583 FT530-35457 FIRESTONE 7847 W013587847
3B14-462 Flexmember 578-33-8-335		ASA-92-8-031 	ASA-92-6-013 	FIRESTONE 7855
3B14-463 Flexmember 578-33-8-335		ASA-92-8-174 	ASA-92-6-013 	FIRESTONE 7859

- - Bolt or Stud 1/2-13 or 1/2-20
- ⊗ - Air Fitting - 1/4 NPTF
- ⊙ - Stud - 3/4-10
- ⊕ - Tapped Hole on Top Retainers 3/8-16, on Pistons - 1/2-13
- ⊗ - Air Fitting - 1/2 NPTF or 3/8 NPTF
- ⊙ - Combination Stud Air Fitting Stud - 3/4-16; Air Fitting - 1/4 NPTF

AIR SPRING BELLOWS

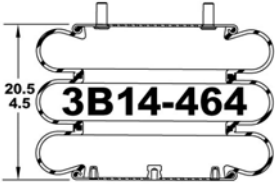
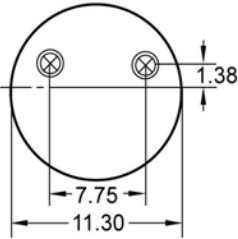
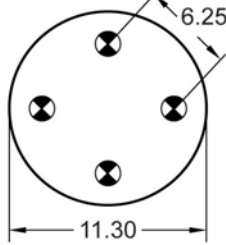
Part No.	Side View With Extended And Compressed Height	Upper Mounting View	Lower Mounting View	Manufacturer Numbers
3B14-464 Flexmember 556-33-8-335		ASA-92-8-100 	ASA-92-6-013 	Conti 64587 FT530-35534 FIRESTONE 7862 W013587862

- - Bolt or Stud 1/2-13 or 1/2-20
- ⊗ - Air Fitting - 1/4 NPTF
- ⊙ - Stud - 3/4-10
- ◐ - Tapped Hole on Top Retainers 3/8-16, on Pistons - 1/2-13
- ⊗ - Air Fitting - 1/2 NPTF or 3/8 NPTF
- ⊗ - Combination Stud Air Fitting Stud - 3/4-16; Air Fitting - 1/4 NPTF

AIR SPRING ROLLING LOBES

Part No.	Side View With Extended And Compressed Height	Upper Mounting View	Lower Mounting View	Manufacturer Numbers
1R8-009 <u>Flexmember</u> 566-16-3-007 <u>Piston</u> 566-16-7-000 Aluminum	<p>18.6 6.8</p>	ASC-16-8-003 <p>3.38 5.31</p>	<p>1/2-20 UNF 8.25</p>	
1R8-031 <u>Flexmember</u> 566-16-3-007 <u>Piston</u> 566-16-7-000 Aluminum	<p>18.6 5.6</p>	ASC-16-8-004 <p>3.38 5.31</p>	<p>1/2-20 UNF 8.25</p>	
1R8-034 <u>Flexmember</u> 566-16-3-007 <u>Piston</u> 566-16-7-021 Composite	<p>18.6 5.8 1.51</p>	ASC-16-8-004 <p>3.38 5.31</p>	<p>8.00</p>	<u>FIRESTONE</u> 5710 5730 W013585710 W013585730 <u>FLXIBLE</u> 6-304-156 6-336-175 <u>GMC</u> 10530086 6617550 698634 8870484 G5008051 <u>LES AUTOBUS</u> 10530086 698934 G5001705 <u>NOVABUS</u> G5001705 G5001706 <u>PREVOST</u> 63-0226
1R8-041 <u>Flexmember</u> 566-16-3-007 <u>Piston</u> 566-16-7-021 Composite OBSOLETE	<p>18.8 5.8</p>	ASC-16-8-004 <p>3.38 5.31</p>	<p>1/2-20 UNF 8.00</p>	
1R9-003 <u>Flexmember</u> 566-18-3-004 <u>Piston</u> 566-16-7-021 Composite	<p>17.9 5.6</p>	ASC-16-8-004 <p>3.38 5.31</p>	<p>8.00</p>	<u>AM GENERAL</u> 5973923 Conti 66-5-13S056 68136 <u>FIRESTONE</u> 5409 W013585409 W013585435 <u>FLXIBLE</u> 6-336-11 <u>GMC</u> 662743 <u>NEW FLYER</u> 5920815 5973877 5973923 5993113

- - Bolt or Stud 1/2-13 or 1/2-20
- ⊗ - Air Fitting - 1/4 NPTF
- ⊙ - Stud - 3/4-10
- ⊕ - Tapped Hole on Top Retainers 3/8-16, on Pistons - 1/2-13
- ⊗ - Air Fitting - 1/2 NPTF or 3/8 NPTF
- ⊗ - Combination Stud Air Fitting Stud - 3/4-16; Air Fitting - 1/4 NPTF

AIR SPRING ROLLING LOBES

Part No.	Side View With Extended And Compressed Height	Upper Mounting View	Lower Mounting View	Manufacturer Numbers
1R9-025 <u>Flexmember</u> 566-18-3-010 <u>Piston</u> 566-16-7-017 Aluminum	<p>12.0 4.9</p> <p>1R9-025</p>	ASC-16-8-004 <p>3.38 5.31</p>	<p>7.50</p>	
1R9-038 <u>Flexmember</u> 566-18-3-010 <u>Piston</u> 566-16-7-017 Aluminum	<p>12.0 4.0</p> <p>1R9-038</p>	ASC-16-8-004 <p>3.38 5.31</p>	<p>7.50</p>	<u>Conti</u> 66-5-13S039 68121 <u>FIRESTONE</u> 5406 W013585406 <u>GMC</u> 2021085 667512A 667512C 716111 <u>GRANNING</u> 1971
1R9-047 <u>Flexmember</u> 566-18-3-004 <u>Piston</u> Not Included	<p>17.9 5.6</p> <p>1R9-047</p>	ASC-16-8-004 <p>3.38 5.31</p>	<p style="text-align: center;">USE EXISTING SUPER CUSHION PISTON</p>	<u>FLXIBLE</u> 6-336-166
1R9-053 <u>Flexmember</u> 566-18-3-004 <u>Piston</u> 566-16-7-021 Composite	<p>17.9 6.7</p> <p>1R9-053</p>	ASC-16-8-003 <p>3.38 5.31</p>	<p>1/2-20 UNF 8.00</p>	<u>GMC</u> 672755 <u>MCI</u> 12L-4-212 12L-4-8
1R9-054 <u>Flexmember</u> 566-18-3-004 <u>Piston</u> 566-16-7-000 Aluminum	<p>5.00 3.13 3.75 17.9 6.7</p> <p>1R9-054</p>	ASC-16-8-020 <p>3.38 8.62</p>	<p>1/2-20 UNF 8.25</p>	<u>INT'L/ NAVISTAR</u> 2013947C2

- - Bolt or Stud 1/2-13 or 1/2-20
- ⊗ - Air Fitting - 1/4 NPTF
- ⊙ - Stud - 3/4-10
- ◐ - Tapped Hole on Top Retainers 3/8-16, on Pistons - 1/2-13
- ⊗ - Air Fitting - 1/2 NPTF or 3/8 NPTF
- ⊙ - Combination Stud Air Fitting Stud - 3/4-16; Air Fitting - 1/4 NPTF

AIR SPRING ROLLING LOBES

Part No.	Side View With Extended And Compressed Height	Upper Mounting View	Lower Mounting View	Manufacturer Numbers
1R9-056 Flexmember 566-18-3-004 Piston 566-16-7-000 Aluminum		ASC-16-8-020 		INTL/ NAVISTAR 2013948C2
1R9-065 Flexmember 566-18-3-003 Piston 566-16-7-009 Steel		ASC-16-8-024 		Conti 66-5-11S027 66-5B-11S525 68108 68119 FIRESTONE 2119 8997 W013582119 W013588997 GRANNING 5122 HENDRICKSON B-2394 NEWAY 905-57-029 905-57-034 RIDEWELL 1003588997C TRIANGLE 8525 WATSON & CHALIN AS-0026
1R9-070 Flexmember 566-18-3-004 Piston 566-16-7-021 Composite		ASC-16-8-004 		Conti 66-5-13S446 68123 FIRESTONE 5410 W013585410 GRANNING 2112 RIDEWELL 1003585410C TRIANGLE 8446 WATSON & CHALIN AS-0029
1R9-071 Flexmember 566-18-3-004 Piston 566-16-7-021 Composite		ASC-16-8-018 		
1R10-019 Flexmember 566-20-3-022 Piston 566-20-7-240 Composite		ASA-92-8-151 		FIRESTONE 9115 W013589115 FLXIBLE 6-336-209 GMC 2475408 684242 716110

- - Bolt or Stud 1/2-13 or 1/2-20
- ⊗ - Air Fitting - 1/4 NPTF
- ⊙ - Stud - 3/4-10
- ⊕ - Tapped Hole on Top Retainers 3/8-16, on Pistons - 1/2-13
- ⊗ - Air Fitting - 1/2 NPTF or 3/8 NPTF
- ⊙ - Combination Stud Air Fitting Stud - 3/4-16; Air Fitting - 1/4 NPTF

AIR SPRING ROLLING LOBES

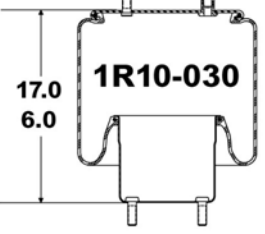
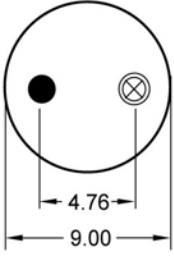
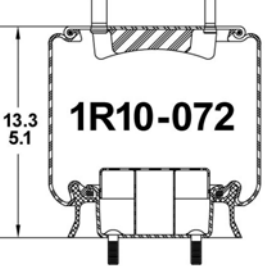
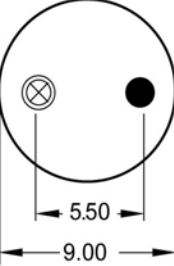
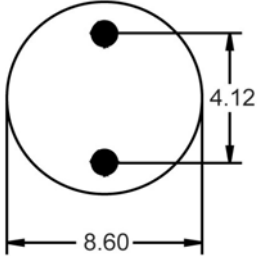
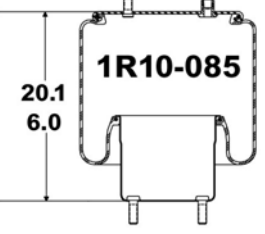
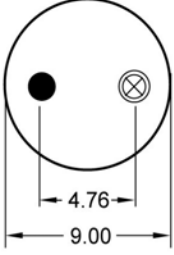
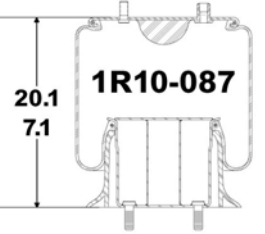
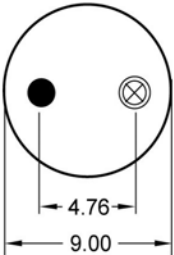
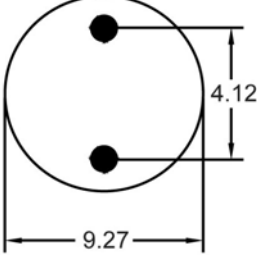
Part No.	Side View With Extended And Compressed Height	Upper Mounting View	Lower Mounting View	Manufacturer Numbers
1R10-030 <u>Flexmember</u> 566-20-3-022 <u>Piston</u> Not Included		ASA-92-8-151 	USE EXISTING SUPER CUSHION PISTON	<u>GMC</u> 667513A 667513C 720414
1R10-072 <u>Flexmember</u> 566-20-3-029 <u>Piston</u> 566-20-7-055 Aluminum		ASA-92-8-162 		
1R10-085 <u>Flexmember</u> 566-20-3-021 <u>Piston</u> Not Included		ASA-92-8-151 	USE EXISTING SUPER CUSHION PISTON	<u>FIRESTONE</u> 9017 W013589017 <u>FLXIBLE</u> 97-240-153 <u>GMC</u> 661759A 661759C 667302 677302 8875032 G1019449 <u>LES AUTOBUS</u> 661759C <u>NOVABUS</u> N15558 <u>PREVOST</u> 63-0044 <u>TMC</u> 661759C
1R10-087 <u>Flexmember</u> 566-20-3-021 <u>Piston</u> 566-20-7-240 Composite		ASA-92-8-152 		<u>BLUEBIRD</u> 990671 <u>FLXIBLE</u> 6-336-212 <u>GMC</u> G1019452 <u>PREVOST</u> 63-0067 63-0158

- - Bolt or Stud 1/2-13 or 1/2-20
- ⊗ - Air Fitting - 1/4 NPTF
- ⊙ - Stud - 3/4-10
- ◐ - Tapped Hole on Top Retainers 3/8-16, on Pistons - 1/2-13
- ⊗ - Air Fitting - 1/2 NPTF or 3/8 NPTF
- ⊙ - Combination Stud Air Fitting Stud - 3/4-16; Air Fitting - 1/4 NPTF

AIR SPRING ROLLING LOBES

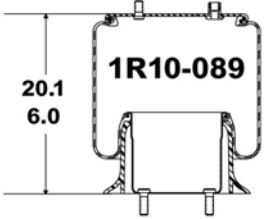
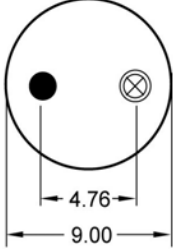
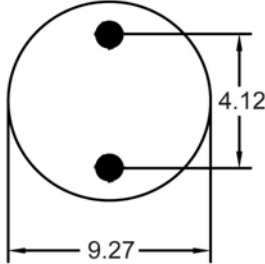
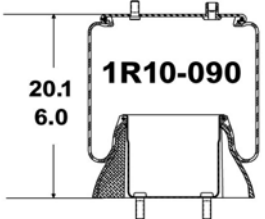
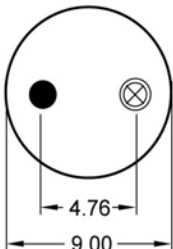
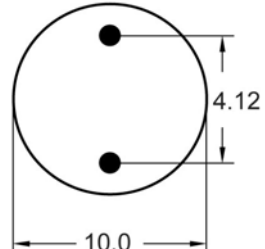
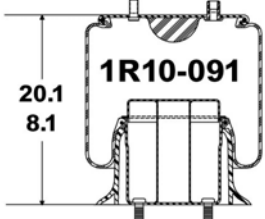
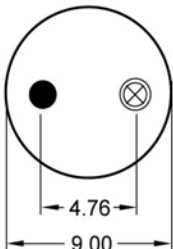
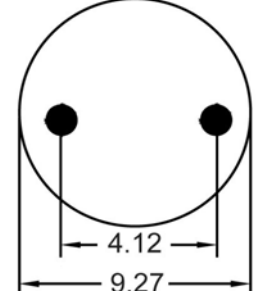
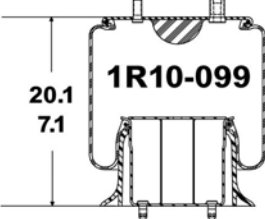
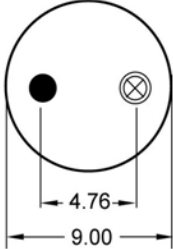
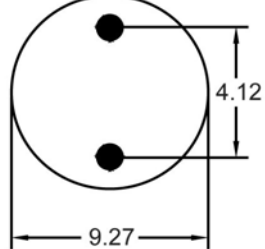
Part No.	Side View With Extended And Compressed Height	Upper Mounting View	Lower Mounting View	Manufacturer Numbers
1R10-089 <u>Flexmember</u> 566-20-3-021 <u>Piston</u> 566-20-7-240 Composite		ASA-92-8-151 		<u>AUTO BUS</u> 10530087 6-336-174 6-841-92 <u>FIRESTONE</u> 9017 97-240-153 9067 10530087 9236HR 661756 9386 677302 9436 684192 9610 684193 W013589017 684195-3 W013589067 8870485 W013589236 8875032 W013589386 <u>NOVABUS</u> W013589436 N15558 W013589610 <u>PREVOST</u> <u>FLXIBLE</u> 6-304-157 63-0044
1R10-090 <u>Flexmember</u> 566-20-3-021 <u>Piston</u> 566-20-7-120 Composite		ASA-92-8-151 		<u>GMC</u> 10530087 684192 661756 684193 684192 6989635 684193 G1020957 6989635 G1019450 G1020957 <u>LES AUTOBUS</u> 10530087 698935 G5008052 <u>TMC</u> 10530087
1R10-091 <u>Flexmember</u> 566-20-3-021 <u>Piston</u> 566-20-7-240 Composite		ASA-92-8-152 		<u>FIRESTONE</u> 9380 W013589380 <u>FLXIBLE</u> 6-336-15 6-336-182 <u>GMC</u> 662744 <u>MCI</u> 12F-4-34 12L-4-261 12L-4-5 12M-4-6
1R10-099 <u>Flexmember</u> 566-20-3-021 <u>Piston</u> 566-20-7-240 Composite		ASA-92-8-309 		<u>DINA</u> 224-B020030 <u>MCI</u> 1496372

- - Bolt or Stud 1/2-13 or 1/2-20
- ⊕ - Air Fitting - 1/4 NPTF
- ⊙ - Stud - 3/4-10
- ⊕ (with dot) - Tapped Hole on Top Retainers 3/8-16, on Pistons - 1/2-13
- ⊕ (with cross) - Air Fitting - 1/2 NPTF or 3/8 NPTF
- ⊙ (with cross) - Combination Stud Air Fitting Stud - 3/4-16; Air Fitting - 1/4 NPTF

AIR SPRING ROLLING LOBES

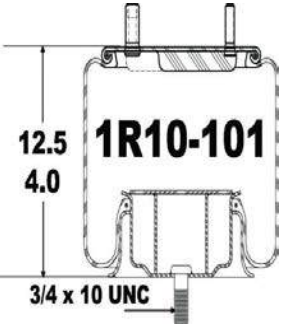
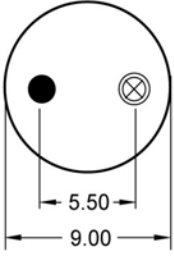
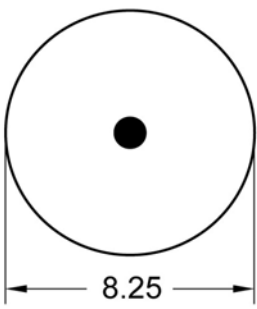
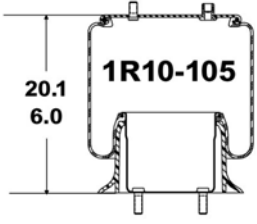
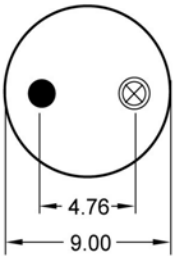
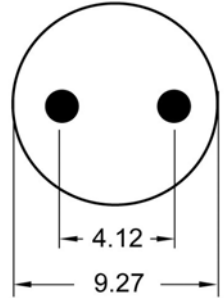
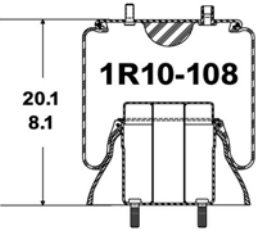
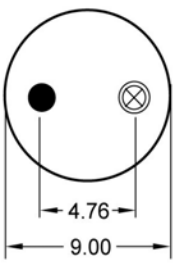
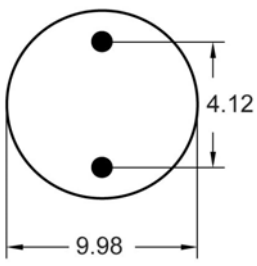
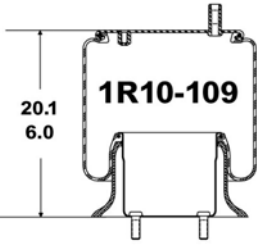
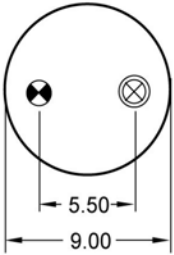
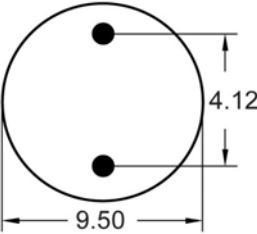
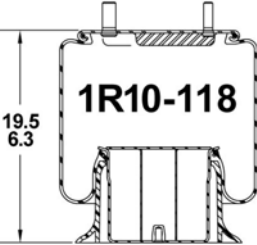
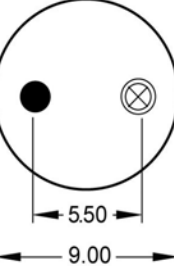
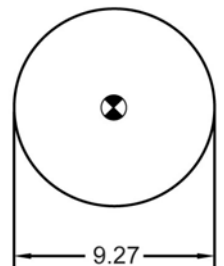
Part No.	Side View With Extended And Compressed Height	Upper Mounting View	Lower Mounting View	Manufacturer Numbers
1R10-101 Flexmember 566-20-3-027 Piston 566-20-7-150 Steel		ASA-92-8-179 		FIRESTONE 5770 W013585770 MCI 39390246
1R10-105 Flexmember 566-20-3-021 Piston 566-20-7-240 Composite		ASA-92-8-151 		FIRESTONE 9043 NOVABUS G1076863
1R10-108 Flexmember 566-20-3-021 Piston 566-20-7-120 Composite		ASA-92-8-152 		FIRESTONE 8899 W013588899 PREVOST 63-0077
1R10-109 Flexmember 566-20-3-021 Piston 566-20-7-077-03 Aluminum		ASA-92-8-017 		ORION 020117511-4 T14-1044
1R10-118 Flexmember 566-20-3-021 Piston 566-20-7-240 Composite		ASA-92-8-179 		

- - Bolt or Stud 1/2-13 or 1/2-20
- ⊗ - Air Fitting - 1/4 NPTF
- ⊙ - Stud - 3/4-10
- ⊕ - Tapped Hole on Top Retainers 3/8-16, on Pistons - 1/2-13
- ⊗ - Air Fitting - 1/2 NPTF or 3/8 NPTF
- ⊙⊗ - Combination Stud Air Fitting Stud - 3/4-16; Air Fitting - 1/4 NPTF

AIR SPRING ROLLING LOBES

Part No.	Side View With Extended And Compressed Height	Upper Mounting View	Lower Mounting View	Manufacturer Numbers
1R10-120 <u>Flexmember</u> 566-20-3-021 <u>Piston</u> 566-20-7-240 Composite	<p>20.1 7.1</p>	ASA-92-8-162 <p>5.50 9.00</p>	<p>9.27</p>	Conti 64388 99K-15P424 FIRESTONE 9293 W013589293 NEWAY 905-57-120 NOVABUS N38168 TRIANGLE 8424 TRP AS92930
1R10-122 <u>Flexmember</u> 566-20-3-021 <u>Piston</u> 566-20-7-237 Composite	<p>22.1 9.1</p>	ASA-92-8-164 <p>5.50 9.00</p>	<p>9.80</p>	Conti 64389 99K-15P425 FIRESTONE 9291 W013589291 NEWAY 905-57-122 905-57-139 TRIANGLE 8425 TRP AS92910
1R10-127 <u>Flexmember</u> 566-20-3-021 <u>Piston</u> 566-20-7-240 Composite	<p>20.1 7.8</p>	ASA-92-8-102 <p>5.50 9.00</p>	<p>4.12 9.27</p>	ORION 20117526
1R10-133 <u>Flexmember</u> 566-20-3-021 <u>Piston</u> 566-20-7-240 Composite	<p>20.1 8.1</p>	ASA-92-8-152 <p>4.76 9.00</p>	<p>4.12 9.27</p>	FIRESTONE W013589592
1R10-137 <u>Flexmember</u> 566-20-3-023 <u>Piston</u> 566-20-7-240 Composite	<p>21.8 7.1</p>	ASA-92-8-429 <p>5.50 9.00</p>	<p>4.12 9.27</p>	

- - Bolt or Stud 1/2-13 or 1/2-20
- ⊗ - Air Fitting - 1/4 NPTF
- ⊙ - Stud - 3/4-10
- ⊕ - Tapped Hole on Top Retainers 3/8-16, on Pistons - 1/2-13
- ⊗ - Air Fitting - 1/2 NPTF or 3/8 NPTF
- ⊗ - Combination Stud Air Fitting Stud - 3/4-16; Air Fitting - 1/4 NPTF

AIR SPRING ROLLING LOBES

Part No.	Side View With Extended And Compressed Height	Upper Mounting View	Lower Mounting View	Manufacturer Numbers																
1R10-165 <u>Flexmember</u> 566-20-3-021 <u>Piston</u> 566-20-7-240 Composite		ASA-92-8-407 																		
1R10-171 <u>Flexmember</u> 566-20-3-021 <u>Piston</u> 566-20-7-387 Composite		ASA-92-8-355 	M12 X 1.75-6g 																	
1R11-018 <u>Flexmember</u> 566-22-3-006 <u>Piston</u> 566-20-7-079 Steel		ASA-20-8-004 		<table border="0"> <tr> <td><u>Conti</u> 99-14A322</td> <td><u>KENWORTH</u> K-102-A</td> </tr> <tr> <td><u>DAYTON</u> 352-9073</td> <td>K-303-5</td> </tr> <tr> <td>352-9415</td> <td><u>LOAD GUARD</u> SC2049</td> </tr> <tr> <td><u>FIRESTONE</u> 9415</td> <td><u>RIDEWELL</u> 1003589073C</td> </tr> <tr> <td>W013589415</td> <td>1013580708C</td> </tr> <tr> <td><u>HENDRICKSON</u> B-7193</td> <td><u>TAURUS</u> AS103-9073</td> </tr> <tr> <td><u>INT'L / NAVISTAR</u> 554761C1</td> <td><u>TRIANGLE</u> 8322</td> </tr> </table>	<u>Conti</u> 99-14A322	<u>KENWORTH</u> K-102-A	<u>DAYTON</u> 352-9073	K-303-5	352-9415	<u>LOAD GUARD</u> SC2049	<u>FIRESTONE</u> 9415	<u>RIDEWELL</u> 1003589073C	W013589415	1013580708C	<u>HENDRICKSON</u> B-7193	<u>TAURUS</u> AS103-9073	<u>INT'L / NAVISTAR</u> 554761C1	<u>TRIANGLE</u> 8322		
<u>Conti</u> 99-14A322	<u>KENWORTH</u> K-102-A																			
<u>DAYTON</u> 352-9073	K-303-5																			
352-9415	<u>LOAD GUARD</u> SC2049																			
<u>FIRESTONE</u> 9415	<u>RIDEWELL</u> 1003589073C																			
W013589415	1013580708C																			
<u>HENDRICKSON</u> B-7193	<u>TAURUS</u> AS103-9073																			
<u>INT'L / NAVISTAR</u> 554761C1	<u>TRIANGLE</u> 8322																			
1R11-028 <u>Flexmember</u> 566-22-3-021 <u>Piston</u> 566-20-7-014 Steel		ASA-92-8-024 		<table border="0"> <tr> <td><u>Conti</u> 64255</td> <td>K-303-6</td> </tr> <tr> <td>99-12P314</td> <td><u>LOAD GUARD</u> SC2050</td> </tr> <tr> <td><u>FIRESTONE</u> 9422</td> <td><u>TOYO</u> TRL230H360382</td> </tr> <tr> <td>W013589422</td> <td><u>TRIANGLE</u> 8314</td> </tr> <tr> <td><u>FLEETRITE</u> 1R11-278</td> <td><u>TRP</u> AS94220</td> </tr> <tr> <td><u>INT'L / NAVISTAR</u> 554762C1</td> <td><u>WATSON & CHALIN</u> AS-0017</td> </tr> <tr> <td><u>KENWORTH</u> K-303-14</td> <td></td> </tr> <tr> <td>K-303-15</td> <td></td> </tr> </table>	<u>Conti</u> 64255	K-303-6	99-12P314	<u>LOAD GUARD</u> SC2050	<u>FIRESTONE</u> 9422	<u>TOYO</u> TRL230H360382	W013589422	<u>TRIANGLE</u> 8314	<u>FLEETRITE</u> 1R11-278	<u>TRP</u> AS94220	<u>INT'L / NAVISTAR</u> 554762C1	<u>WATSON & CHALIN</u> AS-0017	<u>KENWORTH</u> K-303-14		K-303-15	
<u>Conti</u> 64255	K-303-6																			
99-12P314	<u>LOAD GUARD</u> SC2050																			
<u>FIRESTONE</u> 9422	<u>TOYO</u> TRL230H360382																			
W013589422	<u>TRIANGLE</u> 8314																			
<u>FLEETRITE</u> 1R11-278	<u>TRP</u> AS94220																			
<u>INT'L / NAVISTAR</u> 554762C1	<u>WATSON & CHALIN</u> AS-0017																			
<u>KENWORTH</u> K-303-14																				
K-303-15																				
1R11-039 <u>Flexmember</u> 566-22-3-143 <u>Piston</u> 566-20-7-036 Aluminum		ASA-92-8-005 		<table border="0"> <tr> <td><u>Conti</u> 64379</td> <td></td> </tr> <tr> <td>99-14A337</td> <td></td> </tr> <tr> <td><u>FIRESTONE</u> 9439</td> <td></td> </tr> <tr> <td>W013589439</td> <td></td> </tr> <tr> <td><u>TRIANGLE</u> 8337</td> <td></td> </tr> </table>	<u>Conti</u> 64379		99-14A337		<u>FIRESTONE</u> 9439		W013589439		<u>TRIANGLE</u> 8337							
<u>Conti</u> 64379																				
99-14A337																				
<u>FIRESTONE</u> 9439																				
W013589439																				
<u>TRIANGLE</u> 8337																				

- - Bolt or Stud 1/2-13 or 1/2-20
- ⊗ - Air Fitting - 1/4 NPTF
- ⊙ - Stud - 3/4-10
- ⊗ (with cross) - Tapped Hole on Top Retainers 3/8-16, on Pistons - 1/2-13
- ⊗ (with circle) - Air Fitting - 1/2 NPTF or 3/8 NPTF
- ⊗ (with circle and cross) - Combination Stud Air Fitting Stud - 3/4-16; Air Fitting - 1/4 NPTF

AIR SPRING ROLLING LOBES

Part No.	Side View With Extended And Compressed Height	Upper Mounting View	Lower Mounting View	Manufacturer Numbers
1R11-045 <u>Flexmember</u> 566-22-3-143 <u>Piston</u> 566-20-7-077-03 Aluminum	<p>18.0 6.0</p>	ASA-92-8-164 <p>5.5 9.00</p>	<p>4.12 9.50</p>	
1R11-047 <u>Flexmember</u> 566-22-3-021 <u>Piston</u> 566-20-7-014 Steel	<p>11.9 3.8</p>	ASA-92-8-005 <p>6.20 9.00</p>	<p>9.25</p>	<u>MCI</u> 12J-3-53
1R11-066 <u>Flexmember</u> 566-22-3-021 <u>Piston</u> 566-20-7-055 Aluminum	<p>13.0 4.7</p>	ASA-92-8-327 1.00-11.50 NPTF <p>2.75 6.20 9.00</p>	<p>8.60</p>	<u>FIRESTONE</u> 9447 W013589447 <u>RIDEWELL</u> 1003589447C
1R11-075 <u>Flexmember</u> 566-22-3-028 <u>Piston</u> 566-20-7-055 Aluminum	<p>15.4 4.3</p>	AS1-92-8-163 <p>3.05 9.00</p>	<p>4.12 8.60</p>	
1R11-088 <u>Flexmember</u> 566-22-3-143 <u>Piston</u> 566-20-7-120 Composite	<p>18.3 8.1</p>	ASA-92-8-152 <p>4.76 9.00</p>	<p>4.12 9.98</p>	<u>FIRESTONE</u> 5739 W013585739 <u>PREVOST</u> 63-0092 63-0104

- - Bolt or Stud 1/2-13 or 1/2-20
- ⊗ - Air Fitting - 1/4 NPTF
- ⊙ - Stud - 3/4-10
- ⊕ - Tapped Hole on Top Retainers 3/8-16, on Pistons - 1/2-13
- ⊗ - Air Fitting - 1/2 NPTF or 3/8 NPTF
- ⊙ - Combination Stud Air Fitting Stud - 3/4-16; Air Fitting - 1/4 NPTF

AIR SPRING ROLLING LOBES

Part No.	Side View With Extended And Compressed Height	Upper Mounting View	Lower Mounting View	Manufacturer Numbers
1R11-090 <u>Flexmember</u> 566-22-3-143 <u>Piston</u> 566-20-7-079 Steel	<p>18.3 8.1</p>	ASA-92-8-438 1.250-12 UNF outside 500-14 NPTF inside <p>4.76 9.00</p>	<p>4.12 10.12</p>	<u>PREVOST</u> 63-0090 63-0094 63-0106
1R11-094 <u>Flexmember</u> 566-22-3-143 <u>Piston</u> 566-20-7-240 Composite	<p>18.0 6.4</p>	ASA-92-8-179 <p>5.50 9.00</p>	<p>9.27</p>	
1R11-097 <u>Flexmember</u> 566-22-3-044 <u>Piston</u> 566-20-7-079 Steel	<p>22.1 8.1</p>	ASA-92-8-152 <p>4.76 9.00</p>	<p>4.12 10.12</p>	<u>PREVOST</u> 63-0129
1R11-109 <u>Flexmember</u> 566-22-3-143 <u>Piston</u> Not Included	<p>18.3 8.1</p>	ASA-92-8-438 1/2-14 NPTF <p>4.76 9.00</p>	USE EXISTING SUPER CUSHION PISTON	<u>PREVOST</u> 63-0109
1R11-115 <u>Flexmember</u> 566-22-3-051 <u>Piston</u> 566-20-7-183 Steel	<p>18.3 6.2</p>	ASA-92-8-271 500-14 NPTF <p>2.87 6.20 9.00</p>	<p>6.20 7.84</p>	<u>MCI</u> 12-03-1041

- - Bolt or Stud 1/2-13 or 1/2-20
- ⊗ - Air Fitting - 1/4 NPTF
- ⊙ - Stud - 3/4-10
- ⊕ - Tapped Hole on Top Retainers 3/8-16, on Pistons - 1/2-13
- ⊗ - Air Fitting - 1/2 NPTF or 3/8 NPTF
- ⊙ - Combination Stud Air Fitting Stud - 3/4-16; Air Fitting - 1/4 NPTF

AIR SPRING ROLLING LOBES

Part No.	Side View With Extended And Compressed Height	Upper Mounting View	Lower Mounting View	Manufacturer Numbers
1R11-121 <u>Flexmember</u> 566-22-3-143 <u>Piston</u> 566-20-7-156 Composite		ASA-92-8-005 		Conti 64379 99-14A337 <u>FIRESTONE</u> 9441 W013589441 <u>FLXIBLE</u> 6-336-200 <u>GILLIG</u> 53-13187 53-14006 53-8212 <u>NOVABUS</u> N16374
1R11-130 <u>Flexmember</u> 566-22-3-049 <u>Piston</u> 566-20-7-124 Steel		ASA-92-8-005 		<u>NOVABUS</u> N17842
1R11-143 <u>Flexmember</u> 566-22-3-143 <u>Piston</u> 566-20-7-240 Composite		ASA-92-8-304 M22x 1.5-6G outside .250 18NPTF inside 		<u>DINA</u> 224-B020020 <u>MCI</u> 12-03-6034 1512076
1R11-147 <u>Flexmember</u> 566-22-3-143 <u>Piston</u> 566-20-7-240 Composite		ASA-92-8-102 		<u>ORION</u> 20217501
1R11-149 <u>Flexmember</u> 566-22-3-143 <u>Piston</u> 566-20-7-239 Composite		ASA-92-8-142 		Conti 64364 99-12P464 <u>FIRESTONE</u> 8901 W013588901

- - Bolt or Stud 1/2-13 or 1/2-20
- ⊗ - Air Fitting - 1/4 NPTF
- ⊙ - Stud - 3/4-10
- ⊕ - Tapped Hole on Top Retainers 3/8-16, on Pistons - 1/2-13
- ⊗ - Air Fitting - 1/2 NPTF or 3/8 NPTF
- ⊙ - Combination Stud Air Fitting Stud - 3/4-16; Air Fitting - 1/4 NPTF

AIR SPRING ROLLING LOBES

Part No.	Side View With Extended And Compressed Height	Upper Mounting View	Lower Mounting View	Manufacturer Numbers
1R11-150 <u>Flexmember</u> 566-22-3-021 <u>Piston</u> 566-20-7-055 Aluminum		ASA-92-8-162 		Conti 64286 99-12P563 <u>FIRESTONE</u> 9448 W013589448 <u>RIDEWELL</u> 1003589448C <u>TRIANGLE</u> 8563 TRP AS94480
1R11-151 <u>Flexmember</u> 566-22-3-021 <u>Piston</u> 566-20-7-055 Aluminum		ASA-92-8-162 		<u>BLUEBIRD</u> 1286814 <u>FIRESTONE</u> 9457 W013589457 <u>RIDEWELL</u> 1003589457C
1R11-152 <u>Flexmember</u> 566-22-3-021 <u>Piston</u> 566-20-7-055 Aluminum		ASA-92-8-162 		<u>CHANCE BUS</u> 23891728 <u>FIRESTONE</u> 9459 W013589459 <u>RIDEWELL</u> 1003589459C
1R11-159 <u>Flexmember</u> 566-22-3-021 <u>Piston</u> 566-20-7-014 Steel		ASA-92-8-162 		Conti 64367 99-12P479 <u>FIRESTONE</u> 9387 W013589387 TRP AS93920
1R11-161 <u>Flexmember</u> 566-22-3-057 <u>Piston</u> 566-20-7-150 Steel		ASA-92-8-115 		<u>AMERICAN CARRIER</u> 8003023 <u>FIRESTONE</u> 5766 W013585766 <u>HUTCHENS IND.</u> 19141-01

- - Bolt or Stud 1/2-13 or 1/2-20
- ⊗ - Air Fitting - 1/4 NPTF
- ⊙ - Stud - 3/4-10
- ◐ - Tapped Hole on Top Retainers 3/8-16, on Pistons - 1/2-13
- ⊗ - Air Fitting - 1/2 NPTF or 3/8 NPTF
- ⊙ - Combination Stud Air Fitting Stud - 3/4-16; Air Fitting - 1/4 NPTF

AIR SPRING ROLLING LOBES

Part No.	Side View With Extended And Compressed Height	Upper Mounting View	Lower Mounting View	Manufacturer Numbers
1R11-162 <u>Flexmember</u> 566-22-3-021 <u>Piston</u> 566-20-7-014 Steel		ASA-92-8-164 		
1R11-166 <u>Flexmember</u> 566-22-3-143 <u>Piston</u> 566-20-7-235 Composite		ASA-92-8-164 		Conti 64386 99K-15P417 <u>FIRESTONE</u> 9295 W013589295 <u>NEWAY</u> 905-57-121 <u>TRIANGLE</u> 8417 TRP AS92950
1R11-169 <u>Flexmember</u> 566-22-3-143 <u>Piston</u> 566-20-7-250 Composite		ASA-92-8-151 		NOVABUS G1202328 G1202651 G1202652
1R11-170 <u>Flexmember</u> 566-22-3-143 <u>Piston</u> 566-20-7-240 Composite		ASA-92-8-165 		
1R11-171 <u>Flexmember</u> 566-22-3-057 <u>Piston</u> 566-20-7-150 Steel		ASA-92-8-164 		<u>AMERICAN CARRIER</u> 8003003 Conti 64627 99-12P705 <u>FIRESTONE</u> 9421 W013589421 <u>TRIANGLE</u> 8468 TRP AS94210

- - Bolt or Stud 1/2-13 or 1/2-20
- ⊗ - Air Fitting - 1/4 NPTF
- ⊙ - Stud - 3/4-10
- ⊕ - Tapped Hole on Top Retainers 3/8-16, on Pistons - 1/2-13
- ⊗ - Air Fitting - 1/2 NPTF or 3/8 NPTF
- ⊙⊗ - Combination Stud Air Fitting Stud - 3/4-16; Air Fitting - 1/4 NPTF

AIR SPRING ROLLING LOBES

Part No.	Side View With Extended And Compressed Height	Upper Mounting View	Lower Mounting View	Manufacturer Numbers
1R11-175 <u>Flexmember</u> 566-22-3-060 <u>Piston</u> 566-20-7-257 Composite		ASA-92-8-355 	M12 x 1.75-6G 	<u>INT'L/</u> <u>NAVISTAR</u> 3541733C1
1R11-176 <u>Flexmember</u> 566-22-3-075 <u>Piston</u> 566-20-7-257 Composite		ASA-92-8-355 	M12 x 1.75-6G 	
1R11-178 <u>Flexmember</u> 566-22-3-143 <u>Piston</u> 566-20-7-209 Composite		ASA-92-8-005 		<u>Conti</u> 67492 99-14P895 <u>FIRESTONE</u> W01W359385 <u>NEW FLYER</u> 55089 <u>TRP</u> AS93850
1R11-179 <u>Flexmember</u> 566-22-3-143 <u>Piston</u> 566-20-7-209 Composite		ASA-92-8-005 		<u>Conti</u> 64631 99-14P708 99K-15P708 <u>FIRESTONE</u> W01W359465 <u>NEW FLYER</u> 99865
1R11-189 <u>Flexmember</u> 566-22-3-049 <u>Piston</u> 566-20-7-240 Composite		ASA-92-8-309 		<u>MCI</u> 1498928

- - Bolt or Stud 1/2-13 or 1/2-20
- ⊗ - Air Fitting - 1/4 NPTF
- ⊙ - Stud - 3/4-10
- ⊖ - Tapped Hole on Top Retainers 3/8-16, on Pistons - 1/2-13
- ⊗ - Air Fitting - 1/2 NPTF or 3/8 NPTF
- ⊙ - Combination Stud Air Fitting Stud - 3/4-16; Air Fitting - 1/4 NPTF

AIR SPRING ROLLING LOBES

Part No.	Side View With Extended And Compressed Height	Upper Mounting View	Lower Mounting View	Manufacturer Numbers
1R11-191 <u>Flexmember</u> 566-22-3-143 <u>Piston</u> 566-20-7-239 Composite		ASA-92-8-005 		Conti 64381 99-14A517 99-14P517 <u>FIRESTONE</u> 8919 W013588919 <u>RIDEWELL</u> 1003588919C <u>TRIANGLE</u> 8517
1R11-200 <u>Flexmember</u> 566-22-3-021 <u>Piston</u> 566-20-7-252 Composite		ASA-92-8-003 		Conti 64365 99-12P477 <u>FIRESTONE</u> 9376 W013589376 <u>MCI</u> 14002 <u>MONOCO</u> <u>COACH</u> 14002 <u>TRIANGLE</u> 8477 <u>TRP</u> AS93760
1R11-201 <u>Flexmember</u> 566-22-3-021 <u>Piston</u> 566-20-7-252 Composite		ASA-92-8-017 		Conti 64366 99-12P478 <u>FIRESTONE</u> 9377 W013589377 <u>REYCO</u> 21054-01 <u>TRIANGLE</u> 8478 <u>TRP</u> AS93770
1R11-202 <u>Flexmember</u> 566-22-3-021 <u>Piston</u> 566-20-7-252 Composite		ASA-92-8-164 		Conti 64363 99-12P447 <u>FIRESTONE</u> 9378 W013589378 <u>RIDEWELL</u> 1003589378C <u>TRIANGLE</u> 8447 <u>TRP</u> AS93780
1R11-203 <u>Flexmember</u> 566-22-3-021 <u>Piston</u> 566-20-7-251 Composite		ASA-92-8-164 		Conti 64367 99-12P479 <u>FIRESTONE</u> 9387 W013589387 <u>RIDEWELL</u> 1003589387C <u>TRIANGLE</u> 8479 <u>TRP</u> AS93870

- - Bolt or Stud 1/2-13 or 1/2-20
- ⊗ - Air Fitting - 1/4 NPTF
- ⊙ - Stud - 3/4-10
- ⊕ - Tapped Hole on Top Retainers 3/8-16, on Pistons - 1/2-13
- ⊗ - Air Fitting - 1/2 NPTF or 3/8 NPTF
- ⊙⊗ - Combination Stud Air Fitting Stud - 3/4-16; Air Fitting - 1/4 NPTF

AIR SPRING ROLLING LOBES

Part No.	Side View With Extended And Compressed Height	Upper Mounting View	Lower Mounting View	Manufacturer Numbers
1R11-204 <u>Flexmember</u> 566-22-3-021 <u>Piston</u> 566-20-7-253 Composite		ASA-92-8-164 		Conti 64362 99-12P401 FIRESTONE 8900 W013588900 REYCO 17361-01 TRIANGLE 8401
1R11-205 <u>Flexmember</u> 566-22-3-021 <u>Piston</u> 566-20-7-253 Composite		ASA-92-8-017 		Conti 64368 99-12P516 FIRESTONE 9476 W013589476 REYCO 20446-01 TRIANGLE 8516 TRP AS94760
1R11-207 <u>Flexmember</u> 566-22-3-021 <u>Piston</u> 566-20-7-156 Composite		ASA-92-8-269 		
1R11-209 <u>Flexmember</u> 566-22-3-143 <u>Piston</u> 566-20-7-209 Composite		ASA-92-8-151 		
1R11-216 <u>Flexmember</u> 566-22-3-068 <u>Piston</u> 566-20-7-257 Composite		ASA-92-8-355 		M12 x 1.75-6G

- - Bolt or Stud 1/2-13 or 1/2-20
- ⊗ - Air Fitting - 1/4 NPTF
- ⊙ - Stud - 3/4-10
- ⊕ - Tapped Hole on Top Retainers 3/8-16, on Pistons - 1/2-13
- ⊗ - Air Fitting - 1/2 NPTF or 3/8 NPTF
- ⊙⊗ - Combination Stud Air Fitting Stud - 3/4-16; Air Fitting - 1/4 NPTF

AIR SPRING ROLLING LOBES

Part No.	Side View With Extended And Compressed Height	Upper Mounting View	Lower Mounting View	Manufacturer Numbers
1R11-219 <u>Flexmember</u> 566-22-3-021 <u>Piston</u> 566-20-7-287 Steel		ASA-92-8-374 SAE 45 flare, .500 O.D. tube SAE J512, .750-16 UNF-2A 		Conti 66112 99-9P860 <u>FIRESTONE</u> 9617 W013589617 <u>KENWORTH</u> K-303-18 <u>TRIANGLE</u> 8514
1R11-220 <u>Flexmember</u> 566-22-3-021 <u>Piston</u> 566-20-7-286 Steel		ASA-92-8-374 SAE 45 flare, .500 O.D. tube SAE J512, .750-16 UNF-2A 		Conti 66113 99-10P862 <u>FIRESTONE</u> 9618 W013589618 <u>KENWORTH</u> K-303-19
1R11-221 <u>Flexmember</u> 566-22-3-021 <u>Piston</u> 566-20-7-287 Steel		ASA-92-8-373 JIC 37 flare, 1.0 O.D. tube SAE J514, 1.312-12 UNF-2A 		Conti 65367 65394 99-10P576 99-9P537 <u>FIRESTONE</u> 9622 9675 W013589622 W013589675 <u>KENWORTH</u> K-303-22 K-303-28 <u>TRIANGLE</u> 8537 TRP AS96750
1R11-222 <u>Flexmember</u> 566-22-3-021 <u>Piston</u> 566-20-7-286 Steel		ASA-92-8-373 JIC 37 flare, 1.0 O.D. tube SAE J514, 1.312-12 UNF-2A 		Conti 65389 99-10P538 <u>FIRESTONE</u> 9625 W013589625 <u>KENWORTH</u> K-303-25 <u>TRIANGLE</u> 8538 TRP AS96250
1R11-223 <u>Flexmember</u> 566-22-3-143 <u>Piston</u> 566-20-7-156 Composite		ASA-92-8-005 		<u>FIRESTONE</u> 9469 W013589469

- - Bolt or Stud 1/2-13 or 1/2-20
- ⊗ - Air Fitting - 1/4 NPTF
- ⊙ - Stud - 3/4-10
- ⊕ - Tapped Hole on Top Retainers 3/8-16, on Pistons - 1/2-13
- ⊗ - Air Fitting - 1/2 NPTF or 3/8 NPTF
- ⊙ - Combination Stud Air Fitting Stud - 3/4-16; Air Fitting - 1/4 NPTF

AIR SPRING ROLLING LOBES

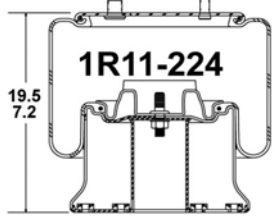
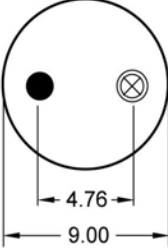
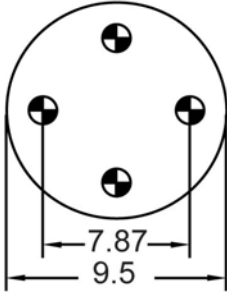
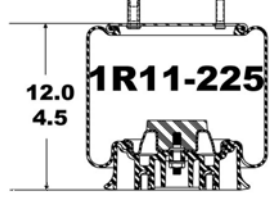
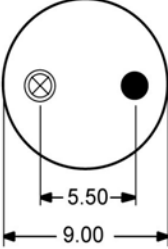
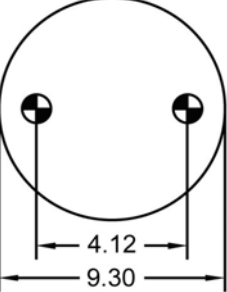
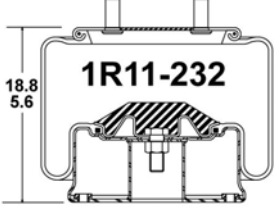
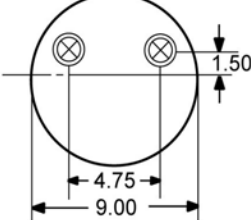
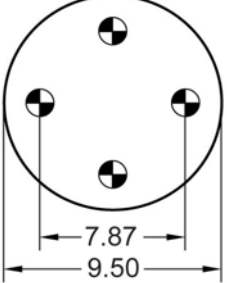
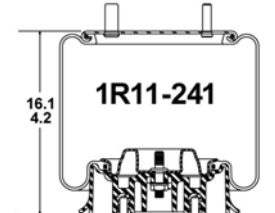
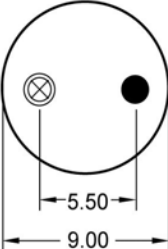
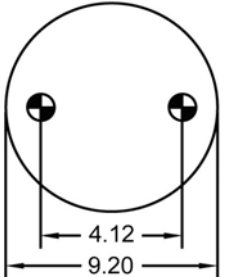
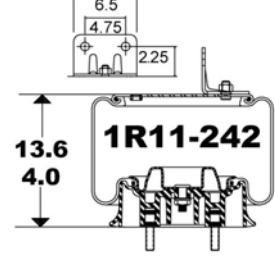
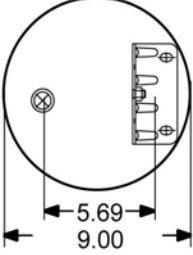
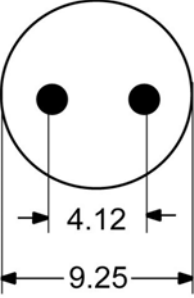
Part No.	Side View With Extended And Compressed Height	Upper Mounting View	Lower Mounting View	Manufacturer Numbers
1R11-224 Flexmember 566-22-3-073 Piston 566-20-7-308 Composite		ASA-92-8-151 		
1R11-225 Flexmember 566-22-3-057 Piston 566-20-7-253 Composite		ASA-92-8-164 		FIRESTONE 9650 W013589650 NEWAY 905-57-097
1R11-232 Flexmember 566-22-3-049 Piston 566-20-7-124 Steel		ASA-92-8-257 		NOVABUS N35162
1R11-241 Flexmember 566-22-3-143 Piston 566-20-7-253 Composite		ASA-92-8-164 		
1R11-242 Flexmember 566-22-3-021 Piston 566-20-7-252 Composite		ASA-92-8-437 		Conti 64256 99-12P515 FIRESTONE 9616 W013589616 KENWORTH K-303-16 TRIANGLE 8515 TRP AS96160

- - Bolt or Stud 1/2-13 or 1/2-20
- ⊗ - Air Fitting - 1/4 NPTF
- ⊙ - Stud - 3/4-10
- ⊕ - Tapped Hole on Top Retainers 3/8-16, on Pistons - 1/2-13
- ⊗ - Air Fitting - 1/2 NPTF or 3/8 NPTF
- ⊙⊗ - Combination Stud Air Fitting Stud - 3/4-16; Air Fitting - 1/4 NPTF

AIR SPRING ROLLING LOBES

Part No.	Side View With Extended And Compressed Height	Upper Mounting View	Lower Mounting View	Manufacturer Numbers
1R11-243 <u>Flexmember</u> 566-22-3-143 <u>Piston</u> 566-20-7-120 Composite		ASA-92-8-438 		<u>PREVOST</u> 63-0093 63-0099 63-0105 63-0260
1R11-244 <u>Flexmember</u> 566-22-3-079 <u>Piston</u> 566-20-7-079 Steel		ASA-92-8-438 		<u>PREVOST</u> 63-0102 63-0126 63-0259
1R11-249 <u>Flexmember</u> 566-22-3-084 <u>Piston</u> 566-20-7-156 Composite		ASA-92-8-367 		<u>FIRESTONE</u> W013588616 <u>NABI-HF</u> 633-9668
1R11-252 <u>Flexmember</u> 566-22-3-042 <u>Piston</u> 566-20-7-235 Composite		ASA-92-8-164 		<u>Conti</u> 64423 910-17-5P536 <u>FIRESTONE</u> W013588903
1R11-268 <u>Flexmember</u> 566-22-3-021 <u>Piston</u> 566-20-7-287 Steel		ASA-92-8-480 JIC 37 flare, 1.0 O.D. tube SAE J514, 1.312-12 UNF-2A 		<u>Conti</u> 66109 99-9P859 <u>FIRESTONE</u> 9541 9542 9547 W013589542 W013589547 W015449542



- - Bolt or Stud 1/2-13 or 1/2-20
- ⊗ - Air Fitting - 1/4 NPTF
- ⊙ - Stud - 3/4-10
- ⊕ - Tapped Hole on Top Retainers 3/8-16, on Pistons - 1/2-13
- ⊗ - Air Fitting - 1/2 NPTF or 3/8 NPTF
- ⊙ - Combination Stud Air Fitting Stud - 3/4-16; Air Fitting - 1/4 NPTF

AIR SPRING ROLLING LOBES

Part No.	Side View With Extended And Compressed Height	Upper Mounting View	Lower Mounting View	Manufacturer Numbers
<p><u>Flexmember</u> 566-24-3-024</p> <p><u>Piston</u> 566-20-7-079 Steel</p>	<p style="text-align: center;">1R12-028</p>	<p>ASC-20-8-003</p>		<p>PREVOST 63-0045</p>
<p>1R12-066</p> <p><u>Flexmember</u> 566-24-3-038</p> <p><u>Piston</u> 566-20-7-080 Composite</p>	<p style="text-align: center;">1R12-066</p>	<p>ASA-92-8-164</p>		<p>Conti 64294 910-16P333 <u>DAYTON</u> 352-9083 <u>FIRESTONE</u> 9083 W013589083 <u>GRANNING</u> 1359 1528 B59 INT'L/</p> <p><u>NAVISTAR</u> 554763C1 <u>LOAD GUARD</u> SC2036 <u>RIDEWELL</u> 1003589083C <u>TAURUS</u> AS506-9080 <u>TRIANGLE</u> 8333 <u>WATSON & CHALIN</u> AS-0018 AS-0028</p>
<p>1R12-069</p> <p><u>Flexmember</u> 566-24-3-163</p> <p><u>Piston</u> 566-20-7-235 Composite</p>	<p style="text-align: center;">1R12-069</p>	<p>ASA-92-8-041</p>		<p>Conti 64274 910-14P312 <u>DAYTON</u> 352-9069 <u>FIRESTONE</u> 9069 W013589069 <u>FLEETRITR</u> 1R12-1052 INT'L/ <u>NAVISTAR</u> 554764C1 <u>LOAD GUARD</u> SC2034</p> <p><u>PETERBILT</u> 03-01649 03-02038 03-02456 03-04759 03-07112 23-10042 <u>TAURUS</u> AS504-9069 AS506-9069 <u>TRIANGLE</u> 8312 <u>WATSON & CHALIN</u> AS-0077</p>
<p>1R12-076</p> <p><u>Flexmember</u> 566-24-3-076</p> <p><u>Piston</u> 566-20-7-036 Aluminum</p> <p>OBSOLETE</p>	<p style="text-align: center;">1R12-076</p>	<p>ASA-92-8-151</p>		<p><u>AM GENERAL</u> 5973924 <u>FIRESTONE</u> 9100 W013589100</p>
<p>1R12-090</p> <p><u>Flexmember</u> 566-24-3-038</p> <p><u>Piston</u> 566-20-7-079 Steel</p>	<p style="text-align: center;">1R12-090</p>	<p>ASA-92-8-052</p>		<p>Conti 64262 910-16P407 <u>DAYTON</u> 352-9213 <u>FIRESTONE</u> 9213 W013589213 <u>FLEETRITR</u> 1R12-1060 INT'L/ <u>NAVISTAR</u> 1660581C1 501559C1</p> <p>501559C2 <u>LOAD GUARD</u> SC2048 <u>TRIANGLE</u> 8407</p>

- - Bolt or Stud 1/2-13 or 1/2-20
- ⊗ - Air Fitting - 1/4 NPTF
- ⊙ - Stud - 3/4-10
- ⊖ - Tapped Hole on Top Retainers 3/8-16, on Pistons - 1/2-13
- ⊗ - Air Fitting - 1/2 NPTF or 3/8 NPTF
- ⊙ - Combination Stud Air Fitting Stud - 3/4-16; Air Fitting - 1/4 NPTF

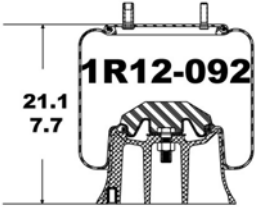
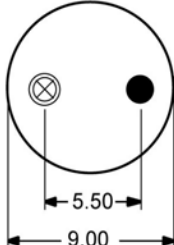
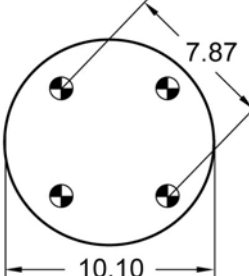
AIR SPRING ROLLING LOBES

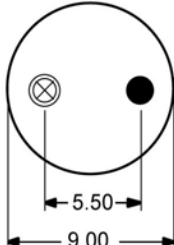
Part No.	Side View With Extended And Compressed Height	Upper Mounting View	Lower Mounting View	Manufacturer Numbers
<p>1R12-092</p> <p><u>Flexmember</u> 566-24-3-163</p> <p><u>Piston</u> 566-20-7-080 Composite</p>	 <p>1R12-092</p>	<p>ASA-92-8-164</p> 		<p><u>Conti</u> 64269 910-16P310 910-16P350 <u>DAYTON</u> 352-9082 <u>FAB TEK</u> 101828 <u>FIRESTONE</u> 9082 W013589082 <u>FLEETRITE</u> 1R12-1053 <u>GRANNING</u> 2727 HDA PMABG-9082B <u>HENDRICKSON</u> 36514-7 B-2066 <u>HUTCHENS</u> <u>IND.</u> 9630-01 INT'L/ <u>NAVISTAR</u> 517559C9 <u>KWIK-LOK /</u> <u>TODCO</u> CP-3281 CP-5125 CP-5152 <u>LOAD GUARD</u> SC2035</p> <p><u>NEWAY</u> 905-57-006 905-57-027 905-57-037 905-57-054 905-57-075 AR-1315-1-F AR-1315-1-G <u>NOVABUS</u> N39112 <u>R & S TRUCK & BODY</u> 1090217 <u>REYCO</u> 12882-01 <u>RIDEWELL</u> 1003589082C S-542-C <u>SUSPENSIONS INC.</u> 201869 <u>TAURUS</u> AS506-9082 <u>TOYO</u> TRL-240/393 <u>TRIANGLE</u> 8310 <u>WATSON & CHALIN</u> AS-0011</p>
<p>1R12-093</p> <p><u>Flexmember</u> 566-24-3-038</p> <p><u>Piston</u> Not Included</p>	 <p>1R12-093</p>	<p>ASA-92-8-164</p> 	<p>USE EXISTING SUPER CUSHION PISTON</p>	<p><u>HUTCHENS IND.</u> 9630-03 INT'L/ <u>NAVISTAR</u> 554765C1 <u>LOAD GUARD</u> SC2054 <u>NEWAY</u> 900-44-200 900-44-216 900-44-647 <u>RIDEWELL</u> 1013580712C</p> <p><u>TAURUS</u> AS506-0712</p>

- - Bolt or Stud 1/2-13 or 1/2-20
- ⊗ - Air Fitting - 1/4 NPTF
- ⊙ - Stud - 3/4-10
- ◐ - Tapped Hole on Top Retainers 3/8-16, on Pistons - 1/2-13
- ⊗ - Air Fitting - 1/2 NPTF or 3/8 NPTF
- ⊗ - Combination Stud Air Fitting Stud - 3/4-16; Air Fitting - 1/4 NPTF

AIR SPRING ROLLING LOBES

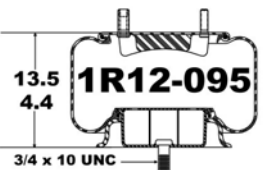
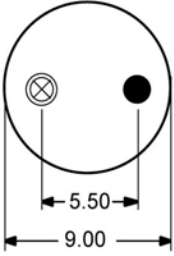
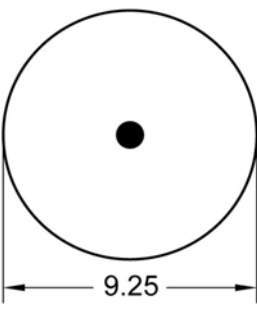
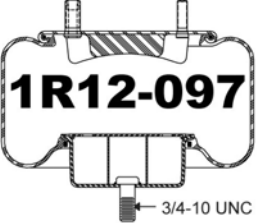
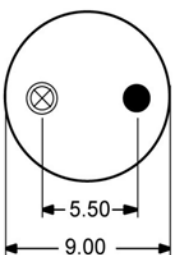
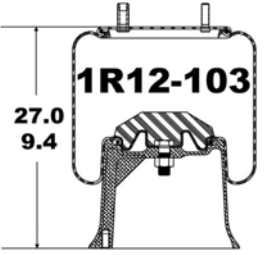
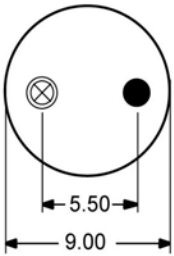
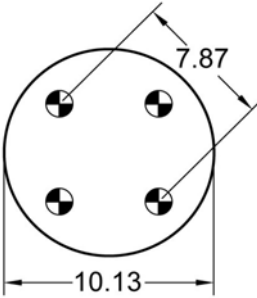
Part No.	Side View With Extended And Compressed Height	Upper Mounting View	Lower Mounting View	Manufacturer Numbers	
<p>1R12-095</p> <p><u>Flexmember</u> 566-24-3-067</p> <p><u>Piston</u> 566-20-7-014 Steel</p>	 <p style="text-align: center;">1R12-095</p>	<p style="text-align: center;">ASA-92-8-162</p> 		<p><u>BLUEBIRD</u> 12TA-1-2 300-961250 <u>Conti</u> 64260 910-10P311 <u>DAYTON</u> 352-9039 <u>FAB TEK</u> 101827 <u>FIRESTONE</u> 9039 W013589039 <u>FLEETRITE</u> 1R12-1061 <u>FLXIBLE</u> 6-336-202 <u>HDA</u> PMABG-9039B <u>HENDRICKSON</u> B-11650 B-2064 <u>HUTCHENS</u> IND. 9424-01 9424-03 <u>INT'L / NAVISTAR</u> 554766C1</p>	<p><u>LOAD GUARD</u> SC2033 <u>NEWAY</u> 905-57-011 905-57-023 905-57-085 <u>R & S TRUCK & BODY</u> 1090218 <u>RIDEWELL</u> 1003589039C 1013589039C S-2061-C S-5356-C <u>SAUR AXLES (SAS)</u> P50-734 <u>SUSPENSIONS INC.</u> 200457 <u>TAURUS</u> AS500-9039 <u>TRIANGLE</u> 8311 <u>WATSON & CHALIN</u> AS-0012</p>
<p>1R12-097</p> <p><u>Flexmember</u> 566-24-3-067</p> <p><u>Piston</u> Not Included</p>	 <p style="text-align: center;">1R12-097</p>	<p style="text-align: center;">ASA-92-8-162</p> 	<p style="text-align: center;">USE EXISTING SUPER CUSHION PISTON</p>	<p><u>HUTCHENS</u> IND. 9424-1 <u>INT'L / NAVISTAR</u> 554767C1 <u>LOAD GUARD</u> SC2058 <u>NEWAY</u> 900-44-199 900-44-708 900-54-234 <u>RIDEWELL</u> 1013580702C</p>	<p><u>TAURUS</u> AS500-0702</p>
<p>1R12-103</p> <p><u>Flexmember</u> 566-24-3-066</p> <p><u>Piston</u> 566-20-7-006 Aluminum</p>	 <p style="text-align: center;">1R12-103</p>	<p style="text-align: center;">ASA-92-8-164</p> 		<p><u>Conti</u> 64279 910-19P315 <u>DAYTON</u> 352-9101 <u>FIRESTONE</u> 9101 W013589101 <u>HENDRICKSON</u> B-3842 <u>INT'L / NAVISTAR</u> 554768C1 <u>LOAD GUARD</u> SC2038 <u>NEWAY</u> 900-44-701 905-57-008 905-57-009 905-57-082</p>	<p><u>REYCO</u> 12883-01 <u>RIDEWELL</u> 1003589101C S-5828-C S-740-C <u>TAURUS</u> AS506-9093 AS509-9101 <u>TOYO</u> TRL-250 <u>TRIANGLE</u> 8315 <u>TRUCKSTELL</u> 63647 <u>WATSON & CHALIN</u> AS-0040</p>

- - Bolt or Stud 1/2-13 or 1/2-20
- ⊗ - Air Fitting - 1/4 NPTF
- ⊙ - Stud - 3/4-10
- ◐ - Tapped Hole on Top Retainers 3/8-16, on Pistons - 1/2-13
- ⊗ - Air Fitting - 1/2 NPTF or 3/8 NPTF
- ⊗ - Combination Stud Air Fitting Stud - 3/4-16; Air Fitting - 1/4 NPTF

AIR SPRING ROLLING LOBES

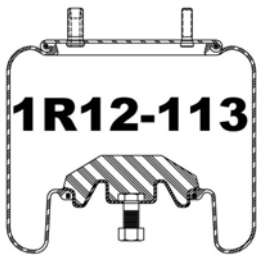
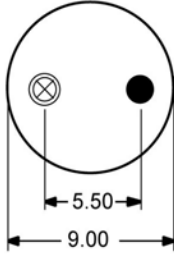
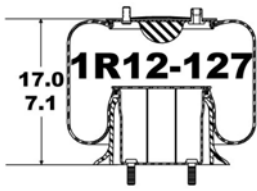
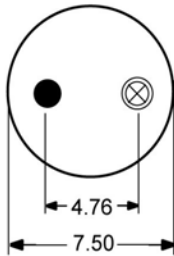
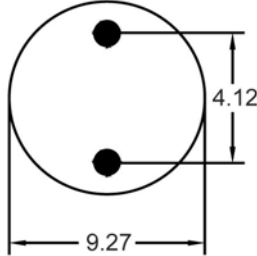
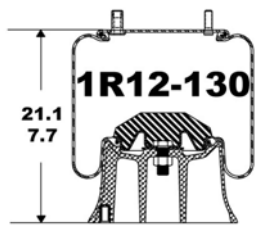
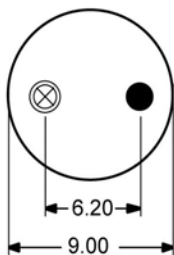
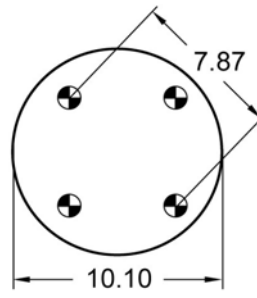
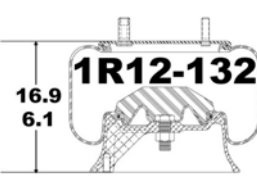
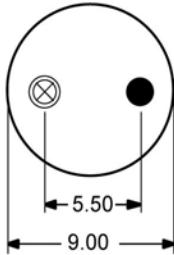
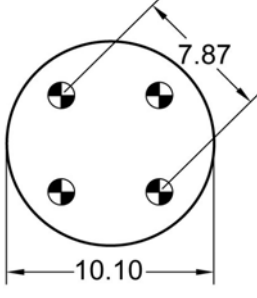
Part No.	Side View With Extended And Compressed Height	Upper Mounting View	Lower Mounting View	Manufacturer Numbers
1R12-113 <u>Flexmember</u> 566-24-3-066 <u>Piston</u> Not Included		ASA-92-8-164 	USE EXISTING SUPER CUSHION PISTON	<u>FIRESTONE</u> W013589102 <u>INT'L /</u> <u>NAVISTAR</u> 554769C1 <u>LOAD GUARD</u> SC2053 <u>NEWAY</u> 900-44-201 900-44-653 900-54-218 <u>RIDEWELL</u> 1013589102C <u>TAURUS</u> AS509-9102
1R12-127 <u>Flexmember</u> 566-24-3-024 <u>Piston</u> 566-20-7-240 Composite		ASC-20-8-003 		<u>PREVOST</u> 63-0040 63-0064
1R12-130 <u>Flexmember</u> 566-24-3-038 <u>Piston</u> 566-20-7-080 Composite		ASA-92-8-005 		<u>Conti</u> 64298 910-16P353 <u>FIRESTONE</u> 9227 W013589227 <u>HENDRICKSON</u> B-2924 <u>TRIANGLE</u> 8353
1R12-132 <u>Flexmember</u> 566-24-3-076 <u>Piston</u> 566-20-7-036 Aluminum		ASA-92-8-164 		<u>Conti</u> 64445 910-12A319 910-12A341 910-12A343 910-12A504 910-12P319 <u>DAYTON</u> 352-9105 <u>FIRESTONE</u> 9105 9113 9302 9303 W013589105 W013589302 <u>GRANNING</u> 5065 <u>HDA</u> PMABG-9105B <u>HENDRICKSON</u> 36514-3 B-1245 <u>INT'L /</u> <u>NAVISTAR</u> 554770C1 <u>LOAD GUARD</u> SC2039 <u>R & S TRUCK &</u> <u>BODY</u> 1090276 <u>RIDEWELL</u> 1003580725C 1003589105C S-570-C <u>SAUR AXLES</u> <u>(SAS)</u> P50-705 <u>TAURUS</u> AS302-9302 AS502-0725 AS502-9105 AS502-9113 <u>TRIANGLE</u> 8319 <u>WATSON &</u> <u>CHALIN</u> AS-0015

- - Bolt or Stud 1/2-13 or 1/2-20
- ⊗ - Air Fitting - 1/4 NPTF
- ⊙ - Stud - 3/4-10
- ⊕ - Tapped Hole on Top Retainers 3/8-16, on Pistons - 1/2-13
- ⊗ - Air Fitting - 1/2 NPTF or 3/8 NPTF
- ⊙ - Combination Stud Air Fitting Stud - 3/4-16; Air Fitting - 1/4 NPTF

AIR SPRING ROLLING LOBES

Part No.	Side View With Extended And Compressed Height	Upper Mounting View	Lower Mounting View	Manufacturer Numbers
1R12-139 <u>Flexmember</u> 566-24-3-076 <u>Piston</u> 566-20-7-006 Aluminum	<p>18.7 12.5</p>	ASA-92-8-098 <p>6.20 9.00</p>	<p>7.87 10.13</p>	<u>MCI</u> 12J-1-23
1R12-142 <u>Flexmember</u> 566-24-3-066 <u>Piston</u> 566-20-7-006 Aluminum	<p>27.0 9.4</p>	ASA-92-8-005 <p>6.20 9.00</p>	<p>7.87 10.13</p>	<u>Conti</u> 67479 910-19P946 <u>FIRESTONE</u> W013589241 <u>INTL/</u> <u>NAVISTAR</u> 1681579C1 <u>LOAD GUARD</u> SC2108 <u>SUSPENSIONS</u> <u>INC.</u> 200041
1R12-143 <u>Flexmember</u> 566-24-3-048 <u>Piston</u> 566-20-7-006 Aluminum	<p>22.9 9.5</p>	ASC-20-8-045 <p>5.50 7.70</p>	<p>7.87 10.13</p>	<u>Conti</u> 64302 910-16P376 <u>FIRESTONE</u> 9392 W013589392 <u>HENDRICKSON</u> B-4773 <u>TRIANGLE</u> 8376 TRP AS93920
1R12-145 <u>Flexmember</u> 566-24-3-066 <u>Piston</u> 566-20-7-006 Aluminum	<p>27.0 9.4</p>	ASA-92-8-017 <p>5.50 9.00</p>	<p>7.87 10.13</p>	<u>Conti</u> 64325 910-19P356 DAYTON 352-9238 <u>FIRESTONE</u> 9238 W013589238 <u>HENDRICKSON</u> B-5060 <u>INTL/</u> <u>NAVISTAR</u> 1681737C1 <u>LOAD GUARD</u> SC2109 <u>PREVOST</u> 63-0178 <u>TAURUS</u> AS509-9238 <u>TRIANGLE</u> 8356
1R12-154 <u>Flexmember</u> 566-24-3-048 <u>Piston</u> 566-20-7-120 Composite	<p>17.1 8.0</p>	ASC-20-8-053 <p>5.50 7.70</p>	<p>4.12 10.0</p>	<u>MCI</u> 12J-1-88

- - Bolt or Stud 1/2-13 or 1/2-20
- ⊗ - Air Fitting - 1/4 NPTF
- ⊙ - Stud - 3/4-10
- ⊗ - Tapped Hole on Top Retainers 3/8-16, on Pistons - 1/2-13
- ⊗ - Air Fitting - 1/2 NPTF or 3/8 NPTF
- ⊗ - Combination Stud Air Fitting Stud - 3/4-16; Air Fitting - 1/4 NPTF

AIR SPRING ROLLING LOBES

Part No.	Side View With Extended And Compressed Height	Upper Mounting View	Lower Mounting View	Manufacturer Numbers
1R12-155 <u>Flexmember</u> 566-24-3-038 <u>Piston</u> 566-20-7-080 Composite REPLACED BY 1R12-358		ASA-92-8-002 		Conti 64292 910-16P325 <u>FIRESTONE</u> 9096 W013589096 <u>FRUEHAUF</u> UCE-1304-1 <u>TRIANGLE</u> 8325
1R12-156 <u>Flexmember</u> 566-24-3-067 <u>Piston</u> 566-20-7-055 Aluminum		ASA-92-8-005 		MCI 12K-3-11 <u>PREVOST</u> 63-0179
1R12-167 <u>Flexmember</u> 566-24-3-066 <u>Piston</u> 566-20-7-080 Composite		ASA-92-8-164 		Conti 64323 910-19P326 <u>INTL/</u> <u>NAVISTAR</u> 1681738C1 1681740C1
1R12-169 <u>Flexmember</u> 566-24-3-076 <u>Piston</u> 566-20-7-036-03 Aluminum		ASA-92-8-119 		<u>FLXIBLE</u> 97-2410-00006 97-2410-1 97-2410-2 97-2410-3 97-2410-4 97-2410-5 97-6693-1
1R12-178 <u>Flexmember</u> 566-24-3-067 <u>Piston</u> 566-20-7-055 Aluminum		ASA-92-8-125 		Conti 64361 99-12P379 <u>FIRESTONE</u> 9379 W013589379 <u>INTL/</u> <u>NAVISTAR</u> 1660694C1 <u>LOAD GUARD</u> SC2110 <u>TRIANGLE</u> 8379 <u>TRP</u> AS93790

- - Bolt or Stud 1/2-13 or 1/2-20
- ⊗ - Air Fitting - 1/4 NPTF
- ⊗ - Stud - 3/4-10
- ⊗ - Tapped Hole on Top Retainers 3/8-16, on Pistons - 1/2-13
- ⊗ - Air Fitting - 1/2 NPTF or 3/8 NPTF
- ⊗ - Combination Stud Air Fitting Stud - 3/4-16; Air Fitting - 1/4 NPTF

AIR SPRING ROLLING LOBES

Part No.	Side View With Extended And Compressed Height	Upper Mounting View	Lower Mounting View	Manufacturer Numbers
1R12-182 <u>Flexmember</u> 566-24-3-038 <u>Piston</u> 566-20-7-079 Steel	<p>20.5 6.2</p>	ASA-92-8-004 <p>5.50 9.00</p>	<p>4.12 10.12</p>	Conti 64259 910-16P408 <u>FIRESTONE</u> 9219 W013589219 <u>INTL/</u> <u>NAVISTAR</u> 1681739C1 <u>LOAD GUARD</u> SC2070 <u>TRIANGLE</u> 8408 TRP AS92190 <u>VOLVO</u> 35003-3201 35003-3203 35003-3204 35003-3209
1R12-185 <u>Flexmember</u> 566-24-3-066 <u>Piston</u> 566-20-7-080 Composite	<p>25.2 7.6</p>	ASA-92-8-164 <p>5.50 9.00</p>	<p>7.87 10.13</p>	<u>FIRESTONE</u> 9192 W013589192 <u>HENDRICKSON</u> S6195
1R12-188 <u>Flexmember</u> 566-24-3-038 <u>Piston</u> 566-20-7-079 Steel	<p>20.5 7.1</p>	ASA-92-8-162 <p>5.50 9.00</p>	<p>4.12 10.12</p>	Conti 64275 910-16P409 <u>FIRESTONE</u> 9223 W013589223 <u>HENDRICKSON</u> 48195 <u>REYCO</u> 12884-01 12884-01A <u>TRIANGLE</u> 8409
1R12-195 <u>Flexmember</u> 566-24-3-066 <u>Piston</u> 566-20-7-006 Aluminum	<p>28.5 9.4</p>	ASA-92-8-257 <p>1.50 4.75 9.00</p>	<p>7.87 10.13</p>	Conti 64335 910-19P438 <u>FIRESTONE</u> 9349 W013589349 <u>HENDRICKSON</u> B-8988 <u>REYCO</u> 17636-01 <u>TRIANGLE</u> 8438 TRP AS93490
1R12-204 <u>Flexmember</u> 566-24-3-067 <u>Piston</u> 566-20-7-055 Aluminum	<p>13.5 3.7</p>	ASA-92-8-138 <p>5.50 9.00</p>	<p>4.12 8.60</p>	<u>FIRESTONE</u> 9566 W013589566 <u>INTL/</u> <u>NAVISTAR</u> 1672401C1

- - Bolt or Stud 1/2-13 or 1/2-20
- ⊗ - Air Fitting - 1/4 NPTF
- ⊙ - Stud - 3/4-10
- ⊗ (with diagonal line) - Tapped Hole on Top Retainers 3/8-16, on Pistons - 1/2-13
- ⊗ (with cross) - Air Fitting - 1/2 NPTF or 3/8 NPTF
- ⊗ (with diagonal line and cross) - Combination Stud Air Fitting Stud - 3/4-16; Air Fitting - 1/4 NPTF

AIR SPRING ROLLING LOBES

Part No.	Side View With Extended And Compressed Height	Upper Mounting View	Lower Mounting View	Manufacturer Numbers
1R12-205 <u>Flexmember</u> 566-24-3-076 <u>Piston</u> 566-20-7-055 Aluminum	<p>16.0 5.1</p>	ASA-92-8-125 <p>5.50 9.00</p>	<p>4.12 8.60</p>	Conti 64472 910-14P450 <u>FIRESTONE</u> 9568 W013589568 INT'L/ NAVISTAR 1675495C1 <u>TRIANGLE</u> 8450 TRP AS95680
1R12-208 <u>Flexmember</u> 566-24-3-066 <u>Piston</u> 566-20-7-006 Aluminum	<p>27.0 9.5</p>	ASA-92-8-141 3/4 - 14 NPTF <p>2.87 6.20 9.00</p>	<p>7.87 10.13</p>	Conti 67703 910-19P973 <u>HENDRICKSON</u> C-10443
1R12-212 <u>Flexmember</u> 566-24-3-072 <u>Piston</u> 566-20-7-079 Steel	<p>17.0 6.2</p>	UPPER BEAD PLATE NOT INCLUDED	<p>4.12 10.10</p>	MCI G1004846
1R12-217 <u>Flexmember</u> 566-24-3-048 <u>Piston</u> 566-20-7-120 Composite	<p>17.1 7.3</p>	UPPER BEAD PLATE NOT INCLUDED. SHOWN FOR REFERENCE ONLY.	<p>4.12 10.0</p>	MCI 12L-1-104 12L-1-136 <u>PREVOST</u> 63-0181
1R12-220 <u>Flexmember</u> 566-24-3-038 <u>Piston</u> 566-20-7-080 Composite	<p>21.1 7.7</p>	ASA-92-8-164 <p>5.50 9.00</p>	<p>7.87 10.10</p>	Conti 64301 910-16P372 <u>FIRESTONE</u> 9092 W013589092 <u>HENDRICKSON</u> B-12353 INT'L/ NAVISTAR 517096C91 NEWAY 905-57-031 <u>TRIANGLE</u> 8372

- - Bolt or Stud 1/2-13 or 1/2-20
- ⊗ - Air Fitting - 1/4 NPTF
- ⊗ - Stud - 3/4-10
- ⊗ - Tapped Hole on Top Retainers 3/8-16, on Pistons - 1/2-13
- ⊗ - Air Fitting - 1/2 NPTF or 3/8 NPTF
- ⊗ - Combination Stud Air Fitting Stud - 3/4-16; Air Fitting - 1/4 NPTF

AIR SPRING ROLLING LOBES

Part No.	Side View With Extended And Compressed Height	Upper Mounting View	Lower Mounting View	Manufacturer Numbers
1R12-256 <u>Flexmember</u> 566-24-3-090 <u>Piston</u> 566-20-7-159 Composite	<p>29.1 9.5</p>	ASA-92-8-142 <p>6.20 9.00</p>	<p>7.87 9.80</p>	Conti 64384 64716 910-21A505 910-21P505 <u>FIRESTONE</u> 9367 W013589321 W013589367 <u>HENDRICKSON</u> B-14249 B-4375 <u>LOAD GUARD</u> SC2120 <u>SUSPENSIONS INC.</u> 201335 <u>TRIANGLE</u> 8505 <u>TRP</u> AS93670 AS9367A <u>WATSON & CHALIN</u> AS-0104
1R12-261 <u>Flexmember</u> 566-24-3-066 <u>Piston</u> 566-20-7-006 Aluminum	<p>27.0 9.4</p>	ASA-92-8-005 <p>6.20 9.00</p>	<p>7.87 10.10</p>	Conti 64327 910-19A358 910-19Pxxx <u>DAYTON</u> 352-9321 <u>FIRESTONE</u> 9241 W013589241 <u>R & S TRUCK & BODY</u> 10907 <u>TAURUS</u> AS509-9241 <u>TRIANGLE</u> 8358 8361
1R12-265 <u>Flexmember</u> 566-24-3-066 <u>Piston</u> 566-20-7-080 Composite REPLACED BY 1R12-167	<p>25.2 7.7</p>	ASA-92-8-164 <p>5.50 9.00</p>	<p>7.87 10.10</p>	Conti 64331 910-19P390
1R12-274 <u>Flexmember</u> 566-24-3-097 <u>Piston</u> 566-20-7-079 Steel	<p>22.8 8.1</p>	ASA-92-8-121 <p>6.20 9.00</p>	<p>4.12 10.12</p>	
1R12-281 <u>Flexmember</u> 566-24-3-066 <u>Piston</u> 566-20-7-080 Composite	<p>25.2 9.0</p>	ASA-92-8-121 <p>6.20 9.00</p>	<p>7.87 10.10</p>	Conti 64327 64615 910-19A358 910-19P321 910-19P358 <u>DAYTON</u> 352-9130 <u>FIRESTONE</u> 9130 9394 W013589130 W013589394 <u>FRUEHAUF</u> UCE-9393-1 UCE-9393-3 UCE-9393-4 <u>TRIANGLE</u> 8321

- - Bolt or Stud 1/2-13 or 1/2-20
- ⊗ - Air Fitting - 1/4 NPTF
- ⊙ - Stud - 3/4-10
- ⊗ - Tapped Hole on Top Retainers 3/8-16, on Pistons - 1/2-13
- ⊗ - Air Fitting - 1/2 NPTF or 3/8 NPTF
- ⊗ - Combination Stud Air Fitting Stud - 3/4-16; Air Fitting - 1/4 NPTF

AIR SPRING ROLLING LOBES

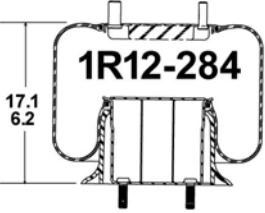
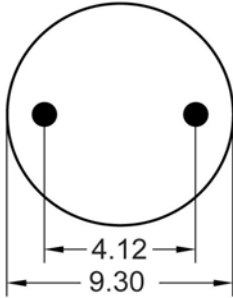
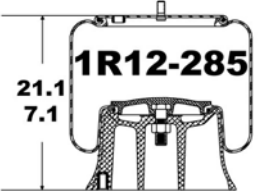
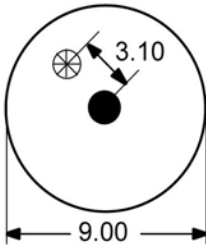
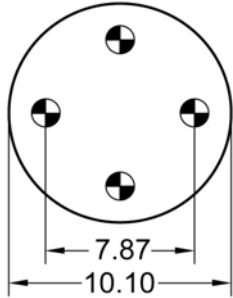
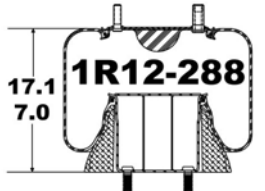
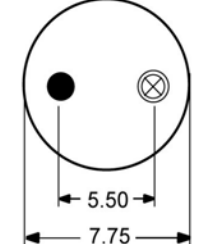
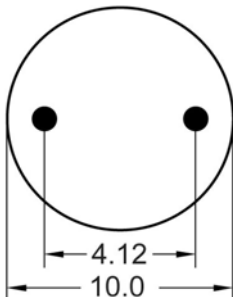
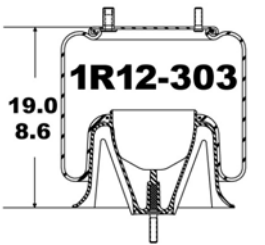
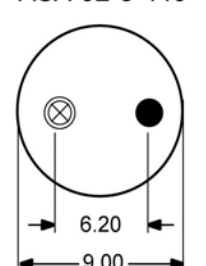
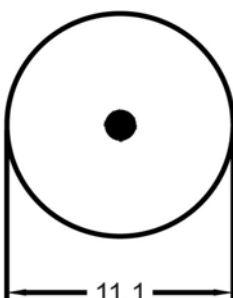
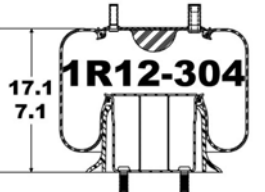
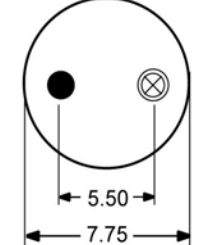
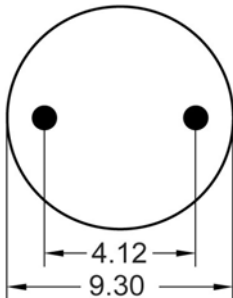
Part No.	Side View With Extended And Compressed Height	Upper Mounting View	Lower Mounting View	Manufacturer Numbers
1R12-284 <u>Flexmember</u> 566-24-3-048 <u>Piston</u> 566-20-7-240 Composite		UPPER BEAD PLATE NOT INCLUDED. SHOWN FOR REFERENCE ONLY.		
1R12-285 <u>Flexmember</u> 566-24-3-038 <u>Piston</u> 566-20-7-080 Composite		ASC-92-8-088 		<u>Conti</u> 64632 910-14P709 <u>FIRESTONE</u> W359060 <u>NEW FLYER</u> 14635 65
1R12-288 <u>Flexmember</u> 566-24-3-048 <u>Piston</u> 566-20-7-120 Composite		ASC-20-8-110 		<u>MCI</u> 12C-1-126 12K-1-45 12L-1-126 <u>PREVOST</u> 63-0180
1R12-303 <u>Flexmember</u> 566-24-3-108 <u>Piston</u> 566-20-7-116 Composite		ASA-92-8-440 		<u>Conti</u> 67473 910S-16A382 910S-16P382 <u>FIRESTONE</u> 5779 9780 W013589780 <u>FLEETRITE</u> 1R12-1054 <u>FREIGHTLINER</u> 16-13810-000 16-13810-001 16-13810-002 16-14377-000 16-15595-000 16-15595-001 16-15595-002 16-16825-000 16-19468-000 18-18335-000 18-18335-001 <u>TRIANGLE</u> 8382 <u>TRP</u> AS9870A
1R12-304 <u>Flexmember</u> 566-24-3-048 <u>Piston</u> 566-20-7-240 Composite		ASC-20-8-110 		<u>FIRESTONE</u> 9018 W013589018 <u>MCI</u> 12G-1-60 12L-1-133 12L-1-135 12L-1-142 <u>PREVOST</u> 63-0182

- - Bolt or Stud 1/2-13 or 1/2-20
- ⊗ - Air Fitting - 1/4 NPTF
- ⊙ - Stud - 3/4-10
- ⊕ - Tapped Hole on Top Retainers 3/8-16, on Pistons - 1/2-13
- ⊗ - Air Fitting - 1/2 NPTF or 3/8 NPTF
- ⊙ - Combination Stud Air Fitting Stud - 3/4-16; Air Fitting - 1/4 NPTF

AIR SPRING ROLLING LOBES

Part No.	Side View With Extended And Compressed Height	Upper Mounting View	Lower Mounting View	Manufacturer Numbers
1R12-309 <u>Flexmember</u> 566-24-3-067 <u>Piston</u> 566-20-7-164 Steel	<p>14.9 6.0</p>	ASA-92-8-002 <p>2.88 6.20 9.00</p>	<p>5.66 9.50</p>	Conti 64446 910-12A327 DAYTON 352-9053 E-Z RIDE 8030192 FAB TEK 10828 FIRESTONE 9053 W013589053 FRUEHAUF UCE-1304-2 RIDEWELL 1003589053C TAURUS AS502-9053 TRIANGLE 8327 WATSON & CHALIN AS-0095
1R12-324 <u>Flexmember</u> 566-24-3-067 <u>Piston</u> 566-20-7-055 Aluminum	<p>13.5 3.7</p>	ASA-92-8-138 <p>5.50 9.00</p>	M12x1.75-6g <p>8.60</p>	FIRESTONE 9565 W013589565 INT'L/ NAVISTAR 2027912C1
1R12-325 <u>Flexmember</u> 566-24-3-076 <u>Piston</u> 566-20-7-055 Aluminum	<p>15.3 5.1</p>	ASA-92-8-125 <p>5.50 9.00</p>	M12x1.75-6g <p>8.60</p>	Conti 64473 910-14P461 FIRESTONE 9567 W013589567 INT'L/ NAVISTAR 2027913C1 TRIANGLE 8461 TRP AS95670
1R12-335 <u>Flexmember</u> 566-24-3-090 <u>Piston</u> 566-20-7-006 Aluminum	<p>29.1 9.4</p>	ASA-92-8-142 <p>6.20 9.00</p>	<p>7.87 10.13</p>	Conti 64291 64715 910-21A361 910-21P361 FIRESTONE 9321 W013589321 TRP AS93210 WATSON & CHALIN AS-0036
1R12-350 <u>Flexmember</u> 566-24-3-061 <u>Piston</u> 566-20-7-197 Aluminum	<p>13.1 5.3</p>	ASA-92-8-002 <p>2.88 6.20 9.00</p>	<p>9.25</p>	Conti 64433 910-10P339 FIRESTONE 9031 W013589031 PEERLESS 0550-00051 TAURUS AS500-9031 TRIANGLE 8339

- - Bolt or Stud - 1/2-13 or 1/2-20
- ⊗ - Air Fitting - 1/4 NPTF
- ⊙ - Stud - 3/4-10
- ⊕ - Tapped Hole on Top Retainers - 3/8-16, on Pistons - 1/2-13
- ⊗ - Air Fitting - 1/2 NPTF or 3/8 NPTF
- ⊙⊗ - Combination Stud Air Fitting - Stud - 3/4-16; Air Fitting - 1/4 NPTF

AIR SPRING ROLLING LOBES

Part No.	Side View With Extended And Compressed Height	Upper Mounting View	Lower Mounting View	Manufacturer Numbers	
1R12-351 <u>Flexmember</u> 566-24-3-061 <u>Piston</u> 566-20-7-197 Aluminum	<p>13.1 5.3</p>	ASA-92-8-003 <p>2.88 6.20 9.00</p>	<p>9.25</p>	Conti 64430 910-10P328 <u>FIRESTONE</u> 9033 W013589033 <u>NEWAY</u> 905-57-012 AR-1515-1 <u>TAURUS</u> AS500-9033 <u>TRIANGLE</u> 8328	
1R12-352 <u>Flexmember</u> 566-24-3-076 <u>Piston</u> 566-20-7-080 Composite	<p>18.0 7.2</p>	ASA-92-8-004 <p>5.50 9.00</p>	<p>7.87 10.10</p>	Conti 64258 910-14P345 <u>FIRESTONE</u> W013589010 <u>HENDRICKSON</u> B-2827	
1R12-355 <u>Flexmember</u> 566-24-3-076 <u>Piston</u> 566-20-7-036 Aluminum	<p>16.9 5.6</p>	ASA-92-8-088 <p>2.88 9.00</p>	<p>7.87 10.10</p>	Conti 64447 910-12A329 910-12P329 <u>FIRESTONE</u> 9078 W013589078 <u>FRUEHAUF</u> MFR-022355 UCB-9668-1 <u>TRIANGLE</u> 8329	
1R12-356 <u>Flexmember</u> 566-24-3-038 <u>Piston</u> 566-20-7-080 Composite	<p>21.0 6.5</p>	ASA-92-8-258 1.25-12 UNF outside 500-14 NPTF inside <p>6.13 9.00</p>	<p>7.87 10.10</p>	Conti 64297 910-16P352 <u>DAYTON</u> 352-9194 <u>FIRESTONE</u> 9194 W013589194 <u>PETERBILT</u> 03-05107 <u>TAURUS</u> AS506-9194 <u>TRIANGLE</u> 8352	<u>WATSON & CHALIN</u> AS-0101
1R12-357 <u>Flexmember</u> 566-24-3-066 <u>Piston</u> 566-20-7-006 Aluminum OBSOLETE	<p>27.0 10.7</p>	ASA-92-8-257 <p>1.50 4.75 9.00</p>	<p>7.87 10.13</p>	Conti 65356 910-19P439 <u>FIRESTONE</u> 9348 W013589348 <u>TAURUS</u> AS509-9348 <u>TRP</u> AS93480	

- - Bolt or Stud 1/2-13 or 1/2-20
- ⊗ - Air Fitting - 1/4 NPTF
- ⊙ - Stud - 3/4-10
- ⊕ - Tapped Hole on Top Retainers 3/8-16, on Pistons - 1/2-13
- ⊗ - Air Fitting - 1/2 NPTF or 3/8 NPTF
- ⊙ - Combination Stud Air Fitting Stud - 3/4-16; Air Fitting - 1/4 NPTF

AIR SPRING ROLLING LOBES

Part No.	Side View With Extended And Compressed Height	Upper Mounting View	Lower Mounting View	Manufacturer Numbers
1R12-358 <u>Flexmember</u> 566-24-3-038 <u>Piston</u> 566-20-7-080 Composite	<p>21.1 7.7</p>	ASA-92-8-003 <p>2.88 6.20 9.00</p>	<p>7.87 10.10</p>	Conti 64292 910-16P325 DAYTON 352-9096 FIRESTONE 9096 W013589096 FRUEHAUF UCE-1304-1 TAURUS AS504-9096 TRIANGLE 8325
1R12-359 <u>Flexmember</u> 566-24-3-061 <u>Piston</u> 566-20-7-197 Aluminum	<p>13.1 5.3</p>	ASA-92-8-088 <p>2.88 9.00</p>	<p>9.25</p>	Conti 64431 910-10P331 FIRESTONE 9077 W013589077 FRUEHAUF MFR-022354 UCB-4453-1 TAURUS AS500-9077 TRIANGLE 8331
1R12-363 <u>Flexmember</u> 566-24-3-090 <u>Piston</u> 566-20-7-159 Composite	<p>29.1 9.5</p>	ASA-92-8-164 <p>5.50 9.00</p>	<p>7.87 9.80</p>	Conti 64382 910-21P360 FIRESTONE 9320 W013589320 NEWAY 905-57-099 TRIANGLE 8360 TRP AS93200
1R12-365 <u>Flexmember</u> 566-24-3-038 <u>Piston</u> 566-20-7-079 Steel	<p>20.6 8.1</p>	ASA-92-8-121 <p>6.20 9.00</p>	<p>4.50 10.13</p>	Conti 64276 910-16P410 FIRESTONE 9466 W013589466 HENDRICKSON 49048 49674 MACK TRUCK 364SQ28 57QL411M TRIANGLE 8410
1R12-366 <u>Flexmember</u> 566-24-3-038 <u>Piston</u> 566-20-7-163 Steel	<p>21.2 7.3</p>	AS1-92-8-192 <p>3.05 9.00</p>	<p>5.66 9.50</p>	Conti 64401 910-16P710 910-17-5P436 910-175P436 FIRESTONE 8944 9015 9299 W013588944 W013589015 W013589299 HENDRICKSON C-20217

- - Bolt or Stud 1/2-13 or 1/2-20
- ⊗ - Air Fitting - 1/4 NPTF
- ⊙ - Stud - 3/4-10
- ⊕ - Tapped Hole on Top Retainers 3/8-16, on Pistons - 1/2-13
- ⊗ - Air Fitting - 1/2 NPTF or 3/8 NPTF
- ⊙ - Combination Stud Air Fitting Stud - 3/4-16; Air Fitting - 1/4 NPTF

AIR SPRING ROLLING LOBES

Part No.	Side View With Extended And Compressed Height	Upper Mounting View	Lower Mounting View	Manufacturer Numbers
1R12-367 <u>Flexmember</u> 566-24-3-076 <u>Piston</u> 566-20-7-164 Steel	<p>16.6 5.5</p>	ASC-92-8-192 <p>3.05 9.00</p>	<p>5.66 9.50</p>	Conti 64395 910-12A427 FIRESTONE 9640 W013589640 HENDRICKSON C-20223 TRIANGLE 8427 TRP AS96400
1R12-369 <u>Flexmember</u> 566-24-3-038 <u>Piston</u> 566-20-7-079 Steel	<p>20.0 6.7</p>	ASA-92-8-165 <p>5.70 9.00</p>	<p>10.12</p>	DINA 2027911C1
1R12-370 <u>Flexmember</u> 566-24-3-076 <u>Piston</u> 566-20-7-036 Aluminum	<p>16.9 6.1</p>	ASA-92-8-162 <p>5.50 9.00</p>	<p>7.87 10.10</p>	Conti 64464 910-14A330 FIRESTONE 9070 W013589070 NEWAY 905-57-038-1 905-57-090 AR-90112 TAURUS AS504-9070 TRIANGLE 8330 8490 WATSON & CHALIN AS-0050 AS-0053
1R12-375 <u>Flexmember</u> 566-24-3-165 <u>Piston</u> 566-20-7-163 Steel	<p>24.9 7.8</p>	ASA-92-8-192 <p>3.05 9.00</p>	<p>5.66 9.50</p>	Conti 64288 910-19P435 FIRESTONE 9265 W013589265 FLEETRITE 1R12-1055 HENDRICKSON 20413 C-20124 TRIANGLE 8435 TRP AS92650
1R12-377 <u>Flexmember</u> 566-24-3-120 <u>Piston</u> 566-20-7-192 Steel	<p>19.6 9.7</p>	ASA-92-8-268 1 1/4 x 12 .500 X 14 NPTF <p>5.75 9.00</p>	<p>4.12 10.10</p>	PREVOST 63-0151

- - Bolt or Stud 1/2-13 or 1/2-20
- ⊗ - Air Fitting - 1/4 NPTF
- ⊗ - Stud - 3/4-10
- ⊗ - Tapped Hole on Top Retainers 3/8-16, on Pistons - 1/2-13
- ⊗ - Air Fitting - 1/2 NPTF or 3/8 NPTF
- ⊗ - Combination Stud Air Fitting Stud - 3/4-16; Air Fitting - 1/4 NPTF

AIR SPRING ROLLING LOBES

Part No.	Side View With Extended And Compressed Height	Upper Mounting View	Lower Mounting View	Manufacturer Numbers
1R12-383 <u>Flexmember</u> 566-24-3-061 <u>Piston</u> 566-20-7-014 Steel		ASA-92-8-162 		<u>FLXIBLE</u> 97-9999-02185 <u>ORION</u> 010132404-4
1R12-394 <u>Flexmember</u> 566-24-3-038 <u>Piston</u> Not Included		ASA-92-8-283 	USE EXISTING SUPER CUSHION PISTON	<u>MCI</u> 12L-1-169 <u>PREVOST</u> 63-0224
1R12-395 <u>Flexmember</u> 566-24-3-066 <u>Piston</u> 566-20-7-080 Composite		ASA-92-8-005 		<u>Conti</u> 64324 910-19P355 <u>DAYTON</u> 352-9203 <u>FIRESTONE</u> 9203 W013589203 <u>HENDRICKSON</u> B-2694 <u>TAURUS</u> AS509-9203 <u>TRIANGLE</u> 8355
1R12-396 <u>Flexmember</u> 566-24-3-038 <u>Piston</u> 566-20-7-240 Composite		ASA-92-8-283 		<u>MCI</u> 12L-1-140 <u>PREVOST</u> 63-0183
1R12-400 <u>Flexmember</u> 566-24-3-038 <u>Piston</u> 566-20-7-246 Steel		ASA-92-8-306 		<u>Conti</u> 64310 910-16P416 <u>FIRESTONE</u> 9296 W013589296 <u>TRIANGLE</u> 8416 <u>TRP</u> AS92960 <u>VOLVO</u> 8061151 8169868

- - Bolt or Stud 1/2-13 or 1/2-20
- ⊗ - Air Fitting - 1/4 NPTF
- ⊙ - Stud - 3/4-10
- ⊖ - Tapped Hole on Top Retainers 3/8-16, on Pistons - 1/2-13
- ⊗ - Air Fitting - 1/2 NPTF or 3/8 NPTF
- ⊙ - Combination Stud Air Fitting Stud - 3/4-16; Air Fitting - 1/4 NPTF

AIR SPRING ROLLING LOBES

Part No.	Side View With Extended And Compressed Height	Upper Mounting View	Lower Mounting View	Manufacturer Numbers	
1R12-401 <u>Flexmember</u> 566-24-3-163 <u>Piston</u> 566-20-7-221 Composite		ASA-92-8-165 		<u>Conti</u> 64290 910-175P521 910-18-5P521 910-185P521 <u>FIRESTONE</u> 9371 W013589371 <u>FLEETRITE</u> 1R12-1062 <u>INTL/</u> <u>NAVISTAR</u> 1670043C1 1686386C1	<u>TRIANGLE</u> 8521 <u>TRP</u> AS93710
1R12-402 <u>Flexmember</u> 566-24-3-097 <u>Piston</u> 566-20-7-246 Steel		ASA-92-8-199 		<u>Conti</u> 64410 910-175P520 910-18-5P520 910-185P520 <u>FIRESTONE</u> 9297 W013589297 <u>HENDRICKSON</u> 50898-1 50898-2 <u>TRIANGLE</u> 8520	<u>TRP</u> AS92970
1R12-403 <u>Flexmember</u> 566-24-3-140 <u>Piston</u> 566-20-7-377 Steel		ASA-92-8-430 		<u>Conti</u> 64265 64336 910-175P440 910-175P519 910-18-5P440 910-185P440 910-18-5P519 910-185P519 <u>FIRESTONE</u> 9373 W013589373 <u>FLEETRITE</u> 1R12-1056	<u>HENDRICKSON</u> 57122-1 <u>MCI</u> 2992101C1 <u>TRIANGLE</u> 8519 <u>TRP</u> AS93730
1R12-404 <u>Flexmember</u> 566-24-3-097 <u>Piston</u> 566-20-7-246 Steel		ASA-92-8-430 		<u>Conti</u> 64264 910-175P451 910-18-5P451 910-185P451 <u>FIRESTONE</u> 9375 W013589375 <u>FLEETRITE</u> 1R12-1063 <u>HENDRICKSON</u> 50899-1 50899-2	<u>MACK TRUCK</u> 364SQ27 57QL414M <u>TRIANGLE</u> 8451 <u>TRP</u> AS93750
1R12-406 <u>Flexmember</u> 566-24-3-120 <u>Piston</u> 566-20-7-223 Steel		ASA-92-8-268 		<u>PREVOST</u> 63-0162	

- - Bolt or Stud 1/2-13 or 1/2-20
- ⊗ - Air Fitting - 1/4 NPTF
- ⊙ - Stud - 3/4-10
- ⊕ - Tapped Hole on Top Retainers 3/8-16, on Pistons - 1/2-13
- ⊗ - Air Fitting - 1/2 NPTF or 3/8 NPTF
- ⊙ - Combination Stud Air Fitting Stud - 3/4-16; Air Fitting - 1/4 NPTF

AIR SPRING ROLLING LOBES

Part No.	Side View With Extended And Compressed Height	Upper Mounting View	Lower Mounting View	Manufacturer Numbers
1R12-419 <u>Flexmember</u> 566-24-3-038 <u>Piston</u> 566-20-7-233 Composite	<p>21.1 8.2</p>	ASA-92-8-311 <p>M12x1.75-6G .750-14 NPTF 5.87 9.00</p>	<p>7.87 M12 x 1.75-6G 9.80</p>	
1R12-421 <u>Flexmember</u> 566-24-3-076 <u>Piston</u> 566-20-7-158 Composite	<p>18.0 7.0</p>	ASA-92-8-164 <p>5.50 9.00</p>	<p>7.87 9.80</p>	<u>Conti</u> 64258 910-14P345 <u>FIRESTONE</u> 9010 W013589010 <u>REYCO</u> 12928-01 <u>RIDEWELL</u> 1003589010C <u>TRIANGLE</u> 8345 <u>WATSON &</u>
1R12-422 <u>Flexmember</u> 566-24-3-076 <u>Piston</u> 566-20-7-036 Aluminum	<p>16.9 6.1</p>	ASA-92-8-013 <p>6.20 9.00</p>	<p>7.87 10.10</p>	<u>Conti</u> 68638 910-12A104 <u>NOVABUS</u> N21361
1R12-423 <u>Flexmember</u> 566-24-3-038 <u>Piston</u> 566-20-7-246 Steel	<p>4.38 3.00 3.14 2.25 20.0 8.1</p>	ASA-92-8-199 <p>6.20 9.00</p>	<p>M12x1.75-6g 10.13</p>	<u>VOLVO</u> 3180673
1R12-424 <u>Flexmember</u> 566-24-3-097 <u>Piston</u> 566-20-7-246 Steel	<p>7.75 5.98 3.64 2.36 20.0 8.1</p>	ASA-92-8-199 <p>6.20 9.00</p>	<p>4.50 10.13</p>	<u>Conti</u> 64277 910-175P406 910-18-5P406 910-185P406 <u>FIRESTONE</u> 9287 W013589287 <u>GMC</u> 15963160 <u>HENDRICKSON</u> 50405 50405-1 50405-2

- - Bolt or Stud 1/2-13 or 1/2-20
- ⊗ - Air Fitting - 1/4 NPTF
- ⊙ - Stud - 3/4-10
- ⊕ - Tapped Hole on Top Retainers 3/8-16, on Pistons - 1/2-13
- ⊗ - Air Fitting - 1/2 NPTF or 3/8 NPTF
- ⊙ - Combination Stud Air Fitting Stud - 3/4-16; Air Fitting - 1/4 NPTF

AIR SPRING ROLLING LOBES

Part No.	Side View With Extended And Compressed Height	Upper Mounting View	Lower Mounting View	Manufacturer Numbers
1R12-432 <u>Flexmember</u> 566-24-3-165 <u>Piston</u> 566-20-7-236 Composite		ASA-92-8-344 	M12x1.75-6g 	Conti 66908 910B-19-5P889 910B-195P889 INTL/ NAVISTAR 350243C94 TRP ASP8890
1R12-434 <u>Flexmember</u> 566-24-3-076 <u>Piston</u> 566-20-7-164 Steel		ASA-92-8-164 		Conti 64477 910-14A469 910-14P469 FIRESTONE 8802 W013588802 NEWAY 905-57-170 RIDEWELL 1003588802C TRIANGLE 8469
1R12-435 <u>Flexmember</u> 566-24-3-067 <u>Piston</u> 566-20-7-014 Steel		ASA-92-8-162 		Conti 910-10P471 910-10P482 FIRESTONE 9307 9334 NEWAY 905-57-129 RIDEWELL 1003589334C TRIANGLE 8471 8482 TRP AS93070 AS93340
1R12-436 <u>Flexmember</u> 566-24-3-038 <u>Piston</u> 566-20-7-158 Composite		ASA-92-8-017 		Conti 64314 910-16P497 FIRESTONE 8924 W013588924 RIDEWELL 1003588924C TRIANGLE 8497
1R12-437 <u>Flexmember</u> 566-24-3-076 <u>Piston</u> 566-20-7-156 Composite		ASA-92-8-017 		Conti 64484 910-14A496 FIRESTONE 9797 W013589797 RIDEWELL 1003589797C TRIANGLE 8496 TRP AS97970

- - Bolt or Stud 1/2-13 or 1/2-20
- ⊗ - Air Fitting - 1/4 NPTF
- ⊙ - Stud - 3/4-10
- ⊕ - Tapped Hole on Top Retainers 3/8-16, on Pistons - 1/2-13
- ⊗ - Air Fitting - 1/2 NPTF or 3/8 NPTF
- ⊙ - Combination Stud Air Fitting Stud - 3/4-16; Air Fitting - 1/4 NPTF

AIR SPRING ROLLING LOBES

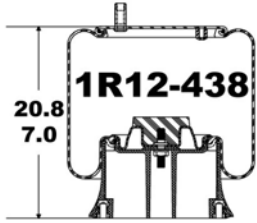
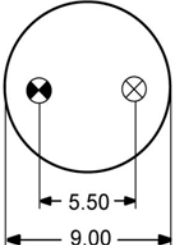
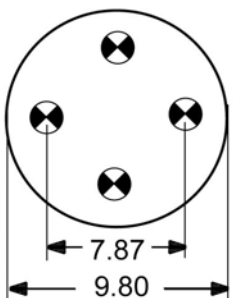
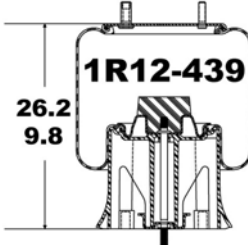
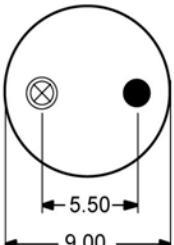
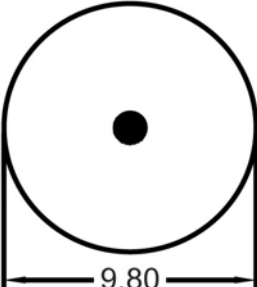
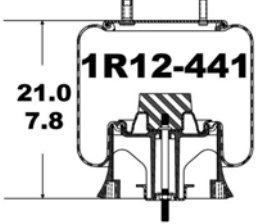
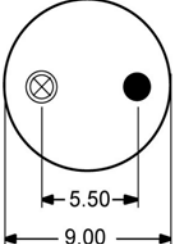
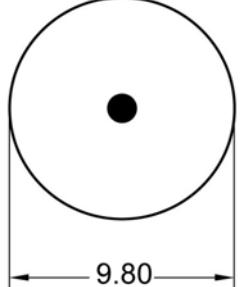
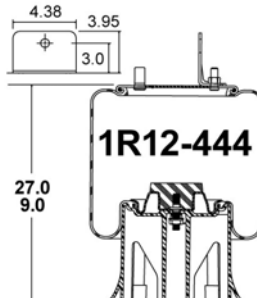
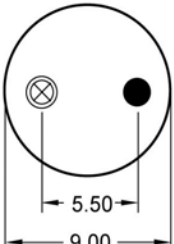
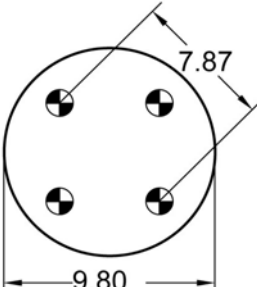
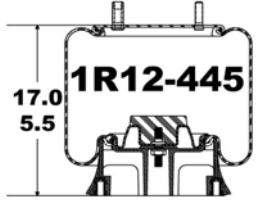
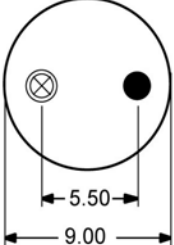
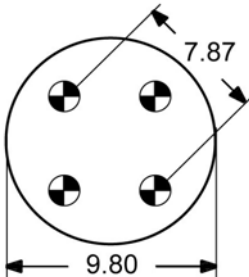
Part No.	Side View With Extended And Compressed Height	Upper Mounting View	Lower Mounting View	Manufacturer Numbers
1R12-438 <u>Flexmember</u> 566-24-3-038 <u>Piston</u> 566-20-7-158 Composite		ASA-92-8-017 		Conti 64474 910-14P462 FIRESTONE 8805 W013588805 RIDEWELL 1003588805C TRIANGLE 8462
1R12-439 <u>Flexmember</u> 566-24-3-066 <u>Piston</u> 566-20-7-237 Composite		ASA-92-8-164 		Conti 64338 910-19P470 FIRESTONE 9346 W013589346 NEWAY 905-57-126 TRIANGLE 8470 TRP AS93460 WATSON & CHALIN AS-0056
1R12-441 <u>Flexmember</u> 566-24-3-038 <u>Piston</u> 566-20-7-235 Composite		ASA-92-8-164 		Conti 64304 910-16P391 FIRESTONE 9362 W013589362 NEWAY 905-57-113 TRIANGLE 8391 TRP AS93620 WATSON & CHALIN AS-0049
1R12-444 <u>Flexmember</u> 566-24-3-066 <u>Piston</u> 566-20-7-159 Composite		ASA-92-8-004 		
1R12-445 <u>Flexmember</u> 566-24-3-076 <u>Piston</u> 566-20-7-156 Composite		ASA-92-8-164 		Conti 64486 910-14A545 FIRESTONE 8806 W013588806 RIDEWELL 1003588802X

- - Bolt or Stud 1/2-13 or 1/2-20
- ⊗ - Air Fitting - 1/4 NPTF
- ⊙ - Stud - 3/4-10
- ⊗ (with dot) - Tapped Hole on Top Retainers 3/8-16, on Pistons - 1/2-13
- ⊗ (with cross) - Air Fitting - 1/2 NPTF or 3/8 NPTF
- ⊗ (with circle) - Combination Stud Air Fitting Stud - 3/4-16; Air Fitting - 1/4 NPTF

AIR SPRING ROLLING LOBES

Part No.	Side View With Extended And Compressed Height	Upper Mounting View	Lower Mounting View	Manufacturer Numbers
1R12-446 <u>Flexmember</u> 566-24-3-097 <u>Piston</u> 566-20-7-158 Composite	<p>23.2 7.9</p>	ASA-92-8-164 <p>5.50 9.00</p>	<p>7.87 9.80</p>	Conti 64331 910-19P390 <u>FIRESTONE</u> 9245 W013589245 <u>RIDEWELL</u> 1003589245C <u>TRIANGLE</u> 8390 TRP AS92450
1R12-450 <u>Flexmember</u> 566-24-3-097 <u>Piston</u> 566-20-7-158 Composite	<p>23.2 6.6</p>	ASA-92-8-164 <p>5.50 9.00</p>	<p>7.87 9.80</p>	Conti 64334 910-17-5P418 <u>FIRESTONE</u> W013589342
1R12-454 <u>Flexmember</u> 566-24-3-038 <u>Piston</u> 566-20-7-079 Steel	<p>17.1 7.3</p>	ASA-92-8-283 <p>2.50 1.50 4.50 9.00</p>	<p>4.12 10.12</p>	Conti 69075 910-16P130 <u>MCI</u> 12L-1-215
1R12-462 <u>Flexmember</u> 566-24-3-038 <u>Piston</u> 566-20-7-246 Steel	<p>4.38 1.97 2.30 3.14 20.0 8.1</p>	ASA-92-8-199 <p>6.20 9.00</p>	M12x1.75-6g <p>10.13</p>	<u>VOLVO</u> 3180984P2
1R12-465 <u>Flexmember</u> 566-24-3-067 <u>Piston</u> 566-20-7-014 Steel	<p>13.5 4.4</p>	ASA-92-8-013 <p>6.20 9.00</p>	<p>9.25</p>	Conti 64440 910-10P473 <u>FIRESTONE</u> W013588963

- - Bolt or Stud 1/2-13 or 1/2-20
- ⊗ - Air Fitting - 1/4 NPTF
- ⊗ - Stud - 3/4-10
- ⊗ - Tapped Hole on Top Retainers 3/8-16, on Pistons - 1/2-13
- ⊗ - Air Fitting - 1/2 NPTF or 3/8 NPTF
- ⊗ - Combination Stud Air Fitting Stud - 3/4-16; Air Fitting - 1/4 NPTF

AIR SPRING ROLLING LOBES

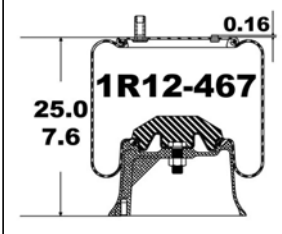
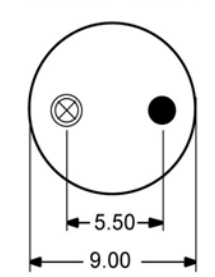
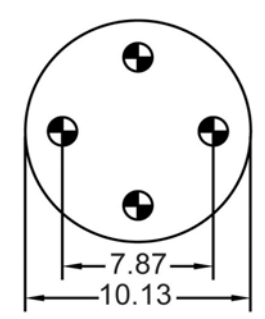
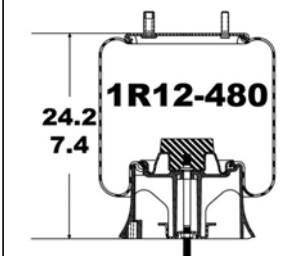
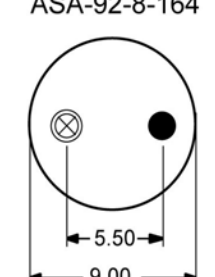
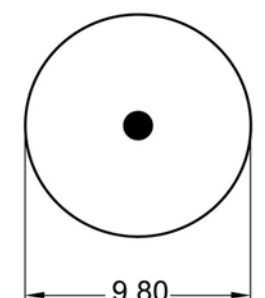
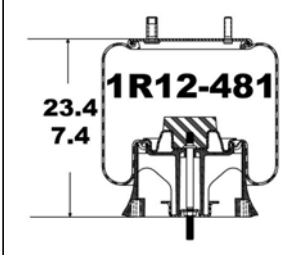
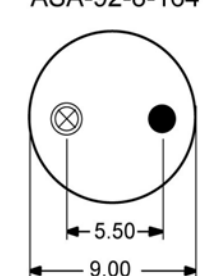
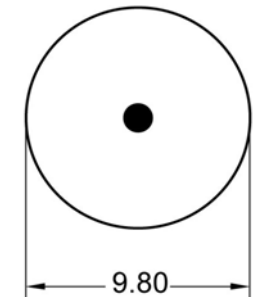
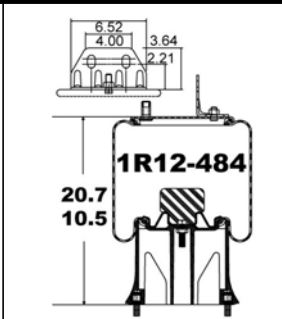
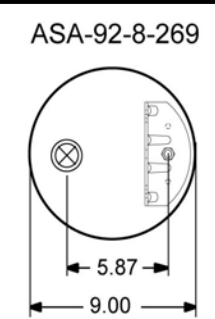
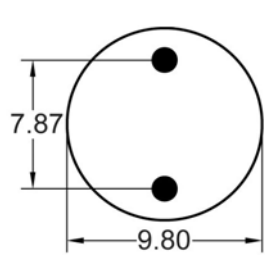
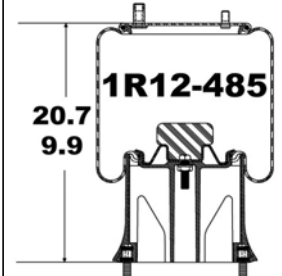
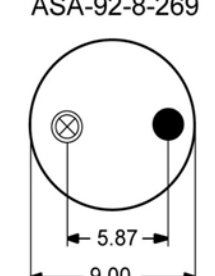
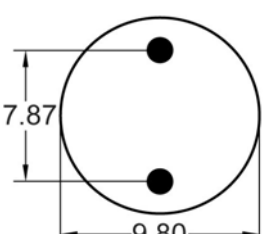
Part No.	Side View With Extended And Compressed Height	Upper Mounting View	Lower Mounting View	Manufacturer Numbers
1R12-467 <u>Flexmember</u> 566-24-3-066 <u>Piston</u> 566-20-7-005 Aluminum		ASA-92-8-331 		Conti 65387 65807 910-195P801 910-19A801 910-19A830 910-19P801 RIDEWELL 1000001 TRP AS2467G ASA8010
1R12-480 <u>Flexmember</u> 566-24-3-066 <u>Piston</u> 566-20-7-235 Composite		ASA-92-8-164 		Conti 64329 910-19P384 FIRESTONE 9243 W013589243 NEWAY 905-57-112 WATSON & CHALIN AS-0061
1R12-481 <u>Flexmember</u> 566-24-3-097 <u>Piston</u> 566-20-7-235 Composite		ASA-92-8-164 		Conti 64278 910-17-5P429 910-175P429 FIRESTONE 9923 W013589923 NEWAY 905-57-118 TRIANGLE 8429 TRP AS99230
1R12-484 <u>Flexmember</u> 566-24-3-038 <u>Piston</u> 566-20-7-215 Composite		ASA-92-8-269 		Conti 64418 910-17-5P574 910-175P574 NEWAY 905-57-215
1R12-485 <u>Flexmember</u> 566-24-3-038 <u>Piston</u> 566-20-7-215 Composite		ASA-92-8-269 		Conti 910-175P715 NEWAY 905-57-214 TRP AS95010

- - Bolt or Stud 1/2-13 or 1/2-20
- ⊗ - Air Fitting - 1/4 NPTF
- ⊙ - Stud - 3/4-10
- ◐ - Tapped Hole on Top Retainers 3/8-16, on Pistons - 1/2-13
- ⊗ - Air Fitting - 1/2 NPTF or 3/8 NPTF
- ⊗ - Combination Stud Air Fitting Stud - 3/4-16; Air Fitting - 1/4 NPTF

AIR SPRING ROLLING LOBES

Part No.	Side View With Extended And Compressed Height	Upper Mounting View	Lower Mounting View	Manufacturer Numbers
1R12-486 <u>Flexmember</u> 566-24-3-038 <u>Piston</u> 566-20-7-215 Composite	<p>20.7 10.5</p>	ASA-92-8-269 <p>5.87 9.00</p>	<p>7.87 9.80</p>	Conti 64418 910-17-5P574 910-175P574 910-175P714 NEWAY 905-57-216
1R12-487 <u>Flexmember</u> 566-24-3-067 <u>Piston</u> 566-20-7-239 Composite	<p>15.0 5.5</p>	ASA-92-8-164 <p>5.87 9.00</p>	<p>9.80</p>	Conti 64459 910-12A488 910-12P488 FIRESTONE 9366 W013589366 NABI-HF 633-7773 NEWAY 905-57-160 905-57-210 905-57-225 TRIANGLE 8488 TRP AS93660 WATSON & CHALIN AS-0054
1R12-492 <u>Flexmember</u> 566-24-3-076 <u>Piston</u> 566-20-7-036 Aluminum	<p>16.9 5.5</p>	ASA-92-8-164 <p>5.50 9.00</p>	<p>7.87 10.10</p>	Conti 64486 910-14A545 FIRESTONE W013588806
1R12-494 <u>Flexmember</u> 566-24-3-038 <u>Piston</u> 566-20-7-036 Aluminum	<p>19.2 5.5 0.16</p>	ASA-92-8-331 <p>5.5 9.00</p>	<p>7.87 10.1</p>	Conti 64762 910-17-5A802 910-175A802
1R12-498 <u>Flexmember</u> 566-24-3-097 <u>Piston</u> 566-20-7-237 Composite	<p>25.0 9.2</p>	ASA-92-8-164 <p>5.50 9.00</p>	<p>9.80</p>	Conti 64399 910-17-5P428 910-175P428 FIRESTONE 9922 W013589922 NEWAY 905-57-119 TRIANGLE 8428 TRP AS99220

- - Bolt or Stud 1/2-13 or 1/2-20
- ⊗ - Air Fitting - 1/4 NPTF
- ⊙ - Stud - 3/4-10
- ⊕ - Tapped Hole on Top Retainers 3/8-16, on Pistons - 1/2-13
- ⊗ - Air Fitting - 1/2 NPTF or 3/8 NPTF
- ⊗ - Combination Stud Air Fitting Stud - 3/4-16; Air Fitting - 1/4 NPTF

AIR SPRING ROLLING LOBES

Part No.	Side View With Extended And Compressed Height	Upper Mounting View	Lower Mounting View	Manufacturer Numbers
1R12-499 <u>Flexmember</u> 566-24-3-038 <u>Piston</u> 566-20-7-238 Composite		ASA-92-8-331 		Conti 64405 910-17-5P454 910-175P454 <u>FIRESTONE</u> 9936 W013589936 <u>NEWAY</u> 905-57-156 <u>TRIANGLE</u> 8454 TRP AS99360
1R12-502 <u>Flexmember</u> 566-24-3-038 <u>Piston</u> 566-20-7-235 Composite		ASA-92-8-164 		Conti 64402 910-17-5P443 910-175P443 <u>FIRESTONE</u> 9921 W013589921 <u>NEWAY</u> 905-57-117 <u>TRIANGLE</u> 8443 TRP AS99210 <u>WATSON & CHALIN</u> AS-0090
1R12-504 <u>Flexmember</u> 566-24-3-066 <u>Piston</u> 566-20-7-237 Composite		ASA-92-8-269 		Conti 64409 910-17-5P502 910-175P502 <u>FIRESTONE</u> 9471 W013589471
1R12-505 <u>Flexmember</u> 566-24-3-076 <u>Piston</u> 566-20-7-235 Composite		ASA-92-8-164 		Conti 64451 910-12P395 <u>FIRESTONE</u> 9325 W013589325 <u>GILLIG</u> 87-17289 <u>NABI-HF</u> 630-5056 <u>NEWAY</u> 905-57-149 <u>TRIANGLE</u> 8395 TRP AS93250
1R12-507 <u>Flexmember</u> 566-24-3-090 <u>Piston</u> 566-20-7-236 Composite		ASA-92-8-355 	M12 X 1.75-6g 	

- - Bolt or Stud - 1/2-13 or 1/2-20
- ⊗ - Air Fitting - 1/4 NPTF
- ⊙ - Stud - 3/4-10
- ⊕ - Tapped Hole on Top Retainers - 3/8-16, on Pistons - 1/2-13
- ⊗ - Air Fitting - 1/2 NPTF or 3/8 NPTF
- ⊙⊗ - Combination Stud Air Fitting - Stud - 3/4-16; Air Fitting - 1/4 NPTF

AIR SPRING ROLLING LOBES

Part No.	Side View With Extended And Compressed Height	Upper Mounting View	Lower Mounting View	Manufacturer Numbers	
1R12-508 <u>Flexmember</u> 566-24-3-067 <u>Piston</u> 566-20-7-251 Composite	<p>14.1 4.5</p>	ASA-92-8-164 <p>5.50 9.00</p>	<p>9.30</p>	Conti 64439 64443 64456 910-10P471 910-10P482 910-12P484 <u>FIRESTONE</u> 8204 W013588204 W013589307 W013589334 <u>NEWAY</u> 905-57-173	905-57-223 <u>TRIANGLE</u> 8484
1R12-509 <u>Flexmember</u> 566-24-3-038 <u>Piston</u> 566-20-7-005 Aluminum	<p>21.1 7.6</p>	ASA-92-8-164 <p>5.50 9.00</p>	<p>7.87 10.13</p>	Conti 64269 910-16P310 <u>DAYTON</u> 352-9082 <u>FAB TEK</u> 101828 <u>FIRESTONE</u> 9082 W013589082 <u>GRANNING</u> 2727 HDA PMABG-9082B <u>HENDRICKSON</u> 36514-7 B-2066 <u>HUTCHENS</u> <u>IND.</u> 9630-01 <u>INT'L / NAVISTAR</u> 517559C9 <u>KWIK-LOK / TODCO</u> CP-3281 CP-5125 CP-5152	<u>LOAD GUARD</u> SC2035 <u>NEWAY</u> 905-57-006 905-57-027 905-57-037 905-57-054 905-57-075 <u>R & S TRUCK & BODY</u> 1090217 <u>REYCO</u> 12882-01 <u>RIDEWELL</u> 1003589082C S-542-C <u>SUSPENSIONS INC.</u> 201869 <u>TAURUS</u> AS506-9082 <u>TOYO</u> TRL-240/393 <u>TRIANGLE</u> 8310
1R12-511 <u>Flexmember</u> 566-24-3-048 <u>Piston</u> 566-20-7-240 Composite	<p>17.1 6.2</p>	UPPER BEAD PLATE NOT INCLUDED. SHOWN FOR REFERENCE ONLY.	<p>4.12 9.27</p>	<u>GMC</u> 15504181 G1015009 G1020956 <u>NOVABUS</u> G1015009 G1202944	
1R12-512 <u>Flexmember</u> 566-24-3-076 <u>Piston</u> 566-20-7-156 Composite	<p>16.9 6.0</p>	ASA-92-8-005 <p>6.20 9.00</p>	<p>7.87 9.80</p>	Conti 64633 910-14A707 <u>FIRESTONE</u> 9127 W013589127 <u>NEW FLYER</u> 9594	

- - Bolt or Stud 1/2-13 or 1/2-20
- ⊗ - Air Fitting - 1/4 NPTF
- ⊙ - Stud - 3/4-10
- ⊕ - Tapped Hole on Top Retainers 3/8-16, on Pistons - 1/2-13
- ⊗ - Air Fitting - 1/2 NPTF or 3/8 NPTF
- ⊙ - Combination Stud Air Fitting Stud - 3/4-16; Air Fitting - 1/4 NPTF

AIR SPRING ROLLING LOBES

Part No.	Side View With Extended And Compressed Height	Upper Mounting View	Lower Mounting View	Manufacturer Numbers
1R12-523 <u>Flexmember</u> 566-24-3-165 <u>Piston</u> 566-20-7-236 Composite		ASA-92-8-355 	M12x1.75-6g 	<u>INT'L/</u> <u>NAVISTAR</u> 3541732C1
1R12-527 <u>Flexmember</u> 566-24-3-066 <u>Piston</u> 566-20-7-006 Aluminum		ASA-92-8-002 		
1R12-530 <u>Flexmember</u> 566-24-3-061 <u>Piston</u> 566-20-7-251 Composite		ASA-92-8-164 		<u>FIRESTONE</u> 9306 W013589306
1R12-531 <u>Flexmember</u> 566-24-3-061 <u>Piston</u> 566-20-7-251 Composite		ASA-92-8-164 		
1R12-532 <u>Flexmember</u> 566-24-3-097 <u>Piston</u> 566-20-7-235 Composite		ASA-92-8-331 		<u>Conti</u> 64412 910-17-5P548 910-175P548 <u>FIRESTONE</u> 9935 W013589935 <u>NEWAY</u> 905-57-157 <u>TRIANGLE</u> 8548 <u>TRP</u> AS99350

- - Bolt or Stud 1/2-13 or 1/2-20
- ⊗ - Air Fitting - 1/4 NPTF
- ⊙ - Stud - 3/4-10
- ◐ - Tapped Hole on Top Retainers 3/8-16, on Pistons - 1/2-13
- ⊗ - Air Fitting - 1/2 NPTF or 3/8 NPTF
- ⊗ - Combination Stud Air Fitting Stud - 3/4-16; Air Fitting - 1/4 NPTF

AIR SPRING ROLLING LOBES

Part No.	Side View With Extended And Compressed Height	Upper Mounting View	Lower Mounting View	Manufacturer Numbers
1R12-534 <u>Flexmember</u> 566-24-3-116 <u>Piston</u> 566-20-7-158 Composite	<p>23.0 7.9</p>	ASA-92-8-360 <p>6.20 9.00</p>	<p>7.87 9.80</p>	Conti 64708 910-19P762
1R12-535 <u>Flexmember</u> 566-24-3-038 <u>Piston</u> 566-20-7-236 Composite	<p>20.0 6.7</p>	ASA-92-8-344 <p>5.87 9.00</p>	M12 X 1.75-6g <p>10.00</p>	
1R12-538 <u>Flexmember</u> 566-24-3-163 <u>Piston</u> 566-20-7-236 Composite	<p>6.53 3.64 2.87 20.0 6.7</p>	ASA-92-8-165 <p>5.70 9.00</p>	M12 x 1.75-6G <p>10.00</p>	Conti 64263 910-175P456 910-18-5P456 910-185P456 FIRESTONE 9648 W013589648 FLEETRITE 1R12-1057 INT'L/ NAVISTAR 2027911C1 2027911C2 2027911C3 TRIANGLE 8456 TRP AS96480
1R12-539 <u>Flexmember</u> 566-24-3-061 <u>Piston</u> 566-20-7-251 Composite	<p>12.7 4.6</p>	ASA-92-8-164 <p>5.50 9.00</p>	<p>9.20</p>	
1R12-540 <u>Flexmember</u> 566-24-3-116 <u>Piston</u> 566-20-7-209 Composite	<p>22.5 6.5</p>	ASA-92-8-360 <p>6.20 9.00</p>	<p>7.87 9.80</p>	WATSON & CHALIN AS-0114G

- - Bolt or Stud 1/2-13 or 1/2-20
- ⊗ - Air Fitting - 1/4 NPTF
- ⊙ - Stud - 3/4-10
- ⊕ - Tapped Hole on Top Retainers 3/8-16, on Pistons - 1/2-13
- ⊗ - Air Fitting - 1/2 NPTF or 3/8 NPTF
- ⊗ - Combination Stud Air Fitting Stud - 3/4-16; Air Fitting - 1/4 NPTF

AIR SPRING ROLLING LOBES

Part No.	Side View With Extended And Compressed Height	Upper Mounting View	Lower Mounting View	Manufacturer Numbers
1R12-541 <u>Flexmember</u> 566-24-3-038 <u>Piston</u> 566-20-7-209 Composite		ASA-92-8-360 		Conti 64650 910-16P769 <u>WATSON & CHALIN</u> AS-0113G
1R12-543 <u>Flexmember</u> 566-24-3-076 <u>Piston</u> 566-20-7-212 Composite		ASA-92-8-269 		Conti 65361 910-14AT75 910-14P575 <u>NEWAY</u> 905-57-275
1R12-545 <u>Flexmember</u> 566-24-3-038 <u>Piston</u> 566-20-7-240 Composite		ASA-92-8-309 		<u>MCI</u> 12-04-6007
1R12-552 <u>Flexmember</u> 566-24-3-038 <u>Piston</u> 566-20-7-215 Composite		ASA-92-8-269 		Conti 64416 910-17-5P572 910-175P572 <u>FIRESTONE</u> 9471 9501 W013589471 <u>NEWAY</u> 905-57-212 <u>TRP</u> AS95010
1R12-553 <u>Flexmember</u> 566-24-3-038 <u>Piston</u> 566-20-7-213 Composite		ASA-92-8-269 		Conti 64417 910-17-5P573 910-175P573 <u>FIRESTONE</u> 9472 9491 W013589472 W013589491 <u>NEWAY</u> 905-57-213 <u>TRIANGLE</u> 8467

- - Bolt or Stud 1/2-13 or 1/2-20
- ⊗ - Air Fitting - 1/4 NPTF
- ⊙ - Stud - 3/4-10
- ⊗ (with horizontal line) - Tapped Hole on Top Retainers 3/8-16, on Pistons - 1/2-13
- ⊗ (with vertical line) - Air Fitting - 1/2 NPTF or 3/8 NPTF
- ⊗ (with diagonal line) - Combination Stud Air Fitting Stud - 3/4-16; Air Fitting - 1/4 NPTF

AIR SPRING ROLLING LOBES

Part No.	Side View With Extended And Compressed Height	Upper Mounting View	Lower Mounting View	Manufacturer Numbers
1R12-554 <u>Flexmember</u> 566-24-3-038 <u>Piston</u> 566-20-7-214 Composite		ASA-92-8-269 		Conti 64415 910-17-5P571 910-175P571 <u>FIRESTONE</u> W013589470 <u>NEWAY</u> 905-57-211 <u>TRIANGLE</u> 8501
1R12-555 <u>Flexmember</u> 566-24-3-067 <u>Piston</u> 566-20-7-253 Composite		ASA-92-8-017 		Conti 64658 910-10P542 <u>FIRESTONE</u> 8961 W013588961 <u>REYCO</u> 23377-01 <u>TRIANGLE</u> 8542
1R12-556 <u>Flexmember</u> 566-24-3-067 <u>Piston</u> 566-20-7-252 Composite		ASA-92-8-017 		Conti 64441 910-10P480 <u>FIRESTONE</u> 8964 W013588964 <u>REYCO</u> 21598-01 <u>TRIANGLE</u> 8480
1R12-557 <u>Flexmember</u> 566-24-3-067 <u>Piston</u> 566-20-7-252 Composite		ASA-92-8-017 		Conti 64444 910-10P503 <u>FIRESTONE</u> 8976 W013588976 <u>REYCO</u> 21055-01 <u>TRIANGLE</u> 8503
1R12-558 <u>Flexmember</u> 566-24-3-067 <u>Piston</u> 566-20-7-252 Composite		ASA-92-8-164 		Conti 64438 910-10P400 <u>FIRESTONE</u> 8986 W013588986 <u>RIDEWELL</u> 1003588986C <u>TRIANGLE</u> 8400

- - Bolt or Stud 1/2-13 or 1/2-20
- ⊗ - Air Fitting - 1/4 NPTF
- ⊙ - Stud - 3/4-10
- ⊕ - Tapped Hole on Top Retainers 3/8-16, on Pistons - 1/2-13
- ⊗ - Air Fitting - 1/2 NPTF or 3/8 NPTF
- ⊙ - Combination Stud Air Fitting Stud - 3/4-16; Air Fitting - 1/4 NPTF

AIR SPRING ROLLING LOBES

Part No.	Side View With Extended And Compressed Height	Upper Mounting View	Lower Mounting View	Manufacturer Numbers
1R12-559 <u>Flexmember</u> 566-24-3-067 <u>Piston</u> 566-20-7-252 Composite		ASA-92-8-164 		Conti 64437 910-10P399 FIRESTONE 9029 W013589029 RIDEWELL 1003589029C TRIANGLE 8399
1R12-560 <u>Flexmember</u> 566-24-3-067 <u>Piston</u> 566-20-7-253 Composite		ASA-92-8-164 		Conti 64436 910-10P398 FIRESTONE 9308 W013589308 NEWAY 905-57-089 REYCO 17360-01 TRIANGLE 8398 TRP AS93080
1R12-561 <u>Flexmember</u> 566-24-3-067 <u>Piston</u> 566-20-7-253 Composite		ASA-92-8-164 		Conti 64435 910-10P397 FIRESTONE 9332 W013589332 REYCO 20074-01 TRIANGLE 8397 TRP AS93320
1R12-562 <u>Flexmember</u> 566-24-3-067 <u>Piston</u> 566-20-7-251 Composite		ASA-92-8-331 		Conti 68009 910-12P024 FIRESTONE 8197 W013588197 NEWAY 905-57-230
1R12-563 <u>Flexmember</u> 566-24-3-067 <u>Piston</u> 566-20-7-252 Composite		ASA-92-8-192 		Conti 64463 910-12P544 FIRESTONE 8934 W013588934 HENDRICKSON S-20228 TRIANGLE 8544

- - Bolt or Stud 1/2-13 or 1/2-20
- ⊗ - Air Fitting - 1/4 NPTF
- ⊙ - Stud - 3/4-10
- ⊕ - Tapped Hole on Top Retainers 3/8-16, on Pistons - 1/2-13
- ⊗ - Air Fitting - 1/2 NPTF or 3/8 NPTF
- ⊙ - Combination Stud Air Fitting Stud - 3/4-16; Air Fitting - 1/4 NPTF

AIR SPRING ROLLING LOBES

Part No.	Side View With Extended And Compressed Height	Upper Mounting View	Lower Mounting View	Manufacturer Numbers
1R12-567 <u>Flexmember</u> 566-24-3-038 <u>Piston</u> 566-20-7-235 Composite	<p>21.0 6.7</p>	ASA-92-8-041 <p>2.88 6.20 9.00</p>	<p>9.80</p>	Conti 64306 910-16P393 FIRESTONE 9026 W013589026 PETERBILT 03-06213 03-07111 TRIANGLE 8393
1R12-568 <u>Flexmember</u> 566-24-3-066 <u>Piston</u> 566-20-7-235 Composite	<p>24.7 6.7</p>	ASA-92-8-041 <p>2.88 6.20 9.00</p>	<p>9.80</p>	Conti 64339 910-19P472 FIRESTONE 8852 W013588852 FLEETRITE 1R12-1058 PETERBILT 03-07887 TRIANGLE 8472
1R12-571 <u>Flexmember</u> 566-24-3-067 <u>Piston</u> 566-20-7-238 Composite	<p>16.0 6.5</p>	ASA-92-8-164 <p>5.50 9.00</p>	<p>9.80</p>	Conti 64460 910-12P495 FIRESTONE 9365 W013589365 NEWAY 905-57-159 TRIANGLE 8495 TRP AS93650
1R12-576 <u>Flexmember</u> 566-24-3-038 <u>Piston</u> 566-20-7-159 Composite	<p>22.8 9.5</p>	ASA-92-8-005 <p>6.20 9.00</p>	<p>7.87 9.80</p>	Conti 64651 910-16P770
1R12-580 <u>Flexmember</u> 566-24-3-117 <u>Piston</u> 566-20-7-299 Composite	<p>28.2 9.5</p>	ASA-92-8-367 <p>6.20 10.30</p>	<p>10.6</p>	Conti 64383 910-21P448 FIRESTONE 9370 W013589370 TRP AS93700 WATSON & CHALIN AS-0057

- - Bolt or Stud 1/2-13 or 1/2-20
- ⊗ - Air Fitting - 1/4 NPTF
- ⊙ - Stud - 3/4-10
- ⊕ - Tapped Hole on Top Retainers 3/8-16, on Pistons - 1/2-13
- ⊗ - Air Fitting - 1/2 NPTF or 3/8 NPTF
- ⊗ - Combination Stud Air Fitting Stud - 3/4-16; Air Fitting - 1/4 NPTF

AIR SPRING ROLLING LOBES

Part No.	Side View With Extended And Compressed Height	Upper Mounting View	Lower Mounting View	Manufacturer Numbers
1R12-584 <u>Flexmember</u> 566-24-3-038 <u>Piston</u> 566-20-7-158 Composite	<p>20.8 7.0</p>	ASA-92-8-331 <p>5.50 9.00</p>	<p>7.87 9.80</p>	<u>RIDEWELL</u> 1001R12584G
1R12-586 <u>Flexmember</u> 566-24-3-038 <u>Piston</u> 566-20-7-237 Composite	<p>22.7 10.6</p>	ASA-92-8-269 <p>5.87 8.00</p>	<p>9.80</p>	<u>Conti</u> 64403 910-17-5P445 910-175P445 <u>FIRESTONE</u> 9473 W013589473 <u>NEWAY</u> 905-57-152 905-57-179 <u>TRP</u> AS94730
1R12-592 <u>Flexmember</u> 566-24-3-097 <u>Piston</u> 566-20-7-158 Composite	<p>23.2 7.9</p>	ASA-92-8-355 <p>5.87 9.00</p>	<p>7.87 8.0</p>	
1R12-593 <u>Flexmember</u> 566-24-3-100 <u>Piston</u> 566-20-7-036 Aluminum	<p>17.8 5.5</p>	ASA-92-8-164 <p>5.50 9.00</p>	<p>7.87 10.10</p>	
1R12-599 <u>Flexmember</u> 566-24-3-090 <u>Piston</u> 566-20-7-159 Composite	<p>29.1 9.0</p>	ASA-92-8-331 <p>5.50 9.00</p>	<p>7.87 9.80</p>	

- - Bolt or Stud 1/2-13 or 1/2-20
- ⊗ - Air Fitting - 1/4 NPTF
- ⊙ - Stud - 3/4-10
- ⊗ - Tapped Hole on Top Retainers 3/8-16, on Pistons - 1/2-13
- ⊗ - Air Fitting - 1/2 NPTF or 3/8 NPTF
- ⊗ - Combination Stud Air Fitting Stud - 3/4-16; Air Fitting - 1/4 NPTF

AIR SPRING ROLLING LOBES

Part No.	Side View With Extended And Compressed Height	Upper Mounting View	Lower Mounting View	Manufacturer Numbers
1R12-600 <u>Flexmember</u> 566-24-3-076 <u>Piston</u> 566-20-7-156 Composite		ASA-92-8-331 		
1R12-603 <u>Flexmember</u> 566-24-3-108 <u>Piston</u> 566-20-7-322 Aluminum		ASA-92-8-440 		<u>Conti</u> 64266 68207 910-16A382 910-16A999 910S-16A382 <u>FIRESTONE</u> 9781 W013589781 <u>FLEETRITE</u> 1R12-1064 <u>FREIGHTLINER</u> 16-19465-000 6813200017 A16-14004-000 A16-14004-001 <u>TRIANGLE</u> 8382
1R12-607 <u>Flexmember</u> 566-24-3-066 <u>Piston</u> 566-20-7-158 Composite		ASA-92-8-331 		
1R12-609 <u>Flexmember</u> 566-24-3-090 <u>Piston</u> 566-20-7-159 Composite		ASA-92-8-192 		<u>Conti</u> 65649 910-21P817
1R12-613 <u>Flexmember</u> 566-24-3-066 <u>Piston</u> 566-20-7-158 Composite		ASA-92-8-192 		<u>Conti</u> 64761 910-19A552

- - Bolt or Stud 1/2-13 or 1/2-20
- ⊗ - Air Fitting - 1/4 NPTF
- ⊙ - Stud - 3/4-10
- ⊕ - Tapped Hole on Top Retainers 3/8-16, on Pistons - 1/2-13
- ⊗ - Air Fitting - 1/2 NPTF or 3/8 NPTF
- ⊗ - Combination Stud Air Fitting Stud - 3/4-16; Air Fitting - 1/4 NPTF

AIR SPRING ROLLING LOBES

Part No.	Side View With Extended And Compressed Height	Upper Mounting View	Lower Mounting View	Manufacturer Numbers
1R12-614 <u>Flexmember</u> 566-24-3-076 <u>Piston</u> 566-20-7-156 Composite		ASA-92-8-164 		
1R12-615 <u>Flexmember</u> 566-24-3-164 <u>Piston</u> 566-20-7-303 Composite		ASA-92-8-306 	M12x1.75-6g 	Conti 20413888 64312 20505399 910-16P449 3934699 FIRESTONE 8079902 8829 8084296 W013588829 8097092 FLEETRITE 1R12-1059 MACK TRUCK 57QL54M TRIANGLE 8449 VOLVO 20396293
1R12-616 <u>Flexmember</u> 566-24-3-076 <u>Piston</u> 566-20-7-251 Composite		ASA-92-8-164 		
1R12-617 <u>Flexmember</u> 566-24-3-038 <u>Piston</u> 566-20-7-036 Aluminum		ASA-92-8-164 		
1R12-620 <u>Flexmember</u> 566-24-3-076 <u>Piston</u> 566-20-7-239 Composite		ASA-92-8-430 		Conti 64475 910-14P465 FIRESTONE 9335 W013589335 HENDRICKSON 56917-1 56917-2 65086-2 TRIANGLE 8465 TRP AS93350

- - Bolt or Stud 1/2-13 or 1/2-20
- ⊗ - Air Fitting - 1/4 NPTF
- ⊙ - Stud - 3/4-10
- ⊗ (with dot) - Tapped Hole on Top Retainers 3/8-16, on Pistons - 1/2-13
- ⊗ (with cross) - Air Fitting - 1/2 NPTF or 3/8 NPTF
- ⊗ (with circle) - Combination Stud Air Fitting Stud - 3/4-16; Air Fitting - 1/4 NPTF

AIR SPRING ROLLING LOBES

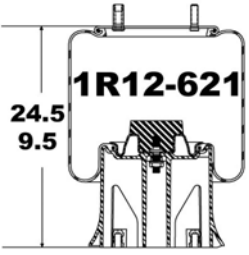
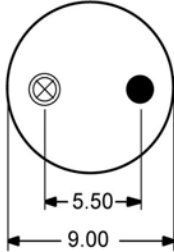
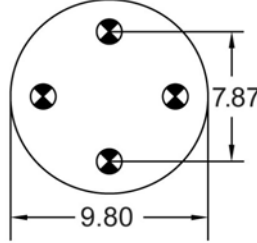
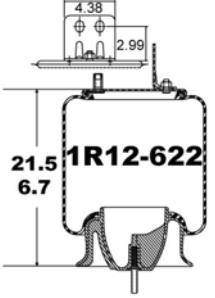
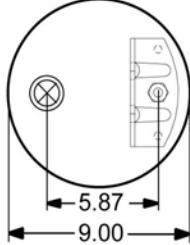
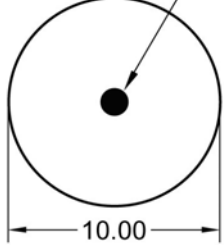
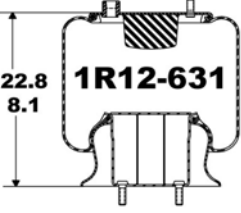
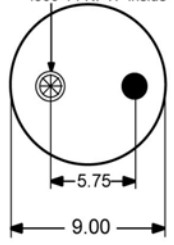
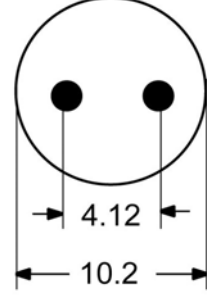
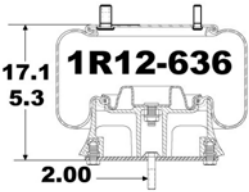
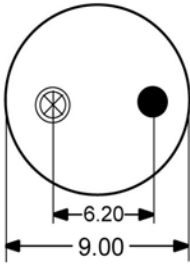
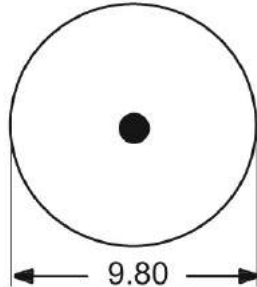
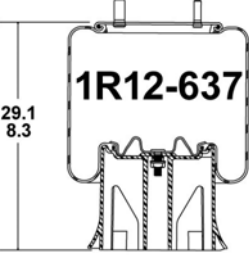
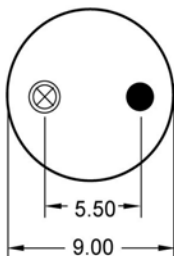
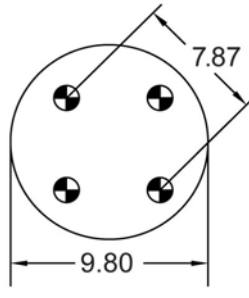
Part No.	Side View With Extended And Compressed Height	Upper Mounting View	Lower Mounting View	Manufacturer Numbers
1R12-621 <u>Flexmember</u> 566-24-3-097 <u>Piston</u> 566-20-7-159 Composite		ASA-92-8-164 		Conti 64293 910-16P332 FIRESTONE 9093 W013589093 NEWAY 905-57-007 905-57-032 905-57-035 TRIANGLE 8332
1R12-622 <u>Flexmember</u> 566-24-3-097 <u>Piston</u> 566-20-7-236 Composite		ASA-92-8-355 	M12 X 1.75-6g 	INTL/ NAVISTAR 3596112C1
1R12-631 <u>Flexmember</u> 566-24-3-120 <u>Piston</u> 566-20-7-079 Steel		ASA-92-8-439 1.250-12 UNF outside 500-14 NPTF inside 		PREVOST 360258 63-0125
1R12-636 <u>Flexmember</u> 566-24-3-076 <u>Piston</u> 566-20-7-156 Composite		ASA-92-8-440 		Conti 65361 910-14A575 FIRESTONE 9634 W013589634 TRP AS96340
1R12-637 <u>Flexmember</u> 566-24-3-090 <u>Piston</u> 566-20-7-159 Composite		ASA-92-8-164 		Conti 64385 910-21P511 FIRESTONE W013589338



- - Bolt or Stud 1/2-13 or 1/2-20
- ⊗ - Air Fitting - 1/4 NPTF
- ⊙ - Stud - 3/4-10
- ⊕ - Tapped Hole on Top Retainers 3/8-16, on Pistons - 1/2-13
- ⊗ - Air Fitting - 1/2 NPTF or 3/8 NPTF
- ⊗ - Combination Stud Air Fitting Stud - 3/4-16; Air Fitting - 1/4 NPTF

AIR SPRING ROLLING LOBES

Part No.	Side View With Extended And Compressed Height	Upper Mounting View	Lower Mounting View	Manufacturer Numbers
1R12-639 <u>Flexmember</u> 566-24-3-066 <u>Piston</u> 566-20-7-159 Composite	<p>26.2 9.5</p>	ASA-92-8-164 <p>5.50 9.00</p>	<p>7.87 9.80</p>	Conti 64326 910-19P357 FIRESTONE W013589240
1R12-640 <u>Flexmember</u> 566-24-3-038 <u>Piston</u> 566-20-7-238 Composite	<p>18.8 6.7</p>	ASA-92-8-257 <p>1.50 4.75 9.00</p>	<p>9.80</p>	Conti 64398 910-17-5P426 FIRESTONE W013589902
1R12-644 <u>Flexmember</u> 566-24-3-097 <u>Piston</u> 566-20-7-158 Composite	<p>23.2 7.0</p>	AS1-92-8-192 <p>3.05 9.00</p>	<p>7.87 9.80</p>	Conti 64340 910-19P552 FIRESTONE W013588855
1R12-645 <u>Flexmember</u> 566-24-3-038 <u>Piston</u> 566-20-7-080 Composite	<p>21.3 6.8</p>	ASA-92-8-164 <p>5.50 9.00</p>	<p>5/8-11 UNC 1/2-13 UNC 5.25 5.58 10.1</p>	FIRESTONE W013589210
1R12-647 <u>Flexmember</u> 566-24-3-097 <u>Piston</u> 566-20-7-303 Composite	<p>2.36 3.11 4.38 22.0 6.7</p>	ASA-92-8-306 <p>5.50 9.00</p>	M12x1.75-6g <p>10.00</p>	MACK TRUCK 20910892 57QL519M VOLVO 20733034

- - Bolt or Stud 1/2-13 or 1/2-20
- ⊗ - Air Fitting - 1/4 NPTF
- ⊙ - Stud - 3/4-10
- ⊖ - Tapped Hole on Top Retainers 3/8-16, on Pistons - 1/2-13
- ⊗ - Air Fitting - 1/2 NPTF or 3/8 NPTF
- ⊙ - Combination Stud Air Fitting Stud - 3/4-16; Air Fitting - 1/4 NPTF

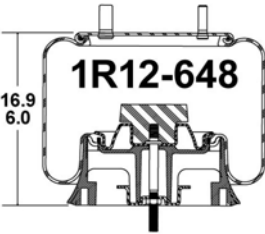
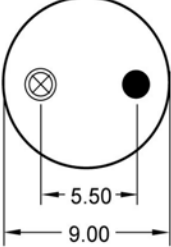
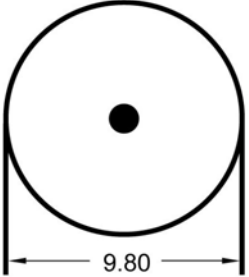
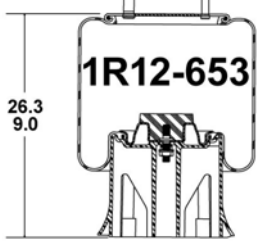
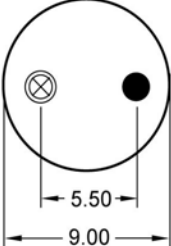
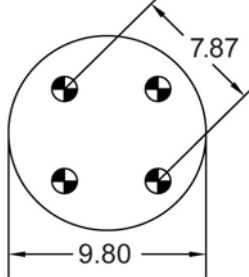
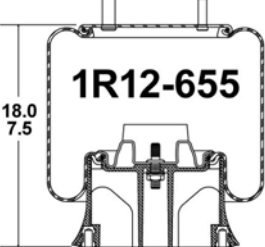
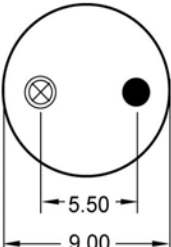
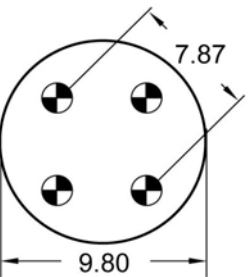
AIR SPRING ROLLING LOBES

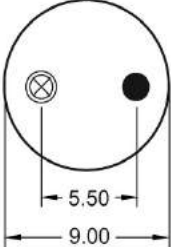
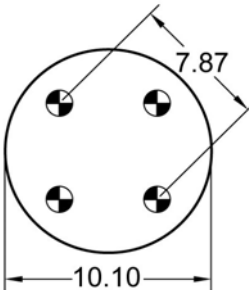
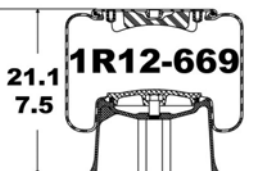
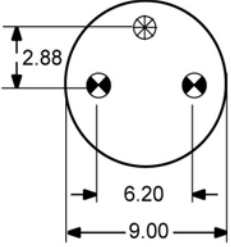
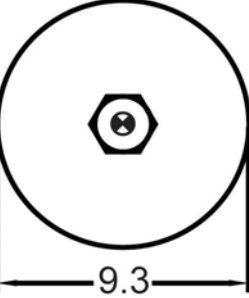
Part No.	Side View With Extended And Compressed Height	Upper Mounting View	Lower Mounting View	Manufacturer Numbers
1R12-648 <u>Flexmember</u> 566-24-3-076 <u>Piston</u> 566-20-7-239 Composite		ASA-92-8-164 		Conti 64479 910-14P490 <u>FIRESTONE</u> 9336 W013589336
1R12-653 <u>Flexmember</u> 566-24-3-066 <u>Piston</u> 566-20-7-159 Composite		ASA-92-8-004 		
1R12-655 <u>Flexmember</u> 566-24-3-076 <u>Piston</u> 566-20-7-158 Composite		ASA-92-8-164 		
1R12-663 <u>Flexmember</u> 566-24-3-090 <u>Piston</u> 566-20-7-006 Aluminum		ASA-92-8-164 		Conti 64382 910-21P360 <u>FIRESTONE</u> W013589320
1R12-669 <u>Flexmember</u> 566-24-3-038 <u>Piston</u> 566-20-7-053 Aluminum		ASA-92-8-021 		Conti 64274 910-14P312 <u>FIRESTONE</u> 9069 W013589069 INT'L/ <u>NAVISTAR</u> 554764C1 <u>LOAD GUARD</u> SC2034 <u>PETERBILT</u> 03-01649 03-02038 03-02456 03-04759 03-07112 23-10042 <u>TAURUS</u> AS504-9069 AS506-9069 <u>TRIANGLE</u> 8312 <u>WATSON & CHALIN</u> AS-0077

- - Bolt or Stud 1/2-13 or 1/2-20
- ⊗ - Air Fitting - 1/4 NPTF
- ⊙ - Stud - 3/4-10
- ⊕ - Tapped Hole on Top Retainers 3/8-16, on Pistons - 1/2-13
- ⊗ - Air Fitting - 1/2 NPTF or 3/8 NPTF
- ⊗ - Combination Stud Air Fitting Stud - 3/4-16; Air Fitting - 1/4 NPTF

AIR SPRING ROLLING LOBES

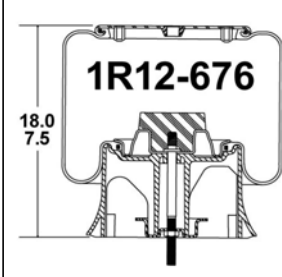
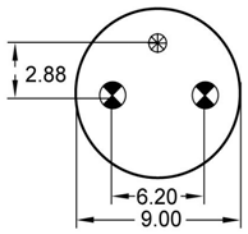
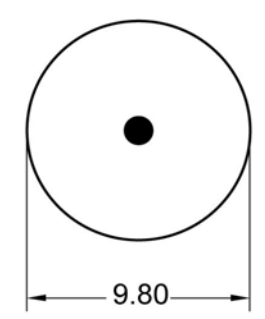
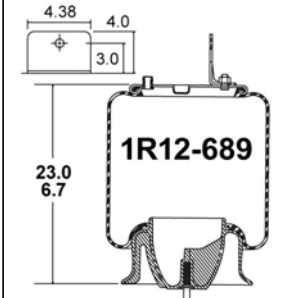
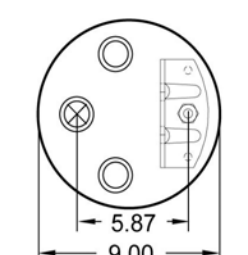
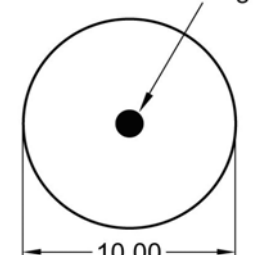
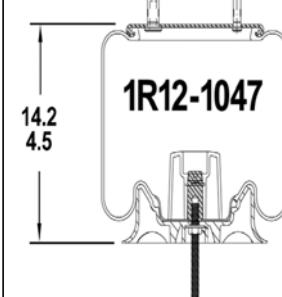
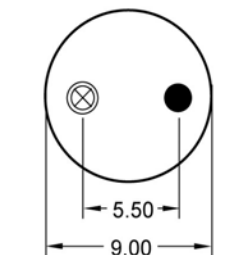
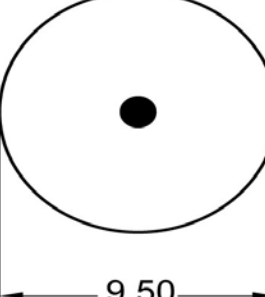
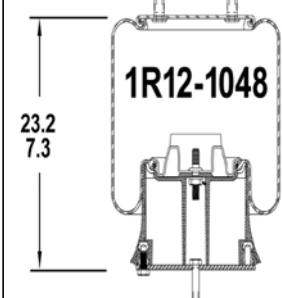
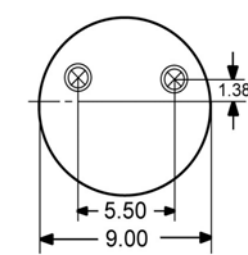
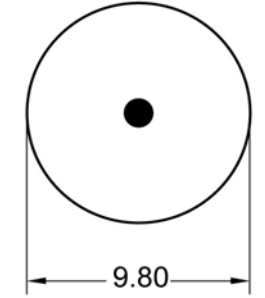
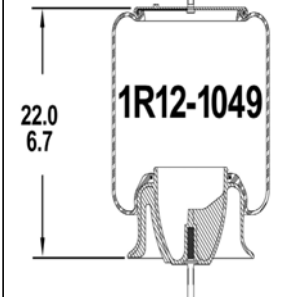
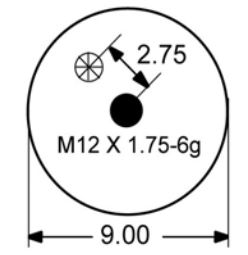
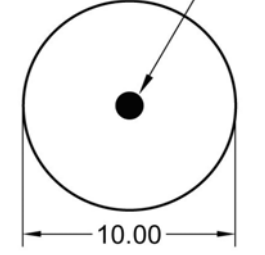
Part No.	Side View With Extended And Compressed Height	Upper Mounting View	Lower Mounting View	Manufacturer Numbers
1R12-676 <u>Flexmember</u> 566-24-3-076 <u>Piston</u> 566-20-7-235 Composite		ASA-92-8-041 		Conti 64274 910-14P312 FIRESTONE 9069 W013589069
1R12-689 <u>Flexmember</u> 566-24-3-066 <u>Piston</u> 566-20-7-236 Composite		ASA-92-8-344 	M12 X 1.75-6g 	
1R12-1047 <u>Flexmember</u> 566-24-3-142 <u>Piston</u> 566-20-7-413 Composite		ASA-92-8-547 		Conti 68151 910-13-5P874 FIRESTONE 9807 W013589807 NEW HOLLAND 48100494
1R12-1048 <u>Flexmember</u> 566-24-3-097 <u>Piston</u> 566-20-7-158 Composite		ASA-92-8-238 		Conti 67586 910-17-5A930 FIRESTONE 9974 W013589974
1R12-1049 <u>Flexmember</u> 566-24-3-097 <u>Piston</u> 566-20-7-236 Composite		ASC-92-8-471 	M12 X 1.75-6g 	MACK TRUCK 21244322 21669088 VOLVO 21132005 21669088

- - Bolt or Stud 1/2-13 or 1/2-20
- ⊗ - Air Fitting - 1/4 NPTF
- ⊙ - Stud - 3/4-10
- ⊖ - Tapped Hole on Top Retainers 3/8-16, on Pistons - 1/2-13
- ⊗ - Air Fitting - 1/2 NPTF or 3/8 NPTF
- ⊗ - Combination Stud Air Fitting Stud - 3/4-16; Air Fitting - 1/4 NPTF

AIR SPRING ROLLING LOBES

Part No.	Side View With Extended And Compressed Height	Upper Mounting View	Lower Mounting View	Manufacturer Numbers
1R13-038 <u>Flexmember</u> 566-26-3-072 <u>Piston</u> 566-20-7-097 Composite	<p>24.9 8.9</p>	ASA-92-8-245 		<u>Conti</u> 1110-5-21A313 11105-21A313 64273 <u>DAYTON</u> 352-9122 <u>FLEETRITE</u> 1R13-246 <u>HENDRICKSON</u> B-12514-008 B-3830 C-22173 S-3467 S-3830 INT'L/ <u>NAVISTAR</u> 554772C1 <u>LOAD GUARD</u> SC2041 <u>NEWAY</u> 905-57-020 905-57-071 905-57-076 905-57-077 905-57-185 AR-1215-1-G REYCO 12883-02 <u>RIDEWELL</u> 1003589122C S-3053-C <u>TAURUS</u> AS622-9122 <u>TOYO</u> TRL-270/476 <u>WATSON &</u> <u>CHALIN</u> AS-0023
1R13-039 <u>Flexmember</u> 566-26-3-051 <u>Piston</u> 566-20-7-327 Composite	<p>19.5 7.7</p>	ASA-92-8-245 		<u>Conti</u> 1010-16-5S783 1010-165S783 64746 <u>DAYTON</u> 352-9121 <u>FIRESTONE</u> 9121 W013589121 <u>HDA</u> PMABG-9123B <u>HENDRICKSON</u> B-3411 INT'L/ <u>NAVISTAR</u> 554773C1 <u>LOAD GUARD</u> SC2040 <u>NEWAY</u> 905-57-019 905-57-052 905-57-078 905-57-083 AR-1115-1-G <u>R & S TRUCK &</u> <u>BODY</u> 1090023 <u>REYCO</u> 12882-02 <u>RIDEWELL</u> 1003589121C S-3052-C <u>SAUR AXLES</u> <u>(SAS)</u> P50-733B <u>TAURUS</u> AS621-9121 <u>TRIANGLE</u> 8317 <u>WATSON &</u> <u>CHALIN</u> AS-0013 AS-0083
1R13-047 <u>Flexmember</u> 566-26-3-051 <u>Piston</u> 566-20-7-096 Steel	<p>19.5 7.7</p>	ASA-92-8-245 		<u>Conti</u> 1110-5-17A377 64347 <u>FIRESTONE</u> W013589144 <u>NEWAY</u> 905-57-110 <u>TRIANGLE</u> 8377
1R13-048 <u>Flexmember</u> 566-26-3-072 <u>Piston</u> Not Included	<p>1R13-048 Service Assembly for 1R13-038</p>	ASA-92-8-245 	USE EXISTING SUPER CUSHION PISTON	INT'L/ <u>NAVISTAR</u> 554774C1 <u>LOAD GUARD</u> SC2056 <u>NEWAY</u> 900-44-658 900-44-668 <u>RIDEWELL</u> 1013589124C <u>TAURUS</u> AS622-9124

- - Bolt or Stud 1/2-13 or 1/2-20
- ⊗ - Air Fitting - 1/4 NPTF
- ⊗ - Stud - 3/4-10
- ⊕ - Tapped Hole on Top Retainers 3/8-16, on Pistons - 1/2-13
- ⊗ - Air Fitting - 1/2 NPTF or 3/8 NPTF
- ⊗ - Combination Stud Air Fitting Stud - 3/4-16; Air Fitting - 1/4 NPTF

AIR SPRING ROLLING LOBES

Part No.	Side View With Extended And Compressed Height	Upper Mounting View	Lower Mounting View	Manufacturer Numbers
1R13-049 <u>Flexmember</u> 566-26-3-051 <u>Piston</u> Not Included	<p style="text-align: center;">1R13-049 Service Assembly for 1R13-039</p>	ASA-92-8-245 	<p style="text-align: center;">USE EXISTING SUPER CUSHION PISTON</p>	<u>INT'L/</u> <u>NAVISTAR</u> 554775C1 <u>LOAD GUARD</u> SC2055 <u>NEWAY</u> 900-44-670 900-44-702 905-54-060 <u>RIDEWELL</u> 1013589123C <u>TAURUS</u> AS621-9123
1R13-053 <u>Flexmember</u> 566-26-3-051 <u>Piston</u> 566-20-7-036 Aluminum	<p style="text-align: center;">1R13-053</p>	ASA-20-8-245 		<u>FIRESTONE</u> 8754 W013588754 <u>NEW FLYER</u> 13
1R13-070 <u>Flexmember</u> 566-26-3-015 <u>Piston</u> 566-20-7-084 Aluminum OBSOLETE	<p style="text-align: center;">1R13-070</p>	ASD-20-8-053 	3/4-10 	<u>Conti</u> 910-19P444 <u>LOAD GUARD</u> SC2776 <u>MACK TRUCK</u> 57QL332 57QL39306 <u>NEWAY</u> 905-44-608 905-57-070 905-57-087 <u>TRIANGLE</u> 8444
1R13-075 <u>Flexmember</u> 566-26-3-051 <u>Piston</u> 566-20-7-036-03 Aluminum	<p style="text-align: center;">1R13-075</p>	ASA-92-8-245 		
1R13-097 <u>Flexmember</u> 566-26-3-081 <u>Piston</u> 566-20-7-296 Composite	<p style="text-align: center;">1R13-097</p>	ASA-92-8-245 		<u>Conti</u> 1010-15S518 1010-15S962 67600 <u>RIDEWELL</u> 1001R13-087 1001R13-097 1003588752C <u>TRIANGLE</u> 8518

- - Bolt or Stud 1/2-13 or 1/2-20
- ⊗ - Air Fitting - 1/4 NPTF
- ⊙ - Stud - 3/4-10
- ◐ - Tapped Hole on Top Retainers 3/8-16, on Pistons - 1/2-13
- ⊗ - Air Fitting - 1/2 NPTF or 3/8 NPTF
- ⊗ - Combination Stud Air Fitting Stud - 3/4-16; Air Fitting - 1/4 NPTF

AIR SPRING ROLLING LOBES

Part No.	Side View With Extended And Compressed Height	Upper Mounting View	Lower Mounting View	Manufacturer Numbers
1R13-109 <u>Flexmember</u> 566-26-3-081 <u>Piston</u> 566-20-7-296 Composite	<p>17.8 5.6</p>	ASA-92-8-243 <p>2.13 6.20 10.30</p>	<p>7.87 10.20</p>	Conti 1010-15S871 66340 <u>FIRESTONE</u> 8782 W013588782 <u>RIDEWELL</u> 1001R13-109
1R13-115 <u>Flexmember</u> 566-26-3-044 <u>Piston</u> 566-20-7-006 Aluminum	<p>27.0 9.4</p>	ASA-92-8-004 <p>5.50 9.00</p>	<p>7.87 10.13</p>	Conti 64375 910D-21A324 <u>FIRESTONE</u> 9250 W013589250 <u>RIDEWELL</u> 1003589250C <u>TRIANGLE</u> 8324 TRP AS92500 <u>WATSON &</u>
1R13-116 <u>Flexmember</u> 566-26-3-044 <u>Piston</u> 566-20-7-006 Aluminum	<p>27.0 8.9</p>	ASA-92-8-004 <p>5.50 9.00</p>	<p>7.87 10.13</p>	Conti 64376 910D-21A363 <u>FIRESTONE</u> 9252 W013589252 <u>RIDEWELL</u> 1003589252C <u>TRIANGLE</u> 8363 TRP AS92520
1R13-117 <u>Flexmember</u> 566-26-3-043 <u>Piston</u> 566-20-7-080 Composite	<p>23.2 7.7</p>	ASA-92-8-004 <p>5.50 9.00</p>	<p>7.87 10.10</p>	Conti 64371 910B-17-5A323 910B-175A323 <u>FIRESTONE</u> 9275 W013589275 <u>RIDEWELL</u> 1003589275C <u>TRIANGLE</u> 8323 TRP AS92750
1R13-118 <u>Flexmember</u> 566-26-3-068 <u>Piston</u> 566-20-7-325 Composite	<p>23.5 7.2</p>	ASA-92-8-240 <p>3.05 10.30</p>	<p>5.66 10.20</p>	Conti 1010-21P434 64394 <u>FIRESTONE</u> 9262 9580 W013589580 <u>FLEETRITE</u> 1R13-247 <u>HENDRICKSON</u> 29892 C-20127 C-20414

- - Bolt or Stud 1/2-13 or 1/2-20
- ⊗ - Air Fitting - 1/4 NPTF
- ⊙ - Stud - 3/4-10
- ⊕ - Tapped Hole on Top Retainers 3/8-16, on Pistons - 1/2-13
- ⊗ - Air Fitting - 1/2 NPTF or 3/8 NPTF
- ⊙ - Combination Stud Air Fitting Stud - 3/4-16; Air Fitting - 1/4 NPTF

AIR SPRING ROLLING LOBES

Part No.	Side View With Extended And Compressed Height	Upper Mounting View	Lower Mounting View	Manufacturer Numbers
1R13-119 <u>Flexmember</u> 566-26-3-098 <u>Piston</u> 566-20-7-106 Steel	<p>16.4 5.6</p>	ASA-92-8-235 <p>1.84 4.89 3.05 9.00</p>	<p>5.66 9.50</p>	Conti 64287 910-13-5S433 FIRESTONE W013589270 FLEETRITE 1R13-248 HENDRICKSON C-20010 S-20010 TRP AS92700
1R13-120 <u>Flexmember</u> 566-26-3-054 <u>Piston</u> 566-20-7-334 Aluminum	<p>18.0 5.7</p>	ASA-92-8-049 <p>5.50 11.30</p>	<p>7.87 11.70</p>	Conti 1110-5-15A422 11105-15A422 64428 FIRESTONE 9218 W013589218 NEWAY 905-57-209 RIDEWELL 1003589218C TRIANGLE 8422 WATSON & CHALIN AS-0073
1R13-124 <u>Flexmember</u> 566-26-3-050 <u>Piston</u> 566-20-7-127 Steel	<p>18.5 7.3</p>	ASA-92-8-230 <p>1.38 5.50 10.30</p>	<p>5.66 10.20</p>	Conti 1010-15S522 1010-15S711 64397 FIRESTONE 8710 8755 W013588710 W013588755 HENDRICKSON B-22046 C-21623 C-22045 C-22046 TRIANGLE 8522 TRP AS87550
1R13-130 <u>Flexmember</u> 566-26-3-055 <u>Piston</u> 566-20-7-230 Composite	<p>13.0 4.6</p>	ASA-92-8-245 <p>5.50 10.30</p>	<p>6.50 10.00</p>	Conti 1010-5AV-12P51 1010B-13S513 64420 FIRESTONE 8729 W013588729 MERITOR 202796 SUSPENSIONS INC. 202796 TRIANGLE 8513
1R13-133 <u>Flexmember</u> 566-26-3-056 <u>Piston</u> 566-20-7-231 Steel	<p>14.6 4.6</p>	ASA-92-8-307 M12x1.75-6G <p>.750-14 NPTF 6.75 10.30</p>	<p>M12 x 1.75-6g 5.00 8.10</p>	DINA 224-B020018 MCI 1510979

- - Bolt or Stud 1/2-13 or 1/2-20
- ⊗ - Air Fitting - 1/4 NPTF
- ⊙ - Stud - 3/4-10
- (with horizontal lines) - Tapped Hole on Top Retainers 3/8-16, on Pistons - 1/2-13
- ⊗ (with vertical lines) - Air Fitting - 1/2 NPTF or 3/8 NPTF
- ⊗ (with diagonal lines) - Combination Stud Air Fitting Stud - 3/4-16; Air Fitting - 1/4 NPTF

AIR SPRING ROLLING LOBES

Part No.	Side View With Extended And Compressed Height	Upper Mounting View	Lower Mounting View	Manufacturer Numbers
1R13-138 <u>Flexmember</u> 566-26-3-050 <u>Piston</u> 566-20-7-106 Steel	<p>16.9 5.6</p>	ASA-92-8-245 <p>5.50 10.30</p>	<p>5.66 9.50</p>	Conti 1010-15S518 64396 <u>FIRESTONE</u> 8752 W013588752
1R13-149 <u>Flexmember</u> 566-26-3-068 <u>Piston</u> 566-20-7-127 Steel	<p>25.0 7.3</p>	ASA-92-8-240 <p>3.05 10.30</p>	<p>5.66 10.20</p>	
1R13-151 <u>Flexmember</u> 566-26-3-069 <u>Piston</u> 566-20-7-334 Aluminum	<p>13.9 5.1</p>	ASA-92-8-326 <p>3.12 6.25 11.30</p>	<p>7.87 11.70</p>	
1R13-152 <u>Flexmember</u> 566-26-3-071 <u>Piston</u> 566-20-7-235 Composite	<p>21.4 7.5</p>	ASA-92-8-245 <p>5.50 10.30</p>	<p>9.80</p>	Conti 1010-21P570 64252 <u>FIRESTONE</u> 8748 W013588748 <u>NEWAY</u> 905-57-167 AR-250-14 AR-250-15
1R13-153 <u>Flexmember</u> 566-26-3-071 <u>Piston</u> 566-20-7-237 Composite	<p>23.5 9.0</p>	ASA-92-8-245 <p>5.50 10.30</p>	<p>9.80</p>	Conti 1010-21P486 64419 <u>FIRESTONE</u> 8749 W013588749 <u>NEWAY</u> 905-57-168 AR-250-12 AR-250-16 AR-250-17 <u>TRIANGLE</u> 8486

- - Bolt or Stud 1/2-13 or 1/2-20
- ⊗ - Air Fitting - 1/4 NPTF
- ⊙ - Stud - 3/4-10
- ⊕ - Tapped Hole on Top Retainers 3/8-16, on Pistons - 1/2-13
- ⊗ - Air Fitting - 1/2 NPTF or 3/8 NPTF
- ⊙ - Combination Stud Air Fitting Stud - 3/4-16; Air Fitting - 1/4 NPTF

AIR SPRING ROLLING LOBES

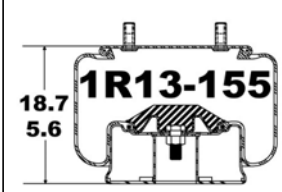
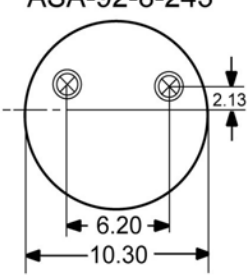
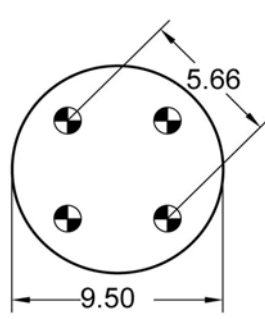
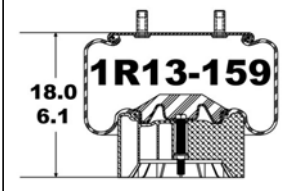
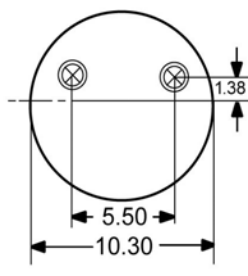
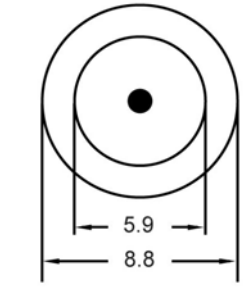
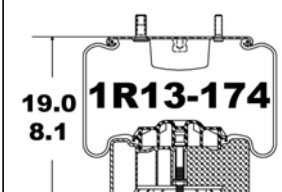
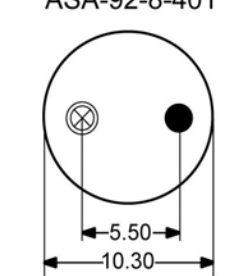
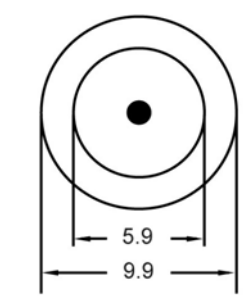
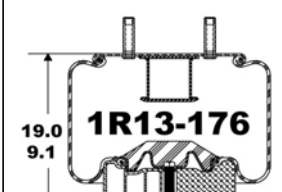
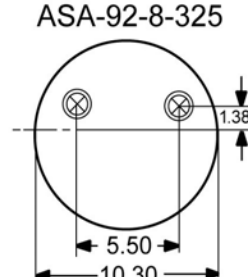
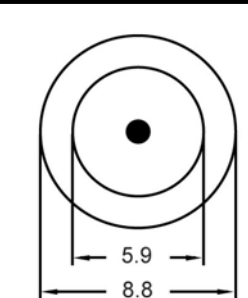
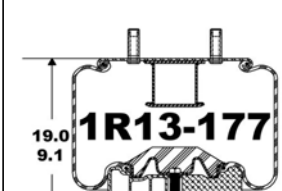
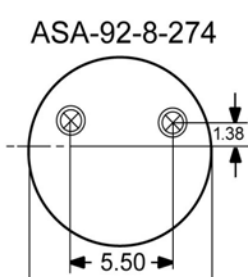
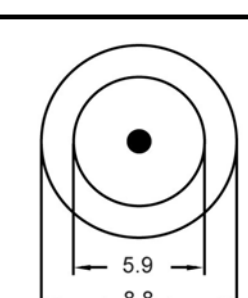
Part No.	Side View With Extended And Compressed Height	Upper Mounting View	Lower Mounting View	Manufacturer Numbers
1R13-155 <u>Flexmember</u> 566-26-3-051 <u>Piston</u> 566-20-7-106 Steel		ASA-92-8-243 		Conti 1010-16S724 64649 <u>WATSON & CHALIN</u> AS-0107G
1R13-159 <u>Flexmember</u> 566-26-3-073 <u>Piston</u> 566-20-7-154 Composite		ASA-92-8-230 		Conti 1010-15P453 1010-5-15P460 10105-15P460 64645 <u>FIRESTONE</u> 8709 8751 W013588709 W013588751 <u>FLEETRITR</u> 1R13-249 <u>HENDRICKSON</u> C-20900
1R13-174 <u>Flexmember</u> 566-26-3-078 <u>Piston</u> 566-20-7-152 Composite REPLACED BY 1R13-188		ASA-92-8-401 		<u>DANA / SPICER</u> SR1VA101
1R13-176 <u>Flexmember</u> 566-26-3-078 <u>Piston</u> 566-20-7-154 Composite		ASA-92-8-325 		Conti 1010-16S533 64636 <u>FIRESTONE</u> 8713 W013588713 <u>HENDRICKSON</u> C-22948 <u>TRIANGLE</u> 8533
1R13-177 <u>Flexmember</u> 566-26-3-078 <u>Piston</u> 566-20-7-154 Composite		ASA-92-8-274 		Conti 1010-16S526 64638 <u>FIRESTONE</u> 8708 W013588708 <u>FLEETRITR</u> 1R13-250 <u>HENDRICKSON</u> C-21966 <u>TRIANGLE</u> 8526

- - Bolt or Stud 1/2-13 or 1/2-20
- ⊗ - Air Fitting - 1/4 NPTF
- ⊙ - Stud - 3/4-10
- ⊗ (with dot) - Tapped Hole on Top Retainers 3/8-16, on Pistons - 1/2-13
- ⊗ (with cross) - Air Fitting - 1/2 NPTF or 3/8 NPTF
- ⊗ (with circle) - Combination Stud Air Fitting Stud - 3/4-16; Air Fitting - 1/4 NPTF

AIR SPRING ROLLING LOBES

Part No.	Side View With Extended And Compressed Height	Upper Mounting View	Lower Mounting View	Manufacturer Numbers
1R13-179 Flexmember 566-26-3-078 Piston 566-20-7-152 Composite		ASA-92-8-245 		
1R13-181 Flexmember 566-26-3-051 Piston 566-20-7-124 Steel		ASA-92-8-245 		
1R13-182 Flexmember 566-26-3-051 Piston 566-20-7-124 Steel		ASA-92-8-243 		
1R13-188 Flexmember 566-26-3-078 Piston 566-20-7-314 Composite		ASA-92-8-424 		DANA / SPICER SR1JA100 SR1VA101-1 SR1VA105 HENDRICKSON S-29892
1R13-189 Flexmember 566-26-3-078 Piston 566-20-7-152 Composite		ASA-92-8-230 		

- - Bolt or Stud 1/2-13 or 1/2-20
- ⊗ - Air Fitting - 1/4 NPTF
- ⊙ - Stud - 3/4-10
- ⊕ - Tapped Hole on Top Retainers 3/8-16, on Pistons - 1/2-13
- ⊗ - Air Fitting - 1/2 NPTF or 3/8 NPTF
- ⊗ - Combination Stud Air Fitting Stud - 3/4-16; Air Fitting - 1/4 NPTF

AIR SPRING ROLLING LOBES

Part No.	Side View With Extended And Compressed Height	Upper Mounting View	Lower Mounting View	Manufacturer Numbers
1R13-207 <u>Flexmember</u> 566-26-3-081 <u>Piston</u> 566-20-7-106 Steel	<p>17.8 5.6</p>	ASA-92-8-243 <p>2.13 6.20 10.30</p>	<p>5.66 9.50</p>	Conti 1010-15S713 64639 FIRESTONE W013588753 WATSON & CHALIN AS0098
1R13-208 <u>Flexmember</u> 566-26-3-071 <u>Piston</u> 566-20-7-235 Composite	<p>23.5 7.5</p>	ASA-92-8-249 <p>1.84 4.89 3.05 10.30</p>	<p>9.80</p>	Conti 1010-21P774 64728 FIRESTONE W013588746
1R13-210 <u>Flexmember</u> 566-26-3-081 <u>Piston</u> 566-20-7-106 Steel	<p>17.8 5.6</p>	ASA-92-8-240 <p>3.05 10.30</p>	<p>5.66 9.50</p>	Conti 1010-15S773 64725 FIRESTONE W013588740
1R13-216 <u>Flexmember</u> 566-26-3-072 <u>Piston</u> 566-20-7-097 Steel	<p>24.9 8.9</p>	ASA-92-8-245 <p>5.50 10.30</p>	<p>7.87 10.20</p>	
1R13-235 <u>Flexmember</u> 566-26-3-095 <u>Piston</u> 566-20-7-274 Steel	<p>30.1 9.6</p>	ASA-92-8-230 <p>1.38 5.50 10.30</p>	<p>8.78 10.30</p>	HENDRICKSON S-25872



- - Bolt or Stud 1/2-13 or 1/2-20
- ⊗ - Air Fitting - 1/4 NPTF
- ⊙ - Stud - 3/4-10
- ⊗ (with dot) - Tapped Hole on Top Retainers 3/8-16, on Pistons - 1/2-13
- ⊗ (with cross) - Air Fitting - 1/2 NPTF or 3/8 NPTF
- ⊗ (with circle) - Combination Stud Air Fitting Stud - 3/4-16; Air Fitting - 1/4 NPTF

AIR SPRING ROLLING LOBES

Part No.	Side View With Extended And Compressed Height	Upper Mounting View	Lower Mounting View	Manufacturer Numbers
1R13-237 <u>Flexmember</u> 566-26-3-097 <u>Piston</u> 566-20-7-277 Steel	<p>26.7 8.2</p>	ASA-92-8-230 		<u>HENDRICKSON</u> S-25871
1R13-239 <u>Flexmember</u> 566-26-3-098 <u>Piston</u> 566-20-7-106 Steel	<p>16.4 5.6</p>	ASA-92-8-249 		Conti 64287 910-13-5S433 910-135S433 910-135S881 <u>FIRESTONE</u> 9270 W013589270 <u>HENDRICKSON</u> 1R13-102 C-21208 S-25559 <u>TRIANGLE</u> 8433 <u>WATSON & CHALIN</u> AS-0084
1R14-018 <u>Flexmember</u> 566-28-3-021 <u>Piston</u> 566-20-7-096 Steel	<p>22.5 7.7</p>	ASA-92-8-028 		11105-17A365 Conti 1110-5-21A365 64344 <u>DAYTON</u> 352-9149 <u>FIRESTONE</u> 9149 W013589149 <u>GILLIG</u> 53-13188 <u>INT'L/ NAVISTAR</u> 554776C1 <u>LOAD GUARD</u> SC2043 <u>PEERLESS</u> 0550-00010 <u>TAURUS</u> AS621-9149 <u>TRIANGLE</u> 8365
1R14-019 <u>Flexmember</u> 566-28-3-020 <u>Piston</u> 566-20-7-097 Composite	<p>25.8 8.9</p>	ASA-92-8-028 		11105-21A369 Conti 1110-5-21A370 11105-21A370 64354 <u>FIRESTONE</u> 9152 W013589152 <u>HENDRICKSON</u> B-7128 <u>INT'L/ NAVISTAR</u> 554776C1 <u>LOAD GUARD</u> SC2044 <u>PEERLESS</u> 0550-00080 0550-00081 <u>TAURUS</u> AS622-9156 <u>TRIANGLE</u> 8370
1R14-024 <u>Flexmember</u> 566-28-3-021 <u>Piston</u> Not Included	<p>22.5 7.7</p>	ASA-92-8-078 	USE EXISTING SUPER CUSHION PISTON	<u>INT'L/ NAVISTAR</u> 1681741C1 <u>LOAD GUARD</u> SC2112 <u>PEERLESS</u> 0550-00060 <u>TAURUS</u> AS621-9181



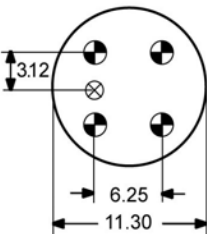
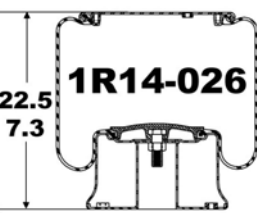
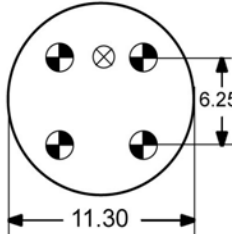
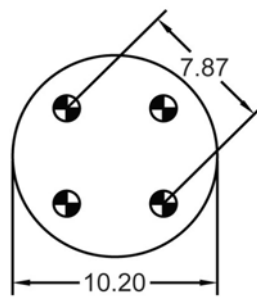

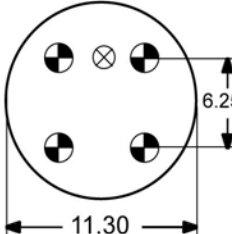
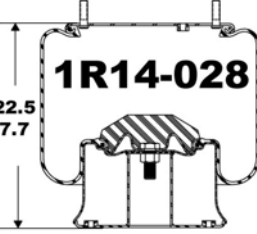
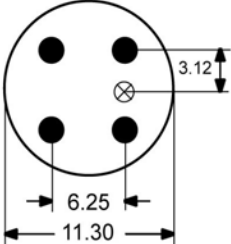
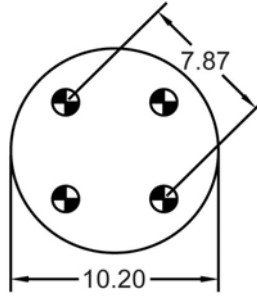
- - Bolt or Stud 1/2-13 or 1/2-20
- ⊗ - Air Fitting - 1/4 NPTF
- ⊙ - Stud - 3/4-10
- ⊕ - Tapped Hole on Top Retainers 3/8-16, on Pistons - 1/2-13
- ⊗ - Air Fitting - 1/2 NPTF or 3/8 NPTF
- ⊙ - Combination Stud Air Fitting Stud - 3/4-16; Air Fitting - 1/4 NPTF

AIR SPRING ROLLING LOBES

Part No.	Side View With Extended And Compressed Height	Upper Mounting View	Lower Mounting View	Manufacturer Numbers
1R14-025 <u>Flexmember</u> 566-28-3-020 <u>Piston</u> Not Included	 <p>1R14-025 Service Assembly of 1R14-019</p>	ASA-92-8-078 	USE EXISTING SUPER CUSHION PISTON	<u>INT'L / NAVISTAR</u> 1681742C1 <u>LOAD GUARD</u> SC2111
1R14-026 <u>Flexmember</u> 566-28-3-021 <u>Piston</u> 566-20-7-096 Steel	 <p>1R14-026</p>	ASA-92-8-028 		<u>Conti</u> 1110-5-17A364 11105-17A364 64343 <u>DAYTON</u> 352-9148 <u>FIRESTONE</u> 9148 W013589148 <u>INT'L / NAVISTAR</u> 554778C1 <u>LOAD GUARD</u> SC2042 <u>PEERLESS</u> 0550-00070 <u>TAURUS</u> AS621-9148 <u>TRIANGLE</u> 8364
1R14-027 <u>Flexmember</u> 566-28-3-021 <u>Piston</u> Not Included	 <p>1R14-027 Service Assembly of 1R14-026</p>	ASA-92-8-028 	USE EXISTING SUPER CUSHION PISTON	<u>INT'L / NAVISTAR</u> 1681743C1 <u>LOAD GUARD</u> SC2113 <u>TAURUS</u> AS621-9198
1R14-028 <u>Flexmember</u> 566-28-3-021 <u>Piston</u> 566-20-7-096 Steel	 <p>1R14-028</p>	ASA-92-8-031 		<u>Conti</u> 1110-5-17A316 11105-17A316 1110-5-17A366 11105-17A366 64342 64345 <u>DAYTON</u> 352-9177 <u>FIRESTONE</u> 9177 9179 W013589177 W013589179 <u>HDA</u> PMABG-9177B <u>HENDRICKSON</u> B-2065 <u>INT'L / NAVISTAR</u> 554779C1 <u>LOAD GUARD</u> SC2046 <u>NEWAY</u> 905-57-003 AR-1115-1-F <u>R & S TRUCK & BODY</u> 1090216 <u>RIDEWELL</u> 1003589177C S-2573-C S-4695-C S-4797-C <u>TAURUS</u> AS621-9177 AS621-9179 <u>TRIANGLE</u> 8316 8366 <u>WATSON & CHALIN</u> AS-0010

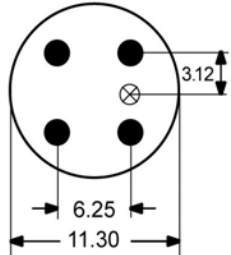
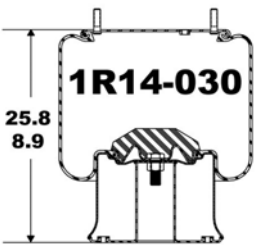
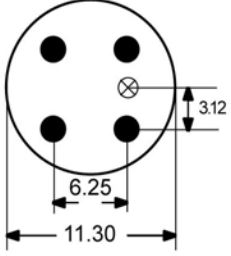
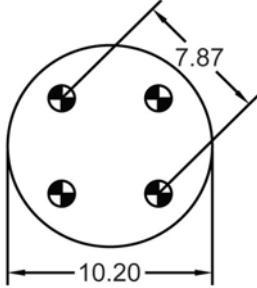
- - Bolt or Stud 1/2-13 or 1/2-20
- ⊗ - Air Fitting - 1/4 NPTF
- ⊙ - Stud - 3/4-10
- ⊕ - Tapped Hole on Top Retainers 3/8-16, on Pistons - 1/2-13
- ⊗ - Air Fitting - 1/2 NPTF or 3/8 NPTF
- ⊙ - Combination Stud Air Fitting Stud - 3/4-16; Air Fitting - 1/4 NPTF

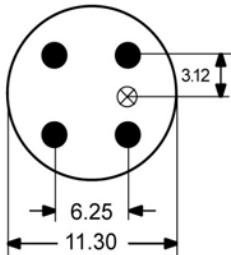
AIR SPRING ROLLING LOBES

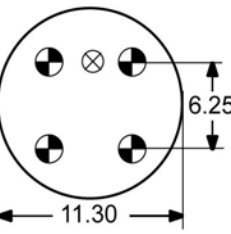
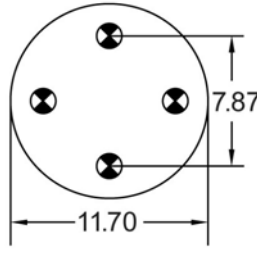
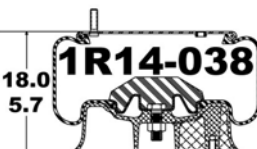
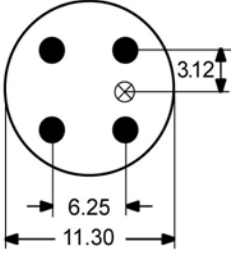
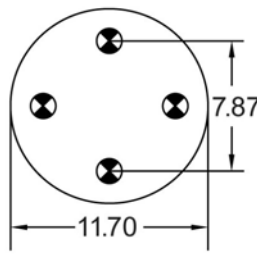
Part No.	Side View With Extended And Compressed Height	Upper Mounting View	Lower Mounting View	Manufacturer Numbers	
1R14-029 <u>Flexmember</u> 566-28-3-021 <u>Piston</u> Not Included	 <p>1R14-029 Service Assembly of 1R14-028</p>	ASA-92-8-079 	USE EXISTING SUPER CUSHION PISTON	INT'L/ <u>NAVISTAR</u> 1681744C1 <u>LOAD GUARD</u> SC2114 <u>NEWAY</u> 900-57-001 <u>RIDEWELL</u> 1013589159C <u>TAURUS</u> AS621-9159	
1R14-030 <u>Flexmember</u> 566-28-3-020 <u>Piston</u> 566-20-7-097 Composite	 <p>1R14-030</p>	ASA-92-8-031 		Conti 1110-5-21A318 11105-21A318 4811NP04 64352 <u>DAYTON</u> 352-9158 <u>FIRESTONE</u> 9158 W013589158 <u>HENDRICKSON</u> 36514-1 36514-4 B-12514-004 B-2063	<u>INT'L/</u> <u>NAVISTAR</u> 554780C1 <u>LOAD GUARD</u> SC2045 <u>NEWAY</u> 905-57-005 905-57-069 AR-1215-1-F <u>RIDEWELL</u> 1003589158C S-2574-C <u>TAURUS</u> AS622-9158 <u>TRIANGLE</u> 8318
1R14-031 <u>Flexmember</u> 566-28-3-020 <u>Piston</u> Not Included	 <p>1R14-031 Service Assembly of 1R14-030</p>	ASC-92-8-079 	USE EXISTING SUPER CUSHION PISTON	INT'L/ <u>NAVISTAR</u> 1681745C1 <u>LOAD GUARD</u> SC2115 <u>NEWAY</u> 900-44-197 <u>RIDEWELL</u> 1013589154C <u>TAURUS</u> AS622-9154	
1R14-037 <u>Flexmember</u> 566-28-3-015 <u>Piston</u> 566-20-7-334 Aluminum	 <p>1R14-037</p>	ASA-92-8-028 		Conti 1110-5-15A414 11105-15A414 64424 <u>DAYTON</u> 352-9215 <u>FIRESTONE</u> 9215 W013589215 <u>HENDRICKSON</u> B-3648 INT'L/ <u>NAVISTAR</u> 554781C1	<u>LOAD GUARD</u> SC2047 <u>TRIANGLE</u> 8414
1R14-038 <u>Flexmember</u> 566-28-3-015 <u>Piston</u> 566-20-7-334 Aluminum	 <p>1R14-038</p>	ASA-92-8-031 		Conti 1110-5-15A415 11105-15A415 64253 <u>DAYTON</u> 352-9200 <u>FIRESTONE</u> 9200 W013589200 <u>HENDRICKSON</u> B-3839 INT'L/ <u>NAVISTAR</u> 1681746C1	<u>LOAD GUARD</u> SC2116 <u>RIDEWELL</u> 1003589200C S-2572-C <u>SUSPENSIONS</u> <u>INC.</u> 200458 <u>TRIANGLE</u> 8415 <u>WATSON &</u> <u>CHALIN</u> AS-0082

- - Bolt or Stud 1/2-13 or 1/2-20
- ⊗ - Air Fitting - 1/4 NPTF
- ⊙ - Stud - 3/4-10
- ⊕ - Tapped Hole on Top Retainers 3/8-16, on Pistons - 1/2-13
- ⊗ - Air Fitting - 1/2 NPTF or 3/8 NPTF
- ⊗ - Combination Stud Air Fitting Stud - 3/4-16; Air Fitting - 1/4 NPTF

AIR SPRING ROLLING LOBES

Part No.	Side View With Extended And Compressed Height	Upper Mounting View	Lower Mounting View	Manufacturer Numbers
1R14-039 <u>Flexmember</u> 566-28-3-065 <u>Piston</u> 566-20-7-334 Aluminum		ASA-92-8-100 		Conti 1110-5C-16A320 11105C-16A320 11105C-16A782 64254 DAYTON 352-8050 FIRESTONE 8050 W013588050 FLEETRITE 1R14-241 HENDRICKSON 36514-13 B-4771 INT'L/ NAVISTAR 1685174C1 LOAD GUARD SC2052 REYCO 23631-01 TRIANGLE 8320 WATSON & CHALIN AS-0039
1R14-042 <u>Flexmember</u> 566-28-3-015 <u>Piston</u> 566-20-7-334-03 Aluminum		ASA-92-8-049 		Conti 1110-5C-16A378 11105C-16A378 64357 FIRESTONE 8052 W013588052 HENDRICKSON 36514-12 B-12514-012 INT'L/ NAVISTAR 1681747C1 LOAD GUARD SC2121 TRIANGLE 8378 WATSON & CHALIN AS-0078
1R14-045 <u>Flexmember</u> 566-28-3-020 <u>Piston</u> 566-20-7-097 Composite		ASA-92-8-049 		Conti 1110-5-21A313 11105-21A313 64273 FIRESTONE 8792 9122 W013588792 W013589122 HENDRICKSON 36514-2 36514-8 B-3467 INT'L/ NAVISTAR 1681748C1 LOAD GUARD SC2098 TRIANGLE 8313 TRP AS91220
1R14-052 <u>Flexmember</u> 566-28-3-015 <u>Piston</u> 566-20-7-334 Aluminum		ASA-92-8-122 		HENDRICKSON B-9001
1R14-060 <u>Flexmember</u> 566-28-3-020 <u>Piston</u> Not Included		ASA-92-8-116 	USE EXISTING SUPER CUSHION PISTON	INT'L/ NAVISTAR 1681749C1 LOAD GUARD SC2099

- - Bolt or Stud 1/2-13 or 1/2-20
- ⊗ - Air Fitting - 1/4 NPTF
- ⊙ - Stud - 3/4-10
- ⊗ - Tapped Hole on Top Retainers 3/8-16, on Pistons - 1/2-13
- ⊗ - Air Fitting - 1/2 NPTF or 3/8 NPTF
- ⊗ - Combination Stud Air Fitting Stud - 3/4-16; Air Fitting - 1/4 NPTF

AIR SPRING ROLLING LOBES

Part No.	Side View With Extended And Compressed Height	Upper Mounting View	Lower Mounting View	Manufacturer Numbers
1R14-094 <u>Flexmember</u> 566-28-3-015 <u>Piston</u> 566-20-7-334-03 Aluminum		ASA-92-8-223 		GILLIG 53-20415-0001
1R14-101 <u>Flexmember</u> 566-28-3-021 <u>Piston</u> 566-20-7-080 Composite		ASA-92-8-048 		FLXIBLE 87-0808-00001 97-5382-001 97-6694-1
1R14-106 <u>Flexmember</u> 566-28-3-021 <u>Piston</u> 566-20-7-188 Steel		ASA-92-8-279 		MCI 12-03-1029
1R14-108 <u>Flexmember</u> 566-28-3-015 <u>Piston</u> 566-20-7-334 Aluminum		ASA-92-8-031 		
1R14-112 <u>Flexmember</u> 566-28-3-024 <u>Piston</u> 566-20-7-050 Aluminum		ASA-92-8-221 		FLXIBLE 6-336-183 GMC 2052623 2054879 2090412 G1017370 G1050310

- - Bolt or Stud 1/2-13 or 1/2-20
- ⊗ - Air Fitting - 1/4 NPTF
- ⊙ - Stud - 3/4-10
- ⊕ - Tapped Hole on Top Retainers 3/8-16, on Pistons - 1/2-13
- ⊗ - Air Fitting - 1/2 NPTF or 3/8 NPTF
- ⊗ - Combination Stud Air Fitting Stud - 3/4-16; Air Fitting - 1/4 NPTF

AIR SPRING ROLLING LOBES

Part No.	Side View With Extended And Compressed Height	Upper Mounting View	Lower Mounting View	Manufacturer Numbers
1R14-113 <u>Flexmember</u> 566-28-3-030 <u>Piston</u> 566-20-7-181 Steel	<p>29.7 9.5</p>	ASC-92-8-049 <p>5.50 11.30</p>	<p>7.87 10.2</p>	Conti 1110-5-22S750 11105-22S750 11105-22S764 64688 FIRESTONE 5505 W013585505 NEWAY 905-57-103
1R14-115 <u>Flexmember</u> 566-28-3-021 <u>Piston</u> 566-20-7-097 Steel	<p>23.7 8.9</p>	ASA-92-8-028 <p>6.25 11.30</p>	<p>7.87 10.20</p>	Conti 1110-5-17A367 11105-17A367 64346 FIRESTONE 9961 W013589961 RIDEWELL 1003589961C TAURUS AS621-9961 TRIANGLE 8367 TRP AS99610
1R14-117 <u>Flexmember</u> 566-28-3-031 <u>Piston</u> 566-20-7-185 Steel	<p>6.55 2.65</p>	578-92-8-267 <p>M12 x 1.25 PT.5 x 14 2.6 4.27 3.68 2.36 11.30</p>	578-92-8-267 <p>M12 x 1.25 4.09 11.00</p>	
1R14-124 <u>Flexmember</u> 566-28-3-021 <u>Piston</u> 566-20-7-217 Composite	<p>22.0 8.8</p>	ASA-92-8-048 <p>3.12 6.25 11.30</p>	<p>7.87 10.10</p>	FLXIBLE T14-1035
1R14-127 <u>Flexmember</u> 566-28-3-031 <u>Piston</u> 566-20-7-181 Steel	<p>30.8 10.1</p>	ASA-92-8-100 <p>1.38 7.75 11.30</p>	<p>7.87 10.10</p>	Conti 1110-5-22S712 11105-22S712 64637 FIRESTONE 9264 W013589264 HENDRICKSON C-13122 RIDEWELL 1000002 TRIANGLE 8539

- - Bolt or Stud 1/2-13 or 1/2-20
- ⊗ - Air Fitting - 1/4 NPTF
- ⊙ - Stud - 3/4-10
- ⊕ - Tapped Hole on Top Retainers 3/8-16, on Pistons - 1/2-13
- ⊗ - Air Fitting - 1/2 NPTF or 3/8 NPTF
- ⊙⊗ - Combination Stud Air Fitting Stud - 3/4-16; Air Fitting - 1/4 NPTF

AIR SPRING ROLLING LOBES

Part No.	Side View With Extended And Compressed Height	Upper Mounting View	Lower Mounting View	Manufacturer Numbers
1R14-130 <u>Flexmember</u> 566-28-3-021 <u>Piston</u> 566-20-7-096 Composite		ASA-92-8-318 		<u>Conti</u> 1110-5-17A507 11105-17A507 64350 <u>FIRESTONE</u> 8778 W013588778
1R14-137 <u>Flexmember</u> 566-28-3-021 <u>Piston</u> 566-20-7-096 Steel		ASA-92-8-049 		<u>Conti</u> 1110-5-19A431 11105-19A431 64391 <u>FIRESTONE</u> 9134 W013589134 <u>NEWAY</u> 905-57-125 <u>TRIANGLE</u> 8431
1R14-141 <u>Flexmember</u> 566-28-3-021 <u>Piston</u> 566-20-7-189 Steel		ASA-92-8-272 		<u>MCI</u> 12-01-1002 12-01-1048
1R14-151 <u>Flexmember</u> 566-28-3-020 <u>Piston</u> 566-20-7-096 Composite		ASA-92-8-100 		<u>Conti</u> 1110-5-19A960 67547 <u>RIDEWELL</u> 1000006
1R14-154 <u>Flexmember</u> 566-28-3-020 <u>Piston</u> 566-20-7-097 Composite		ASA-92-8-361 		<u>WATSON & CHALIN</u> AS-0023-1G

- - Bolt or Stud 1/2-13 or 1/2-20
- ⊗ - Air Fitting - 1/4 NPTF
- - Stud - 3/4-10
- ⊕ - Tapped Hole on Top Retainers 3/8-16, on Pistons - 1/2-13
- ⊗ - Air Fitting - 1/2 NPTF or 3/8 NPTF
- ⊗ - Combination Stud Air Fitting Stud - 3/4-16; Air Fitting - 1/4 NPTF

AIR SPRING ROLLING LOBES

Part No.	Side View With Extended And Compressed Height	Upper Mounting View	Lower Mounting View	Manufacturer Numbers
1R14-155 <u>Flexmember</u> 566-26-3-015 <u>Piston</u> 566-20-7-334 Aluminum	<p>18.0 5.7</p>	ASA-92-8-030 <p>3.12 6.25 11.30 .750-14 NPTF</p>	<p>7.87 11.70</p>	Conti 1110-5C-16A729 64660
1R14-159 <u>Flexmember</u> 566-28-3-021 <u>Piston</u> 566-20-7-096 Steel	<p>22.5 7.7</p>	ASA-92-8-049 <p>5.50 11.30</p>	<p>7.87 10.20</p>	Conti 1110-5-17A405 11105-17A405 64349 <u>FIRESTONE</u> 9164 W013589164 <u>NEWAY</u> 905-57-111 <u>R & S TRUCK & BODY</u> 1090326 <u>TRIANGLE</u> 8405
1R14-160 <u>Flexmember</u> 566-28-3-021 <u>Piston</u> 566-20-7-097 Composite	<p>23.7 8.4</p>	ASA-92-8-049 <p>5.50 11.30</p>	<p>7.87 10.20</p>	Conti 1110-5-17A377 11105-17A377 64347 <u>FIRESTONE</u> 9144 W013589144 <u>NEWAY</u> 905-57-155 <u>TRIANGLE</u> 8523
1R14-164 <u>Flexmember</u> 566-28-3-164 <u>Piston</u> 566-20-7-097 Steel	<p>26.7 8.2</p>	ASA-92-8-402 <p>3.75 3.15 4.06 11.3</p>	<p>7.87 10.24</p>	
1R14-167 <u>Flexmember</u> 566-28-3-015 <u>Piston</u> 566-20-7-223 Steel	<p>19.6 9.0</p>	ASA-92-8-393 <p>6.25 11.30 .500-14 NPTF</p>	<p>4.12 10.1</p>	

- - Bolt or Stud 1/2-13 or 1/2-20
- ⊗ - Air Fitting - 1/4 NPTF
- ⊙ - Stud - 3/4-10
- ⊗ (with dot) - Tapped Hole on Top Retainers 3/8-16, on Pistons - 1/2-13
- ⊗ (with cross) - Air Fitting - 1/2 NPTF or 3/8 NPTF
- ⊗ (with circle) - Combination Stud Air Fitting Stud - 3/4-16; Air Fitting - 1/4 NPTF

AIR SPRING ROLLING LOBES

Part No.	Side View With Extended And Compressed Height	Upper Mounting View	Lower Mounting View	Manufacturer Numbers
1R14-170 <u>Flexmember</u> 566-28-3-020 <u>Piston</u> 566-20-7-097 Composite	<p>25.8 8.9</p>	ASA-92-8-174 <p>6.20 11.30</p>	<p>7.87 10.20</p>	<u>Conti</u> 1110-5-22A752 11105-22A752 34690 <u>NEWAY</u> 905-57-102 <u>TRP</u> AS55031 <u>WATSON & CHALIN</u> AS-0047G
1R14-171 <u>Flexmember</u> 566-28-3-065 <u>Piston</u> 566-20-7-152 Composite	<p>18.4 5.9</p>	ASA-92-8-237 <p>1.38 5.50 11.30</p>	<p>5.9 9.9</p>	<u>Conti</u> 1110-5A-16P523 11105A-16P523 64421 <u>FIRESTONE</u> 8091 W013588091 <u>FLEETRITR</u> 1R14-242 <u>HENDRICKSON</u> C-20901 S20901
1R14-172 <u>Flexmember</u> 566-28-3-042 <u>Piston</u> 566-20-7-152 Composite	<p>22.5 5.9</p>	ASA-92-8-237 <p>1.38 5.50 11.30</p>	<p>5.9 9.9</p>	<u>Conti</u> 1110-5F-17P745 11105F-17P745 65593 <u>FIRESTONE</u> W013588774 <u>HENDRICKSON</u> C-25873
1R14-174 <u>Flexmember</u> 566-28-3-020 <u>Piston</u> 566-20-7-097 Composite	<p>25.8 8.9</p>	ASA-92-8-049 <p>5.50 11.30</p>	<p>7.87 10.20</p>	<u>Conti</u> 1110-5-22A530 11105-22A530 64422 <u>FIRESTONE</u> 5503 W013585503 <u>NEWAY</u> 905-57-200 <u>TRIANGLE</u> 8530 <u>TRP</u> AS55030 <u>WATSON & CHALIN</u> AS-0047
1R14-175 <u>Flexmember</u> 566-28-3-042 <u>Piston</u> 566-20-7-334 Aluminum	<p>20.3 5.1</p>	ASA-92-8-174 <p>6.20 11.30</p>	<p>7.87 11.70</p>	<u>RIDEWELL</u> 1000008

- - Bolt or Stud 1/2-13 or 1/2-20
- ⊗ - Air Fitting - 1/4 NPTF
- ⊙ - Stud - 3/4-10
- ⊕ - Tapped Hole on Top Retainers 3/8-16, on Pistons - 1/2-13
- ⊗ - Air Fitting - 1/2 NPTF or 3/8 NPTF
- ⊗ - Combination Stud Air Fitting Stud - 3/4-16; Air Fitting - 1/4 NPTF

AIR SPRING ROLLING LOBES

Part No.	Side View With Extended And Compressed Height	Upper Mounting View	Lower Mounting View	Manufacturer Numbers
1R14-176 <u>Flexmember</u> 566-28-3-020 <u>Piston</u> 566-20-7-181 Steel	<p>27.1 10.1</p>	ASA-92-8-100 <p>7.75 11.30 1.38</p>	<p>7.87 10.10</p>	
1R14-177 <u>Flexmember</u> 566-28-3-021 <u>Piston</u> 566-20-7-276 Steel	<p>22.5 7.5</p>	ASA-92-8-049 <p>5.50 11.30</p>	<p>7.87 11.10</p>	<u>NABI-HF</u> 5014470
1R14-179 <u>Flexmember</u> 566-28-3-024 <u>Piston</u> 566-20-7-334 Aluminum	<p>14.1 5.2</p>	ASA-92-8-049 <p>5.50 11.30</p>	<p>7.87 11.70</p>	
1R14-182 <u>Flexmember</u> 566-28-3-043 <u>Piston</u> 566-20-7-304 Steel	<p>17.0 8.5</p>	ASA-92-8-272 <p>6.25 3.12 500-14 NPTF 11.30</p>	<p>7.87 9.50</p>	<u>MCI</u> 12-01-1090
1R14-183 <u>Flexmember</u> 566-28-3-044 <u>Piston</u> 566-20-7-152 Composite	<p>18.0 5.9</p>	ASA-92-8-100 <p>7.75 11.30 1.38</p>	<p>5.9 9.9</p>	

- - Bolt or Stud 1/2-13 or 1/2-20
- ⊗ - Air Fitting - 1/4 NPTF
- ⊙ - Stud - 3/4-10
- ⊗ (with cross) - Tapped Hole on Top Retainers 3/8-16, on Pistons - 1/2-13
- ⊗ (with circle) - Air Fitting - 1/2 NPTF or 3/8 NPTF
- ⊗ (with circle and cross) - Combination Stud Air Fitting Stud - 3/4-16; Air Fitting - 1/4 NPTF

AIR SPRING ROLLING LOBES

Part No.	Side View With Extended And Compressed Height	Upper Mounting View	Lower Mounting View	Manufacturer Numbers
1R14-190 <u>Flexmember</u> 566-28-3-044 <u>Piston</u> 566-20-7-152 Composite	<p>18.0 5.9</p>	ASA-92-8-237 <p>5.50 1.38 11.40</p>	<p>5.9 9.9</p>	Conti 1110-5F-17P745 11105F-17P745 65593 <u>WATSON & CHALIN</u> AS-0144
1R14-198 <u>Flexmember</u> 566-28-3-015 <u>Piston</u> 566-20-7-334 Aluminum	<p>18.0 4.7</p>	ASA-92-8-100 <p>7.75 1.38 11.30</p>	<p>7.87 11.70</p>	Conti 1110-5C-16A706 64628
1R14-201 <u>Flexmember</u> 566-28-3-020 <u>Piston</u> 566-20-7-097 Steel	<p>25.8 8.9</p>	ASA-92-8-100 <p>7.75 1.38 11.30</p>	<p>7.87 10.20</p>	Conti 1110-5-21A965 67625
1R14-205 <u>Flexmember</u> 566-28-3-015 <u>Piston</u> 566-20-7-230 Composite	<p>14.6 4.6</p>	ASA-92-8-434 <p>.750-14 NPTF M12x1.75 6.75 11.30</p>	<p>10.00</p>	MCI 12-01-1143
1R14-209 <u>Flexmember</u> 566-28-3-020 <u>Piston</u> 566-20-7-096 Steel	<p>24.2 7.2</p>	ASA-92-8-237 <p>5.50 1.38 11.30</p>	<p>7.87 10.20</p>	

- - Bolt or Stud 1/2-13 or 1/2-20
- ⊗ - Air Fitting - 1/4 NPTF
- ⊙ - Stud - 3/4-10
- ⊕ - Tapped Hole on Top Retainers 3/8-16, on Pistons - 1/2-13
- ⊗ - Air Fitting - 1/2 NPTF or 3/8 NPTF
- ⊗ - Combination Stud Air Fitting Stud - 3/4-16; Air Fitting - 1/4 NPTF

AIR SPRING ROLLING LOBES

Part No.	Side View With Extended And Compressed Height	Upper Mounting View	Lower Mounting View	Manufacturer Numbers
1R14-215 <u>Flexmember</u> 566-28-3-021 <u>Piston</u> 566-20-7-327 Composite		ASA-92-8-049 		<u>FIRESTONE</u> W013589141
1R14-216 <u>Flexmember</u> 566-28-3-015 <u>Piston</u> 566-20-7-334 Aluminum		ASA-92-8-434 		<u>MCI</u> 12-01-1249
1R14-218 <u>Flexmember</u> 566-28-3-021 <u>Piston</u> 566-20-7-276 Steel		ASA-92-8-049 		<u>NABI-HF</u> 5009273
1R14-222 <u>Flexmember</u> 566-28-3-043 <u>Piston</u> 566-20-7-158 Composite		ASA-92-8-279 		<u>MCI</u> 12-04-1158
1R14-232 <u>Flexmember</u> 566-28-3-042 <u>Piston</u> 566-20-7-323 Steel		ASA-92-8-237 		<u>WATSON & CHALIN</u> AS-0241

- - Bolt or Stud 1/2-13 or 1/2-20
- ⊗ - Air Fitting - 1/4 NPTF
- ⊙ - Stud - 3/4-10
- ⊕ - Tapped Hole on Top Retainers 3/8-16, on Pistons - 1/2-13
- ⊗ - Air Fitting - 1/2 NPTF or 3/8 NPTF
- ⊗ - Combination Stud Air Fitting Stud - 3/4-16; Air Fitting - 1/4 NPTF

AIR SPRING ROLLING LOBES

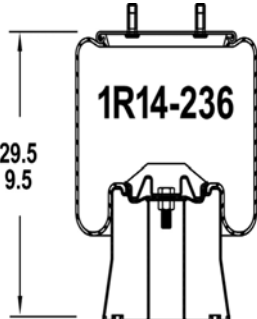
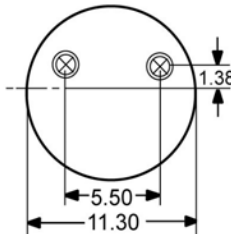
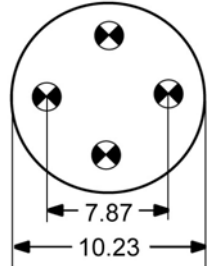
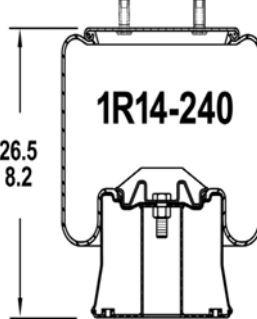
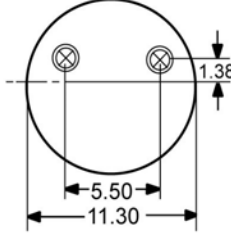
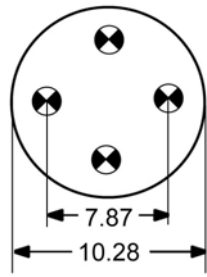
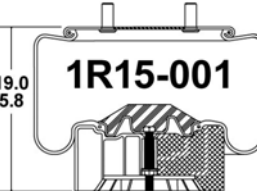
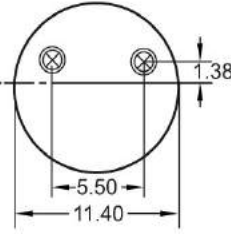
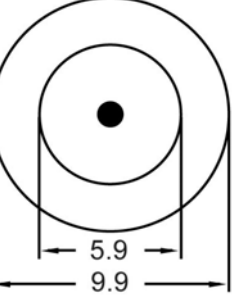
Part No.	Side View With Extended And Compressed Height	Upper Mounting View	Lower Mounting View	Manufacturer Numbers
1R14-236 Flexmember 566-28-3-057 Piston 566-20-7-274 Steel	 <p>29.5 9.5</p>	ASA-92-8-237  <p>1.38 5.50 11.30</p>	 <p>7.87 10.23</p>	HENDRICKSON S-24446 WATSON & CHALIN AS-0246
1R14-240 Flexmember 566-28-3-059 Piston 566-20-7-277 Steel	 <p>26.5 8.2</p>	ASA-92-8-237  <p>1.38 5.50 11.30</p>	 <p>7.87 10.28</p>	HENDRICKSON S-24445
1R15-001 Flexmember 566-30-3-001 Piston 566-20-7-152 Composite	 <p>19.0 5.8</p>	ASA-92-8-237  <p>1.38 5.50 11.40</p>	 <p>5.9 9.9</p>	

- - Bolt or Stud 1/2-13 or 1/2-20
- ⊗ - Air Fitting - 1/4 NPTF
- ⊙ - Stud - 3/4-10
- ⊕ - Tapped Hole on Top Retainers 3/8-16, on Pistons - 1/2-13
- ⊗ - Air Fitting - 1/2 NPTF or 3/8 NPTF
- ⊗ - Combination Stud Air Fitting Stud - 3/4-16; Air Fitting - 1/4 NPTF

AIR SPRING SLEEVES

Part No.	Side View With Extended And Compressed Height	Upper Mounting View	Lower Mounting View	Manufacturer Numbers
1S3-011 Piston ASB-06-7-014		ASB-06-5-012 .750-16 UNF-2A outside .125-27 NPTF inside 	.500-13 UNC 	FIRESTONE 4001 W023584001 LES AUTOBUS G5006637 LINK CAB & SEAT SPRINGS 1101-0001 NOVABUS N12687 PREVOST 95-0208
1S3-013 Piston ASC-06-7-017		ASC-06-5-014 5/16-18 UNC 	.625-11 UNC outside .125 NPTF inside 	FIRESTONE 3000 3001 W023583000 W023583001 PREVOST 950208
1S4-007 Piston ASC-08-7-139		ASB-08-5-007 .375-16 UNC 	.750-16 UNF-2A outside .125-27 NPTF inside 	Conti 67770 SC29-O001 FIRESTONE 7001 7002 7031 W023587001 W023587002 W023587031 FLXIBLE 97-9999-01867 LINK CAB & SEAT SPRINGS 1101-0020 1102-0023 MACK TRUCK 227QS33
1S4-008 Piston ASC-08-7-005		ASB-08-5-006 .750-16 UNF outside .125-27 NPTF inside 	.500-13 UNC 	FIRESTONE 7010 W023587010 LINK CAB & SEAT SPRINGS 1101-0021 MACK TRUCK 227QS39301
1S4-016 Piston ASC-08-7-137		ASB-08-5-132 .500 O.D. Smooth 	.750 smooth outside .125-27 NPTF inside 	INT'L/ NAVISTAR 1680378C1

● - Bolt or Stud 1/2-13 or 1/2-20

● - Tapped Hole on Top Retainers 3/8-16, on Pistons - 1/2-13

⊗ - Air Fitting - 1/4 NPTF

⊗ - Air Fitting - 1/2 NPTF or 3/8 NPTF

⊗ - Stud - 3/4-10

⊗ - Combination Stud Air Fitting Stud - 3/4-16; Air Fitting - 1/4 NPTF

AIR SPRING SLEEVES

Part No.	Side View With Extended And Compressed Height	Upper Mounting View	Lower Mounting View	Manufacturer Numbers
1S4-030 Piston ASC-08-7-093		ASB-08-5-006 .750-16 UNF outside .125-27 NPTF inside 	.500-13 UNC 	FREIGHTLINER 20-12461
1S4-035 Piston ASC-08-7-163		ASB-08-5-132 .500 O.D. smooth 	.750 smooth outside .125-27 UNC inside 	Conti 62844 SZ70-5060P02 FIRESTONE 7003 7050 7055 W023587003 W023587050 W023587055
1S4-042 Piston ASC-08-7-219		AS2-08-5-007 .375-16 UNC 	.750 smooth 	VOLVO 66003-0007
1S4-044 Piston ASC-08-7-194		ASB-08-5-076 .750 smooth outside .125-27 NPTF inside 	.500-13 UNC 	Conti 62561 SZ70-5067 LINK CAB & SEAT SPRINGS 1101-0023
1S4-056 Piston ASC-08-7-194		ASB-08-5-129 .750-16 UNC outside .125-27 NPTF inside 	.500-13 UNC 	FIRESTONE 7040 W023587040 LINK CAB & SEAT SPRINGS 1101-0024

- - Bolt or Stud 1/2-13 or 1/2-20
- ⊗ - Air Fitting - 1/4 NPTF
- - Stud - 3/4-10
- ⊕ - Tapped Hole on Top Retainers 3/8-16, on Pistons - 1/2-13
- ⊗ - Air Fitting - 1/2 NPTF or 3/8 NPTF
- ⊗ - Combination Stud Air Fitting Stud - 3/4-16; Air Fitting - 1/4 NPTF

AIR SPRING SLEEVES

Part No.	Side View With Extended And Compressed Height	Upper Mounting View	Lower Mounting View	Manufacturer Numbers
1S4-058 Piston ASC-08-7-139		AS2-08-5-007 .375-16 UNC 	.750 smooth outside .125-27 UNC inside 	Conti 67858 SC29-0086 FIRESTONE 7086 W023587086
1S4-067 Piston ASC-08-7-137		ASB-08-5-024 .750-16 UNF outside .125-27 NPTF inside 	.750 smooth outside .125-27 NPTF inside 	FIRESTONE 7007 W023587007 MACK TRUCK 227QS34B
1S4-074 Piston ASC-08-7-134		AS2-08-5-007 .375-16 UNC 	.750 smooth outside .125-27 NPTF inside 	VOLVO 66003-3201
1S4-123 Piston ASC-08-7-157		ASB-08-5-170 .125-27 NPTF .375-16 UNC 	.375-16 UNC 	Conti 67769 SC29-0046 SZ70-5060P02 FIRESTONE W023587046 LINK CAB & SEAT SPRINGS 1102-0022
1S4-173 Piston ASC-08-7-137		ASB-08-5-172 3/4 - 16 UNF 2A 	.750 smooth outside .125-27 NPTF inside 	

- - Bolt or Stud 1/2-13 or 1/2-20
- ⊗ - Air Fitting - 1/4 NPTF
- ⊙ - Stud - 3/4-10
- ⊕ - Tapped Hole on Top Retainers 3/8-16, on Pistons - 1/2-13
- ⊗ - Air Fitting - 1/2 NPTF or 3/8 NPTF
- ⊕ - Combination Stud Air Fitting Stud - 3/4-16; Air Fitting - 1/4 NPTF

AIR SPRING SLEEVES

Part No.	Side View With Extended And Compressed Height	Upper Mounting View	Lower Mounting View	Manufacturer Numbers
1S4-175 Piston ASC-08-7-157		ASB-08-5-076 .750 smooth outside .125-27 NPTF inside	.375-16 UNC 	Conti 67858 SC29-0086 LINK CAB & SEAT SPRINGS 1101-0025
1S4-187 Flexmember 579-08-1-049		ASB-08-5-129 .750-16 UNC outside .125-27 NPTF inside	.750-16 UNF-2A outside .125-27 NPTF inside 	DANA / SPICER SR1VA103
1S4.5-073 Piston ASC-08-7-194		ASB-08-5-076 .750 smooth outside .125-27 NPTF inside	.500-13 UNC 	LINK CAB & SEAT SPRINGS 1101-0030
1S4.5-107 Piston ASC-08-7-194		ASB-08-5-129 .750-16 UNC outside .125-27 NPTF inside	.500-13 UNC 	FIRESTONE 7080 W023587080

- - Bolt or Stud 1/2-13 or 1/2-20
- ⊗ - Air Fitting - 1/4 NPTF
- ⊙ - Stud - 3/4-10
- ⊕ - Tapped Hole on Top Retainers 3/8-16, on Pistons - 1/2-13
- ⊗ - Air Fitting - 1/2 NPTF or 3/8 NPTF
- ⊙ - Combination Stud Air Fitting Stud - 3/4-16; Air Fitting - 1/4 NPTF

AIR SPRING SLEEVES

Part No.	Side View With Extended And Compressed Height	Upper Mounting View	Lower Mounting View	Manufacturer Numbers
1S4.5-113 Piston 579-08-7-219		ASB-08-5-132 .500 O.D. smooth	.750 smooth outside .125-27 UNC inside	FIRESTONE 7056 W023587056 LINK CAB & SEAT SPRINGS 1102-0043
1S4.5-121 Piston ASC-08-7-157		ASB-08-5-201 .375-16 UNC .125-27 NPTF .75	.375-16 UNC	Conti 67851 SC29-W035 SZ70-7065P02 FIRESTONE 7035 W023587035 SEARS SEAT S-20235 S-9383
1S4.5-179 Piston ASC-08-7-157		ASB-08-5-076 .750 smooth outside .125-27 NPTF inside	.375-16 UNC	LINK CAB & SEAT SPRINGS 1101-0031
1S5-005 Piston ASC-08-7-005		ASB-08-5-006 .750-16 UNF outside .125-27 NPTF inside	.500-13 UNC	LINK CAB & SEAT SPRINGS 1101-0040
1S5-006 Piston ASC-08-7-005		ASB-08-5-006 .750-16 UNF outside .125-27 NPTF inside	.500-13 UNC	FIRESTONE 7017 W023587014 W023587017 W023587042 W023587044 LINK CAB & SEAT SPRINGS 1101-0041

● - Bolt or Stud - 1/2-13 or 1/2-20

● - Tapped Hole on Top Retainers - 3/8-16, on Pistons - 1/2-13

⊗ - Air Fitting - 1/4 NPTF

⊗ - Air Fitting - 1/2 NPTF or 3/8 NPTF

⊙ - Stud - 3/4-10

⊗ - Combination Stud Air Fitting Stud - 3/4-16; Air Fitting - 1/4 NPTF

AIR SPRING SLEEVES

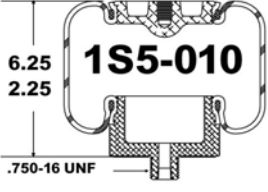
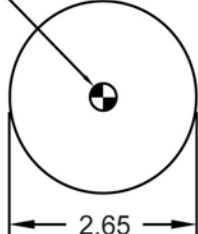
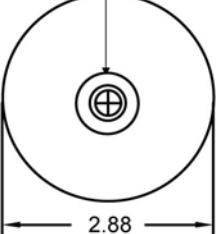
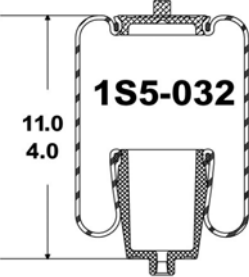
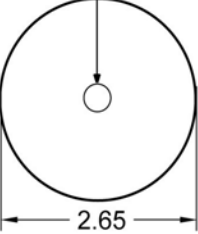
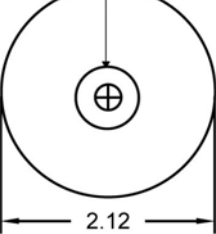
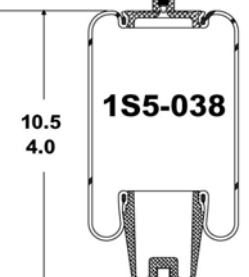
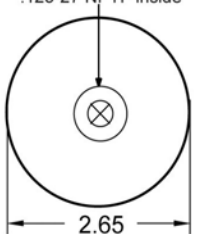
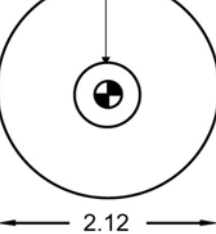
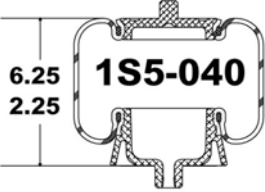
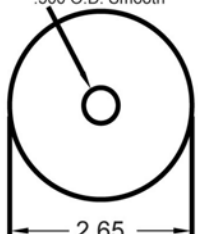
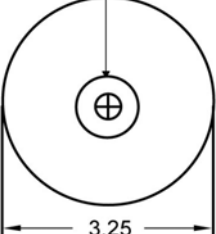
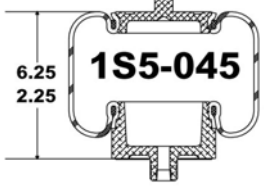
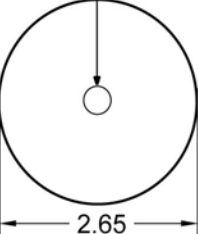
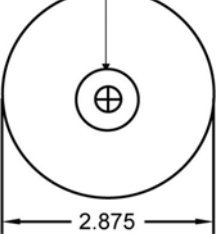
Part No.	Side View With Extended And Compressed Height	Upper Mounting View	Lower Mounting View	Manufacturer Numbers
1S5-010 Piston ASC-08-7-139		AS2-08-5-007 		Conti 67882 SC29-YG01
1S5-032 Piston ASC-08-7-163		ASB-08-5-132 		LINK CAB & SEAT SPRINGS 1101-0042 1101-A042
1S5-038 Piston ASC-08-7-194		ASB-08-5-076 		FIRESTONE 7081 W023587081 LINK CAB & SEAT SPRINGS 1101-0043
1S5-040 Piston ASC-08-7-137		ASB-08-5-132 		Conti 67636 SC29-W087 FIRESTONE 7087 W023587087 FLEETRITE 1S5-040 FREIGHTLINER GYR1S5040
1S5-045 Piston ASC-08-7-139		ASB-08-5-132 		FREIGHTLINER GYR1S5045

- - Bolt or Stud 1/2-13 or 1/2-20
- ⊗ - Air Fitting - 1/4 NPTF
- ⊙ - Stud - 3/4-10
- ⊕ - Tapped Hole on Top Retainers 3/8-16, on Pistons - 1/2-13
- ⊗ - Air Fitting - 1/2 NPTF or 3/8 NPTF
- ⊕ - Combination Stud Air Fitting Stud - 3/4-16; Air Fitting - 1/4 NPTF

AIR SPRING SLEEVES

Part No.	Side View With Extended And Compressed Height	Upper Mounting View	Lower Mounting View	Manufacturer Numbers
1S5-055 Piston ASC-08-7-194		AS2-08-5-063 .750 smooth outside .125-27 NPTF inside 	.500-13 UNC 	MACK TRUCK 227QS38B
1S5-057 Piston 579-08-7-157		ASB-08-5-170 .125-27 NPTF .375-16 UNC 	.375-16 UNC 	Conti 67852 SC29-Y108 SZ70-8077P02 FIRESTONE 7108 W023587108 MILSCO 07067A
1S5-060 Piston ASC-08-7-219		AS2-08-5-007 .375-16 UNC 	.750 smooth 	VOLVO 66003-0004
1S5-061 Piston ASC-08-7-194		AS2-08-5-079 .125-27 NPTF .500-13 UNC 	.500-13 UNC 	
1S5-070 Piston ASB-08-7-134		AS2-08-5-007 .375-16 UNC 	.750 smooth outside .125-27 NPTF inside 	VOLVO 8169029

- - Bolt or Stud - 1/2-13 or 1/2-20
- ⊗ - Air Fitting - 1/4 NPTF
- ⊙ - Stud - 3/4-10
- ⊕ - Tapped Hole on Top Retainers - 3/8-16, on Pistons - 1/2-13
- ⊗ - Air Fitting - 1/2 NPTF or 3/8 NPTF
- ⊙ - Combination Stud Air Fitting - Stud - 3/4-16; Air Fitting - 1/4 NPTF

AIR SPRING SLEEVES

Part No.	Side View With Extended And Compressed Height	Upper Mounting View	Lower Mounting View	Manufacturer Numbers
1S5-072 Piston ASC-08-7-219		AS2-08-5-066 .750 Smooth	.750 smooth outside .125-27 NPTF inside	FLEETRITE 1S5-072 INTL/ NAVISTAR 2012771C1
1S5-120 Piston ASC-08-7-194		ASB-08-5-129 .750-16 UNF outside .125-27 NPTF inside	.500-13 UNC	FIRESTONE 7014 7017 7042 7044 W023587014 W023587017 W023587042 W023587044
1S5-122 Piston ASC-08-7-213		ASB-08-5-145 .75 - 16 UNF	.750 smooth outside .125 NPTF inside	
1S5-133 Piston ASC-08-7-157		ASB-08-5-076 .750 smooth outside .125-27 NPTF inside	.375-16 UNC	LINK CAB & SEAT SPRINGS 1101-0045
1S5-135 Piston ASC-08-7-157		ASB-08-5-170 .375-16 UNC .125-27 NPTF .75	.375-16 UNC	LINK CAB & SEAT SPRINGS 1101-0044

- - Bolt or Stud 1/2-13 or 1/2-20
- ⊗ - Air Fitting - 1/4 NPTF
- ⊙ - Stud - 3/4-10
- ⊕ - Tapped Hole on Top Retainers 3/8-16, on Pistons - 1/2-13
- ⊗ - Air Fitting - 1/2 NPTF or 3/8 NPTF
- ⊙ - Combination Stud Air Fitting Stud - 3/4-16; Air Fitting - 1/4 NPTF

AIR SPRING SLEEVES

Part No.	Side View With Extended And Compressed Height	Upper Mounting View	Lower Mounting View	Manufacturer Numbers
1S5-152 Piston ASC-08-7-219		AS2-08-5-112 .375-16 UNC 	.750 smooth outside .125-27 UNC inside 	FIRESTONE 7110 W023587110
1S5-154 Piston ASC-08-7-213		ASB-08-5-190 M20 x 2.50-6G 	.750-16 smooth outside .125-27 NPTF inside 	MACK TRUCK 227QS312BM
1S5-157 Piston ASC3-08-7-006		AS2-08-5-007 .375-16 UNC 	.750-16 UNF outside .125 NPTF inside 	FIRESTONE 7064 LINK CAB & SEAT SPRINGS 1102-0074
1S5-164 Piston ASC-08-7-137		ASB-08-5-190 M20 x 2.50-6G 	.750 smooth outside .125-27 NPTF inside 	MACK TRUCK 227QS47M
1S5-173 Piston ASC-08-7-137		ASB-08-5-132 .500 O.D. smooth 	.750 smooth outside .125-27 NPTF inside 	FREIGHTLINER 18-41909-0

- - Bolt or Stud 1/2-13 or 1/2-20
- ⊗ - Air Fitting - 1/4 NPTF
- ⊙ - Stud - 3/4-10
- ◐ - Tapped Hole on Top Retainers 3/8-16, on Pistons - 1/2-13
- ⊗ - Air Fitting - 1/2 NPTF or 3/8 NPTF
- ⊙ - Combination Stud Air Fitting Stud - 3/4-16; Air Fitting - 1/4 NPTF

AIR SPRING SLEEVES

Part No.	Side View With Extended And Compressed Height	Upper Mounting View	Lower Mounting View	Manufacturer Numbers
1S5-174 Piston ASC-08-7-232		ASB-08-5-132 500 O.D. Smooth 	.750 smooth outside .125-27 NPTF inside 	
1S5-175 Flexmember 579-10-1-116 Piston ASC-08-7-277		ASB-08-5-176 Recommended Mounting Hole .72" Diameter 	1/4" Air Tube Fitting Recommended Mounting Hole 1.34" Diameter 	Conti 67451 67638 68161 SC31-B207 SC31-Y205 SC31-Y215 FIRESTONE 7205 7207 7215 W023587205 W023587207 W023587215
1S5-176 Flexmember 579-10-1-115 Piston ASC-08-7-277		ASB-08-5-176 Recommended Mounting Hole .72" Diameter 	1/4" Air Tube Fitting Recommended Mounting Hole 1.34" Diameter 	Conti 67452 SC31-W206 FIRESTONE 7202 7206 W023587202 W023587206 FREIGHTLINER 18-29919-000
1S5-186 Flexmember 579-10-1-083 Piston 579-08-7-301		579-08-5-112 .375-16 UNC 	.750-16 UNF-2A outside .125-27 NPTF inside 	Conti 68162 SC29-Y036 FIRESTONE 7036 W023587036 PETERBILT 2903200
1S6-023 Piston ASB-08-7-079		ASB-08-5-048 M20 x 2.50-6G outside .125 NPTF inside 	M20 x 2.50-6G 	

- - Bolt or Stud 1/2-13 or 1/2-20
- ⊗ - Air Fitting - 1/4 NPTF
- ⊗ - Stud - 3/4-10
- ⊕ - Tapped Hole on Top Retainers 3/8-16, on Pistons - 1/2-13
- ⊗ - Air Fitting - 1/2 NPTF or 3/8 NPTF
- ⊗ - Combination Stud Air Fitting Stud - 3/4-16; Air Fitting - 1/4 NPTF

AIR SPRING SLEEVES

Part No.	Side View With Extended And Compressed Height	Upper Mounting View	Lower Mounting View	Manufacturer Numbers
1S6-026 Piston ASC-08-7-223		AS2-08-5-048 M20 x 2.50-6G outside .125-27 NPTF inside	.750 smooth 	<u>MACK TRUCK</u> 227QS310BM
1S6-031 Piston ASC-08-7-215		ASB-08-5-146 M20 x 2.50-6G	.750 smooth outside .125-27 NPTF inside 	<u>FREIGHTLINER</u> GYR1S6031
1S6-033 Piston ASC-08-7-215		ASB-08-5-146 M20 x 2.50-6g	.750 smooth outside .125-27 NPTF inside 	
1S6-036 Piston 579-08-7-215		ASB-08-5-146 M20 x 2.50-6g	.250 Air Fitting with Quick Disconnect 	
1S6-046 Piston ASC-08-7-215		ASB-08-5-145 .750-16 UNF	.750 smooth outside .125-27 NPTF inside 	<u>LINK CAB & SEAT SPRINGS</u> 1101-0060

- - Bolt or Stud 1/2-13 or 1/2-20
- - Tapped Hole on Top Retainers 3/8-16, on Pistons - 1/2-13
- ⊗ - Air Fitting - 1/4 NPTF
- ⊗ - Air Fitting - 1/2 NPTF or 3/8 NPTF
- ⊙ - Stud - 3/4-10
- ⊗ - Combination Stud Air Fitting Stud - 3/4-16; Air Fitting - 1/4 NPTF

AIR SPRING SLEEVES

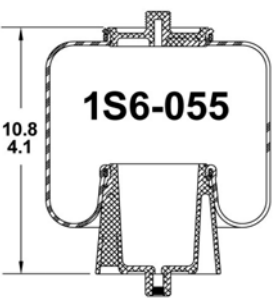
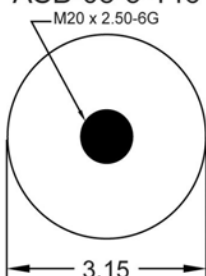
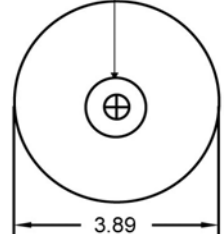
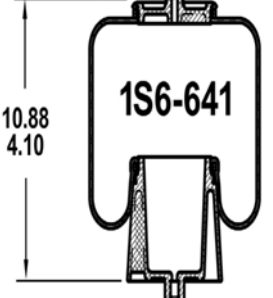
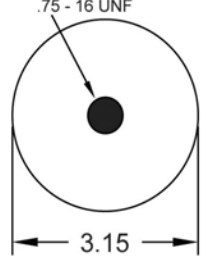
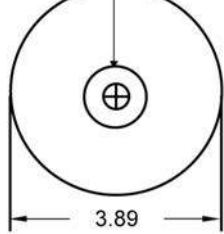
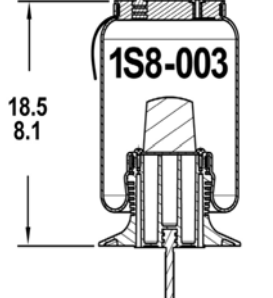
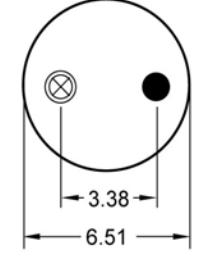
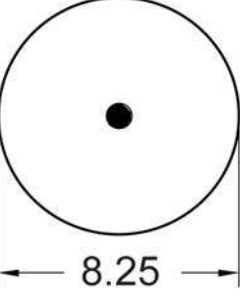
Part No.	Side View With Extended And Compressed Height	Upper Mounting View	Lower Mounting View	Manufacturer Numbers
1S6-055 Piston ASC-08-7-215	 <p>10.8 4.1</p>	ASB-08-5-146 M20 x 2.50-6G  <p>3.15</p>	.750 smooth outside .125-27 NPTF inside  <p>3.89</p>	
1S6-641 Piston 566-08-7-215	 <p>10.88 4.10</p>	ASB-08-5-145 .75 - 16 UNF  <p>3.15</p>	.750-16 UNF-2A outside .125-27 NPTF inside  <p>3.89</p>	
1S8-003 Flexmember 579-16-1-002 Piston 579-16-7-103	 <p>18.5 8.1</p>	579-16-5-001  <p>3.38 6.51</p>	 <p>8.25</p>	

- - Bolt or Stud 1/2-13 or 1/2-20
- ⊗ - Air Fitting - 1/4 NPTF
- ⊙ - Stud - 3/4-10
- ◐ - Tapped Hole on Top Retainers 3/8-16, on Pistons - 1/2-13
- ⊗ - Air Fitting - 1/2 NPTF or 3/8 NPTF
- ⊗ - Combination Stud Air Fitting Stud - 3/4-16; Air Fitting - 1/4 NPTF

Notes

FLEX MEMBER INDEX

Flexible Member No.	Piston Number	Air Spring Number	Flexible Member No.	Piston Number	Air Spring Number
556-33-8-335		3B14-464	566-22-3-049	566-20-7-124	1R11-232
556-33-8-335		3B14-459	566-22-3-049	566-20-7-240	1R11-189
556-33-8-335		3B14-457	566-22-3-049	566-20-7-124	1R11-130
556-33-8-335		3B14-455	566-22-3-051	566-20-7-183	1R11-115
556-33-8-335		3B14-450	566-22-3-057	566-20-7-253	1R11-225
566-16-3-007	566-16-7-021	1R8-034	566-22-3-057	566-20-7-150	1R11-171
566-16-3-007	566-16-7-000	1R8-031	566-22-3-057	566-20-7-150	1R11-161
566-16-3-007	566-16-7-000	1R8-009	566-22-3-060	566-20-7-257	1R11-175
566-16-3-007	566-16-7-021	1R8-041	566-22-3-068	566-20-7-257	1R11-216
566-18-3-003	566-16-7-009	1R9-065	566-22-3-073	566-20-7-308	1R11-224
566-18-3-004	566-16-7-021	1R9-070	566-22-3-075	566-20-7-257	1R11-176
566-18-3-004	566-16-7-000	1R9-056	566-22-3-079	566-20-7-079	1R11-244
566-18-3-004	566-16-7-000	1R9-054	566-22-3-084	566-20-7-156	1R11-249
566-18-3-004	566-16-7-021	1R9-053	566-22-3-143	566-20-7-120	1R11-243
566-18-3-004	Not Included	1R9-047	566-22-3-143	566-20-7-253	1R11-241
566-18-3-004	566-16-7-021	1R9-003	566-22-3-143	566-20-7-156	1R11-223
566-18-3-004	566-16-7-021	1R9-071	566-22-3-143	566-20-7-239	1R11-191
566-18-3-010	566-16-7-017	1R9-038	566-22-3-143	566-20-7-209	1R11-179
566-18-3-010	566-16-7-017	1R9-025	566-22-3-143	566-20-7-209	1R11-178
566-20-3-021	566-20-7-240	1R10-133	566-22-3-143	566-20-7-240	1R11-170
566-20-3-021	566-20-7-240	1R10-127	566-22-3-143	566-20-7-250	1R11-169
566-20-3-021	566-20-7-237	1R10-122	566-22-3-143	566-20-7-235	1R11-166
566-20-3-021	566-20-7-240	1R10-120	566-22-3-143	566-20-7-239	1R11-149
566-20-3-021	566-20-7-240	1R10-118	566-22-3-143	566-20-7-240	1R11-147
566-20-3-021	566-20-7-077-03	1R10-109	566-22-3-143	566-20-7-240	1R11-143
566-20-3-021	566-20-7-120	1R10-108	566-22-3-143	566-20-7-156	1R11-121
566-20-3-021	566-20-7-240	1R10-105	566-22-3-143	566-20-7-079	1R11-090
566-20-3-021	566-20-7-240	1R10-099	566-22-3-143	566-20-7-120	1R11-088
566-20-3-021	566-20-7-240	1R10-091	566-22-3-143	566-20-7-077-03	1R11-045
566-20-3-021	566-20-7-120	1R10-090	566-22-3-143	566-20-7-036	1R11-039
566-20-3-021	566-20-7-240	1R10-089	566-22-3-143	566-20-7-209	1R11-209
566-20-3-021	566-20-7-240	1R10-087	566-22-3-143	Not Included	1R11-109
566-20-3-021	Not Included	1R10-085	566-22-3-143	566-20-7-240	1R11-094
566-20-3-021	566-20-7-387	1R10-171	566-23-8-329		2B14-469
566-20-3-021	566-20-7-240	1R10-165	566-24-3-024	566-20-7-240	1R12-127
566-20-3-022	Not Included	1R10-030	566-24-3-024	566-20-7-079	1R12-028
566-20-3-022	566-20-7-240	1R10-019	566-24-3-038	566-20-7-053	1R12-669
566-20-3-023	566-20-7-240	1R10-137	566-24-3-038	566-20-7-080	1R12-645
566-20-3-027	566-20-7-150	1R10-101	566-24-3-038	566-20-7-238	1R12-640
566-20-3-029	566-20-7-055	1R10-072	566-24-3-038	566-20-7-036	1R12-617
566-22-3-006	566-20-7-079	1R11-018	566-24-3-038	566-20-7-237	1R12-586
566-22-3-021	566-20-7-252	1R11-242	566-24-3-038	566-20-7-158	1R12-584
566-22-3-021	566-20-7-286	1R11-222	566-24-3-038	566-20-7-159	1R12-576
566-22-3-021	566-20-7-287	1R11-221	566-24-3-038	566-20-7-235	1R12-567
566-22-3-021	566-20-7-286	1R11-220	566-24-3-038	566-20-7-214	1R12-554
566-22-3-021	566-20-7-287	1R11-219	566-24-3-038	566-20-7-213	1R12-553
566-22-3-021	566-20-7-253	1R11-205	566-24-3-038	566-20-7-215	1R12-552
566-22-3-021	566-20-7-253	1R11-204	566-24-3-038	566-20-7-240	1R12-545
566-22-3-021	566-20-7-251	1R11-203	566-24-3-038	566-20-7-209	1R12-541
566-22-3-021	566-20-7-252	1R11-202	566-24-3-038	566-20-7-236	1R12-535
566-22-3-021	566-20-7-252	1R11-201	566-24-3-038	566-20-7-005	1R12-509
566-22-3-021	566-20-7-252	1R11-200	566-24-3-038	566-20-7-235	1R12-502
566-22-3-021	566-20-7-014	1R11-162	566-24-3-038	566-20-7-238	1R12-499
566-22-3-021	566-20-7-014	1R11-159	566-24-3-038	566-20-7-036	1R12-494
566-22-3-021	566-20-7-055	1R11-152	566-24-3-038	566-20-7-215	1R12-486
566-22-3-021	566-20-7-055	1R11-151	566-24-3-038	566-20-7-215	1R12-485
566-22-3-021	566-20-7-055	1R11-150	566-24-3-038	566-20-7-215	1R12-484
566-22-3-021	566-20-7-055	1R11-066	566-24-3-038	566-20-7-246	1R12-462
566-22-3-021	566-20-7-014	1R11-047	566-24-3-038	566-20-7-079	1R12-454
566-22-3-021	566-20-7-014	1R11-028	566-24-3-038	566-20-7-235	1R12-441
566-22-3-021	566-20-7-156	1R11-207	566-24-3-038	566-20-7-158	1R12-438
566-22-3-021	566-20-7-287	1R11-268	566-24-3-038	566-20-7-158	1R12-436
566-22-3-028	566-20-7-055	1R11-075	566-24-3-038	566-20-7-246	1R12-423
566-22-3-042	566-20-7-235	1R11-252	566-24-3-038	566-20-7-246	1R12-400
566-22-3-044	566-20-7-079	1R11-097	566-24-3-038	566-20-7-240	1R12-396

*The prefixes ASC, ASD, AS3 OR AS4 may be used interchangeably with 566 and may appear on some flex members or pistons.

FLEX MEMBER INDEX (Cont.)

Flexible Member No.	Piston Number	Air Spring Number	Flexible Member No.	Piston Number	Air Spring Number
566-24-3-038	Not Included	1R12-394	566-24-3-067	566-20-7-251	1R12-508
566-24-3-038	566-20-7-079	1R12-369	566-24-3-067	566-20-7-239	1R12-487
566-24-3-038	566-20-7-163	1R12-366	566-24-3-067	566-20-7-014	1R12-465
566-24-3-038	566-20-7-079	1R12-365	566-24-3-067	566-20-7-014	1R12-435
566-24-3-038	566-20-7-080	1R12-358	566-24-3-067	566-20-7-055	1R12-324
566-24-3-038	566-20-7-080	1R12-356	566-24-3-067	566-20-7-164	1R12-309
566-24-3-038	566-20-7-080	1R12-285	566-24-3-067	566-20-7-055	1R12-204
566-24-3-038	566-20-7-080	1R12-220	566-24-3-067	566-20-7-055	1R12-178
566-24-3-038	566-20-7-079	1R12-188	566-24-3-067	566-20-7-055	1R12-156
566-24-3-038	566-20-7-079	1R12-182	566-24-3-067	Not Included	1R12-097
566-24-3-038	566-20-7-080	1R12-155	566-24-3-067	566-20-7-014	1R12-095
566-24-3-038	566-20-7-080	1R12-130	566-24-3-072	566-20-7-079	1R12-212
566-24-3-038	Not Included	1R12-093	566-24-3-076	566-20-7-158	1R12-655
566-24-3-038	566-20-7-079	1R12-090	566-24-3-076	566-20-7-239	1R12-648
566-24-3-038	566-20-7-080	1R12-066	566-24-3-076	566-20-7-156	1R12-636
566-24-3-038	566-20-7-233	1R12-419	566-24-3-076	566-20-7-239	1R12-620
566-24-3-048	566-20-7-240	1R12-511	566-24-3-076	566-20-7-251	1R12-616
566-24-3-048	566-20-7-240	1R12-304	566-24-3-076	566-20-7-156	1R12-614
566-24-3-048	566-20-7-120	1R12-288	566-24-3-076	566-20-7-156	1R12-600
566-24-3-048	566-20-7-240	1R12-284	566-24-3-076	566-20-7-212	1R12-543
566-24-3-048	566-20-7-120	1R12-217	566-24-3-076	566-20-7-156	1R12-512
566-24-3-048	566-20-7-120	1R12-154	566-24-3-076	566-20-7-235	1R12-505
566-24-3-048	566-20-7-006	1R12-143	566-24-3-076	566-20-7-036	1R12-492
566-24-3-061	566-20-7-251	1R12-539	566-24-3-076	566-20-7-156	1R12-445
566-24-3-061	566-20-7-251	1R12-531	566-24-3-076	566-20-7-156	1R12-437
566-24-3-061	566-20-7-251	1R12-530	566-24-3-076	566-20-7-164	1R12-434
566-24-3-061	566-20-7-014	1R12-383	566-24-3-076	566-20-7-036	1R12-422
566-24-3-061	566-20-7-197	1R12-359	566-24-3-076	566-20-7-158	1R12-421
566-24-3-061	566-20-7-197	1R12-351	566-24-3-076	566-20-7-036	1R12-370
566-24-3-061	566-20-7-197	1R12-350	566-24-3-076	566-20-7-164	1R12-367
566-24-3-066	566-20-7-159	1R12-653	566-24-3-076	566-20-7-036	1R12-355
566-24-3-066	566-20-7-159	1R12-639	566-24-3-076	566-20-7-080	1R12-352
566-24-3-066	566-20-7-158	1R12-613	566-24-3-076	566-20-7-055	1R12-325
566-24-3-066	566-20-7-235	1R12-568	566-24-3-076	566-20-7-055	1R12-205
566-24-3-066	566-20-7-006	1R12-527	566-24-3-076	566-20-7-036-03	1R12-169
566-24-3-066	566-20-7-237	1R12-504	566-24-3-076	566-20-7-006	1R12-139
566-24-3-066	566-20-7-235	1R12-480	566-24-3-076	566-20-7-036	1R12-132
566-24-3-066	566-20-7-005	1R12-467	566-24-3-076	566-20-7-036	1R12-076
566-24-3-066	566-20-7-159	1R12-444	566-24-3-076	566-20-7-235	1R12-676
566-24-3-066	566-20-7-237	1R12-439	566-24-3-090	566-20-7-006	1R12-663
566-24-3-066	566-20-7-080	1R12-395	566-24-3-090	566-20-7-159	1R12-637
566-24-3-066	566-20-7-006	1R12-357	566-24-3-090	566-20-7-159	1R12-609
566-24-3-066	566-20-7-080	1R12-281	566-24-3-090	566-20-7-159	1R12-599
566-24-3-066	566-20-7-080	1R12-265	566-24-3-090	566-20-7-236	1R12-507
566-24-3-066	566-20-7-006	1R12-261	566-24-3-090	566-20-7-159	1R12-363
566-24-3-066	566-20-7-006	1R12-195	566-24-3-090	566-20-7-006	1R12-335
566-24-3-066	566-20-7-080	1R12-185	566-24-3-090	566-20-7-159	1R12-256
566-24-3-066	566-20-7-080	1R12-167	566-24-3-097	566-20-7-303	1R12-647
566-24-3-066	566-20-7-006	1R12-145	566-24-3-097	566-20-7-158	1R12-644
566-24-3-066	566-20-7-006	1R12-142	566-24-3-097	566-20-7-236	1R12-622
566-24-3-066	Not Included	1R12-113	566-24-3-097	566-20-7-159	1R12-621
566-24-3-066	566-20-7-006	1R12-103	566-24-3-097	566-20-7-158	1R12-592
566-24-3-066	566-20-7-236	1R12-689	566-24-3-097	566-20-7-235	1R12-532
566-24-3-066	566-20-7-158	1R12-607	566-24-3-097	566-20-7-237	1R12-498
566-24-3-066	566-20-7-006	1R12-208	566-24-3-097	566-20-7-235	1R12-481
566-24-3-067	566-20-7-238	1R12-571	566-24-3-097	566-20-7-158	1R12-450
566-24-3-067	566-20-7-252	1R12-563	566-24-3-097	566-20-7-158	1R12-446
566-24-3-067	566-20-7-251	1R12-562	566-24-3-097	566-20-7-246	1R12-424
566-24-3-067	566-20-7-253	1R12-561	566-24-3-097	566-20-7-246	1R12-404
566-24-3-067	566-20-7-253	1R12-560	566-24-3-097	566-20-7-246	1R12-402
566-24-3-067	566-20-7-252	1R12-559	566-24-3-097	566-20-7-079	1R12-274
566-24-3-067	566-20-7-252	1R12-558	566-24-3-097	566-20-7-236	1R12-1049
566-24-3-067	566-20-7-252	1R12-557	566-24-3-097	566-20-7-158	1R12-1048
566-24-3-067	566-20-7-252	1R12-556	566-24-3-100	566-20-7-036	1R12-593
566-24-3-067	566-20-7-253	1R12-555	566-24-3-108	566-20-7-322	1R12-603

*The prefixes ASC, ASD, AS3 OR AS4 may be used interchangeably with 566 and may appear on some flex members or pistons.

FLEX MEMBER INDEX (Cont.)

Flexible Member No.	Piston Number	Air Spring Number	Flexible Member No.	Piston Number	Air Spring Number
566-24-3-108	566-20-7-116	1R12-303	566-28-3-015	566-20-7-334	1R14-037
566-24-3-116	566-20-7-209	1R12-540	566-28-3-015	566-20-7-334	1R14-216
566-24-3-116	566-20-7-158	1R12-534	566-28-3-015	566-20-7-230	1R14-205
566-24-3-117	566-20-7-299	1R12-580	566-28-3-015	566-20-7-223	1R14-167
566-24-3-120	566-20-7-079	1R12-631	566-28-3-020	566-20-7-096	1R14-209
566-24-3-120	566-20-7-223	1R12-406	566-28-3-020	566-20-7-097	1R14-201
566-24-3-120	566-20-7-192	1R12-377	566-28-3-020	566-20-7-181	1R14-176
566-24-3-140	566-20-7-377	1R12-403	566-28-3-020	566-20-7-097	1R14-174
566-24-3-142	566-20-7-413	1R12-1047	566-28-3-020	566-20-7-097	1R14-170
566-24-3-163	566-20-7-236	1R12-538	566-28-3-020	566-20-7-097	1R14-154
566-24-3-163	566-20-7-221	1R12-401	566-28-3-020	Not Included	1R14-060
566-24-3-163	566-20-7-080	1R12-092	566-28-3-020	566-20-7-097	1R14-045
566-24-3-163	566-20-7-235	1R12-069	566-28-3-020	Not Included	1R14-031
566-24-3-164	566-20-7-303	1R12-615	566-28-3-020	566-20-7-097	1R14-030
566-24-3-165	566-20-7-236	1R12-523	566-28-3-020	Not Included	1R14-025
566-24-3-165	566-20-7-236	1R12-432	566-28-3-020	566-20-7-097	1R14-019
566-24-3-165	566-20-7-163	1R12-375	566-28-3-020	566-20-7-096	1R14-151
566-26-3-015	566-20-7-084	1R13-070	566-28-3-021	566-20-7-276	1R14-218
566-26-3-015	566-20-7-334	1R14-155	566-28-3-021	566-20-7-327	1R14-215
566-26-3-043	566-20-7-080	1R13-117	566-28-3-021	566-20-7-276	1R14-177
566-26-3-044	566-20-7-006	1R13-116	566-28-3-021	566-20-7-097	1R14-160
566-26-3-044	566-20-7-006	1R13-115	566-28-3-021	566-20-7-096	1R14-159
566-26-3-050	566-20-7-106	1R13-138	566-28-3-021	566-20-7-189	1R14-141
566-26-3-050	566-20-7-127	1R13-124	566-28-3-021	566-20-7-096	1R14-137
566-26-3-051	566-20-7-124	1R13-182	566-28-3-021	566-20-7-096	1R14-130
566-26-3-051	566-20-7-124	1R13-181	566-28-3-021	566-20-7-217	1R14-124
566-26-3-051	566-20-7-106	1R13-155	566-28-3-021	566-20-7-097	1R14-115
566-26-3-051	566-20-7-036-03	1R13-075	566-28-3-021	566-20-7-188	1R14-106
566-26-3-051	566-20-7-036	1R13-053	566-28-3-021	566-20-7-080	1R14-101
566-26-3-051	Not Included	1R13-049	566-28-3-021	Not Included	1R14-029
566-26-3-051	566-20-7-096	1R13-047	566-28-3-021	566-20-7-096	1R14-028
566-26-3-051	566-20-7-327	1R13-039	566-28-3-021	Not Included	1R14-027
566-26-3-054	566-20-7-334	1R13-120	566-28-3-021	566-20-7-096	1R14-026
566-26-3-055	566-20-7-230	1R13-130	566-28-3-021	Not Included	1R14-024
566-26-3-056	566-20-7-231	1R13-133	566-28-3-021	566-20-7-096	1R14-018
566-26-3-068	566-20-7-325	1R13-118	566-28-3-024	566-20-7-334	1R14-179
566-26-3-068	566-20-7-127	1R13-149	566-28-3-024	566-20-7-050	1R14-112
566-26-3-069	566-20-7-334	1R13-151	566-28-3-030	566-20-7-181	1R14-113
566-26-3-071	566-20-7-235	1R13-208	566-28-3-031	566-20-7-181	1R14-127
566-26-3-071	566-20-7-237	1R13-153	566-28-3-031	566-20-7-185	1R14-117
566-26-3-071	566-20-7-235	1R13-152	566-28-3-042	566-20-7-334	1R14-175
566-26-3-072	Not Included	1R13-048	566-28-3-042	566-20-7-152	1R14-172
566-26-3-072	566-20-7-097	1R13-038	566-28-3-042	566-20-7-323	1R14-232
566-26-3-072	566-20-7-097	1R13-216	566-28-3-043	566-20-7-304	1R14-182
566-26-3-073	566-20-7-154	1R13-159	566-28-3-043	566-20-7-158	1R14-222
566-26-3-078	566-20-7-152	1R13-189	566-28-3-044	566-20-7-152	1R14-190
566-26-3-078	566-20-7-314	1R13-188	566-28-3-044	566-20-7-152	1R14-183
566-26-3-078	566-20-7-152	1R13-179	566-28-3-057	566-20-7-274	1R14-236
566-26-3-078	566-20-7-154	1R13-177	566-28-3-059	566-20-7-277	1R14-240
566-26-3-078	566-20-7-154	1R13-176	566-28-3-065	566-20-7-152	1R14-171
566-26-3-078	566-20-7-152	1R13-174	566-28-3-065	566-20-7-334	1R14-039
566-26-3-081	566-20-7-106	1R13-210	566-28-3-164	566-20-7-097	1R14-164
566-26-3-081	566-20-7-106	1R13-207	566-30-3-001	566-20-7-152	1R15-001
566-26-3-081	566-20-7-296	1R13-109	566-92-3-356		2B14-362
566-26-3-081	566-20-7-296	1R13-097	578-33-8-335		3B14-453
566-26-3-095	566-20-7-274	1R13-235	578-33-8-335		3B14-463
566-26-3-097	566-20-7-277	1R13-237	578-33-8-335		3B14-462
566-26-3-098	566-20-7-106	1R13-119	578-33-8-335		3B14-456
566-26-3-098	566-20-7-106	1R13-239	578-91-3-301		1B12-313
566-28-3-015	566-20-7-334	1R14-198	578-91-3-301		1B12-306
566-28-3-015	566-20-7-334	1R14-108	578-91-3-301		1B12-305
566-28-3-015	566-20-7-334-03	1R14-094	578-91-3-301		1B12-301
566-28-3-015	566-20-7-334	1R14-052	578-91-3-301		1B12-322
566-28-3-015	566-20-7-334-03	1R14-042	578-91-3-351		1B14-351
566-28-3-015	566-20-7-334	1R14-038	578-91-3-351		1B14-350

*The prefixes ASC, ASD, AS3 OR AS4 may be used interchangeably with 566 and may appear on some flex members or pistons.

FLEX MEMBER INDEX (Cont.)

Flexible Member No.	Piston Number	Air Spring Number	Flexible Member No.	Piston Number	Air Spring Number
578-91-3-351		1B14-373	578-92-3-353		2B14-367
578-91-3-352		1B14-358	578-92-3-353		2B14-366
578-92-3-202		2B9-245	578-92-3-353		2B14-360
578-92-3-202		2B9-244	578-92-3-353		2B14-359
578-92-3-202		2B9-240	578-92-3-353		2B14-356
578-92-3-202		2B9-230	578-92-3-353		2B14-355
578-92-3-202		2B9-225	578-92-3-353		2B14-354
578-92-3-202		2B9-216	578-923-356		2B14-479
578-92-3-202		2B9-210	578-92-3-356		2B14-476
578-92-3-202		2B9-206	578-92-3-356		2B14-470
578-92-3-202		2B9-201	578-92-3-356		2B14-462
578-92-3-202		2B9-200	578-92-3-356		2B14-383
578-92-3-206		2B9-270	578-92-3-356		2B14-365
578-92-3-206		2B9-265	578-92-3-356		2B14-363
578-92-3-206		2B9-255	578-93-3-100		3B12-338
578-92-3-206		2B9-254	578-93-3-100		3B12-335
578-92-3-206		2B9-253	578-93-3-100		3B12-329
578-92-3-206		2B9-252	578-93-3-100		3B12-328
578-92-3-206		2B9-251	578-93-3-100		3B12-324
578-92-3-206		2B9-250	578-93-3-100		3B12-319
578-92-3-206		2B9-218	578-93-3-100		3B12-315
578-923-208		2B9-607	578-93-3-100		3B12-312
578-92-3-208		2B9-266	578-93-3-100		3B12-310
578-923-211		2B9-611	578-93-3-100		3B12-305
578-923-211		2B9-606	578-93-3-100		3B12-304
578-923-211		2B9-296	578-93-3-100		3B12-303
578-92-3-211		2B9-288	578-93-3-100		3B12-301
578-92-3-211		2B9-280	578-93-3-100		3B12-300
578-92-3-211		2B9-246	578-93-3-100		3B12-342
578-92-3-211		2B9-239	578-93-3-103		3B12-347
578-92-3-211		2B9-229	578-93-3-103		3B12-326
578-9-23-211		2B9-614	578-93-3-103		3B12-325
578-92-3-250		2B10-226	578-93-3-103		3B12-323
578-92-3-309		2B12-463	578-93-3-103		3B12-322
578-92-3-309		2B12-432	578-93-3-104		3B12-337
578-92-3-309		2B12-429	578-93-3-105		3B12-416
578-92-3-309		2B12-427	578-93-3-105		3B12-415
578-92-3-309		2B12-426	578-93-3-335		3B14-452
578-92-3-309		2B12-425	578-93-3-335		3B14-451
578-92-3-309		2B12-424	578-93-3-350		3B14-367
578-92-3-309		2B12-412	578-93-3-350		3B14-365
578-92-3-309		2B12-411	578-93-3-350		3B14-364
578-92-3-309		2B12-410	578-93-3-350		3B14-361
578-92-3-309		2B12-406	578-93-3-350		3B14-360
578-92-3-309		2B12-340	578-93-3-350		3B14-359
578-92-3-309		2B12-320	578-93-3-350		3B14-356
578-92-3-309		2B12-319	578-93-3-350		3B14-354
578-92-3-309		2B12-318	578-93-3-350		3B14-351
578-92-3-309		2B12-313	579-91-3-501		1B5-510
578-92-3-309		2B12-309	579-91-3-532		1B8-564
578-92-3-309		2B12-307	579-923-510		1B6-530
578-92-3-309		2B12-304	579-92-3-515		2B6-535
578-92-3-309		2B12-300	579-923-525		2B7-542
578-92-3-310		2B12-446	579-92-3-525		2B7-541
578-92-3-310		2B12-434	579-92-3-525		2B7-540
578-92-3-310		2B12-428	579-92-3-526		2B7-548
578-92-3-310		2B12-402	579-92-3-530		2B8-550
578-92-3-310		2B12-324			
578-92-3-310		2B12-317			
578-92-3-310		2B12-305			
578-92-3-315		2B12-440			
578-92-3-315		2B12-416			
578-92-3-315		2B12-346			
578-92-3-315		2B12-345			
578-92-3-353		2B14-473			

*The prefixes ASC, ASD, AS3 OR AS4 may be used interchangeably with 566 and may appear on some flex members or pistons.

Firestone By Flex Member

Firestone Flex Member No.	Firestone No.	Air Spring Number	Firestone Flex Member No.	Firestone No.	Air Spring Number
19	7009	1B12-301	1T15L-2	8900	1R11-204
20	6910	2B9-200	1T15L-2	9476	1R11-205
20	6935	2B9-201	1T15L-4	8919	1R11-191
20	6905	2B9-206	1T15LA-0	9618	1R11-220
20	6908	2B9-210	1T15LA-0	9625	1R11-222
20	6897	2B9-229	1T15LA-1	9617	1R11-219
20	6940	2B9-230	1T15LA-1	9622	1R11-221
20	6902	2B9-239	1T15LC-2.5	9379	1R12-178
20	6932	2B9-246	1T15LC-2.5	9566	1R12-204
20	6941	2B9-265	1T15LC-2.5	9565	1R12-324
21	7145	2B14-354	1T15LC-4.5	9568	1R12-205
21	7146	2B14-355	1T15LC-4.5	9567	1R12-325
21	7136	2B14-356	1T15LP-5	9293	1R10-120
21	7140	2B14-359	1T15LP-5	9291	1R10-122
21	7135	2B14-360	1T15LP-5	9295	1R11-166
21	7123	2B14-367	1T15M-0	9039	1R12-095
22	7424	2B12-300	1T15M-0	9031	1R12-350
22	7408	2B12-307	1T15M-0	9033	1R12-351
22	7400	2B12-309	1T15M-0	9077	1R12-359
22	7405	2B12-313	1T15M-0	8961	1R12-555
22	7185	2B12-318	1T15M-0	8964	1R12-556
22	7409	2B12-319	1T15M-0	8976	1R12-557
22	7401	2B12-320	1T15M-0	8986	1R12-558
22	7410	2B12-406	1T15M-0	9029	1R12-559
22	7404	2B12-410	1T15M-0	9308	1R12-560
22	7181	2B12-411	1T15M-0	9332	1R12-561
22	7183	2B12-412	1T15M-2	9302	1R12-132
22	7180	2B12-425	1T15M-2	9053	1R12-309
22	7406	2B12-426	1T15M-2	9127	1R12-355
22	7429	2B12-427	1T15M-2	9366	1R12-487
22	7423	2B12-432	1T15M-2	9325	1R12-505
26	7325	2B8-550	1T15M-2	8204	1R12-508
38	8008	3B12-300	1T15M-2	9078	1R12-512
38	8010	3B12-301	1T15M-2	8197	1R12-562
38	8018	3B12-303	1T15M-2	8934	1R12-563
38	8006	3B12-304	1T15M-2	9365	1R12-571
38	8027	3B12-310	1T15M-4	9069	1R12-069
38	8033	3B12-312	1T15M-4	9010	1R12-352
38	8032	3B12-319	1T15M-4	9070	1R12-370
38	7994	3B12-328	1T15M-4	8802	1R12-434
38	7995	3B12-329	1T15M-4	9797	1R12-437
38	7996	3B12-335	1T15M-4	8805	1R12-438
113	7103	1B14-350	1T15M-4	8806	1R12-445
113	7105	1B14-351	1T15M-6	9083	1R12-066
257	7795	2B10-226	1T15M-6	9213	1R12-090
313	7808	3B14-354	1T15M-6	9082	1R12-092
313	7838	3B14-356	1T15M-6	9227	1R12-130
313	7839	3B14-359	1T15M-6	9392	1R12-143
313	7848	3B14-360	1T15M-6	9096	1R12-155
313	7847	3B14-367	1T15M-6	9219	1R12-182
333	7846	3B14-451	1T15M-6	9223	1R12-188
333	7850	3B14-452	1T15M-6	9193	1R12-220
113B-1	7112	1B14-358	1T15M-6	9194	1R12-356
1T14C-1		1R9-065	1T15M-6	9096	1R12-358
1T14F-4	5406	1R9-038	1T15M-6	9296	1R12-400
1T14F-4		1R9-070	1T15M-6	8924	1R12-436
1T15L-1.5	9422	1R11-028	1T15M-6	9362	1R12-441
1T15L-2	9447	1R11-066	1T15M-6	9026	1R12-567
1T15L-2	9448	1R11-150	1T15M-7.5	9921	1R12-502
1T15L-2	9457	1R11-151	1T15M-7.5	9935	1R12-532
1T15L-2	9459	1R11-152	1T15M-8	9923	1R12-481
1T15L-2	9376	1R11-200	1T15M-9	9101	1R12-103
1T15L-2	9377	1R11-201	1T15M-9	9241	1R12-142
1T15L-2	9378	1R11-202	1T15M-9	9238	1R12-145
1T15L-2	9387	1R11-203	1T15M-9	9192	1R12-167

*The prefixes ASC, ASD, AS3 OR AS4 may be used interchangeably with 566 and may appear on some flex members or pistons.

Firestone By Flex Member (Cont.)

Firestone Flex Member No.	Firestone No.	Air Spring Number	Firestone Flex Member No.	Firestone No.	Air Spring Number
1T15M-9	9349	1R12-195	1T19L-11	9158	1R14-030
1T15M-9	9130	1R12-281	1T19L-11	9122	1R14-045
1T15M-9	9348	1R12-357	20-2	6927	2B9-218
1T15M-9	9203	1R12-395	20-2	6943	2B9-250
1T15M-9	9346	1R12-439	20-2	6948	2B9-251
1T15M-9	9245	1R12-446	20-2	6944	2B9-252
1T15M-9	9243	1R12-480	20-2	6945	2B9-253
1T15M-9	8852	1R12-568	20-2	6946	2B9-254
1T15M-11	9321	1R12-256	20-2	6947	2B9-255
1T15M-11	9320	1R12-363	21-2	6801	2B14-365
1T15M-11	9370	1R12-580	21-2	6803	2B14-366
1T15MLW-7	8944	1R12-366	22-1.5	7443	2B12-305
1T15MT-3	9640	1R12-367	22-1.5	7447	2B12-324
1T15MT-6	9466	1R12-365	22-1.5	7444	2B12-416
1T15MT-8	9287	1R12-274	22-1.5	7473	2B12-428
1T15MT-8	9371	1R12-401	22-1.5	7472	2B12-434
1T15MT-8	9297	1R12-402	22-1.5	7444	2B12-446
1T15MT-8	9373	1R12-403	228-1.5	7545	2B12-345
1T15MT-8	9375	1R12-404	228-1.5	7550	2B12-346
1T15MT-8	9648	1R12-538	228-1.5	7446	2B12-402
1T15MW-10	9265	1R12-375	228-1.5	7555	2B12-440
1T15S-6	9043	1R10-089	233-2	7557	2B14-383
1T15S-6	9073	1R11-018			
1T15TM-1	5766	1R11-161			
1T15TM-1	9421	1R11-171			
1T15V-8	9473	1R12-484			
1T15V-8	9471	1R12-485			
1T15V-8	9473	1R12-486			
1T15V-8	9471	1R12-504			
1T15V-8	9471	1R12-552			
1T15V-8	9472	1R12-553			
1T15V-8	9470	1R12-554			
1T15V-8	9275	1R13-117			
1T15V-11	9250	1R13-115			
1T15V-11	9252	1R13-116			
1T15VLY-10.5	9580	1R13-118			
1T15VM-4.0	9270	1R13-119			
1T15ZR-6	9780	1R12-303			
1T17B-11	8748	1R13-152			
1T17B-11	8749	1R13-153			
1T17BB-2	8729	1R13-130			
1T17CA-5	8709	1R13-159			
1T17CA-6.5	8713	1R13-176			
1T17CA-6.5	8708	1R13-177			
1T17CL-5	8710	1R13-124			
1T19F-5	9204	1R12-265			
1T19F-5	9218	1R13-120			
1T19F-5	9215	1R14-037			
1T19F-5	9200	1R14-038			
1T19F-7	9148	1R14-026			
1T19F-7	9961	1R14-115			
1T19F-7	9164	1R14-159			
1T19F-7	9144	1R14-160			
1T19F-9	9134	1R14-137			
1T19F-11	9156	1R14-019			
1T19F-12	5505	1R14-113			
1T19F-12	5503	1R14-174			
1T19F-14	9264	1R14-127			
1T19FC-6	8091	1R14-171			
1T19J-6	8052	1R14-042			
1T19J-7	8050	1R14-039			
1T19L-7	9121	1R13-039			
1T19L-7	9149	1R14-018			
1T19L-7	9177	1R14-028			
1T19L-11	9122	1R13-038			

*The prefixes ASC, ASD, AS3 OR AS4 may be used interchangeably with 566 and may appear on some flex members or pistons.

PISTON INDEX

Piston Number	Flexible Member No.	Air Spring Number	Piston Number	Flexible Member No.	Air Spring Number
566-08-7-157	579-08-1-002	1S4-205	566-20-7-055	566-20-3-029	1R10-072
566-08-7-215		1S6-641	566-20-7-077-	566-22-3-143	1R11-045
566-16-7-000	566-18-3-004	1R9-056	566-20-7-077-	566-20-3-021	1R10-109
566-16-7-000	566-18-3-004	1R9-054	566-20-7-079	566-24-3-120	1R12-631
566-16-7-000	566-16-3-007	1R8-031	566-20-7-079	566-24-3-038	1R12-454
566-16-7-000	566-16-3-007	1R8-009	566-20-7-079	566-24-3-038	1R12-369
566-16-7-009	566-18-3-003	1R9-065	566-20-7-079	566-24-3-038	1R12-365
566-16-7-017	566-18-3-010	1R9-038	566-20-7-079	566-24-3-097	1R12-274
566-16-7-017	566-18-3-010	1R9-025	566-20-7-079	566-24-3-072	1R12-212
566-16-7-021	566-18-3-004	1R9-070	566-20-7-079	566-24-3-038	1R12-188
566-16-7-021	566-18-3-004	1R9-053	566-20-7-079	566-24-3-038	1R12-182
566-16-7-021	566-18-3-004	1R9-003	566-20-7-079	566-24-3-038	1R12-090
566-16-7-021	566-16-3-007	1R8-034	566-20-7-079	566-24-3-024	1R12-028
566-16-7-021	566-18-3-004	1R9-071	566-20-7-079	566-22-3-079	1R11-244
566-16-7-021	566-16-3-007	1R8-041	566-20-7-079	566-22-3-044	1R11-097
566-20-7-005	566-24-3-038	1R12-509	566-20-7-079	566-22-3-143	1R11-090
566-20-7-005	566-24-3-066	1R12-467	566-20-7-079	566-22-3-006	1R11-018
566-207-006	566-24-3-066	1R12-208	566-20-7-080	566-28-3-021	1R14-101
566-20-7-006	566-26-3-044	1R13-116	566-20-7-080	566-26-3-043	1R13-117
566-20-7-006	566-26-3-044	1R13-115	566-20-7-080	566-24-3-038	1R12-645
566-20-7-006	566-24-3-090	1R12-663	566-20-7-080	566-24-3-066	1R12-395
566-20-7-006	566-24-3-066	1R12-527	566-20-7-080	566-24-3-038	1R12-358
566-20-7-006	566-24-3-066	1R12-357	566-20-7-080	566-24-3-038	1R12-356
566-20-7-006	566-24-3-090	1R12-335	566-20-7-080	566-24-3-076	1R12-352
566-20-7-006	566-24-3-066	1R12-261	566-20-7-080	566-24-3-038	1R12-285
566-20-7-006	566-24-3-066	1R12-195	566-20-7-080	566-24-3-066	1R12-281
566-20-7-006	566-24-3-066	1R12-145	566-20-7-080	566-24-3-066	1R12-265
566-20-7-006	566-24-3-048	1R12-143	566-20-7-080	566-24-3-038	1R12-220
566-20-7-006	566-24-3-066	1R12-142	566-20-7-080	566-24-3-066	1R12-185
566-20-7-006	566-24-3-076	1R12-139	566-20-7-080	566-24-3-066	1R12-167
566-20-7-006	566-24-3-066	1R12-103	566-20-7-080	566-24-3-038	1R12-155
566-20-7-014	566-24-3-067	1R12-465	566-20-7-080	566-24-3-038	1R12-130
566-20-7-014	566-24-3-067	1R12-435	566-20-7-080	566-24-3-163	1R12-092
566-20-7-014	566-24-3-061	1R12-383	566-20-7-080	566-24-3-038	1R12-066
566-20-7-014	566-24-3-067	1R12-095	566-20-7-084	566-26-3-015	1R13-070
566-20-7-014	566-22-3-021	1R11-162	566-20-7-096	566-28-3-020	1R14-209
566-20-7-014	566-22-3-021	1R11-159	566-20-7-096	566-28-3-021	1R14-159
566-20-7-014	566-22-3-021	1R11-047	566-20-7-096	566-28-3-021	1R14-137
566-20-7-014	566-22-3-021	1R11-028	566-20-7-096	566-28-3-021	1R14-130
566-20-7-036	566-26-3-051	1R13-053	566-20-7-096	566-28-3-021	1R14-028
566-20-7-036	566-24-3-038	1R12-617	566-20-7-096	566-28-3-021	1R14-026
566-20-7-036	566-24-3-038	1R12-494	566-20-7-096	566-28-3-021	1R14-018
566-20-7-036	566-24-3-076	1R12-492	566-20-7-096	566-26-3-051	1R13-047
566-20-7-036	566-24-3-076	1R12-422	566-20-7-097	566-28-3-020	1R14-201
566-20-7-036	566-24-3-076	1R12-370	566-20-7-097	566-28-3-020	1R14-174
566-20-7-036	566-24-3-076	1R12-355	566-20-7-097	566-28-3-020	1R14-170
566-20-7-036	566-24-3-076	1R12-132	566-20-7-097	566-28-3-021	1R14-160
566-20-7-036	566-24-3-076	1R12-076	566-20-7-097	566-28-3-020	1R14-154
566-20-7-036	566-22-3-143	1R11-039	566-20-7-097	566-28-3-021	1R14-115
566-20-7-036	566-24-3-100	1R12-593	566-20-7-097	566-28-3-020	1R14-045
566-20-7-036-	566-26-3-051	1R13-075	566-20-7-097	566-28-3-020	1R14-030
566-20-7-036-	566-24-3-076	1R12-169	566-20-7-097	566-28-3-020	1R14-019
566-20-7-050	566-28-3-024	1R14-112	566-20-7-097	566-26-3-072	1R13-038
566-20-7-053	566-24-3-038	1R12-669	566-20-7-097	566-26-3-072	1R13-216
566-20-7-055	566-24-3-076	1R12-325	566-20-7-097	566-28-3-164	1R14-164
566-20-7-055	566-24-3-067	1R12-324	566-20-7-106	566-26-3-081	1R13-210
566-20-7-055	566-24-3-076	1R12-205	566-20-7-106	566-26-3-081	1R13-207
566-20-7-055	566-24-3-067	1R12-204	566-20-7-106	566-26-3-051	1R13-155
566-20-7-055	566-24-3-067	1R12-178	566-20-7-106	566-26-3-050	1R13-138
566-20-7-055	566-24-3-067	1R12-156	566-20-7-106	566-26-3-098	1R13-119
566-20-7-055	566-22-3-021	1R11-152	566-20-7-106	566-26-3-098	1R13-239
566-20-7-055	566-22-3-021	1R11-151	566-20-7-116	566-24-3-108	1R12-303
566-20-7-055	566-22-3-021	1R11-150	566-20-7-120	566-24-3-048	1R12-288
566-20-7-055	566-22-3-028	1R11-075	566-20-7-120	566-24-3-048	1R12-217
566-20-7-055	566-22-3-021	1R11-066	566-20-7-120	566-24-3-048	1R12-154

*The prefixes ASC, ASD, AS3 OR AS4 may be used interchangeably with 566 and may appear on some flex members or pistons.

PISTON INDEX (Cont.)

Piston Number	Flexible Member No.	Air Spring Number	Piston Number	Flexible Member No.	Air Spring Number
566-20-7-120	566-22-3-143	1R11-243	566-20-7-181	566-28-3-030	1R14-113
566-20-7-120	566-22-3-143	1R11-088	566-20-7-183	566-22-3-051	1R11-115
566-20-7-120	566-20-3-021	1R10-108	566-20-7-185	566-28-3-031	1R14-117
566-20-7-120	566-20-3-021	1R10-090	566-20-7-188	566-28-3-021	1R14-106
566-20-7-124	566-26-3-051	1R13-182	566-20-7-189	566-28-3-021	1R14-141
566-20-7-124	566-26-3-051	1R13-181	566-20-7-192	566-24-3-120	1R12-377
566-20-7-124	566-22-3-049	1R11-232	566-20-7-197	566-24-3-061	1R12-359
566-20-7-124	566-22-3-049	1R11-130	566-20-7-197	566-24-3-061	1R12-351
566-20-7-127	566-26-3-050	1R13-124	566-20-7-197	566-24-3-061	1R12-350
566-20-7-127	566-26-3-068	1R13-149	566-20-7-209	566-24-3-038	1R12-541
566-20-7-150	566-22-3-057	1R11-171	566-20-7-209	566-24-3-116	1R12-540
566-20-7-150	566-22-3-057	1R11-161	566-20-7-209	566-22-3-143	1R11-179
566-20-7-150	566-20-3-027	1R10-101	566-20-7-209	566-22-3-143	1R11-178
566-20-7-152	566-30-3-001	1R15-001	566-20-7-209	566-22-3-143	1R11-209
566-20-7-152	566-28-3-044	1R14-190	566-20-7-212	566-24-3-076	1R12-543
566-20-7-152	566-28-3-044	1R14-183	566-20-7-213	566-24-3-038	1R12-553
566-20-7-152	566-28-3-042	1R14-172	566-20-7-214	566-24-3-038	1R12-554
566-20-7-152	566-28-3-065	1R14-171	566-20-7-215	566-24-3-038	1R12-552
566-20-7-152	566-26-3-078	1R13-189	566-20-7-215	566-24-3-038	1R12-486
566-20-7-152	566-26-3-078	1R13-179	566-20-7-215	566-24-3-038	1R12-485
566-20-7-152	566-26-3-078	1R13-174	566-20-7-215	566-24-3-038	1R12-484
566-20-7-154	566-26-3-078	1R13-177	566-20-7-217	566-28-3-021	1R14-124
566-20-7-154	566-26-3-078	1R13-176	566-20-7-221	566-24-3-163	1R12-401
566-20-7-154	566-26-3-073	1R13-159	566-20-7-223	566-28-3-015	1R14-167
566-20-7-156	566-24-3-076	1R12-636	566-20-7-223	566-24-3-120	1R12-406
566-20-7-156	566-24-3-076	1R12-614	566-20-7-230	566-26-3-055	1R13-130
566-20-7-156	566-24-3-076	1R12-600	566-20-7-230	566-28-3-015	1R14-205
566-20-7-156	566-24-3-076	1R12-512	566-20-7-231	566-26-3-056	1R13-133
566-20-7-156	566-24-3-076	1R12-445	566-20-7-233	566-24-3-038	1R12-419
566-20-7-156	566-24-3-076	1R12-437	566-20-7-235	566-26-3-071	1R13-208
566-20-7-156	566-22-3-143	1R11-223	566-20-7-235	566-26-3-071	1R13-152
566-20-7-156	566-22-3-143	1R11-121	566-20-7-235	566-24-3-066	1R12-568
566-20-7-156	566-22-3-084	1R11-249	566-20-7-235	566-24-3-038	1R12-567
566-20-7-156	566-22-3-021	1R11-207	566-20-7-235	566-24-3-097	1R12-532
566-20-7-158	566-24-3-076	1R12-655	566-20-7-235	566-24-3-076	1R12-505
566-20-7-158	566-24-3-097	1R12-644	566-20-7-235	566-24-3-038	1R12-502
566-20-7-158	566-24-3-066	1R12-613	566-20-7-235	566-24-3-097	1R12-481
566-20-7-158	566-24-3-097	1R12-592	566-20-7-235	566-24-3-066	1R12-480
566-20-7-158	566-24-3-038	1R12-584	566-20-7-235	566-24-3-038	1R12-441
566-20-7-158	566-24-3-097	1R12-450	566-20-7-235	566-24-3-163	1R12-069
566-20-7-158	566-24-3-097	1R12-446	566-20-7-235	566-22-3-042	1R11-252
566-20-7-158	566-24-3-038	1R12-438	566-20-7-235	566-22-3-143	1R11-166
566-20-7-158	566-24-3-038	1R12-436	566-20-7-235	566-24-3-076	1R12-676
566-20-7-158	566-24-3-076	1R12-421	566-20-7-236	566-24-3-097	1R12-622
566-20-7-158	566-24-3-066	1R12-607	566-20-7-236	566-24-3-163	1R12-538
566-20-7-158	566-24-3-116	1R12-534	566-20-7-236	566-24-3-038	1R12-535
566-20-7-158	566-28-3-043	1R14-222	566-20-7-236	566-24-3-165	1R12-523
566-20-7-158	566-24-3-097	1R12-1048	566-20-7-236	566-24-3-090	1R12-507
566-20-7-159	566-24-3-066	1R12-653	566-20-7-236	566-24-3-165	1R12-432
566-20-7-159	566-24-3-066	1R12-639	566-20-7-236	566-24-3-066	1R12-689
566-20-7-159	566-24-3-090	1R12-637	566-20-7-236	566-24-3-097	1R12-1049
566-20-7-159	566-24-3-097	1R12-621	566-20-7-237	566-26-3-071	1R13-153
566-20-7-159	566-24-3-090	1R12-609	566-20-7-237	566-24-3-038	1R12-586
566-20-7-159	566-24-3-090	1R12-599	566-20-7-237	566-24-3-066	1R12-504
566-20-7-159	566-24-3-038	1R12-576	566-20-7-237	566-24-3-097	1R12-498
566-20-7-159	566-24-3-066	1R12-444	566-20-7-237	566-24-3-066	1R12-439
566-20-7-159	566-24-3-090	1R12-363	566-20-7-237	566-20-3-021	1R10-122
566-20-7-159	566-24-3-090	1R12-256	566-20-7-238	566-24-3-038	1R12-640
566-20-7-163	566-24-3-165	1R12-375	566-20-7-238	566-24-3-067	1R12-571
566-20-7-163	566-24-3-038	1R12-366	566-20-7-238	566-24-3-038	1R12-499
566-20-7-164	566-24-3-076	1R12-434	566-20-7-239	566-24-3-076	1R12-648
566-20-7-164	566-24-3-076	1R12-367	566-20-7-239	566-24-3-076	1R12-620
566-20-7-164	566-24-3-067	1R12-309	566-20-7-239	566-24-3-067	1R12-487
566-20-7-181	566-28-3-020	1R14-176	566-20-7-239	566-22-3-143	1R11-191
566-20-7-181	566-28-3-031	1R14-127	566-20-7-239	566-22-3-143	1R11-149

*The prefixes ASC, ASD, AS3 OR AS4 may be used interchangeably with 566 and may appear on some flex members or pistons.

PISTON INDEX (Cont.)

Piston Number	Flexible Member No.	Air Spring Number	Piston Number	Flexible Member No.	Air Spring Number
566-20-7-240	566-24-3-038	1R12-545	566-20-7-287	566-22-3-021	1R11-219
566-20-7-240	566-24-3-048	1R12-511	566-20-7-287	566-22-3-021	1R11-268
566-20-7-240	566-24-3-038	1R12-396	566-20-7-296	566-26-3-081	1R13-109
566-20-7-240	566-24-3-048	1R12-304	566-20-7-296	566-26-3-081	1R13-097
566-20-7-240	566-24-3-048	1R12-284	566-20-7-299	566-24-3-117	1R12-580
566-20-7-240	566-24-3-024	1R12-127	566-20-7-303	566-24-3-097	1R12-647
566-20-7-240	566-22-3-049	1R11-189	566-20-7-303	566-24-3-164	1R12-615
566-20-7-240	566-22-3-143	1R11-170	566-20-7-304	566-28-3-043	1R14-182
566-20-7-240	566-22-3-143	1R11-147	566-20-7-308	566-22-3-073	1R11-224
566-20-7-240	566-22-3-143	1R11-143	566-20-7-314	566-26-3-078	1R13-188
566-20-7-240	566-20-3-023	1R10-137	566-20-7-322	566-24-3-108	1R12-603
566-20-7-240	566-20-3-021	1R10-133	566-20-7-323	566-28-3-042	1R14-232
566-20-7-240	566-20-3-021	1R10-127	566-20-7-325	566-26-3-068	1R13-118
566-20-7-240	566-20-3-021	1R10-120	566-20-7-327	566-28-3-021	1R14-215
566-20-7-240	566-20-3-021	1R10-118	566-20-7-327	566-26-3-051	1R13-039
566-20-7-240	566-20-3-021	1R10-105	566-20-7-328	566-22-3-143	1R11-267
566-20-7-240	566-20-3-021	1R10-099	566-20-7-328	566-22-3-076	1R11-266
566-20-7-240	566-20-3-021	1R10-091	566-20-7-334	566-28-3-015	1R14-198
566-20-7-240	566-20-3-021	1R10-089	566-20-7-334	566-28-3-024	1R14-179
566-20-7-240	566-20-3-021	1R10-087	566-20-7-334	566-28-3-042	1R14-175
566-20-7-240	566-20-3-022	1R10-019	566-20-7-334	566-28-3-015	1R14-108
566-20-7-240	566-22-3-143	1R11-094	566-20-7-334	566-28-3-015	1R14-052
566-20-7-240	566-20-3-021	1R10-165	566-20-7-334	566-28-3-065	1R14-039
566-20-7-246	566-24-3-038	1R12-462	566-20-7-334	566-28-3-015	1R14-038
566-20-7-246	566-24-3-097	1R12-424	566-20-7-334	566-28-3-015	1R14-037
566-20-7-246	566-24-3-038	1R12-423	566-20-7-334	566-26-3-069	1R13-151
566-20-7-246	566-24-3-097	1R12-404	566-20-7-334	566-26-3-054	1R13-120
566-20-7-246	566-24-3-097	1R12-402	566-20-7-334	566-28-3-015	1R14-216
566-20-7-246	566-24-3-038	1R12-400	566-20-7-334	566-26-3-015	1R14-155
566-20-7-250	566-22-3-143	1R11-169	566-20-7-334	566-28-3-015	1R14-094
566-20-7-251	566-24-3-076	1R12-616	566-20-7-334	566-28-3-015	1R14-042
566-20-7-251	566-24-3-067	1R12-562	566-20-7-377	566-24-3-140	1R12-403
566-20-7-251	566-24-3-061	1R12-539	566-20-7-387	566-20-3-021	1R10-171
566-20-7-251	566-24-3-061	1R12-531	566-20-7-392	566-22-3-143	1R11-273
566-20-7-251	566-24-3-061	1R12-530	566-20-7-413	566-24-3-142	1R12-1047
566-20-7-251	566-24-3-067	1R12-508	579-08-7-157		1S5-057
566-20-7-251	566-22-3-021	1R11-203	579-08-7-215		1S6-036
566-20-7-252	566-24-3-067	1R12-563	579-08-7-219		1S4.5-113
566-20-7-252	566-24-3-067	1R12-559	579-08-7-301	579-10-1-083	1S5-186
566-20-7-252	566-24-3-067	1R12-558	579-16-7-103	579-16-1-002	1S8-003
566-20-7-252	566-24-3-067	1R12-557	AS3-08-7-006		1S5-157
566-20-7-252	566-24-3-067	1R12-556	ASB-06-7-014		1S3-011
566-20-7-252	566-22-3-021	1R11-242	ASB-08-7-079		1S6-023
566-20-7-252	566-22-3-021	1R11-202	ASB-08-7-134		1S5-070
566-20-7-252	566-22-3-021	1R11-201	ASC-06-7-017		1S3-013
566-20-7-252	566-22-3-021	1R11-200	ASC-08-7-005		1S5-006
566-20-7-253	566-24-3-067	1R12-561	ASC-08-7-005		1S5-005
566-20-7-253	566-24-3-067	1R12-560	ASC-08-7-005		1S4-008
566-20-7-253	566-24-3-067	1R12-555	ASC-08-7-093		1S4-030
566-20-7-253	566-22-3-143	1R11-241	ASC-08-7-134		1S4-074
566-20-7-253	566-22-3-057	1R11-225	ASC-08-7-137		1S5-173
566-20-7-253	566-22-3-021	1R11-205	ASC-08-7-137		1S5-040
566-20-7-253	566-22-3-021	1R11-204	ASC-08-7-137		1S4-067
566-20-7-257	566-22-3-068	1R11-216	ASC-08-7-137		1S4-016
566-20-7-257	566-22-3-075	1R11-176	ASC-08-7-137		1S5-164
566-20-7-257	566-22-3-060	1R11-175	ASC-08-7-137		1S4-173
566-20-7-274	566-28-3-057	1R14-236	ASC-08-7-139		1S5-045
566-20-7-274	566-26-3-095	1R13-235	ASC-08-7-139		1S5-010
566-20-7-276	566-28-3-021	1R14-218	ASC-08-7-139		1S4-058
566-20-7-276	566-28-3-021	1R14-177	ASC-08-7-139		1S4-007
566-20-7-277	566-26-3-097	1R13-237	ASC-08-7-157		1S5-135
566-20-7-277	566-28-3-059	1R14-240	ASC-08-7-157		1S5-133
566-20-7-286	566-22-3-021	1R11-222	ASC-08-7-157		1S4.5-179
566-20-7-286	566-22-3-021	1R11-220	ASC-08-7-157		1S4.5-121
566-20-7-287	566-22-3-021	1R11-221	ASC-08-7-157		1S4-175

*The prefixes ASC, ASD, AS3 OR AS4 may be used interchangeably with 566 and may appear on some flex members or pistons.

PISTON INDEX (Cont.)

Piston Number	Flexible Member No.	Air Spring Number	Piston Number	Flexible Member No.	Air Spring Number
ASC-08-7-157		1S4-123			
ASC-08-7-163		1S4-035			
ASC-08-7-163		1S5-032			
ASC-08-7-194		1S5-120			
ASC-08-7-194		1S5-061			
ASC-08-7-194		1S5-055			
ASC-08-7-194		1S5-038			
ASC-08-7-194		1S4.5-107			
ASC-08-7-194		1S4.5-073			
ASC-08-7-194		1S4-056			
ASC-08-7-194		1S4-044			
ASC-08-7-213		1S5-154			
ASC-08-7-213		1S5-122			
ASC-08-7-215		1S6-046			
ASC-08-7-215		1S6-033			
ASC-08-7-215		1S6-031			
ASC-08-7-215		1S6-055			
ASC-08-7-219		1S5-152			
ASC-08-7-219		1S5-072			
ASC-08-7-219		1S5-060			
ASC-08-7-219		1S4-042			
ASC-08-7-223		1S6-026			
ASC-08-7-232		1S5-174			
ASC-08-7-277	579-10-1-115	1S5-176			
ASC-08-7-277	579-10-1-116	1S5-175			
Not Included	566-18-3-004	1R9-047			
Not Included	566-28-3-020	1R14-060			
Not Included	566-28-3-020	1R14-031			
Not Included	566-28-3-021	1R14-029			
Not Included	566-28-3-021	1R14-027			
Not Included	566-28-3-020	1R14-025			
Not Included	566-28-3-021	1R14-024			
Not Included	566-26-3-051	1R13-049			
Not Included	566-26-3-072	1R13-048			
Not Included	566-24-3-038	1R12-394			
Not Included	566-24-3-066	1R12-113			
Not Included	566-24-3-067	1R12-097			
Not Included	566-24-3-038	1R12-093			
Not Included	566-20-3-021	1R10-085			
Not Included	566-20-3-022	1R10-030			

*The prefixes ASC, ASD, AS3 OR AS4 may be used interchangeably with 566 and may appear on some flex members or pistons.

CROSS REFERENCE INFORMATION

Competitor No.	Our No.	Competitor No.	Our No.	Competitor No.	Our No.	Competitor No.	Our No.	Competitor No.	Our No.
AM GENERAL		64544	2B14-359	FD200-25428	2B9-255	FT330-29520	3B12-335	1110-5-21A31	1R13-038
Air Spring Rolling Lobe		64545	2B14-356	FD200-25429	2B9-251	FT330-29525	3B12-312	1110-5-21A31	1R14-045
5973923	1R9-003	64546	2B14-355	FD200-25453	2B9-218	FT330-29546	3B12-328	11105-21A313	1R13-038
5973924	1R12-076	64547	2B14-367	FD200-25-454	2B9-266	FT330-29547	3B12-315	11105-21A313	1R14-045
AMERICAN CARRIER		64548	2B14-354	FD200-25454	2B9-252	FT330-29547	3B12-329	1110-5-21A31	1R14-030
Air Spring Bellows		64549	2B9-250	FD200-25454	2B9-266	FT330-29554	3B12-415	11105-21A318	1R14-030
8003005	2B14-355	64550	2B9-253	FD200-25463	2B9-254	FT330-29723	3B12-335	1110-5-21A36	1R14-018
8003006	2B8-550	64551	2B9-255	FD330-22313	2B12-309	FT530-32325	3B14-359	11105-21A369	1R14-019
8003007	1B14-351	64552	2B9-251	FD330-22318	2B12-307	FT530-32329	3B14-356	1110-5-21A37	1R14-019
AMERICAN CARRIER		64553	2B9-218	FD330-22323	2B12-305	FT530-32333	3B14-360	11105-21A370	1R14-019
Air Spring Rolling Lobe		64554	2B9-252	FD330-22327	2B12-300	FT530-32336	3B14-354	1110-5-21A96	1R14-201
8003003	1R11-171	64554	2B9-266	FD330-22331	2B12-406	FT530-35436	3B14-453	1110-5-22A53	1R14-174
8003023	1R11-161	64555	2B9-254	FD330-22334	2B12-320	FT530-35441	3B14-452	11105-22A530	1R14-174
AUTO BUS		64560	3B12-319	FD330-22343	2B12-427	FT530-35455	3B14-364	1110-5-22A75	1R14-170
Air Spring Rolling Lobe		64562	3B12-300	FD330-22346	2B12-410	FT530-35455	3B14-457	11105-22A752	1R14-170
10530087	1R10-089	64563	3B12-301	FD330-22363	2B12-425	FT530-35456	3B14-451	1110-5-22S71	1R14-127
CHANCE BUS		64565	3B12-310	FD330-22364	2B12-313	FT530-35457	3B14-367	11105-22S712	1R14-127
Air Spring Rolling Lobe		64568	3B12-304	FD330-22365	2B12-426	FT530-35457	3B14-459	1110-5-22S75	1R14-113
23891728	1R11-152	64570	3B12-335	FD330-22367	2B12-319	FT530-35534	3B14-464	11105-22S750	1R14-113
CONTITECH		64571	3B12-312	FD330-22368	2B12-432	CONTITECH		11105-22S764	1R14-113
Air Spring Bellows		64572	3B12-328	FD330-22465	2B12-432	Air Spring Rolling Lobe		1110-5A-16P5	1R14-171
64267	2B9-200	64573	3B12-315	FD330-22471	2B12-412	1010-15P453	1R13-159	11105A-16P5	1R14-171
64268	2B12-406	64573	3B12-329	FD330-22472	2B12-411	1010-15S518	1R13-097	1110-5C-16A3	1R14-039
64270	2B12-309	64576	3B14-453	FD330-22500	2B12-304	1010-15S518	1R13-138	11105C-16A3	1R14-039
64283	2B12-300	64580	3B14-452	FD330-22540	2B12-463	1010-15S522	1R13-124	1110-5C-16A3	1R14-042
64284	2B12-440	64581	3B14-364	FD330-22780	2B12-429	1010-15S711	1R13-124	11105C-16A3	1R14-042
64285	3B12-303	64581	3B14-457	FD330-30323	2B12-305	1010-15S713	1R13-207	1110-5C-16A7	1R14-198
64488	2B12-307	64582	3B14-451	FD330-30340	2B12-324	1010-15S773	1R13-210	1110-5C-16A7	1R14-155
64489	2B12-320	64583	3B14-367	FD330-30369	2B12-416	1010-15S871	1R13-109	11105C-16A7	1R14-039
64491	2B12-427	64583	3B14-459	FD330-30369	2B12-446	1010-15S962	1R13-097	1110-5F-17P7	1R14-172
64492	2B12-410	64587	3B14-464	FD330-30370	2B12-402	1010-16-5S78	1R13-039	1110-5F-17P7	1R14-190
64493	2B12-425	64589	2B14-366	FD330-30371	2B12-434	1010-16S783	1R13-039	11105F-17P74	1R14-172
64494	2B12-313	64590	2B14-365	FD330-30372	2B12-428	1010-16S526	1R13-177	11105F-17P74	1R14-190
64495	2B12-426	64593	2B14-462	FD330-30464	2B12-434	1010-16S533	1R13-176	34690	1R14-170
64497	2B12-319	64595	1B12-301	FD330-30502	2B12-317	1010-16S724	1R13-155	4811NP04	1R14-030
64498	2B12-432	64596	1B12-313	FD330-30513	2B12-324	1010-21P434	1R13-118	64252	1R13-152
64499	2B12-412	64597	2B12-345	FD331-26480	2B12-440	1010-21P486	1R13-153	64253	1R14-038
64500	2B12-411	64599	2B12-346	FD331-26514	2B12-345	1010-21P570	1R13-152	64254	1R14-039
64501	2B12-304	64601	2B8-550	FD331-26-541	2B12-346	1010-21P774	1R13-208	64255	1R11-028
64502	2B12-463	64604	2B14-383	FD331-26541	2B12-346	1010-5-15P46	1R13-159	64256	1R11-242
64503	3B14-359	64605	2B14-476	FD530-22311	2B14-360	10105-15P460	1R13-159	64258	1R12-352
64504	3B14-356	64606	2B14-470	FD530-22316	2B14-359	1010-5AV-12P	1R13-130	64258	1R12-421
64505	3B14-360	66094	2B6-535	FD530-22321	2B14-356	1010B-13S51	1R13-130	64259	1R12-182
64506	3B14-354	66300	2B12-429	FD530-22342	2B14-355	1110-5-15A41	1R14-037	64260	1R12-095
64509	2B9-239	66522	3B12-415	FD530-22345	2B14-367	11105-15A414	1R14-037	64262	1R12-090
64510	2B9-206	67667	2B7-548	FD530-22374	2B14-354	1110-5-15A41	1R14-038	64263	1R12-538
64511	2B9-210	67705	2B10-226	FD530-30449	2B14-366	11105-15A415	1R14-038	64264	1R12-404
64512	2B9-265	FD110-15766	2B6-535	FD530-30451	2B14-365	1110-5-15A42	1R13-120	64265	1R12-403
64512	2B9-280	FD110-17A77	2B7-548	FD530-30532	2B14-462	11105-15A422	1R13-120	64266	1R12-603
64513	2B9-230	FD120-20509	2B8-550	FD530-35530	2B14-383	1110-5-17A31	1R14-028	64269	1R12-092
64514	2B9-246	FD200-19310	2B9-239	FD530-35543	2B14-476	11105-17A316	1R14-028	64269	1R12-509
64515	2B9-201	FD200-19315	2B9-206	FD530-35544	2B14-470	1110-5-17A36	1R14-026	64273	1R13-038
64516	2B9-288	FD200-19320	2B9-200	FD530-35720	2B14-462	11105-17A364	1R14-026	64273	1R14-045
64517	2B9-229	FD200-19362	2B9-210	FS330-11468	1B12-301	11105-17A365	1R14-018	64274	1R12-069
64519	2B9-245	FD200-19448	2B9-252	FS330-11474	1B12-313	1110-5-17A36	1R14-028	64274	1R12-669
64521	1B14-358	FD200-19448	2B9-265	FS530-14339	1B14-358	11105-17A366	1R14-028	64274	1R12-676
64523	1B14-350	FD200-19448	2B9-280	FS530-14442	1B14-350	1110-5-17A36	1R14-115	64275	1R12-188
64524	1B14-351	FD200-19450	2B9-230	FS530-14446	1B14-351	11105-17A367	1R14-115	64276	1R12-365
64525	1B14-351	FD200-19452	2B9-246	FS530-14447	1B14-351	1110-5-17A37	1R13-047	64277	1R12-424
64531	2B12-305	FD200-19499	2B9-201	FT330-29413	3B12-319	1110-5-17A37	1R14-160	64278	1R12-481
64532	2B12-324	FD200-19504	2B9-288	FT330-29431	3B12-300	11105-17A377	1R14-160	64279	1R12-103
64533	2B12-416	FD200-19505	2B9-229	FT330-29432	3B12-301	1110-5-17A40	1R14-159	64286	1R11-150
64533	2B12-446	FD200-19510	2B9-245	FT330-29434	3B12-303	11105-17A405	1R14-159	64287	1R13-119
64534	2B12-402	FD200-19713	2B10-226	FT330-29466	3B12-310	1110-5-17A50	1R14-130	64287	1R13-239
64535	2B12-434	FD200-22524	2B10-226	FT330-29469	3B12-300	11105-17A507	1R14-130	64288	1R12-375
64536	2B12-428	FD200-22706	2B9-229	FT330-29498	3B12-301	1110-5-19A43	1R14-137	64290	1R12-401
64539	2B12-317	FD200-25426	2B9-250	FT330-29503	3B12-304	11105-19A431	1R14-137	64291	1R12-335
64543	2B14-360	FD200-25427	2B9-253	FT330-29508	3B12-312	1110-5-19A96	1R14-151	64292	1R12-155

Competitor No.	Our No.	Competitor No.	Our No.	Competitor No.	Our No.	Competitor No.	Our No.	Competitor No.	Our No.
CONTITECH		64397	1R13-124	64688	1R14-113	910-12A341	1R12-132	910-175P406	1R12-424
Air Spring Rolling Lobe (cont.)		64398	1R12-640	64708	1R12-534	910-12A343	1R12-132	910-17-5P418	1R12-450
64292	1R12-358	64399	1R12-498	64715	1R12-335	910-12A427	1R12-367	910-17-5P426	1R12-640
64293	1R12-621	64401	1R12-366	64716	1R12-256	910-12A488	1R12-487	910-17-5P428	1R12-498
64294	1R12-066	64402	1R12-502	64725	1R13-210	910-12A504	1R12-132	910-175P428	1R12-498
64297	1R12-356	64403	1R12-586	64728	1R13-208	910-12P024	1R12-562	910-17-5P429	1R12-481
64298	1R12-130	64405	1R12-499	64746	1R13-039	910-12P319	1R12-132	910-175P429	1R12-481
64301	1R12-220	64409	1R12-504	64761	1R12-613	910-12P329	1R12-355	910-17-5P436	1R12-366
64302	1R12-143	64410	1R12-402	64762	1R12-494	910-12P395	1R12-505	910-175P436	1R12-366
64304	1R12-441	64412	1R12-532	65356	1R12-357	910-12P484	1R12-508	910-175P440	1R12-403
64306	1R12-567	64415	1R12-554	65361	1R12-543	910-12P488	1R12-487	910-17-5P443	1R12-502
64310	1R12-400	64416	1R12-552	65361	1R12-636	910-12P495	1R12-571	910-175P443	1R12-502
64312	1R12-615	64417	1R12-553	65367	1R11-221	910-12P544	1R12-563	910-17-5P445	1R12-586
64314	1R12-436	64418	1R12-484	65387	1R12-467	910-13-5P874	1R12-1047	910-175P445	1R12-586
64323	1R12-167	64418	1R12-486	65389	1R11-222	910-13-5S433	1R13-119	910-175P451	1R12-404
64324	1R12-395	64419	1R13-153	65394	1R11-221	910-13-5S433	1R13-239	910-17-5P454	1R12-499
64325	1R12-145	64420	1R13-130	65593	1R14-172	910-135S433	1R13-239	910-175P454	1R12-499
64326	1R12-639	64421	1R14-171	65593	1R14-190	910-135S881	1R13-239	910-175P456	1R12-538
64327	1R12-261	64422	1R14-174	65649	1R12-609	910-14A330	1R12-370	910-17-5P502	1R12-504
64327	1R12-281	64423	1R11-252	65807	1R12-467	910-14A469	1R12-434	910-175P502	1R12-504
64329	1R12-480	64424	1R14-037	66109	1R11-268	910-14A496	1R12-437	910-175P519	1R12-403
64331	1R12-265	64428	1R13-120	66112	1R11-219	910-14A545	1R12-445	910-175P520	1R12-402
64331	1R12-446	64430	1R12-351	66113	1R11-220	910-14A545	1R12-492	910-175P521	1R12-401
64334	1R12-450	64431	1R12-359	66340	1R13-109	910-14A575	1R12-636	910-17-5P536	1R11-252
64335	1R12-195	64433	1R12-350	66-5-11S027	1R9-065	910-14A707	1R12-512	910-17-5P548	1R12-532
64336	1R12-403	64435	1R12-561	66-5-13S039	1R9-038	910-14AT75	1R12-543	910-175P548	1R12-532
64338	1R12-439	64436	1R12-560	66-5-13S056	1R9-003	910-14P312	1R12-069	910-17-5P571	1R12-554
64339	1R12-568	64437	1R12-559	66-5-13S446	1R9-070	910-14P312	1R12-669	910-175P571	1R12-554
64340	1R12-644	64438	1R12-558	66-5B-11S525	1R9-065	910-14P312	1R12-676	910-17-5P572	1R12-552
64342	1R14-028	64439	1R12-508	66908	1R12-432	910-14P345	1R12-352	910-175P572	1R12-552
64343	1R14-026	64440	1R12-465	67473	1R12-303	910-14P345	1R12-421	910-17-5P573	1R12-553
64344	1R14-018	64441	1R12-556	67479	1R12-142	910-14P450	1R12-205	910-175P573	1R12-553
64345	1R14-028	64443	1R12-508	67492	1R11-178	910-14P461	1R12-325	910-17-5P574	1R12-484
64346	1R14-115	64444	1R12-557	67547	1R14-151	910-14P462	1R12-438	910-17-5P574	1R12-486
64347	1R13-047	64445	1R12-132	67586	1R12-1048	910-14P465	1R12-620	910-175P574	1R12-484
64347	1R14-160	64446	1R12-309	67600	1R13-097	910-14P469	1R12-434	910-175P574	1R12-486
64349	1R14-159	64447	1R12-355	67625	1R14-201	910-14P490	1R12-648	910-175P714	1R12-486
64350	1R14-130	64451	1R12-505	67703	1R12-208	910-14P575	1R12-543	910-175P715	1R12-485
64352	1R14-030	64456	1R12-508	68009	1R12-562	910-14P709	1R12-285	910-18-5P406	1R12-424
64354	1R14-019	64459	1R12-487	68108	1R9-065	910-16A382	1R12-603	910-185P406	1R12-424
64357	1R14-042	64460	1R12-571	68119	1R9-065	910-16A999	1R12-603	910-18-5P440	1R12-403
64361	1R12-178	64463	1R12-563	68121	1R9-038	910-16P130	1R12-454	910-185P440	1R12-403
64362	1R11-204	64464	1R12-370	68123	1R9-070	910-16P310	1R12-092	910-18-5P451	1R12-404
64363	1R11-202	64472	1R12-205	68136	1R9-003	910-16P310	1R12-509	910-185P451	1R12-404
64364	1R11-149	64473	1R12-325	68151	1R12-1047	910-16P325	1R12-155	910-18-5P456	1R12-538
64365	1R11-200	64474	1R12-438	68207	1R12-603	910-16P325	1R12-358	910-185P456	1R12-538
64366	1R11-201	64475	1R12-620	68638	1R12-422	910-16P332	1R12-621	910-18-5P519	1R12-403
64367	1R11-159	64477	1R12-434	69075	1R12-454	910-16P333	1R12-066	910-185P519	1R12-403
64367	1R11-203	64479	1R12-648	910-10P311	1R12-095	910-16P350	1R12-092	910-18-5P520	1R12-402
64368	1R11-205	64484	1R12-437	910-10P328	1R12-351	910-16P352	1R12-356	910-185P520	1R12-402
64371	1R13-117	64486	1R12-445	910-10P331	1R12-359	910-16P353	1R12-130	910-18-5P521	1R12-401
64375	1R13-115	64486	1R12-492	910-10P339	1R12-350	910-16P372	1R12-220	910-185P521	1R12-401
64376	1R13-116	64615	1R12-281	910-10P397	1R12-561	910-16P376	1R12-143	910-195P801	1R12-467
64379	1R11-039	64627	1R11-171	910-10P398	1R12-560	910-16P391	1R12-441	910-19A358	1R12-261
64379	1R11-121	64628	1R14-198	910-10P399	1R12-559	910-16P393	1R12-567	910-19A358	1R12-281
64381	1R11-191	64631	1R11-179	910-10P400	1R12-558	910-16P407	1R12-090	910-19A552	1R12-613
64382	1R12-363	64632	1R12-285	910-10P471	1R12-435	910-16P408	1R12-182	910-19A801	1R12-467
64382	1R12-663	64633	1R12-512	910-10P471	1R12-508	910-16P409	1R12-188	910-19A830	1R12-467
64383	1R12-580	64636	1R13-176	910-10P473	1R12-465	910-16P410	1R12-365	910-19Pxxx	1R12-261
64384	1R12-256	64637	1R14-127	910-10P480	1R12-556	910-16P416	1R12-400	910-19P315	1R12-103
64385	1R12-637	64638	1R13-177	910-10P482	1R12-435	910-16P449	1R12-615	910-19P321	1R12-281
64386	1R11-166	64639	1R13-207	910-10P482	1R12-508	910-16P497	1R12-436	910-19P326	1R12-167
64388	1R10-120	64645	1R13-159	910-10P503	1R12-557	910-16P710	1R12-366	910-19P355	1R12-395
64389	1R10-122	64649	1R13-155	910-10P542	1R12-555	910-16P769	1R12-541	910-19P356	1R12-145
64391	1R14-137	64650	1R12-541	910-12A104	1R12-422	910-16P770	1R12-576	910-19P357	1R12-639
64394	1R13-118	64651	1R12-576	910-12A319	1R12-132	910-17-5A802	1R12-494	910-19P358	1R12-281
64395	1R12-367	64658	1R12-555	910-12A327	1R12-309	910-175A802	1R12-494	910-19P384	1R12-480
64396	1R13-138	64660	1R14-155	910-12A329	1R12-355	910-17-5A930	1R12-1048	910-19P390	1R12-265

Competitor No.	Our No.	Competitor No.	Our No.	Competitor No.	Our No.	Competitor No.	Our No.	Competitor No.	Our No.
CONTITECH		67636	1S5-040	354-7798	3B14-356	6800	2B14-362	7557	2B14-383
Air Spring Rolling Lobe (cont.)		67638	1S5-175	354-7800	3B14-360	6801	2B14-365	7782	2B14-470
910-19P390	1R12-446	67769	1S4-123	354-7818	3B14-359	6803	2B14-366	7788	2B9-245
910-19P435	1R12-375	67770	1S4-007	354-7847	3B14-367	6805	2B14-462	7790	2B12-324
910-19P438	1R12-195	67851	1S4.5-121	354-8008	3B12-300	6850	2B12-463	7795	2B10-226
910-19P439	1R12-357	67852	1S5-057	DAYTON		6897	2B9-229	7798	3B14-356
910-19P444	1R13-070	67858	1S4-058	Air Spring Rolling Lobe		6902	2B9-239	7800	3B14-360
910-19P470	1R12-439	67858	1S4-175	352-8050	1R14-039	6905	2B9-206	7808	3B14-354
910-19P472	1R12-568	67882	1S5-010	352-9039	1R12-095	6908	2B9-210	7816	3B14-359
910-19P552	1R12-644	68161	1S5-175	352-9053	1R12-309	6910	2B9-200	7818	3B14-359
910-19P762	1R12-534	68162	1S5-186	352-9069	1R12-069	6920	1B12-305	7838	3B14-453
910-19P801	1R12-467	SC29-0046	1S4-123	352-9069	1R12-669	6926	2B9-288	7839	3B14-456
910-19P946	1R12-142	SC29-0086	1S4-058	352-9073	1R11-018	6927	2B9-218	7843	3B14-457
910-19P973	1R12-208	SC29-0086	1S4-175	352-9082	1R12-092	6928	2B9-225	7846	3B14-451
910-21A361	1R12-335	SC29-O001	1S4-007	352-9082	1R12-509	6932	2B9-246	7847	3B14-459
910-21A505	1R12-256	SC29-W035	1S4.5-121	352-9083	1R12-066	6935	2B9-201	7850	3B14-452
910-21P360	1R12-363	SC29-W087	1S5-040	352-9096	1R12-358	6940	2B9-230	7855	3B14-462
910-21P360	1R12-663	SC29-Y036	1S5-186	352-9101	1R12-103	6941	2B9-280	7859	3B14-463
910-21P361	1R12-335	SC29-Y108	1S5-057	352-9105	1R12-132	6943	2B9-250	7862	3B14-464
910-21P448	1R12-580	SC29-YG01	1S5-010	352-9121	1R13-039	6944	2B9-252	7990	3B12-329
910-21P505	1R12-256	SC31-B207	1S5-175	352-9122	1R13-038	6945	2B9-253	7994	3B12-328
910-21P511	1R12-637	SC31-W206	1S5-176	352-9130	1R12-281	6946	2B9-254	7995	3B12-329
910-21P817	1R12-609	SC31-Y205	1S5-175	352-9148	1R14-026	6947	2B9-255	7996	3B12-335
910B-17-5A32	1R13-117	SC31-Y215	1S5-175	352-9149	1R14-018	6948	2B9-251	8006	3B12-304
910B-175A32	1R13-117	SZ70-5060P0	1S4-035	352-9158	1R14-030	7009	1B12-301	8008	3B12-300
910B-19-5P88	1R12-432	SZ70-5060P0	1S4-123	352-9177	1R14-028	7043	1B12-305	8010	3B12-301
910B-195P88	1R12-432	SZ70-5067	1S4-044	352-9194	1R12-356	7103	1B14-350	8018	3B12-303
910D-21A324	1R13-115	SZ70-7065P0	1S4.5-121	352-9200	1R14-038	7105	1B14-351	8025	3B12-300
910D-21A363	1R13-116	SZ70-8077P0	1S5-057	352-9203	1R12-395	7112	1B14-358	8027	3B12-310
910S-16A382	1R12-303	DANA/SPICER		352-9213	1R12-090	7119	2B9-240	8030	3B12-301
910S-16A382	1R12-603	Air Spring Rolling Lobe		352-9215	1R14-037	7123	2B14-367	8032	3B12-319
910S-16P382	1R12-303	SR1JA100	1R13-188	352-9238	1R12-145	7124	2B12-340	8033	3B12-312
99-10P538	1R11-222	SR1VA101	1R13-174	352-9321	1R12-261	7133	2B14-367	8038	3B12-415
99-10P576	1R11-221	SR1VA101-1	1R13-188	352-9415	1R11-018	7135	2B14-360	8039	3B12-416
99-10P862	1R11-220	SR1VA105	1R13-188	352-9422	1R11-028	7136	2B14-356	8042	3B12-322
99-12P314	1R11-028	DANA/SPICER		DINA		7140	2B14-359	8043	3B12-323
99-12P379	1R12-178	Air Spring Sleeve		Air Spring Bellows		7145	2B14-354	8047	3B12-326
99-12P401	1R11-204	SR1VA103	1S4-187	A-8127-19	2B9-200	7146	2B14-355	8048	3B12-325
99-12P447	1R11-202	DAYTON		AZ-8127-19	2B9-216	7180	2B12-425	W013586799	2B14-476
99-12P464	1R11-149	Air Spring Bellows		DINA		7181	2B12-411	W013586801	2B14-365
99-12P477	1R11-200	354-6801	2B14-365	Air Spring Rolling Lobe		7183	2B12-412	W013586803	2B14-366
99-12P478	1R11-201	354-6803	2B14-366	2027911C1	1R12-369	7184	2B12-429	W013586805	2B14-462
99-12P479	1R11-159	354-6902	2B9-201	224-B020018	1R13-133	7185	2B12-318	W013586850	2B12-463
99-12P479	1R11-203	354-6905	2B9-206	224-B020020	1R11-143	7325	2B8-550	W013586897	2B9-229
99-12P515	1R11-242	354-6910	2B9-200	224-B020030	1R10-099	7344	2B12-304	W013586902	2B9-239
99-12P516	1R11-205	354-6947	2B9-255	E-Z RIDE		7400	2B12-309	W013586905	2B9-206
99-12P563	1R11-150	354-7112	1B14-358	Air Spring Bellows		7401	2B12-320	W013586908	2B9-210
99-12P705	1R11-171	354-7123	2B14-367	8030120	2B9-206	7403	2B12-307	W013586910	2B9-200
99-14A322	1R11-018	354-7135	2B14-360	8030150	2B12-324	7404	2B12-410	W013586920	1B12-305
99-14A337	1R11-039	354-7136	2B14-356	8030160	2B14-365	7405	2B12-313	W013586926	2B9-288
99-14A337	1R11-121	354-7140	2B14-359	8030170	3B14-354	7406	2B12-426	W013586927	2B9-218
99-14A517	1R11-191	354-7145	2B14-354	8030180	3B14-359	7409	2B12-319	W013586928	2B9-225
99-14P517	1R11-191	354-7146	2B14-355	8030190	2B12-425	7410	2B12-406	W013586932	2B9-246
99-14P708	1R11-179	354-7181	2B12-411	E-Z RIDE		7423	2B12-432	W013586935	2B9-201
99-14P895	1R11-178	354-7183	2B12-412	Air Spring Rolling Lobe		7424	2B12-300	W013586940	2B9-230
99-9P537	1R11-221	354-7400	2B12-309	8030192	1R12-309	7429	2B12-427	W013586941	2B9-265
99-9P859	1R11-268	354-7403	2B12-307	FAB TEK		7437	2B12-320	W013586941	2B9-280
99-9P860	1R11-219	354-7404	2B12-410	Air Spring Bellows		7443	2B12-305	W013586943	2B9-250
99K-15P417	1R11-166	354-7405	2B12-313	40080	2B12-309	7444	2B12-416	W013586944	2B9-252
99K-15P424	1R10-120	354-7406	2B12-426	FAB TEK		7444	2B12-446	W013586944	2B9-266
99K-15P425	1R10-122	354-7409	2B12-319	Air Spring Rolling Lobe		7446	2B12-402	W013586945	2B9-253
99K-15P708	1R11-179	354-7410	2B12-406	101827	1R12-095	7447	2B12-324	W013586946	2B9-254
CONTITECH		354-7424	2B12-300	101828	1R12-092	7472	2B12-434	W013586947	2B9-255
Air Spring Sleeve		354-7429	2B12-427	101828	1R12-509	7473	2B12-428	W013586948	2B9-251
62561	1S4-044	354-7437	2B12-320	10828	1R12-309	7499	2B12-317	W013587008	1B12-313
62844	1S4-035	354-7443	2B12-305	FIRESTONE		7545	2B12-345	W013587009	1B12-301
67451	1S5-175	354-7446	2B12-402	Air Spring Bellows		7550	2B12-346	W013587043	1B12-305
67452	1S5-176	354-7447	2B12-324	6799	2B14-476	7555	2B12-440	W013587103	1B14-350

Competitor No.	Our No.	Competitor No.	Our No.	Competitor No.	Our No.	Competitor No.	Our No.	Competitor No.	Our No.
FIRESTONE		W013588018	3B12-303	9029	1R12-559	9303	1R12-132	9650	1R11-225
Air Spring Bellows (cont.)		W013588025	3B12-300	9031	1R12-350	9306	1R12-530	9675	1R11-221
W013587104	1B14-351	W013588027	3B12-310	9033	1R12-351	9307	1R12-435	9780	1R12-303
W013587105	1B14-351	W013588030	3B12-301	9039	1R12-095	9308	1R12-560	9781	1R12-603
W013587112	1B14-358	W013588032	3B12-319	9043	1R10-105	9320	1R12-363	9797	1R12-437
W013587119	2B9-240	W013588033	3B12-312	9053	1R12-309	9321	1R12-335	9807	1R12-1047
W013587123	2B14-367	W013588038	3B12-415	9067	1R10-089	9325	1R12-505	9921	1R12-502
W013587124	2B12-340	W013588039	3B12-416	9069	1R12-069	9332	1R12-561	9922	1R12-498
W013587133	2B14-367	W013588042	3B12-322	9069	1R12-669	9334	1R12-435	9923	1R12-481
W013587135	2B14-360	W013588043	3B12-323	9069	1R12-676	9335	1R12-620	9935	1R12-532
W013587136	2B14-356	W013588047	3B12-326	9070	1R12-370	9336	1R12-648	9936	1R12-499
W013587140	2B14-359	W013588048	3B12-325	9077	1R12-359	9346	1R12-439	9961	1R14-115
W013587145	2B14-354	FIRESTONE		9078	1R12-355	9348	1R12-357	9974	1R12-1048
W013587146	2B14-355	Air Spring Rolling Lobe		9082	1R12-092	9349	1R12-195	W013582119	1R9-065
W013587180	2B12-425	2119	1R9-065	9082	1R12-509	9362	1R12-441	W013585406	1R9-038
W013587181	2B12-411	5406	1R9-038	9083	1R12-066	9365	1R12-571	W013585409	1R9-003
W013587183	2B12-412	5409	1R9-003	9092	1R12-220	9366	1R12-487	W013585410	1R9-070
W013587184	2B12-429	5410	1R9-070	9093	1R12-621	9367	1R12-256	W013585435	1R9-003
W013587185	2B12-318	5503	1R14-174	9096	1R12-155	9370	1R12-580	W013585503	1R14-174
W013587325	2B8-550	5505	1R14-113	9096	1R12-358	9371	1R12-401	W013585505	1R14-113
W013587344	2B12-304	5710	1R8-034	9100	1R12-076	9373	1R12-403	W013585710	1R8-034
W013587400	2B12-309	5730	1R8-034	9101	1R12-103	9375	1R12-404	W013585730	1R8-034
W013587401	2B12-320	5739	1R11-088	9105	1R12-132	9376	1R11-200	W013585739	1R11-088
W013587403	2B12-307	5766	1R11-161	9113	1R12-132	9377	1R11-201	W013585766	1R11-161
W013587404	2B12-410	5770	1R10-101	9115	1R10-019	9378	1R11-202	W013585770	1R10-101
W013587405	2B12-313	5779	1R12-303	9121	1R13-039	9379	1R12-178	W013588050	1R14-039
W013587406	2B12-426	8050	1R14-039	9122	1R14-045	9380	1R10-091	W013588052	1R14-042
W013587409	2B12-319	8052	1R14-042	9127	1R12-512	9386	1R10-089	W013588091	1R14-171
W013587410	2B12-406	8091	1R14-171	9130	1R12-281	9387	1R11-159	W013588197	1R12-562
W013587423	2B12-432	8197	1R12-562	9134	1R14-137	9387	1R11-203	W013588204	1R12-508
W013587424	2B12-300	8204	1R12-508	9144	1R14-160	9392	1R12-143	W013588616	1R11-249
W013587429	2B12-427	8708	1R13-177	9148	1R14-026	9394	1R12-281	W013588708	1R13-177
W013587437	2B12-320	8709	1R13-159	9149	1R14-018	9415	1R11-018	W013588709	1R13-159
W013587443	2B12-305	8710	1R13-124	9152	1R14-019	9421	1R11-171	W013588710	1R13-124
W013587444	2B12-416	8713	1R13-176	9158	1R14-030	9422	1R11-028	W013588713	1R13-176
W013587444	2B12-446	8729	1R13-130	9164	1R14-159	9436	1R10-089	W013588729	1R13-130
W013587446	2B12-402	8748	1R13-152	9177	1R14-028	9439	1R11-039	W013588740	1R13-210
W013587447	2B12-324	8749	1R13-153	9179	1R14-028	9441	1R11-121	W013588746	1R13-208
W013587472	2B12-434	8751	1R13-159	9192	1R12-185	9447	1R11-066	W013588748	1R13-152
W013587473	2B12-428	8752	1R13-138	9194	1R12-356	9448	1R11-150	W013588749	1R13-153
W013587499	2B12-317	8754	1R13-053	9200	1R14-038	9457	1R11-151	W013588751	1R13-159
W013587545	2B12-345	8755	1R13-124	9203	1R12-395	9459	1R11-152	W013588752	1R13-138
W013587550	2B12-346	8778	1R14-130	9213	1R12-090	9466	1R12-365	W013588753	1R13-207
W013587555	2B12-440	8782	1R13-109	9215	1R14-037	9469	1R11-223	W013588754	1R13-053
W013587557	2B14-383	8792	1R14-045	9218	1R13-120	9471	1R12-504	W013588755	1R13-124
W013587782	2B14-470	8802	1R12-434	9219	1R12-182	9471	1R12-552	W013588774	1R14-172
W013587788	2B9-245	8805	1R12-438	9223	1R12-188	9472	1R12-553	W013588778	1R14-130
W013587790	2B12-324	8806	1R12-445	9227	1R12-130	9473	1R12-586	W013588782	1R13-109
W013587795	2B10-226	8829	1R12-615	9236HR	1R10-089	9476	1R11-205	W013588792	1R14-045
W013587798	3B14-356	8852	1R12-568	9238	1R12-145	9491	1R12-553	W013588802	1R12-434
W013587800	3B14-360	8899	1R10-108	9241	1R12-261	9501	1R12-552	W013588805	1R12-438
W013587808	3B14-354	8900	1R11-204	9243	1R12-480	9541	1R11-268	W013588806	1R12-445
W013587816	3B14-359	8901	1R11-149	9245	1R12-446	9542	1R11-268	W013588806	1R12-492
W013587818	3B14-359	8919	1R11-191	9250	1R13-115	9547	1R11-268	W013588829	1R12-615
W013587838	3B14-453	8924	1R12-436	9252	1R13-116	9565	1R12-324	W013588852	1R12-568
W013587843	3B14-457	8934	1R12-563	9262	1R13-118	9566	1R12-204	W013588855	1R12-644
W013587845	3B14-450	8944	1R12-366	9264	1R14-127	9567	1R12-325	W013588899	1R10-108
W013587846	3B14-451	8961	1R12-555	9265	1R12-375	9568	1R12-205	W013588900	1R11-204
W013587847	3B14-459	8964	1R12-556	9270	1R13-239	9580	1R13-118	W013588901	1R11-149
W013587850	3B14-452	8976	1R12-557	9275	1R13-117	9610	1R10-089	W013588903	1R11-252
W013587862	3B14-464	8986	1R12-558	9287	1R12-424	9616	1R11-242	W013588919	1R11-191
W013587990	3B12-329	8997	1R9-065	9291	1R10-122	9617	1R11-219	W013588924	1R12-436
W013587994	3B12-328	9010	1R12-421	9293	1R10-120	9618	1R11-220	W013588934	1R12-563
W013587995	3B12-329	9015	1R12-366	9295	1R11-166	9622	1R11-221	W013588944	1R12-366
W013587996	3B12-335	9017	1R10-085	9296	1R12-400	9625	1R11-222	W013588961	1R12-555
W013588006	3B12-304	9017	1R10-089	9297	1R12-402	9634	1R12-636	W013588963	1R12-465
W013588008	3B12-300	9018	1R12-304	9299	1R12-366	9640	1R12-367	W013588964	1R12-556
W013588010	3B12-301	9026	1R12-567	9302	1R12-132	9648	1R12-538	W013588976	1R12-557

Competitor No.	Our No.	Competitor No.	Our No.	Competitor No.	Our No.	Competitor No.	Our No.	Competitor No.	Our No.
FIRESTONE		W013589250	1R13-115	W013589491	1R12-553	7207	1S5-175	97-6694-1	1R14-101
Air Spring Rolling Lobe (cont.)		W013589252	1R13-116	W013589542	1R11-268	7215	1S5-175	97-9999-0218	1R12-383
W013588986	1R12-558	W013589264	1R14-127	W013589547	1R11-268	W023583000	1S3-013	T14-1035	1R14-124
W013588997	1R9-065	W013589265	1R12-375	W013589565	1R12-324	W023583001	1S3-013	FLXIBLE	
W013589010	1R12-352	W013589270	1R13-119	W013589566	1R12-204	W023584001	1S3-011	Air Spring Sleeve	
W013589010	1R12-421	W013589270	1R13-239	W013589567	1R12-325	W023587001	1S4-007	97-9999-0186 1S4-007	
W013589015	1R12-366	W013589275	1R13-117	W013589568	1R12-205	W023587002	1S4-007	FREIGHTLINER	
W013589017	1R10-085	W013589287	1R12-424	W013589580	1R13-118	W023587003	1S4-035	Air Spring Bellows	
W013589017	1R10-089	W013589291	1R10-122	W013589592	1R10-133	W023587007	1S4-067	16-10769-000	2B12-309
W013589018	1R12-304	W013589293	1R10-120	W013589610	1R10-089	W023587010	1S4-008	16-11378-000	2B12-406
W013589026	1R12-567	W013589295	1R11-166	W013589616	1R11-242	W023587014	1S5-006	16-14318-000	2B9-201
W013589029	1R12-559	W013589296	1R12-400	W013589617	1R11-219	W023587014	1S5-120	FREIGHTLINER	
W013589031	1R12-350	W013589297	1R12-402	W013589618	1R11-220	W023587017	1S5-006	Air Spring Rolling Lobe	
W013589033	1R12-351	W013589299	1R12-366	W013589622	1R11-221	W023587017	1S5-120	16-13810-000	1R12-303
W013589039	1R12-095	W013589302	1R12-132	W013589625	1R11-222	W023587031	1S4-007	16-13810-001	1R12-303
W013589053	1R12-309	W013589306	1R12-530	W013589634	1R12-636	W023587035	1S4.5-121	16-13810-002	1R12-303
W013589067	1R10-089	W013589307	1R12-508	W013589640	1R12-367	W023587036	1S5-186	16-14377-000	1R12-303
W013589069	1R12-069	W013589308	1R12-560	W013589648	1R12-538	W023587040	1S4-056	16-15595-000	1R12-303
W013589069	1R12-669	W013589320	1R12-363	W013589650	1R11-225	W023587042	1S5-006	16-15595-001	1R12-303
W013589069	1R12-676	W013589320	1R12-663	W013589675	1R11-221	W023587042	1S5-120	16-15595-002	1R12-303
W013589070	1R12-370	W013589321	1R12-256	W013589780	1R12-303	W023587044	1S5-006	16-16825-000	1R12-303
W013589077	1R12-359	W013589321	1R12-335	W013589781	1R12-603	W023587044	1S5-120	16-19465-000	1R12-603
W013589078	1R12-355	W013589325	1R12-505	W013589797	1R12-437	W023587046	1S4-123	16-19468-000	1R12-303
W013589082	1R12-092	W013589332	1R12-561	W013589807	1R12-1047	W023587050	1S4-035	18-18335-000	1R12-303
W013589082	1R12-509	W013589334	1R12-508	W013589902	1R12-640	W023587055	1S4-035	18-18335-001	1R12-303
W013589083	1R12-066	W013589335	1R12-620	W013589921	1R12-502	W023587056	1S4.5-113	6813200017	1R12-603
W013589092	1R12-220	W013589336	1R12-648	W013589922	1R12-498	W023587080	1S4.5-107	A16-14004-00	1R12-603
W013589093	1R12-621	W013589338	1R12-637	W013589923	1R12-481	W023587081	1S5-038	A16-14004-00	1R12-603
W013589096	1R12-155	W013589342	1R12-450	W013589935	1R12-532	W023587086	1S4-058	FREIGHTLINER	
W013589096	1R12-358	W013589346	1R12-439	W013589936	1R12-499	W023587087	1S5-040	Air Spring Sleeve	
W013589100	1R12-076	W013589348	1R12-357	W013589961	1R14-115	W023587108	1S5-057	18-29919-000	1S5-176
W013589101	1R12-103	W013589349	1R12-195	W013589974	1R12-1048	W023587110	1S5-152	18-40977-000	1S5-175
W013589102	1R12-113	W013589362	1R12-441	W015449542	1R11-268	W023587202	1S5-176	18-41909-0	1S5-173
W013589105	1R12-132	W013589365	1R12-571	W01W359385	1R11-178	W023587205	1S5-175	18-52651-000	1S5-175
W013589115	1R10-019	W013589366	1R12-487	W01W359465	1R11-179	W023587206	1S5-176	20-12461	1S4-030
W013589121	1R13-039	W013589367	1R12-256	W359060	1R12-285	W023587207	1S5-175	GYR1S5040	1S5-040
W013589122	1R14-045	W013589370	1R12-580	FIRESTONE		W023587215	1S5-175	GYR1S5045	1S5-045
W013589127	1R12-512	W013589371	1R12-401	Air Spring Sleeve		FLXIBLE		GYR1S6031	1S6-031
W013589130	1R12-281	W013589373	1R12-403	3000	1S3-013	Air Spring Bellows		FRUEHAUF	
W013589134	1R14-137	W013589375	1R12-404	3001	1S3-013	6-336-13	2B12-304	Air Spring Bellows	
W013589141	1R14-215	W013589376	1R11-200	4001	1S3-011	6-336-5	2B12-304	UAB-5620	2B12-411
W013589144	1R13-047	W013589377	1R11-201	7001	1S4-007	FLXIBLE		UCA-0112	2B12-412
W013589144	1R14-160	W013589378	1R11-202	7002	1S4-007	Air Spring Rolling Lobe		UCA-0112B	2B12-412
W013589148	1R14-026	W013589379	1R12-178	7003	1S4-035	6-304-156	1R8-034	UCC-3054-1	2B12-411
W013589149	1R14-018	W013589380	1R10-091	7007	1S4-067	6-304-157	1R10-089	FRUEHAUF	
W013589152	1R14-019	W013589386	1R10-089	7010	1S4-008	6-336-11	1R9-003	Air Spring Rolling Lobe	
W013589158	1R14-030	W013589387	1R11-159	7014	1S5-120	6-336-15	1R10-091	MFR-022354	1R12-359
W013589164	1R14-159	W013589387	1R11-203	7017	1S5-006	6-336-166	1R9-047	MFR-022355	1R12-355
W013589177	1R14-028	W013589392	1R12-143	7017	1S5-120	6-336-174	1R10-089	UCB-4453-1	1R12-359
W013589179	1R14-028	W013589394	1R12-281	7031	1S4-007	6-336-175	1R8-034	UCB-9668-1	1R12-355
W013589192	1R12-185	W013589415	1R11-018	7035	1S4.5-121	6-336-182	1R10-091	UCE-1304-1	1R12-155
W013589194	1R12-356	W013589421	1R11-171	7036	1S5-186	6-336-183	1R14-112	UCE-1304-1	1R12-358
W013589200	1R14-038	W013589422	1R11-028	7040	1S4-056	6-336-200	1R11-121	UCE-1304-2	1R12-309
W013589203	1R12-395	W013589436	1R10-089	7042	1S5-120	6-336-202	1R12-095	UCE-9393-1	1R12-281
W013589210	1R12-645	W013589439	1R11-039	7044	1S5-120	6-336-209	1R10-019	UCE-9393-3	1R12-281
W013589213	1R12-090	W013589441	1R11-121	7050	1S4-035	6-336-212	1R10-087	UCE-9393-4	1R12-281
W013589215	1R14-037	W013589447	1R11-066	7055	1S4-035	6-841-92	1R10-089	GILLIG	
W013589218	1R13-120	W013589448	1R11-150	7056	1S4.5-113	87-0808-0000	1R14-101	Air Spring Rolling Lobe	
W013589219	1R12-182	W013589457	1R11-151	7064	1S5-157	97-240-153	1R10-085	53-13187	1R11-121
W013589223	1R12-188	W013589459	1R11-152	7080	1S4.5-107	97-240-153	1R10-089	53-13188	1R14-018
W013589227	1R12-130	W013589466	1R12-365	7081	1S5-038	97-2410-0000	1R12-169	53-14006	1R11-121
W013589236	1R10-089	W013589469	1R11-223	7086	1S4-058	97-2410-1	1R12-169	53-20415-000	1R14-094
W013589238	1R12-145	W013589470	1R12-554	7087	1S5-040	97-2410-2	1R12-169	53-8212	1R11-121
W013589240	1R12-639	W013589471	1R12-504	7108	1S5-057	97-2410-3	1R12-169	87-17289	1R12-505
W013589241	1R12-142	W013589471	1R12-552	7110	1S5-152	97-2410-4	1R12-169	GMC	
W013589241	1R12-261	W013589472	1R12-553	7202	1S5-176	97-2410-5	1R12-169	Air Spring Bellows	
W013589243	1R12-480	W013589473	1R12-586	7205	1S5-175	97-5382-001	1R14-101	2076095	2B12-320
W013589245	1R12-446	W013589476	1R11-205	7206	1S5-176	97-6693-1	1R12-169	693230	2B12-309

Competitor No.	Our No.	Competitor No.	Our No.	Competitor No.	Our No.	Competitor No.	Our No.	Competitor No.	Our No.
GMC		8221	3B12-335	C-1013	2B12-309	C-20217	1R12-366	554784C1	2B9-201
Air Spring Bellows (cont.)		GRANNING		S-12405	3B12-319	C-20223	1R12-367	554785C1	2B12-300
711954	2B12-320	Air Spring Rolling Lobe		S-14795	3B12-323	C-20414	1R13-118	554786C1	2B12-305
GMC		1359	1R12-066	S-7853	3B14-451	C-20900	1R13-159	554787C1	2B12-307
Air Spring Rolling Lobe		1528	1R12-066	HENDRICKSON		C-20901	1R14-171	554788C1	2B12-309
10530086	1R8-034	1971	1R9-038	Air Spring Rolling Lobe		C-21208	1R13-239	554789C1	2B12-320
10530087	1R10-089	2112	1R9-070	1R13-102	1R13-239	C-21623	1R13-124	554790C1	2B12-324
10530087	1R10-090	2727	1R12-092	20413	1R12-375	C-21800	1R13-159	554791C1	2B12-402
15504181	1R12-511	2727	1R12-509	29892	1R13-118	C-21966	1R13-177	554792C1	2B12-406
15963160	1R12-424	5065	1R12-132	36514-1	1R14-030	C-22045	1R13-124	554793C1	2B12-410
2021085	1R9-038	5122	1R9-065	36514-12	1R14-042	C-22046	1R13-124	554794C1	2B12-411
2052623	1R14-112	B59	1R12-066	36514-13	1R14-039	C-22173	1R13-038	554795C1	2B12-412
2054879	1R14-112	HDA		36514-2	1R14-045	C-22948	1R13-176	554796C1	2B14-354
2090412	1R14-112	Air Spring Bellows		36514-3	1R12-132	C-25873	1R14-172	554797C1	2B14-355
2475408	1R10-019	PMABG-6902	2B9-201	36514-4	1R14-030	S-20010	1R13-119	554798C1	2B14-356
6617550	1R8-034	PMABG-6910	2B9-200	36514-7	1R12-092	S-20228	1R12-563	554799C1	2B14-359
661756	1R10-089	PMABG-7136	2B14-356	36514-7	1R12-509	S20901	1R14-171	554800C1	2B14-360
661756	1R10-090	PMABG-7140	2B14-359	36514-8	1R14-045	S-24445	1R14-240	554801C1	3B14-354
661759A	1R10-085	PMABG-7400	2B12-309	48195	1R12-188	S-24446	1R14-236	554802C1	3B14-356
661759C	1R10-085	PMABG-7401	2B12-320	49048	1R12-365	S-25559	1R13-239	554803C1	3B14-359
662743	1R9-003	PMABG-7403	2B12-307	49674	1R12-365	S-25871	1R13-237	554804C1	3B14-360
662744	1R10-091	PMABG-7424	2B12-300	50405	1R12-424	S-25872	1R13-235	INT'L/NAVISTAR	
667302	1R10-085	PMABG-7446	2B12-402	50405-1	1R12-424	S-29892	1R13-188	Air Spring Rolling Lobe	
667512A	1R9-038	PMABG-7798	3B14-356	50405-2	1R12-424	S-3467	1R13-038	1660581C1	1R12-090
667512C	1R9-038	HDA		50898-1	1R12-402	S-3830	1R13-038	1660694C1	1R12-178
667513A	1R10-030	Air Spring Rolling Lobe		50898-2	1R12-402	S6195	1R12-185	1670043C1	1R12-401
667513C	1R10-030	PMABG-9039	1R12-095	50899-1	1R12-404	HISTEER		1672401C1	1R12-204
672755	1R9-053	PMABG-9082	1R12-092	50899-2	1R12-404	Air Spring Bellows		1675495C1	1R12-205
677302	1R10-085	PMABG-9082	1R12-509	56917-1	1R12-620	10301	3B14-452	1681579C1	1R12-142
677302	1R10-089	PMABG-9105	1R12-132	56917-2	1R12-620	10302	2B9-252	1681737C1	1R12-145
684192	1R10-089	PMABG-9123	1R13-039	57122-1	1R12-403	10302	2B9-280	1681738C1	1R12-167
684192	1R10-090	PMABG-9177	1R14-028	65086-2	1R12-620	10303	3B12-303	1681739C1	1R12-182
684193	1R10-089	HENDRICKSON		B-11650	1R12-095	10303	3B12-416	1681740C1	1R12-167
684193	1R10-090	Air Spring Bellows		B-12353	1R12-220	10307	2B9-266	1681741C1	1R14-024
684195-3	1R10-089	1015	3B12-322	B-1245	1R12-132	10313	3B12-415	1681742C1	1R14-025
684242	1R10-019	1475	2B12-324	B-12514-004	1R14-030	10315	2B12-346	1681743C1	1R14-027
698634	1R8-034	1796	2B12-345	B-12514-008	1R13-038	10316	2B14-383	1681744C1	1R14-029
6989635	1R10-090	20018	2B12-440	B-12514-012	1R14-042	HOLLAND HITCH		1681745C1	1R14-031
716110	1R10-019	36514-5	2B12-434	B-14249	1R12-256	Air Spring Bellows		1681746C1	1R14-038
716111	1R9-038	45843-1	2B9-206	B-2063	1R14-030	4514	3B14-360	1681747C1	1R14-042
720414	1R10-030	45843-3	2B9-200	B-2064	1R12-095	HUTCHENS IND.		1681748C1	1R14-045
8870484	1R8-034	5079	2B7-548	B-2065	1R14-028	Air Spring Bellows		1681749C1	1R14-060
8870485	1R10-089	B-1080	2B14-356	B-2066	1R12-092	10384-01	2B12-313	1685174C1	1R14-039
8875032	1R10-085	B-1159	2B12-307	B-2066	1R12-509	HUTCHENS IND.		1686386C1	1R12-401
8875032	1R10-089	B-11637	3B12-300	B-22046	1R13-124	Air Spring Rolling Lobe		2013947C2	1R9-054
G1015009	1R12-511	B-12405	3B12-319	B-2394	1R9-065	19141-01	1R11-161	2013948C2	1R9-056
G1017370	1R14-112	B-12514-005	2B12-434	B-2694	1R12-395	9424-01	1R12-095	2027911C1	1R12-538
G1019449	1R10-085	B-12514-014	2B14-360	B-2827	1R12-352	9424-03	1R12-095	2027911C2	1R12-538
G1019450	1R10-090	B-1345	2B12-410	B-2924	1R12-130	9424-1	1R12-097	2027911C3	1R12-538
G1019452	1R10-087	B-14486	2B10-226	B-3411	1R13-039	9630-01	1R12-092	2027912C1	1R12-324
G1020956	1R12-511	B-14487	3B12-312	B-3467	1R14-045	9630-01	1R12-509	2027913C1	1R12-325
G1020957	1R10-090	B-2630	2B9-201	B-3648	1R14-037	9630-03	1R12-093	350243C94	1R12-432
G1050310	1R14-112	B-2734	2B14-365	B-3830	1R13-038	INT'L/NAVISTAR		3541732C1	1R12-523
G5008051	1R8-034	B-2883	2B12-307	B-3839	1R14-038	Air Spring Bellows		3541733C1	1R11-175
GRANNING		B-3184	2B14-359	B-3842	1R12-103	1681750C1	2B12-432	3596112C1	1R12-622
Air Spring Bellows		B-3518	2B9-206	B-4375	1R12-256	1681751C1	2B12-434	501559C1	1R12-090
1014	3B14-359	B-3798	2B12-402	B-4771	1R14-039	1685175C1	2B9-206	501559C2	1R12-090
1015	2B14-359	B-5270	2B9-206	B-4773	1R12-143	1685176C1	2B9-218	517096C91	1R12-220
1218	2B12-305	B-5468	2B12-410	B-5060	1R12-145	1685177C1	2B12-313	517559C9	1R12-092
1371	2B9-200	B-6242	2B12-324	B-7128	1R14-019	1685178C1	2B12-319	517559C9	1R12-509
1476	3B14-359	B-6412	2B14-366	B-7193	1R11-018	1685179C1	2B12-425	554761C1	1R11-018
1589	2B12-305	B-6861	3B14-359	B-8988	1R12-195	1685180C1	2B12-426	554762C1	1R11-028
1613	3B14-356	B-7100	3B14-364	B-9001	1R14-052	1685181C1	2B12-427	554763C1	1R12-066
1626	2B14-356	B-8701	2B9-255	C-10443	1R12-208	1685182C1	2B12-428	554764C1	1R12-069
2725	2B12-307	B-8768	2B9-200	C-13122	1R14-127	1685183C1	2B14-365	554764C1	1R12-669
2726	2B12-309	B-8874	3B14-367	C-20010	1R13-119	1685184C1	2B14-367	554765C1	1R12-093
4514	3B14-360	B-9830	2B12-416	C-20124	1R12-375	554782C1	1B14-358	554766C1	1R12-095
4848	2B9-201	B-9830	2B12-446	C-20127	1R13-118	554783C1	2B9-200	554767C1	1R12-097

Competitor No.	Our No.	Competitor No.	Our No.	Competitor No.	Our No.	Competitor No.	Our No.	Competitor No.	Our No.
INT'L/NAVISTAR		1101-0042	1S5-032	SC2040	1R13-039	MCI		5973877	1R9-003
Air Spring Rolling Lobe (cont.)		1101-0043	1S5-038	SC2041	1R13-038	Air Spring Bellows		5973923	1R9-003
554768C1	1R12-103	1101-0044	1S5-135	SC2042	1R14-026	12C-1-36	2B9-240	5993113	1R9-003
554769C1	1R12-113	1101-0045	1S5-133	SC2043	1R14-018	12C-3-52	2B12-340	65	1R12-285
554770C1	1R12-132	1101-0060	1S6-046	SC2044	1R14-019	MCI		9594	1R12-512
554772C1	1R13-038	1101-A042	1S5-032	SC2045	1R14-030	Air Spring Rolling Lobe		99865	1R11-179
554773C1	1R13-039	1102-0022	1S4-123	SC2046	1R14-028	12-01-1002	1R14-141	NEW HOLLAND	
554774C1	1R13-048	1102-0023	1S4-007	SC2047	1R14-037	12-01-1048	1R14-141	Air Spring Rolling Lobe	
554775C1	1R13-049	1102-0043	1S4.5-113	SC2048	1R12-090	12-01-1090	1R14-182	48100494	
554776C1	1R14-018	1102-0074	1S5-157	SC2049	1R11-018	12-01-1143	1R14-205	NEWAY	
554777C1	1R14-019	LOAD GUARD		SC2050	1R11-028	12-01-1249	1R14-216	Air Spring Bellows	
554778C1	1R14-026	Air Spring Bellows		SC2052	1R14-039	12-03-1029	1R14-106	570-07-180	2B12-425
554779C1	1R14-028	SC2010	2B9-201	SC2053	1R12-113	12-03-1041	1R11-115	905-57-001	2B14-360
554780C1	1R14-030	SC2011	2B9-200	SC2054	1R12-093	12-03-6034	1R11-143	905-57-002	1B12-301
554781C1	1R14-037	SC2012	1B14-358	SC2055	1R13-049	12-04-1158	1R14-222	905-57-014	2B12-300
INT'L/NAVISTAR		SC2013	2B14-360	SC2056	1R13-048	12-04-6007	1R12-545	905-57-015	2B12-320
Air Spring Sleeve		SC2014	2B14-356	SC2058	1R12-097	12C-1-126	1R12-288	905-57-016	2B12-309
1680378C1	1S4-076	SC2015	2B14-359	SC2070	1R12-182	12F-4-34	1R10-091	905-57-026	1B14-358
2012771C1	1S5-072	SC2016	2B14-354	SC2098	1R14-045	12G-1-60	1R12-304	905-57-028	1B14-358
KENWORTH		SC2017	2B14-355	SC2099	1R14-060	12J-1-23	1R12-139	905-57-039	2B14-355
Air Spring Rolling Lobe		SC2018	2B12-411	SC2108	1R12-142	12J-1-88	1R12-154	905-57-041	1B14-358
K-102-A	1R11-018	SC2019	2B12-412	SC2109	1R12-145	12J-3-53	1R11-047	905-57-203	2B14-476
K-303-14	1R11-028	SC2020	2B12-309	SC2110	1R12-178	12K-1-45	1R12-288	905-57-236	3B12-322
K-303-15	1R11-028	SC2022	2B12-410	SC2111	1R14-025	12K-3-11	1R12-156	905-57-237	2B9-250
K-303-16	1R11-242	SC2023	2B12-406	SC2112	1R14-024	12L-1-104	1R12-217	905-57-257	2B14-469
K-303-18	1R11-219	SC2024	2B12-300	SC2113	1R14-027	12L-1-126	1R12-288	AR-1520	2B14-355
K-303-19	1R11-220	SC2025	2B12-320	SC2114	1R14-029	12L-1-133	1R12-304	AR-1834	1B14-358
K-303-22	1R11-221	SC2026	2B12-305	SC2115	1R14-031	12L-1-135	1R12-304	TC-144-2	2B12-300
K-303-25	1R11-222	SC2027	2B12-402	SC2116	1R14-038	12L-1-136	1R12-217	TC-144-3A	2B12-320
K-303-28	1R11-221	SC2028	2B12-324	SC2120	1R12-256	12L-1-140	1R12-396	TC-144-4	2B12-309
K-303-5	1R11-018	SC2029	3B14-356	SC2121	1R14-042	12L-1-142	1R12-304	NEWAY	
K-303-6	1R11-028	SC2030	3B14-360	SC2776	1R13-070	12L-1-169	1R12-394	Air Spring Rolling Lobe	
KWIK-LOK/TODCO		SC2031	3B14-354	LOADAIR		12L-1-215	1R12-454	900-44-197	1R14-031
Air Spring Bellows		SC2032	3B14-359	Air Spring Bellows		12L-4-212	1R9-053	900-44-199	1R12-097
53671	2B14-367	SC2071	2B9-206	P10-754U	2B6-535	12L-4-261	1R10-091	900-44-200	1R12-093
CP-5223	2B12-427	SC2072	2B9-218	MACK TRUCK		12L-4-5	1R10-091	900-44-201	1R12-113
KWIK-LOK/TODCO		SC2073	2B12-313	Air Spring Bellows		12L-4-8	1R9-053	900-44-216	1R12-093
Air Spring Rolling Lobe		SC2074	2B12-319	227QS32	2B8-550	12M-4-6	1R10-091	900-44-647	1R12-093
CP-3281	1R12-092	SC2075	2B12-425	57QK1113	2B8-550	14002	1R11-200	900-44-653	1R12-113
CP-3281	1R12-509	SC2076	2B12-426	57QL239	2B14-354	1496372	1R10-099	900-44-658	1R13-048
CP-5125	1R12-092	SC2077	2B12-427	MACK TRUCK		1498928	1R11-189	900-44-668	1R13-048
CP-5125	1R12-509	SC2078	2B12-428	Air Spring Rolling Lobe		1510979	1R13-133	900-44-670	1R13-049
CP-5152	1R12-092	SC2079	2B14-365	20910892	1R12-647	1512076	1R11-143	900-44-701	1R12-103
CP-5152	1R12-509	SC2080	2B14-367	21244322	1R12-1049	2992101C1	1R12-403	900-44-702	1R13-049
LES AUTOBUS		SC2101	2B12-432	21669088	1R12-1049	39390246	1R10-101	900-44-708	1R12-097
Air Spring Rolling Lobe		SC2119	3B12-301	364SQ27	1R12-404	G1004846	1R12-212	900-54-218	1R12-113
10530086	1R8-034	SC2122	2B9-250	364SQ28	1R12-365	MERITOR		900-54-234	1R12-097
10530087	1R10-090	SC2123	2B9-251	57QL332	1R13-070	Air Spring Rolling Lobe		900-57-001	1R14-029
661759C	1R10-085	SC2124	2B9-252	57QL39306	1R13-070	202796	1R13-130	905-44-608	1R13-070
698934	1R8-034	SC2125	2B9-253	57QL411M	1R12-365	MILSCO		905-54-060	1R13-049
698935	1R10-090	SC2126	2B9-254	57QL414M	1R12-404	Air Spring Sleeve		905-57-003	1R14-028
G5001705	1R8-034	SC2127	2B9-255	57QL519M	1R12-647	07067A	1S5-057	905-57-005	1R14-030
G5008052	1R10-090	SC2128	2B12-434	57QL54M	1R12-615	MONOCO COACH		905-57-006	1R12-092
LES AUTOBUS		SC2129	2B14-366	MACK TRUCK		Air Spring Rolling Lobe		905-57-006	1R12-509
Air Spring Sleeve		SC2130	3B12-300	Air Spring Sleeve		14002	1R11-200	905-57-007	1R12-621
G5006637	1S3-011	SC2131	3B12-303	227QS310BM	1S6-026	NABI-HF		905-57-008	1R12-103
LINK CAB & SEAT SPRINGS		SC2132	3B12-304	227QS312BM	1S5-154	Air Spring Rolling Lobe		905-57-009	1R12-103
Air Spring Sleeve		SC2784	3B12-312	227QS33	1S4-007	5009273	1R14-218	905-57-011	1R12-095
1101-0001	1S3-011	LOAD GUARD		227QS34B	1S4-067	5014470	1R14-177	905-57-012	1R12-351
1101-0020	1S4-007	Air Spring Rolling Lobe		227QS38B	1S5-055	630-5056	1R12-505	905-57-019	1R13-039
1101-0021	1S4-008	SC2033	1R12-095	227QS39301	1S4-008	633-7773	1R12-487	905-57-020	1R13-038
1101-0023	1S4-044	SC2034	1R12-069	227QS47M	1S5-164	633-9668	1R11-249	905-57-023	1R12-095
1101-0024	1S4-056	SC2034	1R12-669	MASA		NEW FLYER		905-57-027	1R12-092
1101-0025	1S4-175	SC2035	1R12-092	Air Spring Bellows		Air Spring Rolling Lobe		905-57-027	1R12-509
1101-0030	1S4.5-073	SC2035	1R12-509	227002002	2B12-309	73	1R13-053	905-57-029	1R9-065
1101-0031	1S4.5-179	SC2036	1R12-066	227004001	2B9-201	14635	1R12-285	905-57-031	1R12-220
1101-0040	1S5-005	SC2038	1R12-103	227138412	2B9-200	55089	1R11-178	905-57-032	1R12-621
1101-0041	1S5-006	SC2039	1R12-132			5920815	1R9-003	905-57-034	1R9-065

Competitor No.	Our No.	Competitor No.	Our No.	Competitor No.	Our No.	Competitor No.	Our No.	Competitor No.	Our No.
NEWAY		AR-1115-1-G	1R13-039	03-07887	1R12-568	R & S TRUCK & BODY		1003588010C	3B12-301
Air Spring Rolling Lobe (cont.)		AR-1215-1-F	1R14-030	23-10042	1R12-069	Air Spring Rolling Lobe		1003588030C	3B12-301
905-57-035	1R12-621	AR-1215-1-G	1R13-038	23-10042	1R12-669	1090023	1R13-039	1006587437C	2B12-320
905-57-037	1R12-092	AR-1315-1-F	1R12-092	PETERBILT		1090216	1R14-028	S-1326-C	2B14-360
905-57-037	1R12-509	AR-1315-1-G	1R12-092	Air Spring Sleeve		1090217	1R12-092	S-1505-C	3B14-360
905-57-038-1	1R12-370	AR-1515-1	1R12-351	2903200	1S5-186	1090217	1R12-509	S-1728-C	2B9-201
905-57-052	1R13-039	AR-250-12	1R13-153	PEZZANI		1090218	1R12-095	S-2683-C	2B12-305
905-57-054	1R12-092	AR-250-14	1R13-152	Air Spring Bellows		1090276	1R12-132	S-2685-C	3B14-359
905-57-054	1R12-509	AR-250-15	1R13-152	AR-21-A	2B14-360	1090326	1R14-159	S-2845-C	2B9-206
905-57-069	1R14-030	AR-250-16	1R13-153	PREVOST		10907	1R12-261	S-3159-C	2B12-426
905-57-070	1R13-070	AR-250-17	1R13-153	Air Spring Bellows		REYCO		S-3363-C	2B12-320
905-57-071	1R13-038	AR-90112	1R12-370	63-0166	2B9-240	Air Spring Bellows		S-3364-C	1B14-358
905-57-075	1R12-092	NOVABUS		63-0173	2B9-200	12906-01	2B9-218	S-4302-C	2B12-307
905-57-075	1R12-509	Air Spring Rolling Lobe		63-0174	2B9-216	12906-02	2B9-218	S-4512-C	2B9-200
905-57-076	1R13-038	G1015009	1R12-511	63-0185	2B12-340	18813-01	2B12-440	S-4538-C	2B12-425
905-57-077	1R13-038	G1076863	1R10-105	PREVOST		19983-01	2B14-383	S-4540-C	2B14-354
905-57-078	1R13-039	G1202328	1R11-169	Air Spring Rolling Lobe		20018-01	2B12-440	S-4830-C	3B14-354
905-57-082	1R12-103	G1202651	1R11-169	360258	1R12-631	REYCO		S-5844-C	3B12-301
905-57-083	1R13-039	G1202652	1R11-169	63-0040	1R12-127	Air Spring Rolling Lobe		S-788-C	2B12-309
905-57-085	1R12-095	G1202944	1R12-511	63-0044	1R10-085	12882-01	1R12-092	RIDEWELL	
905-57-087	1R13-070	G5001705	1R8-034	63-0044	1R10-089	12882-01	1R12-509	Air Spring Rolling Lobe	
905-57-089	1R12-560	G5001706	1R8-034	63-0045	1R12-028	12882-02	1R13-039	1000001	1R12-467
905-57-090	1R12-370	N15558	1R10-085	63-0064	1R12-127	12883-01	1R12-103	1000002	1R14-127
905-57-097	1R11-225	N15558	1R10-089	63-0067	1R10-087	12883-02	1R13-038	1000006	1R14-151
905-57-099	1R12-363	N16374	1R11-121	63-0077	1R10-108	12884-01	1R12-188	1000008	1R14-175
905-57-102	1R14-170	N17842	1R11-130	63-0090	1R11-090	12884-01A	1R12-188	1001R12584G	1R12-584
905-57-103	1R14-113	N21361	1R12-422	63-0092	1R11-088	12928-01	1R12-421	1001R13-087	1R13-097
905-57-110	1R13-047	N35162	1R11-232	63-0093	1R11-243	17360-01	1R12-560	1001R13-097	1R13-097
905-57-111	1R14-159	N38168	1R10-120	63-0094	1R11-090	17361-01	1R11-204	1001R13-109	1R13-109
905-57-112	1R12-480	N39112	1R12-092	63-0099	1R11-243	17636-01	1R12-195	1003580725C	1R12-132
905-57-113	1R12-441	NOVABUS		63-0102	1R11-244	20074-01	1R12-561	1003585410C	1R9-070
905-57-117	1R12-502	Air Spring Sleeve		63-0104	1R11-088	20446-01	1R11-205	1003588752C	1R13-097
905-57-118	1R12-481	N12687	1S3-011	63-0105	1R11-243	21054-01	1R11-201	1003588802C	1R12-434
905-57-119	1R12-498	ORION		63-0106	1R11-090	21055-01	1R12-557	1003588802X	1R12-445
905-57-120	1R10-120	Air Spring Rolling Lobe		63-0109	1R11-109	21598-01	1R12-556	1003588805C	1R12-438
905-57-121	1R11-166	010132404-4	1R12-383	63-0125	1R12-631	23377-01	1R12-555	1003588919C	1R11-191
905-57-122	1R10-122	020117511-4	1R10-109	63-0126	1R11-244	23631-01	1R14-039	1003588924C	1R12-436
905-57-125	1R14-137	20117526	1R10-127	63-0129	1R11-097	RIDEWELL		1003588986C	1R12-558
905-57-126	1R12-439	20217501	1R11-147	63-0151	1R12-377	Air Spring Bellows		1003588997C	1R9-065
905-57-129	1R12-435	T14-1044	1R10-109	63-0158	1R10-087	1002B09270G	2B9-270	1003589010C	1R12-421
905-57-139	1R10-122	PEERLESS		63-0162	1R12-406	1003586801C	2B14-365	1003589029C	1R12-559
905-57-149	1R12-505	Air Spring Bellows		63-0178	1R12-145	1003586805C	2B14-462	1003589039C	1R12-095
905-57-152	1R12-586	0550-00001	2B12-425	63-0179	1R12-156	1003586850C	2B12-463	1003589053C	1R12-309
905-57-155	1R14-160	0550-00015	1B14-350	63-0180	1R12-288	1003586902C	2B9-239	1003589073C	1R11-018
905-57-156	1R12-499	0550-00030	3B14-354	63-0181	1R12-217	1003586905C	2B9-206	1003589082C	1R12-092
905-57-157	1R12-532	PEERLESS		63-0182	1R12-304	1003586910C	2B9-200	1003589082C	1R12-509
905-57-159	1R12-571	Air Spring Rolling Lobe		63-0183	1R12-396	1003586932C	2B9-246	1003589083C	1R12-066
905-57-160	1R12-487	0550-00010	1R14-018	63-0224	1R12-394	1003586945C	2B9-253	1003589101C	1R12-103
905-57-167	1R13-152	0550-00051	1R12-350	63-0226	1R8-034	1003586946C	2B9-254	1003589105C	1R12-132
905-57-168	1R13-153	0550-00060	1R14-024	63-0259	1R11-244	1003586947C	2B9-255	1003589121C	1R13-039
905-57-170	1R12-434	0550-00070	1R14-026	63-0260	1R11-243	1003586948C	2B9-251	1003589122C	1R13-038
905-57-173	1R12-508	0550-00080	1R14-019	PREVOST		1003587112C	1B14-358	1003589158C	1R14-030
905-57-179	1R12-586	0550-00081	1R14-019	Air Spring Sleeve		1003587135C	2B14-360	1003589177C	1R14-028
905-57-185	1R13-038	PETERBILT		95-0208	1S3-011	1003587136C	2B14-356	1003589200C	1R14-038
905-57-200	1R14-174	Air Spring Rolling Lobe		950208	1S3-013	1003587140C	2B14-359	1003589218C	1R13-120
905-57-209	1R13-120	03-01649	1R12-069	R & S TRUCK & BODY		1003587145C	2B14-354	1003589245C	1R12-446
905-57-210	1R12-487	03-01649	1R12-669	Air Spring Bellows		1003587146C	2B14-355	1003589250C	1R13-115
905-57-211	1R12-554	03-02038	1R12-069	1027405	2B9-200	1003587180C	2B12-425	1003589252C	1R13-116
905-57-212	1R12-552	03-02038	1R12-669	1027505	2B9-201	1003587400C	2B12-309	1003589275C	1R13-117
905-57-213	1R12-553	03-02456	1R12-069	1027519	2B12-309	1003587406C	2B12-426	1003589334C	1R12-435
905-57-214	1R12-485	03-02456	1R12-669	1027556	2B14-356	1003587437C	2B12-320	1003589378C	1R11-202
905-57-215	1R12-484	03-04759	1R12-069	1040201	2B12-307	1003587443C	2B12-305	1003589387C	1R11-203
905-57-216	1R12-486	03-04759	1R12-669	1082914	2B12-402	1003587473C	2B12-428	1003589447C	1R11-066
905-57-223	1R12-508	03-05107	1R12-359	1090201	2B12-307	1003587800C	3B14-360	1003589448C	1R11-150
905-57-225	1R12-487	03-06213	1R12-567	1090214	2B14-359	1003587808C	3B14-354	1003589457C	1R11-151
905-57-230	1R12-562	03-07111	1R12-567	1090215	2B12-300	1003587818C	3B14-359	1003589459C	1R11-152
905-57-275	1R12-543	03-07112	1R12-069	PREVOST		1003587839C	3B14-359	1003589797C	1R12-437
AR-1115-1-F	1R14-028	03-07112	1R12-669	Air Spring Bellows		1003588008C	3B12-300	1003589961C	1R14-115

Competitor No.	Our No.	Competitor No.	Our No.	Competitor No.	Our No.	Competitor No.	Our No.	Competitor No.	Our No.
RIDEWELL		TMC		4441	3B14-452	8337	1R11-039	8468	1R11-171
Air Spring Rolling Lobe (cont.)		Air Spring Rolling Lobe		4442	1B14-350	8339	1R12-350	8469	1R12-434
1013580702C	1R12-097	10530087	1R10-090	4447	1B14-351	8345	1R12-421	8470	1R12-439
1013580708C	1R11-018	661759C	1R10-085	4448	2B9-252	8352	1R12-356	8471	1R12-435
1013580712C	1R12-093	684192	1R10-090	4448	2B9-280	8353	1R12-130	8472	1R12-568
1013589039C	1R12-095	684193	1R10-090	4449	2B14-366	8355	1R12-395	8477	1R11-200
1013589102C	1R12-113	6989635	1R10-090	4450	2B9-230	8356	1R12-145	8478	1R11-201
1013589123C	1R13-049	G1020957	1R10-090	4451	2B14-365	8358	1R12-261	8479	1R11-203
1013589124C	1R13-048	TOYO		4452	2B9-246	8360	1R12-363	8480	1R12-556
1013589154C	1R14-031	Air Spring Rolling Lobe		4453	2B9-218	8361	1R12-261	8482	1R12-435
1013589159C	1R14-029	TRL230H3603	1R11-028	4454	2B9-266	8363	1R13-116	8484	1R12-508
S-2061-C	1R12-095	TRL-240/393	1R12-092	4455	3B14-364	8364	1R14-026	8486	1R13-153
S-2572-C	1R14-038	TRL-240/393	1R12-509	4456	3B14-451	8365	1R14-018	8488	1R12-487
S-2573-C	1R14-028	TRL-250	1R12-103	4457	3B14-367	8366	1R14-028	8490	1R12-370
S-2574-C	1R14-030	TRL-270/476	1R13-038	4463	2B9-254	8367	1R14-115	8495	1R12-571
S-3052-C	1R13-039	TRAILERS DE MONTERREY		4464	2B12-434	8370	1R14-019	8496	1R12-437
S-3053-C	1R13-038	Air Spring Bellows		4465	2B12-432	8372	1R12-220	8497	1R12-436
S-4695-C	1R14-028	73312A	2B12-424	4466	3B12-310	8376	1R12-143	8501	1R12-554
S-4797-C	1R14-028	73312B	2B9-216	4468	1B12-301	8377	1R13-047	8503	1R12-557
S-5356-C	1R12-095	TRIANGLE		4469	3B12-300	8378	1R14-042	8505	1R12-256
S-542-C	1R12-092	Air Spring Bellows		4471	2B12-412	8379	1R12-178	8513	1R13-130
S-542-C	1R12-509	4310	2B9-201	4472	2B12-411	8382	1R12-303	8514	1R11-219
S-570-C	1R12-132	4311	2B14-360	4480	2B12-440	8382	1R12-603	8515	1R11-242
S-5828-C	1R12-103	4313	2B12-309	4499	2B9-201	8390	1R12-446	8516	1R11-205
S-740-C	1R12-103	4315	2B9-206	4502	2B12-317	8391	1R12-441	8517	1R11-191
SAUR AXLES (SAS)		4316	2B14-359	4503	3B12-304	8393	1R12-567	8518	1R13-097
Air Spring Bellows		4318	2B12-307	4505	2B9-229	8395	1R12-505	8519	1R12-403
P10-755	2B12-300	4320	2B9-200	4508	3B12-312	8397	1R12-561	8520	1R12-402
P50-733A (LIF)	2B9-201	4321	2B14-356	4509	2B8-550	8398	1R12-560	8521	1R12-401
PB10-784	2B12-434	4323	2B12-305	4510	2B9-245	8399	1R12-559	8522	1R13-124
SAUR AXLES (SAS)		4325	3B14-359	4513	2B12-324	8400	1R12-558	8523	1R14-171
Air Spring Rolling Lobe		4327	2B12-300	4514	2B12-345	8401	1R11-204	8525	1R9-065
P50-705	1R12-132	4329	3B14-356	4520	3B12-335	8405	1R14-159	8526	1R13-177
P50-733B	1R13-039	4331	2B12-406	4524	2B10-226	8406	1R12-424	8530	1R14-174
P50-734	1R12-095	4333	3B14-360	4525	3B12-312	8407	1R12-090	8533	1R13-176
SEARS SEAT		4334	2B12-320	4530	2B14-383	8408	1R12-182	8537	1R11-221
Air Spring Sleeve		4336	3B14-354	4541	2B12-346	8409	1R12-188	8538	1R11-222
S-20235	1S4.5-121	4337	2B12-320	4544	2B14-470	8410	1R12-365	8539	1R14-127
S-9383	1S4.5-121	4339	1B14-358	4546	3B12-328	8414	1R14-037	8542	1R12-555
SILENT DRIVE		4340	2B12-324	4547	3B12-329	8415	1R14-038	8544	1R12-563
Air Spring Bellows		4342	2B14-355	TRIANGLE		8416	1R12-400	8548	1R12-532
AS-7446	2B12-402	4343	2B12-427	Air Spring Rolling Lobe		8417	1R11-166	8563	1R11-150
AS-8025	3B12-310	4345	2B14-367	8310	1R12-092	8422	1R13-120	TRUCKSTELL	
AS-8027	3B12-310	4346	2B12-410	8310	1R12-509	8424	1R10-120	Air Spring Bellows	
SMOOTH RIDE		4362	2B9-210	8311	1R12-095	8425	1R10-122	63640	3B14-354
Air Spring Bellows		4363	2B12-425	8312	1R12-069	8427	1R12-367	63641	2B14-360
P10-755C	2B12-304	4364	2B12-313	8312	1R12-669	8428	1R12-498	63644	2B14-360
SUSPENSIONS INC.		4365	2B12-426	8313	1R14-045	8429	1R12-481	TRUCKSTELL	
Air Spring Bellows		4367	2B12-319	8314	1R11-028	8431	1R14-137	Air Spring Rolling Lobe	
200042	2B9-201	4368	2B12-432	8315	1R12-103	8433	1R13-239	63647	1R12-103
200117	3B12-310	4369	2B12-416	8316	1R14-028	8434	1R13-118	TTX	
200118	2B9-252	4369	2B12-446	8317	1R13-039	8435	1R12-375	Air Spring Bellows	
200177	3B14-452	4370	2B12-402	8318	1R14-030	8436	1R12-366	1999408 2B9-225	
200180	2B9-254	4371	2B12-434	8319	1R12-132	8438	1R12-195	VOLVO	
200448	2B12-307	4372	2B12-428	8320	1R14-039	8443	1R12-502	Air Spring Bellows	
200620	3B12-304	4374	2B14-354	8321	1R12-281	8444	1R13-070	2076095	2B12-320
200835	2B9-250	4413	3B12-319	8322	1R11-018	8446	1R9-070	35203-0005	2B14-354
200981	2B12-313	4426	2B9-250	8323	1R13-117	8447	1R11-202	35203-3204	2B14-354
201602	2B12-317	4427	2B9-253	8324	1R13-115	8449	1R12-615	VOLVO	
SUSPENSIONS INC.		4428	2B9-255	8325	1R12-155	8450	1R12-205	Air Spring Rolling Lobe	
Air Spring Rolling Lobe		4429	2B9-251	8325	1R12-358	8451	1R12-404	20396293	1R12-615
200041	1R12-142	4430	3B12-304	8327	1R12-309	8454	1R12-499	20413888	1R12-615
200457	1R12-095	4431	3B12-300	8328	1R12-351	8456	1R12-538	20505399	1R12-615
200458	1R14-038	4432	3B12-301	8329	1R12-355	8460	1R13-159	20733034	1R12-647
201335	1R12-256	4434	3B12-303	8330	1R12-370	8461	1R12-325	21132005	1R12-1049
201869	1R12-092	4436	3B14-356	8331	1R12-359	8462	1R12-438	21669088	1R12-1049
201869	1R12-509	4437	3B14-359	8332	1R12-621	8465	1R12-620	3180673	1R12-423
202796	1R13-130	4439	3B14-360	8333	1R12-066	8467	1R12-553	3180984P2	1R12-462

Competitor No.	Our No.	Competitor No.	Our No.	Competitor No.	Our No.	Competitor No.	Our No.	Competitor No.	Our No.
VOLVO		AS-0039	1R14-039						
Air Spring Rolling Lobe (cont.)		AS-0040	1R12-103						
35003-3201	1R12-182	AS-0044	1R12-421						
35003-3203	1R12-182	AS-0047	1R14-174						
35003-3204	1R12-182	AS-0047G	1R14-170						
35003-3209	1R12-182	AS-0049	1R12-441						
3934699	1R12-615	AS-0050	1R12-370						
8061151	1R12-400	AS-0053	1R12-370						
8079902	1R12-615	AS-0054	1R12-487						
8084296	1R12-615	AS-0056	1R12-439						
8097092	1R12-615	AS-0057	1R12-580						
8169868	1R12-400	AS-0061	1R12-480						
VOLVO		AS-0073	1R13-120						
Air Spring Sleeve		AS-0077	1R12-069						
66003-0004	1S5-060	AS-0077	1R12-669						
66003-0007	1S4-042	AS-0078	1R14-042						
66003-3201	1S4-074	AS-0082	1R14-038						
8169029	1S5-070	AS-0083	1R13-039						
WATSON & CHALIN		AS-0084	1R13-239						
Air Spring Bellows		AS-0090	1R12-502						
AS-0001	2B9-200	AS-0095	1R12-309						
AS-0002	2B9-239	AS-0096	1R13-115						
AS-0003	2B12-309	AS0098	1R13-207						
AS-0004	2B14-356	AS-0101	1R12-356						
AS-0005	2B12-402	AS-0104	1R12-256						
AS-0006	3B14-356	AS-0107G	1R13-155						
AS-0007	2B12-307	AS-0113G	1R12-541						
AS-0008	2B14-359	AS-0114G	1R12-540						
AS-0009	2B12-300	AS-0144	1R14-190						
AS-0014	2B12-320	AS-0241	1R14-232						
AS-0019	3B12-300	AS-0246	1R14-236						
AS-0019-1F	3B12-328								
AS-0020	2B9-206								
AS-0021	2B14-365								
AS-0025	3B14-359								
AS-0027	2B12-305								
AS-0030	2B8-550								
AS-0032	2B14-470								
AS-0033	3B14-359								
AS-0034	2B14-476								
AS-0035	2B9-210								
AS-0041	2B9-250								
AS-0048	3B12-319								
AS-0048-1F	3B12-329								
AS-0048-2G	3B12-324								
AS-0048-3G	3B12-342								
AS-0058	2B9-229								
AS-0075	3B12-303								
AS-0086	3B14-452								
AS-0087	2B12-346								
AS-0087-1F	2B12-345								
AS-0088	2B9-245								
AS-0089	2B14-383								
WATSON & CHALIN									
Air Spring Rolling Lobe									
AS-0010	1R14-028								
AS-0011	1R12-092								
AS-0012	1R12-095								
AS-0013	1R13-039								
AS-0015	1R12-132								
AS-0017	1R11-028								
AS-0018	1R12-066								
AS-0023	1R13-038								
AS-0023-1G	1R14-154								
AS-0026	1R9-065								
AS-0028	1R12-066								
AS-0029	1R9-070								
AS-0036	1R12-335								

Discontinued Air Springs

<u>Discontinued part number</u>	<u>Replaced by</u>	<u>Discontinued part number</u>	<u>Replaced by</u>
1R8-036	1S8-003	1R13-103	1R13-159
1R9-019	1R9-065	1R13-126	1R13-038
1R10-053	1R10-091	1R13-140	1R13-176
1R10-059	1R10-089	1R13-174	1R13-188
1R10-078	1R10-089	1R13.5-128	1R13-177
1R10-086	1R10-089	1R14-083	1R14-039
1R10-094	NONE	1R14-093	1R14-171
1R11-075	NONE	1R14-110	1R14-141
1R11-089	1R11-243	1R14-123	1R14-175
1R11-096	1R11-244	1R14-147	1R14-094
1R11-172	1R10-122	1S5-146	1S5-164
1R11-174	1R11-227	1S6-024	NONE
1R12-014	NONE	1S6-025	1S6-055
1R12-047	NONE	1S12-002	1S12-615
1R12-155	1R12-358	1S12-004	1S12-365
1R12-158	NONE	1S12-005	1S12-365
1R12-162	NONE	1S12-006	1S12-402
1R12-186	1R12-603	1S12-007	1S12-404
1R12-197	1R12-365	1S12-017	1S12-538
1R12-225	1R12-424	1S12-022	1S12-400
1R12-265	NONE	1S12-027	1S12-424
1R12-279	1R12-281	1S12-029	1S12-402
1R12-284	1R12-511	1S12-030	1S12-403
1R12-319	1R12-631	1S12-031	1S12-404
1R12-334	1R12-394	1S12-033	1S12-615
1R12-352	1R12-421	1S12-035	1S12-615
1R12-372	1R12-552	1S12-240	1S12-424
1R12-373	1R12-553	1S12-244	1S12-401
1R12-390	1R12-554	1S12-245	1S12-400
1R12-397	1R12-615	3B14-352	3B14-361
1R12-398	1R12-538		
1R12-405	1R12-615		
1R12-427	1R12-615		
1R12-440	1R12-580		
1R12-488	1R12-404		
1R12-501	1R12-120		
1R12-503	1R12-580		
1R12-522	1R12-508		
1R12-533	1R12-481		
1R12-536	1R12-615		
1R12-537	1R12-615		
1R12-548	1R12-615		

STEMCO LP STANDARD TERMS AND CONDITIONS OF SALE

Definitions:

- a. "Buyer" means STEMCO and "Seller" means the legal entity contracting with the Buyer.
- b. "Order" and "Purchase Order" are used synonymously.
- c. "Delivery Date" means the required date of delivery for Goods on the Purchase Order or Blanket Order Release; or the acceptance in total of the Services provided by the Seller.

2. **Acceptance, Modification, and Entire Agreement:** Placement of this order constitutes Buyer's offer to Seller upon terms and conditions stated herein and on the face of the purchase order and does not constitute an acceptance by the Buyer of any offer to sell. This order becomes a binding contract, subject to the terms and conditions thereof, when accepted by acknowledgement or commencement of performance and is binding on the heirs, successors, assigns, and representatives of the Seller. Placement of this order is expressly conditioned upon Seller's acceptance of all the terms and conditions of purchase contained on or attached to this order. Any acknowledgment form or other form of Seller containing terms and conditions of sale submitted to Buyer from Seller shall not have the effect of modifying the terms and conditions hereof. Any such additional or different terms and conditions are hereby objected to and rejected by the Buyer. Buyer may consider Seller's request for changes only if such request is made in writing and directed to specific clauses in this order within ten (10) days of issuance of this order. By acceptance of the order, Seller agrees to comply with the terms and conditions contained herein and to provide all Goods and/or Services as described within the purchase order. These terms and conditions constitute the entire agreement between the parties and supersede any previous oral or written representations, including but not limited to provisions in Seller's quotations, proposals, terms and conditions, acknowledgments, invoices or other documents. No change or modification to Buyer's terms and conditions shall be binding upon Buyer unless specifically accepted in writing.

3. **Delivery:** Time is of the essence in regard to fulfilling this order. Seller shall deliver the Goods and/or Services ordered by Buyer no later than the Delivery Date. Seller shall immediately notify Buyer in the event that Seller's performance is delayed or likely to be delayed, in whole or in part, and Seller shall provide Buyer with all information regarding any reasons for such delay. Such notice shall not constitute a waiver by Buyer of any Seller's obligations under the purchase order. Buyer has the right to cancel all or a portion of this order which has not been delivered in accordance with the Delivery Date. Seller will limit and phase expenditures, incurrence of costs, and purchases and subcontract commitments for raw materials and components in such fashion to ensure continuity in production and permit performance and completion of each production increment in sequence without creating any unreasonable accumulations of raw materials or work in process of components for any production increments.

If the specified mode of transportation for the Goods would not permit the Seller to meet the Delivery Date, Seller shall ship Goods by air freight or other expedient means acceptable to the Buyer and Seller shall pay the costs of such freight for such expedited shipment, over the cost of the specified mode of transportation.

Seller shall be liable for any production line stoppages or related expenditures incurred by Buyer or charged to Buyer by its customers, which are caused by the failure of Seller to deliver its Goods and/or Services in a timely manner. Default in delivery caused by Acts of God or other extraordinary events or occurrences beyond Seller's control and without its fault or negligence shall not make Seller liable therefore, provided Seller immediately notifies Buyer of said event and the estimated delay in delivery.

If the Goods and/or Services ordered by Buyer are in excess of the volume stated on the order, and/or its releases, or are delivered more than five (5) days prior to the Delivery Date, Buyer may reject such delivery of Goods and/or Services and may return such rejected Goods at Seller's own risk and expense, including, without limitation, transportation and insurance charges.

Buyer may delay delivery or acceptance occasioned by reason of force majeure or other causes beyond its control. Seller shall hold such Goods at the direction of the Buyer and shall deliver them when the cause affecting delay has been removed. Causes beyond Buyer's control include, without limitation, government action or failure of the government to act where such action is required, strike or other labor issues, fire, destruction or impairment of facilities, or Acts of God.

4. **Default of Seller:** If Seller shall (a) fail to deliver Goods and/or Services within the time scheduled or in compliance to the Delivery Date or (b) fail to perform any other provision of this order or (c) become insolvent, or (d) file or have filed against it a petition under any state or federal bankruptcy or insolvency law, then, and in any such event, without prejudice to Buyer's other rights or remedies Buyer shall have the right at its option to terminate this order, in whole or in part. Upon any such termination Buyer may exercise any and all rights accruing to it, both at law including those set forth in the Uniform Commercial Code or in equity and may also (1) require Seller to deliver forthwith any or all Goods, or parts thereof, which have been produced, or are in process of production pursuant to this order, in which event Buyer shall pay Seller the order price for the acceptable completed items so delivered and shall reimburse Seller for its costs actually incurred with respect to the partially completed Goods so delivered, provided that such costs in no event shall exceed the order price equitably allocated therefore and (2) procure, for such items and in such manner as it may deem appropriate, Goods and/or Services similar to those terminated, and to recover from Seller the excess cost incurred by Buyer in procuring such similar Goods and/or Services. Seller's obligations under the Warranty, Patent and Confidentiality provisions of this order shall survive such termination.

5. **Price:** This is a firm price order. Seller represents and warrants to Buyer that the price for Goods and/or Services provided under the purchase order are the lowest prices, whether or not published, for which the Seller has sold or is selling such Goods and/or Services, taking into account any differences in quantities and/or delivery schedule. Buyer shall be entitled to receive from Seller a price reduction if Seller offers substantially similar Goods or Services to others at a lower price (taking into account differences in quantities and delivery schedule) at any time during the

period beginning on the date of the order and ending ninety (90) days after the final payment due date for such Goods or Services. Buyer may take volume discounts retroactively.

All payments due under the purchase order to Seller shall be paid in United States dollars as agreed by Buyer and Seller, from the date of invoice from the Seller. Partial payments may be made at Buyer's option. Buyer may set-off any amount owed by Buyer to Seller against any amount owed Buyer from Seller. Seller's acceptance of payment constitutes an unconditional waiver and release of any statutory lien, mechanic's lien, stop notice, bond right, and claim for payment. Seller warrants, represents and covenants that when final payment is accepted from Buyer, title to all work, materials, and/or equipment shall pass to Buyer free and clear of all liens, claims, security interests or any other encumbrances; and all applicable taxes have been fully paid; and all laborers, mechanics, and subcontractors have been paid or will be paid in full from the final payment.

Seller shall pay, without charge to Buyer, any federal, state or local tax or other government charge or assessment relating to the production, sale or shipment of any Goods or provision of Services under the purchase order unless otherwise expressly agreed to in writing by the Buyer.

Seller shall make spare parts for Goods purchased pursuant to the order available to the Buyer at Seller's current price, less all applicable discounts.

All costs associated with custom product tooling shall be paid by Seller, unless otherwise expressly agreed to in writing by Buyer.

Seller shall bear responsibility for all errors contained in any invoice, acceptance, acknowledgement or confirmation it provides to the Buyer.

6. Changes: Buyer may make changes in the drawings and specifications on any item at any time. If such changes result in delay or additional expense to Seller, an equitable adjustment of price and delivery schedule will be made.

7. Specifications: If drawings, blueprints, or specifications are furnished by the Buyer, the purchase order shall be based upon such drawings, blueprints, or such specifications, and approval of samples by Buyer shall not relieve the Seller from strict and full compliance with such blueprints or specifications. Goods and/or Services not conforming to such blueprints or specifications may be rejected.

8. Inspection / Acceptance: Seller agrees to permit Buyer's inspectors to have access to Seller's plant at all reasonable times for the purpose of inspecting the items as set forth in this order and work in process for production of such items. All items are subject to final inspection and approval at Buyer's facilities or other place designated by Buyer. Such inspection shall be made within a reasonable time after delivery irrespective of the date of payment. The date of payment and the payment for any item purchased hereunder shall not constitute approval or acceptance of such material by Buyer and Buyer's right of inspection shall survive payment. Any inspection records relating to the Goods and/or Services on the order shall be available to Buyer for a minimum of one (1) year after delivery to Buyer. No inspection (including source inspection) test, approval (including design approval) or acceptance of Materials shall relieve the Vendor from its obligations hereunder or be deemed acceptance of the Materials. Buyer may (1) assess Seller a fee associated with the delivery of defective Goods (2) assess the Seller for all incurred costs and may (3) return rejected items at Seller's expense and Seller shall bear all costs of return and risk of loss as to rejected items. Seller shall, at Buyer's election, replace any rejected items returned to Seller hereunder, refund the full purchase price thereof and bear the costs associated with any air freight or expedited delivery to the Buyer of conforming product to remedy any defects of nonconformity to specifications, drawings, or provided samples.

9. Packaging and Shipping: All items shall be prepared and packed for shipment in a manner that will prevent damage in transit. Buyer is not liable for extra charges for packing, cartage or any other expense related thereto unless stated in this order. Seller shall provide Buyer's part number, order number, line number and release number on all invoices, packing slips, container labels and any other shipping documentation.

10. Warranty: Seller warrants that all goods and/or services provided by it (i) shall be of good quality and workmanship and free of defects, latent or patent; (ii) shall conform to all specifications, drawings or descriptions which are supplied by Buyer; (iii) shall be merchantable and suitable and sufficient for their intended purpose; and (iv) shall be free from any claim of any third party., including without limitation any claims of infringement. Seller may not negate, exclude, limit or modify any warranty otherwise available to Buyer. Any attempt by Seller to do so is ineffective and shall not in any way bind Buyer. Buyer's inspection or acceptance of any goods or services, or Buyer's payment for goods or services shall not constitute a waiver by it of any warranty. None of the remedies available to Buyer for breach of any of the forgoing warranties may be limited except to the extent and in the manner agreed upon by Buyer in a separate written agreement specifically designating such limitation and signed by an authorized representative of Buyer.

11. Cancellation, Termination for Convenience: Buyer reserves the right to cancel this purchase order, or any part thereof, at any time, even though Seller is not in default hereunder, by giving written notice to the Seller in the event of such cancellation. Buyer shall pay for all goods and services delivered and completed and an equitable settlement shall be arrived at for the costs incurred by Seller for goods and materials in process not to exceed thirty (30) days average procurement by the Buyer over the previous ninety (90) days prior to notification. Where cancellation is by reason of termination of a contract of the United States Government under which this purchase order has been placed, Buyer will pay the Seller at such time as Buyer is paid by the United States Government. Upon receipt of any notice of cancellation hereunder, Seller, unless otherwise directed, will immediately discontinue all work in process and immediately cancel all orders or subcontracts given or made pursuant to this purchase order. Exercise by Buyer of the rights of cancellation reserved in this paragraph shall give rise to no liability on the part of the Buyer except as specified in this paragraph and shall not have the effect of waiving damages the Buyer might otherwise be entitled to.

12. Patent, Trademark, Copyright Indemnity: Seller agrees to indemnify Buyer and its successors, assigns and customers and hold them harmless from and against all claims, liability, loss, damage or expense, including attorney's fees and expenses, arising from or by reason of any suit, claim or demand relating to trademark, patent or copyright infringement or litigation based hereon with respect to the Goods and/or Services, or any part thereof, covered by this order and such obligations shall survive acceptance of the Goods and/or Services and payment thereof by the Buyer. Seller agrees that it will assume the defense of the Buyer and/or its successors, assigns and customers and users of its products against any such aforementioned suit, claim, or demand, pendency of any such suit, claim or demand; provided that it is given reasonable notice of the pendency of any such suit, claim, or demand.

13. Indemnity: Seller will indemnify, defend and hold harmless Buyer, its affiliates, successors and assigns, and its and their respective officers, directors, employees, independent contractors, agents, successors and assigns (collectively, the "Indemnified Parties"), from and against any and all liabilities, losses, costs, expenses, claims and proceedings which any of the Indemnified Parties may suffer or for which any of the Indemnified Parties may become liable and which arise out of any of the following; Seller's breach of any provision herein or any other agreement between Buyer and Seller; the manufacture or delivery of Goods or any defect in the Goods an/or Services, workmanship or otherwise; any act or omission of the Seller; any actual or alleged infringements of any intellectual property right of any other party, resulting from any sale, use or manufacture of any Goods delivered hereunder; Seller's failure to comply with any federal, state, county or local laws, ordinance, regulations and codes; and any and all actions, suits, proceedings, demands, assessments, judgments, costs and expenses, including reasonable attorneys' and consultants' fees incident to any of the foregoing. If there is a claim against Buyer arising out of the foregoing, Seller will have the right, at its option and expense, to defend any such proceeding, claim or demand. If Seller defends such claim, Buyer shall still have the right, at its cost and expense, to participate in the defense with counsel of its own choosing. Buyer may retain counsel and conduct the defense of the proceeding, claim or demand in question as it may deem proper in its sole discretion, at the sole cost and expense of Seller. Seller may not settle any such proceeding, claim or demand without Buyer's consent, which shall not be unreasonably withheld.

14. Subcontract, Assignment: Seller shall not, without the prior written consent of Buyer, make any contract with any other legal entity for furnishing any of the completed or substantially completed Goods and/or Services covered by this order or assign this order or any right hereunder.

15. Buyer's Property: All tools, dies, jigs, patterns, equipment or material and other items purchased, furnished, charged to or paid for by Buyer and any replacement thereof, shall remain the property of Buyer. Such property shall be plainly marked to show it is the property of Buyer and shall be safely stored and maintained apart from other property held by Seller. Seller shall not substitute the property for Buyer's property and shall not use such property except in filling Buyer's orders. Seller shall hold such property at its own risk and upon Buyer's written request deliver the property to Buyer in the same condition as originally received by Seller, reasonable wear and tear excepted. Title to and right of possession to special tooling, dies, jigs, patterns and equipment, the cost of which is fully or substantially amortized in the price of the Goods purchased, shall remain with Seller but Seller shall, at no additional cost to Buyer, hold such special tooling for Buyer's exclusive use and Seller shall not dispose of such tooling without prior written approval of Buyer. Seller shall take all necessary measures to preserve Buyer's title to Buyer's property, free of all encumbrances. Buyer retains the right in addition to other rights provided by law, to enter Seller's premises and remove Buyer-owned property with or without a court order. Seller shall assume and shall indemnify Buyer against any and all liability for damages to property or injury to, or death of any persons which may arise from, may be incidental to the presence of, or may involve the use of Buyer-owned property whether such damage, injury or death is caused by defects in the property, negligence in the use thereof or otherwise.

16. Drawings, Specifications and Technical Information: The ideas, information and designs contained in or shown upon, and the drawings, specifications, photographs and other engineering and manufacturing information supplied by Buyer shall remain Buyer's property, shall be retained in confidence by Seller and not be disclosed to any other person or entity, and shall not be used nor incorporated into any product or item later manufactured or assembled by Seller for anyone other than Buyer. Any unpatented knowledge or information concerning Seller's processes, present or contemplated products or their uses, which Seller may disclose to employees of Buyer in connection with the ordering, acquisition and use by Buyer of the goods or services covered by this order shall, unless otherwise specifically agreed in writing, be deemed to have been disclosed as part of the consideration for this order and Seller agrees not to assert any claim against Buyer by reason of any alleged use to which any such information or knowledge may be put by Buyer.

17. Chemical Substances: Notwithstanding anything to the contrary hereafter represented by either party to the other, Seller warrants that each and every chemical substance sold or otherwise transferred by Seller to Buyer as of the time of such sale or transfer that is required or permitted to be reported for the inventory of chemical substances (409 CFR Part 710) has been reported to EPA either by Seller or by others for incorporation in the inventory of chemical substances compiled and published by the administrator of the Environmental Protection Agency pursuant to the Federal Toxic substances Control Act (PL 94-469).

18. Hazardous Materials: Seller shall notify Buyer of any inherent hazard related to any materials which could be exposed during handling, transportation, storage, use, resale, disposal or scrap. Said notice shall be sent to the Buyer's Director of Supply Chain Management and shall specify the product name and part number, the nature of the hazard, proper precautions that must be undertaken by Buyer or others to protect against the hazard, and any additional information necessary to protect its interest.

19. Compliance with Law: Seller represents and warrants that the performance of this order in furnishing of goods and/or service called for shall be in accordance with the applicable standards, provisions and stipulations of all pertinent federal, state, or local laws, rules, regulations, executive orders or other ordinances, including but not

limited to the Fair Labor Standards Act, as amended and of regulations and orders of the United States Department of Labor issued under Section XIV thereof, the Occupational Safety and Health Act of 1970, and the Toxic Substances Control Act, each as amended and in connection therein. Seller shall include the following legend on all invoices: "We hereby certify that the goods were produced in compliance with all applicable requirements of the Fair Labor Act, as amended, and of regulations and orders of the United States Department of Labor and that the goods as installed and/or used by Buyer will comply with the Occupational Safety and Health Act of 1970 as amended and the implementing rules and regulations promulgated by the Secretary of Labor".

If Seller is providing goods to Buyer, Seller agrees to review and comply with Buyer's conflict minerals policy statement and to use commercially reasonable efforts to: (a) identify whether such goods contain tantalum, tin, tungsten or gold; (b) conduct a reasonable country of origin inquiry regarding the origin of such minerals in such goods to determine whether such minerals originated in covered countries, as defined in Section 1502 of the Dodd-Frank Wall Street Reform and Consumer Protection Act; (c) if such minerals originated in covered countries, conduct due diligence on the chain of custody of the source of such minerals for the purpose of identifying the smelter of said materials; and (d) assist Buyer in conducting reasonable due diligence concerning the smelters of such minerals. Seller shall include the substance of this Section in any agreement between Seller and its lower tier sellers and provide Buyer with reasonable documentation of Seller's and its lower tier sellers' due diligence efforts, in a format prescribed by Buyer, when requested by Buyer.

20. **Equal Opportunity:** During the performance of this order, the Seller shall comply with provisions of Executive Order 11246, including all amendments thereto relative to Equal Employment Opportunity and the implementing rules and regulations of the Department of Labor on Equal Opportunity Employment, all of which are incorporated herein by specific references and Seller shall on Buyer's request, so certify.

21. **Gratuities:** Seller represents and warrants to Buyer that Seller has not offered or given any employee, agent, or representative of Buyer, or any government, any gratuity with the intent of securing any business from Buyer or favorable treatment under any agreement with Buyer. Any breach of this warranty shall be a material breach of the terms and conditions of each and every purchase order between Buyer and Seller.

22. **Waiver:** Failure of Buyer to insist on performance of any of these terms and conditions shall not be construed as a waiver of such items, conditions or requirements and shall not affect the right of Buyer thereafter to enforce each and every term, condition or requirement hereof.

23. **Severability:** If any language herein shall be invalidated for any reason, that language shall be considered deleted and the remainder shall be unaffected and shall continue in full force and effect to the fullest extent permitted by law.

24. **Survival:** The parties acknowledge and agree that the Terms and Conditions are intended to govern the rights, duties and obligations of the parties following the closing. Accordingly, this Agreement shall survive and shall not be deemed merged into, the execution or delivery of any Good and/or Service.

25. **Cumulative Remedies:** Nothing herein shall limit Buyer's rights in law or equity for damages resulting from the delivery of any Goods and/or Services. The remedies provided herein are cumulative and are in addition to any other remedies provided at law, or in equity, and nothing herein shall be construed as prohibiting Buyer from pursuing any other remedies at law or in equity available to it for any breach or threatened breach of these Terms and Conditions, all of such remedies being cumulative in every respect. No waiver of any breach or violation hereof shall be implied from forbearance or failure by Buyer to take action thereon.

26. **Choice of Law and Personal Jurisdiction:** This contract is made in the County of Harrison and shall be governed and construed in accordance with the laws of the State of Texas. Any action relating to this contract shall be instituted and prosecuted in the courts of the County of Harrison, State of Texas or the United States District Court for the Eastern District of Texas. Seller agrees to submit to the exclusive jurisdiction of such courts and further agrees not to contest such venue as a forum non conveniens. Pending any decision, appeal or judgment in such proceedings or the settlement of any dispute arising under this order, Seller shall proceed diligently with the performance of the order in accordance with decision of the Buyer.

27. **Miscellaneous:**

A. The relationship of Buyer and Seller is that of independent contractors.

B. Unless authorized by Buyer in writing, the names of Buyer, its parent, subsidiaries and/or affiliated corporations or any of their trademarks shall not be used by Seller.

C. No news release, public announcement, denial or confirmation of same or any part of the subject matter of this purchase order or any phase of this purchase order shall be made without the prior written approval of Buyer.

STEMCO®



STEMCO® BRAKE PRODUCTS CATALOG



STEMCO®
A Higher Standard of Performance.™

an EnPro Industries company

Making the Roadways Safer®

Introduction

STEMCO Brake Products Introduction	1
PLATINUM PERFORMANCE SYSTEM™ PLUS 7	2

Wheel Kits, Lined Shoes, New Shoes, Linings

Wheel Kit & Lined Shoes Features & Benefits	3
High Performance Brake Lining Overview	4
B-LOCK™ Anti-Rust Jacking	5
Wheel Kits, Lined Shoes, New Shoes, Brake Linings	6 - 36
Brake Shoe Identifier	37 - 41
Friction Interchange	42 - 43

CentriFuse® Brake Drums

Why Choose CentriFuse®?	44
CentriFuse® Weight Savings, Features & Benefits	45
CentriFuse® Application Guide	46
Brake Drum Mounting Procedures	47
CentriFuse® Lite Features & Benefits	48 - 49
CentriFuse® HD Features & Benefits	50 - 51
CentriFuse® Brake Drum Specifications by Brake Size	53
CentriFuse® Drum & Lightweight Hub Assemblies	54
CentriFuse® Drum & Ductile Iron Hub Assemblies	55
Brake Drum Manufacturers Interchange	56
CentriFuse® Drum Back & Band to Drum Part Number	57

Lunar™ Air Disc Brakes

Lunar Air Disc Brakes Features & Benefits	58 - 59
---	---------

Genuine Motor Wheel Cone Lock Nuts

Genuine Motor Wheel Cone Lock Nuts Features & Benefits	60
--	----

Crewson Automatic Brake Adjusters

Crewson Automatic Brake Adjuster Features & Benefits	61 - 62
Crewson Build-A-Part Number	63
Crewson 1.30" Welded Clevis Automatic Brake Adjuster	64 - 65
Crewson Automatic Brake Adjuster Applications with Auto-Check™	66 - 67
Crewson Automatic Brake Adjuster Applications without Auto-Check™	68 - 69
Crewson Manual Brake Adjuster Applications	69
Crewson Brake Adjuster Components	70 - 71
Brake Adjuster Manufacturers Cross Reference	72

Hardware Kits

Hardware Kits Specifications	73 - 79
Hardware Kit Manufacturers Cross-Reference	80 - 81

YOUR STARTING POINT FOR STOPPING POWER



Brake Products

For over 60 years, STEMCO has supplied only the highest quality wheel end components to the commercial vehicle market. By offering application specific high performance braking solutions, as well as industry unique products and processes like CentriFuse®, B-Block™, and Crewson™, STEMCO Brake Products™ is providing an answer to the question “How do I get quieter, safer, brake systems that run cooler and last longer.”

INDUSTRY BEST WARRANTY

SERVICEABLE, AFFORDABLE AND FLEXIBLE



PLATINUM PLUS 7
PERFORMANCE SYSTEM™

New On-Highway Original Equipment Platinum Performance Systems

PLATINUM PLUS 7
PERFORMANCE SYSTEM™

- Guardian® HP or Discover® Seal
- Pro-Torq® Axle Fastener
- Sentinel® Hub Cap
- STEMCO® Bearings

5 Year

PLATINUM PLUS 7
PERFORMANCE SYSTEM™
TIRE INFLATION

- Aeris® Automatic Tire Inflation System

- Guardian® HP or Discover® Seal
- Pro-Torq® Axle Fastener
- Sentinel® Hub Cap
- STEMCO® Bearings

7 Year

PLATINUM PLUS 7
PERFORMANCE SYSTEM™
LIGHT WEIGHT

- STEMCO® CentriFuse® Drum and Hub Assembly
- STEMCO Crewson™ Automatic Brake Adjuster

- Guardian® HP or Discover® Seal
- Pro-Torq® Axle Fastener
- Sentinel® Hub Cap
- STEMCO® Bearings

7 Year

Platinum Performance Plus Systems

- Lower your operating costs, reduce downtime and increase revenue
- STEMCO Platinum Performance System Plus 7 Light Weight removes up to 150 pounds of trailer weight, dramatically increasing payload
- Light Weight and Tire Inflation Platinum Performance HP Systems help improve fuel efficiency performance
- Rebuildable, 3-year aftermarket warranty
- The newly redesigned Guardian® HP seal, and STEMCO manufactured precision bearings allow us to confidently move from a five to a seven year warranty on wheel end components based on major improvements in reliability and durability.

New Lined Brake Shoes and Kits



New Brake Shoes

- **GUARANTEED** minimum of 20% longer friction and drum life with STEMCO new brake shoes versus remanufactured shoes.
- **OEM QUALITY, SAFETY AND DEPENDABILITY** with STEMCO new brake shoes. No worries of not meeting the TMC specification (RP 605B) for table condition and minimum thickness which can lead to lost braking power, friction cracking, loose rivets and/or rust jacking.
- **PRE-FORMED "ROLLED" TABLES** provide a flatter mating surface for brake lining and stress-free welds. Competitors form and weld tables in the same step, and then use a process known as coining to shape the welded shoe which may cause weld stress.
- **E-COATING** prevents rust before it starts by using electrical current to deposit ("Bond") the paint to the shoe, which helps to resist rust jacking. STEMCO Brake Products shoes are environmentally tested to withstand 1,000 hours of salt spray testing.
- **HEAT TREATING*** roller and/or anchor ends hardens the steel and prevents distortion and mushrooming. Such wear, often found on competitor relined and new shoes, can result in slippage and cause excessive wear, shortening the life of your shoes.

Hardware Kits

- **RUST RESISTANT** design includes stainless steel bushings, zinc-chromate coated rollers and heavy-duty E-coated springs to improve the dependability of your brakes.

**OEM replacement shoes have heat treated roller ends. Heat treating roller and anchor ends available on select shoes which are offered on a special order basis.*

HORIZON SP CREST XL VISTA HP ULTRA PEAK BFT ULTRA PEAK FT

TQM
TOTAL QUALITY MAINTENANCE™

High performance friction with superior service and support. Contact us for brake training.

STEMCO
BRAKE PRODUCTS™



High Performance Brake Linings

HORIZON SP®

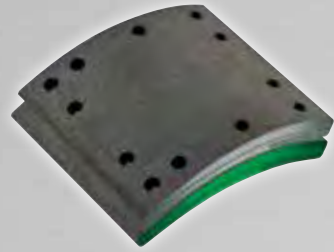

The value and performance choice for highway applications.

Horizon SP® was specially designed to be a cost effective solution for your long-haul needs. Horizon SP® is the standard performance friction formulation for normal-duty cycles, operating environments and loads.

AXLE RATING	APPLICATION(S)
Horizon SP20® 20,000 lbs.	
Horizon SP23® 23,000 lbs.	

CREST XL®

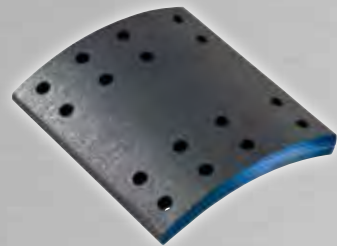

Extra life choice for demanding highway applications.

This unique brake lining is perfect for moderate to heavy-duty long-haul applications. Crest XL® exceeds the performance of the competition in the same category due to its superior formulation.

AXLE RATING	APPLICATION
Crest XL® 20,000 lbs.	

VISTA HP®

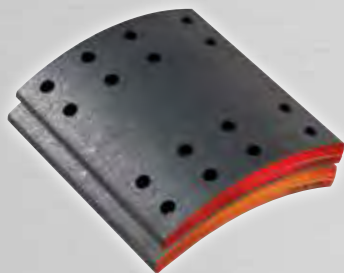

The high performance choice for demanding applications.

If you are looking for superior performance for demanding applications, then look no further. Vista HP® offers smooth, noise-free and stable stopping power over a wide range of temperatures, pressure and speed variations.

AXLE RATING	APPLICATION(S)
Vista HP® 23,000 lbs.	
Vista HP1® 25,000 lbs.	

ULTRA PEAK®

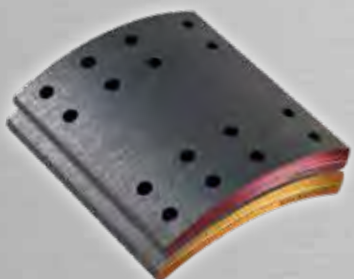

Superior technology for outstanding performance.

Ultra Peak® incorporates the finest raw materials and superior technology to assure maximum performance. This high-quality brake lining has been specially formulated to run quieter and extend lining life and drum life with excellent flexural strength which eliminates failure mode of friction cracking.

AXLE RATING	APPLICATION(S)
Ultra Peak® BRT 23,000 - 26,000 lbs.	
Ultra Peak® FT 26,000 - 29,000 lbs.	

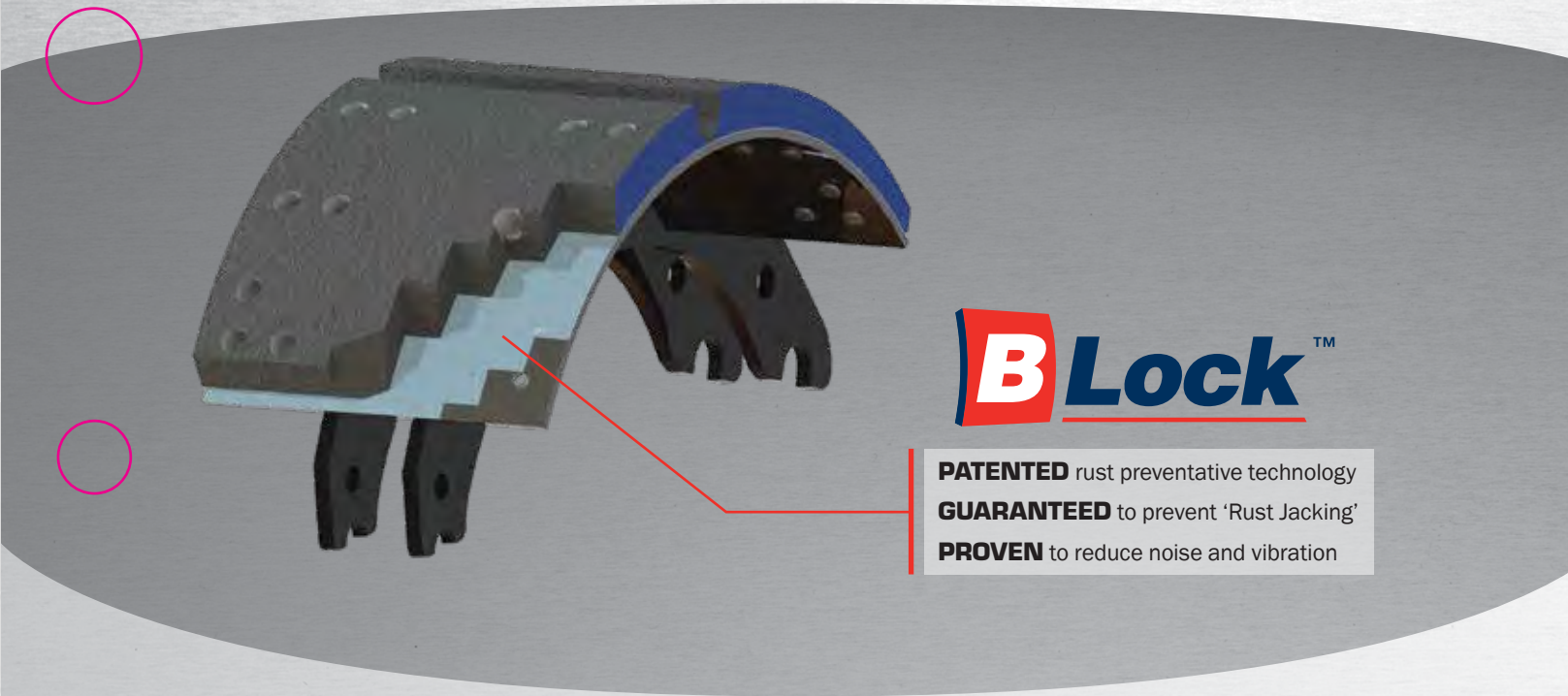

PATENTED rust preventative technology
GUARANTEED to prevent 'Rust Jacking'
PROVEN to reduce noise and vibration

Get the full life out of your STEMCO brake lining with B-Lock!

What is B-Lock?

B-Lock is a patented rust preventative technology that eliminates any possibility of early deterioration of the brake shoe table. B-Lock is applied to the brake shoe table in an adhesive tape form before the shoe is lined. Once the lining is riveted to the B-Lock core, a cold bond is formed between the table of the shoe and the lining.

How is B-Lock cured?

B-Lock forms an epoxy bond and a barrier between the shoe table and the lining with the initial application of the brakes. This eliminates the gap between the two, which prevents elements such as moisture and salt from getting in between the table and lining.

How does B-Lock secure the lining?

B-Lock along with the riveting of the lining provides total and complete lining security and insures that the integrity of the friction is maintained. B-Lock has proven to work well where braking demands are severe and stress on friction is at the greatest. In such applications, it is not uncommon for lining to react to the stress with cracking in the surface. Because B-Lock secures the entire friction area, such cracks will not impair the performance or durability of the lining.

Can B-Lock reduce noise?

B-Lock has been proven to reduce brake noise and vibration especially in industrial applications. This benefit is a result of the bond between the lining and the table.

Is B-Lock guaranteed?

STEMCO LP guarantees our new brake shoes using Rome Steel and B-Lock assembled in Rome, GA against 'Rust Jacking' for the life of the original STEMCO lining. If B-Lock should fail, the brake shoe assembly will be replaced at our cost.

HORIZON SP® CREST XL® VISTA HP® ULTRA PEAK® BRT ULTRA PEAK® FT





Wheel Kits ■ Lined Shoes ■ Brake Lining Options by Axle Rating

	Axle Rating (lbs.)	Wheel Kit	Wheel Kit with B-Lock™	Lined Shoe	Lined Shoe with B-Lock™	Brake Lining
Crest XL	20K	WK1308ECXL	WK1308ECXLBL	LS1308ECXL	LS1308ECXLBL	1308TTDCXL
Vista HP	23K	WK1308EVHP	WK1308EVHPBL	LS1308EVHP	LS1308EVHPBL	1308TTDVHP



Wheel Kits ■ Lined Shoes ■ Brake Lining Options by Axle Rating

	Axle Rating (lbs.)	Wheel Kit	Wheel Kit with B-Lock™	Lined Shoe	Lined Shoe with B-Lock™	Brake Lining
Crest XL	20K	WK1308QCXL	WK1308QCXLBL	LS1308QCXL	LS1308QCXLBL	1308TTDCXL
Vista HP	23K	WK1308QVHP	WK1308QVHPBL	LS1308QVHP	LS1308QVHPBL	1308TTDVHP

New Shoes:



STEMCO
New Steel
Part #
NS-1308E



New Shoes:



STEMCO
New Steel
Part #
NS-1308Q

Hardware Kit:

1 Kit: **SK1500E** 10 Kits: **BSK1500E**

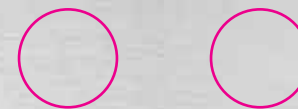
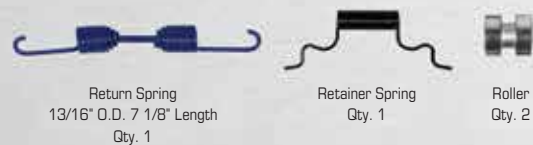

Hardware Kit:

1 Kit: **SK1500Q** 10 Kits: **BSK1500Q**





Wheel Kits ■ Lined Shoes ■ Brake Lining Options by Axle Rating

	Axle Rating (lbs.)	Wheel Kit	Wheel Kit with B-Lock™	Lined Shoe	Lined Shoe with B-Lock™	Brake Lining
Crest XL	20K	WK1443ECXL	WK1443ECXLBL	LS1443ECXL	LS1443ECXLBL	1443TTDCXL
Vista HP	23K	WK1443EVHP	WK1443EVHPBL	LS1443EVHP	LS1443EVHPBL	1443TTDVHP

Wheel Kits ■ Lined Shoes ■ Brake Lining Options by Axle Rating

	Axle Rating (lbs.)	Wheel Kit	Wheel Kit with B-Lock™	Lined Shoe	Lined Shoe with B-Lock™	Brake Lining
Horizon SP20	20K	WK4311ESP20	NA	LS4311ESP20	NA	4311JDSP20
Crest XL	20K	WK4311ECXL	WK4311ECXLBL	LS4311ECXL	NA	4311JDCXL
Horizon SP23	23K	WK4311ESP23	NA	LS4311ESP23	NA	4311JDSP23
Vista HP	23K	WK4311EVHP	WK4311EVHPBL	LS4311EVHP	NA	4311JDVHP
Ultra Peak BRT	23K	WK4311EBRT	NA	LS4311EBRT	NA	4311JDBRT
Vista HP1	25K	WK4311EVHP1	NA	LS4311EBHP1	NA	4311JDVHP1

New Shoes:



STEMCO
New Steel
Part #
NS-1443E

New Shoes:



STEMCO
New Steel
Part #
NS-4311E

Hardware Kit:

1 Kit: **SK1500E** 10 Kits: **BSK1500E**

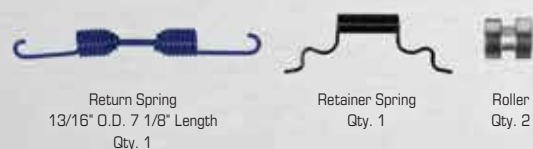

Return Spring
13/16" O.D. 7 1/8" Length
Qty. 1

Retainer Spring
Qty. 1

Roller
Qty. 2

Hardware Kit:

1 Kit: **SK1650E** 10 Kits: **BSK1650E**

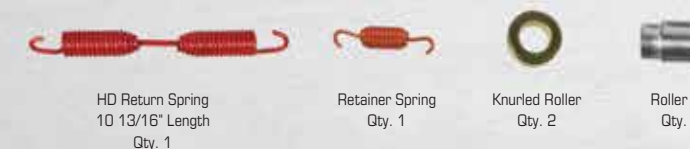

HD Return Spring
10 13/16" Length
Qty. 1

Retainer Spring
Qty. 1

Knurled Roller
Qty. 2

Roller Pin
Qty. 2



Wheel Kits ■ Lined Shoes ■ Brake Lining Options by Axle Rating

	Axle Rating (lbs.)	Wheel Kit	Wheel Kit with B-Lock™	Lined Shoe	Lined Shoe with B-Lock™	Brake Lining
Crest XL	20K	WK4514QCXL	WK4514QCXLBL	LS4514QCXL	LS4514QCXLBL	4514GDCXL
Vista HP	23K	WK4514QVHP	WK4514QVHPBL	LS4514QVHP	LS4514QVHPBL	4514GDVHP
Ultra Peak BRT	23K	WK4514QBRT	NA	LS4514QBRT	NA	4514GDBRT

Wheel Kits ■ Lined Shoes ■ Brake Lining Options by Axle Rating

	Axle Rating (lbs.)	Wheel Kit	Wheel Kit with B-Lock™	Lined Shoe	Lined Shoe with B-Lock™	Brake Lining
Crest XL	20K	WK4514QMCXL	WK4514QMCXLBL	LS4514QMCXL	LS4514QMCXLBL	4514GDCXL
Vista HP	23K	WK4514QMVHP	WK4514QMVHPBL	LS4514QMVHP	LS4514QMVHPBL	4514GDVHP
Ultra Peak BRT	23K	WK4514QMBRT	NA	LS4514QMBRT	NA	4514GDBRT

New Shoes:



STEMCO
New Steel
Part #
NS-4514Q

New Shoes:



STEMCO
New Steel
Part #
NS-4514QM

Hardware Kit:

1 Kit: **SK1650QHD** 10 Kits: **BSK1650QHD** 720 Kits: **ASK1650QHD**



Hardware Kit:

1 Kit: **SK1650QFR** 10 Kits: **BSK1650QFR**





Wheel Kits ■ Lined Shoes ■ Brake Lining Options by Axle Rating

	Axle Rating (lbs.)	Wheel Kit	Wheel Kit with B-Lock™	Lined Shoe	Lined Shoe with B-Lock™	Brake Lining
Horizon SP20	20K	WKS4515QSP20	WKS415QSP20BL	LSS4515QSP20	LSS4515QSP20BL	4515CDSP20/4515EDSP20
Crest XL	20K	WKS4515QCXL	WKS4515QCXLBL	LSS4515QCXL	LSS4515QCXLBL	4515CDCXL/4515EDCXL
Horizon SP23	23K	WKS415QSP23	WKS415QSP23BL	LSS415QSP23	LSS415QSP23BL	4515EDSP23
Vista HP	23K	WKS415QVHP	WKS415QVHPBL	LSS415QVHP	LSS415QVHPBL	4515EDVHP
Ultra Peak BRT	23K	WKS415QBRT	WKS415QBRTBL	LSS415QBRT	LSS415QBRTBL	4515EDBRT
Ultra Peak FT	26K	WKS415QFT	WKS415QFTBL	LSS415QFT	LSS415QFTBL	4515EDBFT

Wheel Kits ■ Lined Shoes ■ Brake Lining Options by Axle Rating

	Axle Rating (lbs.)	Wheel Kit	Wheel Kit with B-Lock™	Lined Shoe	Lined Shoe with B-Lock™	Brake Lining
Horizon SP20	20K	WK4515QSP20	WK4515QSP20BL	LS4515QSP20	LS4515QSP20BL	4515EDSP20/4515CDSP20
Crest XL	20K	WK4515QCXL	WK4515QCXLBL	LS4515QCXL	LS4515QCXLBL	4515EDCXL/4515CDCXL
Horizon SP23	23K	WK4515QSP23	WK4515QSP23BL	LS4515QSP23	LS4515QSP23BL	4515EDSP23
Vista HP	23K	WK4515QVHP	WK4515QVHPBL	LS4515QVHP	LS4515QVHPBL	4515EDVHP
Ultra Peak BRT	23K	WK4515QBRT	WK4515QBRTBL	LS4515QBRT	LS4515QBRTBL	4515EDBRT
Vista HP1	25K	WK4515QVHP1	NA	LS4515QVHP1	NA	4515EDVHP1
Ultra Peak FT	26K	WK4515QFT	WK4515QFTBL	LS4515QFT	LS4515QFTBL	4515EDFT

New Shoes:



STEMCO
New Steel
Part #
NS-S4515Q

New Shoes:



STEMCO
New Steel
Part #
NS-4515Q

Hardware Kit:

1 Kit: **SK1650QHD** 10 Kits: **BSK1650QHD** 720 Kits: **ASK1650QHD**



Hardware Kit:

1 Kit: **SK1650QHD** 10 Kits: **BSK1650QHD** 720 Kits: **ASK1650QHD**





Wheel Kits ■ Lined Shoes ■ Brake Lining Options by Axle Rating

	Axle Rating (lbs.)	Wheel Kit	Wheel Kit with B-Lock™	Lined Shoe	Lined Shoe with B-Lock™	Brake Lining
Horizon SP20	20K	WK4515X3SP20	WK4515X3SP20BL	LS4515X3SP20	LS4515X3SP20BL	4515EDSP/4515CDSP20
Crest XL	20K	WK4515X3CXL	WK4515X3CXLBL	LS4515X3CXL	LS4515X3CXLBL	4515EDCXL/4515CDCXL
Horizon SP23	23K	WK4515X3SP23	WK4515X3SP23BL	LS4515X3SP23	LS4515X3SP23BL	4515EDSP23
Vista HP	23K	WK4515X3VHP	WK4515X3VHPBL	LS4515X3VHP	LS4515X3VHPBL	4515EDVHP
Ultra Peak BRT	23K	WK4515X3BRT	WK4515X3BRTBL	LS4515X3BRT	LS4515X3BRTBL	4515EDBRT
Vista HP1	25K	WK4515X3VHP1	NA	LS4515X3VHP1	NA	4515EDVHP1
Ultra Peak FT	26K	WK4515X3FT	WK4515X3FTBL	LS4515X3FT	LS4515X3FTBL	4515EDFT

Wheel Kits ■ Lined Shoes ■ Brake Lining Options by Axle Rating

	Axle Rating (lbs.)	Wheel Kit	Wheel Kit with B-Lock™	Lined Shoe	Lined Shoe with B-Lock™	Brake Lining
Crest XL	20K	WK4524QCXL	WK4524QCXLBL	LS4524QCXL	LS4524QCXLBL	4524BDCXL
Vista HP	23K	WK4524QVHP	WK4524QVHPBL	LS4524QVHP	LS4524QVHPBL	4524BDVHP
Ultra Peak BRT	23K	WK4524QBRT	NA	LS4524QBRT	NA	4524BDBRT
Ultra Peak FT	26K	WK4524QFT	NA	LS4524QFT	NA	4524BDFT

New Shoes:



STEMCO
New Steel
Part #
NS-4515X3

New Shoes:



STEMCO
New Steel
Part #
NS-4524Q

Hardware Kit:

1 Kit: **SK1650X3HD** 10 Kits: **BSK1650X3HD**



Hardware Kit:

1 Kit: **SK1650QHD** 10 Kits: **BSK1650QHD** 720 Kits: **ASK1650QHD**





Wheel Kits ■ Lined Shoes ■ Brake Lining Options by Axle Rating

	Axle Rating (lbs.)	Wheel Kit	Wheel Kit with B-Lock™	Lined Shoe	Lined Shoe with B-Lock™	Brake Lining
Crest XL	20K	WK4524QMCXL	WK4524QMCXLBL	LS4524QMCXL	LS4524QMCXLBL	4524BDCXL
Vista HP	23K	WK4524QMVHP	WK4524QMVHPBL	LS4524QMVHP	LS4524QMVHPBL	4524BDVHP
Ultra Peak BRT	23K	WK4524QMBRT	NA	LS4524QMBRT	NA	4524BDBRT
Ultra Peak FT	26K	WK4524QMFT	NA	LS4524QMFT	NA	4524BDFT

Wheel Kits ■ Lined Shoes ■ Brake Lining Options by Axle Rating

	Axle Rating (lbs.)	Wheel Kit	Wheel Kit with B-Lock™	Lined Shoe	Lined Shoe with B-Lock™	Brake Lining
Crest XL	20K	WK4551QCXL	WK4551QCXBL	LS4551QCXL	LS4551QCXLBL	4551BDCXL
Vista HP	23K	WK4551QVHP	WK4551QVHPBL	LS4551QVHP	LS4551QVHPBL	4551BDVHP
Ultra Peak BRT	23K	WK4551QBRT	WK4551QBRTBL	LS4551QBRT	LS4551QBRTBL	4551BDBRT

New Shoes:



STEMCO
New Steel
Part #
NS-4524QM

New Shoes:



STEMCO
New Steel
Part #
NS-4551Q

Hardware Kit:

1 Kit: **SK1650QFR**
10 Kits: **BSK1650QFR**



Hardware Kit:

1 Kit: **SK1650QHD**
10 Kits: **BSK1650QHD**
720 Kits: **ASK1650QHD**





Wheel Kits ■ Lined Shoes ■ Brake Lining Options by Axle Rating

	Axle Rating (lbs.)	Wheel Kit	Wheel Kit with B-Lock™	Lined Shoe	Lined Shoe with B-Lock™	Brake Lining
Crest XL	20K	WK4591DXCXL	NA	LS4591DXCXL	NA	4591DCXL
Vista HP	23K	WK4591DXVHP	NA	LS451DXVHP	NA	4591DVHP
Ultra Peak BRT	23K	WK4591DXBRT	NA	LS4591DXBRT	NA	4591DBRT

Wheel Kits ■ Lined Shoes ■ Brake Lining Options by Axle Rating

	Axle Rating (lbs.)	Wheel Kit	Wheel Kit with B-Lock™	Lined Shoe	Lined Shoe with B-Lock™	Brake Lining
Crest XL	20K	WK4591SFCXL	NA	LS4591SFCXL	NA	4591DCXL
Vista HP	23K	WK4591SFVHP	WK4591SFVHPBL	LS4591SFVHP	NA	4591DVHP
Ultra Peak BRT	23K	WK4591SFBRT	NA	LS4591SFBRT	NA	4591DBRT

New Shoes:



STEMCO
New Steel
Part #
NS-4591DX

New Shoes:



STEMCO
New Steel
Part #
NS-4591SF

Hardware Kit:

1 Kit: **SK1225DXPQ** 10 Kits: **BSK1225DXPQ**



Hardware Kit:

1 Kit: **SK1225SF**





Wheel Kits ■ Lined Shoes ■ Brake Lining Options by Axle Rating

	Axle Rating (lbs.)	Wheel Kit	Wheel Kit with B-Lock™	Lined Shoe	Lined Shoe with B-Lock™	Brake Lining
Crest XL	20K	WK4692DFCCXL	WK492DFCCXLBL	LS4692DFCCXL	LS4692DFCCXBL	4692DCXL
Vista HP	23K	WK4692DFCVHP	WK4692DFCVHPBL	LS4692DFCVHP	LS4692DFCVHPBL	4692DVHP
Ultra Peak BRT	23K	WK4692DFCBRT	WK4692DFCBRTBL	LS4692DFCBRT	LS4692DFCBRTBL	4692DBRT

Wheel Kits ■ Lined Shoes ■ Brake Lining Options by Axle Rating

	Axle Rating (lbs.)	Wheel Kit	Wheel Kit with B-Lock™	Lined Shoe	Lined Shoe with B-Lock™	Brake Lining
Crest XL	20K	WK4702QCXL	WK4702QCXLBL	LS4702QCXL	LS4702QCXLBL	4702DCXL
Vista HP	23K	WK4702QVHP	WK4702QVHPBL	LS4702QVHP	LS4702QVHPBL	4702DVHP
Ultra Peak BRT	23K	WK4702QBRT	WK4702QBRTBL	LS4702QBRT	LS4702QBRTBL	4702DBRT
Ultra Peak FT	26K	WK4702QT	WK4702QFTBL	LS4702QFT	LS4702QFTBL	4702DFT

New Shoes:



STEMCO
New Steel
Part #
NS-4692DFC

New Shoes:



STEMCO
New Steel
Part #
NS-4702Q

Hardware Kit: 1 Kit SK1225DFC 10 Kits BSK1225DFC



Hardware Kit: 1 Kit SK1500QP 10 Kits BSK1500QP





Wheel Kits ■ Lined Shoes ■ Brake Lining Options by Axle Rating

	Axle Rating (lbs.)	Wheel Kit	Wheel Kit with B-Lock™	Lined Shoe	Lined Shoe with B-Lock™	Brake Lining
Crest XL	20K	WK4703QCXL	WK4703QCXLBL	LS4703QCXL	LS4703QCXLBL	4703DCXL
Vista HP	23K	WK4703QVHP	WK4703QVHPBL	LS4703QVHP	LS4703QVHPBL	4703DVHP
Ultra Peak BRT	23K	WK4703QBRT	WK4703QBRTBL	LS4703QBRT	LS4703QBRTBL	4703DBRT
Ultra Peak FT	23K	WK4703QFT	WK4703QFTBL	LS4703QFT	LS4703QFTBL	4703DFT

Wheel Kits ■ Lined Shoes ■ Brake Lining Options by Axle Rating

	Axle Rating (lbs.)	Wheel Kit	Wheel Kit with B-Lock™	Lined Shoe	Lined Shoe with B-Lock™	Brake Lining
Crest XL	20K	WK4704QCXL	WK4704QCXLBL	LS4704QCXL	LS4704QCXLBL	4704DCXL
Ultra Peak BRT	23K	WK4704QBRT	WK4704QBRTBL	LS4704QBRT	LS4704QBRTBL	4704DBRT

New Shoes:



STEMCO
New Steel
Part #
NS-4703Q

New Shoes:



STEMCO
New Steel
Part #
NS-4704Q

Hardware Kit:

1 Kit: **SK1500QP**
10 Kits: **BSK1500QP**



Hardware Kit:

1 Kit: **SK1500QP**
10 Kits: **BSK1500QP**





Wheel Kits ■ Lined Shoes ■ Brake Lining Options by Axle Rating

	Axle Rating (lbs.)	Wheel Kit	Wheel Kit with B-Lock™	Lined Shoe	Lined Shoe with B-Lock™	Brake Lining
Horizon SP20	20K	WKS4707QSP20	WKS4707QSP20BL	LSS4707QSP20	LSS4707QSP20BL	4707DSP20
Crest XL	20K	WKS4707QCXL	WKS4707QCXLBL	LSS4707QCXL	LSS4707QCXLBL	4707DCXL
Horizon SP23	23K	WKS4707QSP23	WKS4707QSP23BL	LSS4707QSP23	LSS4707QSP23BL	4707DSP23
Vista HP	23K	WKS4707QVHP	WKS4707QVHPBL	LSS4707QVHP	LSS4707QVHPBL	4707DVHP
Ultra Peak BRT	23K	WKS4707QBRT	WKS4707QBRTBL	LSS4707QBRT	LSS4707QBRTBL	4707DBRT
Ultra Peak FT	26K	WKS407QFT	WKS4707QFTBL	LSS4707QFT	LSS4707QFTBL	4707DFT

Wheel Kits ■ Lined Shoes ■ Brake Lining Options by Axle Rating

	Axle Rating (lbs.)	Wheel Kit	Wheel Kit with B-Lock™	Lined Shoe	Lined Shoe with B-Lock™	Brake Lining
Horizon SP20	20K	WK4707QSP20	WK4707QSP20BL	LS4707QSP20	LS4707QSP20BL	4707DSP20
Crest XL	20K	WK4707QCXL	WK4707QCXLBL	LS4707QCXL	LS4707QCXLBL	4707DCXL
Horizon SP23	23K	WK4707QSP23	WK4707QSP23BL	LS4707QSP23	LS4707QSP23BL	4707DSP23
Vista HP	23K	WK4707QVHP	WK4707QVHPBL	LS4707QVHP	LS4707QVHPBL	4707DVHP
Ultra Peak BRT	23K	WK4707QBRT	WK4707QBRTBL	LS4707QBRT	LS4707QBRTBL	4707DBRT
Vista HP1	25K	WK4707QVHP1	NA	LS4707QVHP1	NA	4707DVHP1
Ultra Peak FT	26K	WK4707QFT	WK4707QFTBL	LS4707QFT	LS4707QFTBL	4707DFT

New Shoes:



STEMCO
New Steel
Part #
NS-4707Q

New Shoes:



STEMCO
New Steel
Part #
NS-4707Q

Hardware Kit:

1 Kit: **SK1650QHD** 10 Kits: **BSK1650QHD** 720 Kits: **ASK1650QHD**



Hardware Kit:

1 Kit: **SK1650QHD** 10 Kits: **BSK1650QHD** 720 Kits: **ASK1650QHD**





Relocated Spring Pin hole for steer application



Wheel Kits ■ Lined Shoes ■ Brake Lining Options by Axle Rating

	Axle Rating (lbs.)	Wheel Kit	Wheel Kit with B-Lock™	Lined Shoe	Lined Shoe with B-Lock™	Brake Lining
Vista HP	23K	WK4707QRVHP	NA	LS4707QRVHP	NA	4707DVHP
Ultra Peak BRT	23K	WK4707QRBRT	NA	LS4707QBRT	NA	4707DBRT
Ultra Peak FT	26K	WK4707QRFT	NA	LS4707QFT	NA	4707DFT

Wheel Kits ■ Lined Shoes ■ Brake Lining Options by Axle Rating

	Axle Rating (lbs.)	Wheel Kit	Wheel Kit with B-Lock™	Lined Shoe	Lined Shoe with B-Lock™	Brake Lining
Horizon SP20	20K	WK4709E2SP20	WK4709E2SP20BL	LS4709E2SP20	LS4709E2SP20BL	4709DSP20
Crest XL	20K	WK4709E2CXL	WK4709E2CXLBL	LS4709E2CXL	LS4709E2CXLBL	4709DCXL
Horizon SP23	23K	WK4709E2SP23	WK4709E2SP23BL	LS4709E2SP23	LS4709E2SP23BL	4709DSP23
Vista HP	23K	WK4700E2VHP	WK4709E2VHPBL	LS4709E2VHP	LS4709EVHPBL	4709DVHP
Ultra Peak BRT	23K	WK4709E2BRT	WK4709E2BRTBL	LS4709E2BRT	LS4709E2BRTBL	4709DBRT
Vista HP1	25K	WK4709E2VHP1	NA	LS4709E2VHP	NA	4709DVHP1
Ultra Peak FT	26K	WK4709E2FT	WK4709E2FTBL	LS4709E2FT	LS4709E2FTBL	4709DFT

New Shoes:



STEMCO
New Steel
Part #
NS-4707QR

New Shoes:



STEMCO
New Steel
Part #
NS-4709E2

Hardware Kit:

1 Kit: **SK1650QFR** 10 Kits: **BSK1650QFR**



Hardware Kit:

1 Kit: **SK1650E2** 10 Kits: **BSK1650E2** 720 Kits: **ASK1650E2**





Tabs for Springs



Wheel Kits ■ Lined Shoes ■ Brake Lining Options by Axle Rating

	Axle Rating (lbs.)	Wheel Kit	Wheel Kit with B-Lock™	Lined Shoe	Lined Shoe with B-Lock™	Brake Lining
Horizon SP20	20K	WK4709ESP20	WK4709ESP20BL	LS4709ESP20	LS4709ESP20BL	4709DSP20
Crest XL	20K	WK4709ECXL	WK4709ECXLBL	LS4709ECXL	LS4709ECXLBL	4709DCXL
Horizon SP23	23K	WK4709ESP23	WK4709ESP23BL	LS4709ESP23	LS4709ESP23BL	4709DSP23
Vista HP	23K	WK4709EVHP	WK4709EVHPBL	LS4709EVHP	LS4709EVHPBL	4709DVHP
Ultra Peak BRT	23K	WK4709EBRT	WK4709EBRTBL	LS4709EBRT	LS4709EBRTBL	4709DBRT
Ultra Peak FT	26K	WK4709EFT	WK4709EFTBL	LS4709EFT	LS4709EFTBL	4709DFT

Wheel Kits ■ Lined Shoes ■ Brake Lining Options by Axle Rating

	Axle Rating (lbs.)	Wheel Kit	Wheel Kit with B-Lock™	Lined Shoe	Lined Shoe with B-Lock™	Brake Lining
Crest XL	20K	WK4710QCXL	WK4710QCXLBL	LS4710QCXL	LS4710QCXLBL	4710DCXL
Vista HP	23K	WK4710QVHP	WK4710QVHPBL	LS4710QVHP	LS4710QVHPBL	4710DVHP
Ultra Peak BRT	23K	WK4710QBRT	WK4710QBRTBL	LS4710QBRT	LS4710QBRTBL	4710DBRT
Ultra Peak FT	26K	WK4710QFT	WK4710QFTBL	LS4710QFT	LS4710QFTBL	4710DFT

New Shoes:



STEMCO New Steel Part # NS-4709E

Tabs for Springs

New Shoes:



STEMCO New Steel Part # NS-4710Q

Hardware Kit:

1 Kit: **SK1650E1** 10 Kits: **BSK1650E1**



Hardware Kit:

1 Kit: **SK1650QH** 10 Kits: **BSK1650QH** 720 Kits: **ASK1650QH**





Wheel Kits ■ Lined Shoes ■ Brake Lining Options by Axle Rating

	Axle Rating (lbs.)	Wheel Kit	Wheel Kit with B-Lock™	Lined Shoe	Lined Shoe with B-Lock™	Brake Lining
Crest XL	20K	WK4711QCXL	WK4711QCXLBL	LS4711QCXL	LS4711QCXLBL	4711DCXL
Vista HP	23K	WK4711QVHP	WK4711QVHPBL	LS4711QVHP	LS4711QVHPBL	4711DVHP
Ultra Peak BRT	23K	WK4711QBRT	WK4711QBRTBL	LS4711QBRT	LS4711QBRTBL	4711DBRT
Ultra Peak FT	26K	WK4711QFT	WK4711QFTBL	LS4711QFT	LS4711QFTBL	4711DFT

Wheel Kits ■ Lined Shoes ■ Brake Lining Options by Axle Rating

	Axle Rating (lbs.)	Wheel Kit	Wheel Kit with B-Lock™	Lined Shoe	Lined Shoe with B-Lock™	Brake Lining
Crest XL	20K	WK4715QCXL	WK4715QCXLBL	LS4715QCXL	LS4715QCXLBL	4715DCXL
Vista HP	23K	WK4715QVHP	WK4715QVHPBL	LS4715QVHP	LS4715QVHPBL	4715DVHP
Ultra Peak BRT	23K	WK4715QBRT	WK4715QBRTBL	LS4715QBRT	LS4715QBRTBL	4715DBRT
Ultra Peak FT	26K	WK4715QFT	WK4715QFTBL	LS4715QFT	LS4715QFTBL	4715DFT

New Shoes:



STEMCO
New Steel
Part #
NS-4711Q

New Shoes:



STEMCO
New Steel
Part #
NS-4715Q

Hardware Kit:

1 Kit: **SK1650QHD** 10 Kits: **BSK1650QHD** 720 Kits: **ASK1650QHD**



Hardware Kit:

1 Kit: **SK1650QFR** 10 Kits: **BSK1650QFR**





Wheel Kits ■ Lined Shoes ■ Brake Lining Options by Axle Rating

	Axle Rating (lbs.)	Wheel Kit	Wheel Kit with B-Lock™	Lined Shoe	Lined Shoe with B-Lock™	Brake Lining
Crest XL	20K	WK4718QCXL	WK4718QCXLBL	LS4718QCXL	LS4718QCXLBL	4718DCXL
Vista HP	23K	WK4718QVHP	WK4718QVHPBL	LS4718QVHP	LS4718QVHPBL	4718DVHP
Ultra Peak BRT	23K	WK4718QBRT	WK4718QBRTBL	LS4718QBRT	LS4718QBRTBL	4718DBRT

Wheel Kits ■ Lined Shoes ■ Brake Lining Options by Axle Rating

	Axle Rating (lbs.)	Wheel Kit	Wheel Kit with B-Lock™	Lined Shoe	Lined Shoe with B-Lock™	Brake Lining
Crest XL	20K	WK4719E2CXL	WK4719E2CXLBL	LS4719E2CXL	LS4719E2CXLBL	4719DCXL
Vista HP	23K	WK4719E2VHP	WK4719E2VHPBL	LS4719E2VHP	LS4719E2VHPBL	4719DVHP
Ultra Peak BRT	23K	WK4719E2BRT	WK4719E2BRTBL	LS4719E2BRT	LS4719E2BRTBL	4719DBRT
Ultra Peak FT	26K	WK4719E2FT	WK4719E2FTBL	LS4719E2FT	LS4719E2FTBL	4719DFT

New Shoes:



STEMCO
New Steel
Part #
NS-4718Q

New Shoes:



STEMCO
New Steel
Part #
NS-4719E2

Hardware Kit:

1 Kit: **SK1650QHD** 10 Kits: **BSK1650QHD** 720 Kits: **ASK1650QHD**



HD Return Spring
1 1/4" O.D. 8 3/8" Length
Qty. 1

Spring Pin
Qty. 2

Retainer Spring
Qty. 2

Knurled Roller
Qty. 2

Roller Retainer
Qty. 2

Anchor Pin
Qty. 2

Bushing
Qty. 2

Hardware Kit:

1 Kit: **SK1650E2FR** 10 Kits: **BSK1650E2FR**



HD Return Spring
10 3/4" Length
Qty. 1

Retainer Spring
Qty. 2

Knurled Roller
Qty. 2

Roller Retainer
Qty. 2

Return Spring*
(for horse collar)
Qty. 2

*Note: Kit contains both single return spring or two horse collar return springs depending on style and hub clearance, use the appropriate version



Wheel Kits ■ Lined Shoes ■ Brake Lining Options by Axle Rating

	Axle Rating (lbs.)	Wheel Kit	Wheel Kit with B-Lock™	Lined Shoe	Lined Shoe with B-Lock™	Brake Lining
Crest XL	20K	WK4720QCXL	WK4720QCXLBL	LS4720QCXL	LS4720QCXLBL	4720DCXL
Vista HP	23K	WK4720QVHP	WK4720QVHPBL	LS4720QVHP	LS4720QVHPBL	4720DVHP
Ultra Peak BRT	23K	WK4720QBRT	WK4720QBRTBL	LS4720QBRT	LS4720QBRTBL	4720DBRT
Ultra Peak FT	26K	WK4720QFT	WK4720QFTBL	LS4720QFT	LS4720QFTBL	4720DFT

Wheel Kits ■ Lined Shoes ■ Brake Lining Options by Axle Rating

	Axle Rating (lbs.)	Wheel Kit	Wheel Kit with B-Lock™	Lined Shoe	Lined Shoe with B-Lock™	Brake Lining
Crest XL	20K	WK4725E2CXL	WK4725E2CXLBL	LS4725E2CXL	LS4725E2CXLBL	4725DCXL
Vista HP	23K	WK4725E2VHP	WK4725E2VHPBL	LS4725E2VHP	LS4725E2VHPBL	4725DVHP
Ultra Peak BRT	23K	WK4725E2BRT	WK4725E2BRTBL	LS4725E2BRT	LS4725E2BRTBL	4725DBRT
Ultra Peak FT	26K	WK4725E2FT	WK4725E2FTBL	LS4725E2FT	LS4725E2FTBL	4725DFT

New Shoes:



STEMCO
New Steel
Part #
NS-4720Q

New Shoes:



STEMCO
New Steel
Part #
NS-4725E2

Hardware Kit:

1 Kit: **SK1650QFR** 10 Kits: **BSK1650QFR**



Hardware Kit:

1 Kit: **SK1650E2FR** 10 Kits: **BSK1650E2FR**



*Note: Kit contains both single return spring or two horse collar return springs depending on style and hub clearance, use the appropriate version



12 1/4" Diameter

Wheel Kits ■ Lined Shoes ■ Brake Lining Options by Axle Rating

	Axle Rating (lbs.)	Wheel Kit	Wheel Kit with B-Lock™	Lined Shoe	Lined Shoe with B-Lock™	Brake Lining
Crest XL	20K	WK4726E2CXL	WK4726E2CXLBL	LS4726E2CXL	LS4726E2CXLBL	4726DCXL
Vista HP	23K	WK4726E2VHP	WK4726E2VHPBL	LS4726E2VHP	LS4726E2VHPBL	4726DVHP
Ultra Peak BRT	23K	WK4726E2BRT	WK4726E2BRTBL	LS4726E2BRT	LS4726E2BRTBL	4726DBRT
Ultra Peak FT	26K	WK4726E2FT	WK4726E2FTBL	LS4726E2FT	LS4726E2FTBL	4726DFT



DANA

Shoe #	Width	Lining
NS-4536DP	5 1/2"	4536B
NS-4692DP	7 1/2"	4692

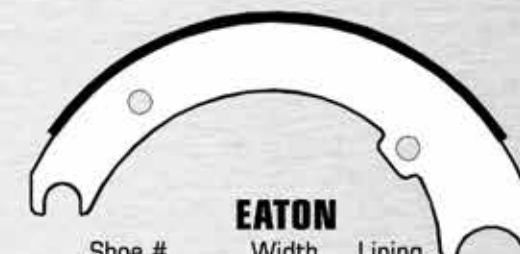

EATON

Shoe #	Width	Lining
NS-4536E	5 1/2"	4536A
NS-4591E	7 1/2"	4591



DANA

Shoe #	Width	Lining
NS-4536DFC	5 1/2"	4536B
NS-4692DFC	7 1/2"	4692

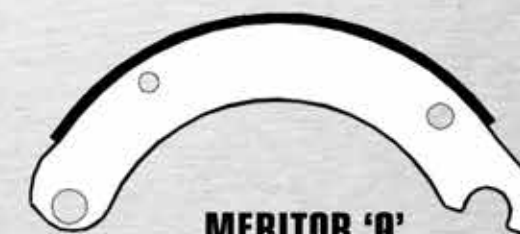

MERITOR 'Q'
(fast change)

Shoe #	Width	Lining
NS-4670Q	7 1/2"	4670
NS-4591ST	7 1/2"	4591

New Shoes:



STEMCO
New Steel
Part #
NS-4726E2

Hardware Kit:

1 Kit	10 Kits	720 Kits
SK1650E2	BSK1650E2	ASK1650E2

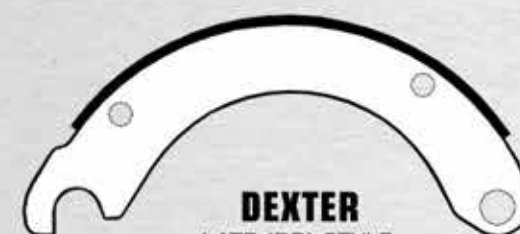

DEXTER
LATE (PQ) STYLE

Shoe #	Width
NS-4700DX	4"
NS-4661CDX	5"
NS-4591DX	7 1/2"



STD. FORGE

Shoe #	Width	Lining
NS-4536SF	5 1/2"	4536B
NS-4591SF	7 1/2"	4591

Replaces early design quick maintenance (QM) style which was open on both ends.

15" Single Web



EATON
(front)

Shoe #	Width	Lining
NS-1308E	4"	1308TT

1 1/4"



EATON (ES)
Extended Service

Shoe #	Width	Lining
NS-1443E	4"	1443TT

Web stamping 807686



MERITOR 'T'
(front)

Shoe #	Width	Lining
NS-1307P	3 1/2"	1307
NS-1308P	4"	1308



MERITOR WEDGE
Stopmaster

Shoe #	Width	Lining
---	3 1/2"	4562A
---	5"	4615
NS-4605S	6"	4605
NS-4602S	7"	4602



ST

RHD
QUICK CHANGE

Shoe #	Width	Lining
NS-1308Q	4"	1308

This shoe is equivalent to current Meritor 'Q'.
Anchor opening is unique RHD anti-chatter design.



BENDIX WEDGE

Shoe #	Width	Lining
NS-4605B	6"	4605
NS-4602B	7"	4602

15" Double Web



BENDIX
(Ford Cargo front)

Shoe #	Width	Lining
NS-4693B	4"	4693



DANA
HEAVY AXLE

Shoe #	Width	Lining
4693 DHA	4"	4693

Note: For Identifications Purposes Only.
Shoe is Not Manufactured



EATON

Shoe #	Width	Lining
NS-4729E	4"	4729

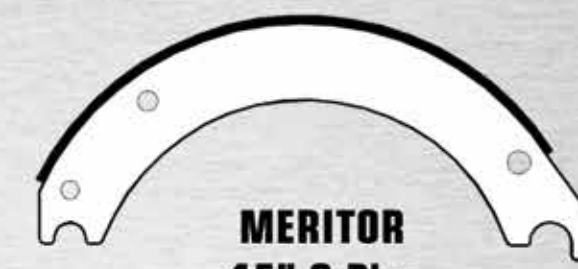

MERITOR
15" Q Plus
extended service shoes (double web)

Shoe #	Width	Lining
NS-4702Q	4"	4702
NS-4703Q	5"	4703
NS-4704Q	6"	4704
NS-4705Q	7"	4705
NS-4710Q	8 5/8"	4710

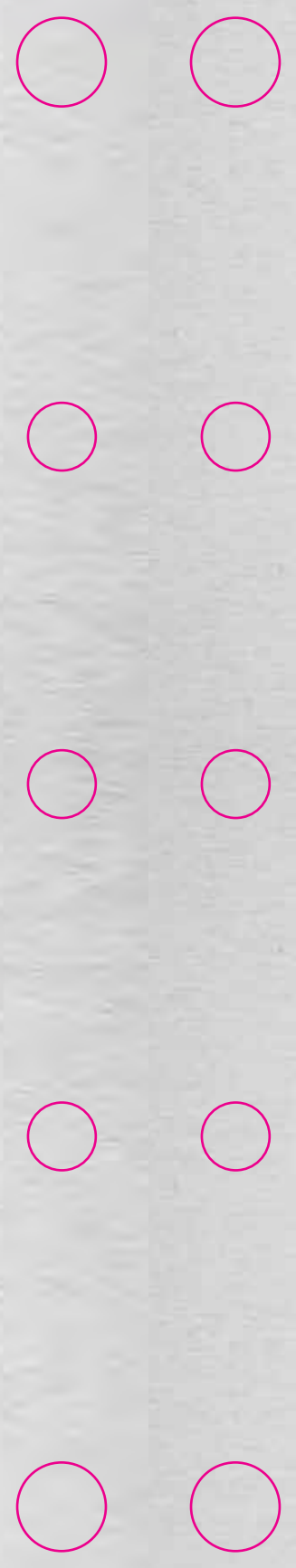

16.5" Diameter



EATON
extended service shoe
for Meritor axles

Shoe #	Width	Lining
NS-4708Q	7"	4708



EATON
(Extended Service and ESII)

Shoe #	Width	Lining
NS-4719E2	5"	4719
NS-4725E2	6"	4725
NS-4709E	7"	4709
NS-4709E2	7"	4709
NS-4726E2	8 5/8"	4726



EATON
SINGLE ANCHOR PIN

Shoe #	Width	Lining
NS-4223E	5"	4223A
NS-4223EHM	5"	4223A
NS-4317E	6"	4317G
NS-4317EHM	6"	4317G
NS-4311E	7"	4311J/G
NS-4311EHM	7"	4311J/G
NS-4674E	8 5/8"	4674

Std. mount measures 4" at A.
High mount is 3 9/16"



FRUEHAUF XEM
3rd Design

Shoe #	Width	Lining
NS-4515X3	7"	4515E/G
NS-4551X3L*	8 5/8"	4551B
NS-4551X3R*	8 5/8"	4551B

*offset webs

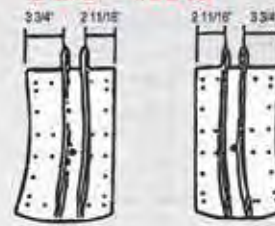

FRUEHAUF 'Q'
Meritor design for
Fruehauf application.
Designated ESF or F5

Shoe #	Width	Lining
NS-4515F5	7"	4515E/G

NOT INTERCHANGEABLE
WITH STANDARD 'Q'



FRUEHAUF
"P" STYLE

Shoe #	Width	Lining
NS-4515F	7"	4515E/G
NS-4551FL*	8 5/8"	4551B
NS-4551FR*	8 5/8"	4551B

*offset webs

16.5" Diameter



MERITOR
Q PLUS BRAKE

Shoe #	Width	Lining
NS-4720Q	5"	4720
NS-4715Q	6"	4715
NS-4707Q	7"	4707
NS-4718Q	8"	4718
NS-4711Q	8 5/8"	4711

Requires ext. life s-cam.

Web stampings: Meritor is marked Q+
STEMCO is marked XT.



RHD/DANA
QUICK CHANGE
(Equivalent to 'Q' style)
Features improved anchor slot design.

Shoe #	Width	Lining
NS-4549Q	4"	4549C
NS-4524Q	5"	4524B
NS-4524QM#	5"	4524B
NS-4514Q	6"	4514G
NS-4514QM#	6"	4514G
NS-4515Q	7"	4515E/G
NS-4644Q	8"	4644A
NS-4551Q	8 5/8"	4551B
4552ST	10"	4552
NS-4514/49Q	10"	4514G/4549C

offset pin location for Mack

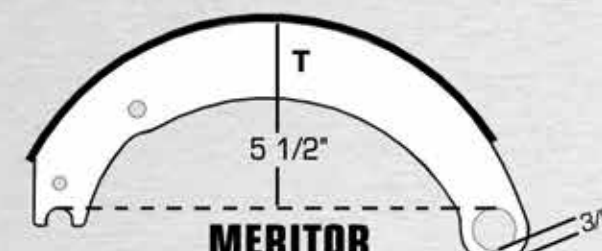

MERITOR
"P" STYLE

Shoe #	Width	Lining
NS-4549P	4"	4549C
NS-4524P	5"	4524B
NS-4524PM#	5"	4524B
NS-4514P	6"	4514G
NS-4514PM#	6"	4514G
NS-4515P	7"	4515E/G
4644ET	8"	4644A
NS-4551P	8 5/8"	4551B
4552T	10"	4552
NS-4514/49P	10"	4514G/4549C

offset pin location for Mack

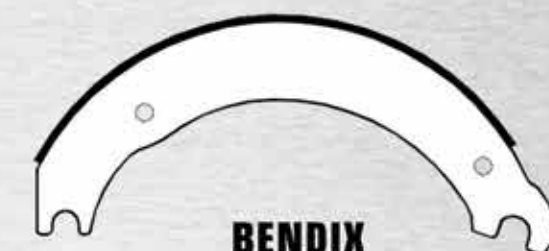

BENDIX
(Ford Cargo)

Shoe #	Width	Lining
NS-4515BQ	7"	4515E/G

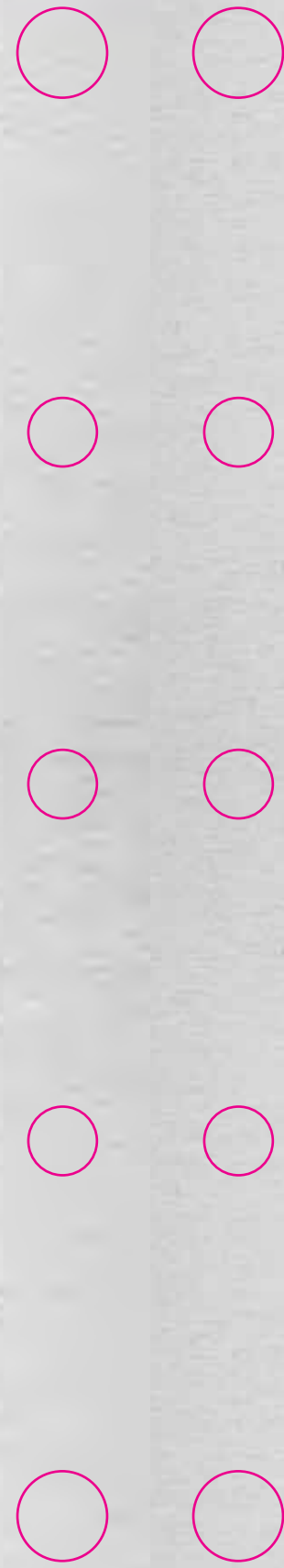

MANUFACTURER	20,000 lb. AXLE MATERIALS			23,000 lb. AXLE MATERIALS			25,000 - 29,000 lb. AXLE MATERIALS		
	ECONOMY	STANDARD	PREMIUM	ECONOMY	STANDARD	PREMIUM	23K SEVERE SERVICE OR COMBO	SEVERE SERVICE	TRANSIT
STEMCO Brake Products		Horizon SP[®] 20	Crest XL[®]		Horizon SP[®] 23	Vista HP[®]	Ultra Peak[®] BRT	Vista HP[®] 1 (25K)	Ultra Peak[®] BRT (26K) Ultra Peak[®] FT (29K)
MERITOR	F520 F540 EC1	MG1	MA212	EC2	MG2 MG2L	MA312 R301		R403	
FRAS-LE	F520 F540	F550-1		F523	F555-1	F557	F560/F555-1 (COMBO)	F587	F787T (28.5K) F557T (26K)
ABEX	XC 6085 VL20	AN 6166 XL 6014	EN 6008-1 EL 6011	VL23	AX 6149	EX 685 SDA 6098	SMC (685/6069) (COMBO)	ED 6028 EH 6040	MX (685) MC (685/697)
BENDIX	BB200 (BLACK) BA200	BA201 (BLUE)	BX380 ES420 BA202R		RED YELLOW	ES600 ES680 BX950	ES1160 (ORANGE)	ES1100 (BRONZE)	
HALDEX	2017 (GN) HV77 HV76	2008 (GF)	2015-2 (GR)	2016 (GD) HV88	2023 (GH)	2020-1 (GG)	2020/2035 (GC)	2035 (GZ) 2040 (GM) 2030 (GP)	TRANSMAX™
MARATHON	MV20	UB	HS20	MV23	FLOE	HS23	MBC MBS	KVT TS	MBST (26K) KVT (28.5K)

MANUFACTURER	20,000 lb. AXLE MATERIALS			23,000 lb. AXLE MATERIALS			25,000 - 29,000 lb. AXLE MATERIALS		
	ECONOMY	STANDARD	PREMIUM	ECONOMY	STANDARD	PREMIUM	23K SEVERE SERVICE OR COMBO	SEVERE SERVICE	TRANSIT
STEMCO Brake Products		Horizon SP[®] 20	Crest XL[®]		Horizon SP[®] 23	Vista HP[®]	Ultra Peak[®] BRT	Vista HP[®] 1 (25K)	Ultra Peak[®] BRT (26K) Ultra Peak[®] FT (29K)
BRF/UAP	M20			M23					
FLEETPRIDE OTR	BLACK BRONZE	BLUE		GREEN	RED		ORANGE	GOLD	
TRUCKPRO		AR1		AR2	AR2	AR3 AR4	ARCM	AR5	
TRP	20EC 20STD	20PREM		23EC 23STD	23PREM				
HEAVY DUTY AMERICA	H20F	H20		H23F	H23				
DAIMLER (ALLIANCE)	20 STD	20PREM		23 STD	23PREM				
NAVISTAR (Renewed)	D2S	D2P		D3S	D3P				
GORILLA BRAKE	GB20STD SB20S	GB20PR SB20P		GB23STD SB23S	GB23PREM SB23P	GB23HD	GBHDC		
VIPAR	20KSTD	20KPREM		23KSTD	23KPREM				

STEMCO
BRAKE PRODUCTS™



HORIZON SP[®] CREST XL[®] VISTA HP[®] ULTRA PEAK[®]

STEMCO
BRAKE PRODUCTS™



HORIZON SP[®] CREST XL[®] VISTA HP[®] ULTRA PEAK[®]

Genuine CentriFuse®

High Performance Brake Drums



Why Choose CentriFuse®?

- **SAFETY** ensured by CentriFuse® Steel Jacket Technology
- **LONGER LIFE** provided by Patented Alloy Braking Surface
- **PROVEN PERFORMANCE** with over 80 Years in the Industry
- **IMPROVE MPG** or Increase Revenue-Producing Payload
- **LIGHTEST WEIGHT** brake drums in the industry!



STEMCO
BRAKE PRODUCTS™



Don't be fooled by imitators, specify Genuine CentriFuse® blue brake drums.

CentriFuse® is Going Blue

Effective October 1, 2015, the color of the brake drum changes from black to STEMCO blue for all CentriFuse® Brake Drums except for CentriFuse HD®, which will remain STEMCO red. The change to blue paint does not affect the fit, form, function or performance of STEMCO CentriFuse® Brake Drums. All part numbers will remain the same, as will the superior quality and performance that you have trusted for over 80 years.

Why Did CentriFuse® Go Blue?

The purpose for this change is to further differentiate the performance and quality of the CentriFuse® product, and to protect the integrity of STEMCO customers' investment in CentriFuse® technology. With offshore imitation and look-a-like drums targeting the industry, STEMCO must ensure that customers are getting the proven quality, reliability, safety, performance, and weight reduction they have come to expect when purchasing Genuine CentriFuse® Brake Drums.

Weight Savings

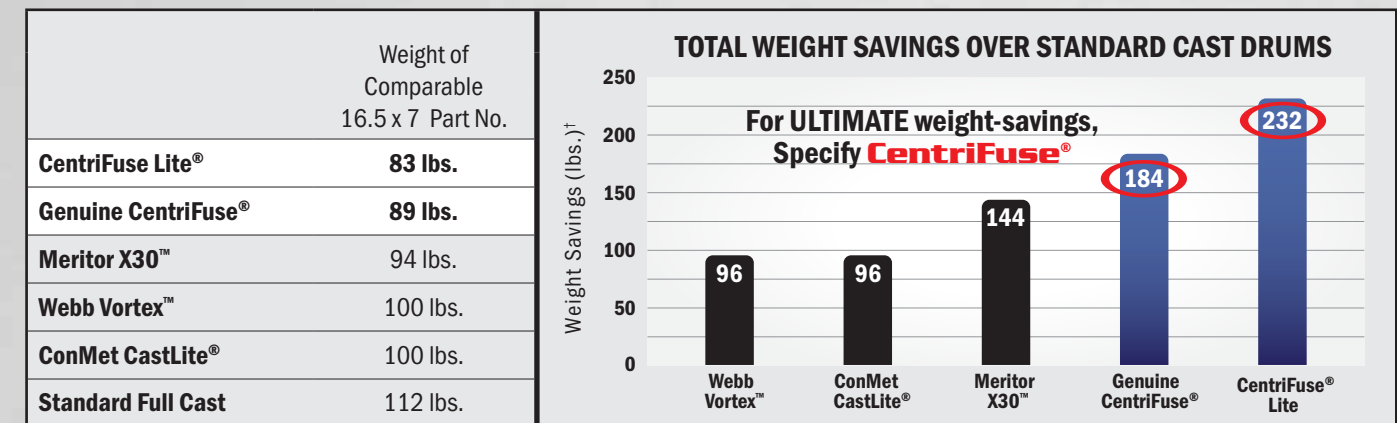

† Weight comparison based on 16.5 x 7 drums on tandem axle tractor with tandem axle trailer. X30™ is a trademark of ArvinMeritor. Vortex™ is a trademark of Webb Wheel Products. CastLite® is a registered trademark of ConMet.

The Difference is in the Details

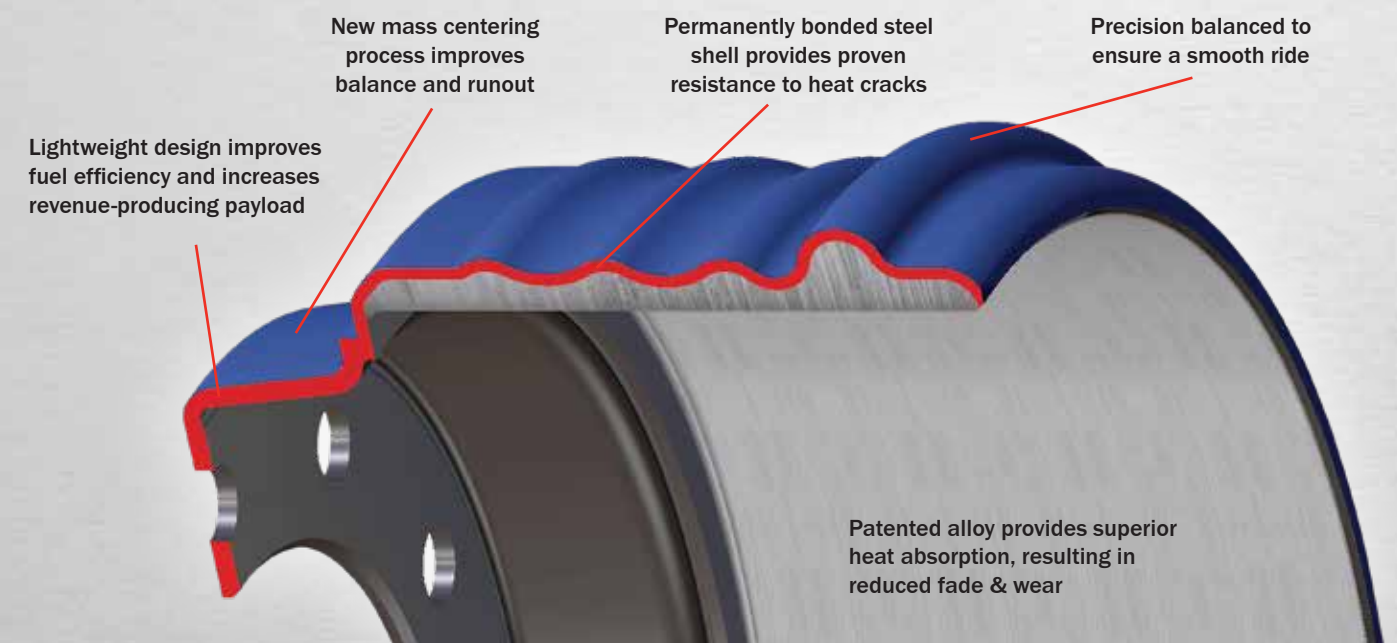

Steel Shell for Safety

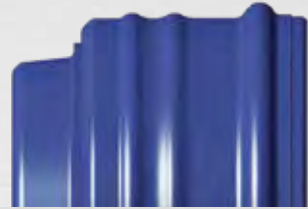

CentriFuse® Lite

The **LIGHTEST** brake drum available in the industry!

- 83 lbs. (16.5" x 7")
- 20,000 Axle Load Rating
- Weight Sensitive Applications
- 10-Year Written Warranty

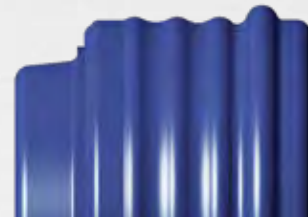

Original CentriFuse®

Proven Performance for All Applications

- 89 lbs. (16.5" x 7") – Many more sizes available!
- 23,000 Axle Load Rating
- The Trusted Brand with Over 80 Years of Excellence!
- 10-Year Written Warranty

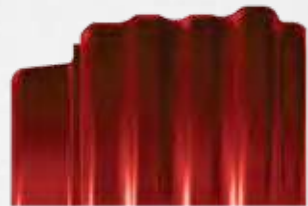

CentriFuse® HD

For Long Life, Safety & Durability in Severe Service Applications

- 100 lbs. (16.5" x 7"), 104 lbs. (16.5" x 8"), 111 lbs. (16.5" x 8.62")
- 26,000 Axle Load Rating
- Specifically Engineered for Heavy Haul, Multi-stop, and Rugged Terrain
- 3-Year Severe Service Written Warranty



CentriFuse® Wide Brake

Lightweight Solution for Maximum Brake Life

- 90 lbs. (16.5" x 8"), 100 lbs. (16.5" x 8.62")
- 23,000 Axle Load Rating
- Available in 16.5" x 8" and 16.5" x 8.62"
- 10-Year Written Warranty

CentriFuse® is an Engineered Product

With the Right Material – In the Right Place – For the Right Reason!



The Industry's Lightest and Strongest Hubs and Drums

Come Together in a Perfect Match

Select one of these high-quality trailer hubs to pair with your choice of our Genuine CentriFuse® High Performance Brake Drums:

Lightweight Hubs

- Lighter and stronger than aluminum with fewer maintenance issues
- Industry-leading lubricant capacity extends bearing and seal life
- Interior and exterior of hubs are E-coated for 1,000 hours of salt spray protection, resulting in the industry's cleanest oil cavities

Ductile Iron Hubs

- Lightest standard ductile iron hubs on the market
- Durable and damage resistant
- Industry-leading lubricant capacity extends bearing and seal life
- Interior and exterior of hubs are E-coated for 1,000 hours of salt spray protection, resulting in the industry's cleanest oil cavities

CentriFuse® Brake Drums

- Steel jacket increases safety
- Patented alloy braking surface reduces fade and wear
- CentriFuse® Lite 16.5x7 83lbs.
- Original CentriFuse® 16.5x7 89lbs.
- CentriFuse® Wide Brake 16.5x8 90lbs. 16.5x8.62 100lbs.

Hub and Drum Assembly Benefits:

- Improve MPG with up to 152 pounds of weight savings per trailer!
- FMVSS-121 compliant, meets or exceeds OEM and SAE standards.
- Specify our Lightweight Hub and Drum assembly with STEMCO bearings and high performance wheel end seals, hub cap, and PRO-TORQ® spindle nut to get our industry-leading 7-year wheel end package warranty.



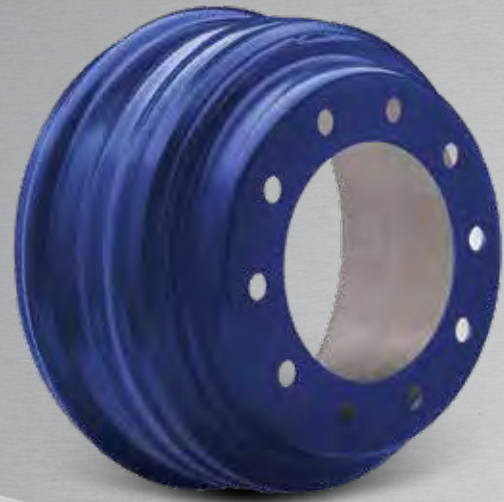

Advanced Braking Technology



Get the safety of CentriFuse®, along with the lightest brake drum in the Industry.

- Industry exclusive steel jacketed 83 lb. CentriFuse® Lite offers up to 232 pounds of weight savings per tractor/trailer combination
- Improve MPG or increase revenue-producing payload
- You get the same proven performance, safety, balance and reliability you trust with Original CentriFuse®
- Lower maintenance costs with CentriFuse® patented alloy braking surface engineered to provide superior heat absorption, resulting in reduced brake fade and wear
- Increase safety with CentriFuse® Steel Jacket technology
- Precision balanced for extended tire life
- Backed by industry leading 10 year written warranty
- Approved OEM component for axle load ratings of 20,000 lbs.



© STEMCO® LP
Part No. 571-3112
Rev. 1/18

SAFETY AT THE LIGHTEST WEIGHT

Applications

CentriFuse® Lite is ideal for Weight Sensitive applications, such as:

- Refrigerated Fleets
- Tanker Fleets
- Bulk Haulers
- Any fleets looking to increase their payload and fuel efficiency

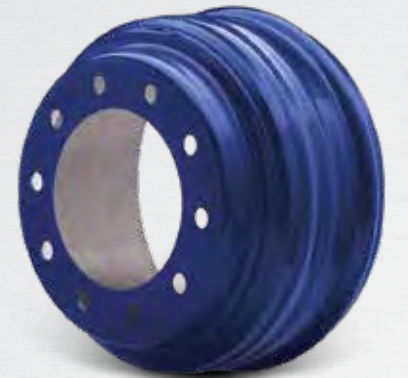

Weight Savings

Save up to 232 lbs. using CentriFuse® Lite!

	Weight of Comparable 16.5 x 7 Part No.	CentriFuse® Lite Weight Savings			
		VERSUS			
		X30™	Vortex™	CastLite®	Cast
CentriFuse Lite®	83 lbs.	88 lbs.	136 lbs.	136 lbs.	232 lbs.
Meritor X30™	94 lbs.	Weight comparison based on 16.5 x 7 drums on tandem axle tractor with tandem axle trailer.			
Webb Vortex™	100 lbs.				
ConMet CastLite®	100 lbs.				
Standard Full Cast	112 lbs.				

X30™ is a trademark of ArvinMeritor. Vortex™ is a trademark of Webb Wheel Products. CastLite® is a registered trademark of ConMet.

CENTRIFUSE® IS AN ENGINEERED PRODUCT

With the Right Material – In the Right Place – For the Right Reason!

CentriFuse® HD

Severe Service Brake Drums



Need Longer Brake Drum and Lining Life? Your Severe Service Solution

For long life, safety and durability in demanding severe service applications.

When it comes to the quality and performance of your brake system, it's your choice. With STEMCO CentriFuse HD Severe Service Brake Drums, you'll be making the decision to fit the best quality, highest performing product available. Engineered and manufactured in the USA to specifically meet the demands of severe service applications like refuse and construction, or where heavy loads need maximum braking performance. Today's fleets demand CentriFuse HD because they're the safest, lightest and longest lasting brake drum.

- Increase safety with CentriFuse HD steel-jacketed drum load rated up to 26,000 lbs.
- Lower maintenance costs and reduce vehicle weight
- Patented Alloy braking surface engineered to provide superior heat absorption, resulting in reduced brake fade and wear
- Precision balanced for extended tire life
- Specifically engineered for heavy haul, multi-stop, and rugged or mountainous terrain



MADE IN USA

STEMCO
BRAKE PRODUCTS™



MADE IN USA

© STEMCO® LP
2018 STEMCO LP
Part No. 571-3111
Rev. 1/18

Demand STEMCO CentriFuse® HD for Severe Conditions

CentriFuse® HD
High Performance Severe Service Brake Drums

Type: Original Steel Shell
Weight: 100 lbs.
Metallurgy: Patented Iron, High Alloy
Durability: ★★★★★
Warranty: 3 Years

Other Brands

Heavy Duty Cast

Type: Full Cast
Weight: 131 lbs.
Metallurgy: Generic Grey Iron
Durability: ★★★
Warranty: 1 Year

Standard Full Cast

Type: Full Cast
Weight: 112 lbs.
Metallurgy: Generic Grey Iron
Durability: ★★
Warranty: 1 Year

Cross Reference

16.5" x 7"			16.5" x 8"			16.5" x 8.62"		
MFR	PART #	WEIGHT	MFR	PART #	WEIGHT	MFR	PART #	WEIGHT
CentriFuse® HD	600004HD	100	CentriFuse® HD	600013HD	104	CentriFuse® HD	600014HD	111
Meritor	123207	112	Gunite	3782	123	ConMet	10025912	137
Meritor	123365	122	Gunite	3891	135	Gunite	3807	127
Gunite	3401	115	Meritor	123520	124	Gunite	3811	157
Gunite	3600A/AX	112	Webb	66800	119	Gunite	3890	133
Gunite	3576/X	131	Webb	66808	119	Meritor	123570	138
Webb	66864/B	112	Webb	78501B	123	Webb	66809	120
Webb	66884/B	119	Webb	78504B	123	Webb	66854	121
Webb	78502B	120				Webb	66855	121
						Webb	78500B	127
						Webb	78505B	127

High Performance Brake Drums



Specifications

Mtg. Type	CentriFuse Drum Part No.	Brake Size	Wt. lb.	Overall Depth	Brake Surf. Width	Hub Pilot Dia.	Bolt Circle Dia.	No. Bolt Holes	Bolt Hole Dia.	Drum Back No.	Drum Band No.	Special Information
0	90089BK	15 x 4	64	8.54	4.58	8.78	285.75	10	1.25	91294	91028	
0	91137BK	15 x 4	64	8.63	4.54	8.78	285.75	10	0.96	91136	91028	CA
0	87945BK	15 x 4	65	8.94	4.60	8.53	11.25	10	1.25	91024	91028	
0	88870BK	15 x 4	64	8.94	4.60	9.00	275	8	0.92	91025	91028	Replaces 85369, 85831, 86140, 86909
0	89870BK	15 x 4	65	8.94	4.60	8.78	285.75	10	1.25	91026	91028	
0	90660BK	15 x 4	64	8.94	4.60	8.78	285.75	10	0.96	91029	91028	
0	90174B	15 x 5	78	9.53	5.81	8.78	285.75	10	1.25	90173	87311	
0	91438B	15 x 8.62	90	11.19	9.11	9.00	275	8	0.92	91439	91480	For industry axles except Meritor TN
0	91482B	15 x 8.62	90	11.19	9.11	8.78	285.75	10	0.96	91481	91480	For industry axles except Meritor TN
0	91723B	15 x 8.62	90	11.44	9.11	9.00	275	8	0.92	91722	91480	For Meritor TN axle only
0	91725B	15 x 8.62	90	11.44	9.11	8.78	285.75	10	0.96	91724	91480	For Meritor TN or TB axle only
0	88739B	16.5 x 5	74	8.59	5.87	8.53	11.25	10	1.25	88435	87369	CA
0	90137B	16.5 x 5	74	8.59	5.87	8.78	285.75	10	1.25	91507	87369	
0	600001	16.5 x 5	75	8.88	5.46	8.78	285.75	10	1.25	90599	87369	
0	88814B	16.5 x 5	76	9.21	5.83	9.00	275	8	0.92	88810	87369	CA
0	90600B	16.5 x 5	76	9.22	5.82	8.78	285.75	10	1.25	90599	87369	0.375 thick mounting
0	600027	16.5 x 5	78	9.22	5.82	8.78	285.75	10	1.25	620020	87369	OEM specified drum
0	88507B	16.5 x 5	77	9.53	5.81	8.53	11.25	10	1.25	88508	87369	CA

Continued on Next Page



High Performance Brake Drums

Safety ■ Longer Life ■ Proven Performance ■ Lightest Weight ■ Improved MPG

Specifications (cont.)

Mtg. Type	CentriFuse Drum Part No.	Brake Size	Wt. lb.	Over All Depth	Brake Surf. Width	Hub Pilot Dia.	Bolt Circle Dia.	No. Bolt Holes	Bolt Hole Dia.	Drum Back No.	Drum Band No.	Special Information
0	91265B	16.5 x 6	88	9.62	6.68	8.78	285.75	10	1.25	91264	87298	Replaces 91049B
I	87415B	16.5 x 7	85	8.66	7.64	9.50	11.25	10	0.81	87416	87105	Replaces 85130 & 86134
I	87407B	16.5 x 7	85	9.66	7.58	9.44	11.25	10	0.81	88152	87105	Replaces 85369, 85831, 86140, 86909
0	89651B	16.5 x 7	88	10.04	7.24	9.00	275	8	0.92	88798	87298	
0	87295B	16.5 x 7	88	10.04	7.27	8.53	11.25	10	0.81	91611	87298	
0	89877B	16.5 x 7	88	10.04	7.27	8.78	285.75	10	0.96	91538	87298	
0	600004HD	16.5 x 7	100	10.41	7.64	8.78	285.75	10	0.96	91538	610021	CentriFuse® HD
0	600084	16.5 x 7	83	10.41	7.64	8.78	285.75	10	0.96	91538	610001	CentriFuse® Lite
0	89996B	16.5 x 7	89	10.41	7.64	8.78	285.75	10	0.96	91538	87105	
0	87101B	16.5 x 7	89	10.41	7.64	8.53	11.25	10	0.81	91611	87105	Replaces 86879
0	87156B	16.5 x 7	90	10.41	7.64	9.00	11.25	10	0.81	87157	87105	Replaces 86232
0	88797B	16.5 x 7	89	10.41	7.64	9.00	275	8	0.92	88798	87105	
0	600013HD	16.5 x 8	104	10.91	8.55	8.78	285.75	10	0.96	91793	610023	CentriFuse® HD
0	91792B	16.5 x 8	90	10.91	8.55	8.78	285.75	10	0.96	91793	91795	
0	600014HD	16.5 x 8.62	111	11.34	9.10	8.78	285.75	10	0.96	91813	610025	0.375 thick mounting, CentriFuse® HD
0	600026	16.5 x 8.62	100	11.34	9.10	8.78	285.75	10	0.96	91813	610029	0.375 thick mounting, Replaces 91812B
0	89467B	16.5 x 8.62	95	11.89	9.10	8.53	11.25	10	0.81	91611	610029	
0	90434B	16.5 x 8.62	95	11.89	9.10	8.78	285.75	10	0.96	91538	610029	
0	89571B	16.5 x 8.62	97	12.15	9.36	9.00	275	8	0.92	88798	87618	
0	87615B	16.5 x 8.62	95	12.15	9.36	8.53	11.25	10	0.81	91611	87618	Replaces 86889
0	90486B	16.5 x 8.62	97	12.15	9.36	8.78	285.75	10	0.96	91538	87618	

Notes: All CentriFuse Drums are Balanced
 I = Inboard Mounted Drum
 O = Outboard Mounted Drum
 CA = Check Availability
 CentriFuse Drum mounting face is 0.25" thick unless otherwise noted.

High Performance Brake Drum & Lightweight Hub Assemblies

These Lightweight Assemblies qualify as a part of STEMCO's Platinum Performance System™ Plus 7. Please see page 2 for details.



Hub Piloted System: 10 Hole, 285.75mm Bolt Circle (CLN)

Lightweight Assembly Part # (General Cups)	Lightweight Assembly Part # (Stemco Cups)	Brake Size	Wheel Usage	Hub ABS	Hub Weight	Assembly Weight	Lightweight Hub Part Number (General Cups)	Lightweight Hub Part Number (Stemco Cups)	CentriFuse® Drum Part #	CentriFuse® Drum Type
N Type Tapered Trailer Axle										
BEARINGS: Inner/Outer Cups: HM218210/HM212011 Cones: HM218248/HM212049 Seal O.D.: 6.00										
400170	400170SC	16.5 X 7	Steel	Non	31	120	00114002	20114002	89996B	Original CentriFuse®
440170	440170SC	16.5 X 7	Steel	ABS	32	121	00114102	20114102	89996B	Original CentriFuse®
400171	400171SC	16.5 X 7	Alum	Non	32	121	00114001	20114001	89996B	Original CentriFuse®
440171	440171SC	16.5 X 7	Alum	ABS	33	122	00114101	20114101	89996B	Original CentriFuse®
400172	400172SC	16.5 X 7	Steel	Non	31	114	00114002	20114002	600084	CentriFuse® Lite
440172	440172SC	16.5 X 7	Steel	ABS	32	115	00114102	20114102	600084	CentriFuse® Lite
400173	400173SC	16.5 X 7	Alum	Non	32	115	00114001	20114001	600084	CentriFuse® Lite
440173	440173SC	16.5 X 7	Alum	ABS	33	116	00114101	20114101	600084	CentriFuse® Lite
400174	400174SC	16.5 X 8.62	Steel	Non	31	131	00114002	20114002	600026*	CentriFuse® Wide
440174	440174SC	16.5 X 8.62	Steel	ABS	32	132	00114102	20114102	600026*	CentriFuse® Wide
400175	400175SC	16.5 X 8.62	Alum	Non	32	132	00114001	20114001	600026*	CentriFuse® Wide
440175	440175SC	16.5 X 8.62	Alum	ABS	33	133	00114101	20114101	600026*	CentriFuse® Wide
400182	400182SC	16.5 X 8	Steel	Non	31	121	00114002	20114002	91792B	CentriFuse® Wide
440182	440182SC	16.5 X 8	Steel	ABS	32	122	00114102	20114102	91792B	CentriFuse® Wide
400183	400183SC	16.5 X 8	Alum	Non	32	122	00114001	20114001	91792B	CentriFuse® Wide
440183	440183SC	16.5 X 8	Alum	ABS	33	123	00114101	20114101	91792B	CentriFuse® Wide
P Type Parallel Trailer Axle										
BEARINGS: Inner/Outer Cups: HM518410 / HM518410 Cones: HM518445 / HM518445 Seal O.D.: 6.00										
400176	400176SC	16.5 X 7	Steel	Non	33	122	00112002	20112002	89996B	Original CentriFuse®
440176	440176SC	16.5 X 7	Steel	ABS	34	123	00112102	20112102	89996B	Original CentriFuse®
400177	400177SC	16.5 X 7	Alum	Non	34	123	00112001	20112001	89996B	Original CentriFuse®
440177	440177SC	16.5 X 7	Alum	ABS	35	124	00112101	20112101	89996B	Original CentriFuse®
400178	400178SC	16.5 X 7	Steel	Non	33	116	00112002	20112002	600084	CentriFuse® Lite
440178	440178SC	16.5 X 7	Steel	ABS	34	117	00112102	20112102	600084	CentriFuse® Lite
400179	400179SC	16.5 X 7	Alum	Non	34	117	00112001	20112001	600084	CentriFuse® Lite
440179	440179SC	16.5 X 7	Alum	ABS	35	118	00112101	20112101	600084	CentriFuse® Lite
400180	400180SC	16.5 X 8.62	Steel	Non	33	133	00112002	20112002	600026*	CentriFuse® Wide
440180	440180SC	16.5 X 8.62	Steel	ABS	34	134	00112102	20112102	600026*	CentriFuse® Wide
400181	400181SC	16.5 X 8.62	Alum	Non	34	134	00112001	20112001	600026*	CentriFuse® Wide
440181	440181SC	16.5 X 8.62	Alum	ABS	35	135	00112101	20112101	600026*	CentriFuse® Wide
400184	400184SC	16.5 X 8	Steel	Non	33	123	00112002	20112002	91792B	CentriFuse® Wide
440184	440184SC	16.5 X 8	Steel	ABS	34	124	00112102	20112102	91792B	CentriFuse® Wide
400185	400185SC	16.5 X 8	Alum	Non	34	124	00112001	20112001	91792B	CentriFuse® Wide
440185	440185SC	16.5 X 8	Alum	ABS	35	125	00112101	20112101	91792B	CentriFuse® Wide

Each Hub & Drum Assembly comes with two M22 X 1.5 Wheel Nuts. * Replaces part number 91812B.



High Performance Brake Drum & Ductile Iron Hub Assemblies

Hubs are also available for sale individually. Please use Hub Part Number to order.

Hub Piloted System: 10 Hole, 285.75mm Bolt Circle (CLN)

Hub & Drum Assembly Part # (General Cups)	Hub & Drum Assembly Part # (Stemco Cups)	Brake Size	Wheel Usage	Hub ABS	Hub Weight	Assembly Weight	Ductile Hub Part Number (General Cups)	Ductile Hub Part Number (Stemco Cups)	CentriFuse® Drum Part #	CentriFuse® Drum Type
N Type Tapered Trailer Axle										
BEARINGS: Inner/Outer Cups: HM218210/HM212011 Cones: HM218248/HM212049 Seal O.D.: 6.00										
400158	400158SC	16.5 X 7	Steel	Non	42	131	00106002	20106002	89996B	Original CentriFuse®
440158	440158SC	16.5 X 7	Steel	ABS	43	132	00106102	20106102	89996B	Original CentriFuse®
400159	400159SC	16.5 X 7	Alum	Non	44	133	00106001	20106001	89996B	Original CentriFuse®
440159	440159SC	16.5 X 7	Alum	ABS	45	134	00106101	20106101	89996B	Original CentriFuse®
400160	400160SC	16.5 X 7	Steel	Non	42	125	00106002	20106002	600084	CentriFuse® Lite
440160	440160SC	16.5 X 7	Steel	ABS	43	126	00106102	20106102	600084	CentriFuse® Lite
400161	400161SC	16.5 X 7	Alum	Non	44	127	00106001	20106001	600084	CentriFuse® Lite
440161	440161SC	16.5 X 7	Alum	ABS	45	128	00106101	20106101	600084	CentriFuse® Lite
400162	400162SC	16.5 X 8.62	Steel	Non	42	142	00106002	20106002	600026*	CentriFuse® Wide
440162	440162SC	16.5 X 8.62	Steel	ABS	43	143	00106102	20106102	600026*	CentriFuse® Wide
400163	400163SC	16.5 X 8.62	Alum	Non	44	144	00106001	20106001	600026*	CentriFuse® Wide
440163	440163SC	16.5 X 8.62	Alum	ABS	45	145	00106101	20106101	600026*	CentriFuse® Wide
P Type Parallel Trailer Axle										
BEARINGS: Inner/Outer Cups: HM518410 / HM518410 Cones: HM518445 / HM518445 Seal O.D.: 6.00										
400164	400164SC	16.5 X 7	Steel	Non	45	134	00161002	20161002	89996B	Original CentriFuse®
440164	440164SC	16.5 X 7	Steel	ABS	46	135	00161102	20161102	89996B	Original CentriFuse®
400165	400165SC	16.5 X 7	Alum	Non	47	136	00161001	20161001	89996B	Original CentriFuse®
440165	440165SC	16.5 X 7	Alum	ABS	48	137	00161101	20161101	89996B	Original CentriFuse®
400166	400166SC	16.5 X 7	Steel	Non	45	128	00161002	20161002	600084	CentriFuse® Lite
440166	440166SC	16.5 X 7	Steel	ABS	46	129	00161102	20161102	600084	CentriFuse® Lite
400167	400167SC	16.5 X 7	Alum	Non	47	130	00161001	20161001	600084	CentriFuse® Lite
440167	440167SC	16.5 X 7	Alum	ABS	48	131	00161101	20161101	600084	CentriFuse® Lite
400168	400168SC	16.5 X 8.62	Steel	Non	45	145	00161002	20161002	600026*	CentriFuse® Wide
440168	440168SC	16.5 X 8.62	Steel	ABS	46	146	00161102	20161102	600026*	CentriFuse® Wide
400169	400169SC	16.5 X 8.62	Alum	Non	47	147	00161001	20161001	600026*	CentriFuse® Wide
440169	440169SC	16.5 X 8.62	Alum	ABS	48	148	00161101	20161101	600026*	CentriFuse® Wide

Each Hub & Drum Assembly comes with two M22 X 1.5 Wheel Nuts. * Replaces part number 91812B.



Genuine CentriFuse®

Brake Drum Manufacturers Interchange

Meritor (Dayton / X30)	lbs.	CentriFuse®	lbs.	Gunite	lbs.	CentriFuse®	lbs.	Webb	lbs.	CentriFuse®	lbs.	ConMet	lbs.	CentriFuse®	lbs.
122453	112	87295B	88	2546B	100	87417B	86	61527	70	91137BK	64	107150	112	89996B	89
122505	73	88115B	64	2983C	108	87397B	84	61528	70	89870BK	65	107164	80	89870BK	65
122550	106	87156B	90	3018A	113	87415B	85	61571	106	87128B	90	107193	109	91265B	88
122607	117	87101B	89	3097A	98	90172B	89	64483	75	88115B	64	107453	94	90600B	76
123207	112	89996B	89	3141	105	87156B	90	65152	122	91265B	88	107507	71	90089BK	64
123254	69	90089BK	64	3141B	105	88797B	89	65157	111	89855B	79	107637	119	91792B	90
123365	122	60004HD	100	3166	115	87101B	89	65162	123	91265B	88	107638	124	60002B	100
123366	70	91137BK	64	3219	106	87128B	90	65163B	119	90600B	76	107865	110	91723B	90
123383	83	90600B	76	3219A	106	90148B	90	65541B	80	88114B	64	107866	117	91725B	90
123399	107	91265B	88	3401	115	60004HD	100	65543	80	88870BK	64	107875	112	88797B	89
123400	105	91265B	88	3402	111	89877B	88	65545	68	90660BK	64	107885	110	89877B	88
123406	142	90486B	97	3402A	111	89651B	88	65547	82	90089BK	64	107902	80	88870BK	64
123409	123	88797B	89	3483	106	87101B	89	65548	78	89870BK	65	107904	112	87156B	90
123448	74	89870BK	65	3573X	98	600001	75	65550	85	87945BK	65	10001776	100	89996B	89
123463	97	90600B	76	3574	80	87945BK	65	65554	83	89870BK	65	10001777	100	87156B	90
123520	128	600013HD	104	3576	131	60004HD	100	65739	95	88739B	74	10001778	100	89996B	89
123570	138	600014HD	111	3596	79	90089BK	64	66353	110	600013HD	104	10001779	100	87156B	90
53-123512-002	62	90089BK	64	3598	96	90600B	76	66800	119	91792B	90	10001781	68	89870BK	65
53-123519-002	87	87397B	84	3598A	96	88814B	76	66808	119	600013HD	104	10001783	67	90089BK	64
53-123535-002	95	91792B	90	3598B	96	90600B	76	66809	120	600014HD	111	10001800	112	89996B	89
53-123537-002	94	89996B	89	3600A	112	89996B	89	66811	130	89467B	95	10001801	112	88797B	89
53-123542-002	63	89870BK	65	3610	82	88115B	64	66814	132	90486B	97	10001802	100	89877B	88
53-123544-002	102	60002B	100	3630	101	90600B	76	66815	133	87615B	95	10001803	112	87156B	90
53-123564-002	94	87101B	89	3647X	114	600013HD	104	66816	136	89571B	97	10005331	82	600001	75
53-123565-002	93	87156B	90	3687	108	91265B	88	66827B	130	600014HD	111	10005332	83	90600B	76
53-123566-002	93	88797B	89	3699	128	87295B	88	66834	129	90434B	95	10009830	112	89996B	89
53-123567-002	63	91137BK	64	3710	96	600001	75	66852	115	87295B	88	10009920	80	89870BK	65
53-123568-002	64	90660BK	64	3721AX	79	90089BK	64	66854	120	60002B	100	10012097	121	60002B	100
53-123575-002	64	88870BK	64	3721X	79	90089BK	64	66864	112	89996B	89	10014756	93	90600B	76
53-123579-002	106	89571B	97	3726X	79	89870BK	65	66873	108	89877B	88	10020147	91	600001	75
53-123580-002	106	87615B	95	3741X	79	88870BK	64	66875	110	88797B	89	10025912	137	600014HD	111
53-123581-002	106	90486B	97	3744X	105	91725B	90	66878	109	89651B	88	10026002	94	88814B	76
53-123582-002	91	87295B	88	3757	114	600013HD	104	66884	117	600004HD	100	10030774	105	89996B	89
53-123583-002	89	89877B	88	3758X	96	90600B	76	66892	111	87295B	88	10033071	103	91265B	88
53-123584-002	*	89651B	88	3782	123	91792B	90	66893	113	87101B	89	10033314	113	60002B	100
53-123585-002	*	87407B	85	3800X	79	89870BK	65	66895	110	87156B	90	10037991	106	91265B	88
53-123586-002	*	87417B	86	3807	127	60002B	100	67518	98	87397B	84				
53-123587-002	*	87415B	85	3807A	127	60002B	100	68730	101	87415B	85				
53-123588-002	79	88814B	76	3811	157	600014HD	111	68921	112	87417B	86				
53-123589-002	79	90600B	76	**3890	133	600014HD	111	78500	127	600014HD	111				
53-123591-002	80	90148B	90	**3891	135	600013HD	104	78501	123	600013HD	104				
53-123592-002	80	87128B	90	3922	105	89996B	89	78502	120	600004HD	100				
53-123594-002	*	91655B	90	**9000X	66	90089BK	64	78504	123	600013HD	104				
53-123595-002	*	88114B	64	**9001X	69	89870BK	65	78505	127	600014HD	111				
53-123596-002	*	89467B	95	**9002X	80	90137B	74	76864B	102	600084	83				
53-123597-002	*	90434B	95	**9006X	94	89996B	89	77528B	64	88114B	64				
53-123598-002	70	90174B	78	**9014X	90	87407B	85	77710B	79	90600B	76				
53-123599-002	70	90176B	78	**9015X	89	87415B	85	77800BW	117	91792B	90				
53-123600-002	70	90174B	78	**9016X	70	88870BK	64	77807BW	109	89996B	89				
53-123601-002	91	91725B	90	**9019X	107	60002B	100	77808BW	118	91792B	90				
53-123602-002	91	91723B	90	**9020X	105	91792B	90	77809BW	120	60002B	100				
53-123603-002	*	91482B	90	**9021X	96	87101B	89	77854BW	119	60002B	100				
53-123604-002	*	91438B	90	**9022X	94	87295B	88	77864BW	109	89996B	89				
53-123605-002	77	88739B	74	**9035X	64	90089BK	64								
53-123606-002	77	90137B	74	**9036X	98	89877B	88								
53-123607-002	87	91265B	88	**9041X	99	87156B	90								
53-123608-002	87	91265B	88	**9041BX	99	88797B	89								
53-123609-002	93	87945BK	65												
53-123627-002	86	600001	75												
53-123771-002	103	60002B	100												
53-123815-002	79	90600B	76												
53-123816-002	79	600001	75												

Webb part numbers ending in B = Balanced

Gunite part numbers ending in X = Balanced

** Gunite Gold Part Numbers

* Weight unavailable, part number no longer published.

Genuine CentriFuse®

Drum Back & Drum Band to CentriFuse Drum Part Number

Drum Back Number	CentriFuse® Drum Part Number
87157	87156B
87416	87415B
87418	87417B
87438	89855B
88116	88114B
88117	88115B
88152	87407B
88253	87397B
88435	88739B
88508	88507B
88798	88797B
88798	89571B
88798	89651B
88810	88814B
89873	89874B
90170	90172B
90173	90174B
90175	90176B
90599	600001
90599	90600B
91008	87128B
91024	87945BK
91025	88870BK
91026	89870BK
91029	90660BK
91136	91137BK
91264	91265B
91293	90148B
91294	90089BK
91439	91438B
91481	91482B
91507	90137B
91538	600004HD
91538	600084
91538	89877B
91538	89996B
91538	90434B
91538	90486B
91611	87101B
91611	87295B
91611	87615B
91611	89467B
91654	91655B
91722	91723B
91724	91725B
91793	600013HD
91793	91792B
91813	600014HD
91813	60002B
91813	91812B



CENTRIFUSE® IS AN ENGINEERED PRODUCT

With the Right Material
In the Right Place
For the Right Reason!

Drum Band Number	CentriFuse® Drum Part Number
610001	600084
610003	600004HD
610021	600004HD
610023	600013HD
610025	600014HD
610029	600026
87105	87101B
87105	87156B
87105	87407B
87105	87415B
87105	87417B
87105	88797B
87105	89996B
87132	87128B
87132	90148B
87132	90172B
87132	91655B
87298	87295B
87298	87397B
87298	89651B
87298	89877B
87298	91265B
87311	90174B
87311	90176B
87369	600001
87369	600027
87369	88507B
87369	88739B
87369	88814B
87369	89874B
87369	90137B
87369	90600B
87618	87615B
87618	89467B
87618	89571B
87618	90434B
87618	90486B
87618	91812B
89852	89855B
91028	87945BK
91028	88114B
91028	88115B
91028	88870BK
91028	89870BK
91028	90089BK
91028	90660BK
91028	91137BK
91480	91438B
91480	91482B
91480	91723B
91480	91725B
91795	91792B

Lunar™ Air Disc Brakes



LUNAR™

LUNAR HP™

Shorter Stopping, Longer Life

STEMCO® Lunar™ air disc brakes help even the heaviest commercial vehicles meet Federal Motor Vehicle Safety Standard 121 maximum stopping distances while contributing less weight per axle than similarly performing drums.

Lunar HP Air Disc Brake Pads For Extreme Duty

Lunar HP is the brake pad of choice for severe-duty applications. With its high performance capability and REG90 certification, Lunar HP out performs the competition in any application.

Even Tougher

An advanced wear formula means that Lunar HP brake pads endure the most demanding situations and handle constant temperatures of 670° F and intervals of up to 1650° F.

Advanced Design

Lunar HP brake pads have industry-leading rotor wear performance and are engineered to deliver stopping power while being less abrasive to the rotor. An integrally molded V-groove aids in airflow to remove gasses during a braking event for improved friction responsiveness.

Improved Performance

Full face burnish coating to promote consistent bedding performance.

Lunar Air Disc Brake Pads Tested and Trusted

Perform as well or better than OEM parts.

Keeping You Safe

Lunar air brake pads help meet maximum stopping distances per Federal Motor Vehicle Safety Standard 121, even in sustained braking on steep downhill gradients.

Rugged

Each pad comes standard with anti-corrosion coating and a mechanical retention system to increase sheer strength and reduce noise. An integrally molded V-groove aids in airflow to remove gasses during a braking event for improved friction responsiveness.

Engineering Performance

Lunar brake pads are designed for constant temperatures of 570° F and intervals of up to 1650° F.

Application Guide

LUNAR PART #	FMSI #	WVA #	APPLICATION	CALIPER
AD1311LHP AD1311L	8426 D1311	29187	Garbage Truck Coach Bus	MCI BUS (285mm) wheel Orion, NABI, ELSA H-2, Meritor #s 2252H2CD, MA761GG 11.250", Meritor EX225 H-2
AD1203LHP AD1203L	8323 D1203	29087, 29105, 29106, 29108, 29109, 29163, 19179, 29201, 29202, 29275	Coach Bus Fire Truck	Nova Bus, Prevost, Bendix # 5013257 Knorr Bremse Model SB-7, SN-7
AD1312LHP AD1312L	8427 D1312	29090	Coach Bus	MCI - Renaissance, Meritor # 68932068N2P Lucas Girling - Meritor D-LISA
AD1369LHP AD1369L	8479 D1369	29158	Tractor Trailer	Bendix # 802078, Hendrickson Trailer Axle Knorr Bremse Model SK-7, (ADB22X)
AD1407LHP AD1407L	8515 D1407	29030, 29083, 29084	Coach Bus Coach Bus	Van Hool, Nova, Orion VI, ELSA 1. MAN # 68325011 Lucas Girling - Meritor D-Elsa
AD1310LHP AD1310L	8425 D1310	29131, 29156	Coach Bus Coach Bus	VOLVO, Van Hool, OE# N508206051, Meritor, MDP-5060 Lucas-Meritor ELSA 2
AD1518LHP AD1518L	8727 D1518	29088	Refuse Garbage Truck	Fits 2002 Mack Freedom with 17" Wheels. Wabco part number PAN17
AD1690LHP AD1690L	8917 D1690		This is a design change to the 1311 Coach Bus-Garbage Truck	MCI BUS-Mack Truck-Prevost-BUS Meritor / EX225H2
AD1708LHP AD1708L	8931 D1708		Volvo Truck and Bus	APPLICATION: Volvo BRAKE MFR. & SYSTEM: Meritor / ELSA225-3
AD1441LHP AD1441L	8577 D1441		Trailer	SAF Axles, SMB Axles Haldex / DB22
AD1560LHP AD1560L	8771 D1560	29125	Tractor BUS	Volvo Meritor / D-Duco
AD1323LHP AD1323L	8435 D1323	29188	Garbage Truck Coach BUS	XX, ELSA H-3 Transit, Meritor # 2252H3CE, MA721, 3222G2477 13.250" (335mm) wheel Meritor EX225 H-3
AD1525LHP AD1525L	8733 D1525			Trailer Axles Meritor / DX 195
AD1370LHP AD1370L	8480 D1370	29189	Coach Bus Transit Bus	Mainly-Prevost Meritor / EX225L2
AD1527LHP AD1527L	8735 D1527			SAF Axles, SMB Axles, Scania Haldex / DB22
AD1777LHP AD1777L	9007-D1777		Trailer Axles	SAF Axles Wabco PAN22-1

STEMCO
LUNAR HP™



Friction coating improves out-of-the-box performance

Large V-groove relieves surface tension

Premium Mechanical Retention System backing plate

Advance wear formula for superior performance in extreme environments

STEMCO
LUNAR™



V-groove aids in airflow

Mechanical retention system

Premium formulation performs as well or better than OEM parts

Corrosion resistant coating provides maximum protection

Advanced Wheel Retention Technology

Even with 500 ft-lb of torque, tightened wheel nuts will “settle in” after being placed into service. Paint, debris, and surface irregularities wear away in minute amounts, leading to a loss of torque.

Motor Wheel Cone Lock Nut #88881 offers more robust wheel retention than the typical 33 mm two-piece flange nut used on hub-piloted wheel mountings. It achieves this improvement by having a more flexible cone-shaped flange to reduce normal seating-in torque loss.

- Flexible cone-shaped flange reduces normal seating-in torque loss
- Belleville spring washer action provides a uniform clamp load against the wheel
- Teflon® based coating deters corrosion
- 1 1/2 inch hex to resist corner rounding



Genuine Motor Wheel Cone Lock Nuts have “MW” marking for identification.

Type	Part No.	Thread	Height	Wrench Size	Flange Diameter
Hub Pilot CLN	88881	M22 x 1.5	1.38	1-1/2 Hex	2.00
Wheel Nut	90846	M22 x 1.5	1.19	33mm Hex	1.80

How it Works

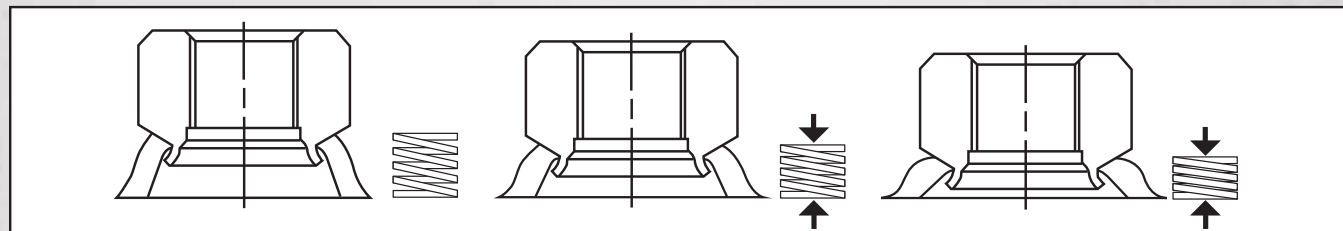

The Motor Wheel nut flange operates as a Belleville spring washer which can be compared to an unloaded coil spring before it is tightened. As torque is applied, the flange is compressed, providing a uniform clamp load against the wheel. When fully tightened, the flange is deflected (as illustrated above) which maintains a higher amount of clamp force during the joint settling process after installation.

As total thickness of the clamped joint diminishes, the Motor Wheel nut flange remains sufficiently compressed to apply adequate clamp force, compared to the more rigid flange on typical fasteners which lets the clamp force drop off sooner.

To maintain adequate clamp force, it is recommended that **WHEEL NUT TORQUE SHOULD BE CHECKED AT REGULARLY SCHEDULED INTERVALS** and retightened if necessary.



MADE IN USA



Patented Auto-Check™

Reduce time spent under your trucks and increase safety.

STEMCO Crewson™ Brake Adjusters. Designed for maximum safety and convenience. With STEMCO Crewson Brake Adjusters you'll have an easier time making sure your trucks are up to code and operating safely. Our brake adjusters have been designed with a variety of patented features including:

- **Auto-Check™:** This patented feature allows you to check brake stroke without crawling under the truck.
- **Cam Guard:** This lubrication system eliminates seizing and corrosion between the S-Cam and ABA.
- **Patented Installation Template:** This handy guide ensures the ABA is installed correctly every time.
- **Patented Clearance Sensing Adjuster System:** STEMCO Crewson features the only patented reduced wear clutch in the industry.
- **High Strength Gearset:** Assures the ABA will stand up to years of service in demanding conditions.
- **Blue Powder Coat:** Protects the ABA from harsh winter conditions.
- **Sealing:** The gear is sealed with a proprietary system that protects it from environmental contamination.
- **Patented Pushrod Cutoff Tool:** For accurate measurements.



Automatic Brake Adjuster

The STEMCO Crewson Automatic Brake Adjuster maintains proper shoe-to-drum clearance in all braking modes and is easily installed in the field or on the shop floor.

Installation

The STEMCO Crewson Automatic Brake Adjuster comes with our patented, structurally rigid installation guide. This handy and fool-proof guide ensures that even first time users can install the ABA correctly every time.

Auto-Check™

Our patented Auto-Check™ feature is designed to provide a method of checking the brake stroke without going under the truck.

- Installed on the ABA facing the center of the vehicle to easily see if brake stroke is in a normal range.
- Bright yellow pointer easily indicates set up position, determines working stroke and shows if brake stroke is past readjust limit without crawling under the vehicle.
- Offers you an extra quality control check.

Long Life Adjustment System

Heavy-duty internal components with a clearance sensing clutch enables your brake system to adjust for hot braking conditions. This patented STEMCO Crewson design protects the adjusting components during normal brake applications when brake adjustment is not required. Over 90% of all brake applications do not require adjustment, so why subject the adjusting components to continuous wear?

The STEMCO Crewson Adjustment System operates like the windshield wipers on your car — it is utilized only when needed, not continuously when the car is running.

- A typical highway vehicle makes about two million brake applications in five years.
- This same vehicle will require the ABA to adjust the brake about 3,000 times.

Warranty

This warranty is not applicable to failures caused by improper installation, repair, alteration, accidents, abuse, improper use, normal wear and tear. The below is only a partial copy of the warranty. For a complete copy of the warranty, please contact your local STEMCO Crewson distributor. STEMCO Crewson reserves the right to modify our warranty policy without notice.

Warranty Period (Whichever occurs first)	6 years/ 1 million miles	2 years/ 200,000 miles	1 year/ 100,000 miles
ABAs used for	On-Highway Trucks Tractors, and Trailers	Off-Highway Applications (e.g. construction vehicles)	Severe Service ABAs (e.g. refuse pickup, school buses, or city deliveries)



Installation Guide



Detail of Auto-Check™ Feature

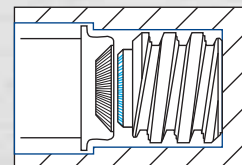

Figure A shows components disengaged to reduce wear (over 90% of the time).

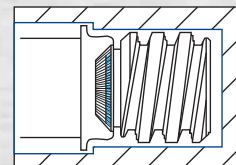

Figure B shows components engaged during brake adjustment (less than 10% of the time).

Automatic Brake Adjuster

STEMCO Crewson Part Numbers

Unlike other manufacturers, you can determine what part you need by gathering the following information.

(MK) ALL AFTERMARKET PART NUMBERS

(A) AUTO-CHECK™ STROKE INDICATOR

- No "Auto-Check" Indicator
- T-16, 20, 24 Std. Stroke Chamber
- T-30 Std. Stroke or T-16 LS, T-20 LS, T-24 LS Chamber or T-24LLS, 30LS Chamber
- T-36 Std. Stroke Chamber

(B) SPLINE (Diameter - Splines)

- 1-1/2" – 10
- 1-1/2" – 28
- 1-5/8" – 37
- 1-1/4" – 10
- 1-1/4" – 24

(C) CLEVIS TYPE & SIZE

- No Clevis
- 5/8" – 18 Straight
- 1/2" – 20 Straight
- 5/8" – 18 Offset
- 1/2" – 20 Offset
- M16x1.5mm Straight
- 5/8" – 18 Straight Extended
- 5/8" – 18 Short Throat
- 5/8" – 18 Short Throat 5/8 Offset
- 1/2" – 20 Straight Extended

(D) BRAKE SIZE/TYPE

- Std S-Cam Brake
- Welded Clevis
- 12-1/4" S-Cam Brake Curved Arm

(E) ARM LENGTH

- 5.5"
- 6.5"
- 5", 6"
- 5", 6", 7"
- 6"

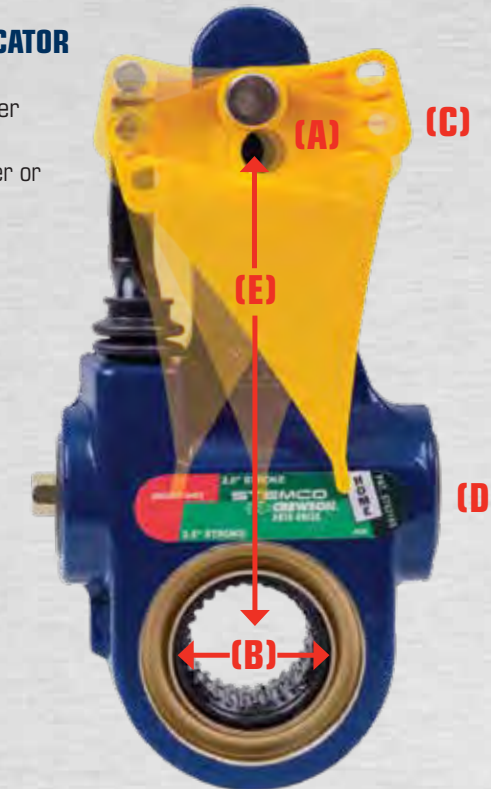

EXAMPLE

MK	(A)	(B)	(C)	(D)	(E)	S
MK	4	2	1	0	6	S

In This Example:

- (A) Would be a STD Type 30 Auto-Check
- (B) Would be a 1-1/2" – 28 Spline
- (C) Would be a 5/8" – 18 Straight Clevis
- (D) Would be a Standard S-Cam Brake
- (E) Would be a 6" Arm Length

COMPONENT PART NO.	COMPONENT DESCRIPTION
MC8056KTAS	PIN KIT FOR ABA (AUTO-CHECK)
MC8056KTS	PIN KIT FOR ABA (NON AUTO-CHECK)
MC8500S	POINTER FOR ABA W/ AUTO-CHECK
MC8530S	PUSHROD CUTOFF TOOL
MC8410KTAS	CLEVIS 1/2" – 20 STD W/ PIN KIT (AUTO-CHECK)
MC8410KTS	CLEVIS 1/2" – 20 STD W/ PIN KIT (NON AUTO-CHECK)
MC8412KTAS	SHORT CLEVIS 1/2" – 20 W/ PIN KIT (AUTO-CHECK)
MC8412KTS	SHORT CLEVIS 1/2" – 20 W/ PIN KIT (NON AUTO-CHECK)
MC8415KTAS	CLEVIS 1/2" – 20 OFFSET W/ PIN KIT (AUTO-CHECK)

COMPONENT PART NO.	COMPONENT DESCRIPTION (CONT.)
MC8415KTS	CLEVIS 1/2" – 20 OFFSET W/ PIN KIT (NON AUTO-CHECK)
MC8420KTAS	CLEVIS 5/8" – 18 STD W/ PIN KIT (AUTO-CHECK)
MC8420KTS	CLEVIS 5/8" – 18 STD W/ PIN KIT (NON AUTO-CHECK)
MC8422KTAS	SHORT CLEVIS 5/8" – 18 W/ PIN KIT (AUTO-CHECK)
MC8422KTS	SHORT CLEVIS 5/8" – 18 W/ PIN KIT (NON AUTO-CHECK)
MC8425KTAS	CLEVIS 5/8" – 18 OFFSET W/ PIN KIT (AUTO-CHECK)
MC8425KTS	CLEVIS 5/8" – 18 OFFSET W/ PIN KIT (NON AUTO-CHECK)
MC8480KTAS	CLEVIS 5/8" – 18 EXT W/ PIN KIT (AUTO-CHECK)
MC8480KTS	CLEVIS 5/8" – 18 EXT W/ PIN KIT (NON AUTO-CHECK)

1.30" Welded Clevis Automatic Brake Adjuster



6 Year/ 1 Million Mile Warranty*

*On-Highway Trucks, Tractors, and Trailers

All of the Great Features You Expect Now for 1.30" Welded Clevis Applications

- **Auto-Check™:** This patented feature allows you to check brake stroke without crawling under the truck.
- **Cam Guard:** This lubrication system eliminates seizing and corrosion.
- **Easy Installation:** The proper mounting angle has been designed into the product, so an installation gauge is not necessary.
- **Patented Clearance Sensing Adjuster System:** Stemco Crewson features the only patented reduced wear clutch in the industry.
- **High Strength Gearset:** Assures the ABA will stand up to years of service in demanding conditions.
- **Blue Powder Coat:** Protects the ABA from harsh winter conditions.
- **Sealing:** The gear is sealed with a proprietary system that protects it from environmental contamination.

NOTE: 1.30" Pin Spacing is typical of welded clevis applications used on International, Freightliner, Mack and Volvo trucks.



Blue box label for easy identification



Silver lift rod for easy identification

Build Your Part Number

EXAMPLE	MK	(A)	(B)	(C)	(D)	(E)
	MK	4	2	0	1	6

As shown in the example on the left, the C & D digit in the model number must be a 0 and 1 respectively to identify a STEMCO Crewson 1.30" Welded Clevis ABA.

(MK)	All Aftermarket Part Numbers
(A)	Auto-Check Stroke Indicator
(2)	No "Auto-Check" Indicator
(3)	T-16, 20, 24 Std. Stroke Chamber
(4)	T-30 Std. Stroke OR T-16, 20LS, 24LS Chamber OR T-24LLS, 30LS Chamber
(5)	T-36 Std. Stroke Chamber
(B)	Spline (Diameter - Splines)
(1)	1-1/2" - 10
(2)	1-1/2" - 28
(3)	1-5/8" - 37
(4)	1-1/4" - 10
(5)	1-1/4" - 24

(C)	Clevis Type & Size
(0)	No Clevis
(1)	5/8" - 18 Straight
(2)	1/2" - 20 Straight
(3)	5/8" - 18 Offset
(4)	1/2" - 20 Offset
(5)	16 X 1.5mm Straight
(8)	5/8" - 18 Short Throat
(9)	5/8" - 18 Short Throat 5/8" Offset
(A)	3/4" - 16 Straight
(E)	1/2" - 20 Straight Extended
(G)	3/4" - 16 Straight Extended
(L)	16 X 1.5mm Offset

(D)	Brake Size / Type
(0)	Std S-Cam Brake
(1)	1.30" Welded Clevis
(5)	12.25" S-Cam Brake Curved Arm
(E)	Arm Length
(0)	5.5"
(2)	5.5", 6.5"
(3)	5", 6"
(4)	5", 6", 7"
(6)	6"

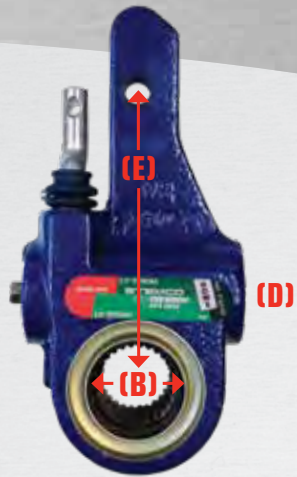

STEMCO Crewson Competitive Crossover

General Cross-Referencing

1. Build the STEMCO Crewson model number using the competitive brake adjuster dimensions (spline diameter; number of splines, arm length).
2. Determine the size (e.g. 24, 30, 36) and type (e.g. Standard or Long Stroke) of the air chamber used and adjust the 1st digit (A) of the STEMCO Crewson model number accordingly.
3. Determine if the brake adjuster is a welded clevis type or not. If not a 1.30" welded clevis, you are done and the correct model number has been identified. If a 1.30" welded clevis, then continue with the instructions to the right.

STEMCO Crewson 1.30" Welded Clevis Cross-Referencing Haldex & Meritor

- These competitive brake adjusters work in multiple clevis pin spacing applications.
- To crossover Haldex and Meritor brake adjusters to STEMCO Crewson 1.30" Welded Clevis, follow the general steps for cross-referencing competitive ABAs (at left) and then adjust the C & D digits in the model number as described above.

Gunite & Bendix

- These competitive brake adjusters, like STEMCO Crewson, are application specific, i.e. a different adjuster for threaded clevis and welded clevis applications.
- To crossover Gunite & Bendix brake adjusters, follow the general cross-referencing steps and use the crossover charts below.

GUNITE PART NUMBER	STEMCO CREWSON 1.30" WELDED CLEVIS PART NUMBERS						
	STEMCO PART NO.	NON AUTO-CHECK	SPLINE SIZE	ARM LENGTH	AUTO-CHECK 16, 20, 24STD	STEMCO PART NO.	AUTO-CHECK 30STD 16, 24LS, 24LLS, 30LS
AS1168	191-0062	MK21010S	1-1/2" - 10	5.5"	NA	190-0112	MK41010S
AS1169	191-0064	MK21016S	1-1/2" - 10	6.0"	NA	190-0100	MK41016S
AS1170	191-0068	MK24010S	1-1/4" - 10	5.5"	NA	190-0108	MK44010S
AS1171	191-0069	MK25010S	1-1/4" - 24	5.5"	NA	190-0110	MK45010S
AS1172	191-0065	MK22010S	1-1/2" - 28	5.5"	NA	190-0102	MK42010S
AS1173	191-0067	MK22016S	1-1/2" - 28	6.0"	NA	190-0106	MK42016S
AS1174	191-0063	MK21011S	1-1/2" - 10	6.5"	NA	190-0098	MK41011S
AS1175	191-0066	MK22011S	1-1/2" - 28	6.5"	NA	190-0104	MK42011S
AS1176	NA	NA	1-1/2" - 28	6.0"	NA	NA	NA
AS1179	NA	NA	1-1/2" - 10	6.0"	NA	NA	NA

BENDIX PART NUMBER	STEMCO CREWSON 1.30" WELDED CLEVIS PART NUMBERS						
	STEMCO PART NO.	NON AUTO-CHECK	SPLINE SIZE	ARM LENGTH	AUTO-CHECK 16, 20, 24STD	STEMCO PART NO.	AUTO-CHECK 30STD 16, 24LS, 24LLS, 30LS
K041870	191-0062	MK21010S	1-1/2" - 10	5.5"	NA	190-0112	MK41010S
K041876	191-0064	MK21016S	1-1/2" - 10	6.0"	NA	190-0100	MK41016S
K041877	191-0067	MK22016S	1-1/2" - 28	6.0"	NA	190-0106	MK42016S
K043197	191-0065	MK22010S	1-1/2" - 28	5.5"	NA	190-0102	MK42010S

With Auto-Check™

STEMCO Crewson Part Number	Spline Type	Arm Length	Clevis Type	Weight (lbs)
Chamber Type: T-16, 20, 24 Std.				
MK31100S	1-1/2" X 10 Spline	5.5"	5/8" – 18 Std	7.6
MK31106S	1-1/2" X 10 Spline	6.0"	5/8" – 18 Std	7.6
MK31200S	1-1/2" X 10 Spline	5.5"	1/2" – 20 Std	7.6
MK31206S	1-1/2" X 10 Spline	6.0"	1/2" – 20 Std	7.6
MK31300S	1-1/2" X 10 Spline	5.5"	5/8" – 18 Offset	7.6
MK31306S	1-1/2" X 10 Spline	6.0"	5/8" – 18 Offset	7.6
MK31400S	1-1/2" X 10 Spline	5.5"	1/2" – 20 Offset	7.6
MK31406S	1-1/2" X 10 Spline	6.0"	1/2" – 20 Offset	7.6
MK31700S	1-1/2" X 10 Spline	5.5"	5/8" – 18 Ext	7.6
MK31706S	1-1/2" X 10 Spline	6.0"	5/8" – 18 Ext	7.6
MK32100S	1-1/2" X 28 Spline	5.5"	5/8" – 18 Std	7.6
MK32106S	1-1/2" X 28 Spline	6.0"	5/8" – 18 Std	7.6
MK32200S	1-1/2" X 28 Spline	5.5"	1/2" – 20 Std	7.6
MK32206S	1-1/2" X 28 Spline	6.0"	1/2" – 20 Std	7.6
MK32300S	1-1/2" X 28 Spline	5.5"	5/8" – 18 Offset	7.6
MK32306S	1-1/2" X 28 Spline	6.0"	5/8" – 18 Offset	7.6
MK32400S	1-1/2" X 28 Spline	5.5"	1/2" – 20 Offset	7.6
MK32700S	1-1/2" X 28 Spline	5.5"	5/8" – 18 Ext	7.6
MK34100S	1-1/4" X 10 Spline	5.5"	5/8" – 18 Std	7.6
MK34101S	1-1/4" X 10 Spline	6.5"	5/8" – 18 Std	7.6
MK34106S	1-1/4" X 10 Spline	6.0"	5/8" – 18 Std	7.6
MK34200S	1-1/4" X 10 Spline	5.5"	1/2" – 20 Std	7.6
MK34206S	1-1/4" X 10 Spline	6.0"	1/2" – 20 Std	7.6
MK34300S	1-1/4" X 10 Spline	5.5"	5/8" – 18 Offset	7.6
MK34306S	1-1/4" X 10 Spline	6.0"	5/8" – 18 Offset	7.6
MK34400S	1-1/4" X 10 Spline	5.5"	1/2" – 20 Offset	7.6
MK34406S	1-1/4" X 10 Spline	6.0"	1/2" – 20 Offset	7.6
MK35100S	1-1/4" X 24 Spline	5.5"	5/8" – 18 Std	7.6
MK35200S	1-1/4" X 24 Spline	5.5"	1/2" – 20 Std	7.6
MK35300S	1-1/4" X 24 Spline	5.5"	5/8" – 18 Offset	7.6
MK35400S	1-1/4" X 24 Spline	5.5"	1/2" – 20 Offset	7.6



Detail of Auto-Check™ Feature

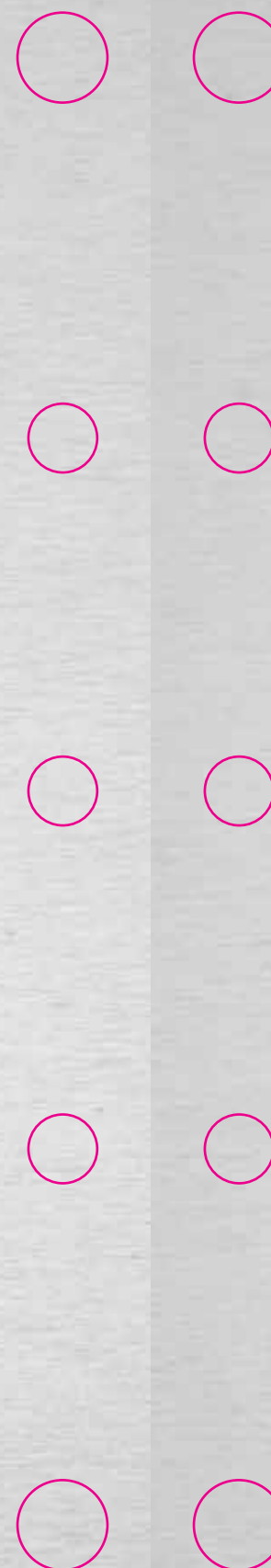

With Auto-Check™

STEMCO Crewson Part Number	Spline Type	Arm Length	Clevis Type	Weight (lbs)
Chamber Type: T30S, 16LS, 20LS, 24LS, T30LS, T24LLS				
MK41010S	1-1/2" X 10 Spline	5.5"	1.3" Pin Spacing	7.6
MK41011S	1-1/2" X 10 Spline	6.5"	1.3" Pin Spacing	7.6
MK41016S	1-1/2" X 10 Spline	6.0"	1.3" Pin Spacing	7.6
MK41100S	1-1/2" X 10 Spline	5.5"	5/8" – 18 Std	7.6
MK41101S	1-1/2" X 10 Spline	6.5"	5/8" – 18 Std	7.6
MK41106S	1-1/2" X 10 Spline	6.0"	5/8" – 18 Std	7.6
MK41200S	1-1/2" X 10 Spline	5.5"	1/2" – 20 Std	7.6
MK41300S	1-1/2" X 10 Spline	5.5"	5/8" – 18 Offset	7.6
MK41306S	1-1/2" X 10 Spline	6.0"	5/8" – 18 Offset	7.6
MK41400S	1-1/2" X 10 Spline	5.5"	1/2" – 20 Offset	7.6
MK41406S	1-1/2" X 10 Spline	6.0"	1/2" – 20 Offset	7.6
MK41700S	1-1/2" X 10 Spline	5.5"	5/8" – 18 Ext	7.6
MK41706S	1-1/2" X 10 Spline	6.0"	5/8" – 18 Ext	7.6
MK42010S	1-1/2" X 28 Spline	5.5"	1.3" Pin Spacing	7.6
MK42011S	1-1/2" X 28 Spline	6.5"	1.3" Pin Spacing	7.6
MK42016S	1-1/2" X 28 Spline	6.0"	1.3" Pin Spacing	7.6
MK42100S	1-1/2" X 28 Spline	5.5"	5/8" – 18 Std	7.6
MK42101S	1-1/2" X 28 Spline	6.5"	5/8" – 18 Std	7.6
MK42106S	1-1/2" X 28 Spline	6.0"	5/8" – 18 Std	7.6
MK42200S	1-1/2" X 28 Spline	5.5"	1/2" – 20 Std	7.6
MK42206S	1-1/2" X 28 Spline	6.0"	1/2" – 20 Std	7.6
MK42300S	1-1/2" X 28 Spline	5.5"	5/8" – 18 Offset	7.6
MK42306S	1-1/2" X 28 Spline	6.0"	5/8" – 18 Offset	7.6
MK42400S	1-1/2" X 28 Spline	5.5"	1/2" – 20 Offset	7.6
MK42406S	1-1/2" X 28 Spline	6.0"	1/2" – 20 Offset	7.6
MK42700S	1-1/2" X 28 Spline	5.5"	5/8" – 18 Ext	7.6
MK42706S	1-1/2" X 28 Spline	6.0"	5/8" – 18 Ext	7.6
MK43100S	1-5/8" X 37 Spline	5.5"	5/8" – 18 Std	7.6
MK43106S	1-5/8" X 37 Spline	6.0"	5/8" – 18 Std	7.6
MK44010S	1-1/4" X 10 Spline	5.5"	1.3" Pin Spacing	7.6
MK44100S	1-1/4" X 10 Spline	5.5"	5/8" – 18 Std	7.6
MK44101S	1-1/4" X 10 Spline	6.5"	5/8" – 18 Std	7.6
MK44106S	1-1/4" X 10 Spline	6.0"	5/8" – 18 Std	7.6
MK44200S	1-1/4" X 10 Spline	5.5"	1/2" – 20 Std	7.6
MK44206S	1-1/4" X 10 Spline	6.0"	1/2" – 20 Std	7.6
MK44300S	1-1/4" X 10 Spline	5.5"	5/8" – 18 Offset	7.6
MK44306S	1-1/4" X 10 Spline	6.0"	5/8" – 18 Offset	7.6
MK44400S	1-1/4" X 10 Spline	5.5"	1/2" – 20 Offset	7.6
MK44406S	1-1/4" X 10 Spline	6.0"	1/2" – 20 Offset	7.6
MK45010S	1-1/4" X 24 Spline	5.5"	1.3" Pin Spacing	7.6
MK45100S	1-1/4" X 24 Spline	5.5"	5/8" – 18 Std	7.6
MK45106S	1-1/4" X 24 Spline	6.0"	5/8" – 18 Std	7.6
MK45200S	1-1/4" X 24 Spline	5.5"	1/2" – 20 Std	7.6
MK45206S	1-1/4" X 24 Spline	6.0"	1/2" – 20 Std	7.6
MK45300S	1-1/4" X 24 Spline	5.5"	5/8" – 18 Offset	7.6
MK45306S	1-1/4" X 24 Spline	6.0"	5/8" – 18 Offset	7.6
MK45400S	1-1/4" X 24 Spline	5.5"	1/2" – 20 Offset	7.6
MK45406S	1-1/4" X 24 Spline	6.0"	1/2" – 20 Offset	7.6



Detail of Auto-Check™ Feature



Without Auto-Check™

STEMCO Crewson Part Number	Spline Type	Arm Length	Clevis Type	Notes	Weight (lbs)
MK21010S	1-1/2" X 10 Spline	5.5"	1.3" Pin Spacing		7.2
MK21011S	1-1/2" X 10 Spline	6.5"	1.3" Pin Spacing		7.2
MK21016S	1-1/2" X 10 Spline	6.0"	1.3" Pin Spacing		7.2
MK21100S	1-1/2" X 10 Spline	5.5"	5/8" – 18 Std		7.2
MK21101S	1-1/2" X 10 Spline	6.5"	5/8" – 18 Std		7.2
MK21102S	1-1/2" X 10 Spline	5.5"/6.5"	5/8" – 18 Std	Double Drilled	7.2
MK21103S	1-1/2" X 10 Spline	5.0"/6.0"	5/8" – 18 Std	Double Drilled	7.2
MK21104S	1-1/2" X 10 Spline	5.0"/6.0"/7.0"	5/8" – 18 Std		8.0
MK21106S	1-1/2" X 10 Spline	6.0"	5/8" – 18 Std		7.2
MK21152S	1-1/2" X 10 Spline	5.5"/6.5"	5/8" – 18 Std	12-1/4" Brake Applications Bent Arm	7.2
MK21153S	1-1/2" X 10 Spline	5.0"/6.0"	5/8" – 18 Std	12-1/4" Brake Applications Bent Arm	7.2
MK21200S	1-1/2" X 10 Spline	5.5"	1/2" – 20 Std		7.2
MK21206S	1-1/2" X 10 Spline	6.0"	1/2" – 20 Std		7.2
MK21300S	1-1/2" X 10 Spline	5.5"	5/8" – 18 Offset		7.2
MK21306S	1-1/2" X 10 Spline	6.0"	5/8" – 18 Offset		7.2
MK21400S	1-1/2" X 10 Spline	5.5"	1/2" – 20 Offset		7.2
MK21406S	1-1/2" X 10 Spline	6.0"	1/2" – 20 Offset		7.2
MK21700S	1-1/2" X 10 Spline	5.5"	5/8" – 18 Ext	Extended Clevis	7.2
MK21706S	1-1/2" X 10 Spline	6.0"	5/8" – 18 Ext	Extended Clevis	7.2
MK22010S	1-1/2" X 28 Spline	5.5"	1.3" Pin Spacing		7.2
MK22011S	1-1/2" X 28 Spline	6.5"	1.3" Pin Spacing		7.2
MK22016S	1-1/2" X 28 Spline	6.0"	1.3" Pin Spacing		7.2
MK22100S	1-1/2" X 28 Spline	5.5"	5/8" – 18 Std		7.2
MK22101S	1-1/2" X 28 Spline	6.5"	5/8" – 18 Std		7.2
MK22102S	1-1/2" X 28 Spline	5.5"/6.5"	5/8" – 18 Std	Double Drilled	7.2
MK22103S	1-1/2" X 28 Spline	5.0"/6.0"	5/8" – 18 Std	Double Drilled	7.2
MK22104S	1-1/2" X 28 Spline	5.0"/6.0"/7.0"	5/8" – 18 Std		8.0
MK22106S	1-1/2" X 28 Spline	6.0"	5/8" – 18 Std		7.2
MK22152S	1-1/2" X 28 Spline	5.5"/6.5"	5/8" – 18 Std	12-1/4" Brake Applications Bent Arm	7.2
MK22153S	1-1/2" X 28 Spline	5.0"/6.0"	5/8" – 18 Std	12-1/4" Brake Applications Bent Arm	7.2
MK22202S	1-1/2" X 28 Spline	5.5"/6.5"	1/2" – 20 Std	Double Drilled	7.2
MK22203S	1-1/2" X 28 Spline	5.0"/6.0"	1/2" – 20 Std	Double Drilled	7.2
MK22206S	1-1/2" X 28 Spline	6.0"	1/2" – 20 Std		7.2
MK22300S	1-1/2" X 28 Spline	5.5"	5/8" – 18 Offset		7.2
MK22306S	1-1/2" X 28 Spline	6.0"	5/8" – 18 Offset		7.2
MK22400S	1-1/2" X 28 Spline	5.5"	1/2" – 20 Offset		7.2
MK22406S	1-1/2" X 28 Spline	6.0"	1/2" – 20 Offset		7.2
MK22700S	1-1/2" X 28 Spline	5.5"	5/8" – 18 Ext	Extended Clevis	7.2
MK22706S	1-1/2" X 28 Spline	6.0"	5/8" – 18 Ext	Extended Clevis	7.2
MK23100S	1-5/8" X 37 Spline	5.5"	5/8" – 18 Std		7.2
MK23102S	1-5/8" X 37 Spline	5.5"/6.5"	5/8" – 18 Std	Double Drilled	7.2
MK23103S	1-5/8" X 37 Spline	5.0"/6.0"	5/8" – 18 Std	Double Drilled	7.2
MK23106S	1-5/8" X 37 Spline	6.0"	5/8" – 18 Std		7.2
MK23152S	1-5/8" X 37 Spline	5.5"/6.5"	5/8" – 18 Std	12-1/4" Brake Applications Bent Arm	7.2
MK23153S	1-5/8" X 37 Spline	5.0"/6.0"	5/8" – 18 Std	12-1/4" Brake Applications Bent Arm	7.2

Without Auto-Check™

STEMCO Crewson Part Number	Spline Type	Arm Length	Clevis Type	Notes	Weight (lbs)
MK24010S	1-1/4" X 10 Spline	5.5"	1.3" Pin Spacing		7.2
MK24100S	1-1/4" X 10 Spline	5.5"	5/8" – 18 Std		7.2
MK24102S	1-1/4" X 10 Spline	5.5"/6.5"	5/8" – 18 Std	Double Drilled	7.2
MK24103S	1-1/4" X 10 Spline	5.0"/6.0"	5/8" – 18 Std	Double Drilled	7.2
MK24104S	1-1/4" X 10 Spline	5.0"/6.0"/7.0"	5/8" – 18 Std	Triple Drilled	8.0
MK24106S	1-1/4" X 10 Spline	6.0"	5/8" – 18 Std		7.2
MK24200S	1-1/4" X 10 Spline	5.5"	1/2" – 20 Std		7.2
MK24206S	1-1/4" X 10 Spline	6.0"	1/2" – 20 Std		7.2
MK24300S	1-1/4" X 10 Spline	5.5"	5/8" – 18 Offset		7.2
MK24306S	1-1/4" X 10 Spline	6.0"	5/8" – 18 Offset		7.2
MK24400S	1-1/4" X 10 Spline	5.5"	1/2" – 20 Offset		7.2
MK24406S	1-1/4" X 10 Spline	6.0"	1/2" – 20 Offset		7.2
MK24700S	1-1/4" X 10 Spline	5.5"	5/8" – 18 Ext	Extended Clevis	7.2
MK25100S	1-1/4" X 24 Spline	5.5"	5/8" – 18 Std		7.2
MK25102S	1-1/4" X 24 Spline	5.5"/6.5"	5/8" – 18 Std	Double Drilled	7.2
MK25103S	1-1/4" X 24 Spline	5.0"/6.0"	5/8" – 18 Std	Double Drilled	7.2
MK25106S	1-1/4" X 24 Spline	6.0"	5/8" – 18 Std		7.2
MK25200S	1-1/4" X 24 Spline	5.5"	1/2" – 20 Std		7.2
MK25206S	1-1/4" X 24 Spline	6.0"	1/2" – 20 Std		7.2
MK25300S	1-1/4" X 24 Spline	5.5"	5/8" – 18 Offset		7.2
MK25306S	1-1/4" X 24 Spline	6.0"	5/8" – 18 Offset		7.2
MK25400S	1-1/4" X 24 Spline	5.5"	1/2" – 20 Offset		7.2
MK25406S	1-1/4" X 24 Spline	6.0"	1/2" – 20 Offset		7.2

Manual Brake Adjusters

STEMCO Crewson Part Number	Spline Type	Arm Length	Notes	Weight (lbs)
MM1200S	1-1/2" X 10 Spline	5.0"/6.0"/7.0"	Straight Arm	5.3
MM1202S	1-1/2" X 10 Spline	5.5"/6.5"	Straight Arm	5.3
MM1296S	1-1/2" X 10 Spline	6.0"	Curved Arm	5.3
MM2200S	1-1/2" X 28 Spline	5.0"/6.0"/7.0"	Straight Arm	5.3
MM2202S	1-1/2" X 28 Spline	5.5"/6.5"	Straight Arm	5.3
MM2204S	1-1/2" X 28 Spline	5.0"/6.0"	Straight Arm	5.3
MM2296S	1-1/2" X 28 Spline	6.0"	Curved Arm	5.3
MM3200S	1-5/8" X 37 Spline	5.0"/6.0"/7.0"	Straight Arm	5.3
MM3206S	1-5/8" X 37 Spline	6.0"	Straight Arm	5.3
MM4200S	1-1/4" X 10 Spline	5.0"/6.0"/7.0"	Straight Arm	5.3
MM4201S	1-1/4" X 10 Spline	4.5"/5.5"	Straight Arm	5.3
MM4204S	1-1/4" X 10 Spline	5.0"/6.0"	Straight Arm	5.3
MM5201S	1-1/4" X 24 Spline	4.5"/5.5"	Straight Arm	5.3

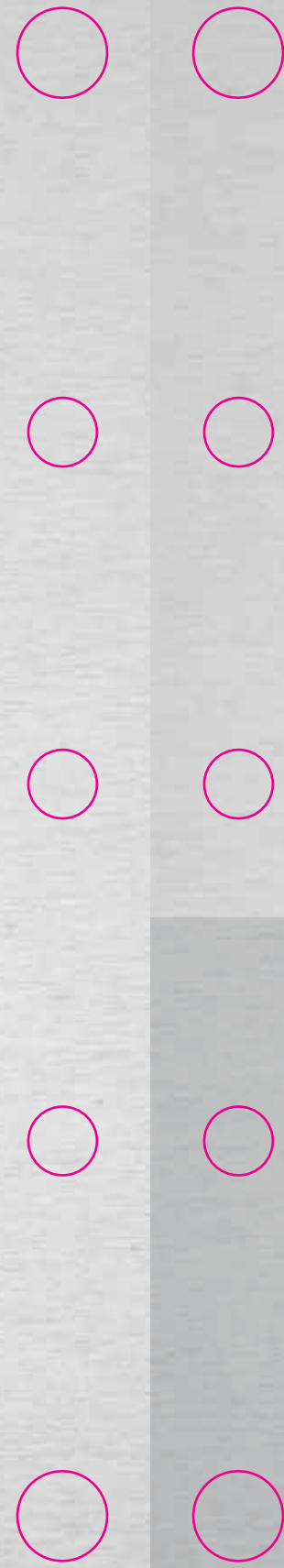

Pin Kits, Pointers, and Cutoff Tool

STEMCO Crewson Part Number	Description	STEMCO Crewson Part Number	Description
 MC8056KTAS	Pin Kit for ABA with Auto-Check™	 MC8500S	Pointer for ABA with Auto-Check™
 MC8056KTS	Pin Kit for ABA without Auto-Check™	 MC8530S	Alignment Cutoff Tool
 SC8056KTAS	Stainless Steel Clevis Pin Kit for ABA with Auto-Check™	 MC5103S	Arm Bushing Kit
		 1951002	Brake Spring Installation Tool



Clevis Kits Without Auto-Check™

STEMCO Crewson Part Number	Fits Push Rod Thread	Straight or Offset	Auto-Check™
 MC8410KTS	1/2" - 20	Straight	No
 MC8415KTS	1/2" - 20	Offset	No
 MC8412KTS	1/2" - 20	Short	No
 MC8420KTS	5/8" - 18	Straight	No
 MC8425KTS	5/8" - 18	Offset	No
 MC8422KTS	5/8" - 18	Short	No
 MC8480KTS	5/8" - 18	Extended	No

Clevis Kits With Auto-Check™

STEMCO Crewson Part Number	Fits Push Rod Thread	Straight or Offset	Auto-Check™
 MC8410KTAS	1/2" - 20	Straight	with Auto-Check™
 MC8412KTAS	1/2" - 20	Short	with Auto-Check™
 MC8415KTAS	1/2" - 20	Offset	with Auto-Check™
 MC8420KTAS	5/8" - 18	Straight	with Auto-Check™
 MC8422KTAS	5/8" - 18	Short	with Auto-Check™
 MC8425KTAS	5/8" - 18	Offset	with Auto-Check™
 MC8480KTAS	5/8" - 18	Extended	with Auto-Check™



1 Kit
SK1225UOR

12.25" Spicer Dana New Style U Brake
1 HD Return Spring: 1" O.D., 6 9/16" Length
2 Spring Pins
2 Retainers
1 Retainer Clip
2 Roller Retainers
2 Anchor Pins

1 Kit 10 Kits
SK1225DXPG **BSK1225DXPG**

12.25" Dexter
1 HD Return Spring: 1" O.D., 6 9/16" Length
2 Spring Pins
2 Retainer Springs
2 Knurled Rollers
2 Roller Pins
2 Lock Rings
2 Anchor Pins
2 Bushings



1 Kit 10 Kits
SK1500E **BSK1500E**

15" Eaton
1 Return Spring: 13/16" O.D., 7 1/8" Length
1 Retainer Spring
2 Rollers

1 Kit 10 Kits
SK1308Q **BSK1308Q**

15" Meritor Front Brake
1 Return Spring: 13/16" O.D., 7 11/16" Length
1 Retainer Spring
2 Rollers
2 Shoe Clips
2 Washers
1 Wear Plate
2 Anchor Pins
2 Nuts

1 Kit
SK1225E

12.25" Eaton
1 Return Spring: 1" O.D., 5" Length
2 Retainer Springs
2 Rollers
2 Washers
1 Lock Washer
1 Lock Ring
1 Anchor Pin
1 Lock Nut

1 Kit 10 Kits
SK1225Q **BSK1225Q**

12.25" Meritor Q Brake
1 Return Spring: 1 1/8" O.D., 6 7/8" Length
2 Spring Pins
2 Retainer Springs
2 Knurled Rollers
2 Roller Pins
4 Lock Rings
2 Anchor Pins
2 Bushings



1 Kit
SK1500T

15" Meritor T Series Types 1 & 2
1 Return Spring: 7/8" O.D., 7 3/16" Length
2 Rollers
2 Lock Rings
2 Washers
2 Anchor Pins
2 Nuts
1 Hold Down Kit

1 Kit 10 Kits
SK1500QP **BSK1500QP**

15" Meritor Q Plus Front Brake
1 Return Spring: 1 1/8" O.D., 8 3/8" Length
2 Spring Pins
2 Retainer Springs
2 Knurled Rollers
2 Roller Retainers
2 Anchor Pins
2 Bushings

1 Kit 10 Kits
SK1225SF **BSK1225SF**

12.25" Standard Forge Fabricated Shoe
1 HD Return Spring: 1" O.D., 6 9/16" Length
2 Spring Retainer Pins
2 Knurled Rollers
2 Roller Pins
4 Washers
2 Lock Rings
4 Lock Rings
2 Anchor Pins
2 SS Bushings

1 Kit
SK1225SF-CF

12.25" Standard Forge Conversion from Cast to Fabricated Shoes
1 HD Return Spring: 1" O.D., 6 9/16" Length
2 Spring Retainer Pins
2 Knurled Rollers
2 Roller Pins
2 Lock Washers
2 Links
2 Lock Rings
2 Anchor Pins
2 Jam Nuts



1 Kit 10 Kits
SK4729E **BSK4729E**

15" Eaton
1 Return Spring: 1 1/4" O.D., 9 1/4" Length
2 Retainer Springs
2 Rollers
2 Roller Retainers

1 Kit
SK4693BQ

15" Bendix Ford Cargo
1 Return Spring
2 Retainer Springs
2 Rollers
2 Roller Pins
1 Anchor Pin

1 Kit
SK4716E

15" Eaton Extra Service and Second Generation
1 Return Spring: 1 3/16" O.D., 3 9/16" Length
2 Retainer Springs
2 Knurled Rollers
2 Roller Retainers

1 Kit
SK4717E

15" Eaton Extra Service and Second Generation
1 Return Spring: 1 1/8" O.D., 10 1/8" Length
2 Retainer Springs
2 Knurled Rollers
2 Roller Retainers

1 Kit 10 Kits
SK1650QH **BSK1650QHD**

16.5" Q and Q+, Intraxx®, Meritor, Spicer XL
1 HD Return Spring: 1 1/4" O.D., 8 3/8" Length
2 Spring Pins
2 Retainer Springs
2 Knurled Rollers
2 Roller Retainers
2 Anchor Pins
2 Bushings

1 Kit 10 Kits
SK1650X3HD **BSK1650X3HD**

16.5" Fruehauf XEM3 (Pro-Par®)
1 HD Return Spring: 8 3/8" Length
2 Spring Pins
2 Retainer Springs
2 Knurled Rollers
2 Roller Retainers
2 Anchor Pins
2 Bushings

1 Kit 10 Kits
SK1650QFR **BSK1650QFR**

16.5" Q and Q+, Intraxx®, Meritor, Spicer XL
1 Return Spring: 9 1/16" Length
2 Spring Pins
2 Retainer Springs
2 Knurled Rollers
2 Roller Retainers
2 Anchor Pins
2 Bushings

1 Kit 10 Kits
SK1650PHD **BSK1650PHD**

16.5" Universal P Meritor
1 HD Return Spring: 8" Length
2 Spring Pins
2 Knurled Rollers
2 Roller Retainers
4 Washers
4 Lock Rings
2 Anchor Pins
2 Bushings

1 Kit
SK1650XL

16.5" Spicer Dana XL Brake
1 HD Return Spring: 8" Length
2 Spring Pins
2 Retainer Springs
2 Roller Pins
2 Roller Retainers
2 Anchor Pins
2 Bushings

1 Kit
SK1650BQ

16.5" Bendix Q (Ford Cargo)
1 Return Spring
2 Spring Pins
2 Retainer Springs
2 Knurled Rollers
2 Anchor Pins
2 Rollers
2 Bushing

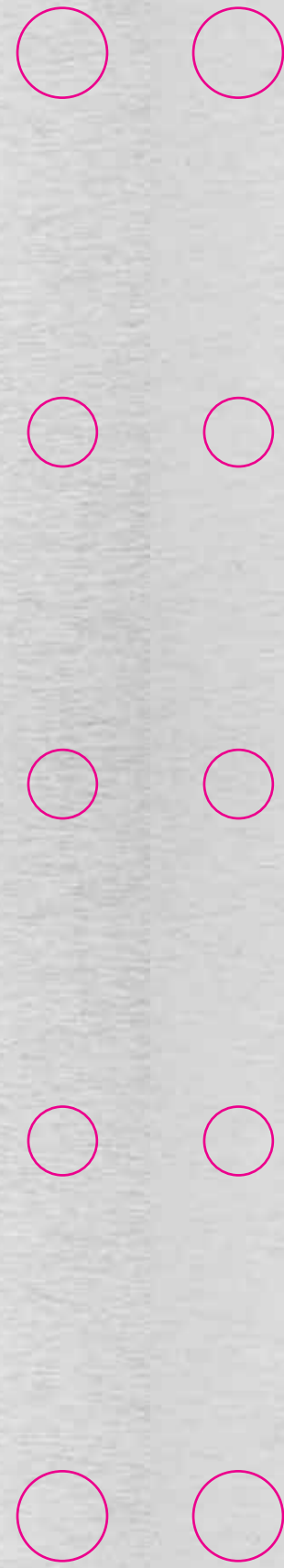

1 Kit 10 Kits

SK1650E1 **BSK1650E1**

16.5" Eaton
1 HD Return Spring: 10 13/16" Length
2 Retainer Springs
2 Knurled Rollers
2 Roller Pins

1 Kit

SK1650EHM

16.5" Eaton High Mount
1 HD Return Spring: 10" Length
2 Retainer Springs
2 Knurled Rollers
2 Roller Pins

1 Kit 10 Kits

SK1650E1 **BSK1650E1**

16.5" Eaton First Generation with Tabs
1 HD Return Spring: 10 3/4" Length
2 Retainer Springs
2 Knurled Rollers
2 Roller Retainers

1 Kit 10 Kits

SK1650E2 **BSK1650E2**

16.5" Eaton Second Generation with No Tabs
1 HD Return Spring: 10 3/4" Length
2 Retainer Springs
2 Knurled Rollers
2 Roller Retainers

1 Kit 10 Kits

SK1650E2FR **BSK1650E2FR**

16.5" Eaton Combination Kit for either straight or horse collar steer axle applications (4179 & 4725)
1 HD Return Spring: 10 3/4" Length
2 Retainer Springs
2 Knurled Rollers
2 Roller Retainers
2 Retainer Springs (for horse collar)

1 Kit 10 Kits

SK1650E2HC **BSK1650E2HC**

16.5" Eaton Steer Axle - For horse collar applications only (4719 & 4725)
2 Retainer Springs (for horse collar): 3 9/16" Lengths
2 Knurled Rollers
2 Retainer Springs
2 Roller Retainers

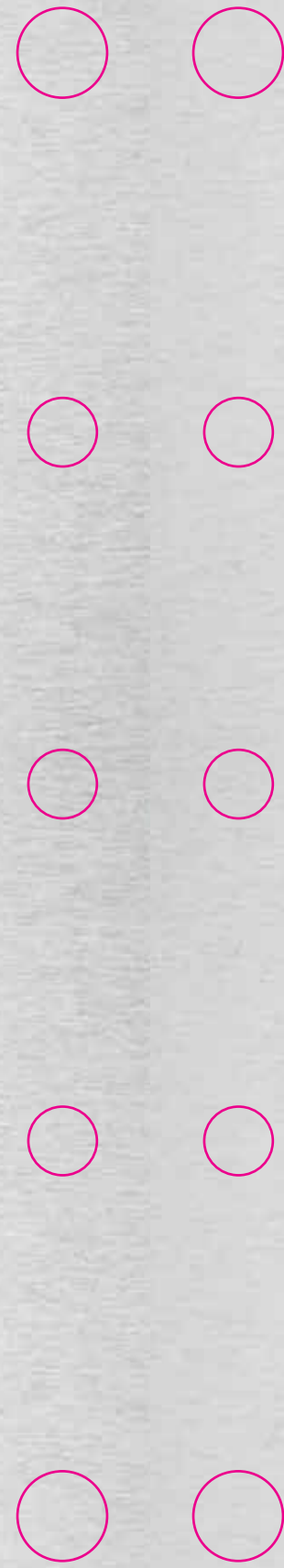

1 Kit

SK44710SC

18" Meritor Old Style Cast Shoe
1 Return Spring
2 Spring Clips
2 Rollers
2 Anchor Pins
4 Lock Rings
4 Shoe Bushings
4 Seals
2 Lock Screws

1 Kit

SK4471NSC

18" Meritor New Style Cast Shoe
1 Return Spring
2 Spider Bushings
2 Rollers
2 Anchor Pins
4 Lock Rings
4 Shoe Bushings
4 Seals
2 Lock Screws

1 Kit

SK1800EC

18" Eaton Cast Brake
1 HD Return Spring: 11" Length
2 Retainer Springs
2 Rollers
2 Roller Pins

BATCO	STEMCO
08-100400	SK1650PHD
08-104200	SK1650E
08-104300	SK4716E
08-104900	SK1225FCII
08-105104	SK1225UOR
08-1074	SK1225SF
08-107404	SK1225DPOR
08-107500	SK1225SF-CF
08-1076	SK1225E
08-1077	N/A
08-108840	SK1650QHD
08-108840	SK1650QHD
08-108850	SK1650QFR
08-109130	SK1650X3HD
08-1093	SK1225Q
08-1103	SK1650EHM
08-1107	SK1500T
08-1111	SK1500Q
08-111300	SK1500E
08-1128	SK1225DP
08-1146	SK1225U
08-114700	SK4729E
08-114800	SK1650E1
08-1160	SK1500QP
08-1162	SK1650XL

BENDIX	STEMCO
HK16XLS	SK1650PHD
HK24XLHM	SK1650EHM
HK24XLSLM	SK1650E
HK29XLS	SK1500QP
HK29XLS	SK1650QHD
HK29XLS	SK1650QHD
HK34XLS	SK1650X3HD
HK40	SK1225E
HK41	N/A
HK43XLS	SK1225SF
HK44XLS	SK1225Q
HK47XLS-150	SK1225UOR
HK48-125	SK1225DP
HK48-150	SK1225DPOR
HK49-150	SK1225DFC
HK51	SK1500T
HK54	SK1500E
HK55	SK1500Q
HK58XLS	SK1225DXPQ
HK61	SK1650E2
HK62XLS	SK1650E2HC
HK63	SK1650E1
HK68	SK44710SC
HK70	SK4693BQ
HK74XLS	SK1650QFR
HK90XLS	SK4716E
HK91XLS	SK4717E
HK96XLS	SK1650XL
HK97XLS	SK4729E

BWP	STEMCO
M-K10/MK99	SK1650E
M-K11	SK4607C
M-K12	SK1225SF
M-K2/M-K7	SK1650PHD
M-K39/M-K72	SK1650QHD
M-K39/M-K72	SK1650QHD
M-K42	SK1650X3HD
M-K43	SK1225SF-CF
MK-45	SK1225Q
MK-46	SK1225E
MK-47	N/A
M-K52	SK1500T
M-K6	SK1650EHM
M-K77	SK1500E
M-K79	SK1500Q
M-K80	SK1225DP
M-K83	SK1225U
M-K84	SK1650E1
M-K91	SK1650XL
M-K98	SK1500QP

EUCLID	STEMCO
E-10244	SK1650E2
E-10756	SK1225FCII
E-10760	SK1650E2HC
E-10875	SK1225DXPQ
E-11981	SK4729E
E-1308E	SK1500E
E-1308Q	SK1500Q
E-1308T	SK1500T
E-14539	SK1225DFC
E-1816HD	SK1650PHD
E-1887AHD	SK1650E
E-2030HD	SK4607C
E-2126	SK1225E
E-2286	N/A
E-2402HD	SK1225SF
E-2403HD	SK1225SF-CF
E-2769HD	SK1650QHD
E-2769HD	SK1650QHD
E-3373HD	SK1225DP
E-3484	SK1225Q
E-3518	SK44710SC
E-3710HD	SK1650X3HD
E-3782	SK1225U
E-3801	SK1650EHM
E-3869	SK1500Q
E-3992	SK4471NSC
E-4311EHD	SK1650E
E-4515PHD	SK1650PHD
E-4515QHD	SK1650QHD
E-4515XHD	SK1650X3HD
E-4691	SK1500T
E-4702KT	SK1500QP
E-4709E2	SK1650E2
E-4709ES	SK1650E1
E-5139	SK1500E
E-5481	SK1650E1
E-5515	SK1650XL
E-7231	SK4693BQ
E-7237	SK1650BQ
E-9039	SK4717E
E-9064	SK1500QP
E-9141	SK4716E
E-9281	SK1225DPOR
E-9283	SK1225UOR
E-9644	SK1650QFR

HALDEX	STEMCO
CQ65446	SK1650E2HC
CQ65477	SK1650E2
CQ65481	SK1650E1
CQ65515	SK1650XL
CQ65519	SK4693BQ
CQ65520	SK1650BQ
CQ65642	SK1500QP
CQ66735	SK1650PHD
CQ66867	SK1650QHD
CQ66887	SK1650QFR
CQ66914	SK1650X3HD
CQ66917	SK1500E
CQ66919	SK1500T
CQ66947	SK4716E
CQ66948	SK4717E
CQ67319	SK1650E
CQ67319	SK1650QHD
CQ67388	SK1225E
CQ67394	N/A
CQ67394	SK1225SF
CQ67395	SK1225Q
CQ67403	SK1225DP
CQ67405	SK1225DPOR
CQ67407	SK44710SC
CQ67408	SK4471NSC
CQ67437	SK1225FCII
CQ67899	SK1500Q
CQ69001	SK1500Q
CQ69002	SK1225U
CQ69003	SK1500Q
CQ69004	SK1650EHM
CQ69006	SK1225UOR
CQ69007	SK4729E

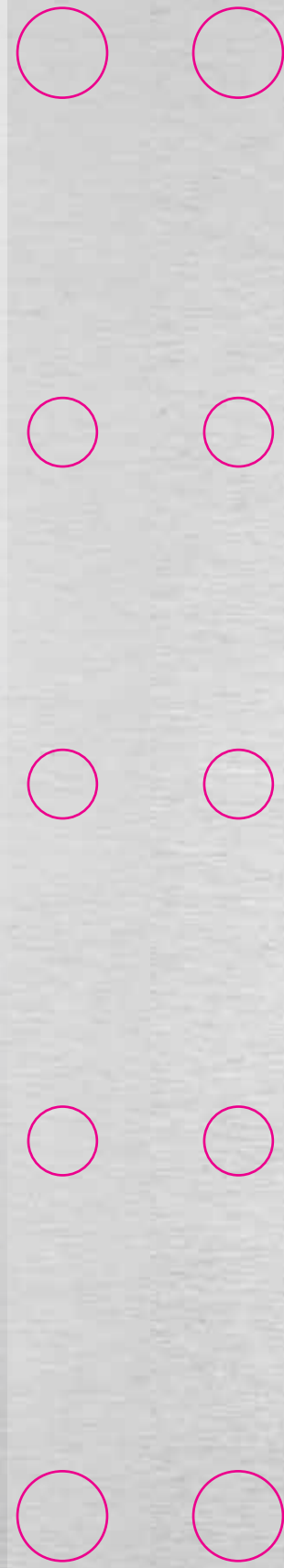

LELAND	STEMCO
K-105	N/A
K-154	SK1225Q
K-260	SK1500T
K-263	SK1500E
K-277	SK1225DP
K-279	SK1225U
K-283	SK1500Q
K-295	SK1650E1
K-305	SK1650XL
K-309	SK1650X3HD
K-316	SK1650EHM
K-318	SK1500QP
K-329	SK1650QHD
K-329	SK1650QHD
K-334	SK1650QFR
K-335	SK1225DPOR
K-336	SK1225UOR
K-356	SK4716E
K-358	SK4717E
K-373	SK1225FCII
K-375	SK1650E2
K-376	SK1650E2HC
K-42/K119	SK1650E
K-45/K-116	SK1650PHD
K-50	SK1225SF-CF
K-515	SK4729E
K-62	SK4607C
K-69	SK1225SF

MERITOR	STEMCO
KIT8000HD	SK1650QHD
KIT8000HD	SK1650QHD
KIT8004	SK1225Q
KIT8029	SK1500Q
KIT8081	SK1650QFR
KIT8824HD	SK1500QP
KIT9094	SK1500T
KIT9179	SK44710SC
MKT1308E	SK1500E
MKT1308Q	SK1500Q
MKT1308T	SK1500T
MKT4311EHD	SK1650E
MKT4515PHD	SK1650PHD
MKT4515QHD	SK1650QHD
MKT4515XHD	SK1650X3HD
MKT4702KT	SK1500QP
MKT4709ES	SK1650E1
MKT4709ES2	SK1650E2
R507000	SK1225E
R507002	SK1650E
R507004	SK1500E
R507005	N/A
R507010	SK1650X3HD
R507014	SK4607C
R507015	SK1225SF
R507057	SK1650E1
R507063	SK1650XL
R507064	SK1650E2
R507068	SK1225SF-CF
R507074	SK1225DP
R507076	SK1225U
R507077	SK1650EHM
R507080	SK4693BQ
R507081	SK1650BQ
R507083	SK4717E
R507086	SK4716E
R507088	SK1225DPOR
R507090	SK1225UOR
R507092	SK1225FCII
R507094	SK1650E2HC
R507095	SK1225DXPQ
R509001	SK1650PHD
R509408	SK4471NSC
R615026	SK4729E

SIRCO	STEMCO
EF-1	SK1500E
EF-2	SK1650E2HC
EK-1HD	SK1650E
EK-3	SK1650EHM
ES-1	SK1650E1
ES-2	SK1650E2
ES-3	SK4716E
ES-4	SK4717E
LB-1	SK1225SF
LB-10	SK1225FCII
LB-2	SK1225DP
LB-3	SK1225Q
LB-4	SK1225E
LB-5	N/A
LB-6	SK1225U
LB-8	SK1225UOR
LB-9	SK1225DPOR
MF-2	SK1650QFR
QK-1HD	SK1650QHD
QK-1HD	SK1650QHD
RF-3	SK1500Q
RF-5	SK1500QP
TK-4HD	SK1650PHD
XK-3HD	SK1650X3HD
XL-1	SK1650XL

SPICER	STEMCO
14-4A	SK1650PHD
24-1A	SK1650E
24-1AF	SK1650EHM
29-1A	SK1650QHD
29-1A	SK1650QHD
29XL	SK1650XL
326514	SK4729E
34A	SK1650X3HD
40A	SK1225E
41A	N/A
42A	SK4607C
43A	SK1225SF
44A	SK1225Q
45A	SK1225SF-CF
47A	SK1225U
47B	SK1225UOR
48A	SK1225DP
48B	SK1225DPOR
51-1A	SK1500T
54A	SK1500E
55A	SK1500Q
66A	SK1500QP
TA63A	SK1650E1

STEMCO®

LONG LIFE
WHEEL ENDS

SERVICEABLE, AFFORDABLE, FLEXIBLE

PLATINUM PLUS
PERFORMANCE SYSTEM™

PLATINUM
PERFORMANCE SYSTEM™



Flexible Options To Fit Your Installation Preferences

STEMCO's Platinum Performance System™ — an integrated system of products and performance. With the Platinum Performance System™, you can extend your wheel end to a three-year or five-year limited warranty

Simply the Best

Benefit from unprecedented product performance with STEMCO's exclusive, patented Guardian® HP or Discover® Seal; Pro-Torq® Advanced Axle Spindle Nut; and the tamper-proof Sentinel® or Integrated Sentinel® Hub Cap. Receive extended bearing warranty by adding STEMCO Heavy Duty Bearings.

Higher Performance Equals Less Maintenance

When you specify the Platinum Performance System™, you are assured of performance that will protect your fleet and your maintenance budget. The unprecedented performance of this STEMCO system will lower your maintenance costs by reducing down-time and protecting your wheel end investment.

PLATINUM Performance System™

STEMCO LONG-LIFE WHEEL END SYSTEMS OFFER:

- **Simplicity** – Proven, known wheel end design.
- **Low Cost** – No costly equipment changes.
- **Durability** – Uses high performance components for sealing, bearings, bearing adjustment and lubricant protection.
- **Field Serviceable** – Standard hub, axle, lubricant and bearings.
- **Reliability** – Address traditional wheel end failure areas with high performance technology products working as a system.

PLATINUM PERFORMANCE SYSTEM™

- Guardian® HP or Discover® Seal
- Pro-Torq® Nut
- Sentinel® or Integrated Sentinel® Hub Cap
- Platinum Matched Bearings (optional)
- Available for OEM Spec or Fleet Retrofit
- 3 - Year Limited Warranty

PLATINUM PLUS PERFORMANCE SYSTEM™

- Guardian® HP or Discover® Seal
- Pro-Torq® Nut
- Sentinel® or Integrated Sentinel® Hub Cap
- Heavy Duty Bearings
- Available for OEM Spec Only
- 5 - Year Limited Parts and Labor Warranty

- All components available separately.
- Platinum Performance System™ warranty available on new vehicle spec or aftermarket retrofit.
- Platinum Performance System™ Plus warranty available for OEM spec only.



A Higher Standard of Performance.™

an EnPro Industries company

GUARDIAN® HP / DISCOVER® SEALS



These high performance seals are available in a hub or a spindle mount configuration.

HEAVY DUTY BEARINGS



STEMCO bearings ensure the highest quality, performance and reliability.

PRO-TORQ® ADVANCED AXLE SPINDLE NUT



Extends the life of the tire, seal and bearing while enabling more accurate ABS sensor monitoring.

INTEGRATED SENTINEL® / SENTINEL® HUB CAPS



The patented Sentinel® technology is the only technology available in the market that ensures that wheel-end lubricant is kept pristine. These tamper-proof hub caps provide an unmatched filtering system against grime, dirt and water.

LONGER LIFE FOR THE LONGEST HAUL

Guardian®
HP
HUB SEALS



Single-Step, Error-Proof Installation

Installation right on the axle instead of the hub bore assures positive alignment every time with virtually error-proof installation. There's no tool impact on the seal causing damage or installation-related failures. Guardian® HP is easy to remove and service, with no bearings damaged during seal removal.

Technologically Advanced Seal

Guardian® HP has been developed for extra protection and greater sealing with its high performance sealing lip and superior contamination exclusion. The rubber outer diameter allows for faster hub cleaning with less corrosion damage to the hub.

Trailer and Axle OEM Standard Seal

The axle installation is durable and unique with proven success for over 25 years. Enhanced features offer improved cost-per-mile performance with simple, one-step axle installation. Guardian® HP is the seal of choice in the heavy duty trailer industry.

HUB SEALS

GUARDIAN® HP Application Reference Guide



APPLICATION	GUARDIAN® HP	INNER BEARING	UNIVERSAL AXLE TOOL HEADS
19,000# Trailer Axle Standard Forge, Dana, Meritor, Eaton	307-0713	663	555-5100
Pro-Par Trailer Axle Fruehauf, Eaton P-22 Meritor TP, Dana	307-0723	HM518445	555-5023
22,500# Trailer Axle Meritor, Standard Forge, Dana Eaton	307-0743	HM218248	555-5039
12,000# Front Axle Meritor, Eaton Ford, Freightliner, Kenworth, Western Star, Navistar Peterbilt, Volvo GM	308-0836	39581 HM212044 HM212049-X HM212047	555-5062 555-5061 555-5098 555-5066
16,000# Front Axle Ford, Navistar, Mack, Meritor, White, Kenworth, Volvo GM, Western Star, Peterbilt	308-0864	6461A	555-5007
34,000# Drive Axle, Mack 44,000# Drive Axle, Mack	309-0903 309-0904	580, 582 663, HM516449-C HM516449-A	555-5072 555-5072 555-5073
38,000# 46,000# Tandem Axles, Eaton, Ford, Freightliner, Kenworth, Western Star, Peterbilt, Meritor, Navistar, Volvo GM	309-0973	594,-A 598,-A	555-507 555-5071

GUARDIAN® HP SEAL

Three O.D. Beads
For Easier Hub Docking

Semi-Unitized Design

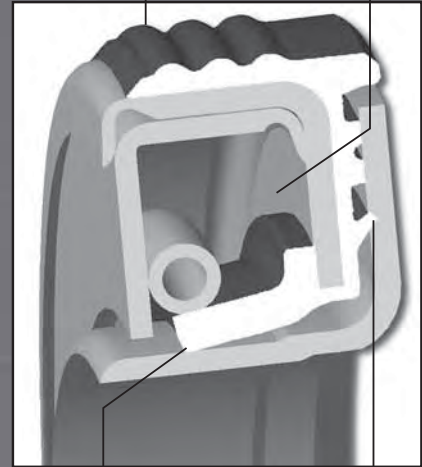

High Performance
Sealing Lip

Flexible Containment
Exclusion Lip

Sealing lip, O.D. beads, thrust pad, and flexible containment exclusion lip are all molded as a single unit from high performance HNBR-Teflon® elastomer for fewer leak paths and better heat resistance.

GUARDIAN® HP Interchange

GUARDIAN® HP	STEMCO	SKF	SKF PLUS	SKF LONGLIFE	NATIONAL	5 STAR	OUTRUNNER
307-0713	372-7098	40136	40133	40146	370036A	380036A	850
307-0723	372-7099	42623	42623	42631	370065A	380065A	851
307-0743	372-7097	46305	46304	46308	370025A	380025A	859
308-0836	382-8036	35066	35059	35102	370001A	380001A	847
308-0864	382-8064	43764	43763	N/A	370048A	380048A	863
309-0903	392-9094	45099	45097	45108	370022A	380022A	856
309-0904	392-9112 392-9130	42672	42671	N/A	370031A	380031A	852
309-0973	392-9131	47697	47695	47693	37003A	38003A	861



HUB INSTALLED UNITIZED DESIGN

Discover®



Increase the Performance Expectations of Wheel Ends

The Discover® seal features a high temperature elastomeric co-polymer sealing element. The revolutionary design incorporates hydrodynamic “pumping” features to keep the lubricant where it is intended to be.

Maintain the Lubricant’s Integrity to Lengthen the Life of the Seal

The premium sealing element is protected by a four-zone labyrinth to provide unmatched contaminant exclusion and performance.

Have Complete Confidence During the Installation Stage

Discover® seal’s piloted entry allows an easy and square installation every time. The ridged steel case is the impact point for the tool head to maintain the internal geometries.

Reduce Removal Time and Effort Without Special Tools or Adjacent Component Damage

The Discover® seal consists of a bonded, ribbed rubber OD and ID for easier removals, yet STEMCO’s patented “SMART” anti-rotation features insure positive positioning and locking of the seal to the spindle.

Extended Warranty Component

Install the Discover® seal with STEMCO’s other premium wheel end components to obtain the Platinum Performance System.™ This system combines the Discover® or Guardian® HP seal, Pro-Torq® nut, and Sentinel® hub cap for a 3-year warranty.

DISCOVER[®]

High Performance...Revolutionary Design



A Higher Standard of Performance.SM
an EnPro Industries company

DISCOVER[®] CROSS REFERENCE GUIDE

APPLICATIONS	DISCOVER [®] PART NUMBER	INNER BEARING	HUB TOOL PART NUMBER	BEARING GUIDE
19,000# Trailer Axle Standard Forge, Dana, Meritor, Eaton	373-0213	663	551-5313	570-0023
Pro-Par Trailer Axle, Fruehauf, Eaton P-22, Meritor TP, Dana	373-0223	HM518445	551-5401	570-0025
22,500# Trailer Axle, Meritor, Standard Forge, Dana, Eaton	373-0243	HM218248	551-5412	570-0026
12,000# Front Axle, Meritor, Eaton, Ford, Freightliner, Kenworth, Western Star, Navistar, Peterbilt, Volvo GM	383-0236	39581	551-5346	570-0017
		HM212044	551-5346	570-0018
		HM212049,-X	551-5346	570-0020
		HM212047	551-5346	570-0019
12,000# Mack Front Axle	*383-0239	641 or HM212049	551-5413	570-0020
16,000# Front Axle, Ford, Navistar, Mack, Meritor, White, Kenworth, Western Star, Peterbilt, Volvo GM	383-0264	6461A	551-5327	570-0022
34,000#, 38,000# Drive Axle, Mack	393-0203	580 or 582	551-5415	570-0023
44,000# Drive Axle, Mack	393-0204	663 or HM516449,-A	551-5414	570-0023
34,000# Drive Axle, Eaton, Ford, Navistar, Volvo GM	393-0212	47685 or 47686	551-5416	570-0023
		47678 or 5760	551-5416	570-0022
38,000#, 46,000# Tandem Axles, Eaton, Ford, Freightliner, Kenworth, Western Star, Peterbilt, Meritor, Navistar, Volvo GM	393-0273	594 or 594A	551-5320	570-0028
		598 or 598A	551-5320	570-0027

*Also sold as 383-8239 Kit, which includes the 310-1132 shoulder bushing.

DISCOVER[®] INTERCHANGE

DISCOVER [®]	SKF	SKF PLUS	SKF LONGLIFE	NATIONAL	5 STAR	OUTRUNNER
373-0213	40136	40133	40146	370036A	380036A	850
373-0223	42623	42622	42631	370065A	380065A	851
373-0243	46305	46304	46308	370025A	380025A	859
383-0236	35066	35059	35102	370001A	380001A	847
383-0239	39988	39977	39990	370033A	N/A	N/A
383-0264	43764	43763	N/A	370048A	380048A	863
393-0203	45099	45097	45108	370022A	380022A	856
393-0204	42672	42671	N/A	370031A	380031A	852
393-0212	38780	38779	38783	370023A	380023A	849
393-0273	47697	47695	47693	370003A	380003A	861

DISCOVER[®]

Seal Design Features

Bonded Rubber OD Offers Easy Installation with "Piloted" Entry

Rugged Modular Design Avoids Installation Damage

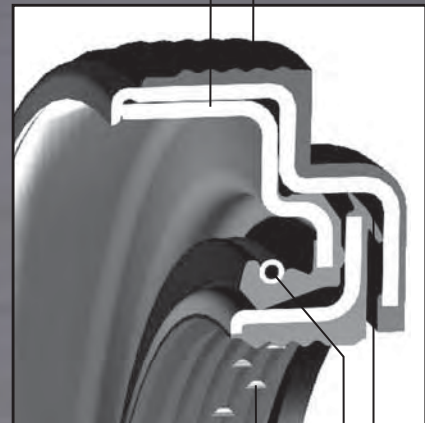

Patented "Smart" Anti-Rotation ID "Locks" onto the Axle

High Temperature Elastomeric Co-Polymer Sealing Element Incorporating Hydrodynamic "Pumping" Features

Four Zone Labyrinth Provides Unmatched Contaminant Exclusion

STEMCO Discover[®] vs. competitor seals (listed by main sealing lip material). Hours shown are accelerated lab life test hours.

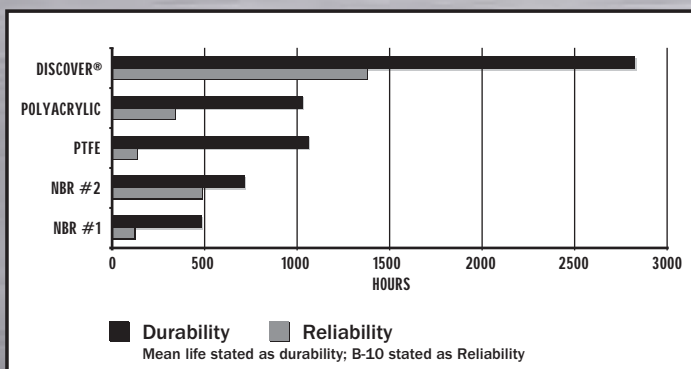

REVOLUTIONARY HUB-INSTALLED UNITIZED SEAL

Voyager®



Simpler, Quicker Installations

The Voyager® seal features a bonded rubber OD and piloted entry ensuring an easy and square installation. The ribbed rubber OD also forms a superior seal between the seal case and the hub bore without the use of additional sealant

Reduce Premature Failures and Rework

The Voyager® seal utilizes a 4-zone labyrinth contaminant exclusion system. This technology is incorporated into a fully-unitized hub-installed seal.

Avoid Seal Damage Upon Installation

The Voyager® seal's thick wall steel construction allows positive hub installation without warping or bending the seal.

Increase Reliability through Superior Material and Design

The temperature-resistant polymer with hydrodynamic "pumping" features keeps the lubricant where it is intended to be.

Eliminate "Pry-Bar" Removal and Adjacent Component Damage

The Voyager® seal's bonded rubber ID and OD allow for easier removal, yet STEMCO's patented anti-rotation "SMART" features lock the ID surface in place.

Superior Contamination Resistance

Voyager® seals resist penetration of both air and water borne contamination while allowing the seal to run cooler.

VOYAGER[®]

Voyager[®] Cross Reference Guide

APPLICATION	VOYAGER [®] P/N	TYPE	INNER BEARING	HUB TOOL P/N	BEARING GUIDE
19,000# Trailer Axle, Standard Forge, Dana, Meritor, Eaton	373-0113	L2	663	551-5313	570-0023
Pro-Par Trailer Axle, Fruehauf, Eaton P-22, Meritor TP, Dana	373-0123	L1	HM518445	551-5401	570-0025
22,500# Trailer Axle, Meritor, Standard Forge, Dana, Eaton	373-0143	L1	HM218248	551-5412	570-0026
20,000# Trailer Axle, Meritor, Shuler	373-0144	L3	665A	551-5339	570-0024
25,000# Trailer Axle	373-0191	L2	749/643	551-5401	570-0003
Meritor Front Transit	383-0101	L2	6386 or 6389 6379	551-5420	570-0020 N/A
12,000# Front Axle, Meritor, Eaton, Ford, Freightliner, Kenworth, Western Star, Navistar, Peterbilt, Volvo GM	383-0136	L1	39581 HM212044 HM212049,-X HM212047	551-5346 551-5346 551-5346 551-5346	570-0017 570-0018 570-0020 570-0019
12,000# Mack Front Axle	*383-0139	L2	641 or HM212049	551-5413	570-0020
Navistar Front Axle, FA309, FA329	383-0153	L3	641 or HM212049 H715345	551-5419 551-5419	570-0020 570-0021
9,000# Front Axle, Navistar, FA 109 Cast Wheel '79 and Up	383-0156	L2	641 H715345	551-5344 551-5344	570-0020 571-0021
16,000# Front Axle, Ford, Navistar, Mack, Meritor, White, Kenworth, Western Star, Peterbilt, Volvo GM	383-0164	L2	6461A	551-5327	570-0022
6,000#, 7,500#, Front Axle, Navistar	383-0166	L3	JM207049 or JM205149	551-5423	570-0036 570-0033
GMC F-120 1985 and up	383-0171	L2	HM212047	551-5403	570-0019
8,000# Front Axle, GMC Topkick	383-0175	L2	JM205149	551-5417	570-0033
11,000# Front Axle, GMC Topkick	383-0176	L2	33212	551-5418	570-0031
34,000#, 38,000# Drive Axle, Mack	393-0103	L2	580 or 582	551-5415	570-0023
44,000# Drive Axle, Mack	393-0104	L2	663 or HM516449,-A	551-5414	570-0023
34,000# Drive Axle, Eaton, Ford, Navistar, White	393-0112	L2	47685 or 47686 47678 or 5760	551-5416 551-5416	570-0023 570-0022
17,000# Single and 34,000# Tandem, GMC	393-0115	L3	47686	551-5424	570-0023
Meritor Drive Transit	393-0134	L2	6580 or 6559	551-5421 551-5421	570-0025 570-0023
50,000#, 60,000# Drive Axle, Mack	393-0148	L2	687 or 780	551-5400	570-0032
38,000#, 46,000# Tandem Axles, Eaton, Ford, Freightliner, Kenworth, Western Star, Peterbilt, Meritor, Navistar, Volvo GM	393-0173	L1	594 or 594A 598 or 598A	551-5320 551-5320	570-0028 570-0027

* Also sold as 383-8139 Kit, which includes the 310-1132 shoulder bushing.

Voyager[®] Interchange

VOYAGER [®]	SKF	SKF PLUS	NATIONAL RED	NATIONAL GOLD	OUTRUNNER
373-0113	40136	40133	370036A	380036A	850
373-0123	42623	42622	370065A	380065A	851
373-0143	46305	46304	370025A	380025A	859
373-0144	43752	43754	370037A	N/A	853
373-0191	42624	N/A	370107A	N/A	N/A
383-0101	40086	40088	370066A	N/A	N/A
383-0136	35066	35059	370001A	380001A	847
383-0139	39988	39977	370033A	N/A	N/A
383-0153	44922	44919	370124A	N/A	855
383-0156	45103	45102	370131A	380131A	857
383-0164	43764	43763	370048A	380048A	863
383-0166	28758	N/A	370150A	N/A	N/A
383-0171	36358	36357	370011A	N/A	N/A
383-0175	N/A	N/A	370199A	N/A	N/A
383-0176	N/A	N/A	370211A	N/A	N/A
393-0103	45099	45097	370022A	380022A	856
393-0104	42672	42671	370031A	380031A	852
393-0112	38780	38779	370023A	380023A	849
393-0115	38750	N/A	370024A	N/A	848
393-0134	48690	N/A	370195A	N/A	N/A
393-0148	52658	N/A	370069A	380069A	N/A
393-0173	47697	47695	370003A	380003A	861

VOYAGER[®] SEAL

Rugged Thick Wall Steel Construction Avoids Installation Damage

Hub Installed with "Piloted" Entry Features



Bonded Rubber OD & ID Seals Bore & Spindle with Easier Installation & Removal

Fully Utilized Design Provides Protection of Main Sealing Lip

4 - Zone Labyrinth "Active" Contaminant Exclusion System

Temperature Resistant Polymer with Hydrodynamic "Pumping" Features

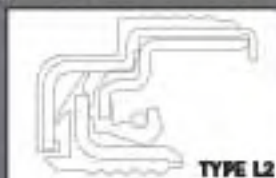

LASTING PROTECTION FOR DIRT EXCLUSION

GRITGUARD®



Dirt Exclusion for Extended Seal Performance

A two-piece design, the Grit Guard® Seal features a spindle-installed deflector ring. This provides dirt exclusion for extended seal performance and insures a new surface for the sealing lip. The deflector ring can often repair a damaged or worn spindle shoulder.

Superior Quality Metal Case Seal

The hub-installed metal case seal provides a metal-to-metal continuous press fit between the seal and hub. In addition, a blue bore sealant is applied to the seal to prevent minor seepage between the seal and hub.

Flexible and Durable Elasto-Leather Seal

Grit Guard's Elasto-Leather sealing lip remains flexible and durable even while operating in the most grueling environments. Also, the lip rotates on the deflector ring for improved heat dissipation and less lip travel per wheel rotation.

Weathering the Toughest Applications

Grit Guard® is available for the rugged, severe duty applications that other seals are not available for.



A Higher Standard of Performance.™
an EnPro Industries company

GRIT GUARD® Application Reference Guide



A Higher Standard of Performance.™

an EnPro Industries company

APPLICATION	GRIT GUARD® P/N	SEAL/RING	INNER BEARING	UNIVERSAL HEAD*/ HUB TOOL**	BEARING GUIDE
20,000# Trailer Axle, Meritor, Shuler	372-7095	2118/1510	665A	555-5069 / 551-5321	570-0024
22,500# Trailer Axle, Dana, Eaton, Meritor, Standard Forge	372-7097	2110/1504	HM218248	555-5039 / 551-5412	570-0026
19,000# Trailer Axle, Dana, Eaton, Meritor, Standard Forge	372-7098	2109/1507	663	555-5100 / 551-5313	570-0023
Pro-Par Trailer Axle, Dana, Eaton P-22, Fruehauf, Meritor TP	372-7099	2023/1503	HM518445	555-5023 / 551-5401	570-0025
19,000# Drive Axle, Eaton, Ford, GMC, Navistar, White	392-9088	2113/1517	594 or 594A	555-5076 / 551-5412	570-0028
50,000# & 60,000# Drive Axle, Mack	392-9089	2097/1516	687 or 780	555-5004 / 551-5400	N/A
34,000# Drive Axle, Mack	392-9094	2129/1511	580 or 582	555-5072 / 551-5393	570-0023
38,000#, 40,000#, 42,000# Tandem Drive Axles, Eaton, Ford, GMC, Mack, Navistar, White	392-9096	2114/1508	595 598	555-5072 / 551-5412 555-5071 / 551-5412	570-0023 570-0027
34,000# Drive Axle, Eaton, Ford, Navistar, White	392-9099	2102/1501	47685 or 47686 47678 or 5760	555-5031 / 551-5318 555-5074 / 551-5318	570-0023 570-0022
44,000# Drive Axle, Mack	392-9112	2213/1515	663 or HM516449, -C	555-5072 / 551-5364	570-0023
44,000# Drive Axle, Mack	392-9130	2213/1519	HM516449A	555-5073 / 551-5364	570-0023
38,000#, 46,000# Tandem Axles, Eaton, Ford, Freightliner, Kenworth, Meritor, Navistar, Peterbilt, Volvo, GM, Western Star	392-9131	2106/1525	594 or 594A 598 or 598A	555-5076 / 551-5320 555-5071 / 551-5320	570-0028 570-0027
38,000# Drive Axle, Eaton, GMC, Mack, Meritor	392-9132	2104/1018	495AX 33287	555-5074 / 551-5383 555-5011 / 551-5383	N/A N/A

*Use Universal Body 555-0001 with 555 Series Tool Heads.

**Use Universal Fleet Tool Handle 551-0001 with 551 Series Tool Heads.

GRIT GUARD®

Designed to reduce maintenance and prevent unnecessary wear on expensive spindles, the Grit Guard® two-piece design provides effective and lasting protection against contamination.

Spindle installed deflector ring

Grit Guard® dust shield for improved dirt exclusion

Hub installed metal case seal

Blue bore sealant

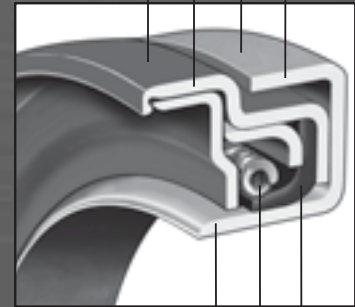

Deflector ring provides heat sink into spindle

Spring

Elasto-Leather sealing element

GRIT GUARD® Interchange

GRIT GUARD®	SKF	SKF PLUS	NATIONAL	OUTRUNNER	TRI SEAL
372-7095	43753	43752	370037A	853	69599
372-7097	46305	46304	370025A (38)	859	69598
372-7098	40136	40133	370036A (38)	850	69597
372-7099	42623	42622	370065A (38)	851	69596
392-9088	45160	45158	370021A	307	69791
392-9089	52664	52658	370069A (38)	N/A	69781
392-9094	45099	45097	370022A (38)	856	70796
392-9096	43860	43861	370019A	854	69797
392-9099	38780	38779	370023A (38)	849	69794
392-9112	42672	42671	370031A (38)	852	69788
392-9130	42672	42671	370031A (38)	852	69788
392-9131	47697	47695	370003A (38)	861	69799
392-9132	47690	N/A	370005A	308	69757



APPLICATION	GUARDIAN® GUARDIAN® HP	VOYAGER®	DISCOVER®	GRIT GUARD® STANDARD	GG/STANDARD COMPONENTS SEAL/RING	INNER BEARING	UNIVERSAL AXLE TOOL HEADS	UNIVERSAL HUB TOOL HEADS	BEARING GUIDE
19,000# Trailer Axle Standard Forge, Dana, Meritor, Eaton	307-0713	373-0113	373-0213	372-7098	2109/1507	663	555-5100	551-5313	570-0023
Pro-Par Trailer Axle Fruehauf, Eaton P-22, Meritor TP, Dana	307-0723	373-0123	373-0223	372-7099	2023/1503	HM518445	555-5023	551-5401	570-0025
22,500# Trailer Axle Meritor, Standard Forge, Dana, Eaton	307-0743	373-0143	373-0243	372-7097	2110/1504	HM218248	555-5039	551-5412	570-0026
20,000# Trailer Axle, Meritor, Shuler	307-0744	373-0144	N/A	372-7095	2118/1510	665A	555-5069	551-5321	570-0024
12,000# Meritor Front Transit	N/A	383-0101	N/A	382-8001	2086/1013	6386 or 6389 6379	555-5060 555-5014	551-5420	570-0020
Meritor Center Point	N/A	N/A	N/A	382-8028	2028/1028	756A	555-5067	551-5385	N/A
GMC F-120 to 1985	N/A	N/A	N/A	382-8034	2034/1034	HM212047	555-5066	551-5387	570-0019
12,000# Front Axle Meritor, Eaton, Ford, Freightliner, Kenworth, Western Star, Navistar, Peterbilt, Volvo GM	308-0836	383-0136	383-0236	382-8036	2036/1036	39581 HM212044 HM212049, -X, X1 HM212047	555-5062 555-5061 555-5098 555-5066	551-5346 551-5346 551-5346 551-5346	570-0017 570-0018 570-0020 570-0019
12,000# Mack Front Axle Navistar Front Axle, FA 309, FA 329	N/A 308-0853	383-0139 383-0153	383-0239 N/A	382-8039 382-8053	2039/1038 2181/1093	641 or HM212049 641 or HM212049 H715345	NONE REQ'D 555-5060 555-5070	551-5413 551-5419 551-5419	570-0020 570-0020 570-0021
9,000# Front Axle, Navistar, FA 109 Cast Wheel '79 and up	308-0855	383-0156	N/A	382-8056	----	641	555-5060	551-5344	570-0020
12,000# Front Axle, Navistar	308-0856	383-0156	N/A	382-8056	2199/1093	H715345	555-5070	551-5344	570-0021
7,000#, 9,000# Front Axle, Ford	308-0863	N/A	N/A	382-8063	2133/1036	39581 45284	555-5062 555-5064	551-5353 551-5353	570-0017 N/A
16,000# Front Axle, Ford, Navistar, Mack, Meritor, White, Kenworth, Western Star, Peterbilt, Volvo GM	308-0864	383-0164	383-0264	382-8064	2137/1037	6461A	555-5007	551-5327	570-0022
6,000#, 7,500# Front Axle, Navistar	308-0866	383-0166	N/A	382-8066	2164/1008	JM207049 JM205149	555-5088 555-5089	551-5423 551-5423	570-0036 570-0033
Volvo FA 7.5 Front Axle	308-0870	N/A	N/A	N/A	N/A	JF7049A	555-5297	N/A	N/A
GMC F-120 1985 and up	N/A	383-0171	N/A	382-8071	2216/1034	HM212047	555-5066	551-5403	570-0019
8,000# Front Axle, GMC Topkick	N/A	383-0175	N/A	N/A	N/A	JM205149	NONE REQ'D	551-5417	570-0033
11,000# Front Axle, GMC Topkick	N/A	383-0176	N/A	N/A	N/A	33212	NONE REQ'D	551-5418	570-0031
34,000#, 38,000# Drive Axle, Mack	309-0903	393-0103	393-0203	392-9094	2129/1511	580 or 582	555-5072	551-5415	570-0023
44,000# Drive Axle, Mack	309-0904	393-0104	393-0204	392-9112 392-9130	2213/1515 2213/1519	663 or HM516449, -C HM516449A	555-5072 555-5073	551-5414 551-5414	570-0023 570-0023
34,000# Drive Axle Eaton, Ford, Navistar, White	309-0912	393-0112	393-0212	392-9099	2102/1501	47685 or 47686 47678 or 5760	555-5031 555-5074	551-5416 551-5416	570-0023 570-0022
17,000# Single and 34,000# Tandem, GMC	309-0915	393-0115	N/A	Refer to above 392-9099 set	----	47686	555-5031	551-5424	570-0023
Meritor Drive Transit	N/A	393-0134	N/A	392-9034	2061/1066	6580 6559	555-5023 555-5072	551-5421	570-0025 570-0023
15,000# Drive Axle, Ford, Meritor F-Series	309-0935	N/A	N/A	392-9035	2057/1062	33287	555-5011	551-5353	N/A
Mack Drive Axle 50,000# and 60,000#	309-0948	393-0148	N/A	392-9089	2097/1516	687 or 780	555-5004	551-5400	570-0032
GMC H/T 150 and H/T 175 Ford, Meritor H 170, 172, 175	309-0957	N/A	N/A	392-9057	2104/1018	495AX 33287	555-5074 555-5011	551-5383 551-5383	N/A N/A
38,000# Drive Axle Mack, GMC, Eaton, Meritor	309-0960	N/A	N/A	392-9132	2115/1530	598A 594A	555-5071 555-5076	551-5356 551-5356	570-0027 570-0028
34,000# Drive Axle, Meritor	309-0961	N/A	N/A	392-9095	2117/1509	580, 582 or 663A	555-5072	551-5325	N/A
19,000# Drive Axle Eaton, Navistar, Ford, GMC, White	309-0964	N/A	N/A	392-9088	2113/1517	594 or 594A	555-5076	551-5412	570-0028
Van Hool Bus	391-9066	N/A	N/A	392-9066	2115/1107	594A	555-5076	551-5356	570-0028
38,000#, 40,000# and 42,000# Tandem Drive Axles, Ford, Eaton, GMC, Mack, Navistar, White	309-0965	N/A	N/A	392-9092 392-9096	2131/1508 2114/1508	598 595	555-5071 555-5072	551-5363 551-5412	570-0027 570-0023
38,000# Drive Axle, Eaton, Meritor, White	309-0970	N/A	N/A	392-9087	2162/1502	683XA or 683 681A	555-5076 555-5071	551-5333 551-5333	570-0028 570-0027
38,000#, 46,000# Tandem Axles, Eaton, Ford, Freightliner, Kenworth, Western Star, Peterbilt, Meritor, Navistar, Volvo GM	309-0973	393-0173	393-0273	392-9131	2106/1525	594 or 594A 598 or 598A	555-5076 555-5071	551-5320 551-5320	570-0028 570-0027

Footnotes

- SS4 Seal.
- Use 555 Series Tool Heads with Universal Tool Body 555-0001. The Axle Tool Heads Install the Standard/Grit Guard® Rings & Guardian®/SS4 Seals.
- Use 551 Series Tool Heads with new Universal Tool Handle 551-0001. The Hub Tool Installs the Standard Seal, Voyager® and Discover® Seals.
- Use with 5.687" Bore Only.
- Use with 5.500" Bore Only.
- Does not fit Mack Applications.
- Fits Mack Application Only.
- Use with Wabco ABS.
- HP Design.
- Use 551-5395 for 320-2039 seal.
- Use 551-5393 for 320-2129 seal.
- Use 551-5364 for 320-2213 seal.
- 383-8139 includes 310-1132 shoulder bushing.
- 383-8239 includes 310-1132 shoulder bushing.
- Use 551-5349 for 320-2181 seal.
- Use 551-5318 for 320-2102 seal.
- Use 551-5356 for 320-2061 seal.
- Use 551-5366 for 320-2164 seal.
- Use 551-5311 for 2086 seal.
- Does not fit 5760 Inner Bearing.
- Does not fit 6379 Inner Bearing.
- White shaded numbers indicate obsolete parts.



A Higher Standard of Performance.™

an EnPro Industries company

SKF to STEMCO

National to STEMCO

SKF	GUARDIAN® HP HUB-SEAL	GRIT GUARD® / STD. WHEEL SET	VOYAGER®	DISCOVER®	NATIONAL	GUARDIAN® HP HUB-SEAL	GRIT GUARD® / STD. WHEEL SET	VOYAGER®	DISCOVER®
28758	308-0866	382-8066	383-0166		370001A (380001A)	308-0836	382-8036	383-0136	383-0236
29480			383-0176		370003A (380003A)	309-0973	392-9131	393-0173	393-0273
35058	308-0836	382-8036	383-0136	383-0236	370011A		382-8071	383-0171	
35059	308-0836	382-8036	383-0136	383-0236	370022A (380022A)	309-0903	392-9094	393-0103	393-0203
35066	308-0836	382-8036	383-0136	383-0236	370023A (380023A)	309-0912	392-9099	393-0112	393-0212
35102	308-0836	382-8036	383-0136	383-0236	370024A	309-0915	392-9099	393-0115	
36357		382-8071	383-0171		370025A (380025A)	307-0743	372-7097	373-0143	373-0243
36358		382-8071	383-0171		370031A (380031A)	309-0904	392-9112	393-0104	393-0204
36365		382-8071	383-0171		370033A/AR12		382-8039	383-0139	383-0239
38748	309-0915	392-9099	393-0115		370034A	309-0973	392-9131	393-0173	393-0273
38750	309-0915	392-9099	393-0115		370036A (380036A) II	307-0713	372-7098	373-0113	373-0213
38776	309-0912	392-9099	393-0112	393-0212	370037A	307-0744	372-7095	373-0144	
38779	309-0912	392-9099	393-0112	393-0212	370048A (380048A)	308-0864	382-8064	383-0164	383-0264
38780	309-0912	392-9099	393-0112	393-0212	370065A (380065A)	307-0723	372-7099	373-0123	373-0223
38783	309-0912	392-9099	393-0112	393-0212	370066A		382-8001	383-0101	
39977/455031		382-8039	383-0139	383-0239	370069A	309-0948	392-9089	393-0148	
39979		382-8039	393-0139	393-0239	370086A	309-0973	392-9131	393-0173	393-0273
39990		382-8039	383-0139	383-0239	370107A		372-7091	373-0191	
39988/455031		382-8039	383-0139	383-0239	370124A	308-0853	382-8053	383-0153	
40086		382-8001	383-0101		370131A (380131A)	308-0856 II	382-8056	383-0156 II	
40088		382-8001	383-0101		370150A	308-0866	382-8066	383-0166	
40091		382-8001	383-0101		370182A	308-0864	382-8064	383-0164	383-0264
40129	307-0713	372-7098	373-0113	373-0213	370195A		392-9034	393-0134	
40133	307-0713	372-7098	373-0113	373-0213	370198A/AR25		382-8039	383-0139	383-0239
40136	307-0713	372-7098	373-0113	373-0213	370199A		N/A	383-0175	
40146	307-0713	372-7098	373-0113	323-0213	370211A		N/A	383-0176	
42622	307-0723	372-7099	373-0123	373-0223	370349A II	307-0713	372-7098	373-0113	373-0213
42623	307-0723	372-7099	373-0123	373-0223	376590A	307-0723	372-7099	373-0123	373-0223
42624		372-7091	373-0191						
42627	307-0723	372-7099	373-0123	373-0223					
42631	307-0723	372-7099	373-0123	373-0223					
42671	309-0904	392-9112	393-0104	393-0204					
42672	309-0904	392-9112	393-0104	393-0204					
42673	309-0904	392-9112	393-0104	393-0204					
43752	307-0744	372-7095	373-0144		301	307-0713	372-7098	373-0113	373-0213
43753	307-0744	372-7095	373-0144		302	307-0723	372-7099	373-0123	373-0223
43754	307-0744	372-7095	373-0144		303	307-0743	372-7097	373-0143	373-0243
43761	308-0864	382-8064	383-0164	383-0264	30323	N/A	392-9018	N/A	
43763	308-0864	382-8064	383-0164	383-0264	304	309-0973	392-9131	393-0173	393-0273
43764	308-0864	382-8064	383-0164	383-0264	305	308-0836	382-8036	383-0136	383-0236
43875	309-0973 I	392-9131 I	393-0173	393-0273	306	309-0912 / 309-0915	392-9099	393-0112	393-0212
44916	308-0853	382-8053	383-0153		307	309-0964	392-9088	N/A	
44919	308-0853	382-8053	383-0153		308	309-0960	392-9132	N/A	
44922	308-0853	382-8053	383-0153		847	308-0836	382-8036	383-0136	383-0236
45097	309-0903	392-9094	393-0103	393-0203	848	309-0912 / 309-0915	392-9099	393-0115	
45093	309-0903	392-9094	393-0103	393-0203	849	309-0912 / 309-0915	392-9099	393-0112	393-0212
45099	309-0903	392-9094	393-0103	393-0203	850	307-0713	372-7098	373-0113	373-0213
45102	308-0856 II	382-8056	383-0156 II		851	307-0723	372-7099	373-0123	373-0223
45103	308-0856 II	382-8056	383-0156		852	309-0904	392-9112 II	393-0104	393-0204
45108	309-0903	392-9094	393-0103	393-0203	853	307-0744	372-7095	373-0144	
45152 II	309-0973	392-9131	393-0173	393-0273	854	309-0965	392-9092	N/A	
46300	307-0743	372-7097	373-0143	373-0243	855	308-0853	382-8053	383-0153	
46304	307-0743	372-7097	373-0143	373-0243	856	309-0903	392-9094	393-0103	393-0203
46305	307-0743	372-7097	373-0143	373-0243	857	308-0856	382-8056	383-0156	
46308	307-0743	372-7097	373-0143	373-0243	858	309-0964	392-9088	N/A	
47691	309-0973	392-9098	393-0173	393-0273	859	307-0743	372-7097	373-0143	373-0243
47692	309-0973	392-9098	393-0173	393-0273	860	309-0960	392-9132	N/A	
47693	309-0973	392-9131	393-0173	393-0273	861	309-0973	392-9131	393-0173	393-0273
47695	309-0973	392-9131	393-0173	393-0273	863	308-0864	382-8064	383-0164	383-0264
47697	309-0973	392-9131	393-0173	393-0273	88319	309-0973	393-0173	393-0173	393-0273
48690		392-9034	393-0134		UZ0301E0	307-0713	392-7098	373-0113	373-0213
48691		392-9034	393-0134		UZ0302E0	307-0723	372-7099	373-0123	373-0223
52658	309-0948	392-9089	393-0148		UZ0303E0	307-0743	372-7097	373-0143	373-0243
52664	309-0948	392-9089	393-0148		UZ0304E0	309-0973	392-9131	393-0173	393-0273
					UZ0305E0	308-0836	382-8036	383-0136	383-0236
					UZ0306E0	309-0912	392-9099	393-0112	393-0212

Outrunner to STEMCO

OUTRUNNER	GUARDIAN® HP HUB-SEAL	GRIT GUARD® / STD. WHEEL SET	VOYAGER®	DISCOVER®
301	307-0713	372-7098	373-0113	373-0213
302	307-0723	372-7099	373-0123	373-0223
303	307-0743	372-7097	373-0143	373-0243
30323	N/A	392-9018	N/A	
304	309-0973	392-9131	393-0173	393-0273
305	308-0836	382-8036	383-0136	383-0236
306	309-0912 / 309-0915	392-9099	393-0112	393-0212
307	309-0964	392-9088	N/A	
308	309-0960	392-9132	N/A	
847	308-0836	382-8036	383-0136	383-0236
848	309-0912 / 309-0915	392-9099	393-0115	
849	309-0912 / 309-0915	392-9099	393-0112	393-0212
850	307-0713	372-7098	373-0113	373-0213
851	307-0723	372-7099	373-0123	373-0223
852	309-0904	392-9112 II	393-0104	393-0204
853	307-0744	372-7095	373-0144	
854	309-0965	392-9092	N/A	
855	308-0853	382-8053	383-0153	
856	309-0903	392-9094	393-0103	393-0203
857	308-0856	382-8056	383-0156	
858	309-0964	392-9088	N/A	
859	307-0743	372-7097	373-0143	373-0243
860	309-0960	392-9132	N/A	
861	309-0973	392-9131	393-0173	393-0273
863	308-0864	382-8064	383-0164	383-0264
88319	309-0973	393-0173	393-0173	393-0273
UZ0301E0	307-0713	392-7098	373-0113	373-0213
UZ0302E0	307-0723	372-7099	373-0123	373-0223
UZ0303E0	307-0743	372-7097	373-0143	373-0243
UZ0304E0	309-0973	392-9131	393-0173	393-0273
UZ0305E0	308-0836	382-8036	383-0136	383-0236
UZ0306E0	309-0912	392-9099	393-0112	393-0212

Footnotes

- I Drive Application. II Trailer Application. III Front Application. IV With 364-6402. V For IHC FA-109 1979 and up with spoke wheel, use 308-0855 Guardian Set.
- VI With 364-6435. VII Ring no longer available. VIII White shaded numbers indicate obsolete parts.

Guardian®/Guardian® HP to Standard/Grit Guard® and Voyager®/Discover® Hub Seal Cross Reference

Guardian® / Guardian-HP Seal No.	Inner Bearing Cone	Universal Tool Head	Standard/ Grit Guard® Set	Voyager® Discover®	Guardian®/ Guardian-HP Seal No.	Inner Bearing Cone	Universal Tool Head	Standard/ Grit Guard® Set	Voyager® Discover®
*307-0713	663	555-5100	372-7098	373-0113 373-0213	309-0912	47685 47686	555-5031	392-9099	393-0112 393-0212
*307-0723	HM518445	555-5023	372-7099	373-0123 373-0223		47678 5760	555-5074		
*307-0743	HM218248	555-5039	372-7097	373-0143 373-0243	309-0915	47685 47686	555-5031	392-9099	N/A
307-0744	665A	555-5069	372-7095	N/A	309-0935	33281 Thru 61 33287 62 Up	555-5002	392-9035	N/A
*308-0836	39581	555-5062	382-8036	383-0136 383-0236			555-5011		
308-0853	HM212044, 557A	555-5061	382-8053	383-0153	309-0948	687 780	555-5004	392-9089	393-0148
	HM212049, -X	555-5098			309-0957	495AX	555-5074	392-9057	N/A
	HM212047	555-5066				33287	555-5011	392-9132	N/A
308-0855	641	555-5060	N/A	N/A	309-0960	594A	555-5076	392-9132	N/A
308-0856	H715345	555-5070	382-8056	383-0156		598A	555-5071	392-9095	N/A
308-0863	39581	555-5062	382-8063	N/A	309-0961	580 582 663A	555-5072	392-9095	N/A
*308-0864	45284	555-5064	382-8064	383-0164 383-0264		309-0964	594 594A	555-5076	392-9088
	6461A	555-5007		383-0166	309-0965	595 598	555-5072 555-5071	392-9096	N/A
308-0866	JM207049 JM205149	555-5088 555-5089	382-8066	383-0166	309-0970	683XA 683	555-5076	392-9087	N/A
308-0870	JF7049A	555-5297	N/A	N/A		681A	555-5071	392-9131	393-0173 393-0273
*309-0903	580 582	555-5072	392-9094	393-0103 393-0203	*309-0973	594 594A	555-5076		
*309-0904	663	555-5072	392-9112	393-0104 393-0204	598 598A	555-5071			
	HM516449,-C								

*Guardian® HP

Use Universal Tool Body 555-0001 with 555 Series Tool Heads.

Guardian® /Guardian® HP Hub Seal Components

Oil Seal □	Deflector Ring □	Guardian®/ Guardian® HP Seal	Oil Seal □	Deflector Ring □	Guardian®/ Guardian® HP Seal
327-2701	317-1743	*307-0743	327-2713	317-1713	309-0965
327-2702	317-1702	*308-0836	327-2715	317-1756	309-0915
327-2703	317-1703	*309-0973	327-2716	317-1761	309-0970
327-2704	317-1704	*307-0713	327-2717	317-1761	309-0960
327-2705	317-1705	*307-0723	327-2718	317-1720	*309-0904
327-2706	317-1706	*309-0903	327-2719	317-1719	309-0961
327-2707	317-1707	309-0912	327-2721	317-1721	308-0863
327-2708	317-1708	308-0853	327-2724	317-1724	309-0957
327-2709	317-1709	307-0744	327-2727	317-1726	308-0866
327-2710	317-1710	308-0855	327-2728	317-1728	309-0935
	317-1706	308-0856	327-2741	317-1790	309-0948
327-2711	317-1711	*308-0864	327-2757	317-1724	308-0870
327-2712	317-1712	309-0964			

□ 327-Series Oil Seals and 317-Series Deflector Rings are component parts for the Guardian® Hub Seal.

These parts are not sold separately.

*Guardian® HP

Shaded numbers indicate obsolete parts.

Standard and Grit Guard® Hub Seal to Set Cross Reference

QUICK REFERENCE

Oil Seal	Axle Ring	Hub Seal Set	Inner Bearing #	Universal Tool Head	Hub Tool	Comment
320-2001	310-1095	392-9001	758	555-5069	551-5398	
			760	555-5079	551-5398	
	310-1103	392-9062	760	555-5079	551-5398	
	For trailer applications, use 310-1045 (set was 370-7019).					
320-2009	310-1028	392-9019	598	555-5071	551-5356	
	310-1079	392-9081	598A	555-5071	551-5356	
320-2012	310-1012	392-9012	47678	555-5074	551-5405	
			47686	555-5031	551-5405	See Set Remarks
			5760	555-5074	551-5405	
320-2017	310-1017	382-8017	39581	555-5062	551-5352	❑
320-2018	310-1008	372-7046	28995	555-5052	551-5351	
	310-1008	382-8018	45284	555-5064	551-5351	
320-2022	310-1050	382-8010	4595 or 39578	None	551-5381	
320-2023	310-1022	372-7022	593	None	551-5401	I Beam Axle Model 5
	310-1023	372-7023	593 & HM518445	555-5023	551-5401	Pro-Par
	310-1041	382-8060	5760 or 6461	None	551-5401	
	310-1130	372-7062	592A or 593	555-5023	551-5401	Modified No. 5 ❑
	315-1503	372-7099	HM518445	555-5023	551-5401	Grit Guard® for Pro-Par only
320-2028	310-1028	382-8028	756A	555-5067	551-5385	
320-2029	310-1018	372-7018	495AX	555-5074	551-5386	
	310-1018	392-9018	495AX	555-5074	551-5386	Ford thru 1969-70 Up use 392-9057 ❑
320-2031	310-1036	382-8025	557A OR HM212044	555-5061	551-5388	
	310-1051	382-8011	559 or 3982	None	551-5388	
320-2032	310-1032	382-8032	HM212049	None	551-5388	
	310-1036	372-7009	39250	555-5066	551-5388	
320-2034	310-1034	382-8034	HM212047	555-5066	551-5387	❑
320-2036	310-1036	382-8036	39581	555-5062	551-5346	
			557A or HM212044	555-5061	551-5346	
			HM212047	555-5066	551-5346	
			HM212049	555-5098	551-5346	
			HM212049X	555-5098	551-5346	
320-2039	310-1038	382-8039	641 or HM212049	None	551-5395 551-5413 ❑	Replaced by Voyager® Seal 383-8139 ❑
320-2041	310-1028	382-8045	756A	555-5067	551-5398	
	310-1043	372-7015	759	555-5023	551-5398	C&M K-30 Std. Forge TA-26, A-26-S
320-2046	310-1036	372-7006	567	555-5011	551-5388	
320-2050	310-1052	382-8009	45284 or 45285	555-5036	551-5347	❑
320-2051	310-1047	372-7008	560S	555-5038	551-5388	
320-2056	310-1061	382-8005	3778	555-5001	551-5302	❑
320-2057	310-1062	392-9035	33287	555-5011	551-5353	❑
	310-1063	392-9036	33281	555-5002	551-5353	❑
320-2058	310-1093	392-9033 or 6559	663, 749A	555-5072	551-5303 Separately	Gaskets Must be Ordered Separately
320-2059	See Catalog 392-9053 and/or 392-9089 Remarks.					

❑ Oil seal installs in bearing cup bore. ❑ Oil seal installs in bearing cup bore on steel hubs. On spoke wheels use seal bore. ❑ Voyager® Seal tool.

Shaded numbers indicate obsolete part numbers.

Standard and Grit Guard® Hub Seal to Set Cross Reference

Oil Seal	Axle Ring	Hub Seal Set	Inner Bearing #	Universal Tool Head	Hub Tool	Comment
320-2061	310-1066	392-9034	6580	555-5023	551-5356	Gasket sold Separately
			6559	555-5072	551-5356	
320-2072	310-1064	372-7048	3984	555-5097	551-5308	
	310-1064	392-9038	3984	555-5097	551-5308	❑
320-2077	310-1104	392-9063	188931	555-5054	551-5362	
			387AS or 7451929	555-5062	551-5362	
320-2086	310-1013	382-8001	6386 or 6389	555-5060	551-5311	
			6379	555-5014	551-5311	
320-2091	SEE COMMENTS W/392-9045 SET	392-9045	33287	555-5011	551-5312	
			33281	555-5002	551-5312	
			495AX	555-5074	551-5312	
			47686	555-5031	551-5312	
320-2096	310-1007	392-9007	663 or HM516449	555-5072	551-5390	Cast housings use 392-9004
320-2097	315-1516	392-9089	687 or 780	555-5004	551-5400	Grit Guard®
320-2099	310-1089	392-9053	782	555-5016	551-5317	See Set Remarks
320-2102	315-1501	392-9099	47685 or 47686	555-5031	551-5318	Grit Guard® ❑
			47678	555-5074	551-5318	
320-2104	310-1018	392-9057	495AX	555-5074	551-5383	Ford 1970 Up Thru 1969 use 392-9018
320-2105	310-1008	382-8044	45284	555-5064	551-5351	
320-2106	315-1525	392-9131	598 or 598A	555-5071	551-5320	Grit Guard® Used with or without Wabco ABS
			594 or 594A	555-5076	551-5320	
320-2109	310-1053	392-9032	580	555-5072	551-5313	
	310-1057	372-7003	575	555-5074	551-5313	
	315-1507	372-7098	663	555-5031	551-5313	KB-5, KB-6 T-18-W only
320-2110	315-1504	372-7097	663	555-5100	551-5313	Grit Guard®
320-2111	315-1506	372-7096	HM218248	555-5039	551-5412	Grit Guard®
320-2113	315-1517	392-9088	787	555-5016	551-5323	Grit Guard®
320-2114	315-1508	392-9096	594 or 594A	555-5076	551-5412	Grit Guard® ❑
			595	555-5072	551-5412	
320-2115	310-1113	392-9020	598	555-5071	551-5412	
	310-1107	392-9066	665	555-5068	551-5356	❑
	315-1530	392-9132	592A/594A	555-5076	551-5356	Van Hool Bus Appl ❑
			592A/598A	555-5071	551-5356	Used with or without Wabco ABS
320-2117	315-1509	392-9095	582 or 663A	555-5072	551-5325	Grit Guard®
320-2118	315-1510	372-7095	665A	555-5069	551-5321	Grit Guard®
320-2119	310-1036	382-8027	39581	555-5062	551-5353	
320-2125	310-1051	382-8062	39585	None	551-5388	❑
320-2129	315-1511	392-9094	580 or 582	555-5072	551-5393	Grit Guard®
320-2131	315-1508	392-9092	598	555-5071	551-5363	Grit Guard®

❑ Oil seal installs in bearing cup bore.

(Continued Next Page)

Shaded numbers indicate obsolete part numbers.

Standard and Grit Guard® Hub Seal to Set Cross Reference

QUICK REFERENCE

Oil Seal	Axle Ring	Hub Seal Set	Inner Bearing #	Universal Tool Head	Hub Tool	Comment
320-2133	310-1036	382-8063	39581	555-5062	551-5353	
			45284	555-5064	551-5353	
320-2136	310-1064	372-7049	JM511946	555-5055	551-5381	
320-2137	310-1037	382-8064	6461A	555-5007	551-5327	Replaced by 383-0164
320-2162	315-1502	392-9087	681A	555-5071	551-5333	See Set Remarks
			683	555-5076	551-5333	Grit Guard®
320-2164	310-1008	382-8066	JM207049	555-5088	551-5366	
			JM205149	555-5089	551-5366	
320-2166	310-1028	382-8069	6386	None	551-5340	Volvo Front
320-2173	310-1023	372-7024	749 or 749S	555-5024	551-5401	
	315-1503	372-7091	749 or 749S	555-5024	551-5401	Grit Guard®
320-2181	310-1009	382-8052	6386A	555-5060	551-5349	
	310-1093	382-8053	641 or HM212049	555-5060	551-5349	
320-2199	310-1093	382-8056	H715345	555-5070	551-5349	
			641	555-5060	551-5344	
320-2213	315-1515	392-9112	663 or HM516449,-C	555-5072	551-5364	Grit Guard®
	315-1519	392-9130	HM516449A	555-5073	551-5364	Grit Guard®
320-2216	310-1034	382-8071	HM212011/ HM212047	555-5066	551-5403	
320-2233	310-1233	392-9111	593X/594	555-5076	551-5404	Mack Midliner

Shaded numbers indicate obsolete part numbers.

CLEANLINESS MADE EASY



Part Number
102-5001

Simple Design

Spill-proof design locks in place - no need to hold while the axle drains. Flat bottom design eliminates spills and will not tip while on the floor. Built-in handles makes the drain pan easy to remove and carry. The large 256 ounce (2 gallons) capacity consolidates multiple disposal trips.

Versatile Fit

Works on both 24.5 and 22.5* wheel ends (for 22.5 wheel ends, trim pan along groove for proper fit).

Simple Disposal

Two built-in drip proof pour spouts for easy waste disposal.

Quality Made

Considered a "GREEN" product - the Dually Drain Pan is manufactured in the U.S.A. from recycled plastic and its use helps keep the environment clean and clear of contaminants.



A Higher Standard of Performance.™
an EnPro Industries company



PERFORMANCE AND VALUE LEADER



**HEAVY DUTY
BEARINGS**

Value Added Bearing Program

Through strategic alliances and strong global procurement, STEMCO Bearings meet the changing needs of today's market. STEMCO Bearings are the right mix of Performance, Convenience and Value.

Consolidated Wheel End Components Provider

The same company that provides High Performance STEMCO Wheel Seals, Pro-Torq Precision Adjusting Nuts and Hub Caps, can supply your wheel bearing needs; providing safety, reliability and performance from a single source.

STEMCO Quality Bearings

Our worldwide network of manufacturing plants is held to the highest quality standards by STEMCO and meets the ABMA specifications for bearing life calculations.

Expanded Bearing Coverage

The STEMCO product offering includes Tapered Roller Bearings, Radial Ball Bearings, Clutch Release Bearings, Individual Cups and Cones, and STEMCO Matched Bearing Sets.

Long Life Warranty

STEMCO offers a 3 or 5 year limited warranty when used in conjunction with the STEMCO Platinum Performance System or Platinum Performance System Plus.

BEARINGS

STEMCO Quality Bearing Reference Guide



HEAVY DUTY TAPERED ROLLER BEARINGS

P/N	DESCRIPTION
382A	Tapered Roller Cup, Truck
387AS	Tapered Roller Cone, Truck
493	Tapered Roller Cup, Truck
552A	Tapered Roller Cup, Front Axle
555S	Tapered Roller Cone, Front Axle
557S	Tapered Roller Cone, Front Axle
563	Tapered Roller Cup, Front Axle
567	Tapered Roller Cone, Front Axle
572	Tapered Roller Cup, Truck Axle
580	Tapered Roller Cone, Truck Axle
582	Tapered Roller Cone, Truck Axle
592A	Tapered Roller Cup, Truck/Trailer
594	Tapered Roller Cone, Front Axle
594A	Tapered Roller Cone, Front Axle
598A	Tapered Roller Cone, Front Axle
653	Tapered Roller Cup, Trailer/Truck Axle
663	Tapered Roller Cone, Trailer/Truck Axle
665A	Tapered Roller Cone, Trailer/Truck Axle
742	Tapered Roller Cup, Truck Axle
749	Tapered Roller Cone, Truck Axle
3720	Tapered Roller Cup, Front Axle
3782	Tapered Roller Cone, Front Axle
3920	Tapered Roller Cup, Truck Axle
6420	Tapered Roller Cup, Front Axle
6461A	Tapered Roller Cone, Front Axle
6535	Tapered Roller Cup, Truck Axle
6580	Tapered Roller Cone, Truck Axle
15245	Tapered Roller Cup, Truck Axle
15250	Tapered Roller Cup, Truck Axle
25520	Tapered Roller Cup, Truck Axle
25580	Tapered Roller Cone, Truck Axle
25820	Tapered Roller Cup, Truck Axle
25877	Tapered Roller Cone, Truck Axle
28682	Tapered Roller Cone, Truck Axle
39520	Tapered Roller Cup, Truck Axle
39585	Tapered Roller Cone, Truck Axle
39590	Tapered Roller Cone, Truck Axle
45220	Tapered Roller Cup, Front Axle
45280	Tapered Roller Cone, Front Axle
47620	Tapered Roller Cup, Rear Axle
47679	Tapered Roller Cone, Rear Axle
47686	Tapered Roller Cone, Rear Axle
H715311	Tapered Roller Cup, Truck Axle
H715345	Tapered Roller Cone, Truck Axle
HM212011	Tapered Roller Cup, Trailer/Front Axle
HM212047	Tapered Roller Cone, Front Axle
HM212049	Tapered Roller Cone, Trailer/Front Axle
HM218210	Tapered Roller Cup, Trailer Axle
HM218248	Tapered Roller Cone, Trailer Axle
HM516410	Tapered Roller Cup, Rear Axle
HM516449	Tapered Roller Cone, Rear Axle
HM518410	Tapered Roller Cup, Trailer Axle
HM518445	Tapered Roller Cone, Trailer Axle
JM207010	Tapered Roller Cup, Truck Axle
JM207049A	Tapered Roller Cone, Truck Axle
LM102949	Tapered Roller Cone, Front Axle

MATCHED BEARING SETS

P/N	COMPONENTS
SET047-011	HM212047 / HM212011
SET049-011	HM212049 / HM212011
SET248-210	HM218248 / HM218210
SET445-410	HM518445 / HM518410
SET449-410	HM516449 / HM516410
SET580-72	580 / 572
SET582-72	582 / 572
SET594A-92A	594A / 592A
SET598A-92A	598A / 592A
SET663-53	663 / 653
SET3782-20	3782 / 3720
SET28682-22	28682 / 28622
SET39590-20	39590 / 39520
SET45280-20	45280 / 45220
SET45284-20	45284 / 45220
SET47679-20	47679 / 47620
SET47686-20	47686 / 47620

STEMCO MATCHED BEARING SETS

P/N	COMPONENTS
ASET047-011	KHM212047 / KHM212011
ASET049-011	KHM212049 / KHM212011
ASET248-210	KHM218248 / KHM218210
ASET445-410	KHM518445 / HKM518410
ASET449A-410	KHM516449A / KHM516410
ASET555S-52A	K555S / K552A
ASET567-563	K567 / K563
ASET580-72	K580 / K572
ASET582-572	K582 / K572
ASET594A-92A	K594A / K592A
ASET598A-92A	K598A / K592A
ASET663-53	K663 / K653
ASET687-672	K687 / K672
ASET3782-20	K3782 / K3720
ASET6461A-20	K6461A / K6420
ASET45280-20	K45280 / K45220
ASET47679-20	K47679 / K47620

BALL/CLUTH RELEASE/TAPERED BEARING SETS

P/N	DESCRIPTION
F-01757-C	N1707
02135	N2135
02256A	N2256-N
A16	LM12749 / LM12711
A34	LM12748 / LM12710
A38	LM104949 / LM104911
105-SS1	Ball Bearing, 2 Shields
205-FF	Ball Bearing, 2 Seals
205-SS	Ball Bearing, 2 Shields
206-FF	Ball Bearing, 2 Seals
206-SS	Ball Bearing, 2 Shields
305-FF	Ball Bearing, 2 Seals
305-SS	Ball Bearing, 2 Shields
306-FF	Ball Bearing, 2 Seals
306-SS	Ball Bearing, 2 Shields

BALL/CLUTH RELEASE/TAPERED BEARING SETS

P/N	DESCRIPTION
306-SSL	Ball Bearing, 2 Shields, Snap Ring
308-L	Ball Bearing, Snap Ring
1308-L	Ball Bearing, Snap Ring

* Multiply last 2 numbers by 5 to get Bore Size.

STEMCO "A" LINE BEARINGS

P/N	INDUSTRY STANDARD P/N
ASET049-011	KHM212049 / KHM212011
A212049	KHM212049
A212011	KHM212011
ASET248-210	KHM218248 / KHM248210
A218248	KHM218248
A218210	KHM218210
ASET594A-92A	K594A / K592A
A594A	K594A
A592A	K592A
ASET580-72	K580 / K572
A580	K580
A572	K572
ASET3782-20	K3782 / K3720
A3782	K3782
A3720	K3720
ASET445-410	KHM518445 / KHM518410
A518445	KHM518445
A518410	KHM518410
ASET663-53	K663 / K653
A663	K663
A653	K653
ASET047-011	KHM212047 / KHM212011
A212047	KHM212047
A212011	KHM212011
ASET45280-20	K45280 / K45220
A45280	K45280
A45220	K45220
ASET6461A-20	K6461A / K6420
A6461A	K6461A
A6420	K6420
ASET555S-52A	K555S / K552A
A555S	K555S
A552A	K552A
ASET449A-410	KHM516449A / KHM516410
A516449A	KHM516449A
A516410	KHM516410
ASET47679-20	K47679 / K47620
A47679	K47679
A47620	K47620
ASET567-563	K567 / K563
A567	K567
A563	K563
ASET582-572	K582 / K572
A582	K582
A572	K572
ASET687-672	K687 / K672
A687	K687
A672	K672
ASET598A-92A	K598A / K592A
A598A	K598A
A592A	K592A

Bearings to Hub Seal Set Cross Reference

CROSS REFERENCE

Inner Cup & Cone	Outer Cup & Cone	Guardian®/ Guardian® HP Seal No.	Grit Guard®**/ Standard Set	Voyager® Discover®
33212	33208			383-0176
382A/387AS	LM104911/ LM104949		392-9063	
493/495AX	3920/ 3984		392-9018	
493/495AX	33287/ 33462	309-0957	392-9057	
493/495AX	39520/ 39590	309-0957	392-9057 392-9045	
552A/559	552/526		382-8011	
553X/557A	3720/3782	308-0836	382-8036	383-0136 383-0236
563/567	522/528		372-7006	
572/575	572/575		392-9032	
572/580	563/567	309-0903	392-9094*	393-0103 393-0203
			392-9032	
572/580	42620/ 42687	309-0961	392-9095*	
572/582	563/567	309-0903	392-9094*	393-0103 393-0203
572/582	42620/ 42687	309-0961	392-9095*	
592A/593	65320/ 65390		372-7022 372-7062	
592A/594	572/580	309-0964 309-0973	392-9088* 392-9131	393-0173 393-0273
592A/594A	572/580	309-0960 309-0964 309-0973	392-9132* 392-9088* 392-9131	393-0173 393-0273
592A/594A	572/582	309-0960	392-9132*	
592A/595	572/580	309-0965	392-9096	
592A/598	572/575	309-0965 309-0973	392-9096* 392-9131	393-0173 393-0273
592A/598A	653/665	309-0965	392-9092*	
592A/598	752/758	309-0965	392-9092*	
592A/598	HM617010/ HM617049	309-0965	392-9092*	
592A/598A	572/580	309-0960 309-0973	392-9132 392-9131	393-0173 393-0273
592A/598A	572/582	309-0960	392-9132*	
592A/598	HM617010/ HM617049	309-0960	392-9081 392-9132	
593X/594	593X/594		392-9111	
632/641	3920/3979	308-0853	382-8053	383-0153 N/A
632/641	28622/ 28682	308-0856	382-8056	383-0156 N/A

Inner Cup & Cone	Outer Cup & Cone	Guardian®/ Guardian® HP Seal No.	Grit Guard®**/ Standard Set	Voyager® Discover®
633/641	65320/ 65385			382-8039 383-8139
652/663	572/575	309-0904		392-9112* 392-9007 393-0104 393-0204
653/663	553X560	307-0713		372-7098* 373-0113 373-0213
653/663	HM212011/ HM212049	307-0713		372-7098* 373-0113 373-0213
653/663A	42620/ 42687	309-0961		372-7003 392-9095*
653/665A	HM212011/ HM212049	307-0744		372-7095*
672/681A	572/575	309-0970		392-9087*
672/683	572/580	309-0970		392-9087*
672/683XA	572/580	309-0970		392-9087*
672/687	772/780	309-0948		392-9089* 393-0148 N/A
672/687	52618/ 52400	309-0948		392-9089* 393-0148 N/A
742/749	632/643			372-7091* 372-7024
742/749S	632/643			372-7091* 372-7024
742/749A	653/663			392-9033
752/756A	HM212011/ HM212046			382-8028 382-8045
752/756A	HM212011/ HM212047			382-8028 382-8045
752/758	663/665			392-9001
752/759	742/740			372-7015
752/760	742/749			392-9001
752/760	742/749			392-9062
772/780	772/776	309-0948		392-9089* 393-0148 N/A
772/780	854/864	309-0948		392-9089* 393-0148 N/A
772/780	52618/ 52400	309-0948		392-9089* 393-0148 N/A
772/780	77675/ 77375	309-0948		392-9089* 393-0148 N/A
772/782	742/749			392-9053
832/843	632/636			382-8008
3720/3778	25820/ 25877			382-8005
3720/3778	2720/2790			382-8005
3920/3982	3820/3877			382-8011
3920/3984	453X/462			392-9038
4536/4595	414A/418			382-8010
5735/5760	572/575	309-0912		392-9012 393-0112 393-0212
5735/5760	39520/ 39590			382-8052

(Continued Next Page.)

Component part numbers obsolete, sold as sets only.

Bearings to Hub Seal Set Cross Reference

Inner Cup & Cone	Outer Cup & Cone	Guardian®/ Guardian® HP Seal No.	Grit Guard**/ Standard Set	Voyager® Discover®
5735/5760	45220/45287		382-8060	
6320/6379	552A/557S		382-8001	383-0101
6320/6386	552A/557S		382-8001	383-0101
6320/6386A	532A/537		382-8052	
6320/6389	552A/557S		382-8001	383-0101
6420/6461	612/621		382-8060	
6420/6461A	552A/555S	308-0864	382-8064	383-0164 383-0264
6420/6461A	3920/3979	308-0864	382-8064	383-0164 383-0264
6535/6559	653/663		392-9033	
			392-9034	393-0134
6535/6580	653/663		392-9034	393-0134
28920/28995	25523/25580		372-7046	
33462/33281	3920/3982	309-0935	392-9035	
33462/33281	39520/39585		392-9036	
33462/33287	3920/3982	309-0935	392-9035	
33472/33281	3925/3984		392-9045	
33472/33287	3925/3982		392-9045	
33821/33895	3120/3196		382-8016	
39520/39578	25520/25572		382-8010	
39520/39581	3525/3585	308-0836	382-8036	383-0136 383-0236
		308-0863	382-8063 382-8027	
39520/39581	26820/26878		382-8017	
39520/39585	25520/25572		382-8062	
45220/45284	2720/2780		382-8044	
45220/45284	2720/2786		382-8009	
45220/45284	2720/2793		382-8009	
45220/45284	2720/2796		382-8009	
45220/45284	25820/25880	308-0863	382-8044 382-8063	
45220/45285	2720/2786		382-8009	
45220/45285	2720/2793		382-8009	
45220/45285	2720/2796		382-8009	
47620/47678	39520/39585	309-0912	392-9012	393-0112
			392-9099*	393-0212
47620/47685	39520/39590	309-0912	392-9099*	393-0112 393-0212
47620/47686	39520/39590	309-0912	392-9099*	393-0112 393-0212
		309-0915	392-9012 392-9045	393-0112

Inner Cup & Cone	Outer Cup & Cone	Guardian®/ Guardian® HP Seal No.	Grit Guard**/ Standard Set	Voyager® Discover®
127627/1889311	49521/188933			392-9063
7451691/7451929	7451813/7451814			392-9063
H715311/H715345	552A/555S	308-0856	382-8056	383-0156 N/A
H715311/H715345	3920/3979	308-0853	382-8053	383-0153 N/A
HM212010/HM212049	28622/28682	308-0853	382-8053	383-0153 N/A
HM212011/HM212044	3720/3782	308-0836	382-8036	383-0136 383-0236
HM212011/HM212047	3720/3779		382-8034	
HM212011/HM212047	3720/3782	308-0836	382-8036	383-0136 383-0236
HM212011/HM212047	45220/45282		382-8034 382-8071	383-0171
HM212011/HM212049	3720/3782	308-0836	382-8036	383-0136 383-0236
			382-8032	
HM212011/HM212049	45220/45280		382-8039	383-0139 383-0239
HM212011/HM212049X	3720/3782	308-0836	382-8036	383-0136 383-0236
HM218210/HM218248	HM212011/HM212049	307-0743	372-7097	373-0143 373-0243
JM205110/JM205149	25820/25877	308-0866	382-8066	383-0166 383-0175
JM207010/JM207049	25820/25877	308-0866	382-8066	383-0166
HM516410/HM516449	572/575		392-9007	
HM516410/HM516449	47620/47679	309-0904	392-9112	393-0104 393-0204
			392-9007	
HM516410/HM516449A	47620/47679	309-0904	392-9130*	393-0104 393-0204
HM518410/HM518445	HM518410/HM518445	307-0723	372-7099	373-0123 373-0223
JM205149	32207			383-0175
JM205110/JM204149A	25820/25877		382-8066	383-0166
JM511910/JM510946	JM205110/JM205149		372-7049	
JF7049A		308-0870		
33212	33208			383-0176

CROSS REFERENCE

Component part numbers obsolete, sold as sets only.

Pinion Seal Specifications

Unitized Pinion Seal Specifications and Interchange

Part #	Bore ID	Yoke Shaft OD	Tool #	Application	OE #	SKF #	National #
429-0002	4.500	3.500	551-5360	Mack Front	88AX458	34882 34891	415991N
429-0003	4.562	2.625	551-5001	Eaton 400 Rear	127721 79470	26373 26378	9773
					127592	26220	
429-0004	3.625	2.625	551-5003	Eaton 400 Front	127720 63910	26209 26239	475003N
429-0005	3.751	3.003	551-5004	Meritor SQ100 Front	A1-1205Y2729 A1205P2590	29865 29867 30007	4810V 100495 415281N
429-0006	4.003	2.937	551-5002	Eaton 402 Front	210737 127719 A1205U1737	29292 29322 29316	416654 475012N
429-0007	4.249	3.253	551-5006	Meritor R145/160 Front	A1-1205X2728 A1205R2592 A1205P1368	32385 32397 32410	4543V 100494 416470N
429-0008	3.537	2.751	551-5007	Mack Front	88AX456 A1205A1925	27295 27558	4874N 475322N
429-0009	3.996	2.751	551-5008	Mack Rear	88AX457	27542 27565	415272N
429-0010	4.935	3.003	551-5009	Meritor SQ100 Rear	A1-1205Z2730 A1205N2588 A1205H2426	30145 30153	3905 4562V 100263
429-0011	5.501	3.253	551-5011	Meritor RT 46-160 180, 380 Series	A1205Q2591	32870	4544V 100557
429-0012	4.564	3.000	551-5012	Eaton 344, 404, 405, 454 Front & Rear	127591	29528	

Pinion Seal Specifications by Set Number

Set No.	Bore ID	Yoke Shaft OD	Wear Sleeve	Dust Seal	Oil Seal	Spline OD
460-6001	3.625	2.625	419-1946	429-2945	429-2944	1-3/4 1 31/32
460-6002	4.562	2.625	419-1946	□	429-2983	1-3/4 1 31/32
460-6003	3.937	2.937	419-1981	429-2978	429-2977	2
460-6004	3.542	2.750	419-1982	429-2980	429-2979	1-3/4 1 7/8
460-6005	3.875	2.750	419-1982	□	429-2982	1-3/4 1 7/8 1.96
460-6006	4.000	2.937	419-1940	429-2937	429-2938	2 2 5/32
460-6007	4.000	3.000	419-1939	429-2937	429-2938	1-31/32
460-6011	4.250	3.250	419-1941	□	429-2941	2-1/4
460-6012	4.250	3.000	419-1901	□	429-2901	Any
460-6083	4.250	3.250	419-1983	□	429-2941	2-1/4
460-6084	4.000	2.937	419-1984	429-2937	429-2938	2 2 5/32

□ Oil Seal & Dust Seal are an integral unit

Shaded numbers indicate obsolete part numbers.

Axle Ring to Hub Seal Set Cross Reference

Axle Ring	Oil Seal	Hub Seal Set	Axle Ring	Oil Seal	Hub Seal Set	Deflector Ring	Guardian/GuardianHP Seal
310-1007	320-2096	392-9007	310-1062	320-2057	392-9035	317-1710*	308-0855
310-1008	320-2018	372-7046	310-1063	320-2057	392-9036	317-1743*	307-0743
310-1008	320-2105	382-8044	310-1064	320-2136	372-7049	317-1702*	308-0836
310-1008	320-2164	382-8066	310-1064	320-2072	392-9038	317-1703*	309-0973
310-1009	320-2181	382-8052	310-1066	320-2061	392-9034	317-1704*	307-0713
310-1012	320-2012	392-9012	310-1079	320-2009	392-9081	317-1705*	309-0904
310-1013	320-2086	382-8001	310-1088	320-2213	None	317-1705*	307-0723
310-1013	320-2109	None	310-1089	320-2099	392-9053	317-1706*	308-0856
310-1017	320-2017	382-8017	310-1093	320-2199	382-8056	317-1706*	309-0903
310-1018	320-2029	372-7018	310-1093	320-2181	382-8053	317-1707*	309-0912
310-1018	320-2029	392-9018	310-1093	320-2058	392-9033	317-1708*	308-0853
310-1018	320-2104	392-9057	310-1093	320-2113	None	317-1709*	307-0744
310-1022	320-2023	372-7022	310-1095	320-2001	392-9001	317-1710*	308-0855
310-1023	320-2023	None	310-1103	320-2001	392-9062	317-1711*	308-0864
310-1023	320-2173	372-7024	310-1104	320-2077	392-9063	317-1712*	309-0964
310-1026	320-2131	None	310-1107	320-2119	392-9066	317-1713*	309-0965
310-1028	320-2166	382-8069	310-1111	320-2106	None	317-1719*	309-0961
310-1028	320-2028	382-8028	310-1111	320-2115	None	317-1721*	308-0863
310-1028	320-2041	382-8045	310-1111	320-2162	None	317-1724*	309-0957
310-1028	320-2009	None	310-1117		See 392-9045 Remarks	317-1726*	308-0866
310-1032	320-2032	382-8032	310-1123		See 392-9034 Remarks	317-1728*	309-0935
310-1034	320-2034	382-8034	310-1130	320-2023	372-7062	317-1756*	309-0915
310-1034	320-2216	382-8071	310-1233	320-2233	392-9111	317-1761*	309-0970
310-1036	320-2032	372-7009	315-1501	320-2102	392-9099	317-1761*	309-0960
310-1036	320-2046	372-7006	315-1502	320-2162	392-9087	317-1790*	309-0948
310-1036	320-2031	None	315-1503	320-2023	372-7099	317-1724*	308-0870
310-1036	320-2036	382-8036	315-1503	320-2173	372-7091		
310-1036	320-2119	382-8027	315-1504	320-2110	372-7097		
310-1036	320-2133	382-8063	315-1506	320-2111	372-7096		
310-1037	320-2118	None	315-1507	320-2109	372-7098		
310-1037	320-2137	382-8064	315-1508	320-2114	392-9096		
310-1038	320-2039	382-8039	315-1508	320-2131	392-9092		
310-1041	320-2023	382-8060	315-1509	320-2117	392-9095		
310-1043	320-2041	372-7015	315-1510	320-2118	372-7095		
310-1048	320-2110	None	315-1511	320-2129	392-9094		
310-1050	320-2022	382-8010	315-1515	320-2213	392-9112		
310-1051	320-2031	382-8011	315-1516	320-2097	392-9089		
310-1051	320-2125	382-8062	315-1517	320-2113	392-9088		
310-1052	320-2050	382-8009	315-1519	320-2213	392-9130		
310-1053	320-2109	392-9032	315-1525	320-2106	392-9131		
310-1057	320-2109	372-7003	315-1530	320-2115	392-9132		
310-1061	320-2056	382-8005					

* 317-series deflector rings are component parts for the Guardian® Hub Seal. These parts are not sold separately.

CROSS REFERENCE

Shaded numbers indicate obsolete part numbers.

EXTEND SEAL & BEARING LIFE BY PREVENTING CONTAMINATION

SENTINEL®



SENTINEL® TECHNOLOGY

Provides an unmatched filtering system to eliminate contamination of lubricant from grime, dirt or water.

Sentinel® Hub Cap

Provides a tamper-proof hub cap system for maximum protection and maintenance-free performance.



Integrated Sentinel® Hub Cap

Tamper-proof hub cap integrates the Sentinel® features into the window with fewer components and greater wheel end visibility.



Sentinel® ESP (Extended Service Plug)

Allows economical retrofitting of wheel ends with the benefits of STEMCO'S exclusive Sentinel® Technology.



Sentinel® ESP Filtered Vent

Drive axles can now be retrofitted to benefit from STEMCO'S exclusive Sentinel® Technology.



A Higher Standard of Performance.™
an EnPro Industries company

SENTINEL[®] TECHNOLOGY

STEMCO[®]
A Higher Standard of Performance.[™]
an EnPro Industries company

- Prevents dirt and water from contaminating the oil, thereby extending seal and bearing life.
- Dramatically reduces contaminant build-up on hub cap windows, allowing for an accurate determination of lube levels.
- Eliminates early oil breakdown by preventing water contamination as a result of submerged axles.
- Provides maximum protection for maintenance-free wheel end systems.
- Improves performance and lowers overall maintenance costs.

SENTINEL[®] HUB CAP

STEMCO BASE PART NO.	OIL CAP	GREASE CAP	BOLT CIRCLE	BOLT SIZE	NO. OF BOLTS	GASKET NUMBER	OIL WINDOW KIT	GREASE WINDOW KIT
4009	348-4009	349-4009	5 1/2"	5/16"	6	330-3009	359-6112	359-6120
4013	348-4013	349-4013	5 1/2"	5/16"	5	330-3013	359-6112	359-6120
4046	348-4046	349-4046	5 1/2"	5/16"	6	330-3009	359-6112	359-6120
4075	348-4075	349-4075	6 1/4" x 8" UN(M)			330-3077	359-6112	359-6120
4095	348-4095	349-4095	5 1/2"	5/16"	6	330-3009	359-6112	359-6120
4195	348-4195	349-4195	6 3/4"	5/16"	6	330-3118	359-6112	359-6120
4281	348-4281	N/A	5 17/32"	3/8"	6	330-3122	359-6112	359-6120

INTEGRATED SENTINEL[®] HUB CAP

STEMCO BASE PART NO.	OIL CAP	GREASE CAP	BOLT CIRCLE	BOLT SIZE	NO. OF BOLTS	GASKET NUMBER	OIL WINDOW KIT	GREASE WINDOW KIT
4009	356-4009	358-4009	5 1/2"	5/16"	6	330-3009	359-6145	359-6146
4013	356-4013	358-4013	5 1/2"	5/16"	5	330-3013	359-6145	359-6146
4024	356-4024	358-4024	4 1/2"	5/16"	6	330-3024	359-6143	359-6144
4025	356-4025	358-4025	5 7/8"	5/16"	6	330-3025	359-6143	359-6144
4046	356-4046	358-4046	5 1/2"	5/16"	6	330-3009	359-6145	359-6146
4075	356-4075	358-4075	6 1/4" x 8" UN(M)			330-3077	359-6145	359-6146
4080	356-4080	358-4080	6	3/8"	6	330-3060	359-6143	359-6144
4095	356-4095	358-4095	5 1/2"	5/16"	6	330-3009	359-6145	359-6146
4119	356-4119	358-4119	7	5/8"	8	330-3090	359-6145	359-6146
4150	356-4150	358-4150	4 1/2"	5/16"	5	330-3150	359-6143	359-6144
4195	356-4195	358-4195	6 3/4"	5/16"	6	330-3118	359-6145	359-6146

SENTINEL[®] ESP (EXTENDED SERVICE PLUG)

STEMCO PART NO.	DESCRIPTION
359-6124	ESP Plug Blister Pack (2/pk)
359-6125	ESP Plugs (bulk pack of 50)

SENTINEL[®] ESP

STEMCO PART NO.	DESCRIPTION
300-5009	340-4009 Hub Cap with ESP Plug Bulk Pack (25/box)
303-5009	343-4009 Hub Cap with ESP Plug Bulk Pack (25/box)

SENTINEL[®] ESP FILTERED VENT

STEMCO PART NO.	DESCRIPTION
359-6137	Drive Axle Vent (3/8" adapter)

SENTINEL[®]

To relieve vacuum, the Sentinel[®] interior check valve lifts slightly, drawing air through the water-resistant expanded PTFE fabric filter into the wheel end, while the duck-bill check valve remains closed, blocking dirt, grime and other contaminants from entering.



To relieve pressure, the Sentinel[®] duck-billed pressure relief valve opens, allowing pressure to vent out, while the umbrella check valve remains closed, stopping lubricant from leaking out and contaminants from flowing in.

Hub Cap Specifications

Hub Caps By Cap Number

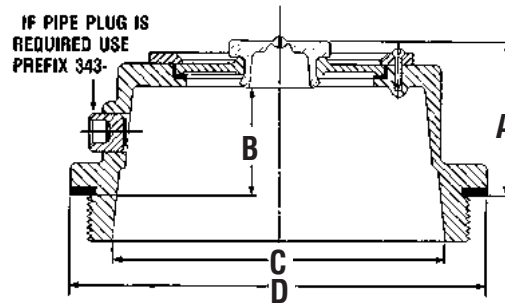
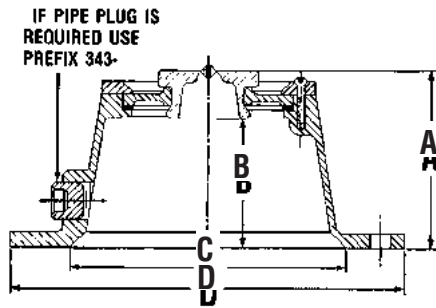























Hub Cap Includes Gasket	Bolt Circle	Bolt Size	No. Of Bolts	A Height	B Inside Depth	C Flange I.D.	D Flange O.D.	Gasket Number	Window Kit
340-4002	5-1/4	3/8	3	2-7/8	2-1/8	4-3/8	6	330-3002	359-5999
340-4009 ☐	5-1/2	5/16	6	2-11/16	1-15/16	4-3/8	6-1/4	330-3009	359-5995
340-4011	6-1/8	3/8	3	2-11/16	1-15/16	4-5/16	7	330-3011	359-5995
340-4013 ☐	5-1/2	5/16	5	2-11/16	1-15/16	4-3/8	6-1/4	330-3013	359-5995
340-4015	Blank	--	--	2-11/16	1-15/16	4-3/8	6-1/4	330-3015	359-5995
340-4019	5-1/4	3/8	3	3-1/2	2-3/4	4-1/8	Not Round	330-3019	359-5995
340-4024	4-1/2	5/16	6	2-5/8	1-7/8	3-1/2	5-1/4	330-3024	359-5999
343-4025 ☐	5-7/8	5/16	6	1-3/8	5/8	4-1/4	6-1/2	330-3025	359-5999
340-4028	5	1/4	4	3-1/8	2-3/8	4	5-3/4	330-3028	359-5999
340-4031	5-1/4	5/16	6	2-7/8	2-1/8	4-3/8	6	330-3031	359-5999
340-4034	6-5/8	1/4	6	2-13/16	2-1/16	5-5/16	7-1/8	330-3034	359-5999
340-4036	5-7/8	5/16	6	2-3/8	1-5/8	5-1/8	Not Round	330-3035	359-5995
340-4042	5-1/8	5/16	6	1-7/8	1-1/8	4	5-11/16	330-3041	359-5999
340-4046	5-1/2	5/16	6	2-5/16	1-9/16	4-9/16	6-3/16	330-3009	359-5995
340-4049	5-9/16	5/16	3	2-7/8	2-1/8	3-3/4	6-3/8	330-3042	359-5999
340-4054 ☐	Blank	None	--	2-1/8	1-3/8	4-1/32	8-5/8	330-3017	359-5995
340-4059	6	5/16	6	2-5/8	1-7/8	5	6-3/4	330-3056	359-5995
343-4064 ☐	6-3/4	3/8	6	2-11/16	1-15/16	5	7-3/4	330-3079	359-5995
340-4065	3-5/8	5/16	4	2-1/4	1-1/2	2-3/4	4-1/2	330-3040	359-5990
340-4066	5-1/8	5/16	6	2-7/8	2-1/8	3-3/4	5-3/4	330-3041	359-5999
340-4075 ☐	6-1/4 X 8 UN (M)			2-5/16	1-9/16	5-3/4	6-7/8	330-3077	359-5995
343-4080 ☐	6	3/8	6	3-3/16	2-3/8	4-15/16	6-7/8	330-3060	359-5999
340-4082	6-7/8	7/16	7	2-11/16	1-15/16	5	7-3/4	330-3062	359-5995
340-4092	5-7/8	5/16	6	1-5/8	1-7/16	4-1/2	6-37/64	330-3025	359-5912
340-4095	5-1/2	5/16	6	1-13/16	1-1/16	4-9/16	6-3/16	330-3009	359-5995
340-4098	5-1/2	5/16	6	1-1/4	1-1/8	4-7/16	6-3/16	330-3009	359-5912
343-4107 ☐	7-1/4	1/4	6	2-7/8	2-1/8	6-1/4	7-7/8	330-3084	359-5995
340-4119 ☐	7	5/8	8	2-1/16	1-5/16	4-5/16	8-1/4	330-3090	359-5995
343-4122 ☐	5-1/2	5/16	6	2-11/16	1-15/16	4-3/8	6-1/4	330-3009	359-5995
340-4139 ☐	4-1/16	3/16	6	2-5/8	1-7/8	3-5/16	4-1/2	330-3094	359-5999











(Continued Next Page)

- ☐ Cannot be made with pipe plug.
- ☒ Made with pipe plug only.
- ☑ Hub cap available with hubo window, order 347-prefix. Also available **347-4342**, which is 4195 hub cap for grease applications and **347-4343** which is 4075 hub cap for grease applications, **347-4278** for 4009 grease hub cap application.
- ☑ 4009 hub cap with magnetic pipe plug (**359-5984**).

Hub Cap Specifications

Hub Caps By Cap Number

Hub Cap Includes Gasket	Bolt Circle	Bolt Size	No. Of Bolts	A Height	B Inside Depth	C Flange I.D.	D Flange O.D.	Gasket Number	Window Kit
340-4149	5-9/16	5/16	6	2-7/8	2-1/8	3-11/16	6-3/8	330-3097	359-5999
340-4157 	4	1/4	4	2-1/8	1-3/8	3-1/8	4-9/16	330-3102	NONE
340-4163 	6-1/8	5/16	6	2-11/16	1-15/16	4-5/16	7	330-3104	359-5995
343-4176	6	5/16	6	2-1/2	1-3/4	4-15/16	6-7/8	330-3060	359-5999
340-4186	5	5/16	4	2-1/8	1-3/8	4	5-3/4	330-3120	359-5999
340-4195 	6-3/4	5/16	6	3-11/16	2-15/16	5-7/16	7-1/2	330-3118	359-5995
340-4198	3-7/8	5/16	6	2-1/4	1-1/2	2-3/4	4-1/2	330-3119	NONE
340-4249 	5-1/2	5/16	6	1-13/16	1-11/16	4-7/16	6-3/16	330-3122	359-5912
343-4250  	5-17/32	3/8	6	1-13/16	1-9/16	4-7/16	6-3/16	330-3122	NONE
340-4263 	4-1/2	6mm	6	2-5/8	1-7/8	3-1/2	5-1/4	330-3024	359-5999
343-4269 	132mm	8.5mm	6	63.5mm	53.4mm	106mm	156mm	330-3128	359-6100
343-4281 	5-17/32	3/8	6	2-5/16	1-9/16	4-9/16	6-3/16	330-3122	359-5995
343-4295 	110mm	8.5mm	6	67.3mm	47.0mm	88.4mm	133.3mm	330-3130	359-5999
340-4305 	7	13/16	8	2-1/16	1-5/16	4-5/16	8-1/4	330-3107	359-5995
343-4308  	4-1/2	5/16	6	2-5/8	1-7/8	3-1/2	5-1/4	330-3024	NONE
343-4309  	5-1/2	5/16	6	1-13/16	1-1/16	4-9/16	6-3/16	330-3009	359-6100
340-4320 	6-1/4 X 8 UN (M)			2-5/16	1-9/16	5-3/4	6-7/8	330-3077	NONE
343-4342  	5-1/2	5/16	6	2-11/16	1-15/16	4-3/8	6-1/4	330-3009	359-6100
340-4975  	6-1/4 X 8 UN (M)			2-5/16	1-9/16	5-3/4	6-7/8	330-3077	NONE
340-4976  	6-1/4 X 8 UN (M)			2-5/16	1-9/16	5-3/4	6-7/8	330-3077	NONE
340-4977 	6-1/4 X 8 UN (M)			2-5/16	1-9/16	5-3/4	6-7/8	330-3077	NONE

-  Cannot be made with pipe plug.
-  Made with pipe plug only.
-  Hub cap can be used with 5-1/2 or 5-9/16 bolt circle with 5/16 inch bolts.
-  Hub cap available with hubo window, order 347-prefix. Also available **347-4342**, which is 4195 hub cap for grease applications, **347-4343** which is 4075 hub cap for grease applications and **347-4278** which is 4009 hub cap for grease applications. Also available with Hubo window when ordered with 347 prefix. See options below.
-  Lexan hub caps, order in multiples of 25.
-  4249 with recessed vent plug.
-  4095 with small vent plug **359-5915**.
-  4009 with small vent plug **359-5915**.
-  4024 with small vent plug.
-  4975 individually boxed.

Torque Specifications

Hub Cap Mounting Bolts			
3/16	8-10 ft. lbs.	1/2	20-24 ft. lbs.
1/4	8-12 ft. lbs.	3/4	24-28 ft. lbs.
5/16	12-16 ft. lbs.	7/8	26-30 ft. lbs.
3/8	16-20 ft. lbs.	6 MM	8-12 ft. lbs.
7/16	18-22 ft. lbs.	8.5 MM	12-16 ft. lbs.

Threaded Hub Caps	
XXX-4075	100 ft. lbs.
340-4975	50-60 ft. lbs.
340-4976	50-60 ft. lbs.
640-0003	50-60 ft. lbs.

Hubo Window Options		
STEMCO Base Part No.	Grease Cap	Oil Cap
4009	347-4278	347-4009
4075	347-4343	347-4075
4195	347-4342	347-4195

Hub Cap Components		
359-6032	#8 Torx Screw	25 in. lbs. Maximum
359-5984	3/8 Mag Plug	5-9 ft. lbs. Maximum
359-5985	3/8 Pipe Plug	5-9 ft. lbs. Maximum

Hub Cap Specifications

Sentinel® Hub Caps



STEMCO Base Part No.	Oil Cap	Grease Cap	Bolt Circle	Bolt Size	No. of Bolts	Gasket Number	Oil Window Kit	Grease Window Kit
4009	348-4009	349-4009	5-1/2	5/16	6	330-3009	359-6112	359-6120
4013	348-4013	349-4013	5-1/2	5/16	5	330-3013	359-6112	359-6120
4046	348-4046	349-4046	5-1/2	5/16	6	330-3009	359-6112	359-6120
4075	348-4075	349-4075	6-1/4 x 8 UN(M)			330-3077	359-6112	359-6120
4095	348-4095	349-4095	5-1/2	5/16	6	330-3009	359-6112	359-6120
4195	348-4195	349-4195	6-3/4	5/16	6	330-3118	359-6112	359-6120
4281	348-4281	N/A	5-17/32	3/8	6	330-3122	359-6112	359-6120

Window kit consists of window, gasket, window ring assembly/gasket and Sentinel Cap Cover P/N 359-6103.

Integrated Sentinel® Hub Cap



STEMCO Base Part No.	Oil Cap	Grease Cap	Bolt Circle	Bolt Size	No. of Bolts	Gasket Number	Oil Window Kit	Grease Window Kit
4009	356-4009	358-4009	5-1/2	5/16	6	330-3009	359-6145	359-6146
4013	356-4013	358-4013	5-1/2	5/16	5	330-3013	359-6145	359-6146
4024	356-4024	358-4024	4-1/2	5/16	6	330-3024	359-6143	359-6144
4046	356-4046	358-4046	5-1/2	5/16	6	330-3009	359-6145	359-6146
4075	356-4075	358-4075	6-1/4 x 8 UN(M)			330-3077	359-6145	359-6146
4095	356-4095	358-4095	5-1/2	5/16	6	330-3009	359-6145	359-6146
4150	356-4150	358-4150	4-1/2	5/16	5	330-3150	359-6143	359-6144
4195	356-4195	358-4195	6-3/4	5/16	6	330-3118	359-6145	359-6146

Sentinel® ESP (Extended Service Plug)

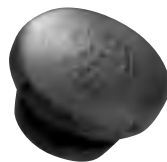

STEMCO BASE PART NO.	DESCRIPTION
359-6124	ESP Plug Blister Pack (2/pk)
359-6125	ESP Plugs (bulk pack of 50)

Sentinel® ESP Filtered Vent



STEMCO BASE PART NO.	DESCRIPTION
359-6137	Drive Axle Vent (3/8" adapter)

Hub Cap Specifications

Hub Caps with Sentinel® ESP Plug



350-4065

Sentinel® ESP Part No.	Description	Bolt Circle	Bolt Size	No. of Bolts	Gasket P/N
350-4065*	4065 Cap, no side fill plug	3-5/8	5/16	4	330-3040
353-4065*	4065 Cap, with side fill plug	3-5/8	5/16	4	330-3040

* Cannot use standard 340 or 343-4065 cap with ESP™ Plug. The casting has been modified to accept the ESP™, therefore, the above part numbers must be ordered to use this application with the ESP™ Plug.

Bulk Pack Hub Caps with Sentinel® ESP Plug

Sentinel® ESP Part No.	Description	Bolt Circle	Bolt Size	No. of Bolts	Gasket P/N
300-5009	4009 Cap, no side fill plug Bulk Pack (25/Box)	5-1/2	5/16	6	330-3009
303-5009	4009 Cap, with side fill plug Bulk Pack (25/Box)	5-1/2	5/16	6	330-3009

PSI Ready Hub Cap



Grease
Hub Cap
340 Series

STEMCO Base Part No.	Grease Cap	Oil Cap	Oil Cap with Magnetic Pipe Plug
4009	340-4370	343-4370	343-4374
4075	340-4371	343-4371	343-4375
4195	340-4372	343-4372	343-4376
4384	340-4384	N/A	N/A
Window Kits	359-6141	359-6140	—



Oil
Hub Cap
343 Series

Window kit consists of window, gasket and PSI retainer ring/gasket.

TIREMAAX® HUB CAP



(340/343-4307)
"N" Series Hub Cap

STEMCO Part No.	Application	Bolt Circle Diameter	No. of Bolts	Gasket P/N
340-4307	"N" series "GREASE" hub cap	5 ½"	6	330-3009
343-4307	"N" series "OIL" hub cap	5 ½"	6	330-3009
340-4311	"P" series "GREASE" hub cap	6 ¾"	6	330-3118
343-4311	"P" series "OIL" hub cap	6 ¾"	6	330-3118



(340/343-4311)
"P" Series Hub Cap

Hubo Bracket for Sentinel® and PSI Hub Caps

STEMCO Part No.	STEMCO Base Part No.	PSI Hub Cap Part No. (Grease)	PSI Hub Cap Part No. (Oil)	Stud Size	Height
610-0084	4195	340-4372	343-4372	5/16	5
610-0028	4009	340-4370	343-4370	5/16	5
610-0090	4075	340-4371	343-4371	*	1 7/8

*Bracket mounts on top of window ring w/4 replacement screws included w/bracket.

Hub Cap Specifications

Stamped Steel Grease Hub Caps



340-5094



340-5096



340-5097

Hub Cap Includes Gasket	Bolt Circle	Bolt Size	No. of Bolts	A Height	B Inside Depth	C Flange I.D.	D Flange O.D.	Gasket Number
340-5094	5-1/2	5/16	6	2-1/2	2-13/32	4-3/8	6-1/4	330-3009
340-5096 <input type="checkbox"/>	5-1/2	5/16	6	2-1/2	2-13/32	4-3/8	6-1/4	330-3009
340-5097	5-1/2	5/16	6	2-1/2	2-13/32	4-3/8	6-1/4	330-3009
340-0044 <input type="checkbox"/>	4-1/2	5/16	6	2	1-15/16	3-5/16	5-3/16	330-3024

With Dirt Exclusion vent

Painted black

Solid Grease Hub Cap/Duckbill Vented

STEMCO Part No.	Bolt Circle	Bolt Size	No. of Bolts	Gasket Number
352-4009	5-1/2	5/16	6	330-3009
352-4195	6-3/4	5/16	6	330-3118
362-4089*	5-1/2	5/16	6	330-3009



352-4195

*No Duckbill Vent

Non-Vented Grease Hub Caps

STEMCO Part No.	Application	Bolt Circle Diameter	Bolt Size	No. of Bolts	Gasket P/N
340-4321	4009 "N" Series Grease-Trailer	5 1/2"	5/16	6	330-3009
340-4322	4195 "P" Series Grease-Trailer	6 3/4"	5/16	6	330-3118



340-4321

Dirt Exclusion Grease Hub Caps

Hub Cap Includes Gasket	Bolt Circle	Bolt Size	No. of Bolts	A Height	B Inside Depth	C Flange I.D.	D Flange O.D.	Gasket Number	* Window Kit
342-4009	5-1/2	5/16	6	2-11/16	1-15/16	4-3/8	6-1/4	330-3009	359-6095
342-4013	5-1/2	5/16	5	2-11/16	1-15/16	4-3/8	6-1/4	330-3013	359-6095
342-4024	4-1/2	5/16	6	2-5/8	1-7/8	3-1/2	5-1/4	330-3024	359-6094
342-4075	6-1/4 x 8 UN(M)			2-5/16	1-9/16	5-3/4	6-7/8	330-3077	359-6095
342-4095	5-1/2	5/16	6	1-13/16	1-1/6	4-9/16	6-3/16	330-3009	359-6095
342-4195	6-3/4	5/16	6	3-11/16	2-15/16	5-7/16	7-1/2	330-3118	359-6095
342-4249	5-1/2	5/16	6	1-13/16	1-11/16	4-7/16	6-3/16	330-3122	359-6096

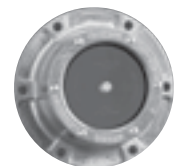

* Window Kit consists of window, gasket and window ring gasket.

Hub Cap Specifications

Typical 4-3/8" Window Component Parts

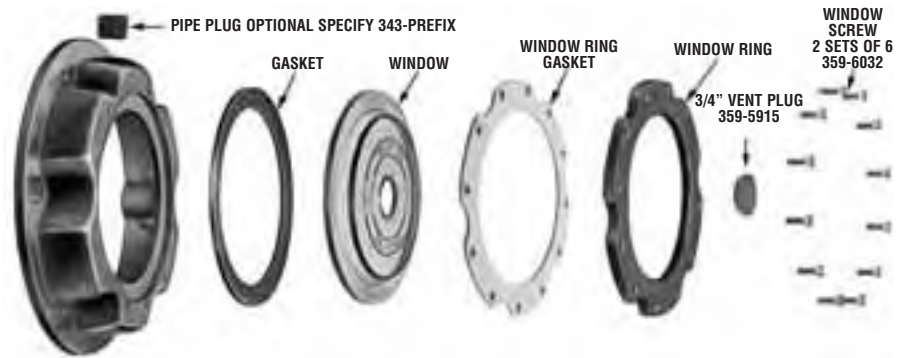

Typical 2-3/4" & 3-1/2" Window Component Parts

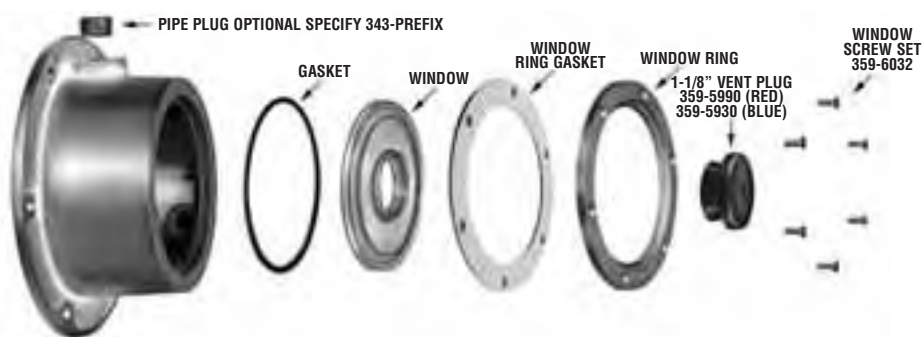

Standard Hub Cap Replacement Components

Window Diameter	Window	Gasket	Window Ring	Window Ring Gasket	Vent Plug	Screw Set 6/Set	Window Kit ☐	3/8 Pipe Plug ☒
2-3/4"	359-5983	359-5996	359-5997 ☐	359-3136	359-5990 ☐	359-6032	359-5999	359-5985
3-1/2"	359-5994	359-5991	359-5992	359-3127	359-5990 ☐	359-6032	359-5995	359-5985
3-1/2"	359-5981 ☐	359-5991	359-5992	359-3127	None	359-6032	359-6117	359-5985
4-3/8"	359-5918	359-5968	359-5970	359-3137	359-5915	359-6032 ☐	359-5912	359-5985
3-1/2"	359-6049 ☐	359-5991	359-5992	359-3127	359-5915	359-6032	359-6100 ☐	359-5985

☐ Window kit consists of window, gasket, window ring gasket and vent plug.

☒ Magnetic pipe plug part number 359-5984.

☐ 5 hole window ring.

☐ Blue vent plug part number 359-5930.

☐ Window for mounting Argo, STEMCO, and Veeder-Root hubodometers (17/32" dia. hole). Be sure hub cap has pipe plug filler before mounting.

☐ Window with recessed vent plug.

☐ Two sets required.

Dirt Exclusion Grease Hub Cap Replacement Components

Window Diameter	Window	Gasket	Window Ring	Window Ring Gasket	Screw Set 6/Set	Window Kit
2-3/4"	359-6086	359-5996	359-5997	359-3136	359-6032	359-6094
3-1/2"	359-6087	359-5991	359-5992	359-3127	359-6032	359-6095
4-3/8"	359-6088	359-5968	359-5970	359-3137	359-6032 ☐	359-6096

☐ Two sets required.

Sentinel® Hub Cap Replacement Components

Window Diameter	Window Kit ☐	Gasket	Window Ring Gasket	Screw Set 6/Set	Magnetic Pipe Plug
3-1/2"	359-6112 ☐	359-5991	359-3127	359-6032	359-5984
3-1/2"	359-6120 ☐	359-5991	359-3127	359-6032	359-5984

☐ Window kit consists of window, gasket, window ring with gasket and Sentinel® red cap cover part number 359-6103.

☐ Window kit for oil application.

☐ Window kit for grease application.

Hub Cap Specifications

Blank Hub Caps

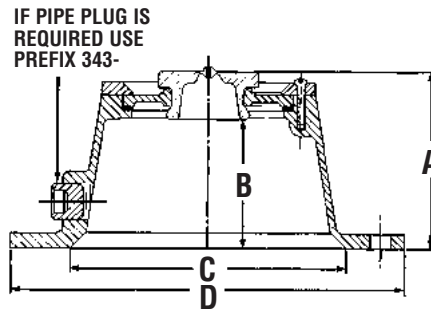

Hub Cap Includes Gasket	Bolt Circle	Bolt Size	No. of Bolts	A Height	B Inside Depth	C Flange I.D.	D Flange O.D.	Gasket Number
340-4054	None	Blank	None	2-1/8	1-3/8	4-1/32	8-5/8	330-3017

4009 Hub Cap Variations

Application	Part Number	Description
Oil	343-4370	Cast aluminum hub cap with PSI face & side fill plug
Oil	347-4009	Cast aluminum hub cap with hubo window & side fill plug
Oil	348-4009	Cast aluminum hub cap with Sentinel® Technology and side fill plug
Oil	356-4009	Integrated Sentinel®
Grease/Oil	340-4009	Cast aluminum hub cap with large red fill plug & no side fill plug
Grease/Oil	343-4009	Cast aluminum hub cap with large red fill plug & side fill plug
Grease/Oil	300-4009	Cast aluminum hub cap with large red fill plug & no side fill plug in 50 unit bulk pack
Grease/Oil	303-4009	Cast aluminum hub cap with large red fill plug & side fill plug in 50 unit bulk pack
Grease	340-4370	Cast aluminum hub cap with PSI face & no side fill plug
Grease	340-5096	Stamped steel hub cap with vent
Grease	340-5097	Stamped steel hub cap with no vent
Grease	342-4009	Cast aluminum hub cap with dirt exclusion window & no side fill plug
Grease	347-4278	Cast aluminum hub cap with hubo window & no side fill plug
Grease	347-5096	Stamped steel hub cap with hubo mounting hole & vent
Grease	349-4009	Cast aluminum hub cap with Sentinel® Technology and no side fill plug
Grease	352-4009	Cast aluminum hub cap with solid top (duckbill vent) & no side fill plug
Grease	358-4009	Integrated Sentinel®

Bulk Hub Caps

STEMCO Part No.	Standard Part No.	Bulk Qty.	Gasket Number
300-4009	340-4009	25	330-3009-Included
303-4009	343-4009	25	330-3009-Included
300-5097	340-4009	25	330-3009-Included
300-4024	340-4024	25	330-3024-Included
303-4024	340-4024	25	330-3024-Included

Hub Cap Specifications

4075 Hub Cap Variations



340-4075



570-7008



340-4975

Application	Part Number	Description
Oil	340-4975	Clear polycarbonate hub cap
Oil	343-4075	Cast aluminum hub cap with side fill plug
Oil	343-4371	Cast aluminum hub cap with PSI face & side fill plug
Oil	347-4075	Cast aluminum hub cap with hubo window and side fill plug
Oil	348-4075	Cast aluminum hub cap with Sentinel® Technology & side fill plug
Oil	353-4075	Cast aluminum hub cap with Sentinel® ESP plug & side fill plug
Oil	356-4075	Integrated Sentinel®
Grease/Oil	340-4075	Cast aluminum hub cap & no side fill plug
Grease	342-4075	Cast aluminum hub cap with dirt exclusion window
Grease	340-4320	Solid cast aluminum hub cap & no side fill plug
Grease	340-4371	Cast aluminum hub cap with PSI face & no side fill plug
Grease	340-4976	Clear polycarbonate hub cap with solid face—no vent
Grease	347-4343	Cast aluminum hub cap with hubo window and no side fill plug
Grease	349-4075	Cast aluminum hub cap with Sentinel® Technology & no side fill plug
Grease	350-4075	Cast aluminum hub cap with Sentinel® ESP & no side fill plug
Grease	358-4075	Integrated Sentinel®

Screw-on Caps must have O-rings (330-3077).
Use 570-7008 tool to tighten pro-par hub caps.

Hubodometer® Hub Caps

Hub Cap Includes Gasket	Gasket Part No.	Bolt Circle Diameter	Number Of Holes	Bolt Diameter	Aluminum Equivalent
640-0001*	641-0005	5-1/2	6	5/16	347-4009
640-0002*	641-0017	5-1/2	5	5/16	347-4013
640-0003*	330-3077	6-1/4 x 8 UN(M)			347-4075

* Vented



640-0001



640-0003

Accessories

Description	Part No.
1-Pipe plug with O-ring	641-0001
2-Supporting hub cap flange 6 hole	641-0003

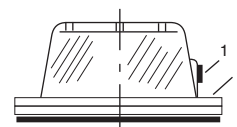

Hub Cap Specifications

Popular Hub Cap Options with Bolt Specifications

	STEMCO Base Part Number	Standard Hub Cap, No Side Fill	Dirt Exclusion, Grease	Standard Hub Cap, Side Fill	Standard Hub Cap, Hubo Window	Sentinel® Hub Cap	Sentinel® Hub Cap Grease	Solid Aluminum Grease/Vented	Integrated Sentinel® Oil	Integrated Sentinel® Grease	Bolt Circle	Bolt Size	Number of Bolts
	340	342	343	347	348	349	352	356	358				
4009	X	X	X	X	X	X	X	X	X	5-1/2	5/16	6	
4013	X	X	X	X	X	X	X	X	X	5-1/2	5/16	5	
4024	X	X	X					X	X	4-1/2	5/16	6	
4046	X		X		X	X		X	X	5-1/2	5/16	6	
4075	X	X	X	X	X	X		X	X	6-1/4 x 8 UN(M)			
4095	X	X	X		X	X	X	X	X	6	3/8	6	
4195	X	X	X	X	X	X	X	X	X	6-3/4	5/16	6	
4249	X	X	X							5-1/2	5/16	6	
4281					X	X				5-17/32	3/8	6	
4370*	X		X							5-1/2	5/16	6	
4371*	X		X							6-1/4 x 8 UN(M)			
4372*	X		X							6-3/4	5/16	6	

*PSI Hub Cap

Hub Cap Crossover

Competitive Part No.	Competitor's Name	STEMCO Part No.	Competitive Part No.	Competitor's Name	STEMCO Part No.	Competitive Part No.	Competitor's Name	STEMCO Part No.
1282	C/R	340-4975	401911P	Mechanex/Barrier	340-4975	DG-6F4.5	Dual Dynamics	340-4024
1612	C/R	343-4024	506085	Eaton	343-4024	DG-6F4.5P	Dual Dynamics	343-4013
1623	C/R	343-4066	506089	Eaton	343-4249	DG-6F4.5PC	Dual Dynamics	343-4024
1627	C/R	343-4019	64002	TriSeal	343-4019	DG-6F4.5S	Dual Dynamics	347-4075
1642	C/R	343-4013	64009	TriSeal	343-4009	DG-6FL	Dual Dynamics	340-4249
1643	C/R	343-4249	64009H	TriSeal	347-4009	DG-6FP	Dual Dynamics	347-4009
1665	C/R	343-4042	64013	TriSeal	343-4013	DG-6FPC	Dual Dynamics	340-4024
1681	C/R	343-4186	64024	TriSeal	343-4024	DG-6P	Dual Dynamics	340-4009
1682	C/R	343-4075	64029	TriSeal	343-4186	DG-6PS	Dual Dynamics	343-4009
1696	C/R	343-4195	64034	TriSeal	343-4034	DG-6PSC	Dual Dynamics	340-4046
1703	C/R	343-4249	64042	TriSeal	343-4042	DG-7.5P	Dual Dynamics	340-4195
1711	C/R	343-4024	64046	TriSeal	343-4046	DG-7.5PS	Dual Dynamics	343-4195
1723	C/R	343-4066	64046	TriSeal	343-4095	DG-P	Dual Dynamics	340-4075
1727	C/R	343-4019	64046	TriSeal	343-4249	DG-PS	Dual Dynamics	343-4075
1742	C/R	343-4013	64066	TriSeal	343-4066	DG-PSC	Dual Dynamics	343-4249
1743	C/R	343-4009	64075A	TriSeal	343-4075	H075	National	343-4075
1743	C/R	343-4046	64075G	TriSeal	342-4075	HS1643	Mechanex/Barrier	343-4249
1743	C/R	343-4095	64075P	TriSeal	340-4975	HU009A	National	343-4009
1753	C/R	343-4249	64249	TriSeal	343-4249	HU009A	National	343-4046
1765	C/R	343-4042	812928	Eaton	343-4095	HU013A	National	343-4013
1770	C/R	343-4034	815214	Eaton	343-4195	HU019A	National	343-4019
1781	C/R	343-4186	821338	Eaton	343-4009	HU024A	National	343-4024
1788	C/R	343-4249	821907	Eaton	343-4009	HU028A	National	343-4186
1800	C/R	347-4009	C40-4009	C/R	340-4009	HU034A	National	343-4034
1801	C/R	347-4013	C40-4009BP	C/R	300-4009	HU042A	National	343-4042
1811	C/R	343-4024	C40-4975	C/R	340-4975	HU066A	National	343-4066
1823	C/R	343-4042	C40-4975BP	C/R	340-4975	HU110A	National	343-4095
1842	C/R	343-4013	C40-5097BP	C/R	340-5097	HU110A	National	343-4249
1843	C/R	343-4009	C43-4009	C/R	343-4009	P411601	Mechanex/Barrier	343-4009
1843	C/R	343-4046	C43-4009BP	C/R	303-4009	P411605	Mechanex/Barrier	343-4095
1843	C/R	343-4095	C43-4013	C/R	343-4013	P411605	Mechanex/Barrier	343-4249
1865	C/R	343-4066	C43-4024	C/R	343-4024	P411608	Mechanex/Barrier	343-4013
1870	C/R	343-4034	C43-4042	C/R	343-4042	P411620	Mechanex/Barrier	343-4066
1890	C/R	343-4249	C43-4075	C/R	343-4075	P411622	Mechanex/Barrier	343-4042
340-009	National	340-4009	C43-4095	C/R	343-4095	P411629	Mechanex/Barrier	343-4186
340-009BK	National	300-4009	C43-4098	C/R	343-4098	P411630	Mechanex/Barrier	343-4024
340-975	National	340-4975	C43-4249	C/R	343-4249	P411640	Mechanex/Barrier	343-4034
340-975BK	National	340-4975	DG-5/6P	Dual Dynamics	340-4013	P411655	Mechanex/Barrier	343-4075
343-009	National	343-4009	DG-5/6PS	Dual Dynamics	343-4013	P411688	Mechanex/Barrier	343-4095
343-009BK	National	303-4009	DG-6F	Dual Dynamics	340-4046	P411967	Mechanex/Barrier	343-4046

PROGRAMMABLE FOR ANY TIRE SIZE



DataTrac® Pro
Shown Actual Size

Program over 2500 specific tire models and sizes ensuring customer gets reliable mileage information.



Always Have The Part Number

Stock only one part number with the programmable DataTrac® Pro and program the customer's specific requirement for any tire. With DataTrac® Pro you can also pre-set your own mileage and eliminate lead-time and pre-set charges.

Schedule Maintenance

The DataTrac® Pro is an indispensable tool for scheduling maintenance based on actual mileage rather than time.

Large, Easy-to-Read LCD Display

The display makes data retrieval simple and accurate. Optional flexibility of trip and life readings for precise data collection and management. Numbers automatically position upright for easy verification of mileage.

Compact Size

The compact size makes it easy to mount and dismount tires without removing the DataTrac® Pro from the wheel.

No Moving Parts

Provides improved reliability and durability for the most demanding vocational applications. Each unit is marked with a unique serial number providing additional security and data control.

DATA TRAC® PRO

AN INDISPENSABLE TOOL FOR...

- Scheduling maintenance
- Validating guarantees
- Determining lease charges
- Calculating costs-per-mile



Tire Make	Tire Model	Tire Size	STEMCO Mechanical Hubo Miles / KM	Veeder-root P/N miles / KM	DataTrac® Pro Miles/KM	*DataTrac® Pro REV - Mile/KM
Bridgestone	M726	11R22.5	650-0598/ 650-0537	777717-494/ 777727-306	600-5499/ 600-4310	499 / 310
Bridgestone	M726	11R24.5	650-0584/ 650-0528	777717-475/ 777727-294	600-5476/ 600-4296	476 / 296
Bridgestone	M726	255/70R22.5	650-0622/ 650-0549	777717-572/ 777727-350	600-5564/ 600-4351	564 / 351
Bridgestone	M726	285/75R24.5	650-0595/ 650-0537	777717-494/ 777727-306	600-5499/ 600-4310	499 / 310
Bridgestone	M726	295/75R22.5	650-0605/ 650-0541	777717-510/ 777727-316	600-5514/ 600-4320	514 / 320
Bridgestone	R194	11R22.5	650-0605/ 650-0541	777717-514/ 777727-316	600-5513/ 600-4319	513 / 319
Bridgestone	R194	11R24.5	650-0593/ 650-0534	777717-490/ 777727-306	600-5489/ 600-4304	489 / 304
Bridgestone	R194	255/70R22.5	650-0627/ 650-0552	777717-572/ 777727-359	600-5580/ 600-4361	580 / 361
Bridgestone	R194	285/75R24.5	650-0605/ 650-0541	777717-514/ 777727-316	600-5513/ 600-4319	513 / 319
Bridgestone	R194	295/75R22.5	650-0612/ 650-0545	777717-525/ 777727-326	600-5529/ 600-4328	529 / 328
GoodYear	G104	255/70R22.5	650-0627/ 650-0552	777717-572/ 777727-359	600-5579/ 600-4360	579 / 360
GoodYear	G124	11R22.5	650-0601/ 650-0537	777717-500/ 777727-310	600-5505/ 600-4314	505 / 314
GoodYear	G124	255/70R22.5	650-0626/ 650-0549	777717-572/ 777727-359	600-5572/ 600-4356	572 / 356
GoodYear	G167	11R22.5	650-0598/ 650-0537	777717-500/ 777727-310	600-5501/ 600-4311	501 / 311
GoodYear	G167	295/75R22.5	650-0605/ 650-0541	777717-514/ 777727-326	600-5515/ 600-4320	515 / 320
GoodYear	G314	11R22.5	650-0605/ 650-0541	777717-510/ 777727-312	600-5512/ 600-4318	512 / 318
GoodYear	G314	11R24.5	650-0593/ 650-0534	777717-484/ 777727-300	600-5488/ 600-4303	488 / 303
GoodYear	G314	285/75R24.5	650-0605/ 650-0541	777717-510/ 777727-316	600-5514/ 600-4320	514 / 320
GoodYear	G314	295/75R22.5	650-0613/ 650-0545	777717-520/ 777727-326	600-5529/ 600-4328	529 / 328
GoodYear	G362	11R24.5	650-0584/ 650-0528	777717-475/ 777727-300	600-5478/ 600-4297	478 / 297
GoodYear	G362	285/75R24.5	650-0598/ 650-0537	777717-500/ 777727-310	600-5501/ 600-4311	501 / 311
GoodYear	G362	295/75R22.5	650-0605/ 650-0541	777717-514/ 777727-326	600-5515/ 600-4320	515 / 320
GoodYear	G372	11R24.5	650-0584/ 650-0528	777717-475/ 777727-297	600-5476/ 600-4296	476 / 296
GoodYear	G372	285/75R24.5	650-0598/ 650-0537	777717-494/ 777727-310	600-5497/ 600-4309	497 / 309
GoodYear	G372	295/75R22.5	650-0605/ 650-0541	777717-510/ 777727-316	600-5512/ 600-4318	512 / 318
Michelin	XDA2	11R22.5	650-0598/ 650-0537	777717-500/ 777727-310	600-5502/ 600-4312	502 / 312
Michelin	XDA2	11R24.5	650-0587/ 650-0528	777717-475/ 777727-294	600-5480/ 600-4298	480 / 298
Michelin	XDA2	255/70R22.5	650-0625/ 650-0549	777717-572/ 777727-350	600-5566/ 600-4352	566 / 352
Michelin	XDA2	275/80R22.5	650-0605/ 650-0541	777717-510/ 777727-326	600-5519/ 600-4323	519 / 323
Michelin	XDA2	275/80R24.5	650-0598/ 650-0537	777717-500/ 777727-310	600-5502/ 600-4312	502 / 312
Michelin	XZA2	11R22.5	650-0601/ 650-0539	777717-510/ 777727-316	600-5510/ 600-4317	510 / 317
Michelin	XZA2	11R24.5	650-0591/ 650-0532	777717-484/ 777727-300	600-5485/ 600-4302	485 / 302
Michelin	XZA2	275/80R22.5	650-0610/ 650-0545	777717-520/ 777727-326	600-5526/ 600-4327	526 / 327
Michelin	XZA2	275/80R24.5	650-0601/ 650-0539	777717-510/ 777727-316	600-5509/ 600-4316	509 / 316
Michelin	XZE	255/70R22.5	650-0626/ 650-0549	777717-572/ 777727-359	600-5574/ 600-4357	574 / 357

Order Yours Today!

Product	Part No.
DataTrac® Pro	600-9999
Programmer	801-6000

Calibration and Installation

STEMCO calibrations are based at the mid-life of the tire tread (not the depth of new tire tread), one more reason we can guarantee +/- 2% accuracy over the life of the tire.

For proper calibration, all you need to know is the tire make, model and size. Refer to the chart for some of the most popular tires.

Hub caps, hub cap mounts, and universal brackets are available for all popular makes and models. For quick and easy installation, use any of three different options: (1) aluminum hub cap with hubo window, (2) grilamid Hubodometer hub cap or (3) bracket.

Warranty

STEMCO DataTrac® Pro is warranted for 500,000 miles or 4 years, when installed in accordance with its specifications.

* Indicates the Revolutions per mile or Kilometer used to program the DataTrac® Pro from the Program Part screen.

* If you have a DataTrac® p/n 600-1xxx for miles and 600-0xxx for kilometers, the unit contains trip. Follow conversion from DataTrac® in the table above.

* Mechanical hubodometers are designated for use in a "range" of RPM or RPK, not a "specific" RPM or RPK. For "exact" Revolutions use DataTrac® Pro.



RELIABLE MILEAGE INFORMATION WITH GUARANTEED ACCURACY

HUBODOMETER®



STEMCO's drive-less Hubodometer® offers road-proven accuracy backed by a 500,000 mile warranty.

An Indispensable Tool

The STEMCO Hubodometer® is an indispensable tool for scheduling maintenance, determining lease charges, validating guarantees, and calculating costs per mile.

Reliable Mileage Information

Hubodometers® are calibrated to perform on over 2,500 specific tire models and sizes to further ensure reliable mileage information.

Spring-loaded Counterweight

Virtually eliminates spin when tires hit bumps and potholes, your assurance of greater accuracy.

Preset Your Hubodometer®

STEMCO will preset your Hubodometer® with the mileage data you require for a nominal charge. Allow 3 days for shipping.

500,000 Mile Warranty

Guaranteed over-life-of-tire accuracy backed by 500,000 mile warranty



A Higher Standard of Performance.™
an EnPro Industries company

HUBODOMETER®

GUARANTEED ACCURACY

STEMCO®
A Higher Standard of Performance.™
an EnPro Industries company

CONSTRUCTION AND DESIGN

- Main shaft is independent of front cover, greatly reducing failure caused by frontal impact.
- Unit is sealed for added durability in a moisture-controlled environment of polycarbonate and steel.
- Externally pinioned odometer mechanism utilizes low-friction molded components. These features, plus nine permanently lubricated bronze bearings, eliminate wear and ensure long life.
- Worm drive rotates parts less frequently, reducing wear.
- Rugged construction. Naval brass on steel. No plastic drive components.

SUPERIOR DESIGN GUARANTEES ±2% ACCURACY

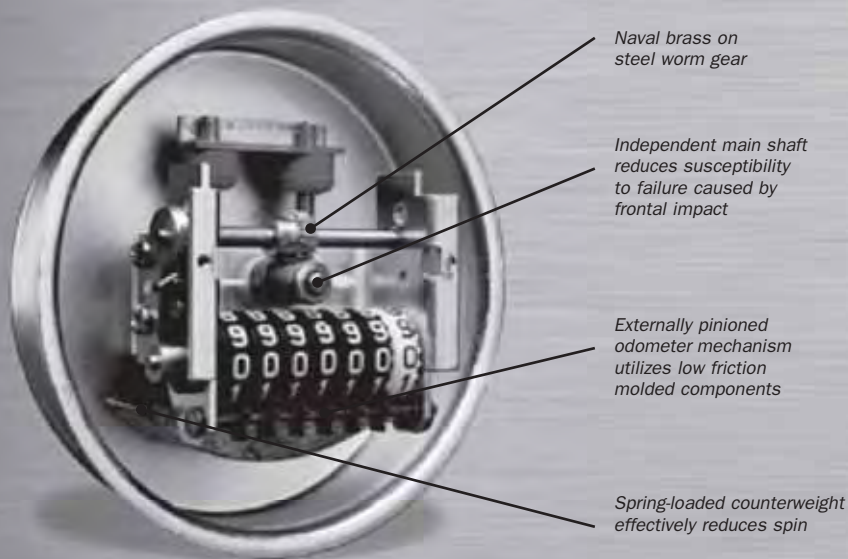

CALIBRATION AND INSTALLATION

To ensure accurate calibration, we've worked with the engineering staffs of all major tire manufacturers. We have compiled fleet data on more than 2,500 tire models and sizes.

In addition, STEMCO calibrations are based at the mid-life of tire tread (not the depth of new tire tread), one more reason we can guarantee ±2% accuracy over the life of the tire.

For proper calibration of any STEMCO Hubodometer®, all you need to know is tire make, model and size. With this information and our Tire Classification catalog (which includes radials and low-profile tires), you can quickly determine the part number for the correct Hubodometer®.

STEMCO offers a pre-set Hubodometer® program at a nominal cost. Pre-set orders are shipped within 3 working days from the Longview, Texas warehouse. For more information, contact STEMCO Customer Service.

Hub caps, hub cap mounts and universal brackets are available for all popular makes and models. For quick and easy installation, use any of three different options: (1) aluminum hub cap with hubo window, (2) grilamid Hubodometer® hub cap or (3) bracket.

WARRANTY

The STEMCO Hubodometer® is warranted for 500,000 miles when installed in accordance with its specifications. See your STEMCO distributor for details.



347-Series
Aluminum Hub cap with Hubo Window



640-Series
Grilamid Hubodometer® Hub Cap



610-Series
Bracket Installation

TQM™
TOTAL QUALITY MAINTENANCE™

Hubodometer® Mounts

Popular Hubodometers® (in popularity order)



Part Number	RPM	Blank Tenths Part Number	Part Number	RPKM
650-0610	522	650-0611	650-0537	310
650-0598	500	650-0600	650-0532	300
650-0613	532	650-0614	650-0539	315
650-0601	504	650-0602	650-0545	324
650-0605	513	650-0606	650-0541	320
650-0587	480	650-0588	650-0549	357

Hubodometer® Brackets

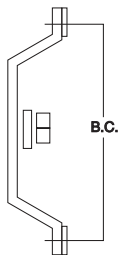

Style A

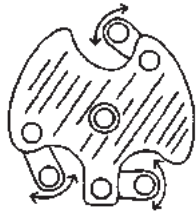

Style C

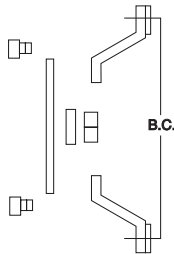

Universal Mount

Part Number	Bolt Circle	Stud Size	Height	Part Number	Style
6100001	5 1/4	1/2	1 11/16		A
6100002	5 1/2	5/8	1 11/16		A
6100003	6 3/8 – 6 1/2	1/2 – 9/16	1 11/16		A
6100005	7 1/4	9/16	1 11/16		A
6100006	7	5/8	1 11/16		A
6100007	7	5/8	1 11/16		A
6100008	7 1/2	5/8	1 9/16		A
6100009	7 1/2	5/8	3 11/16		A
6100010	8 5/8	5/8	5 7/16	Mack Mount	A
6100011	5 1/2 – 7 1/2	1/2	1 3/4	Universal Truck Mount	
6100013	5 1/2	7/16	1/4		A
6100014	7 5/8	5/8	4 3/8		A
6100015	2 1/2 – 6 1/2	9/16	1 1/8	Car Mount (5 Stud)	C
6100016	2 1/2 – 6 1/2	5/16 .343	1 1/8	Universal Truck Mount (5 Stud)	C
6100017	5 7/32	5/8	1 11/16		A
6100022	3 9/16	1/2	1/2	Strap and Lock Assembly	
6100023	3 15/16	1/2	1		A
6100024	5 1/2	5/16 – 18 thd	4 1/2	Hardware for Berg Cap	
6100025	4 1/2 – 9	3/16	1 11/16	TMK-90 Truck Mount	
6100028	5 1/2	5/16	5	Sentinel and PSI Caps – 3 Leg	
6100029	6 3/4	5/16	6	Sentinel, PSI, AirGo Caps – 3 Leg	
6100032	7 1/4	9/16	1 1/2		A
6100058	6 1/2	1/2	4 1/2		A
6100059	4	9/16	1 1/2	For Golf Carts	A
6100065	5 1/2	5/16	3 1/2	Fits 4009 Hubcap	A
6100066	6 1/2	5/8	5 1/4		A
6100079	7 1/4	3/4	1 11/16		A
6100084	6 3/4	5/16	5	Sentinel and PSI Caps – 3 Leg, f/4195	
6100085	5 1/2	5/16	4	PSI Caps	A
6100090	N/A	N/A	N/A	Mounts on Top of Window Ring	
6100093	262 mm (10.31")	M10	N/A	Meritor Planetary Axle-DTrac Only	
6100094	246 mm (9.70")	M10	N/A	MAN Planetary Axle-DTrac Only	
6410023	N/A	N/A	N/A	Refurb Kit f/MAN Bracket	

Hubodometer® Hub Caps - For Trailer Installations



640-0001



640-0003

Hub cap Includes Gasket	Gasket Part No.	Bolt Circle Diameter	Number of Holes	Bolt Diameter	Aluminum Equivalent
640-0001*	641-0005	5-1/2	6	5/16	347-4009
640-0002*	641-0017	5-1/2	5	5/16	347-4013
640-0003*	330-3077	6-1/4 x 8 UN(M)			347-4075

* Vented

STEMCO®

AXLE NUTS

ADVANCED AXLE SPINDLE NUTS

PRO-TORQ®



Longer Tread Life

Fleets save tires, wheels track truer. PRO-TORQ® controls axial motion, holding bearing end play near zero while maintaining exact cup and cone alignment on the spindle. This is good news for radial tires. PRO-TORQ® delivers the adjustment precision which experts agree is needed to maximize radial tire life.

Extended Wheel Seal and Bearing Service

PRO-TORQ® supports seal, bearing and axle manufacturers' specifications. With PRO-TORQ's® tight control on wheel bearing adjustment, fleets minimize premature seal failure and improve extended seal and brake lining programs. PRO-TORQ® compensates for normal bearing wear, permitting precise .001" back-off increments at scheduled preventative maintenance intervals. This keeps bearings properly aligned, running cooler and lasting longer.

Improves ABS

PRO-TORQ's® reliable low end play bearing adjustment and axial motion control helps assure accurate wheel end sensor monitoring of wheel speeds on antilock braking systems.

STEMCO®
A Higher Standard of Performance.™
an EnPro Industries company

PRO-TORQ®

Advanced Axle Spindle Nuts



STEMCO®
A Higher Standard of Performance.™
an EnPro Industries company

SPINDLE NUT APPLICATIONS	REPLACEMENT KEEPER PART NUMBER	THREAD SIZE	OUTER BEARING CONE/CUP	TOOL SOCKET
TRAILER AXLE				
STEMCO No. 447-4723 Fruehauf Pro-par, Meritor TP *Axle date code post January 1, 2006	450-4723 TANG	3.480"-12	HM518445/ HM518410	4 13/16"- 8 point (OTC# 1941)
STEMCO No. 447-4724 22,500#-23,000# Eaton, EST 230-P, EST 225-P, P-22	450-4723 TANG	3 1/2"-12	HM518445/ HM518410	4 13/16"- 8 point (OTC# 1941)
STEMCO No. 447-4743 17,000#-22,500# Meritor, Dana, Eaton, Std Forge, Ingersoll	450-4743 TANG	2 5/8"-16	HM212049/ HM212011	3 3/4"- 8 point (OTC# 1925)
STEER AXLE				
STEMCO No. 448-4836 12,000# Meritor, Navistar	450-4836 D-FLAT	1 1/2"-12	3782/3720	2 1/2"- 6 point (OTC# 1921)
STEMCO No. 448-4837 12,000# Eaton, Ford, Meritor	450-4837 TANG	1 1/2"-18	3782/3720	2 1/2"- 6 point (OTC# 1921)
STEMCO No. 448-4838 Meritor	450-4837 TANG	1 1/2"-12	3782/3720	2 1/2"- 6 point (OTC# 1921)
STEMCO No. 448-4839 12,000#, 14,300# Mack	450-4839 D-FLAT	1 5/8"-12	45280/45220	2 5/8"- 6 point (OTC# 1922)
STEMCO No: 448-4840 Steer Spindle	450-4836 D-FLAT	1 1/2"-18	3782/3720	2 1/2"-6 point (OTC# 1921)
STEMCO No: 448-4863 ArvinMeritor® FH Axle 16,500# GAW	450-4863 D-FLAT	2 1/4"-12	N/A	3 1/2"- 6 point (OTC# 1910)
STEMCO No. 448-4864 18,000#, 20,000# Mack	450-4864 D-FLAT	2"-12	555S/552A	3"- 6 point (OTC# 1906)
STEMCO No. 448-4865 Meritor FL Series	450-4865 D-FLAT	1 3/4"-12	555S/552A 3720/3979	3"- 6 point (OTC# 1906)
DRIVE AXLE				
STEMCO No. 449-4904 34,000#, 38,000#, 44,000# Mack	450-4904 TANG	2 7/8"-12	47679/47620 575/572 567/563	4 1/8"- 6 point (OTC# 1915)
STEMCO No. 449-4973 34,000#-46,000# Eaton, Meritor, Dana, Navistar, 50,000# Mack	450-4973 TANG	3 1/4"-12	580/572	4 3/8"- 8 point (OTC# 1917)
STEMCO No. 449-4974 Meritor, Eaton, Ford, Navistar	450-4743 TANG	2 5/8"-12	3984/3920 39590/39520	3 3/4"- 8 point (OTC# 1925)
STEMCO No. 449-4975 19,000# Dana, Navistar, Bluebird	450-4975 TANG	2 5/8"-12	3984/3920 39590/39520	3 3/4"- 8 point (OTC# 1925)

Cost Saving Installation

For more than 10 years, leading fleets have chosen PRO-TORQ® to deliver the longer service life they expect from today's tires, wheel seals and bearings. PRO-TORQ® minimizes variability in wheel bearing adjustment, which means extended maintenance intervals and trouble-free performance from steer, drive and trailer axle wheel ends.

Tight Control on Bearing Adjustment

PRO-TORQ® gives fleets the ability to standardize wheel end maintenance practices and makes repeatable, close tolerance bearing adjustment a reality. From mechanic to mechanic, PRO-TORQ® single nut systems and adjustment procedure will consistently secure the nut with wheel bearing adjustment accuracy in the range of .001-.003" end play.

PRO-TORQ® avoids the extremes of both preload and excessive bearing end play. It gives fleets the tightest adjustment standard in the industry.

Faster to Install, Easier to Lock

PRO-TORQ® assures that bearings are "positive" locked in precise position the first time. That's because PRO-TORQ® uses only one nut – no jamming, juggling or time wasted while repositioning multiple nut assemblies.

Clearance in the threads of traditional "jamming" type nuts can result in a wide range of final settings. A mechanic can unintentionally impose preload on a bearing by overtightening the jamnut. As a result, the outer bearing cone can be pushed further up the spindle and out of its intended position.

PRO-TORQ® takes the guesswork out of bearing adjustment!

Good Wear Resistance

Bearing contact surface is induction hardened. No washers required.

Flat Contact Surface

Improves wheel bearing cup and cone alignment.

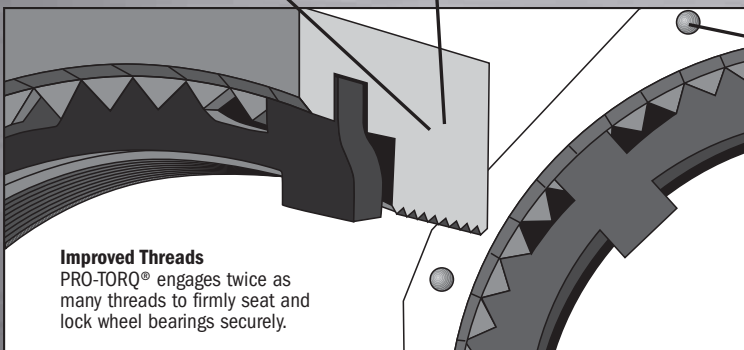

Improved Threads

PRO-TORQ® engages twice as many threads to firmly seat and lock wheel bearings securely.

Highly Visible Adjustment Marks

Give mechanics precise control of nut backoff amount during installation.

Infinite Locking Positions

Nut and spring steel keeper mate and lock at any point on the axle spindle in .001" axial increments.

Pro-Torq® Trailer Axle Nuts

Applications and Specifications

STEMCO Part Number

447-4723

Replacement Keeper No.: 450-4723 TANG
Tool Socket: 4 13/16" - 8 point (OTC# 1941)
Thread Size: 3.480" - 12
Outer Bearing Part No.: HM518445/HM518410

FRUEHAUF AXLES

PROPAR Series

HENDRICKSON AXLES

HP

INGERSOLL AXLES

F24H

MERITOR AXLES

TP Series

STEMCO Part Number

447-4724

Replacement Keeper No.: 450-4723 TANG
Tool Socket: 4 13/16" - 8 point (OTC# 1941)
Thread Size: 3 1/2" - 12
Outer Bearing Part No.: HM518445/HM518410

EATON AXLES

EST 230-P, EST 225-P

STEMCO Part Number

447-4743

Replacement Keeper No.: 450-4743 TANG
Tool Socket: 3 3/4" - 8 point (OTC# 1925)
Thread Size: 2 5/8" - 16
Outer Bearing Part No.: HM212049/HM212011

DANA SPICER AXLES

D-20, D-21, D-22, DD-21, DD-22, K-21, K-22, K-25, K-30

EATON AXLES

C, C2, CD, CD2, CE, ESA-225J, EST, EST-225J, EST-230J, ETA 230C, ETA 225D, ETA 225J, H23L, H25R, HCE, HJ, HJE, J, JE, JH, LA-15, T-18C, 20L-77, 22L, 22R, 23L, 23R, 25R

HENDRICKSON AXLES

HN

INGERSOLL AXLES

A22T

MERITOR AXLES

RL Series, RQ Series, TK Series, TKL Series, TKLD Series, TL Series, TLD Series, TN Series, TND Series, TQ Series, TQC Series, TQD Series

STANDARD FORGE

A25, A26, 17,000 and 18,000 lb. Trade

STEMCO Part Number

448-4836

Replacement Keeper No.: 450-4836
Tool Socket: 2 1/2" - 6 point (OTC# 1921)
Thread Size: 1 1/2" - 12
Outer Bearing Part No.: 3782/3720

DANA SPICER AXLES

D10

EATON AXLES

X-115

FRUEHAUF AXLES

Model 5, TKF

MERITOR AXLES

T-1100

STANDARD FORGE

T 8.5-S

Pro-Torq® Steer Axle Nuts

Applications and Specifications

STEMCO Part Number

448-4836

Replacement Keeper No.: 450-4836 D-FLAT
Tool Socket: 2 1/2" - 6 point (OTC# 1921)
Thread Size: 1 1/2" - 12
Outer Bearing Part No.: 3782/3720

MERITOR AXLES

FD 900, FD 901, FD 961, FE 900, FE 903, FF 900, FF 901, FF 921, FF 931, FF 932, FF 933, FF 941, FF 942, FF 943, FF 944, FF 952, FF 961, FG 941

NAVISTAR

I100S

STEMCO Part Number

448-4837

Replacement Keeper No.: 450-4837 TANG
Tool Socket: 2 1/2" - 6 point (OTC# 1921)
Thread Size: 1 1/2" - 18
Outer Bearing Part No.: 3782/3720

EATON AXLES

EFA-12F4, EFA-13F5, E-1200I, FE 931, 12K, 13.2K

FORD AXLES

SIFCO 12,000#, FORD 6,000#

MERITOR AXLES

FE-931

STEMCO Part Number

448-4838

Replacement Keeper No.: 450-4837 TANG
Tool Socket: 2 1/2" - 6 point (OTC# 1921)
Thread Size: 1 1/2" - 12
Outer Bearing Part No.: 3782/3720

MERITOR AXLES

Steer

* Refer to installation instructions for part number 448-4836.

STEMCO Part Number

448-4839

Replacement Keeper No.: 450-4839 D-FLAT
Tool Socket: 2 5/8" - 6 point (OTC# 1922)
Thread Size: 1 5/8" - 12
Outer Bearing Part No.: 45220/45280

MACK FRONT AXLES

FAW12, FAW12, FAW537, FAW5371, FAW14.3, FAW538, FAW10.5, FAW536, FAW5361

STEMCO Part Number

448-4840

Replacement Keeper No.: 450-4836 D-FLAT
Tool Socket: 2 1/2" - 6 point (OTC# 1921)
Thread Size: 1 1/2" - 18
Outer Bearing Part No.: 3782/3720

HENDRICKSON AUXILIARY AXLE

13,000# Ultra Axle

STEMCO Part Number

448-4863

Replacement Keeper No.: 450-4863 D-Flat
Tool Socket: 3 1/2" - 6 point (OTC# 1910)
Thread Size: 2 1/4" - 12

ARVINMERITOR® FH AXLE

Steering Spindle
16,500 lbs GAW

STEMCO Part Number

448-4864

Replacement Keeper No.: 450-4864 D-FLAT
Tool Socket: 3" - 6 point (OTC# 1906)
Thread Size: 2" - 12
Outer Bearing Part No.: 5552A/5555

MACK FRONT AXLES

FA18, FAW18, FAW616, FA616, FA20, FAW20, FAW617, FA617, FAW16, FAW614

STEMCO Part Number

448-4865

Replacement Keeper No.: 450-4865 D-FLAT
Tool Socket: 3" - 6 point (OTC# 1906)
Thread Size: 1 3/4" - 12
Outer Bearing Part No.: 5552A/5555, 3979/3720

MERITOR FRONT AXLES

FL

Pro-Torq® Drive Axle Nuts

Applications and Specifications

STEMCO Part Number

447-4743

Replacement Keeper No.: 450-4743
 Tool Socket: 3 3/4" - 8 point (OTC# 1925)
 Thread Size: 2 5/8" - 16
 Outer Bearing Part No.: HM212049/HM212011

MERITOR AXLES

F Series, H Series

STEMCO Part Number

449-4904

Replacement Keeper No.: 450-4904 TANG
 Tool Socket: 4 1/8" - 8 point (OTC# 1917)
 Thread Size: 2 7/8" - 12
 Outer Bearing Part No.: 563/567, 572/575, 47620/47679

MACK AXLES

S-34, S-38, S-44, S-462, SW-56, SW-57, SW-441

STEMCO Part Number

449-4973

Replacement Keeper No.: 450-4973 TANG
 Tool Socket: 4 3/8" - 8 point (OTC# 1917)
 Thread Size: 3 1/4" - 12
 Outer Bearing Part No.: 580/572

DANA SPICER AXLES

W 230-S, W 460-S

EATON AXLES

D 380, D 381, D 380-P, D 381-P, D 400, D 401, D 400-P, D 440-P, D 401-P, D 402-P, D 451-P, D 460-P, D 480-P, D 485-P, DP 380, DP 381, DP 380-P, DP 381-P, DP 340, DP 341, DP 400-P, DP 401-P, DP 440-P, DP 460-P, DP 480-P, DP 550, DP 580-P, DP 650-P, DS 340, DS 341, DS 344, DS 380, DS 381, DS 380-P, DS 381-P, DS 400-P, DS 401-P, DS 404-P, DS 400-P, DS 460-P, DS 480-P, DS 454-P, DT 340, DT 341, DT 380, DT 381, DT 380-P, DT 381-P, DT 400-P, DT 440-P, DT 460-P, DT 480-P, RS 341, RS 381, RS 402, RS 401, RS 460, RS 461, RT 402, 44, 440P, 480P, 1911, 1919, 2011, 19500, 20500, 20501

MACK AXLES

50,000#

MERITOR AXLES

Q Series, QHD, QHR, QT Series, R Series, RL-170, RS Series, RT Series, S Series, S 170, S 280, SQ 100, SQ 100-P, SQD, SQDD, SQHD, SQHP, SQHR, SQR, SQW, SR 170, SR 270, SR 280, SRD, SRDD, SRHD, SSHD, SSHP, SP, STD, STDD, STHD, SU 170, SU 270, SU 280, SUHD, SW 170, SW 270, SW 280, T Series, U Series, 58000 Series, 59000 Series, 200

NAVISTAR AXLES

14227, 14308, 14309, 14311, 14338, 14342, 14943, 14348, 14364, 14368, 14494

STEMCO Part Number

449-4974

Replacement Keeper No.: 450-4743 TANG
 Tool Socket: 3 3/4" - 8 point (OTC# 1925)
 Thread Size: 2 5/8" - 12
 Outer Bearing Part No.: 3984/3920, 39590/39520

EATON AXLES

D, DT, 32M, 34M, MF, MR, RP, RT, 17800, 17801

FORD AXLES

18,000# Rear

MERITOR AXLES

H-145, H-162, H-172, H-240, H-262, H-350, H-362, L-172

NAVISTAR AXLES

14044, 14186, 14351, RA44

STEMCO Part Number

449-4975

Replacement Keeper No.: 450-4975 TANG
 Tool Socket: 3 3/4" - 8 point (OTC# 1925)
 Thread Size: 2 5/8" - 12
 Outer Bearing Part No.: 3984/3920, 39590/39520

DANA AXLES

J190S

FORD AXLES

GMC

NAVISTAR AXLES

REAR AXLE SCHOOL BUS APPLICATION

19,000#

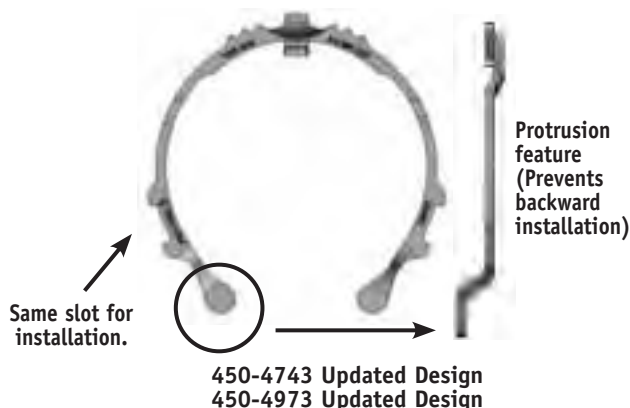

High Performance Brake Linings



HORIZON SP™ The value and performance choice for highway applications.

Horizon SP was specially designed to be a cost effective solution for your long-haul needs. Horizon SP is the standard performance friction formulation for normal-duty cycles, operating environments and loads.

Axle Rating: Horizon SP20 - 20,000 lbs. Horizon SP23 - 23,000 lbs.



CREST XL™ Extra life choice for demanding highway applications.

Whether you're driving an over-the-road truck, tractor or trailer, this unique brake lining is perfect for moderate to heavy-duty long-haul applications. Crest XL exceeds the performance of the competition in the same category due to its superior formulation combined with the Wave Process.

Axle rating: 20,000 lbs.



VISTA HP™ The high performance choice for demanding applications.

If you're looking for superior performance on buses, trucks, tractors or trailers, then look no further. Vista HP offers smooth, noise-free and stable stopping power over a wide range of temperature, pressure and speed variations. As a result, Vista HP high-performance brake linings are ideally suited for the rigors of stop-and-go service.

Axle Rating: Vista HP- 23,000 lbs. Vista HP1- 25,000 lbs.



ULTRA PEAK™ BRT Superior technology for bus, refuse and transit applications.

For maximum performance in bus, refuse and transit applications, choose Ultra Peak BRT. This high-quality brake lining has been specially formulated to run quieter and extend lining life and drum life with excellent flexural strength. Ultra Peak BRT has been FMVSS 121 rated up to 26,000 lbs. for transit platforms. In addition, extraordinary flexural strength eliminates the failure mode of friction cracking.

Axle Rating: 23,000 - 26,000 lbs.



ULTRA PEAK™ HH Superior performance for your heavy-haul truck.

Your heavy-haul truck demands superior performance. That's why we offer Ultra Peak HH. This lining was specifically designed for severe service. This combination set includes two heavy-duty premium high-temperature products. Ultra Peak HH has high thermal diffusivity and reduces noise.

Axle rating: 23,000 lbs.



ULTRA PEAK™ FT Outstanding performance for specialty applications.

For specialty applications where performance is key, Ultra Peak FT incorporates the finest raw materials and superior technology to assure maximum performance in the most severe transit and refuse environments. In addition, Ultra Peak FT offers extended brake life cycles and reduces noise.

Axle rating: 26,000 - 29,000 lbs.

CATCH THE WAVE.

Our patented and revolutionary "Wave Process" assures higher performance and a longer life along with a lower noise level. This patented technology begins with the cold mold cycle, which creates the unique wave pattern. Hot molding then forces the waves to condense under heat and pressure. Aligning the friction density into column structures assures less heat susceptibility, which results in quieter, longer lasting brakes.

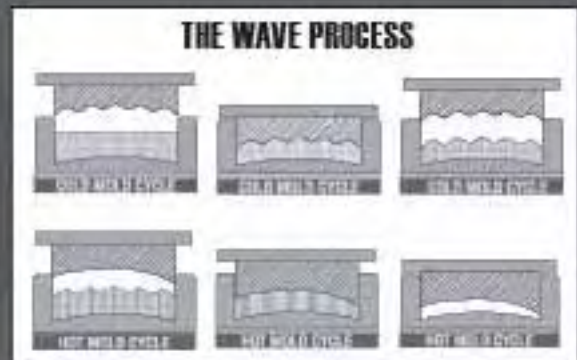

Friction Manufacturers Interchange

	20,000 lb. AXLE MATERIALS			23,000 lb. AXLE MATERIALS					25,000 – 29,000 lb. AXLE MATERIALS		
Manufacturer	Economy	Standard	Premium	Economy	Standard	Heavy Duty Premium	High Performance Long Life	Combination Block	Severe Service	Transit	Film Transfer
STEMCO DUROLINE™		Horizon SP20	Crest XL		Horizon SP23	Vista HP	Ultra Peak BRT	Ultra Peak HH	Vista HP1	Ultra Peak BRT (26K) Ultra Peak FT (29K)	Ultra Peak FT (29K)
Federal Mogul ABEX	XC6085 VL20	AN6166 XL6014	EN6008-1 EL6011	VL23	AX6149	EX685 SDA6098		SMC (685/6069)	ED6028 EH6040	Metro Combo 685/697 (26K)	
Affinia Brake Pro			CM16		CM18	CM20	CM22A1	CMB42	CM29	CMT22A1 (25K) CCM2425	CCM2429 (29K)
Carlisle	EC20 NA100	MB20	MB21 CF2000	EC23	MB44	MB23	WT56	MBC62	SD1 MB60	TG2 (26K) WT56 (26K)	
Cobreq	NABK334	NABK090	NABK102	NABK091	NABKC110			NABK171F	NABK132	NABK142 (26K) NABK110 (26K)	
Fras-le	F520 F540-1	F550-1		F523	F555-1	F557		F560/F555	F587	787T (28K) F557 (26K)	

STEMCO
DUROLINE™



HORIZON SP™ CREST XL™ VISTA HP™ ULTRA PEAK™

Private Label Reference

	20,000 lb. AXLE MATERIALS			23,000 lb. AXLE MATERIALS					25,000 – 29,000 lb. AXLE MATERIALS		
STEMCO DUROLINE™		Horizon SP20	Crest XL		Horizon SP23	Vista HP	Ultra Peak BRT	Ultra Peak HH	Vista HP1	Ultra Peak BRT (26K) Ultra Peak FT (29K)	Ultra Peak FT (29K)
Private Label	Economy	Standard	Premium	Economy	Standard	Heavy Duty Premium	High Performance Long Life	Combination Block	Severe Service	Transit	Film Transfer
ArvinMeritor	F520 F540 EG1	F550-1 MG1	MA210 MA212 R201	F523 EG2	F555-1 MG2L MG2	MA310 MA312 R301 F557		F560/F555-1	R403 F587	787T (28K) F557 (26K) R685/R687 (26K)	
Bendix/Spicer	GREEN	BLUE SILVER	ES310 ES410 ES420		RED YELLOW GOLD	ES600 ES690 ES440		ES1150	ES1050		
BRF/UAP		M20			M23						
Haldex	2017 (GN) HV77	2008 (GF)	2015-2 (GR) 2025 (GW) WEDGE	2016 (GD) HV88	2023 (GH)	2020-1 (GG)		2020-2035 (GC)	2035 (GZ) 2040 (GM) 2030 (GP)	TRANS MAX (TM)	
HD America	H20F	H20		H23F	H23						
Marathon	MH	UB	DB20		FLOE	HS		MBC	TS	HST (25K) KVT (26K) MBST (26K)	
Road Leveler	STD 20	PR20		STD 23	PR23						
VIPAR	VIPRO 20K STD	VIPRO 20K PREM		VIPRO 23K STD	VIRPO 203K PREM						

DataTrac® Pro Installation Instructions

HOW IT WORKS

DataTrac® Pro is an advanced mileage counter that relies on Earth's gravity for counting wheel revolutions. The DataTrac® Pro unit monitors its orientation to Earth's gravitational pull and uses this reference to recognize and count revolutions.

INSTALLING THE UNIT

In order to prevent inadvertent counting during shipment, a new DataTrac® Pro unit will be delivered in "Ship Mode." **To wake the device**, shake it vigorously for 4 seconds. The display will turn on and a timer will begin counting down. Install the DataTrac® Pro unit before the timer reaches zero (approximately 2 minutes). This will prevent counts induced by handling vibrations. **A unit should never be installed on a wheel without first waking it up.**

FOR FLEETS

To prevent premature wake up while repackaging, you cannot wake the device until 30 seconds after successfully programming it. The DataTrac® Pro can be programmed as many times as desired until the device is awakened by shaking it. Once the unit has been awakened the revolutions can not be changed.

READING THE DISPLAY

The display will turn on when the vehicle is at rest. Numbers will automatically orient to read upright. This is also indicated by the icon display, e.g. mile, km, acre. The mileage reading is always in the same direction as the icon.

In order to conserve power the display turns off at any time a vibration is detected. This means that the display will be off while the vehicle is moving. As soon as all vibration or motion stops the display will reactivate in about 5 seconds.

DISPLAY MODES

The DataTrac® Pro unit comes equipped with three display modes: LIFE and TRIP (if programmed), and REV. To toggle the display between LIFE, TRIP and REV Modes, use the palm of your hand to cover the round bubble on the face of the unit for at least 1 second, and then uncover it. If the unit is in bright sunlight, the bubble may have to be covered with your palm to block more light from reaching the sensor. TRIP mode is displayed with tenths resolution and is indicated by display of the TRIP icon (only if unit is programmed for TRIP).

To reset the TRIP display, toggle between LIFE, TRIP and REV Modes 5 times, quickly. Note that the unit cannot toggle faster than every 1.5 seconds. To view the revolutions of the unit simply repeat the process that is used to view trip and then a screen that shows (REV XXX) will show up. The XXX is the number of revolutions per KM or MILE that the unit is programmed for. On units without TRIP there are only two screens, all others have three screens (LIFE, TRIP, and REV). As with the TRIP mode the unit will return to the mileage after 10 seconds if left in the revolutions screen.

CERTIFICATIONS

This unit complies with European EMI (CE) regulations as noted on front cover by the E11 marking.

PRODUCT LIMITATIONS

It is important to note that this unit is designed to recognize vibrations and accelerations common to wheel rotation, therefore, it will not count accurately when held in a person's hand, which allows movement in any direction. Furthermore, this unit should not be used as a rotating shaft counter for machinery, unless the machine shaft rotates slower than 1250 RPM and has a slow acceleration profile similar to a wheel end. At all times the unit should rotate about an axis perpendicular to gravitational forces.

This unit contains a Lithium-Thionyl Chloride battery and should be disposed of according to local regulations. The battery contains less than 1 gram of lithium and is therefore classified as a non-hazardous product. Lithium-Thionyl Chloride batteries contain no poisonous materials and do not present environmental hazards when properly disposed of.



DATA TRAC® PRO INSTALLATION

Standard/Grit Guard® Seal Installation

STEP 1

Remove all burrs and thoroughly clean the spindle. Apply a thin layer of No. 2 sealant to the O.D. of the spindle shoulder. Place the axle ring on the spindle.

STEP 2

Using the recommended STEMCO Universal Axle Tool, drive the axle ring on until the tool bottoms against the spindle shoulder. Make certain the axle ring is flush with the shoulder. Wipe away any excess sealant.



STEP 3

Remove all burrs from the hub bore and thoroughly clean the entire wheel cavity.

STEP 4

With the wheel in the horizontal position, pre-lube the inner bearing and place it into the bearing cup. **NOTE:** When using grease, pre-pack the outer bearing before placement into the hub.



STEP 5

Apply a thin layer of No. 2 sealant to the O.D. of the seal and position the seal in the hub. Using the recommended STEMCO Universal Hub Tool, held in a vertical position, drive the seal into the seal bore until it is bottomed out. Check the clearance between the bearing cone and seal (at least 1/32nd is required).



STEP 6

With the wheel mounted on a dolly, carefully align the bore with the spindle. Gently push the wheel assembly onto the spindle to the proper position. Pre-lube the outer bearing and push it into the bearing cup.

NOTE: When using grease, pre-pack the inner bearing before placement into the hub.



STEP 7

Assemble the inner nut and tighten it to 200 ft. lbs. Rotate the wheel several times then back off nut one full turn. Make final bearing adjustment, according to TMC recommended bearing adjustment procedure. Install the appropriate axle fastener.

STEP 8

Install the hub cap with the new gasket and fill the cavity with lubricant to the proper level. On drive axles be sure the differential oil is high enough (manufacturer's recommended level) to ensure oil flow through the tube to the wheels. It is recommended to jack one side up and then the other until flow starts. Make certain the breather plug is clear. Recheck steers and trailers to ensure proper fill levels.

Guardian®/Guardian®HP Installation

STEP 1

Remove all burrs from the hub bore and spindle. Thoroughly clean the entire wheel cavity. Apply a thin layer of No. 2 sealant to the O.D. of the spindle shoulder. Place the seal assembly on the spindle so the words "OIL BEARING SIDE" are facing you. **WARNING: DO NOT INSTALL THE SEAL INTO THE HUB BORE.**



STEP 2

Using the recommended STEMCO Universal Axle Tool, drive the seal assembly on until the tool bottoms against the shoulder. Make sure the ring is flush with the axle shoulder. Wipe away any excess sealant.



STEP 3

Dip the inner bearing in oil and place on the spindle. Note: The O.D. of the seal must be coated with a thin coat of lubricant. **NOTE: When using grease, pre-pack the inner bearing before placement into the hub.**

STEP 4

With the wheel mounted on a wheel dolly, carefully push the wheel onto the spindle until it contacts the seal. Dip the outer bearing in oil and place it on the spindle. **NOTE: When using grease, pre-pack the outer bearing before placement into the hub.** Tighten the inner spindle nut hand tight and remove the wheel dolly.



STEP 5

Tighten the inner nut to 200 ft. lbs. Rotate the wheel several times then back off nut one full turn. Make final bearing adjustment, according to TMC recommended bearing adjustment procedure. Install the appropriate axle fastener.



STEP 6

Install the hub cap with a new gasket and fill the cavity with oil to the proper level. On drive axles be sure the differential oil level is high enough (manufacturer's recommended level) to ensure oil flow through the tube to the wheels. It is recommended to jack one side up and then the other until flow starts. Make certain the breather plug is clear. Recheck steers and trailers to ensure proper fill levels.

Voyager®/ Discover® Hub Seal Installation

STEP 1

Remove all burrs from hub bore and spindle. Thoroughly clean hub cavity and spindle. **NOTE:** Do not apply a **sealant** to the spindle shoulder. Apply a light coat of lubricant to spindle surfaces.

STEP 2

With the wheel in horizontal position, pre-lube the inner bearing and place it into the bearing cup. **NOTE:** When using grease, pre-pack the inner bearing before placement into the hub.



STEP 3

Place the seal on the recommended STEMCO Installation Tool, with the correct head, so that the words "Air Side" face into the tool. Place the tool (with the seal correctly mounted in the tool head) over the hub bore. Use a heavy hammer to drive against the end of the tool. Drive seal into bore until complete bottoming is assured. Remove Tool. Apply a thin layer of lubricant on the I.D. surface of the seal.

NOTE: Do not apply lubricant to the **O.D. of the seal.**



STEP 4

With the wheel mounted on a dolly, carefully align the bore with the spindle. Gently push the wheel assembly onto the spindle to the proper position. Fill the hub cavity with lubricant until it runs over the outer bearing cup. Coat the outer bearing with lubricant and place it on the spindle and into the bearing cup. **NOTE:** When using grease, pre-pack the outer bearing before placement into the hub. **NOTE:** Support the hub with the lifting device until the outer bearing and wheel-end fastener have been installed to a hand tight condition to prevent cocking of the hub/seal.



STEP 5

Assemble the inner nut and tighten it to 200 ft. lbs. Rotate the wheel several times then back off nut one full turn. Make final bearing adjustment according to TMC recommended bearing adjustment procedure. Install the appropriate axle fastener.



STEP 6

Install hub cap with new gasket, and fill cavity with the desired lubricant to the proper level. On drive axles be sure the differential oil is high enough (manufacturer's recommended level) to ensure oil flow through the tube to the wheels. It is recommended to jack one side up and then the other until flow starts. Make certain the breather plug is clear. Recheck steers and trailers to ensure proper fill levels.

Unitized Pinion Seal Installation

STEP 1

Remove yoke.



STEP 2

Remove old seal and wear ring (if applicable)



STEP 3

Remove all burrs and thoroughly clean cage bore.



NOTE: If installing the seal into a worn cage bore, apply a thin layer of No. 2 sealant to the OD of the seal before installation.

STEP 4

Align installation tool with the seal and spline as shown. Hand tighten bolt/nut.



STEP 5

Tighten until the seal flange bottoms into the cage -or- installation tool bottoms into cage (non-flange seals). Take care not to overtighten bolt/nut.



STEP 6

Remove burrs and thoroughly clean yoke. Lube the seal ID. Install yoke as shown.



STEP 7

Refer to axle manufacturer for yoke assembly torque requirements.



PRO-TORQ[®] Bearing Adjustment for Hubs with Manually Adjusted Wheel Bearings

STEP 1. Remove The Keeper From The Nut:

Use a screwdriver to carefully pry the keeper arm from the undercut groove on each side until the keeper is released.

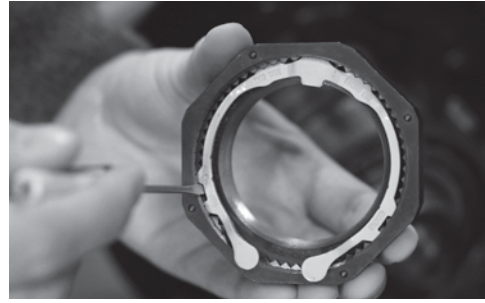

STEP 2. Seat the Bearing:

With hub or hub/drum only:

Using a torque wrench:

- 1 (A) Tighten the nut to 200 ft-lbs.
Spin the wheel at least one full rotation.
- (B) Tighten the nut to 200 ft-lbs.
Spin the wheel at least one full rotation.
- (C) Tighten the nut to 200 ft-lbs.
- 2 Back the nut off until it is loose.

With hub/drum/wheels:

Using a torque wrench:

- 1 Tighten the nut to 200 ft-lbs
while the wheel is rotating.
- 2 Back the nut off until it is loose.



STEP 3. Adjust The Bearing:

With hub or hub/drum only:

Using a torque wrench:

- 1 (A) Tighten the nut to 100 ft-lbs.
Spin the wheel at least one full rotation.
- (B) Tighten the nut to 100 ft-lbs.
Spin the wheel at least one full rotation.
- (C) Tighten the nut to 100 ft-lbs.
- 2 Back the nut off one raised face mark (according to chart).

With hub/drum/wheels:

Using a torque wrench:

- 1 Tighten the nut to 100 ft-lbs
while the wheel is rotating.
- 2 Back the nut off one raised face mark (according to chart).



FINAL BACKOFF

Part Numbers	Backoff
Trailer Axle Nut 447-4723, 447-4724	1/8 turn
Trailer Axle Nut 447-4743	1/4 turn
Steering Spindle Nut 448-4836, 448-4838, 448-4839, 448-4863, 448-4865	1/4 turn
448-4864	1/6 turn
Steering Spindle Nut 448-4837, 448-4840	1/3 turn
Drive Axle Nut 449-4904, 449-4973, 449-4974, 449-4975	1/8 turn

IMPORTANT

Pro-Torq[®] Installation Procedure for PreSet[®] or LMS[®] Hubs:

Pro-Torq[®] spindle nuts may be used with PreSet[®] or LMS[®] hub assemblies.

When used with these systems, it is important to follow the hub manufacturers' product specific installation instructions. For PreSet[®] and LMS[®] hub assemblies, torque the Pro-Torq[®] spindle nut to a minimum of 250 ft. lbs. Engage the keeper. If the keeper can not be engaged, advance the spindle nut until it can be engaged. **DO NOT BACK OFF THE SPINDLE NUT.**

WARNING

Failure to follow this instruction could cause the wheel to come off and cause bodily injury. The PRO-TORQ[®] Spindle Nut is sold as an assembly with the keeper in place. **DO NOT** attempt to place the nut on the spindle or tighten or loosen the nut on the spindle while the keeper is locked inside the nut. Doing so may deform the keeper and allow the nut to unthread during operation. **DO NOT** bend or manipulate keyway tang in any way. Doing so may cause the tang to break off in service. Failure to back off the nut will cause the bearings to run hot and be damaged.

STEP 4. Install the Keeper:

Orange side facing out

- 1 Insert the keeper tab into the undercut groove of the nut and engage the keyway tang in the axle keyway. Insert keeper tab with the orange side facing out.
- 2 Engage the mating teeth.
- 3 Compress and insert the keeper arms, one at a time, into the undercut groove with a screwdriver.

For Steering Spindle Nut

448-4836, 448-4839, 448-4840, 448-4863, 448-4864, 448-4865, 448-4863, and 448-4840

- 1 Align the flat of the keeper with the milled flat on the spindle and insert the single keeper tab into the undercut groove of the nut. Insert keeper tab with the orange side facing out.
- 2 Engage the mating teeth.
- 3 Compress and insert the keeper arms, one at a time, into the undercut groove with a screwdriver.



NOTE Recommended practice is to replace the keeper each time the Pro-Torq nut assembly is removed for maintenance purposes.

STEP 5. Inspect the Installation:

Failure to follow this instruction could cause the wheel to come off and cause bodily injury. Make sure that the keeper tab and keeper arms are fully seated into the undercut groove. Inspect keyway tang to insure it does not contact the bottom of the keyway. If contact exists, immediately notify your PRO-TORQ® representative.

This procedure will consistently produce a bearing setting of .001" to .003" end play.

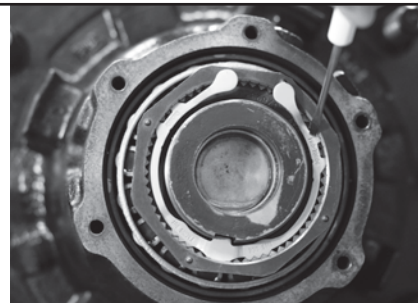

STEP 6. Acceptable End Play:

The dial indicator should be attached to the hub or brake drum with its magnetic base. Adjust the dial indicator so that its plunger is against the end of the spindle with its line of action approximately parallel to the axis of the spindle. Grasp the wheel or hub assembly at the 3 o'clock and 9 o'clock positions. Push and pull the wheel-end assembly in and out while oscillating the wheel approximately 45 degrees. Stop oscillating the hub so that the dial indicator tip is in the same position as it was before oscillation began. Read the bearing end-play as the total indicator movement.

**Acceptable end-play is .001"-.005". For single nut self-locking systems, consult manufacturers' specifications. STEMCO assumes no responsibility for bearing warranty.*

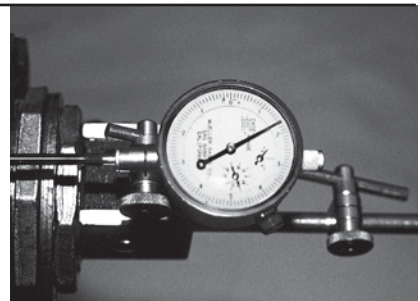

FAQS - COMMON CAUSES AND SOLUTIONS

- Q. Is there a problem with the keeper hitting the bottom of the keyway or the flat of the spindle?**
- A. If contact exists, contact STEMCO Customer Service**
- Q. Is a washer required between the Pro-Torq® Nut and the outer bearing?**
- A. The bearing contact surface is hardened, therefore a washer is not required. One exception is a Ford 12,000# SIFCO steer axle.**
- Q. What if the teeth in the Pro-Torq® Nut do not match-up with the keeper after the final adjustment?**
- A. By very slightly loosening the nut, the teeth will engage the keeper.**
- Q. Why does my keeper have paddles?**
- A. A design improvement to help install the keeper correctly every time. More specific bearing adjustment procedures with standard adjustment nuts are addressed beginning on Page 48.**

Wheel Bearing Adjustment

TMC's Recommended Wheel Bearing Adjustment Procedure for Standard Spindle Nuts

Proper wheel bearing adjustment is critical to the performance of wheel seals and other related wheel end products. For that reason, we are proud to be a part of TMC's Wheel End Task Force.

We are happy to bring these standards to you in the form of this technical guide.

Working together, in this way, STEMCO helps keep your rigs rolling.

The following seven step bearing adjustment recommendation for standard spindle nuts was developed by TMC's Wheel End Task Force.

It represents the combined input of manufacturers of wheel end components.

STEP 1.

Bearing Lubrication:

Lubricate the wheel bearing with clean lubricant of the same type used in the axle sump or hub assembly.

STEP 2.

Initial Adjusting Nut Torque:

Tighten the adjusting nut to a torque of 200 ft-lbs. while rotating the wheel.

STEP 3.

Initial Back-Off:

Back the adjusting nut off one full turn.

STEP 4.

Re-Torque Adjustment:

Re-Torque adjusting nut to 50 ft-lbs while rotating the wheel.

STEP 5.

Final Back Off:

AXLE TYPE	THREADS PER INCH	FINAL BACK-OFF
Steer (Single Nut)	12	1/6 Turn*
	18	1/4 Turn*
Steer (Double Nut)	14	1/2 Turn
	18	1/2 Turn
Drive	12	1/4 Turn
	16	1/4 Turn
Trailer	12	1/4 Turn
	16	1/4 Turn

STEP 6.

Jam Nut Torque:

AXLE TYPE	NUT SIZE	TORQUE SPECIFICATIONS
Steer (Double Nut)	Less Than 2 7/8"	200-300 ft-lbs
	2 7/8" And Over	300-400 ft-lbs
Drive	Dowel Type Washer	300-400 ft-lbs
	Tang Type Washer	200-275 ft-lbs
Trailer	Less Than 2 7/8"	200-300 ft-lbs
	2 7/8" And Over	300-400 ft-lbs

*Install cotter pin to lock axle nut in position.

STEP 7.

Acceptable End Play:

Refer to Page 21 of the STEMCO TQM Catalog for measuring end play.

Bearing Removal and Installation

Removal



Step 1 Remove hub/wheel assembly from vehicle in accordance with recommended practices.

Step 2 Remove inboard and outboard bearing cones and set aside for inspection.

Step 3 Using a mild steel drift or cup driver, carefully drive out the bearing cups.

- Caution should be used when driving bearing cups, as drifts and other tools can damage bearings.
- Drifts can damage hub bearing bores. Be careful not to score bores while removing cups, especially when using aluminum hubs.

Inspection



Step 1 Inspect the hub bearing bores and shoulders for damage. The bores should be smooth and free from scoring, burrs, indications of cup spinning, or other forms of damage. Remove any burrs or raised areas using emery cloth, a file, or other appropriate tool.

Step 2 Measure the bearing cup bore and compare to manufacturer specifications.



Step 3 Inspect bearing cups and cones for damage. Bearings should be free from chips, contamination, and signs of excessive wear or excessive heat. Refer to bearing damage analysis literature for identifying possible bearing issues.

Step 4 Inspect axle spindle bearing journals for any signs of damage or excessive wear. Remove any raised areas or burrs using emery cloth, a file, or other appropriate tool.

Step 5 Journals should be measured and compared with manufacturer specifications.

Installation



Step 1 Thoroughly clean bearing cups and cones prior to installation.

- Do not use compressed air to spin bearing rollers as injury may result if cage does not retain the rollers.

Step 2 Lightly coat the outside of bearing cups with oil.

Step 3 Using a cup driver, carefully drive bearing cups into hub bearing bores. Be sure to drive cup firmly against cup shoulder in hub.

- If a cup driver is not available, a mild steel drift can be used to install bearing cups.

- Caution should be used when driving bearing cups, as drifts and other tools can damage bearings.

- NEVER use a bearing cone to drive a bearing cup. This can damage the bearings and cause premature failure.

Step 4 Use a feeler gauge to check for gaps between cup and shoulder.

Step 5 Inspect the bearing cups to ensure no damage occurred during installation.

Step 6 Lubricate bearing cones according to recommended practices and proceed with installation of wheel assembly.

WARRANTY

STEMCO warrants to Buyer that all components sold will be free from defects in material and workmanship. This warranty is limited to components installed on vehicles licensed for on-highway use under normal use and service. This warranty extends for a period of one year from the date of manufacture.

The Buyer's exclusive remedy under this warranty shall be the repair or replacement of STEMCO components, but not the cost of removal or installation. STEMCO reserves the right to require that all warranty claim components are available and/or returned for review and evaluation. STEMCO shall not be liable for any claim, whether arising from breach of contract or warranty or claims of negligence or negligent manufacture, in excess of the purchase price. In no event shall STEMCO be liable for special, incidental, indirect, or consequential, or collateral, losses or damages of any kind.

This limited warranty is in lieu of all other warranties or conditions, expressed or implied, including any implied warranty of merchantability or fitness for particular purpose.

This is the only warranty offered by STEMCO and no STEMCO employee or representative is authorized to extend additional warranty terms on behalf of STEMCO.

STEMCO QUALITY PRODUCTS

Guardian[®]
HP



Voyager[®]



Discover[®]



PRO-TORQ[®]



SENTINEL[®]



SENTINEL[®]
ESP



HEAVY DUTY BEARINGS



DataTrac[®]
PRO



HUBDOMETER[®]



Unitized Pinion Seals



PLATINUM
PERFORMANCE SYSTEM[™]



DUALLY DRAIN PAN



STEMCO
CREWSON[™]
AUTOMATIC BRAKE ADJUSTER



STEMCO
DUROLINE[™]



STEMCO[®]

A Higher Standard of Performance.SM

an EnPro Industries company



STEMCO is committed to “*Making the Roadways Safer*” and increased customer value. We recognize the importance of providing customers with detailed product information, installation procedures and failure analysis.

- **Reduced Maintenance Cost**
- **Less Equipment Down Time**
- **Reduced Liability Exposure**
- **Reduced Rework Cost**
- **Safer Operating Equipment**
- **Process Control**
- **Repeatable Quality**

This TQMSM Manual was designed for this purpose, to assist in achieving a higher standard of performance within your operation.

What can TQM provide for your company?

A wheel end is not a collection of parts functioning independently; it is a system of interacting components. Specifically, the hub seal, axle fastener, hub cap, bearings, and lubricant play an important role in the overall performance of the wheel end. Each component is interrelated and its performance affects the total system. Using STEMCO parts with fluid lubrication, your wheel end components will not only provide optimum individual performance, they will, together, form a world-class wheel end system.

Quality Components Working as an Integral Unit Supported by Trained Professionals.

As a result of more than five decades of experience in the trucking industry, STEMCO has accumulated product and process knowledge of wheel end systems that will benefit all maintenance professionals. TQM demonstrates how STEMCO products, designed to perform with standard hub and axle configurations combined with sound assembly procedures, can result in exceptional wheel end performance.

As trucking technology has advanced, STEMCO has responded to the needs of the industry. At STEMCO, state-of-the-art equipment duplicates exact road conditions to test seal products and to insure their durability and performance. This TQMSM Manual is designed to maximize your investment in today's technologically advanced components, thereby helping the transportation industry achieve the goal of Total Quality Maintenance.

STEMCO® Hub Seal Selection

STEMCO has provided the trucking industry with reliable hub seals for more than 40 years. Throughout our history, we have recognized the need for tougher, longer life seals that meet the performance, design and price requirements related to selecting the right seal for any fleet. To meet that need, STEMCO has engineered a menu of sealing options designed to meet the varying performance expectations of each fleet, all in an effort to maximize performance and value.

Selecting the right STEMCO seal for the right application.

Discover® is designed for the long haul carrier seeking high performance components. The Discover seal is an excellent choice for fleets running outboard-mounted drums that allow brake changes without seal replacement. The long life characteristics of this seal, proven in testing that exceeds competitive products' performance by five times, make it the industry choice for performance driven fleet managers.

The Voyager® seal is designed for regional route trucks, city delivery and coach applications. Rugged design, simple installation and proven performance make Voyager the right choice for fleets looking for a superior brake job-to-brake job seal. In the everyday stop-and-go traffic environment these vehicles experience, the Voyager seal is the best value.

The Guardian® HP is the standard seal for trailer and axle original equipment manufacturers. The axle installation is durable and unique, and has proven successful for more than 40 years. Today, its enhanced features offer improved cost-per-mile performance. With simple one-step axle installation, Guardian HP is the seal of choice in the trailer industry.

Grit Guard® is always rough and ready and has endured more than forty years of dirty, unfriendly road environments that destroy wheel end components. So with this sixty year plus track record of performance, Grit Guard endures where others fail, and is still the choice for fleets working in grueling environments.



STEMCO® Hub Cap Selection

STEMCO, the industry leader in hub caps, has developed a comprehensive offering of hub caps for all applications. To meet the performance, design and price requirements of today's national and international fleets, STEMCO has developed a menu of hub cap options for both oil and grease applications. The product line has evolved into product specific technology developed to eliminate contaminants in abusive environments.

The traditional aluminum series 340 and 343 provide durability with the trademark red plug to allow venting of the hub cap. Using cast aluminum for constructing the hub cap body prevents warpage and provides superior durability and heat dissipation properties. The trucking industry recognizes STEMCO hub caps as the benchmark.



For grease applications, the 342 series Dirt Exclusion Hub Caps provide the same 340 casting without a side fill plug, plus a solid window with a sintered metal vent for venting purposes. To further support grease wheel ends, STEMCO developed the 352 series Solid Aluminum Hub Caps with a duckbill vent inserted in the face of a solid hub cap.



STEMCO Stamped Steel grease hub caps are manufactured from 14 gage steel and have a protective yellow chromate plating with a clear lacquer coating for additional protection from corrosion. For synthetic base grease like Mobilith SHC™ 007, use the vented 340-5096 version cap. For petroleum base grease use the non-vented 340-5097 cap.



STEMCO PSI hub caps are available in both oil and grease for several popular applications. The oil hub caps have a side fill plug and a standard window with oil fill lines. The grease hub caps do not have a side fill plug and incorporate a gray opaque window with no markings. The PSI tee fitting and flapper valve are to be installed in the center of the hub cap and are available from PSI as a part of the PSI System.



Sentinel® Technology provides an unmatched filtering system to eliminate contamination of lubricant from grime, dirt or water. STEMCO provides four options to put Sentinel Technology to work for you: The Sentinel Hub Cap provides tamper-proof system for maximum protection and maintenance-free performance.



Integrated Sentinel® hub caps integrate the Sentinel features into the window with fewer components and greater wheel end visibility. The Sentinel ESP (Extended Service Plug) and Sentinel ESP Filtered Vent allows economical retrofitting of wheel ends and drive axles with the benefits of STEMCO's exclusive Sentinel Technology.



Defender™ composite hub caps offer superior corrosion protection and are available in oil and grease applications. Defender™ comes in a wide variety of vent options from our trademark red plug, to our Sentinel® ESP plug, or our Integrated Sentinel® Technology. For applications running in the most grueling conditions use the Defender™ to defend your wheel end.



STEMCO® Platinum Performance System™

- Lower your operating costs, reduce downtime and increase revenue.
- STEMCO Platinum Performance System Plus 7 Light Weight removes up to 150 pounds of trailer weight, dramatically increasing payload.
- Light Weight and Tire Inflation Platinum Performance Systems help improve fuel efficiency performance.

Industry's Best Parts and Labor Warranty

PLATINUM PERFORMANCE SYSTEM™	AFTERMARKET PLATINUM PERFORMANCE SYSTEM™	PLATINUM PLUS PERFORMANCE SYSTEM™	PLATINUM PLUS 7 PERFORMANCE SYSTEM TIRE INFLATION	PLATINUM PLUS 7 PERFORMANCE SYSTEM LIGHT WEIGHT
<ul style="list-style-type: none"> ▪ Guardian® HP or Discover® Seal ▪ PRO-TORQ® Axle Fastener ▪ Sentinel® Hub Cap ▪ STEMCO® Bearings (Optional) ▪ Available for Aftermarket 	<ul style="list-style-type: none"> ▪ Guardian® HP or Discover® Seal ▪ PRO-TORQ® Axle Fastener ▪ Defender Sentinel® Hub Cap ▪ STEMCO® Bearings (Optional) 	<ul style="list-style-type: none"> ▪ Guardian® HP or Discover® Seal ▪ PRO-TORQ® Axle Fastener ▪ Sentinel® Hub Cap ▪ STEMCO® Bearings 	<ul style="list-style-type: none"> ▪ Aeris™ Automatic Tire Inflation System ▪ Guardian® HP or Discover® Seal ▪ PRO-TORQ® Axle Fastener ▪ Sentinel® Hub Cap ▪ STEMCO® Bearings 	<ul style="list-style-type: none"> ▪ STEMCO® CentriFuse® Drum and Hub Assembly ▪ STEMCO Crewson™ Automatic Brake Adjuster ▪ Guardian® HP or Discover® Seal ▪ PRO-TORQ® Axle Fastener ▪ Sentinel® Hub Cap ▪ STEMCO® Bearings
3 Year	3 Year	5 Year †	7 Year †	7 Year †

† Platinum Performance Plus, Platinum Performance Plus 7: Tire Inflation, and Platinum Performance Plus 7: Light Weight are for OEM Distributors only.

Industry's Best Parts and Labor Warranty

When you specify the Platinum Performance System™, you are assured of performance that will protect your fleet and your maintenance costs by reducing down-time and protecting your wheel end investment. Available on both tapered and parallel axles.

The newly redesigned Guardian® HP seal, and STEMCO manufactured precision bearings allow us to confidently move from a five to a seven year warranty on wheel end components based on major improvements in reliability and durability.

Extend Your Wheel End Performance in the Aftermarket

With the Platinum Performance System, you can gain a three year Aftermarket limited wheel end warranty.

Extend Your Aftermarket Wheel End Performance To Three Additional Years	
Retrofit	Refurbishment
<p>Replace components with:</p> <ul style="list-style-type: none"> ▪ Discover or Guardian HP Oil Seal ▪ Sentinel Hub Cap ▪ PRO-TORQ Spindle Nut 	<p>Replace components with:</p> <ul style="list-style-type: none"> ▪ Discover or Guardian HP Oil Seal ▪ Sentinel Hub Cap ▪ PRO-TORQ Keeper
<p>Receive: Three Year Limited Parts Warranty on components stated above. Wheel ends already equipped with PRO-TORQ can refurbish the axle fastener by replacing the PRO-TORQ Keeper and receive limited warranty coverage.</p>	
<p>Additional Warranty Coverage:</p> <ul style="list-style-type: none"> ▪ Add STEMCO New Brake Shoes ▪ Add Aeris® Automatic Tire Inflation System 	

STEMCO® Platinum Performance System™



PLATINUM
PERFORMANCE SYSTEM™

Flexible Options to Fit Your Installation Preferences

STEMCO's Platinum Performance System™ an integrated system of products and performance. With the Platinum Performance System, you can extend your wheel end to a three-year or five year limited warranty.

Simply The Best

Benefit from unprecedented product performance with STEMCO's exclusive patented Guardian® HP or Discover® Seal; PRO-TORQ® Advanced Axle Spindle Nut; and the tamper-proof Sentinel Hub Cap. Receive extended bearing warranty by adding STEMCO Heavy Duty Bearings.

Higher Performance Equals Less Maintenance

When you specify the Platinum Performance System, you are assured of performance that will protect your fleet and maintenance budget. The unprecedented performance of this STEMCO system will lower your maintenance costs by reducing down-time and protecting your wheel end investment.

Two Seven-Year Wheel End Offerings

The Tire Inflation package guarantees the life of the Aeris® Automatic Tire Inflation System, Guardian® HP or Discover Seal, PRO-TORQ axle fastener, Sentinel hub cap, and STEMCO bearings for up to seven years. The Light Weight Performance package guarantees the life of the STEMCO CentriFuse® Drum and Hub Assembly, STEMCO Crewson Automatic Brake Adjustor, as well as the wheel end products stated above for up to seven years. These long-life systems provide a seven year limited parts and labor warranty by simply adding select components to the industry leading five year Platinum Performance System Plus offering. STEMCO's Platinum Performance System is an integrated system of product and performance.

These new packages are designed to lower operating costs, reduce downtime, and increase revenue by keeping tires properly inflated and reducing weight up to 150 pounds per tandem axle trailer. The Platinum Performance Plus, Platinum Performance Plus 7 Tire Inflation and Platinum Performance Plus 7 Light Weight are for OEM Distributors only.



Technologically Advanced Sealing Solutions



Unitized Pinion Seals

Easy Installation

The single piece, unitized design is installed in one step using the yoke bolt to install the press-fit OD.

Repair Sleeves Not Required

The unitized design incorporates a wear ring to provide an ideal running surface for the sealing lip, thus eliminating the need for repair sleeves that often change the seal lip angle during operation, resulting in reduced life.

Eliminate Yoke Wear

Sealing lips are contained in a manner that prevents yoke surface contact from the lip. New yokes will remain new at the sealing point.

Repair 'Grooved' Yokes

STEMCO's patented anti-rotation "SMART" features lock the ID surface in place while a wider contact area on the rubber ID makes most yokes reusable.

Eliminate Leak Paths

Bore sealant on the OD and a wider contact area on the rubber ID eliminate leak paths to avoid premature failures.

Reduce Contamination Failures

To promote long life, a labyrinth path with multiple dust lips prevents contamination ingress into the sealing lip and oil.

Long-Life Performance

Fluoroelastomer rubber on the main sealing lip withstands the high heat consistent with pinion seal applications.

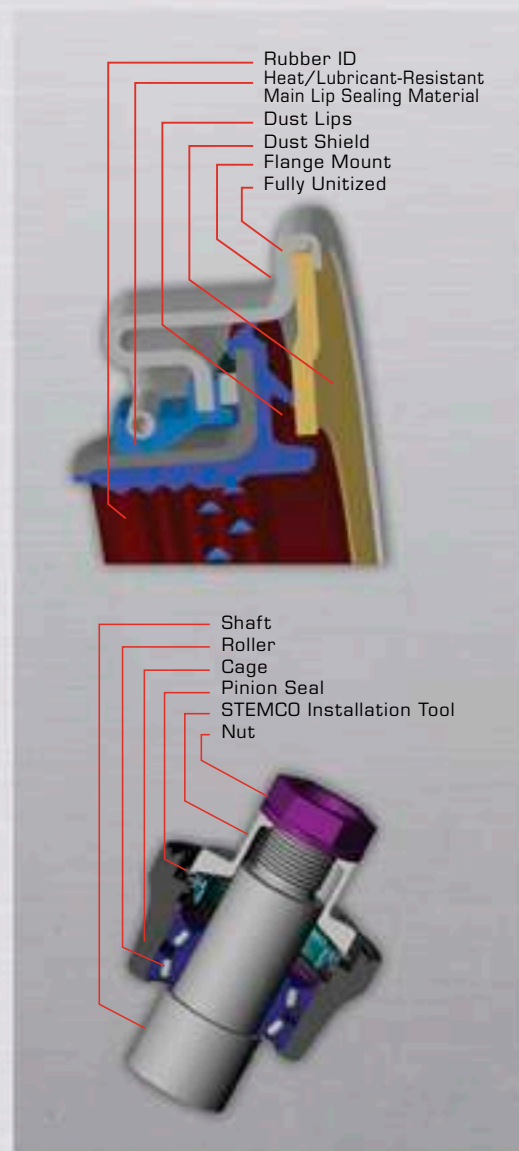

Programmable for Any Tire Size



DataTrac Pro
Shown Actual Size

DataTrac[®]
PRO

Always Have The Part Number

Stock only one part number with the programmable DataTrac[®] Pro and program the customer's specific requirement for any tire. With DataTrac Pro you can also pre-set your own mileage and eliminate lead-time and pre-set charges.

Schedule Maintenance

The DataTrac Pro is an indispensable tool for scheduling maintenance based on actual mileage rather than time.

Large, Easy-to-Read LCD Display

The display makes data retrieval simple and accurate. Optional flexibility of trip and life readings for precise data collection and management. Numbers automatically position upright for easy verification of mileage.

Compact Size

The compact size makes it easy to mount and dismount tires without removing the DataTrac Pro from the wheel.

No Moving Parts

Provides improved reliability and durability for the most demanding vocational applications. Each unit is marked with a unique serial number providing additional security and data control.



Program over 2500 specific tire models and sizes ensuring customer gets reliable mileage information.

Guardian[®] and Guardian[®] HP Seal Installation



STEP 1 Remove all burrs from the hub bore and spindle. Thoroughly clean the entire wheel cavity. Apply a thin layer of No. 2 sealant to the OD of the spindle shoulder. Place the seal assembly on the spindle so the words "Oil Bearing Side" are exposed to the oil. **[Photo 1]**

Warning: Do not install the seal into the hub bore.



STEP 2 Using the recommended STEMCO Universal Axle Tool, drive the seal assembly on until the tool bottoms against the shoulder. **[Photo 2]** Make sure the ring is flush with the axle shoulder. Ensure seal fully contacts the wear ring flange. Wipe away any excess sealant.



STEP 3 Dip the inner bearing in oil and place on the spindle. **NOTE: The OD of the seal must be coated with a thin coat of lubricant. NOTE: When using grease, pre-pack the inner bearing before placement into the hub.**

STEP 4 With the wheel mounted on a wheel dolly, carefully push the wheel onto the spindle until it contacts the seal. **[Photo 3]** Dip the outer bearing in oil and place it on the spindle. **NOTE: When using grease, pre-pack the outer bearing before placement into the hub. Tighten the inner spindle nut hand tight and remove the wheel dolly.**



STEP 5 Tighten the inner nut to 200 ft/lbs. **[Photo 4]** Rotate the wheel several times and then back-off nut one full turn. Make final bearing adjustment according to TMC recommended bearing adjustment procedure. Install the appropriate axle fastener.

STEP 6 Install the hub cap with a new gasket and fill the cavity with lubricant to the proper level. On drive axles, be sure the differential oil level is high enough (manufacturer's recommended level) to ensure oil flow through the tube to the wheels. It is recommended to jack-up one side and then the other until flow starts. Make certain the breather plug is clear. Recheck steers and trailers to insure proper fill levels.

Voyager® and Discover® Installation

STEP 1 Remove all burrs from the hub bore and spindle. Thoroughly clean hub cavity and spindle. **Note: Do not apply any sealant to the spindle shoulder. Apply a light coat of lubricant to spindle surfaces.**

STEP 2 With the wheel in horizontal position, pre-lube the inner bearing and place it into the bearing cup. **[Photo 1]**
Note: When using grease, pre-pack the inner bearing before placement into the hub.

STEP 3 Place the seal on the recommended STEMCO Installation Tool, with the correct head, so that the words "Air Side" face into the tool. Place the tool (with the seal correctly mounted in the tool head) over the hub bore. Use a heavy hammer to drive against the end of the tool. Drive seal into bore until complete bottoming is assured. **[Photo 2]** Remove Tool. Apply a thin layer of lubricant on the ID surface of the seal. **Note: Do not apply lubricant to the OD of the seal.**

STEP 4 With the wheel mounted on a dolly, carefully align the bore with the spindle. **[Photo 3]** Gently push the wheel assembly onto the spindle to the proper position. Be careful not to bump the top of the seal against the axle. Fill the hub cavity with lubricant until it runs over the outer bearing cup. Coat the outer bearing with lubricant and place it on the spindle and into the bearing cup. **Note: When using grease, pre-pack the outer bearing before placement into the hub. Note: Support the hub with the lifting device until the outer bearing and wheel-end fastener have been installed to a hand tight condition to prevent cocking of the hub/seal.**

STEP 5 Assemble the inner nut and tighten it to 200 ft/lbs. **[Photo 4]** Rotate the wheel several times and then back-off nut one full turn. Make final bearing adjustment according to TMC recommended bearing adjustment procedure. Install the appropriate axle fastener.

STEP 6 Install the hub cap with a new gasket and fill the cavity with lubricant to the proper level. On drive axles, be sure the differential oil level is high enough (manufacturer's recommended level) to ensure oil flow through the tube to the wheels. It is recommended to jack-up one side and then the other until flow starts. Make certain the breather plug is clear. Recheck steers and trailers to insure proper fill levels.

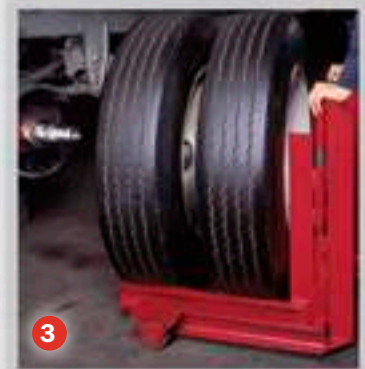
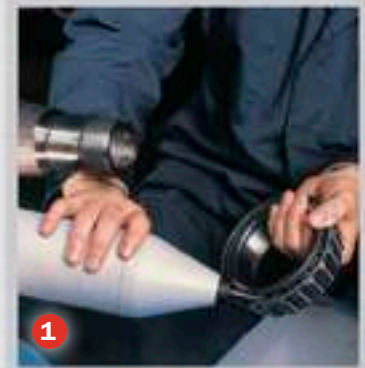

Standard/Grit Guard® Seal Installation



STEP 1 Remove all burrs and thoroughly clean the spindle. Apply a thin layer of No. 2 sealant to the OD of the spindle shoulder. Place the axle ring on the spindle.



STEP 2 Using the recommended STEMCO Universal Axle Tool, drive the axle ring on until the tool bottoms against the spindle shoulder. **[Photo 1]** Make certain the axle ring is flush with the shoulder. Wipe away any excess sealant.



STEP 3 Remove all burrs from the hub bore and thoroughly clean the entire wheel cavity.

STEP 4 With the wheel in horizontal position, pre-lube the inner bearing and place it into the bearing cup. **[Photo 2]** *Note: When using grease, pre-pack the inner bearing before placement into the hub.*



STEP 5 Apply a thin layer of No. 2 sealant to the OD of the seal and position the seal in the hub. Using the recommended STEMCO Universal Hub Tool held in a vertical position, drive the seal into the seal bore until it is bottomed-out. **[Photo 3]** Check the clearance between the bearing cone and seal (at least 1/32" is required).

STEP 6 With the wheel mounted on a dolly, carefully align the bore with the spindle. **[Photo 4]** Gently push the wheel assembly onto the spindle to the proper position. Pre-lube the outer bearing and push it into the bearing cup. *Note: When using grease, pre-pack the outer bearing before placement into the hub.*



STEP 7 Assemble the inner nut and tighten it to 200 ft/lbs. **[Photo 5]** Rotate the wheel several times and then back-off nut one full turn. Make final bearing adjustment according to TMC recommended bearing adjustment procedure. Install the appropriate axle fastener.

STEP 8 Install the hub cap with a new gasket and fill the cavity with lubricant to the proper level. On drive axles, be sure the differential oil level is high enough (manufacturer's recommended level) to ensure oil flow through the tube to the wheels. It is recommended to jack-up one side and then the other until flow starts. Make certain the breather plug is clear. Recheck steers and trailers to insure proper fill levels.

DataTrac® Pro Installation Instructions

How It Works

DataTrac Pro is an advanced mileage counter that relies on Earth's gravity for counting wheel revolutions. The DataTrac® Pro unit monitors its orientation to Earth's gravitational pull and uses this reference to recognize and count revolutions.

Programming The Unit

Distribution or End User with a Programmer

The unit is shipped from the factory with a Revs/Mile value of zero. Dashes (- - -) on the display indicate that the unit has NOT been programmed. It MUST be programmed before it is installed on a wheel end (The DataTrac Pro distributor should have a programmer or can sell you a programmer).

The programmer can set the DataTrac PRO's:

- 1) Revolutions/Mile (or per Km) - Use Stemco's catalog to determine the Revolutions/Mile for each Tire Make/Model.
- 2) Distance Unit of Measure - Miles or Km (Life miles only or including Trip Miles)
- 3) Mileage Preset - Set the mileage to match the current mileage of the vehicle the unit will be mounted to.

When programming is complete, (as indicated on the programmer screen) immediately lift the DataTrac PRO up and confirm the display shows the correct Tire Revolutions (shown as "REV###" on the screen). If not, repeat the programming. The DataTrac Pro can be programmed/reprogrammed as many times as desired until there is approximately 2 miles on the unit.

Installing The Unit

Install the DataTrac PRO unit using the appropriate STEMCO bracket and hardware. The nut furnished with the unit is a locking nut and must not be torqued over 15-ft lbs.

Reading The Display

The display will turn on when the vehicle is at rest. Numbers will automatically orient to read upright. This is also indicated by the icon display, e.g. mile, km, acre. The mileage reading is always in the same direction as the icon.

In order to conserve power the display turns off at any time a vibration is detected. This means that the display will be off while the vehicle is moving. As soon as all vibration or motion stops the display will reactivate in about 5 seconds.

Display Modes

The DataTrac Pro unit comes equipped with three display modes: LIFE and TRIP (if programmed), and REV. To toggle the display between LIFE, TRIP and REV Modes, use the palm of your hand to cover the round bubble on the face of the unit for at least 1 second, and then uncover it. If the unit is in bright sunlight, the bubble may have to be covered with your palm to block more light from reaching the sensor. TRIP mode is displayed with tenths resolution and is indicated by display of the TRIP icon (only if unit is programmed for TRIP).

To reset the TRIP display, toggle between LIFE, TRIP and REV Modes 5 times, quickly. Note that the unit cannot toggle faster than every 1.5 seconds. To view the revolutions of the unit simply repeat the process that is used to view trip and then a screen that shows (REV XXX) will show up. The XXX is the number of revolutions per KM or MILE that the unit is programmed for. On units without TRIP there are only two screens, all others have three screens (LIFE, TRIP, and REV). As with the TRIP mode the unit will return to the mileage after 10 seconds if left in the revolutions screen.

DataTrac® PRO



Install DataTrac Pro on wheel end.



Display turns on when the vehicle is at rest.



Display turns off when vibration is detected (vehicle moving) to conserve energy.



LIFE mode shows mileage without tenths.



TRIP mode shows mileage with tenths and TRIP icon.



REV Mode shows RPM or RPK unit Programmed for.

Hub Cap Installation and Troubleshooting

The hub cap endures constant physical abuse from the elements and internal factors that can affect its characteristics both visually and functionally. The TQMSM Manual will provide helpful information about installation and lubrication, as well as help in troubleshooting problems. Additionally, examples of potential hub cap failures are pictured in the Failure Analysis section.

Proper Hub Cap Installation Procedures

- STEP 1** Check the mounting surface of the hub, making sure to clean off old gaskets and sealant. Also, check for any burrs or imperfections that might prevent a proper gasket seal.
- STEP 2** Make sure all components are free of any dirt or grit.
- STEP 3** Always install the hub cap with a new gasket.
- STEP 4** Split washers are recommended to lock the flange bolts in place.
- STEP 5** Initially hand tighten the hub cap (see bolt tightening sequence below) and finally torque to the recommended specification as noted on page 15.
- STEP 6** For the threaded Pro-Par caps, lightly lubricate the threads and O-ring and install the hub cap. Refer to the torque specifications on Page 15 for the recommended torque value for threaded hub caps.
- STEP 7** For oil applications, fill to the recommended level and re-check after the lube has had adequate time to establish its final level.

Window Kit Replacement Procedures

- STEP 1** Remove the old window ring using a #8 Torx driver.
- STEP 2** Thoroughly clean the hub cap and window ring leaving the window ledge free of oil and the mounting surface of the window ring clean and free of any old gasket material.
- STEP 3** Place the new window gasket in the hub cap casting, and insert the new window with the window ring and window ring gasket in place.
- STEP 4** It is recommended that screws be replaced with new ones. Once the screws have been started and pulled down, begin tightening with a cross hatch pattern to evenly distribute the load. Refer to the Torque Specifications chart on Page 15 for the proper torque. It is recommended that hand tools be used for this procedure, as power tools may over-torque the screws and damage the threads.
- STEP 5** The hub cap is now ready for installation.

Recommended Bolt Tightening Sequence



Hub Cap Installation and Troubleshooting

Frequently Asked Questions

Q. Should the hub cap be packed with grease?

A. A small amount of grease may be added to the hub cap before installation. Do not cover the vent mechanism with grease. See Page 26 for more detail. For additional information on lubrication fill procedures for hub caps, refer to TMC publication RP 631.

Q. How tight should the flange bolts be?

A. Refer to the Hub Cap Torque Specifications below.

Q. Is it OK to use an impact tool to mount the hub cap?

A. It is suggested that hub cap bolts be tightened with hand tools to prevent possible warping or breakage of the hub cap flange. Refer to the Torque Specifications below for the recommended torque value.

Q. Is venting required for all applications?

A. It is suggested that the wheel assembly be vented to allow the hub to vent pressure and relieve vacuum when using oils and synthetic greases. Only with heavy packing grease will the wheel end properly operate without venting.

Q. Why do my hub caps have a build-up on the inside of the sight glass?

A. This build-up is a slow process caused by the additives present in some lubricants. Removal is impossible; however, replacement window kits are available.

Troubleshooting Guide	
Problem	Possible Sources or Causes
Water Contaminated/ Milky Oil	High pressure washing, flooded loading docks (Note: See Oil Crackle Test on Page 13).
Bulged/Melted Windows	Check for low lube level, high heat caused from improperly adjusted bearings, high heat caused from improperly adjusted brakes.
Leaking Gaskets	Improper torque of flange bolts, gouged mounting surface (hub cap flange/hub face), no gasket, reuse of gasket.
Leakage from Red Fill Plug	Make sure the oil level is not in an overfilled condition, and check the vent hole to make certain it is not plugged. High heat and resulting pressure may also contribute to leakage.

Hub Cap Torq Specs			
Threaded Hub Caps			
Part No.		Torq	
XXX-4075		100 ft/lbs	
340-4975		50-60 ft/lbs	
340-4976		50-60 ft/lbs	
640-0003		50-60 ft/lbs	
Hub Cap Components			
Part No.	Type	Torq	
359-6032	#8 Torx Screw	18-23 in/lbs	
359-5984	3/8" Mag Plug	5-9 ft/lbs	
359-5985	3/8" Pipe Plug	5-9 ft/lbs	
Hub Cap Mounting Bolts			
Size	Torq	Size	Torq
1/4"	8-12 ft/lbs	5/8"	22-26 ft/lbs
5/16"	12-16 ft/lbs	3/4"	24-28 ft/lbs
3/8"	16-20 ft/lbs	7/8"	26-30 ft/lbs
7/16"	18-22 ft/lbs	6MM	8-12 ft/lbs
1/2"	20-24 ft/lbs	8.5MM	12-16 ft/lbs

PRO-TORQ® and Bearing Adjustment

PRO-TORQ® Installation Procedure for Hubs with Manually Adjusted Wheel Bearings

STEP 1 Remove The Keeper From The Nut:

Use a screwdriver to carefully pry the keeper arm from the undercut groove on each side until the keeper is released.

STEP 2 Seat the Bearing:

WITH HUB OR HUB/DRUM ONLY

Using a torque wrench:

1. (A) Tighten the nut to 200 ft-lbs.
Spin the wheel at least one full rotation.
- (B) Tighten the nut to 200 ft-lbs.
Spin the wheel at least one full rotation.
- (C) Tighten the nut to 200 ft-lbs.

WITH HUB/DRUM/WHEELS:

Using a torque wrench:

1. Tighten the nut to 200 ft-lbs while the wheel is rotating.
2. Back the nut off one full turn.

STEP 3 Adjust The Bearing:

WITH HUB OR HUB/DRUM ONLY

Using a torque wrench:

1. (A) Tighten the nut to 100 ft-lbs.
Spin the wheel at least one full rotation.
- (B) Tighten the nut to 100 ft-lbs.
Spin the wheel at least one full rotation.
- (C) Tighten the nut to 100 ft-lbs.
2. Back the nut off one raised face mark (according to chart).

WITH HUB/DRUM/WHEELS

Using a torque wrench:

1. Tighten the nut to 100 ft-lbs while the wheel is rotating.
2. Back the nut off one raised face mark (according to chart)

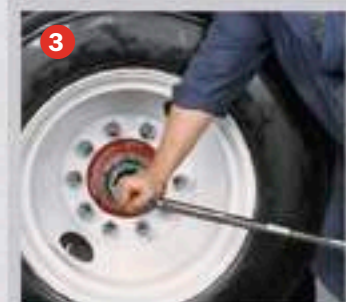
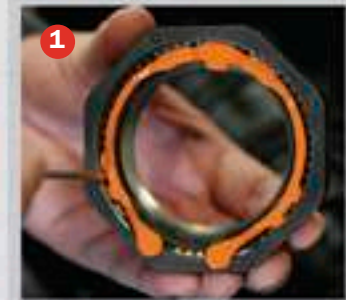

Final Backoff	
Part Numbers	Backoff
Trailer Axle Nut 447-4723, 447-4724, 449-4973	1/8 turn
Trailer Axle Nut 447-4743	1/4 turn
Steering Spindle Nut 448-4836, 448-4838, 448-4839, 448-4863, 448-4864, 448-4865	1/4 turn
Steering Spindle Nut 448-4837, 448-4840	1/3 turn
Drive Axle Nut 449-4904, 449-4973, 449-4974, 449-4975	1/8 turn

PRO-TORQ® and Bearing Adjustment

STEP 4 Install the Keeper:

ORANGE SIDE FACING OUT

1. Insert the keeper tab into the undercut groove of the nut and engage the keyway tang in the axle keyway. Insert keeper tab with the orange side facing out.
2. Engage the mating teeth.
3. Compress and insert the keeper arms, one at a time, into the undercut groove with a screwdriver.

FOR STEERING SPINDLE NUT

448-4836, 448-4839, 448-4840, 448-4863, 448-4864, and 448-4865

1. Align the flat of the keeper with the milled flat on the spindle and insert the single keeper tab into the undercut groove of the nut. Insert keeper tab with the orange side facing out.
2. Engage the mating teeth.
3. Compress and insert the keeper arms, one at a time, into the undercut groove with a screwdriver.

Recommended practice is to replace the keeper each time the PRO-TORQ nut assembly is removed for maintenance purposes.

STEP 5 Inspect the Installation:

Failure to follow this instruction could cause the wheel to come off and cause bodily injury. Make sure that the keeper tab and keeper arms are fully seated into the undercut groove. Inspect keyway tang to insure it does not contact the bottom of the keyway. If contact exists, immediately notify your PRO-TORQ® representative.

This procedure will consistently produce a bearing setting of .001" to .003" end play.

STEP 6 Acceptable End Play:

The dial indicator should be attached to the hub or brake drum with its magnetic base. Adjust the dial indicator so that its plunger is against the end of the spindle with its line of action approximately parallel to the axis of the spindle. Grasp the wheel or hub assembly at the 3 o'clock and 9 o'clock positions. Push and pull the wheel-end assembly in and out while oscillating the wheel approximately 45 degrees. Stop oscillating the hub so that the dial indicator tip is in the same position as it was before oscillation began. Read the bearing end-play as the total indicator movement.

*Acceptable end-play is .001"-.005". For single nut self-locking systems, consult manufacturers' specifications. STEMCO assumes no responsibility for bearing warranty.

IMPORTANT

PRO-TORQ Installation Procedure for PreSet® or LMS® Hubs:

PRO-TORQ spindle nuts may be used with PreSet or LMS hub assemblies. When used with these systems, it is important to follow the hub manufacturers' product specific installation instructions. For PreSet and LMS hub assemblies, torque the PRO-TORQ spindle nut to a minimum of 250 ft. lbs. Engage the keeper. If the keeper can not be engaged, advance the spindle nut until it can be engaged. **DO NOT BACK OFF THE SPINDLE NUT.**

PRO-TORQ® ADVANCED AXLE SPINDLE NUTS



WARNING!

Failure to follow this instruction could cause the wheel to come off and cause bodily injury. The PRO-TORQ Spindle Nut is sold as an assembly with the keeper in place. **DO NOT** attempt to place the nut on the spindle or tighten or loosen the nut on the spindle while the keeper is locked inside the nut. Doing so may deform the keeper and allow the nut to unthread during operation. **DO NOT** bend or manipulate keyway tang in any way. Doing so may cause the tang to break off in service. Failure to back off the nut will cause the bearings to run hot and be damaged.

Performance and Value Leader



HEAVY DUTY BEARINGS

Value Added Bearing Program

Through strategic alliances and strong global procurement, STEMCO bearings meet the changing needs of today's market. STEMCO bearings are the right mix of performance, convenience and value.

Consolidated Wheel End Components Provider

The same company that provides high performance STEMCO Wheel Seals, PRO-TORQ Precision Adjusting Nuts and Hub Caps, can supply your wheel bearing needs; providing safety, reliability and performance from a single source.

STEMCO Quality Bearings

Our worldwide network of manufacturing plants is held to the highest quality standards by STEMCO and meets the ABMA specifications for bearing life calculations.

Expanded Bearing Coverage

The STEMCO product offering includes tapered roller bearings, radial ball bearings, clutch release bearings, individual cups and cones, and STEMCO matched bearing sets.

Long Life Warranty

STEMCO offers a 3 or 5 year limited warranty when used in conjunction with the STEMCO Platinum Performance System or Platinum Performance System Plus.

Bearing Removal and Installation

Bearing Removal

- STEP 1** Remove hub/wheel assembly from vehicle in accordance with recommended practices.
- STEP 2** Remove inboard and outboard bearing cones and set aside for inspection.
- STEP 3** Using a mild steel drift or cup driver, carefully drive out the bearing cups.
- *Caution should be used when driving bearing cups, as drifts and other tools can damage bearings.*
 - *Drifts can damage hub bearing bores. Be careful not to score bores while removing cups, especially when using aluminum hubs.*

Bearing Inspection

- STEP 1** Inspect the hub bearing bores and shoulders for damage. The bores should be smooth and free from scoring, burrs, indications of cup spinning, or other forms of damage. Remove any burrs or raised areas using emery cloth, a file, or other appropriate tool.
- STEP 2** Measure the bearing cup bore and compare to manufacturer specifications.
- STEP 3** Inspect bearing cups and cones for damage. Bearings should be free from chips, contamination, and signs of excessive wear or excessive heat. Refer to bearing damage analysis literature for identifying possible bearing issues.
- STEP 4** Inspect axle spindle bearing journals for any signs of damage or excessive wear. Remove any raised areas or burrs using emery cloth, a file, or other appropriate tool.
- STEP 5** Journals should be measured and compared with manufacturer specifications.

Bearing Installation

- STEP 1** Thoroughly clean bearing cups and cones prior to installation.
- *Do not use compressed air to spin bearing rollers as injury may result if cage does not retain the rollers.*
- STEP 2** Lightly coat the outside of bearing cups with oil.
- STEP 3** Using a cup driver, carefully drive bearing cups into hub bearing bores. Be sure to drive cup firmly against cup shoulder in hub.
- *If a cup driver is not available, a mild steel drift can be used to install bearing cups.*
 - *Caution should be used when driving bearing cups, as drifts and other tools can damage bearings.*
 - *NEVER use a bearing cone to drive a bearing cup. This can damage the bearings and cause premature failure.*
- STEP 4** Use a feeler gauge to check for gaps between cup and shoulder.
- STEP 5** Inspect bearing cups to ensure no damage occurred during installation.
- STEP 6** Lubricate bearing cones according to recommended practices and proceed with installation of wheel assembly.



STEMCO Endorses TMC's Recommended Wheel Bearing Adjustment Procedure

Proper wheel bearing adjustment is critical to the performance of wheel seals and other related wheel end products. For that reason, we are proud to be a part of TMC's Wheel End Task Force. We are happy to bring these standards to you in the form of this technical guide.

Working together, in this way, STEMCO helps keep your rigs rolling. The following seven step bearing adjustment recommendation was developed by TMC's Wheel End Task Force. It represents the combined input of manufacturers of wheel end components.

Wheel Bearing Adjustment

STEP 1 Bearing Lubrication:

Lubricate the wheel bearing with clean lubricant of the same type used in the axle sump or hub assembly.

STEP 2 Initial Adjusting:

Nut Torque: Tighten the adjusting nut to a torque of 200 ft-lbs. while rotating the wheel.

STEP 3 Initial Back-Off:

Back the adjusting nut off one full turn.

STEP 4 Re-Torque Adjustment:

Re-Torque adjusting nut to 50 ft-lbs while rotating the wheel.

STEP 5 Final Back-Off:

See Chart A above right.

STEP 6 Jam Nut Torque:

See Chart B below right.

STEP 7 Acceptable End Play:

Refer to Page 21 for measuring end play.

Chart A

Axle Type	Threads Per Inch	Final Back-Off
Steer <i>Single Nut</i>	12	¼ Turn*
	18	¼ Turn*
Steer <i>Double Nut</i>	14	½ Turn
	18	½ Turn
Drive	12	¼ Turn
	16	¼ Turn
Trailer	12	¼ Turn
	16	¼ Turn

*Install cotter pin to lock axle nut in position.

Chart B

Axle Type	Nut Size & Type	Torque Specifications
Steer <i>Double Nut</i>	Less Than 2-5/8"	200 - 300 ft-lbs
Drive	Dowel Type Washer	300 - 400 ft-lbs
	Tang Type Washer	200 - 275 ft-lbs
Trailer	2-5/8" And Larger	200 - 300 ft-lbs

Bearing Adjustment Procedure for Single Castellated Nut

STEP 1 Torque the Castellated Nut to 200 ft/lbs.

STEP 2 Back the nut off 1/2 to 1 full turn and rotate wheel assembly.

STEP 3 Re-torque Castellated Nut to 75 ft/lbs while wheel assembly is rotated.

STEP 4 Lock Castellated Nut in place with a new cotter pin through one of the two holes drilled in the axle. If at 75 ft-lbs you are not on a hole, back the nut off to the closest hole and lock in place with the cotter pin.

STEP 5 Due to Castellated Nut configuration, variation in bearing adjustment can be significant.

STEP 6 Always check end play after final adjustment and lock down.

*For Single Nut Systems see 571-2994.

Acceptable End Play and How to Measure It

Measuring Acceptable End Play

- STEP 1** Using a magnetic base, mount the dial indicator on the spindle end, making sure the hub face is clean and free of gasket material.
- STEP 2** Adjust the arm of the dial indicator, setting the plunger tip of the indicator on the machined face of the hub at the 12 o'clock position. The plunger should be set-up so that it is parallel to the axis of the spindle. When positioning the indicator tip, ensure that the indicator has adequate range of travel for proper measurement. Set the indicator to zero.
- STEP 3** Grasp the wheel/hub assembly at the 3 o'clock and 9 o'clock positions. Pull the wheel end assembly outward while oscillating the wheel approximately 45°. While continuing to pull, stop oscillating and read the indicator.
- STEP 4** Push the wheel assembly inward while oscillating. While continuing to push, stop oscillating and read the indicator.
- STEP 5** Read bearing end play as total indicator movement.

Acceptable end play is .001" to .005" as measured with a dial indicator as per TMC's Recommended Bearing Adjustment Procedure.



Oil Analysis: The Visual Crackle

A New Twist to an Old Technique

Purpose: Moisture in lubricating oils is a primary contaminant that leads to degradation of lubricant base-stock and additives, and it also corrodes component surfaces and accelerates wear due to reduced fluid film strength. The visual crackle test is a simple field method to detect and roughly quantify the presence of moisture in these fluids.

Method: The crackle-test is a simple test to identify the presence of free and emulsified water that is suspended in oil. Water is the most harmful element to the machine as well as to the oil.

The method is as follows:

STEP 1 Achieve surface temperature on a hot plate of 300° F (135° C). Be sure to always use the same temperature.

STEP 2 Violently agitate oil sample to achieve homogenous suspension of water in oil.

STEP 3 Using a clean dropper, place a drop of oil on the hot plate.



Observable Results:

Fig 1. If no crackling or vapor bubbles are produced after a few seconds, no free or emulsified water is present.

Fig 2. If very small bubbles (0.5 mm) are produced but disappear quickly, approximately 0.05 – 0.1% water is present.

Fig 3. If bubbles approximately 2 mm are produced and gather at the center of oil spot and then enlarge to about 4 mm and disappear, approximately 0.1 to 0.2% water is present.

Fig 4. For moisture levels above 0.2%, bubbles may originate at approximately 2-3 mm and then grow to 4 mm, with the process repeating once or twice. For even higher moisture levels, violent bubbling and audible crackling may result.

Limitations:

1. The method is non-quantitative.
2. Hot plate temperatures above 300° F induce rapid scintillation that may be undetectable.
3. The method does not measure the presence of chemically dissolved water.

Safety Considerations:

1. Protective eyewear is suggested.
2. Long sleeves are suggested.
3. Test should be performed in a well-ventilated area.

Equipment Required:

1. Hot plate capable of achieving and maintaining 300° F surface temperature.
2. Paint shaker (or equivalent) for oil agitation.
3. Oil dropper tube or lab syringe.

Applicable Standards: None

Interferences:

Refrigerants and other low boiling point suspensions may interfere. Different base stocks, viscosities, and additives will exhibit varying results. Certain synthetics, such as esters, may not produce scintillation.

Failure Analysis

Failure Analysis is a Key Element of TQM

Determining the cause of component failure can be difficult. The following photographs and descriptions are primary failure modes and their typical causes and/or solutions. While this TQM Manual will address numerous installation procedures and recommendations, it is also important to understand why products fail in order to correct potential factors that may cause these failures.

In addition to the information which follows, STEMCO would also like to offer additional sources of product evaluation and solutions to problems:

STEP 1 Contact STEMCO Customer Service

STEP 2 Contact the District Sales Manager in your area.

STEP 3 Ship failed parts to STEMCO's Warranty Department for evaluation.

- A.** Select a representative sample of mated seals and rings or other products.
- B. *DO NOT*** wash the parts in solvent.
- C.** Attach a tag if parts are mates, showing vehicle mileage, component mileage, wheel position, oil type, vehicle ID and installation date/removal dates.
- D.** Ship parts to:
 - STEMCO**
 - 300 Industrial Blvd.**
 - Longview, Texas 75602**
 - Attn: Warranty Department**
- E.** STEMCO will provide you a written report of the analysis.

Failure Analysis



Burr in Hub

Deep axial cuts on the OD of this seal created a leak path for oil. Proper inspection and clean-up of the hub can eliminate this problem.

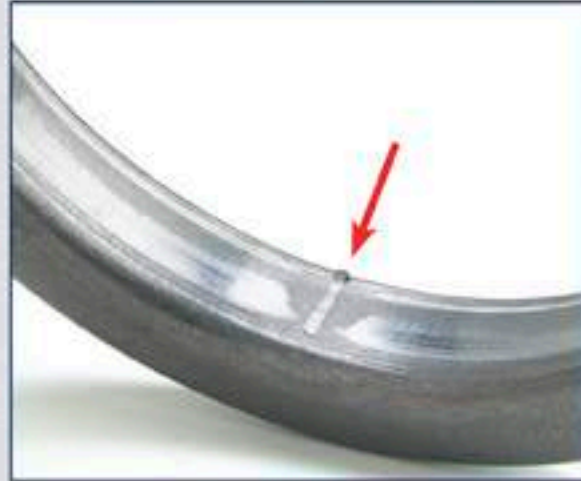

Burr on Spindle

Deep axial cuts on the ID of this axle ring created a leak path for oil. Proper inspection and clean-up of the spindle can eliminate this problem.

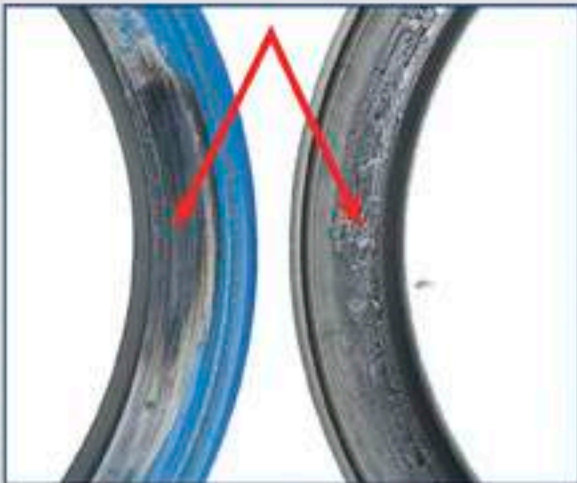

Cocked Seal

The high friction area shown on the left in one position on the seal face and the gouged metal in the axle ring are indicators of a seal being installed in a cocked position. The result can be increased heat and pumping of oil caused by the eccentric run out of the seal.



Bumped Spindle

Heavy facial damage is an indication that the seal incurred a hard impact with the spindle during the docking procedure. The result is damaged internal components that prevent proper sealing. The docking procedure is very important, as the critical elements of the seal are in close proximity to the spindle.

Failure Analysis



Incorrect Installation Tool

The seal on the right was installed with an incorrect tool, causing the outer case to bend. Note the clearance gap on the seal to the left and the lack of this critical characteristic on the right. This damage is detrimental to the proper function of the seal.



Ring with Rust in Groove

This axle ring shows signs of rust, indicating that water was present in the lubricant. Investigation to determine the source of the water will prevent this occurrence in the future.



Rubber Peeled Back

The condition of the rubber OD of this Guardian® Seal was caused by a hub being improperly docked. The misalignment of the hub and seal caused the rubber OD to be peeled back. Follow Guardian installation instructions to prevent this problem. A clean, rust free seal bore is also necessary.

Failure Analysis



Poor Lip

Normal performance of seals will not destroy the seal lip as seen here. This condition occurs as a result of excessive and abrasive contaminants in the wheel end. Proper clean-up and inspection of bearings will prevent this.



Damaged Hubodometer® Face

Facial impact or damage caused when changing tires can result in a cracked cover and potential internal damage.



Hubodometer® with Bent Stud

This condition is the result of a tire/rim assembly being dropped or resting on the Hubodometer. The resulting damage destroys the ability of the Hubodometer to perform properly.



Hubodometer® with Ridge at Base of Stud

A ridge or groove at the base of the stud indicates the Hubodometer was not tight on the bracket and was spinning in the mounting hole of the bracket.

Failure Analysis



Bulged Window on Hub Cap

The bulged, discolored appearance of this hub cap window is an indication that the wheel has experienced high temperatures resulting from improperly adjusted bearings, low lubrication or possibly brake problems.



Impact to Hub Cap

Damage to hub caps such as this is due to heavy impact and can cause leakage under the window.



Overtorque of Flange Nuts

Damage to the flange of this hub cap occurred when the flange nuts were overtightened and proper tightening procedure was not used to evenly fasten the hub cap in place. Use of air impacts with excessive torque settings may also contribute to this problem.



Failure Analysis

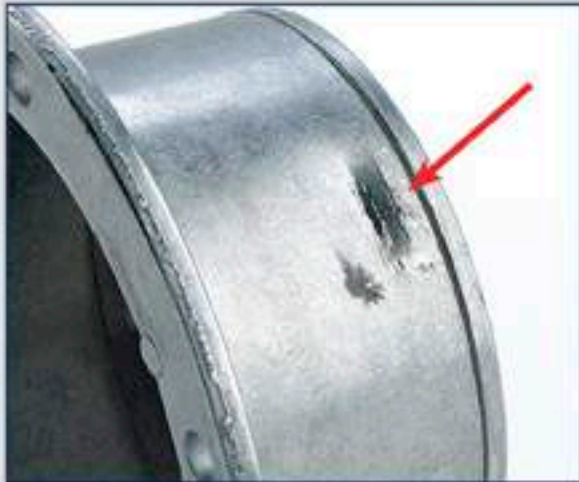

Punctured Hub Cap Casting

This damage is most often caused by tire/wheel assemblies being dropped on the hub cap during removal. The result is heavy loss of oil.

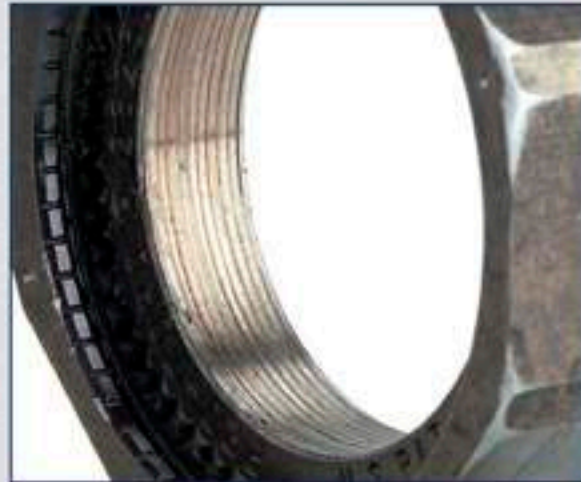

PRO-TORQ® - No Threads

Failure to remove the orange keeper before removing the PRO-TORQ® Nut will result in damaged threads to both the nut and the spindle.



STEMCO Universal Tool System

Recognizing that most seal failures can be traced to improper installation, STEMCO has designed Universal Hub and Axle Tools to make the procedure simpler and precise. Compromising proper installation by using anything other than the specified STEMCO tool can be very costly.



Failure Analysis

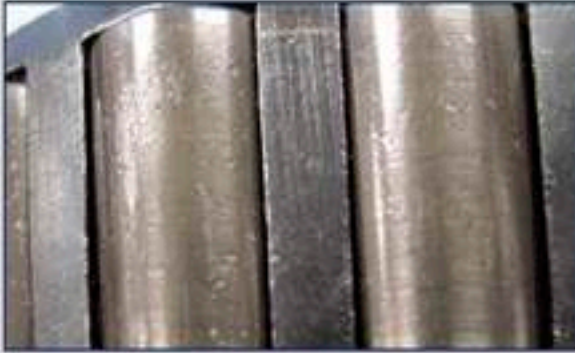

1. Contamination

- **Appearance** - Dents or impressions in rollers or raceways.
- **Causes** - Presence of foreign material in wheel.
- **Remedies** - Leave bearings in their original packages until time of installation. Install bearings in clean environment (hands, tools, etc.). Make sure hub is free from contamination.



2. Corrosion

- **Appearance** - Staining, rusting, and/or pitting of bearing surfaces.
- **Causes** - Moisture (water) in wheel end.
- **Remedies** - Replace lubricant. Use caution to make sure water is not introduced into the wheel end.



3. Inadequate or Improper Lubrication

- **Appearance** - Partial or large area welding, scoring, signs of excessive heat, metal to metal contact.
- **Causes** - Use of improper lubricant or inadequate quantity of lubricant. Overloading of bearings or excessive pre-load can exhibit similar appearance to inadequate lubrication.
- **Remedies** - Follow the manufacturer's recommendations for proper lubricant fill quantities and use of appropriate lubricants. Be sure to follow manufacturer recommendations for proper bearing adjustment.

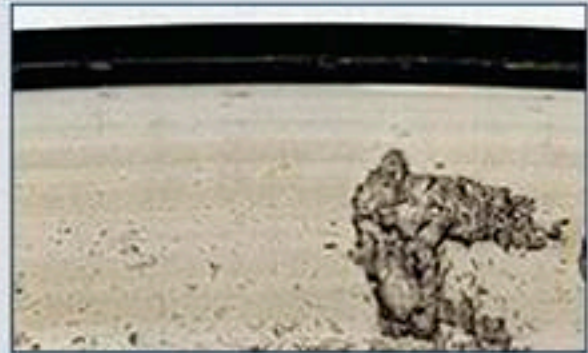

4. Spalling / Fatigue

- **Appearance** - Missing material from surfaces of bearing rolling elements or raceways.
- **Causes** - Normal fatigue (life) of bearings, contamination, or excessive loading.
- **Remedies** - If due to normal life, replace bearings. If cause is other than normal life, correct per recommendations for that failure mode.

STEMCO® Tech Tip #11

Hub Cap Lubricant Installation Procedure for Oil, Semi-Fluid Grease and Hard Pack Grease

The purpose of this document is to inform customers of proper lubrication methods for SENTINEL® hub caps with oil, SENTINEL®, stamped steel, duckbill vented stamped steel, dirt exclusion hub caps with semi-fluid grease and stamped steel hubcaps with hard pack grease.

Oil Lubricant

SENTINEL® Hub Caps

When using oil lubricants, the following procedure should be followed. Adherence to this procedure will result in longer wheel end life and improved performance.

STEP 1 After the hub cap has been installed on hub, slowly pour oil through side fill hole. Allow the oil to flow into the hub cavity and do not fill the oil level past the bottom of the red cover or the red shaded area below. Allow two to three minutes for the oil to migrate into the hub cavity and repeat process as needed until the oil level is at the full line on the clear hub cap window. **DO NOT COVER THE VENT MECHANISM WITH LUBRICANT.**

NOTE: Failure to follow the above procedure will result in “filming” or cosmetic seepage of lubricant through the center vent onto the external face of the hub cap during initial operation.

Sentinel® Application	Approximate Fluid Ounces of Lubricant
349-4009	3.5 fl. oz.
349-4013	3.5 fl. oz.
349-4046	2.9 fl. oz.
349-4075	7.2 fl. oz.
349-4095	2.4 fl. oz.



Fig. 1: Fill Level for Oil

Semi-Fluid Grease

SENTINEL®, Dirt Exclusion, Duckbill Vent, Solid Aluminium Grease Hub Caps

When using semi-fluid lubricants, it is recommended to add lubricant to the hub caps to provide added lubrication to the outer bearing. Adherence to this procedure will result in longer wheel end life and improved performance. Addition of semi-fluid lubricant should be completed as follows:

STEP 1 Holding the hub cap as shown (Figure 2), fill the lower side of the hub cap until level with the inner edge of the mounting flange and the edge of the vent mechanism. **DO NOT COVER THE VENT MECHANISM WITH LUBRICANT!** Failure to follow the above procedure will result in “filming” or cosmetic seepage of lubricant from the vent onto the external face of the hub cap during initial operation.

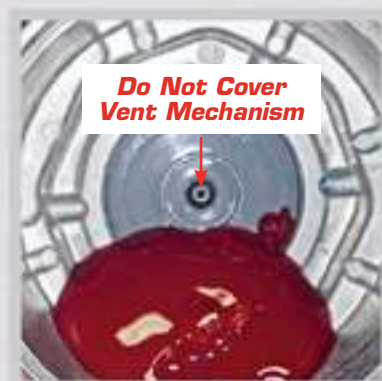

Fig. 2: Fill Level for Semi-fluid Grease

STEP 2 Install the hub cap quickly to prevent spilling the lubricant.

STEMCO® Tech Tip #11

Hard Pack Grease

Stamped Steel Hub Caps

STEMCO stamped steel hub caps are zinc dichromate plated to provide corrosion protection and a superior finish. While the plating provides ample protection in most instances, there are conditions which can accelerate corrosion beyond the capability of the plating. For this reason, STEMCO recommends that all stamped steel hub caps be internally coated prior to installation, except for the vent, with a thin layer of lubricant. Coating should be performed as follows:

STEP 1 Using a clean brush or your hand (*Figure 3*), wipe the inner surfaces of the stamped hub cap with a thin layer of lubricant until all areas are covered as shown. **DO NOT COVER THE VENT MECHANISM WITH LUBRICANT.** Failure to follow the above procedure will result in “filming” or seepage of lubricant from the vent onto the external face of the hub cap during initial operation, and may clog the vent in some cases.

STEP 2 For this purpose, NLGI grade 2 or 3 hard pack greases are the preferred lubricants, as they do not flow and will maintain coverage of the plating on the internal surface of the hub cap.

STEP 3 Install the hub cap per normal installation practices.

STEP 4 Use this procedure on all STEMCO stamped steel hub caps.

Lubrication

With the vast array of wheel end configurations and operating variables, STEMCO recommends following manufacturer’s recommendations for lubricant selection.

Additionally, STEMCO endorses The Maintenance Council’s recommended practice RP 631 (Recommendations for Wheel End Lubrication) and RP 624 (Lubricant Fundamentals), available from TMC.

STEMCO Tech Tips are developed to provide detailed information about particular products and/or procedures. These Tech Tips are available from STEMCO by requesting the numbers noted below.



Fig. 3: Paint in the inside of stamped steel hub cap will grease

STEMCO Tech Tips			
Tech Tip	Technical Information	Tech Tip	Technical Information
#3	Moisture Ejector Installation	#21	Inspection and Service Intervals for STEMCO Systems
#5	Guardian® HP Wheel Seals - Proper Installation	#23	PRO-TORQ® Keeper Replacement Interval
#6	Guardian® HP Wheel Seals - Lubricant Compatibility	#24	Sentinel® ESP Filtered Vent
#8	Installation for PRO-TORQ® P/N's 449-4974 & 449-4975	#26	Installation for PRO-TORQ® Part Number 448-4837
#11	Procedure for Using Semi-fluid Lubricants	#29	Leaky Seal
#12	Improved Universal Axle Tool	#34	STEMCO Approved Lubricants
#13	Sentinel® Products & Internal Vacuum	#35	Product Improvement - Sentinel® Hub Caps
#14	448-4836/448-4837 Keeper Removal Procedure	#38	Product Improvement - Guardian® HP
#15	392-9112 & 392-9130 Grit Guard® Sets Commonality	#50	ConMet Conversion

STEMCO® Warranty

STEMCO® Standard Components

1 Year Warranty

STEMCO warrants to Buyer that all components sold will be free from defects in material and workmanship. This warranty is limited to components installed on vehicles licensed for on-highway use under normal use and service. This warranty extends for a period of one year from the date of manufacture.

The Buyer's exclusive remedy under this warranty shall be the repair or replacement of STEMCO components, but not the cost of removal or installation. STEMCO reserves the right to require that all warranty claim components are available and/or returned for review and evaluation. STEMCO shall not be liable for any claim, whether arising from breach of contract or warranty or claims of negligence or negligent manufacture, in excess of the purchase price. In no event shall STEMCO be liable for special, incidental, indirect, or consequential, or collateral, losses or damages of any kind.

This limited warranty is in lieu of all other warranties or conditions, expressed or implied, including any implied warranty of merchantability or fitness for particular purpose. This is the only warranty offered by STEMCO and no STEMCO employee or representative is authorized to extend additional warranty terms on behalf of STEMCO.

3 Year Warranty

PLATINUM
PERFORMANCE SYSTEM™

Trailer:
Unlimited
Mileage

Tractor:
Unlimited
Mileage

5 Year Warranty

PLATINUM PLUS
PERFORMANCE SYSTEM™

Trailer:
Unlimited Mileage

7 Year Warranty

PLATINUM PLUS 7
PERFORMANCE SYSTEM™

Trailer:
Unlimited Mileage

500,000 Mile Warranty

HUBODOMETER®
GUARANTEED OVER-LIFE-OF-TIRE ACCURACY

The STEMCO Hubodometer® is warranted for 500,000 miles when installed in accordance with its specifications.

4 Year/500,000 Mile Warranty

DataTrac®
**DataTrac®
PRO**

DataTrac® is warranted for 4 years / 500,000 miles when installed in accordance with its specifications.



WHEN IT COMES TO TRAINING WE HOLD OURSELVES TO A HIGHER STANDARD

STEMCO WHEEL END PRODUCTS™

- Wheel end failure analysis and rebuild
- Proper seal and bearing installation
- Single and double nut adjustment procedures
- Oil and grease lubrication best practices

STEMCO BRAKE PRODUCTS™

- Foundation basics
- Brake balance
- Auto Brake Adjusters

STEMCO SUSPENSION PRODUCTS™

- King pin replacement for Qwik Kits and Plus Kits
- Complete break down and rebuild training

STEMCO INNOVATIVE TIRE & MILEAGE SOLUTIONS | ITMS™

- Tire inflation management
- Mileage management
- Tire pressure monitoring
- Trailer aerodynamics

To request training on any or all of these products,
contact your local STEMCO District Sales Manager.

STEMCO QUALITY PRODUCTS

Guardian[®]
HP



Voyager[®]



Discover[®]



PRO-TORQ[®]



SENTINEL[®]



HEAVY DUTY BEARINGS



GOODYEAR[®]
AIR SPRINGS



TrailerTail[®]
BY STEMCO



STEMCO
GAFF[™]



STEMCO
KAISER[®]



STEMCO
MOTOR WHEEL[®]



STEMCO
BRAKE PRODUCTS[®]



AERIS
SMARTSENSE[®]
BY STEMCO



STEMCO
CREWSON[™]
AUTOMATIC BRAKE ADJUSTER



PLATINUM PLUS⁷
PERFORMANCE SYSTEM



Table of Contents

ORDERING GUIDE

- 03 Replacement Panels

TRAILERTAIL® 4X4 PANELS

- 05 Lateral Panel
- 06 4x4 Family #1L
- 07 4x4 Family #2L
- 08 4x4 Family #3L
- 09 4x4 Family #4L
- 10 4x4 Family #5L
- 11 4x4 Family #6L
- 12 4x4 Family #7L
- 13 Top Panel
- 14 4x4 Family #1T
- 15 4x4 Family #2T
- 16 4x4 Family #3T
- 17 4x4 Family #4T
- 18 Bottom Panel
- 19 4x4 Family #1B
- 20 4x4 Family #2B
- 21 4x4 Family #3B
- 22 4x4 Family #4B
- 23 4x4 Family #5B
- 24 4x4 Family #6B
- 25 4x4 Family #7B
- 26 4x4 Family #8B

TRAILERTAIL® TRIDENT PANELS

- 27 Lateral Panel
- 28 TRI Family #1L
- 29 TRI Family #2L
- 30 TRI Family #3L
- 31 TRI Family #4L
- 32 TRI Family #5L
- 33 Top Panel
- 34 TRI Family #1T
- 35 TRI Family #2T
- 36 TRI Family #3T
- 37 TRI Family #4T

SPARE AND REPLACEMENT PARTS

- 38 Brackets
- 43 Other Metal Hardware
- 49 Fasteners
- 50 Miscellaneous
- 52 Decals
- 54 AutoDeploy® & ZeroTouch® Components

APPENDIX A

- 60 TrailerTail® 4x4 Parts Diagram
- 64 TrailerTail® Trident Parts Diagram

APPENDIX B

- 67 Onsite Panel Modifications

INDEX

- 71 Part Numbers

TrailerTail® 4x4



TrailerTail® Trident



Replacement Panels

Lateral Panels:

1. Follow the instructions for TrailerTail® 4x4 or Trident lateral panels to determine the family number.
 - See page 05 for 4x4 lateral panels.
 - See page 27 for Trident lateral panels.
2. Follow the instructions on the family page to determine the panel part numbers.
 - For measurements between holes, measure between the center of the holes. Measurement errors up to a ¼" are acceptable.
 - Variations of options on panels are indicated by a dashed-line box with a small number in the top right corner. For each option, choose the variation that matches your panel. Holes outlined in red indicate differences. Holes outlined in black indicate reference holes.
3. Replacement lateral panels do not come with hinge cutouts or visibility cutouts. See Appendix B on page 67 for details on how to make panel modifications.
4. Replacement lateral panels do not come with mounting hinges. If existing mounting hinges cannot be reused or are damaged, you will need these additional components:
 - Dry van trailers:
 - (x4) ATD000147 *ASY Lateral Hinge* per lateral panel
 - (x1) ATD001859 *ASY KIT Bolt, Carriage, 0.375 in x 16, 1.25 in (x45) & Nut, Flange, 0.375 in x 16 (x45), Kit 19*; needed only if door mounting hardware is lost or damaged
 - Drop frame trailers:
 - (x5) ATD000147 *ASY Lateral Hinge* per lateral panel
 - (x1) ATD001859 *ASY KIT Bolt, Carriage, 0.375 in x 16, 1.25 in (x45) & Nut, Flange, 0.375 in x 16 (x45), Kit 19*; needed only if door mounting hardware is lost or damaged
 - Refrigerated trailers:
 - (x4) ATD000004 *Lateral Hinge Female* per lateral panel
 - (x4) ATD001134 *ASY Hinge Male, Self-Adhering* per lateral panel (cannot be used on Wabash trailers), or
 - (x4) ATD001135 *ASY Hinge Male, Extended Mounted, Self-Adhering* per lateral panel (must be used on Wabash trailers; can be used on any refrigerated trailer only if existing hinge matches)
 - (x1) ATD001856 *ASY KIT Bolt, Hex, 0.3125 in x 18, 3.75 in (x30) & Nut, Lock, 0.3125 in x 18 (x31) & Washer, 0.3125 in (x26), Kit 16*; four nuts and bolts are needed per lateral panel
 - (x1) ATD000960 *ASY KIT Rivet, Bulb-Tite, 0.25 in (x90)*; needed only if hinge mounted on door is replaced
5. Part numbers of panels may not define the color of the panel. Default color for panels is white. If your panels are a different color, notify Customer Support when ordering. Part number shipped may differ.
6. Part numbers of panels do not define decal layouts. Default decal layout is shown on page 05. If your panels have custom decals, notify Customer Support when ordering.

Top and Bottom Panels:

1. Follow the instructions for TrailerTail® 4x4 or Trident panels to determine the family number.
 - See page 13 for 4x4 top panels.
 - See page 18 for 4x4 bottom panels.
 - See page 33 for Trident top panels.

2. Follow the instructions on the family page to determine the panel part numbers.
 - For measurements between holes, measure between the center of the holes. Measurement errors up to a ¼" are acceptable.
 - Variations of options on panels are indicated by a dashed-line box with a small number in the top right corner. For each option, choose the variation that matches your panel. Holes outlined in red indicate differences. Holes outlined in black indicate reference holes.

3. Replacement bottom panels do not come with vent door cutouts. See Appendix B on page 67 for details on how to make panel modifications.

4. Replacement top and bottom panels may or may not come with mounting hinges. See guide below for ordering. Damaged mounting hinges should always be replaced.
 - Dry van trailers:
 - Mounting hinges are included with replacement panels
 - (x1) ATD001859 ASY KIT Bolt, Carriage, 0.375 in x 16, 1.25 in (x45) & Nut, Flange, 0.375 in x 16 (x45), Kit 19; needed only if door mounting hardware is lost or damaged
 - Refrigerated trailers:
 - (x1) ATD001137 ASY Hinge Male Short, Self-Adhering per top or bottom panel assembly
 - (x1) ATD001134 ASY Hinge Male, Self-Adhering per top or bottom panel assembly (cannot be used on Wabash trailers), or
 - (x1) ATD001136 ASY Hinge Male, Clearance, Self-Adhering per top or bottom panel assembly (must be used on Wabash trailers; can be used on any refrigerated trailer only if existing hinge matches)
 - (x1) ATD001856 ASY KIT Bolt, Hex, 0.3125 in x 18, 3.75 in (x30) & Nut, Lock, 0.3125 in x 18 (x31) & Washer, 0.3125 in (x26), Kit 16; four nuts and bolts are needed per lateral panel
 - (x1) ATD000960 ASY KIT Rivet, Bulb-Tite, 0.25 in (x90); needed only if hinge mounted on door is replaced

5. Part numbers of panels may not define the color of the panel. Default color for panels is white. If your panels are different, notify Customer Support when ordering. Part number shipped may differ.

Lateral Panel

Instructions:

1. Measure the distance between the holes highlighted in blue (Distance A).
2. Measure the width of the panel (Distance B).
3. Measure the length of the panel along the longest edge (Distance C).
4. Determine the family number of your panel from the table below. Flip to the page of that family.

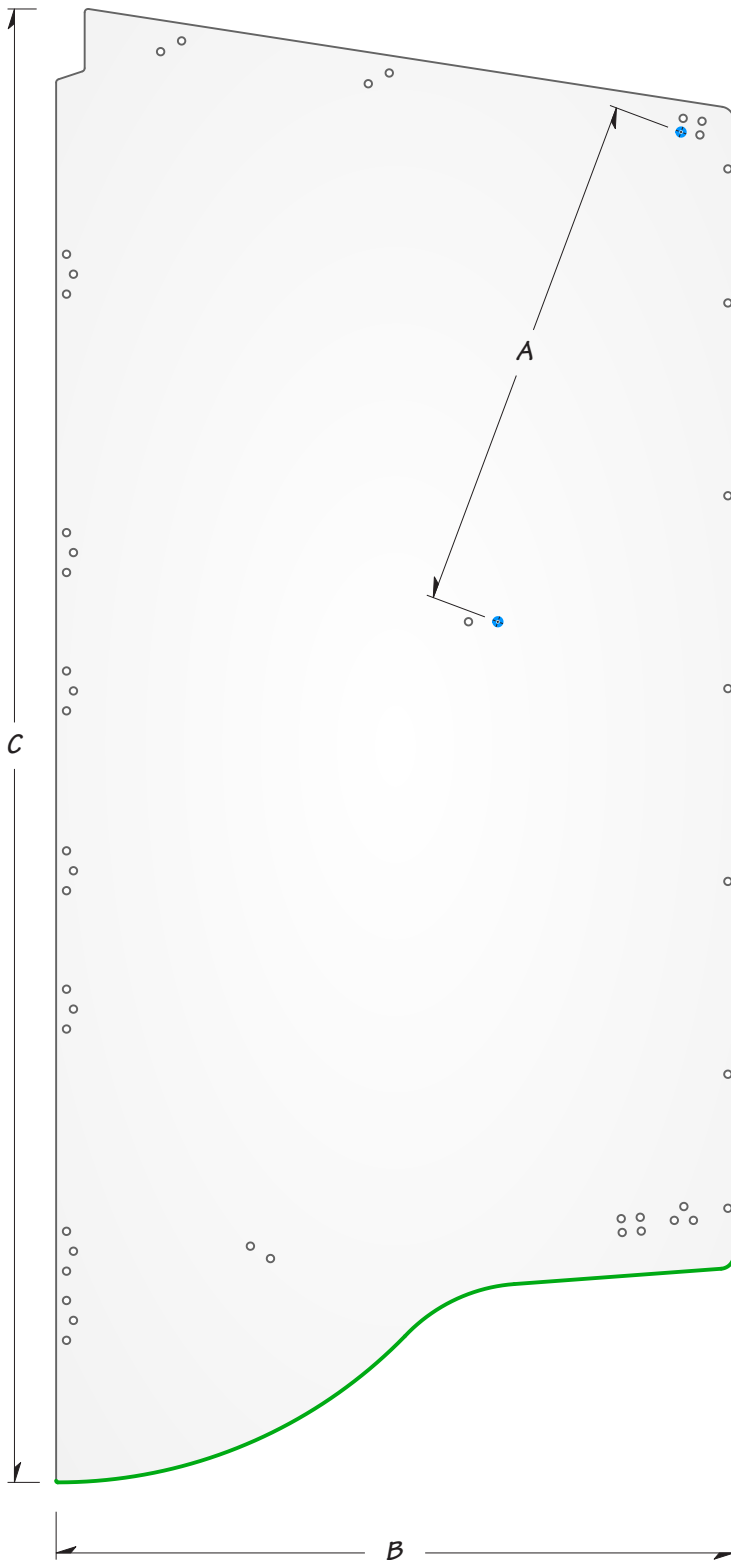

Family	A	B	C
4x4 #1L	32 1/2"	49"	<112"
4x4 #2L	35 3/4"	48 1/4"	<112"
4x4 #3L	36"	49"	<112"
4x4 #4L*	37 3/4"	49"	<112"
4x4 #5L	39 5/8"	49"	<112"
4x4 #6L	41 1/2"	49"	—
4x4 #7L	37 3/4"	49"	≥112"

**Indicates most common configuration family.*

By default, all lateral panels ordered will be **white** and will come with **standard TrailerTail®** decals in the approximate location shown. If your panels are a *different color* or you have a *different decal layout* or *custom decals*, you must notify Customer Support when ordering.

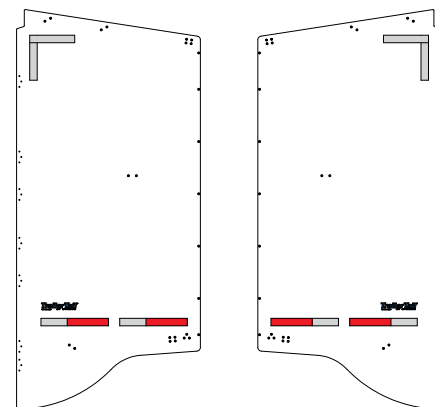

Note:

Your lateral panel bottom edge contour, highlighted in green, may vary. You may need to trim for lock rods, hazard placards, and other door accessories.

See Appendix B on page 67.

4x4 Family #1L

Instructions:

1. Choose the respective roadside (RDS) or curbside (CBS) part number for your panel.

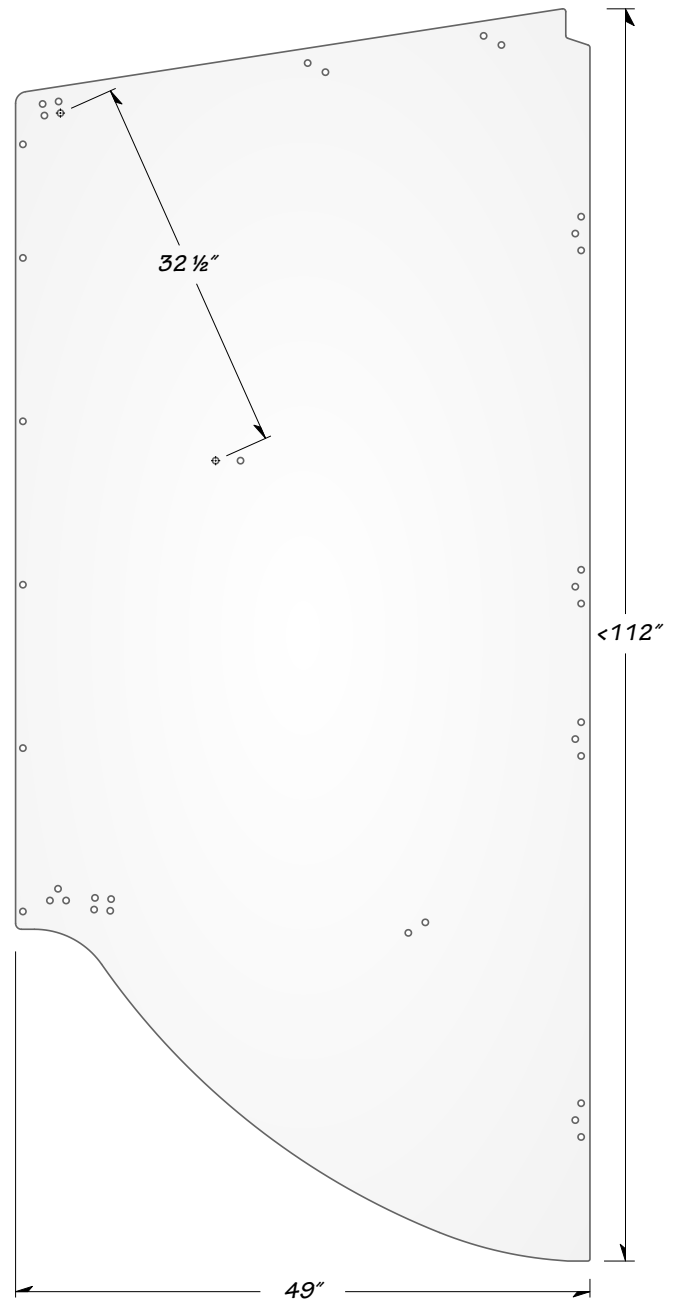

Lateral Panel Part Numbers†

RDS P/N	CBS P/N
ATD002844	ATD002845

†All lateral panels ordered will come pre-assembled with appropriate brackets, stiffeners, mechanical latches and cable components. Mounting hinges are **not** included.

Default color for lateral panels is white and will come with standard TrailerTail® decals (see page 05). If your panels are a different color or you have a different decal layout or custom decals, notify Customer Support when ordering.

4x4 Family #2L

Instructions:

1. Locate the variations of each dotted lined box using the number(s) in the top right corner.
2. Determine the variation you have for each number based on the hole pattern highlighted in red. Note the name of your variation.
3. Determine your latch type by choosing the design that best matches your existing latch.
4. Choose the respective roadside (RDS) or curbside (CBS) part number for your panel.

Secondary Latch

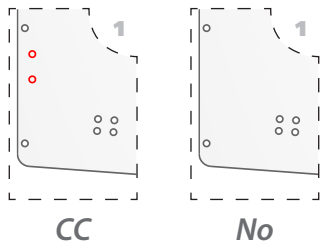

CC

No

Latch Type

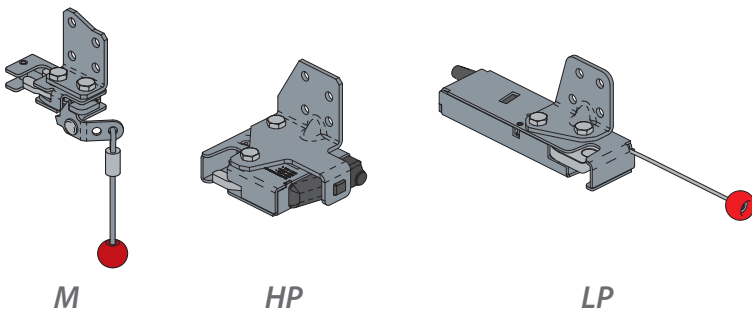

M

HP

LP

If you have latch type "HP" and it is **not reusable** or is damaged, choose from the part numbers with the "LP" latch type. Additionally, you will need latches from the list of **low-profile latch replacement kits** on page 55.

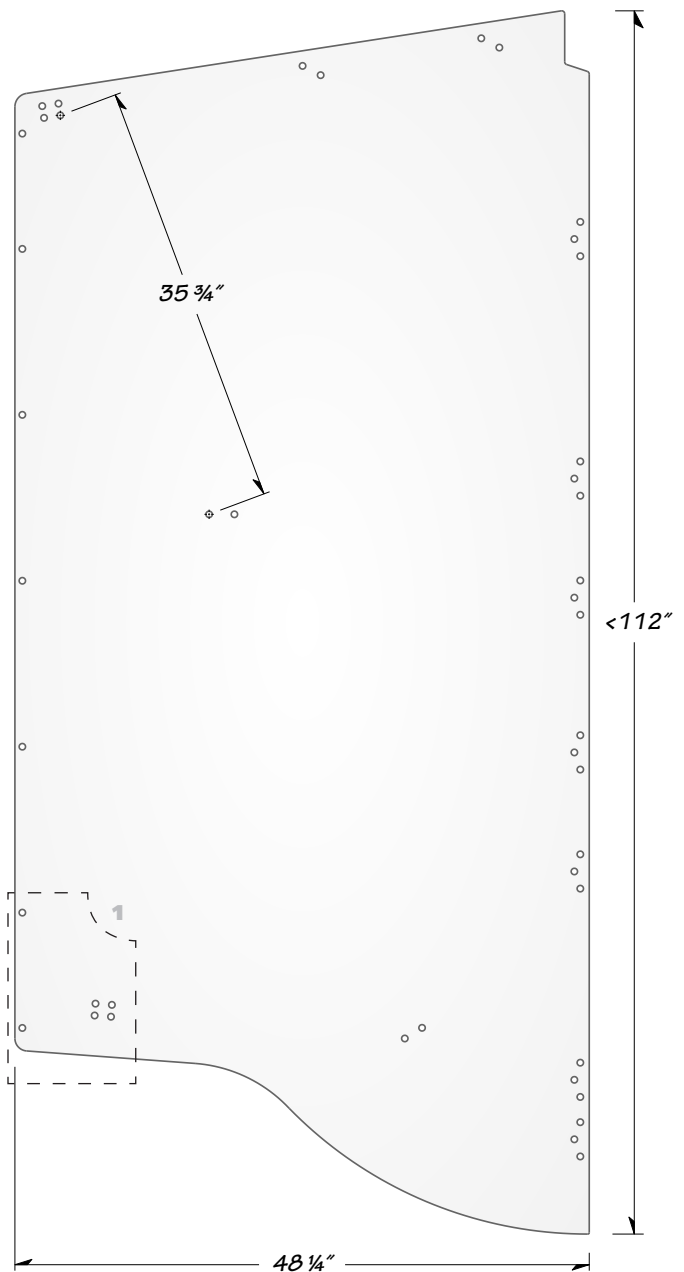

Lateral Panel Part Numbers [†]		Latch Type	¹ Secondary Latch
RDS P/N	CBS P/N	M, HP or LP	CC
ATD001912	ATD001913	M	No
ATD002849	ATD002850	M	CC
ATD002854	ATD002855	HP	No
ATD002859	ATD002860	HP	CC
<i>(Contact STEMCO)</i>		LP	No

[†]All lateral panels ordered will come pre-assembled with appropriate brackets, stiffeners, mechanical latches and cable components. Mounting hinges and AutoDeploy electronic latches are **not** included. Default color for lateral panels is white and will come with standard TrailerTail® decals (see page 05). If your panels are a different color or you have a different decal layout or custom decals, notify Customer Support when ordering.

4x4 Family #3L

Instructions:

1. Locate the variations of each dotted lined box using the number(s) in the top right corner.
2. Determine the variation you have for each number based on the hole pattern highlighted in red. Note the name of your variation.
3. Determine your latch type by choosing the design that best matches your existing latch.
4. Choose the respective roadside (RDS) or curbside (CBS) part number for your panel.

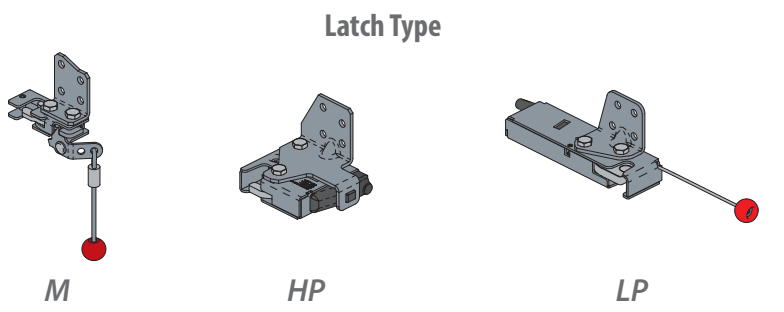
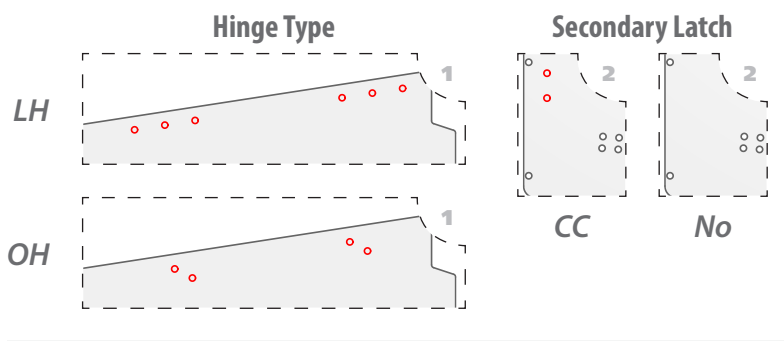

If you have latch type "HP" and it is **not reusable** or is damaged, choose from the part numbers with the "LP" latch type. Additionally, you will need latches from the list of **low-profile latch replacement kits** on page 55.

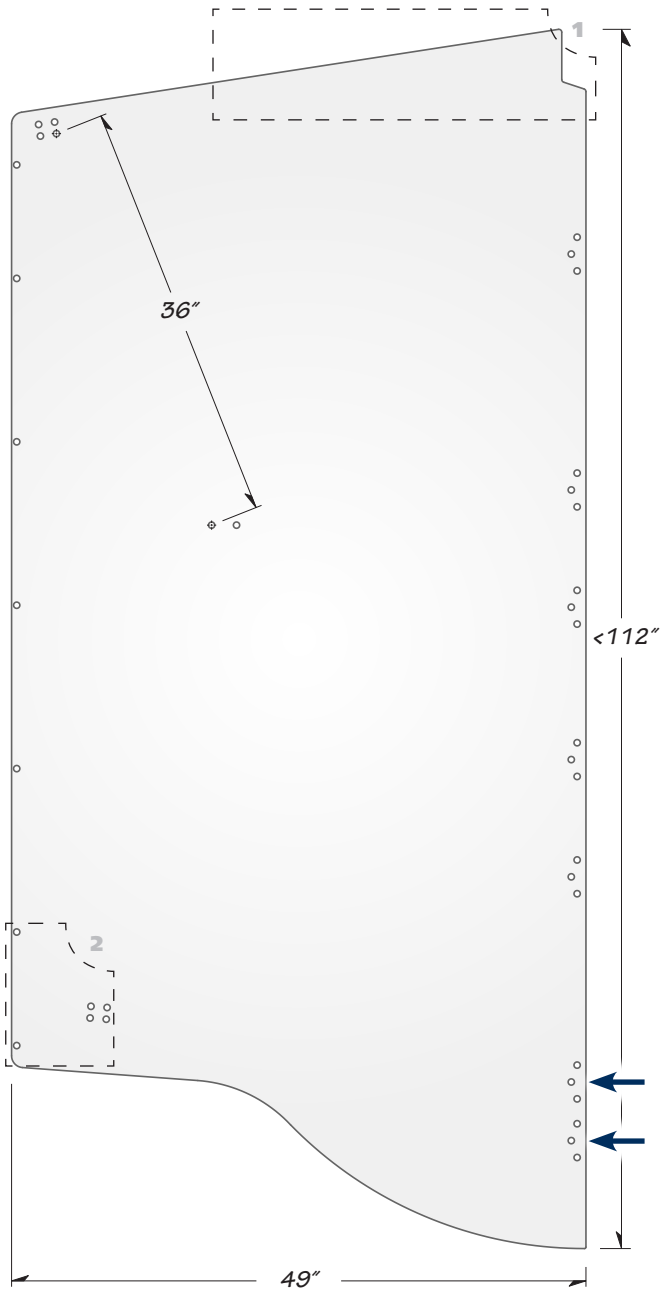

→ If neither set of bottom holes fits attached hinge on door, new holes will need to be drilled on-site.

Lateral Panel Part Numbers [†]		Latch Type	¹ Hinge Type	² Secondary Latch
RDS P/N	CBS P/N	M, HP or LP	OH or LH	CC
ATD000764	ATD000765	M	OH	No
ATD000764A0	ATD000765A0	M	LH	No
ATD002804	ATD002805	M	OH	CC
ATD002804B	ATD002805B	M	LH	CC
ATD002001	ATD002002	HP	OH	No
ATD001295	ATD001296	HP	OH	CC
<i>(Contact STEMCO)</i>		LP	OH	No

[†]All lateral panels ordered will come pre-assembled with appropriate brackets, stiffeners, mechanical latches and cable components. Mounting hinges and AutoDeploy electronic latches are **not** included.

Default color for lateral panels is white and will come with standard TrailerTail® decals (see page 05). If your panels are a different color or you have a different decal layout or custom decals, notify Customer Support when ordering.

4x4 Family #4L

(Most common family configuration)

Instructions:

1. Locate the variations of each dotted lined box using the number(s) in the top right corner.
2. Determine the variation you have for each number based on the hole pattern highlighted in red. Note the name of your variation.
3. Determine your latch type by choosing the design that best matches your existing latch.
4. Choose the respective roadside (RDS) or curbside (CBS) part number for your panel.

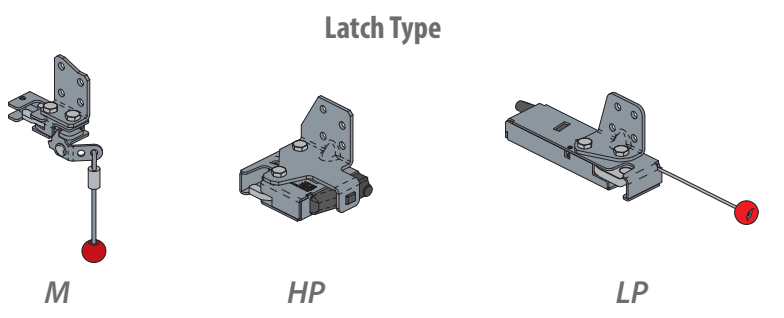
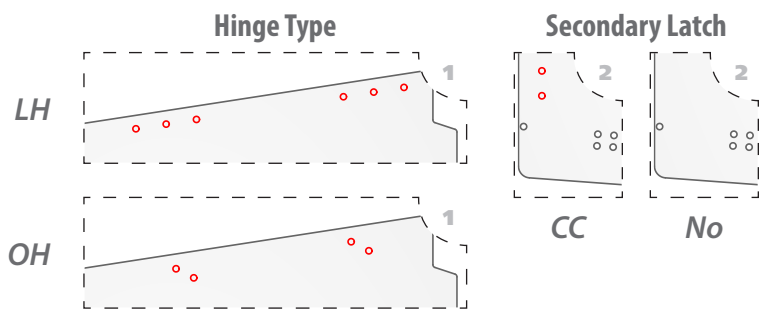

If you have latch type "HP" and it is **not reusable** or is damaged, choose from the part numbers with the "LP" latch type. Additionally, you will need latches from the list of **low-profile latch replacement kits** on page 55.

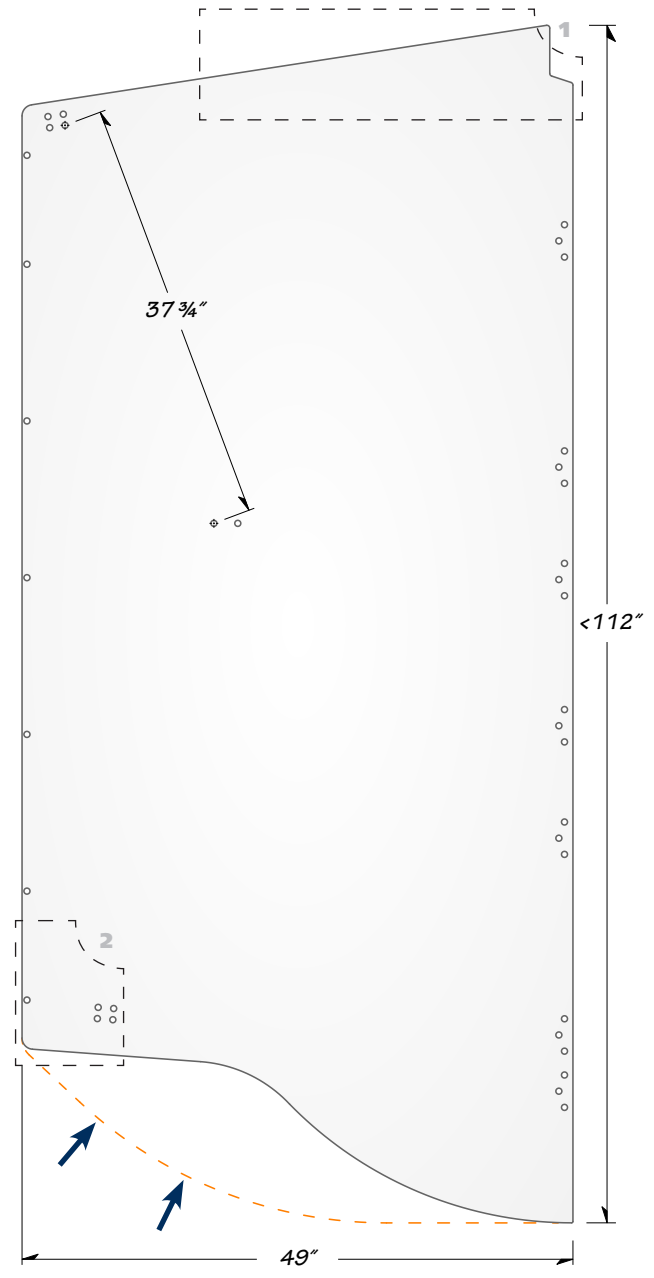

➔ If the bottom contour of your lateral panel looks similar to the orange dotted line, choose from the part numbers with a "Yes" in the Covered column.

Lateral Panel Part Numbers [†]		Latch Type	1 Hinge Type	2 Secondary Latch	3 Covered
RDS P/N	CBS P/N	M, HP or LP	OH or LH	CC	X
ATD000148	ATD000149	M	OH	No	No
ATD000148B	ATD000149B	M	LH	No	No
ATD002065	ATD002066	M	OH	CC	No
ATD000825	ATD000826	HP	OH	No	No
ATD000947	ATD000948	HP	OH	CC	No
ATD002931	ATD002932	M	OH	No	Yes
(Contact STEMCO)		LP	OH	No	No

[†]All lateral panels ordered will come pre-assembled with appropriate brackets, stiffeners, mechanical latches and cable components. Mounting hinges and AutoDeploy electronic latches are **not** included.

Default color for lateral panels is white and will come with standard TrailerTail® decals (see page 05). If your panels are a different color or you have a different decal layout or custom decals, notify Customer Support when ordering.

4x4 Family #5L

Instructions:

1. Locate the variations of each dotted lined box using the number(s) in the top right corner.
2. Determine the variation you have for each number based on the hole pattern highlighted in red. Note the name of your variation.
3. Determine your latch type by choosing the design that best matches your existing latch.
4. Choose the respective roadside (RDS) or curbside (CBS) part number for your panel.

Secondary Latch

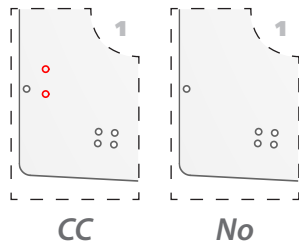

CC

No

Latch Type

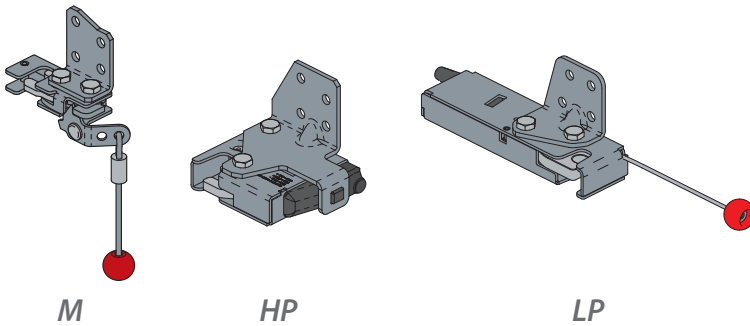

M

HP

LP

If you have latch type "HP" and it is **not reusable** or is damaged, choose from the part numbers with the "LP" latch type. Additionally, you will need latches from the list of **low-profile latch replacement kits** on page 55.

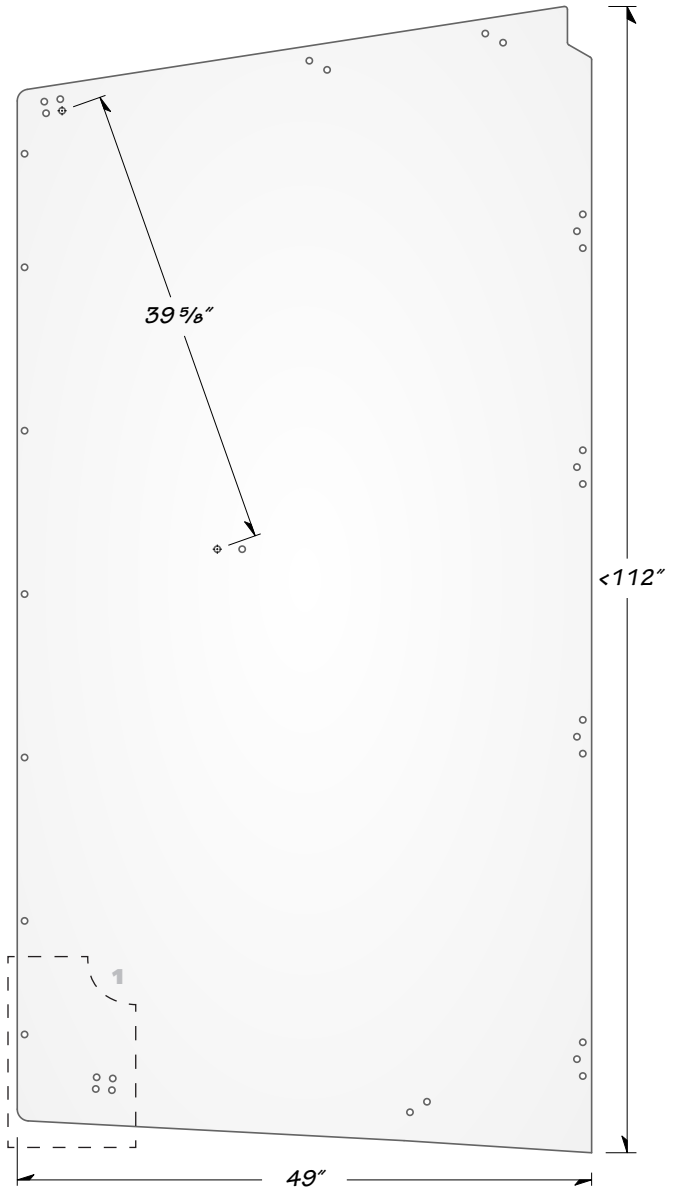

Lateral Panel Part Numbers [†]		Latch Type	¹ Secondary Latch
RDS P/N	CBS P/N	M, HP or LP	CC
ATD002809	ATD002810	M	No
ATD002814	ATD002815	M	CC
ATD002819	ATD002820	HP	No
ATD002824	ATD002825	HP	CC
<i>(Contact STEMCO)</i>		LP	No

[†]All lateral panels ordered will come pre-assembled with appropriate brackets, stiffeners, mechanical latches and cable components. Mounting hinges and AutoDeploy electronic latches are **not** included. Default color for lateral panels is white and will come with standard TrailerTail[®] decals (see page 05). If your panels are a different color or you have a different decal layout or custom decals, notify Customer Support when ordering.

4x4 Family #6L

Instructions:

1. Locate the variations of each dotted lined box using the number(s) in the top right corner.
2. Determine the variation you have for each number based on the hole pattern highlighted in red. Note the name of your variation.
3. Determine your latch type by choosing the design that best matches your existing latch.
4. Choose the respective roadside (RDS) or curbside (CBS) part number for your panel.
5. If your panel height is not greater than 112", please contact Customer Service for your panel part numbers.

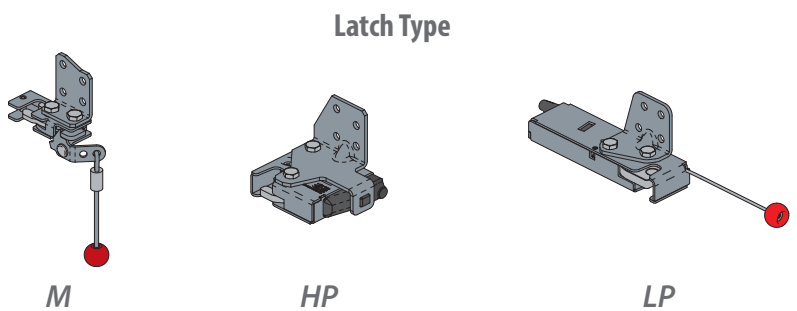
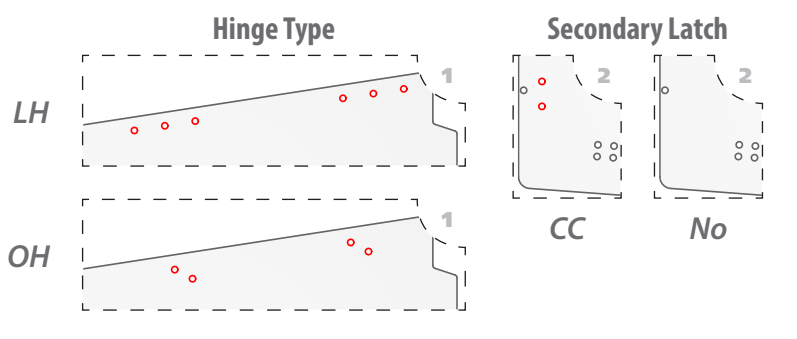

If you have latch type "HP" and it is **not reusable** or is damaged, choose from the part numbers with the "LP" latch type. Additionally, you will need latches from the list of **low-profile latch replacement kits** on page 55.

Lateral Panel Part Numbers [†]		Latch Type	¹ Hinge Type	² Secondary Latch
RDS P/N	CBS P/N	M, HP or LP	OH or LH	CC
ATD001690	ATD001691	M	OH	No
ATD001690B	ATD001691B	M	LH	No
ATD002829	ATD002830	M	OH	CC
ATD002829B	ATD002830B	M	LH	CC
<i>(Contact STEMCO)</i>		LP	OH	No

[†]All lateral panels ordered will come pre-assembled with appropriate brackets, stiffeners, mechanical latches and cable components. Mounting hinges and AutoDeploy electronic latches are **not** included.

Default color for lateral panels is white and will come with standard TrailerTail® decals (see page 05). If your panels are a different color or you have a different decal layout or custom decals, notify Customer Support when ordering.

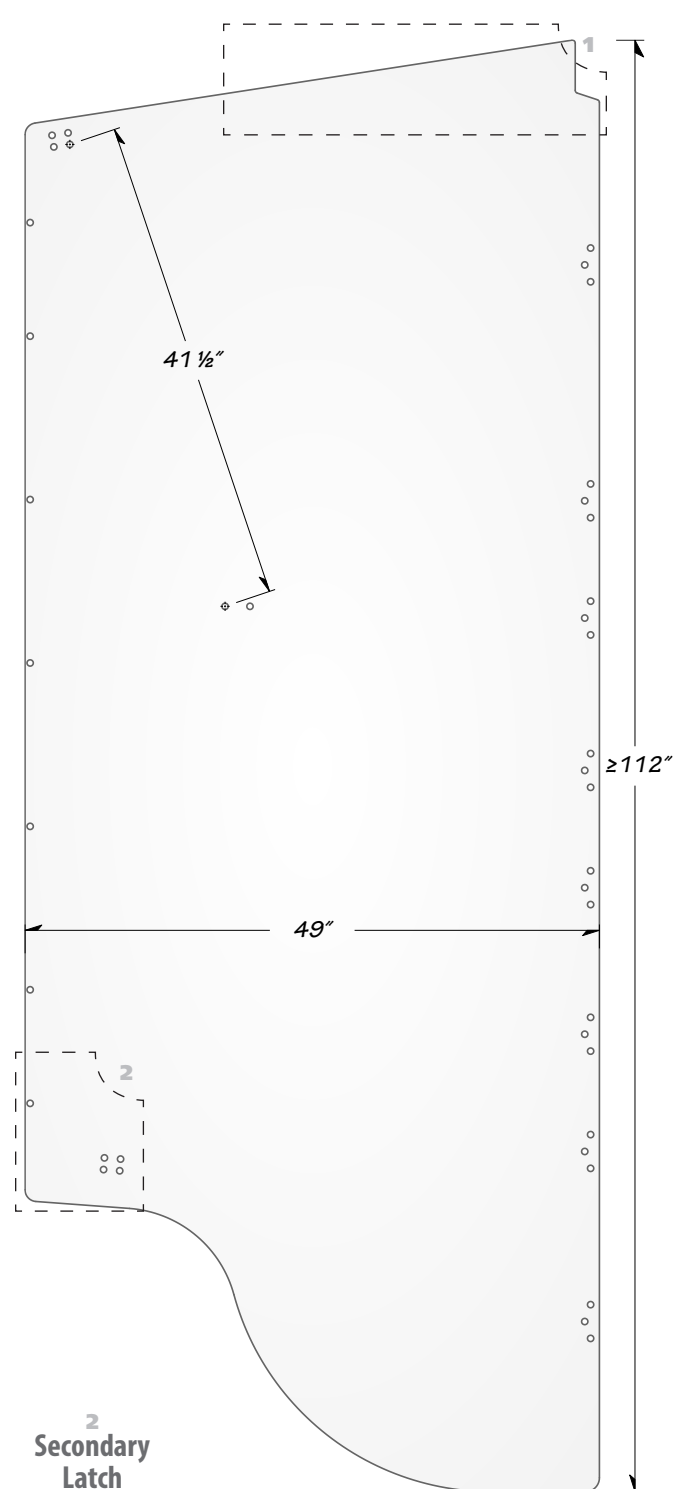

4x4 Family #7L

Instructions:

1. Determine your latch type by choosing the design that best matches your existing latch.
2. Choose the respective roadside (RDS) or curbside (CBS) part number for your panel.

Latch Type

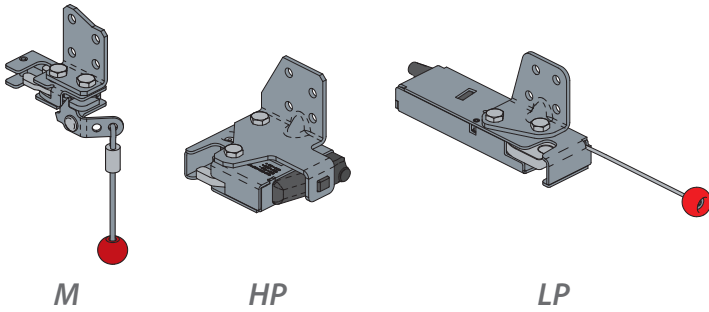

If you have latch type "HP" and it is **not reusable** or is damaged, choose from the part numbers with the "LP" latch type. Additionally, you will need latches from the list of **low-profile latch replacement kits** on page 55.

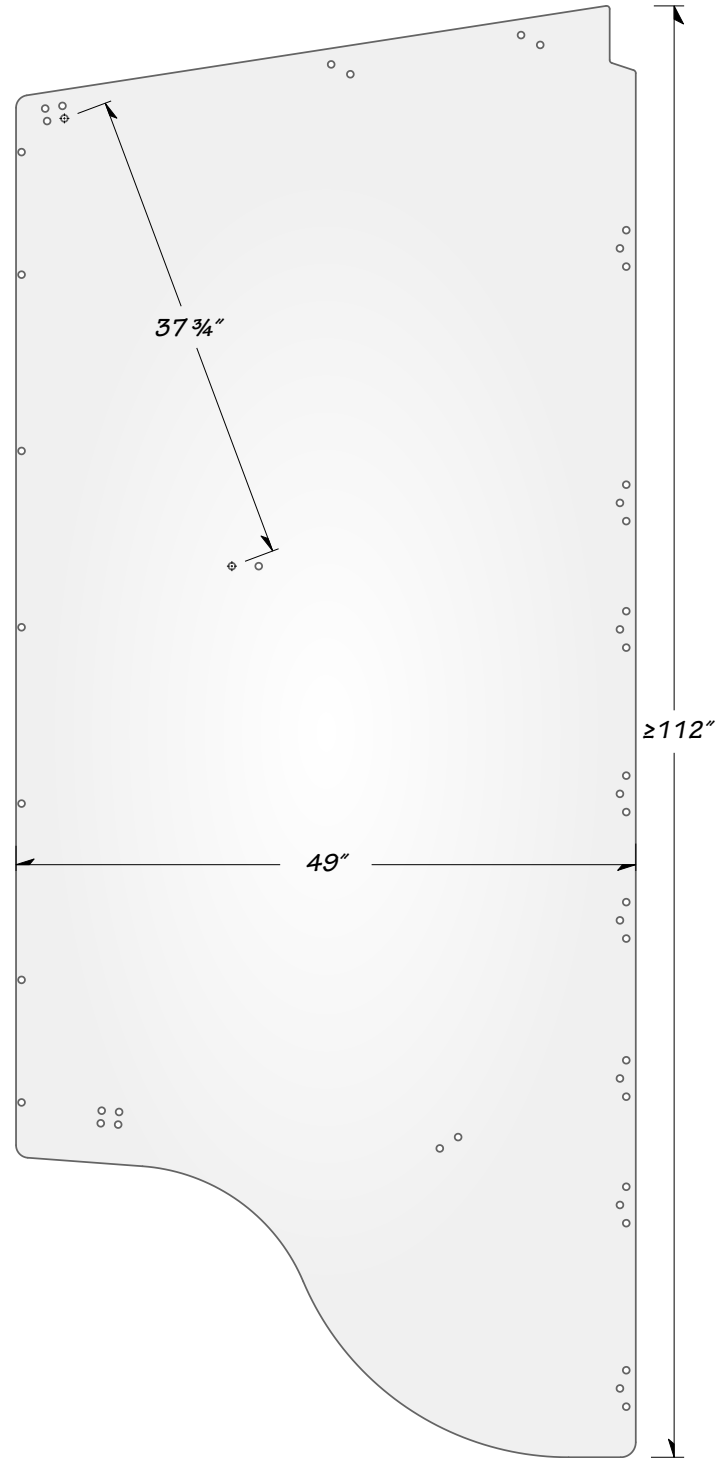

Lateral Panel Part Numbers [†]		Latch Type
RDS P/N	CBS P/N	M or LP
ATD003928	ATD003929	M
(Contact STEMCO)		LP

[†]All lateral panels ordered will come pre-assembled with appropriate brackets, stiffeners, mechanical latches and cable components. Mounting hinges and AutoDeploy electronic latches are **not** included. Default color for lateral panels is white and will come with standard TrailerTail® decals (see page 05). If your panels are a different color or you have a different decal layout or custom decals, notify Customer Support when ordering.

Top Panel

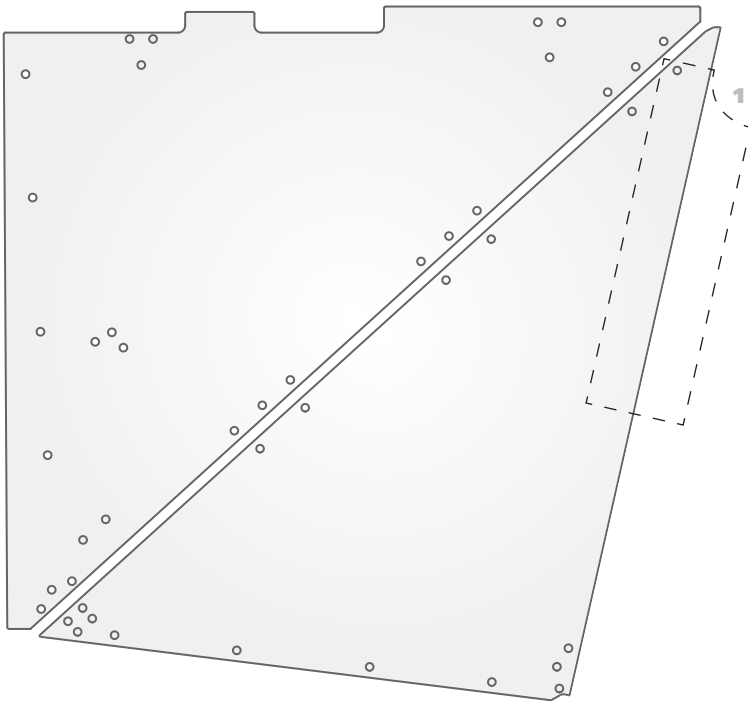

Instructions:

1. Locate the variations of each dotted lined box using the number(s) in the top right corner.
2. Determine the variation you have for each number based on the hole pattern highlighted in red. Note the name of your variation.
3. Identify your trailer type.
4. Determine the family number of your panel from the table below. Flip to the page of that family.

Hinge Type

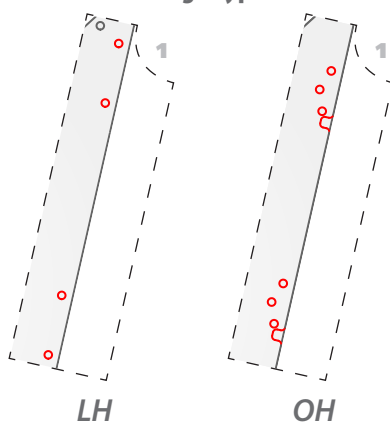

Family	1	
	Hinge Type	Trailer Type
	OH or LH	Dry or Refrigerated
4x4 #1T*	OH	Dry
4x4 #2T	LH	Dry
4x4 #3T*	OH	Refrigerated
4x4 #4T	LH	Refrigerated

**Indicates most common configuration families.*

4x4 Family #1T

(Most common family configuration)

Instructions:

1. Choose the respective roadside (RDS) or curbside (CBS) part number for your panel.

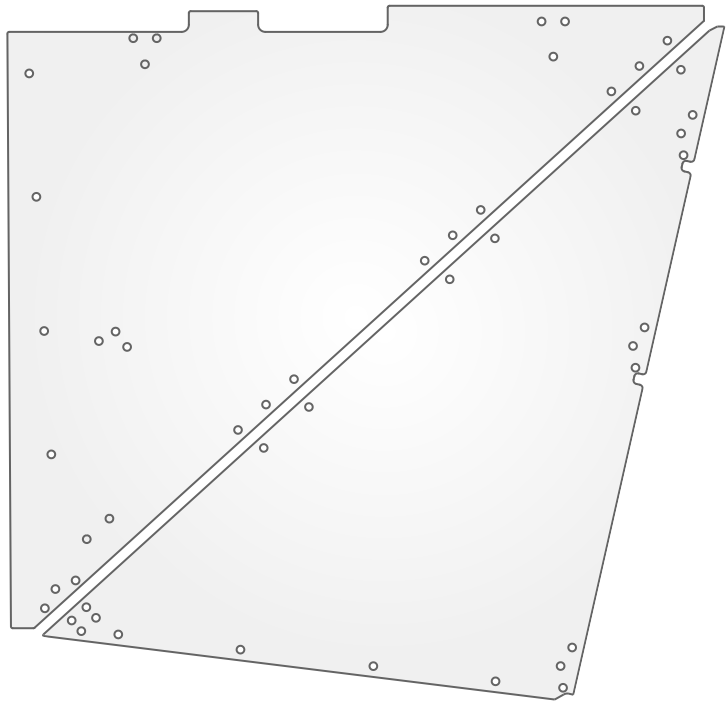

Trailer Type: Dry Van

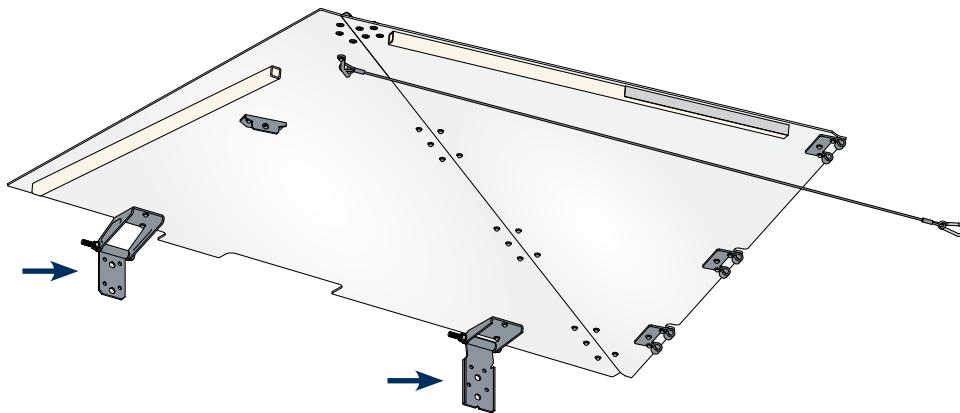

All top panels ordered in this family will come with two triangular shaped panels pre-assembled together with appropriate brackets, stiffeners, and cable components. Mounting hinges are included.

Top Panel Part Numbers[†]

RDS P/N	CBS P/N
ATD000164	ATD000165

[†]All top panels ordered in this family will come pre-assembled as shown above. Mounting hinges are included.

Default color for panels is white. If your panel is a different color, please indicate when ordering.

4x4 Family #2T

Instructions:

1. Choose the respective roadside (RDS) or curbside (CBS) part number for your panel.

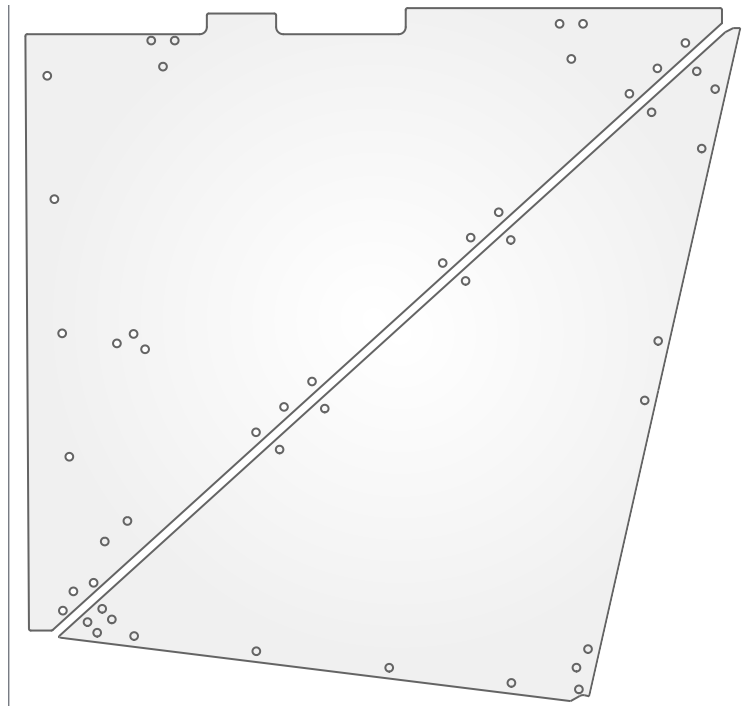

Trailer Type: Dry Van

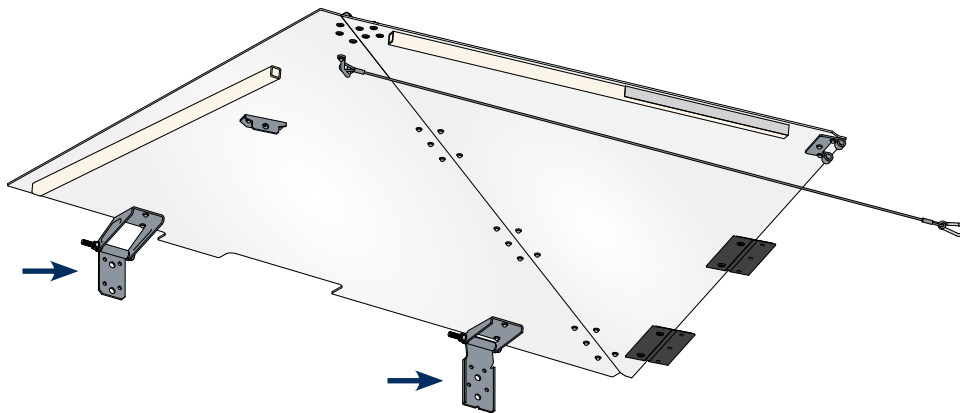

All top panels ordered in this family will come with two triangular shaped panels pre-assembled together with appropriate brackets, stiffeners, and cable components. Mounting hinges are included.

Top Panel Part Numbers†

RDS P/N	CBS P/N
ATD000164C	ATD000165C

†All top panels ordered in this family will come pre-assembled as shown above. Mounting hinges are included.

Default color for panels is white. If your panel is a different color, please indicate when ordering.

4x4 Family #3T

(Most common family configuration)

Instructions:

1. Measure the distances between the holes highlighted in blue (Distance A & C).
2. Measure the maximum horizontal width of the panel (Distance B).
3. Choose the respective roadside (RDS) or curbside (CBS) part number for your panel using the information above.

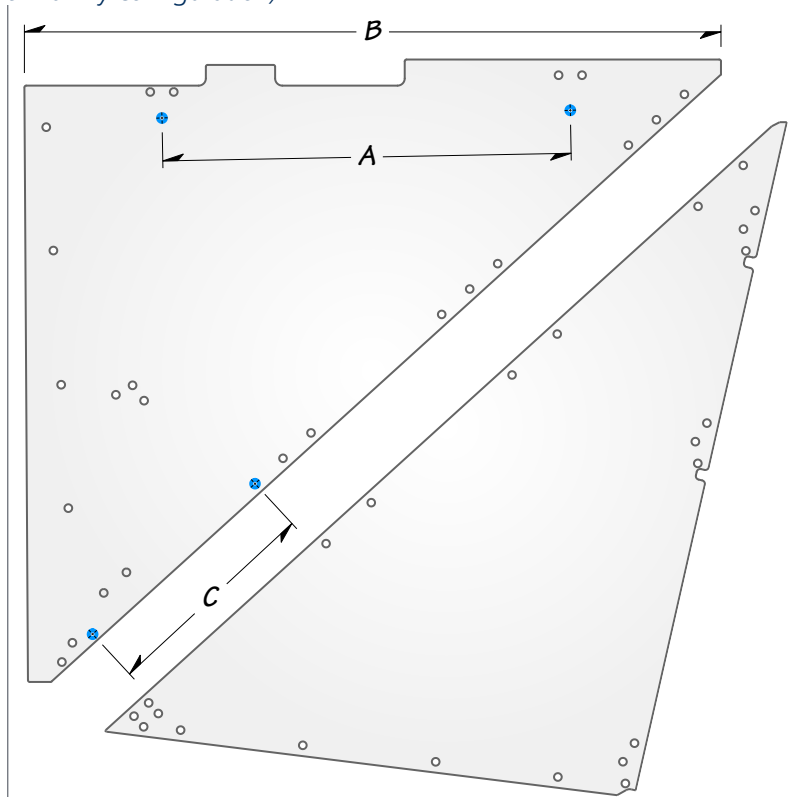

Trailer Type: Refrigerated

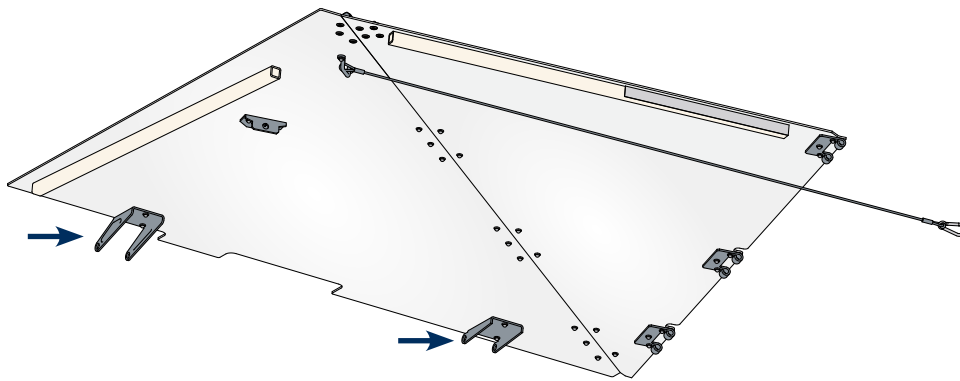

All top panels ordered in this family will come with two triangular shaped panels pre-assembled together with appropriate brackets, stiffeners, and cable components. Mounting hinges are **not** included.

Top Panel Part Numbers†		A	B	C
RDS P/N	CBS P/N			
ATD000685	ATD000049	28 3/8"	48 1/2"	15 3/8"
(Contact STEMCO)		28 3/8"	47 1/2"	15 3/8"
ATD000658	ATD000659	28 3/8"	48 1/8"	13 1/8"
ATD000046	N/A	30 3/8"	48 1/2"	15 3/8"

†All top panels ordered in this family will come pre-assembled as shown above. Mounting hinges are **not** included. Panels may not be symmetric between roadside and curbside. Please measure the exact panel you are replacing. Default color for panels is white. If your panel is a different color, please indicate when ordering.

4x4 Family #4T

Instructions:

1. Measure the distance between the holes highlighted in blue (Distance A).
2. Choose the respective roadside (RDS) or curbside (CBS) part number for your panel using the information above.

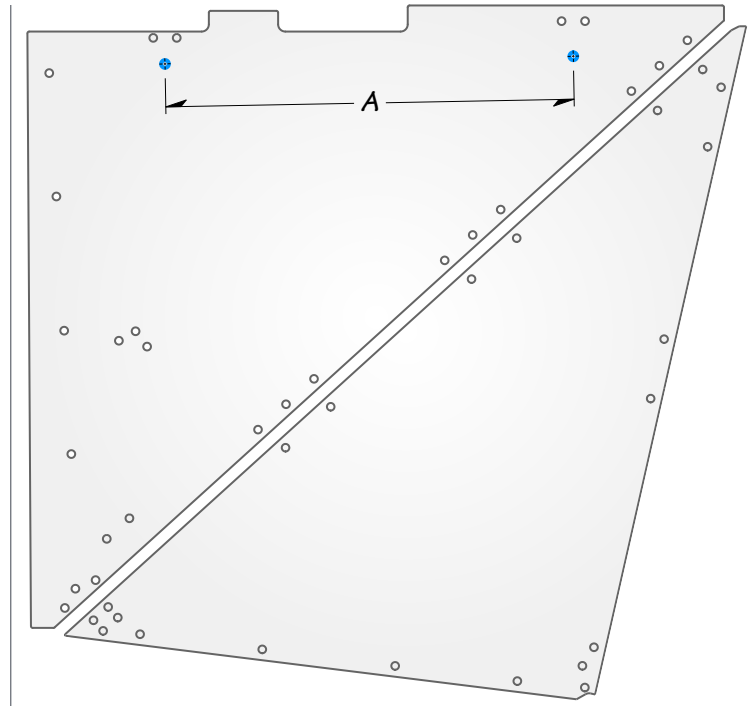

Trailer Type: Refrigerated

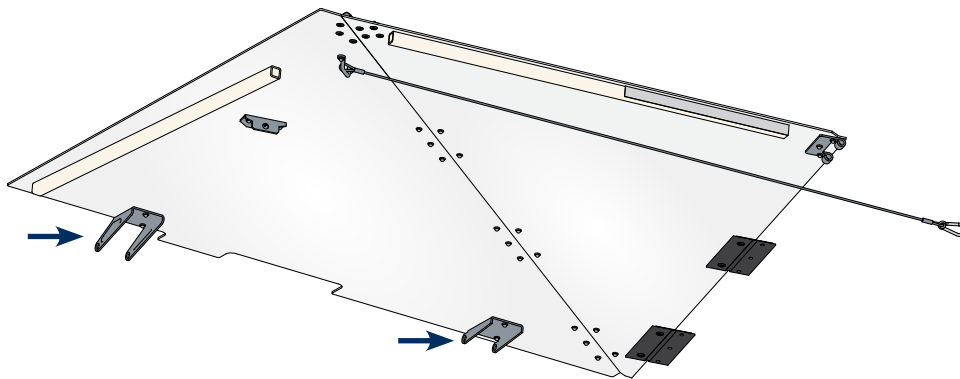

All top panels ordered in this family will come with two triangular shaped panels pre-assembled together with appropriate brackets, stiffeners, and cable components. Mounting hinges are **not** included.

Top Panel Part Numbers†		A
RDS P/N	CBS P/N	
ATD000685A	ATD000049A	28 3/8"
ATD000046A	N/A	30 3/8"

†All top panels ordered in this family will come pre-assembled as shown above. Mounting hinges are **not** included.
Panels may not be symmetric between roadside and curbside. Please measure the exact panel you are replacing.
Default color for panels is white. If your panel is a different color, please indicate when ordering.

Bottom Panel

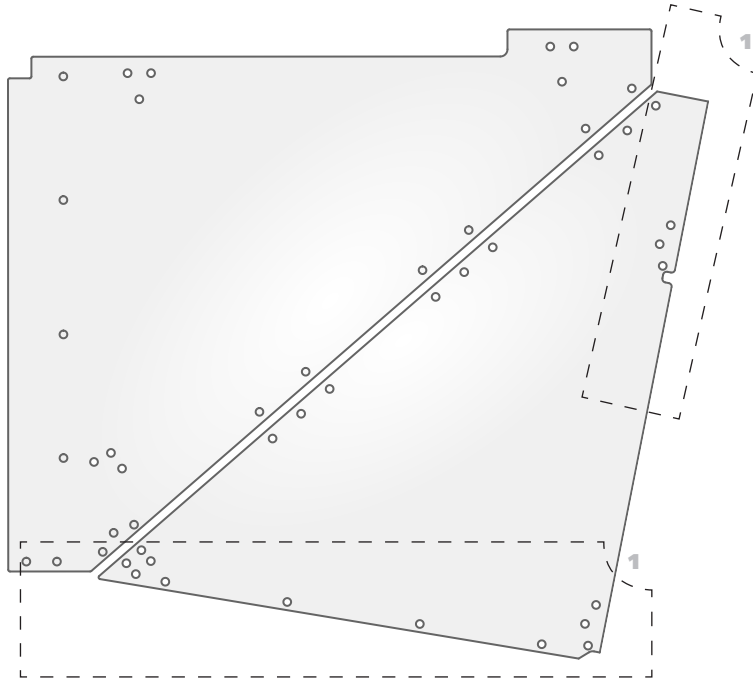

Instructions:

1. Locate the variations of each dotted lined box using the number(s) in the top right corner.
2. Determine the variation you have for each number based on the hole pattern highlighted in red. Note the name of your variation.
3. Determine your latch type by choosing the design that best matches your existing latch.
4. Identify your trailer type.
5. Determine the family number of your panel from the table below. Flip to the page of that family.

Hinge Type

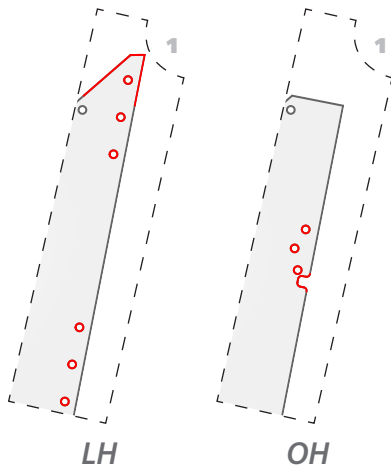

Latch Type

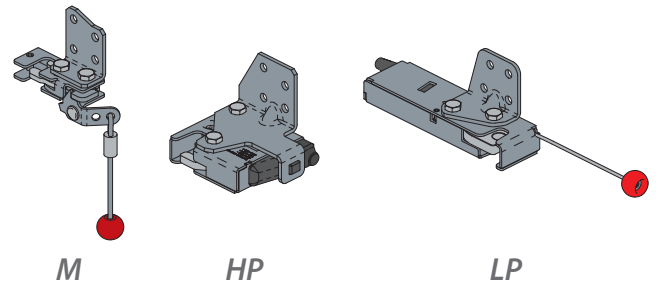

If you have latch type "HP" and it is **not reusable** or is damaged, choose from the part numbers with the "LP" latch type. Additionally, you will need latches from the list of **low-profile latch replacement kits** on page 55.

Family	1		
	Hinge Type	Latch Type	Trailer Type
	OH or LH	M, HP or LP	Dry or Refrigerated
4x4 #1B*	OH	M	Dry
4x4 #2B	LH	M	Dry
4x4 #3B	OH	HP	Dry
4x4 #4B	OH	LP	Dry
4x4 #5B*	OH	M	Refrigerated
4x4 #6B	LH	M	Refrigerated
4x4 #7B	OH	HP	Refrigerated
4x4 #8B	OH	LP	Refrigerated

*Indicates most common configuration families.

4x4 Family #1B

(Most common family configuration)

Instructions:

1. Measure the distance between the holes highlighted in blue (Distance A).
2. Measure the distance from the edge of the panel to the hole highlighted in blue (Distance B).
3. Choose the respective roadside (RDS) or curbside (CBS) part number for your panel using the information above.

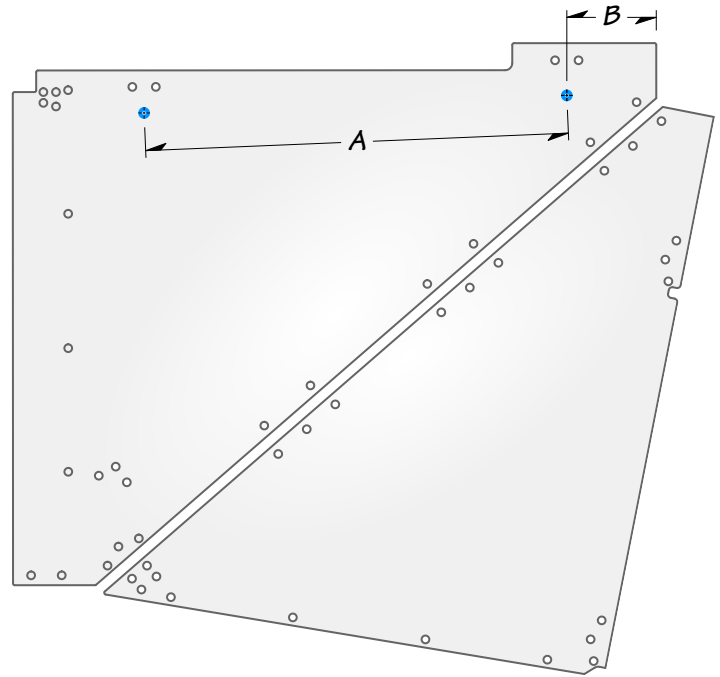

Trailer Type: Dry Van

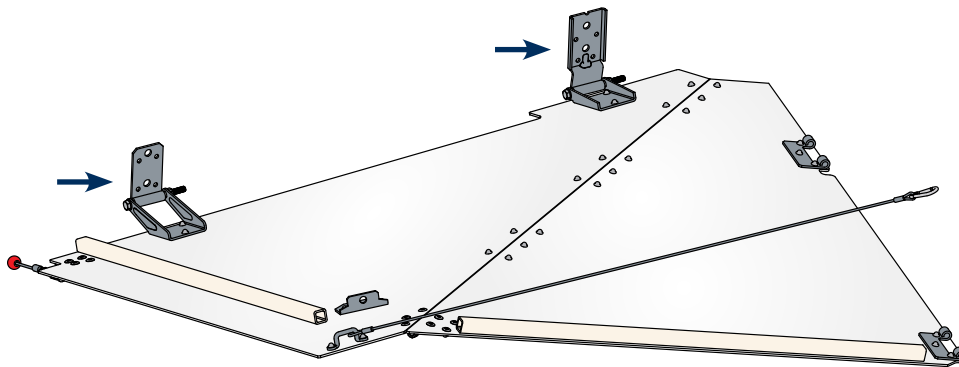

All bottom panels ordered in this family will come with two triangular shaped panels pre-assembled together with appropriate brackets, stiffeners, mechanical latches and cable components. Mounting hinges are included.

Bottom Panel Part Numbers [†]		A	B
RDS P/N	CBS P/N		
ATD001959	ATD001960	27 3/8"	6 1/4"
ATD000137	ATD000138	29 3/8"	6 1/4"
ATD002255	ATD002256	30 3/8"	5 1/4"
(Contact STEMCO)		31 3/8"	4 1/4"
ATD001414	ATD001415	32 3/8"	3 1/4"
N/A	ATD002366	34 1/4"	1 3/8"

[†]All bottom panels ordered in this family will come pre-assembled as shown above.

Mounting hinges are included.

Panels may not be symmetric between roadside and curbside. Please measure the exact panel you are replacing.

Default color for panels is white. If your panel is a different color, please indicate when ordering.

4x4 Family #2B

Instructions:

1. Measure the distance between the holes highlighted in blue (Distance A).
2. Measure the distance from the edge of the panel to the hole highlighted in blue (Distance B).
3. Choose the respective roadside (RDS) or curbside (CBS) part number for your panel using the information above.

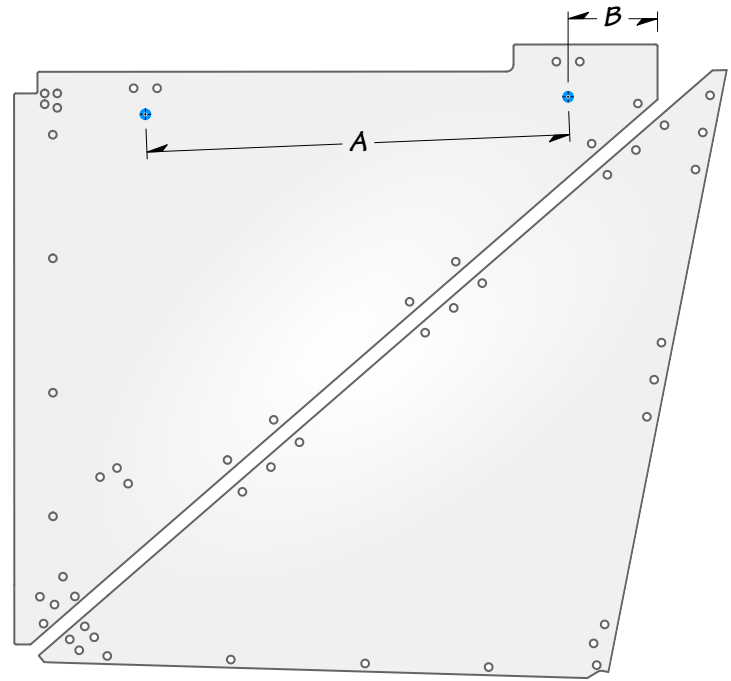

Trailer Type: Dry Van

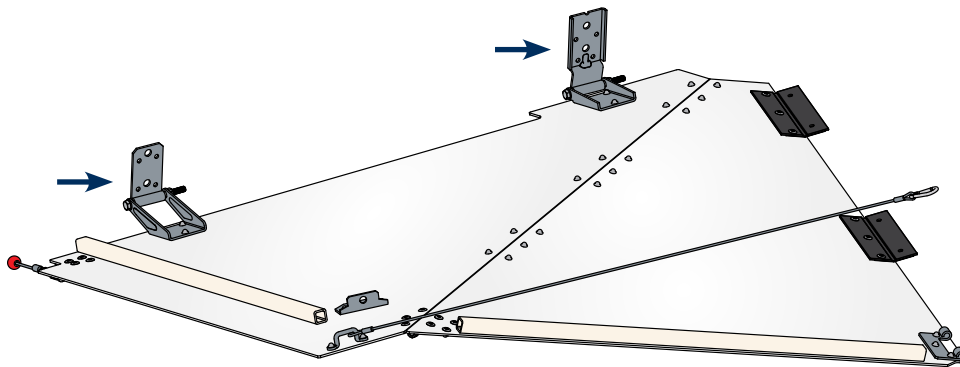

All bottom panels ordered in this family will come with two triangular shaped panels pre-assembled together with appropriate brackets, stiffeners, mechanical latches and cable components. Mounting hinges are included.

Bottom Panel Part Numbers [†]		A	B
RDS P/N	CBS P/N		
ATD001959B	ATD001960B	27 3/8"	6 1/4"
ATD000137D2	ATD000138D2	29 3/8"	6 1/4"
ATD002255B	ATD002256B	30 3/8"	5 1/4"
ATD001414A	ATD001415A	32 3/8"	3 1/4"

[†]All bottom panels ordered in this family will come pre-assembled as shown above.

Mounting hinges are included.

Panels may not be symmetric between roadside and curbside. Please measure the exact panel you are replacing.

Default color for panels is white. If your panel is a different color, please indicate when ordering.

4x4 Family #3B

Instructions:

1. Measure the distance between the holes highlighted in blue (Distance A).
2. Measure the distance from the edge of the panel to the hole highlighted in blue (Distance B).
3. Choose the respective roadside (RDS) or curbside (CBS) part number for your panel using the information above.

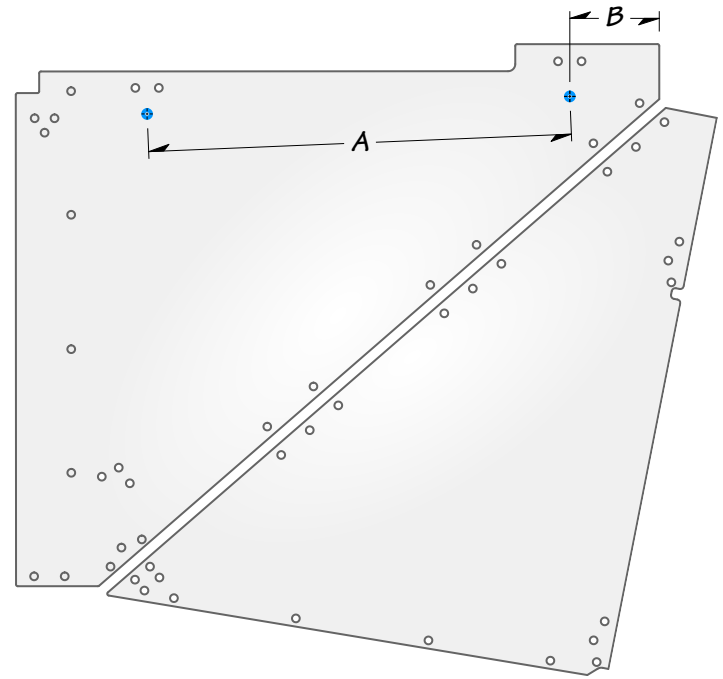

Trailer Type: Dry Van

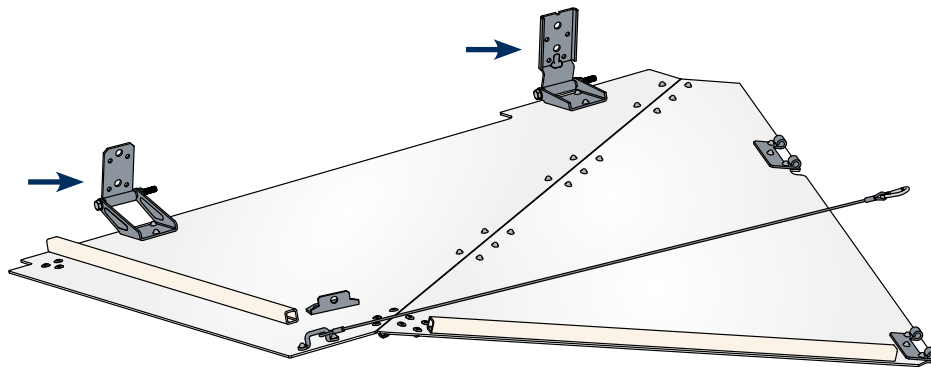

All bottom panels ordered in this family will come with two triangular shaped panels pre-assembled together with appropriate brackets, stiffeners, and cable components. Mounting hinges are included. AutoDeploy electronic latches are **not** included.

Bottom Panel Part Numbers [†]		A	B
RDS P/N	CBS P/N		
ATD000830	ATD000831	29 3/8"	6 1/4"
ATD001468	ATD001469	30 3/8"	5 1/4"
<i>(Contact STEMCO)</i>		31 3/8"	4 1/4"
ATD002911	ATD002912	32 3/8"	3 1/4"
N/A	ATD002920	34 1/4"	1 3/8"

[†]All bottom panels ordered in this family will come pre-assembled as shown above. Mounting hinges are included. AutoDeploy electronic latches are **not** included. Panels may not be symmetric between roadside and curbside. Please measure the exact panel you are replacing. Default color for panels is white. If your panel is a different color, please indicate when ordering.

4x4 Family #4B

Instructions:

1. Measure the distance between the holes highlighted in blue (Distance A).
2. Measure the distance from the edge of the panel to the hole highlighted in blue (Distance B).
3. Choose the respective roadside (RDS) or curbside (CBS) part number for your panel using the information above.

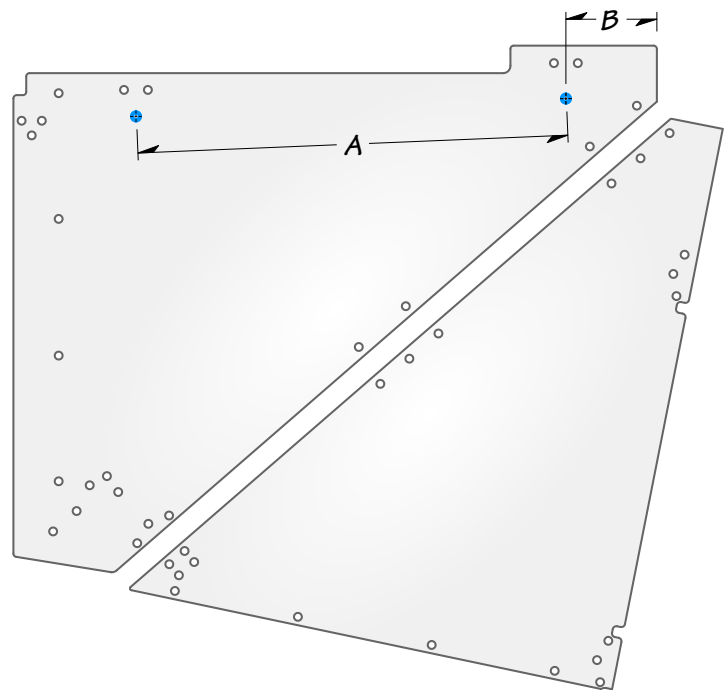

Trailer Type: Dry Van

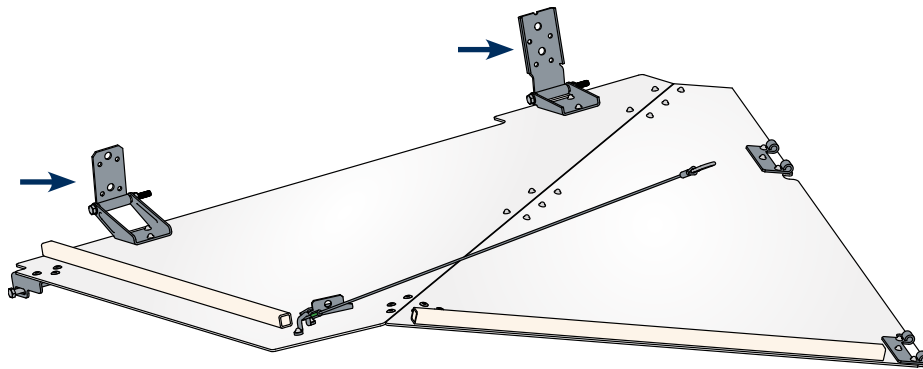

All bottom panels ordered in this family will come with two triangular shaped panels pre-assembled together with appropriate brackets, stiffeners, and cable components. Mounting hinges are included. AutoDeploy electronic latches are **not** included.

Bottom Panel Part Numbers [†]		A	B
RDS P/N	CBS P/N		
(Contact STEMCO)	(Contact STEMCO)	29 3/8"	6 1/4"
(Contact STEMCO)	(Contact STEMCO)	30 3/8"	5 1/4"
(Contact STEMCO)	(Contact STEMCO)	31 3/8"	4 1/4"
(Contact STEMCO)	(Contact STEMCO)	32 3/8"	3 1/4"
(Contact STEMCO)	(Contact STEMCO)	34 1/4"	1 3/8"

[†]All bottom panels ordered in this family will come pre-assembled as shown above. Mounting hinges are included. AutoDeploy electronic latches are **not** included. Panels may not be symmetric between roadside and curbside. Please measure the exact panel you are replacing. Default color for panels is white. If your panel is a different color, please indicate when ordering.

4x4 Family #5B

(Most common family configuration)

Instructions:

1. Measure the distances between the holes highlighted in blue (Distance A & D).
2. Measure the distances from the edge of the panel to the holes highlighted in blue (Distance B & C).
3. Choose the respective roadside (RDS) or curbside (CBS) part number for your panel using the information above.

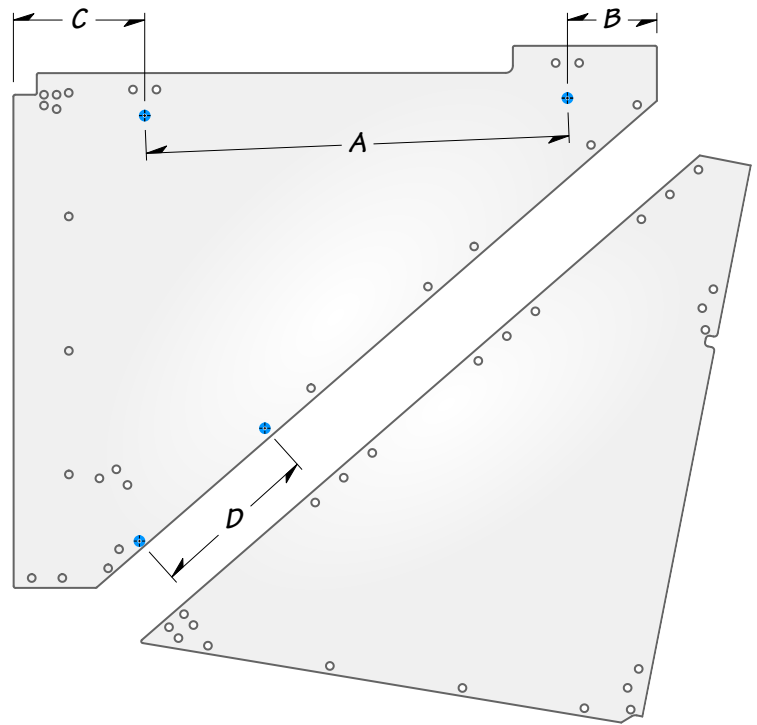

Trailer Type: Refrigerated

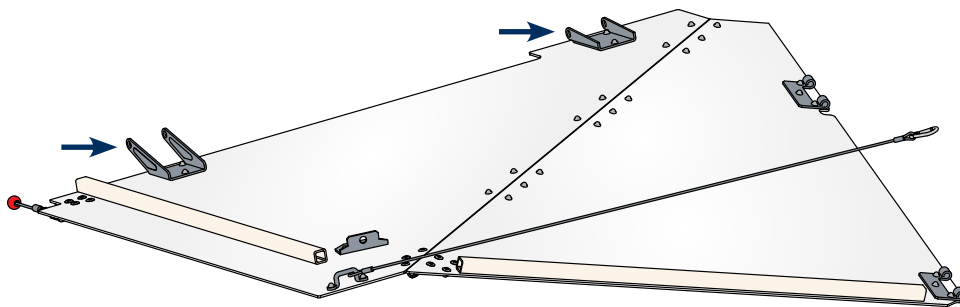

All bottom panels ordered in this family will come with two triangular shaped panels pre-assembled together with appropriate brackets, stiffeners, mechanical latches and cable components. Mounting hinges are **not** included.

Bottom Panel Part Numbers [†]		A	B	C	D
RDS P/N	CBS P/N				
ATD002921	ATD002922	27 3/8"	6 1/4"	11 1/8"	11 3/4"
ATD000686	ATD000045	29 3/8"	6 1/4"	9 1/8"	11 3/4"
(Contact STEMCO)		29 3/8"	6 1/4"	8 1/8"	11 3/4"
ATD000050	ATD001109	32 3/8"	5 1/4"	7 1/8"	11 3/4"
ATD000663	ATD000664	32 5/8"	6 1/4"	5 7/8"	9 3/4"
(Contact STEMCO)		32 7/8"	6 1/4"	5 5/8"	11 3/4"

[†]All bottom panels ordered in this family will come pre-assembled as shown above. Mounting hinges are **not** included.

Panels may not be symmetric between roadside and curbside. Please measure the exact panel you are replacing.

Default color for panels is white. If your panel is a different color, please indicate when ordering.

4x4 Family #6B

Instructions:

1. Measure the distance between the holes highlighted in blue (Distance A).
2. Measure the distance from the edge of the panel to the hole highlighted in blue (Distance C).
3. Choose the respective roadside (RDS) or curbside (CBS) part number for your panel using the information above.

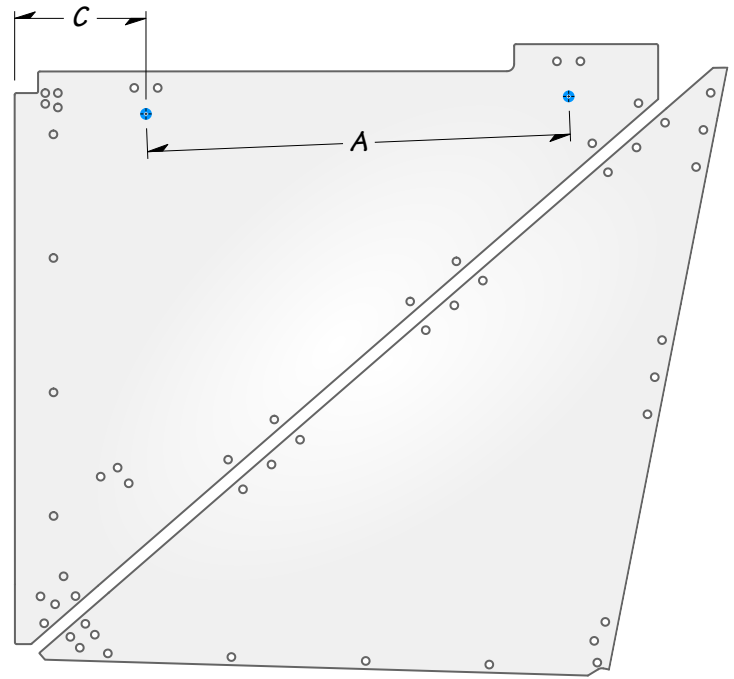

Trailer Type: Refrigerated

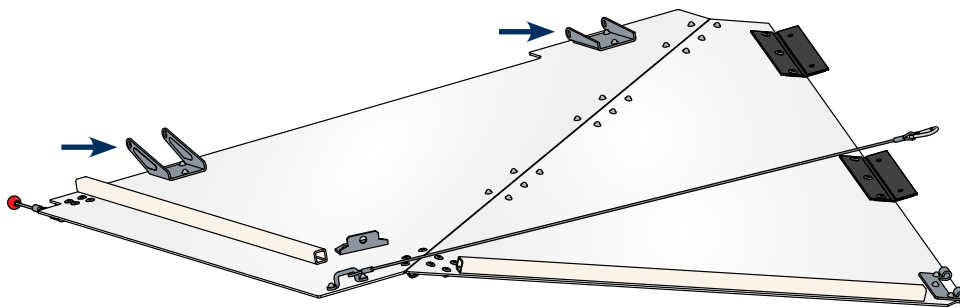

All bottom panels ordered in this family will come with two triangular shaped panels pre-assembled together with appropriate brackets, stiffeners, mechanical latches and cable components. Mounting hinges are **not** included.

Bottom Panel Part Numbers [†]		A	C
RDS P/N	CBS P/N		
ATD002921B	ATD002922B	27 3/8"	11 1/8"
ATD000686D2	ATD000045D2	29 3/8"	9 1/8"
ATD000050D2	ATD001109D2	32 3/8"	7 1/8"
ATD001260D2	ATD001261D2	32 7/8"	5 5/8"

[†]All bottom panels ordered in this family will come pre-assembled as shown above.

Mounting hinges are **not** included.

Panels may not be symmetric between roadside and curbside. Please measure the exact panel you are replacing.

Default color for panels is white. If your panel is a different color, please indicate when ordering.

4x4 Family #7B

Instructions:

1. Measure the distance between the holes highlighted in blue (Distance A).
2. Measure the distance from the edge of the panel to the hole highlighted in blue (Distance C).
3. Choose the respective roadside (RDS) or curbside (CBS) part number for your panel using the information above.

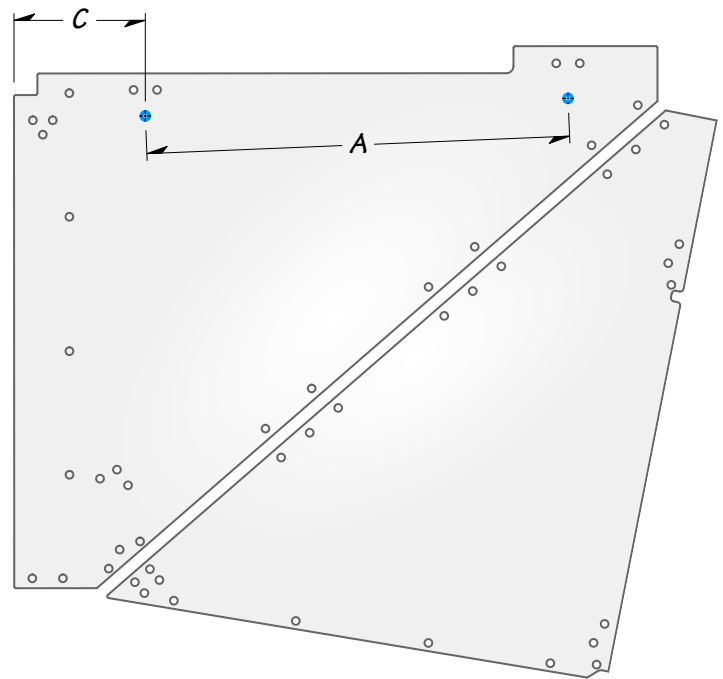

Trailer Type: Refrigerated

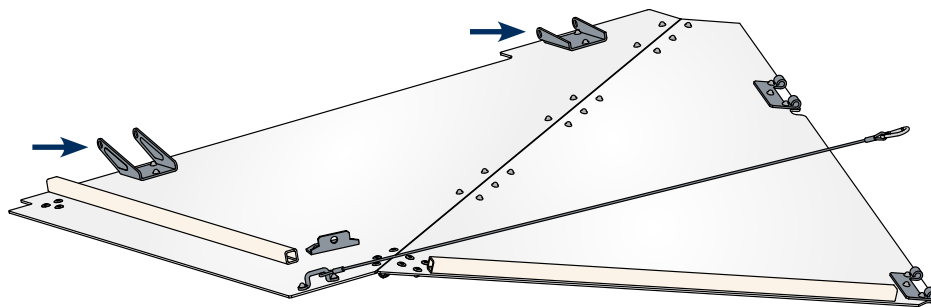

All bottom panels ordered in this family will come with two triangular shaped panels pre-assembled together with appropriate brackets, stiffeners, and cable components. Mounting hinges and AutoDeploy electronic latches are **not** included.

Bottom Panel Part Numbers [†]		A	C
RDS P/N	CBS P/N		
ATD002926	ATD002927	29 3/8"	8 1/8"
ATD000832	ATD000833	29 3/8"	9 1/8"
(Contact STEMCO)		32 3/8"	7 1/8"
ATD002015	ATD002914	32 7/8"	5 5/8"

[†]All bottom panels ordered in this family will come pre-assembled as shown above.

Mounting hinges and AutoDeploy electronic latches are **not** included.

Panels may not be symmetric between roadside and curbside. Please measure the exact panel you are replacing.

Default color for panels is white. If your panel is a different color, please indicate when ordering.

4x4 Family #8B

Instructions:

1. Measure the distance between the holes highlighted in blue (Distance A).
2. Measure the distance from the edge of the panel to the hole highlighted in blue (Distance C).
3. Choose the respective roadside (RDS) or curbside (CBS) part number for your panel using the information above.

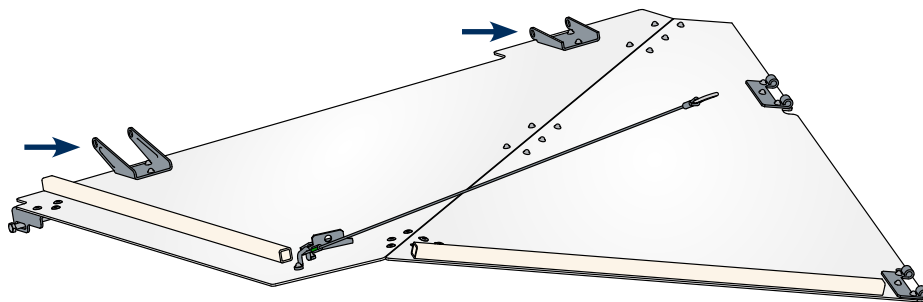
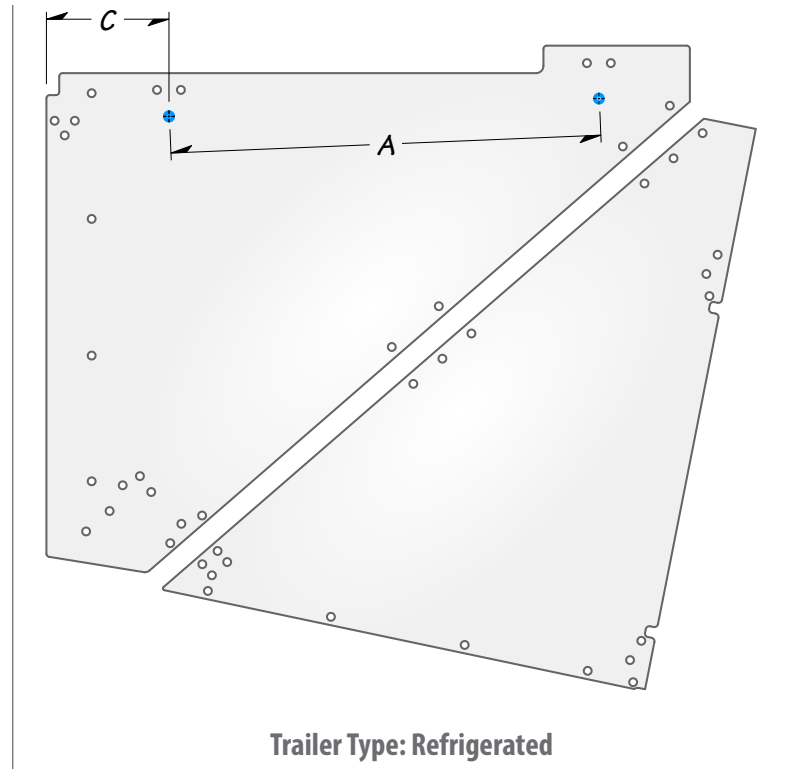

All bottom panels ordered in this family will come with two triangular shaped panels pre-assembled together with appropriate brackets, stiffeners, and cable components. Mounting hinges are included. AutoDeploy electronic latches are **not** included.

Bottom Panel Part Numbers [†]		A	C
RDS P/N	CBS P/N		
(Contact STEMCO)		29 3/8"	8 1/8"
	(Contact STEMCO)	29 3/8"	9 1/8"
(Contact STEMCO)		32 3/8"	7 1/8"
	(Contact STEMCO)	32 7/8"	5 5/8"

[†]All bottom panels ordered in this family will come pre-assembled as shown above. Mounting hinges and AutoDeploy electronic latches are **not** included. Panels may not be symmetric between roadside and curbside. Please measure the exact panel you are replacing. Default color for panels is white. If your panel is a different color, please indicate when ordering.

Lateral Panel

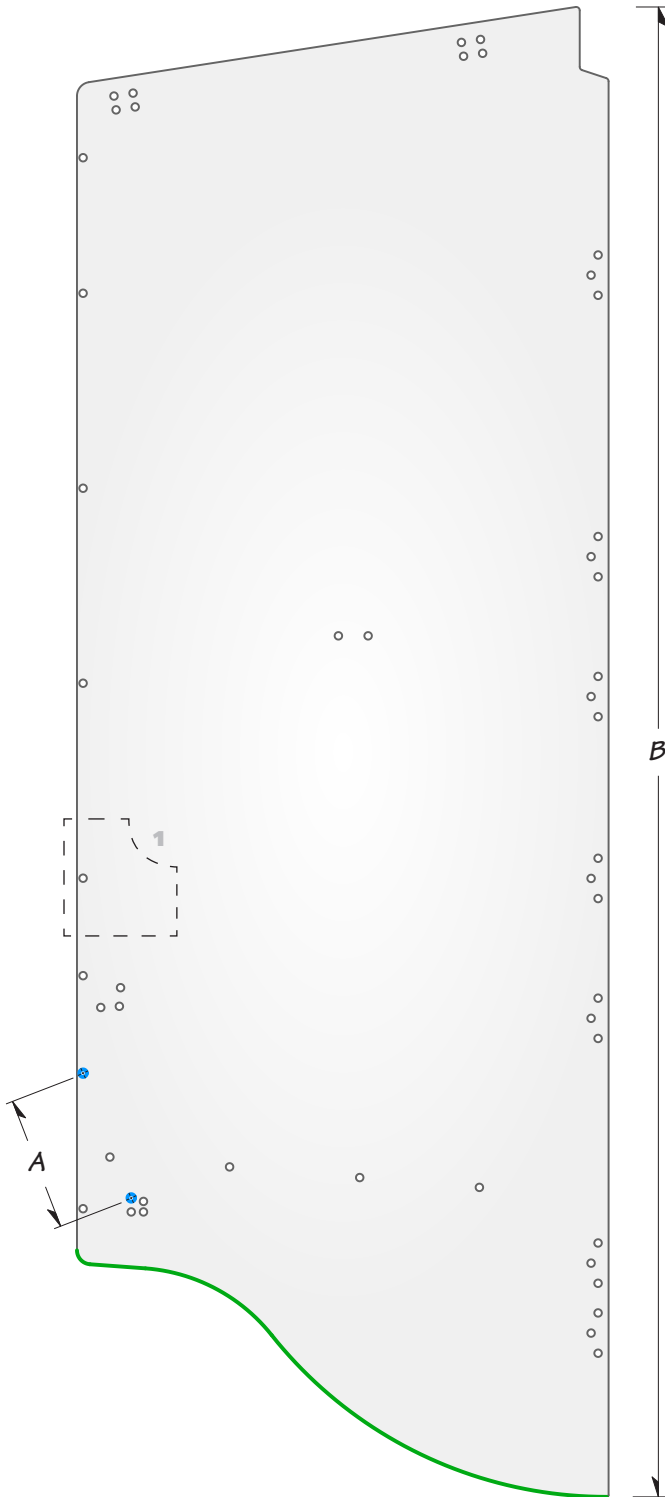

Instructions:

1. Locate the variation of the dotted lined box using the number in the top right corner.
2. Determine the variation you have based on the hole pattern highlighted in red. Note the name of your variation.
3. Determine your bracket type by choosing the design that best matches your door mounting brackets.
4. Measure the distance between the holes highlighted in blue (Distance A).
5. Measure the length of the panel along the longest edge (Distance B).
6. Determine the family number of your panel from the table below. Flip to the page of that family.

Swingarm Type

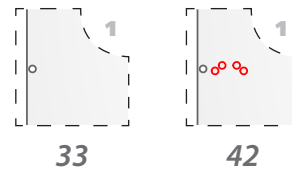

Bracket Type

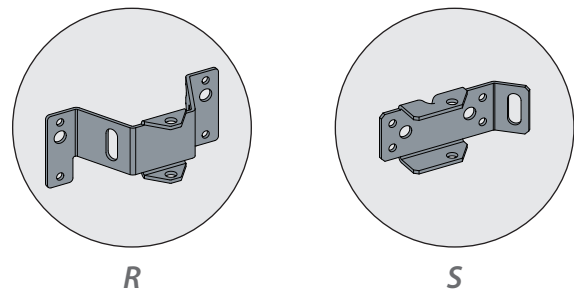

Family	¹ Swingarm Type	Bracket Type	A	B
TRI #1L*	33	R	9 ½" – 10"	<112"
TRI #2L	33	R	11 ⅜"	<112"
TRI #3L	42	R	—	107"
TRI #4L	33	S	9 ½"	<112"
TRI #5L	33	R	—	≥112"

*Indicates most common configuration family.

Note:

Your lateral panel bottom edge contour, highlighted in green, may vary. You may need to trim for lock rods, hazard placards, and other door accessories.

See Appendix B on page 67.

TRI Family #1L

(Most common family configuration)

Instructions:

1. Locate the variations of each dotted lined box using the number(s) in the top right corner.
2. Determine the variation you have for each number based on the hole pattern highlighted in red. Note the name of your variation.
3. Determine your latch type by choosing the design that best matches your existing latch.
4. Choose the respective roadside (RDS) or curbside (CBS) part number for your panel.

Secondary Latch

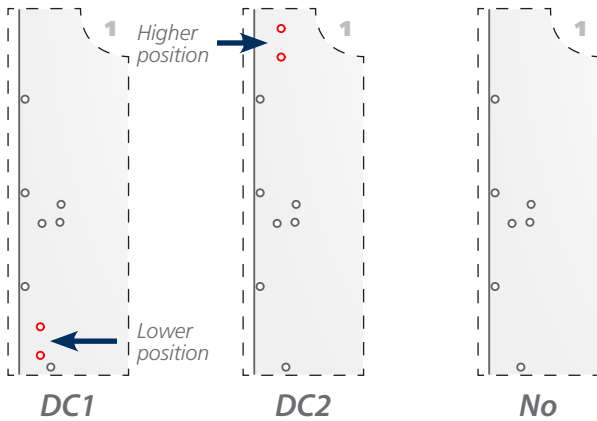

Latch Type

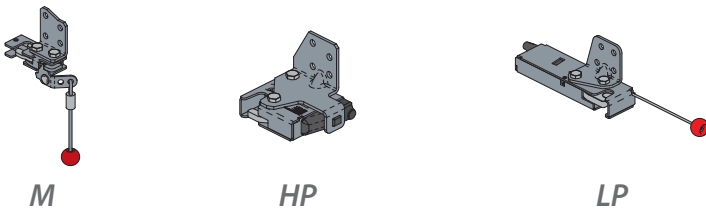

If you have latch type "HP" and it is **not reusable** or is damaged, choose from the part numbers with the "LP" latch type. Additionally, you will need latches from the list of **low-profile latch replacement kits** on page 55.

Lateral Panel Part Numbers [†]		1 Secondary Latch	Latch Type	2 Covered
RDS P/N	CBS P/N	DC	M, HP or LP	X
ATD000650	ATD000651	No	M	No
ATD001364	ATD001365	No	HP	No
ATD001372	ATD001373	DC1	HP	No
ATD002938	ATD002939	DC2	HP	No
ATD002089	ATD002090	No	M	Yes
(Contact STEMCO)		No	LP	No

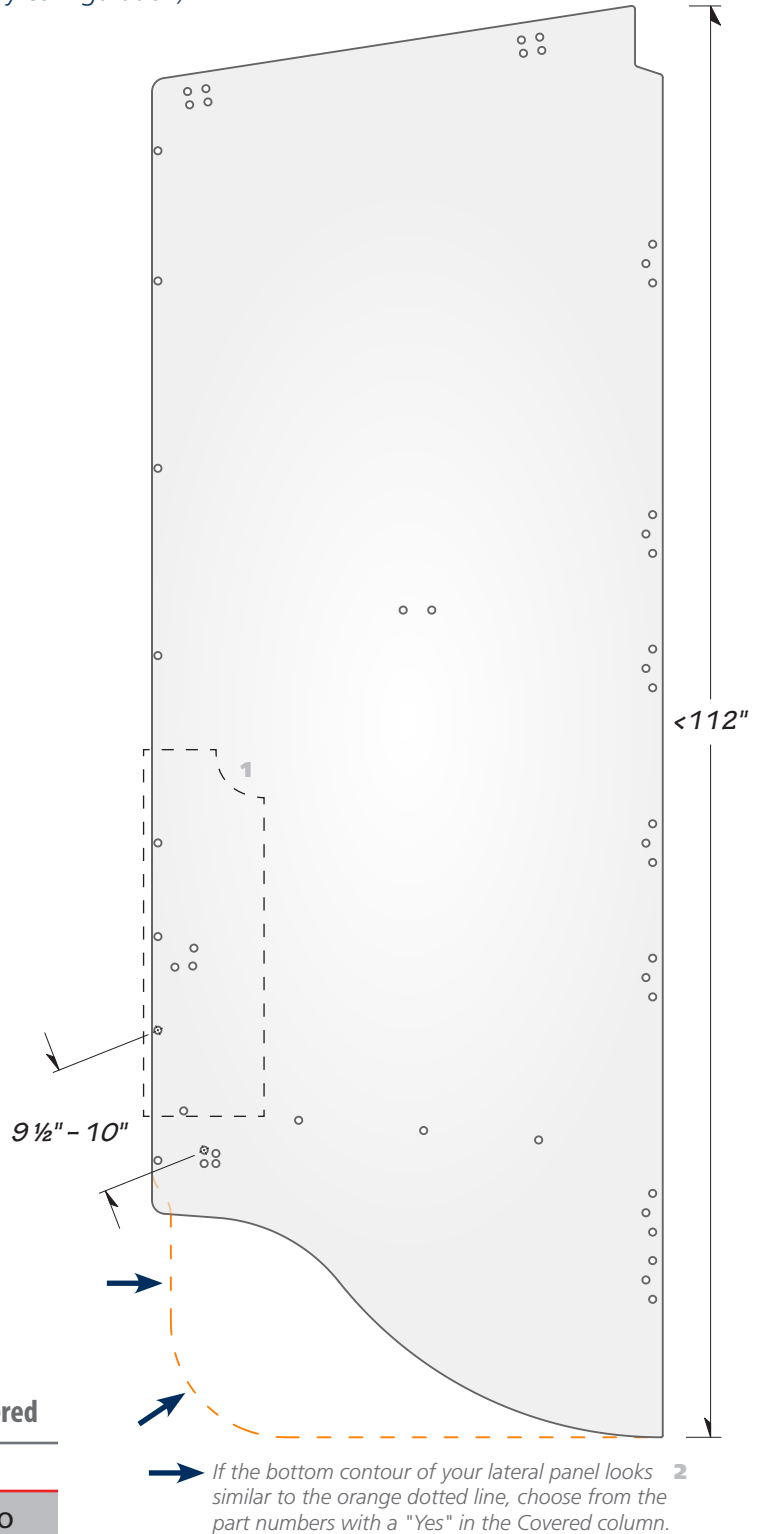

[†]All lateral panels ordered will come pre-assembled with appropriate brackets, stiffeners, mechanical latches and cable components. Mounting hinges and AutoDeploy electronic latches are **not** included.

Default color for lateral panels is white and will come with standard TrailerTail® decals (see page 05). If your panels are a different color or you have a different decal layout or custom decals, notify Customer Support when ordering.

TRI Family #2L

Instructions:

1. Locate the variations of each dotted lined box using the number(s) in the top right corner.
2. Determine the variation you have for each number based on the hole pattern highlighted in red. Note the name of your variation.
3. Determine your latch type by choosing the design that best matches your existing latch.
4. Choose the respective roadside (RDS) or curbside (CBS) part number for your panel.

Secondary Latch

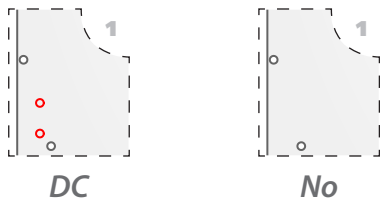

Latch Type

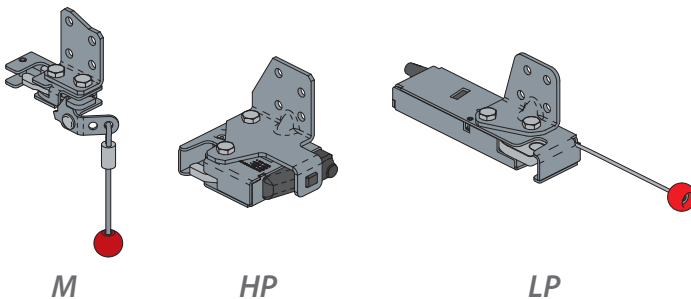

If you have latch type "HP" and it is **not reusable** or is damaged, choose from the part numbers with the "LP" latch type. Additionally, you will need latches from the list of **low-profile latch replacement kits** on page 55.

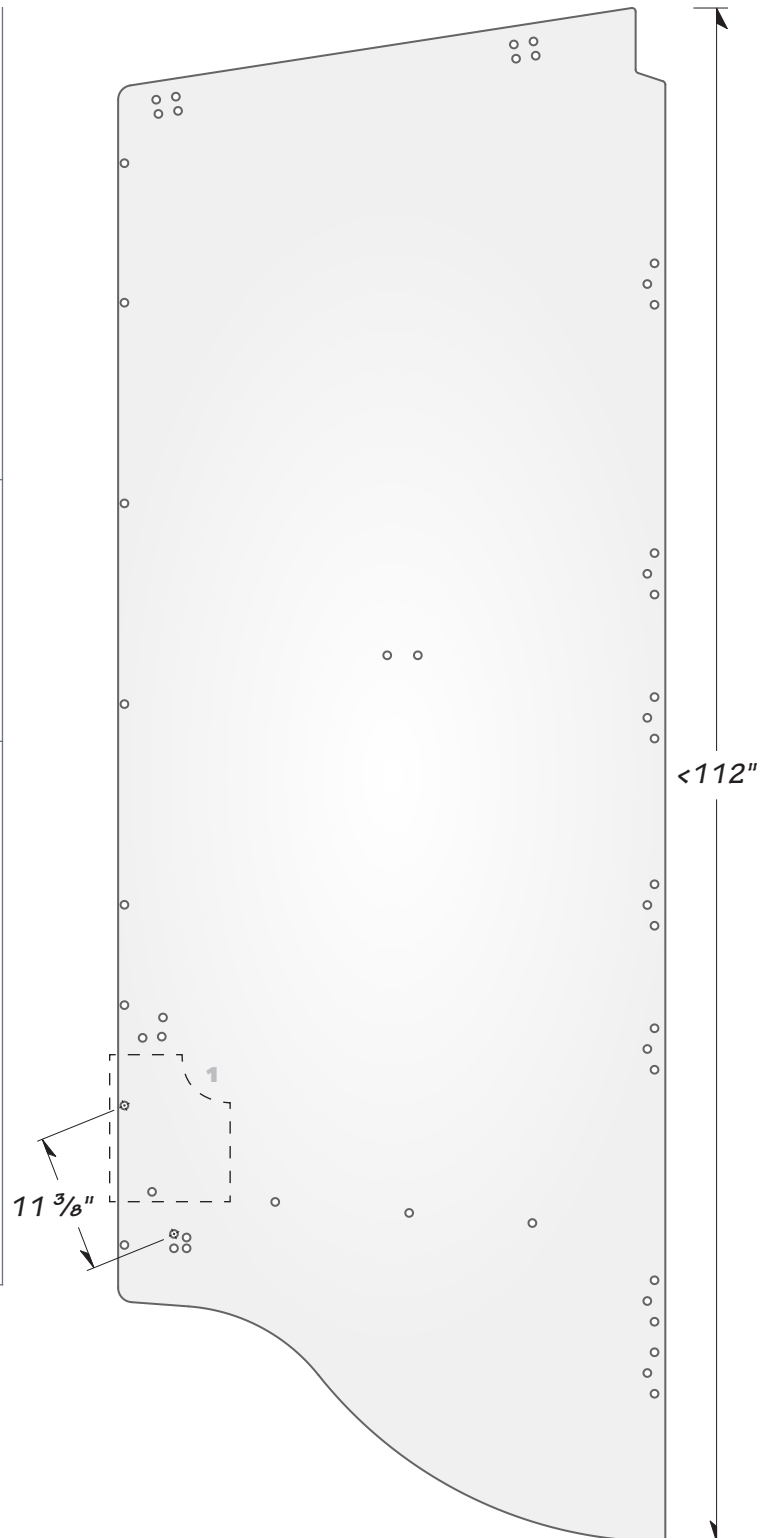

Lateral Panel Part Numbers [†]		1 Secondary Latch	Latch Type
RDS P/N	CBS P/N	DC	M, HP or LP
ATD000650D	ATD000651D	No	M
ATD001364D	ATD001365D	No	HP
ATD001372D	ATD001373D	DC	HP
(Contact STEMCO)		No	LP

[†]All lateral panels ordered will come pre-assembled with appropriate brackets, stiffeners, mechanical latches and cable components. Mounting hinges and AutoDeploy electronic latches are **not** included. Default color for lateral panels is white and will come with standard TrailerTail® decals (see page 05). If your panels are a different color or you have a different decal layout or custom decals, notify Customer Support when ordering.

TRI Family #3L

Instructions:

1. Choose the respective roadside (RDS) or curbside (CBS) part number for your panel.
2. If your panel height is greater than 112", please contact Customer Support for your panel part numbers.

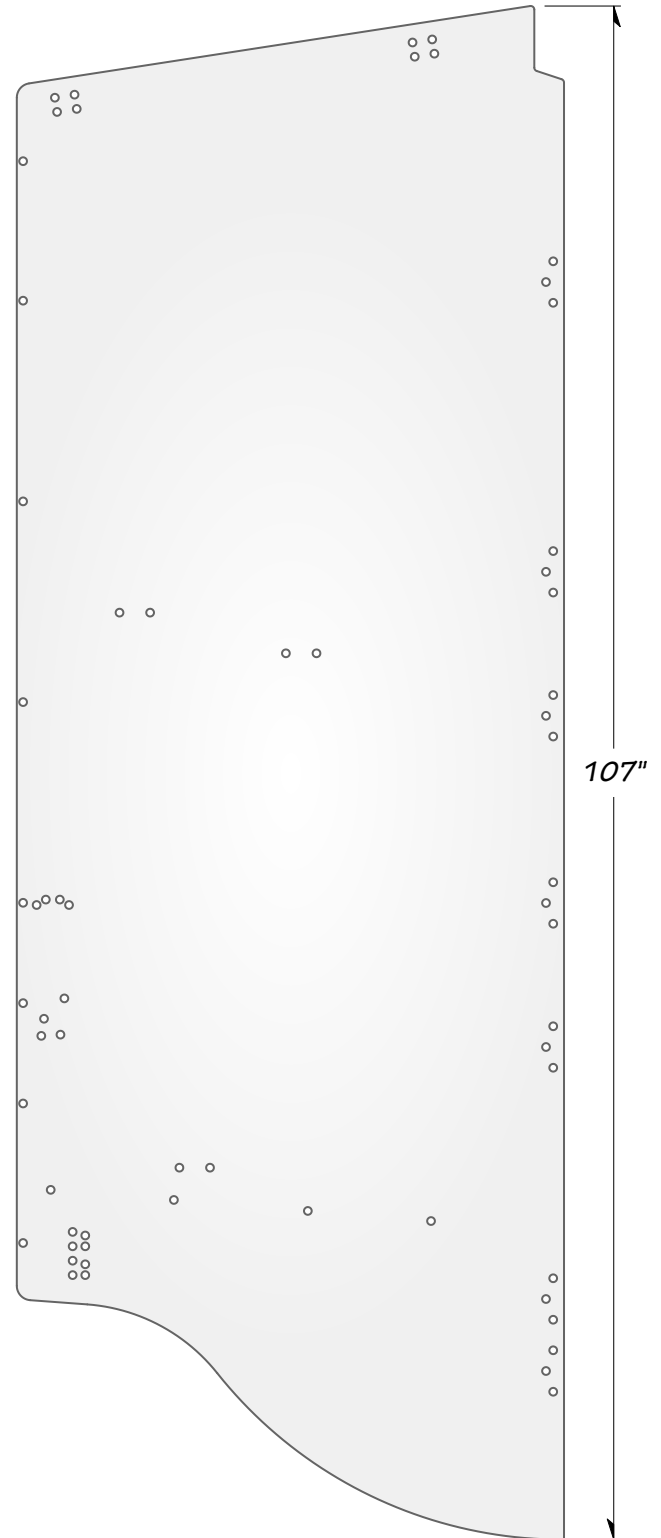

*†All lateral panels ordered will come pre-assembled with appropriate brackets, stiffeners, and cable components. Several components including mounting hinges are **not** included. Please refer to [ATD002331] **Install Manual - Universal Panels** for details on installing components correctly. Default color for lateral panels is white and will come with standard TrailerTail[®] decals (see page 05). If your panels are a different color or you have a different decal layout or custom decals, notify Customer Support when ordering.*

Lateral Panel Part Numbers[†]

RDS P/N	CBS P/N
ATD002143	ATD002144

TRI Family #4L

Instructions:

1. Verify your door mounting brackets look like the design below.
2. Determine your latch type by choosing the design that best matches your existing latch.
3. Choose the respective roadside (RDS) or curbside (CBS) part number for your panel.

Bracket Type

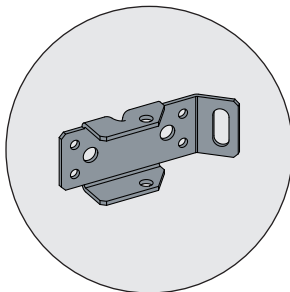

Latch Type

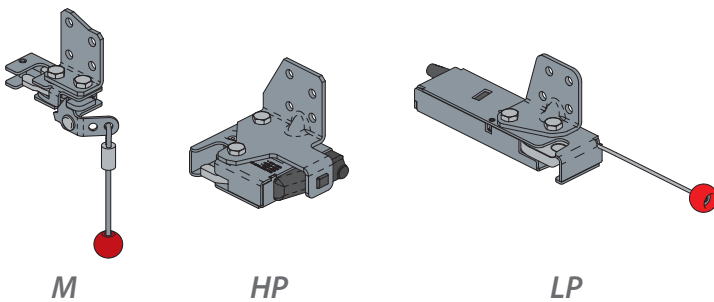

If you have latch type "HP" and it is **not reusable** or is damaged, choose from the part numbers with the "LP" latch type. Additionally, you will need latches from the list of **low-profile latch replacement kits** on page 55.

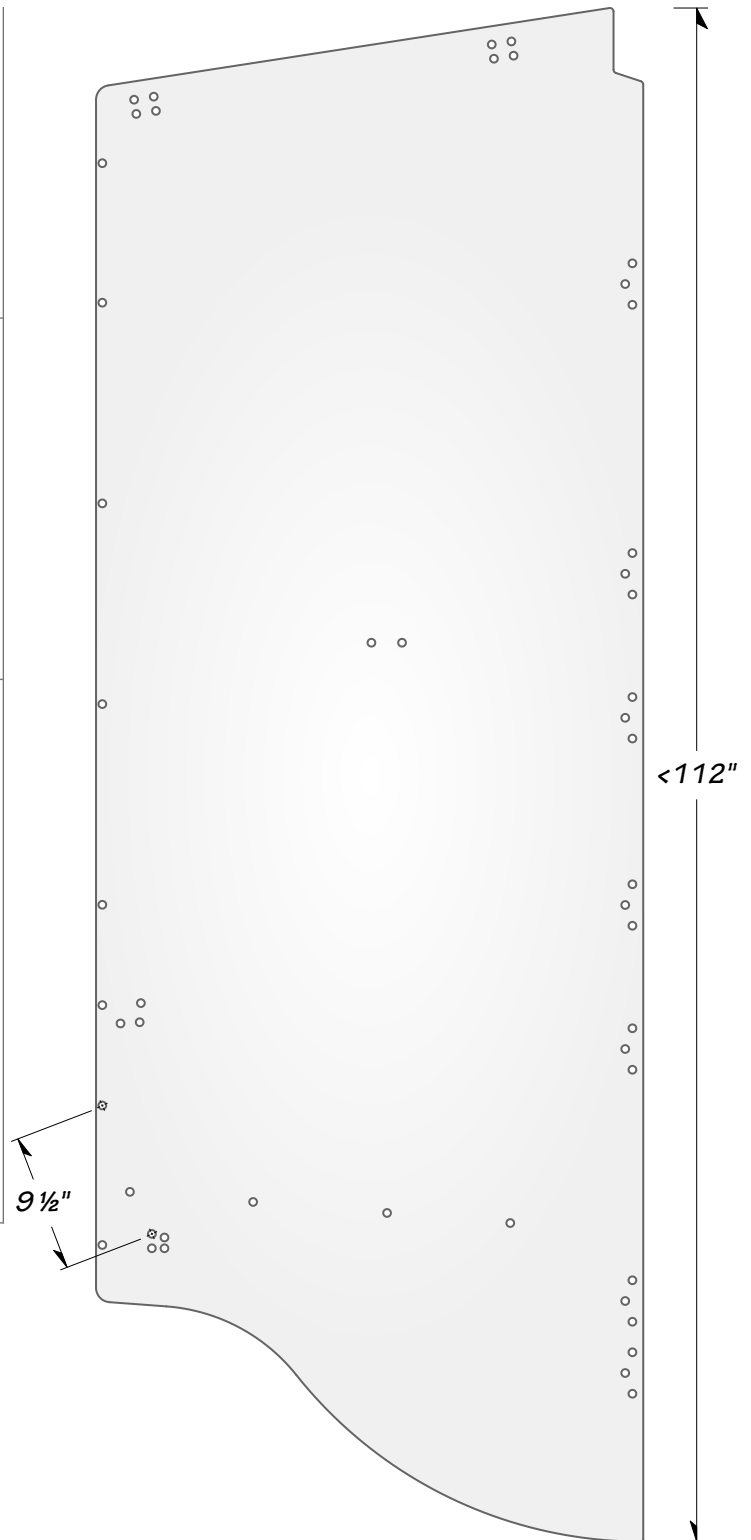

Lateral Panel Part Numbers [†]		Latch Type
RDS P/N	CBS P/N	M, HP or LP
<i>(Contact STEMCO)</i>		M
<i>(Contact STEMCO)</i>		HP
<i>(Contact STEMCO)</i>		LP

[†]All lateral panels ordered will come pre-assembled with appropriate brackets, stiffeners, mechanical latches and cable components. Mounting hinges and AutoDeploy electronic latches are **not** included. Default color for lateral panels is white and will come with standard TrailerTail® decals (see page 05). If your panels are a different color or you have a different decal layout or custom decals, notify Customer Support when ordering.

TRI Family #5L

Instructions:

1. Determine your latch type by choosing the design that best matches your existing latch.
2. Choose the respective roadside (RDS) or curbside (CBS) part number for your panel.

Latch Type

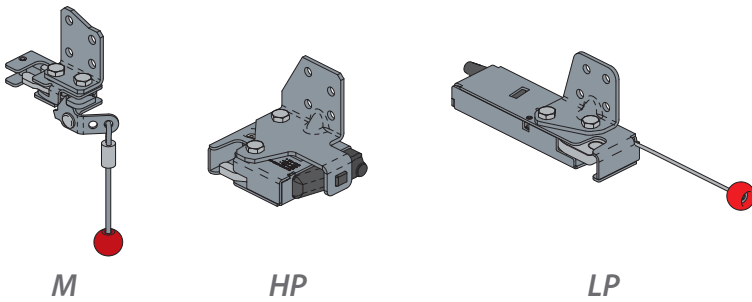

If you have latch type "HP" and it is **not reusable** or is damaged, choose from the part numbers with the "LP" latch type. Additionally, you will need latches from the list of **low-profile latch replacement kits** on page 55.

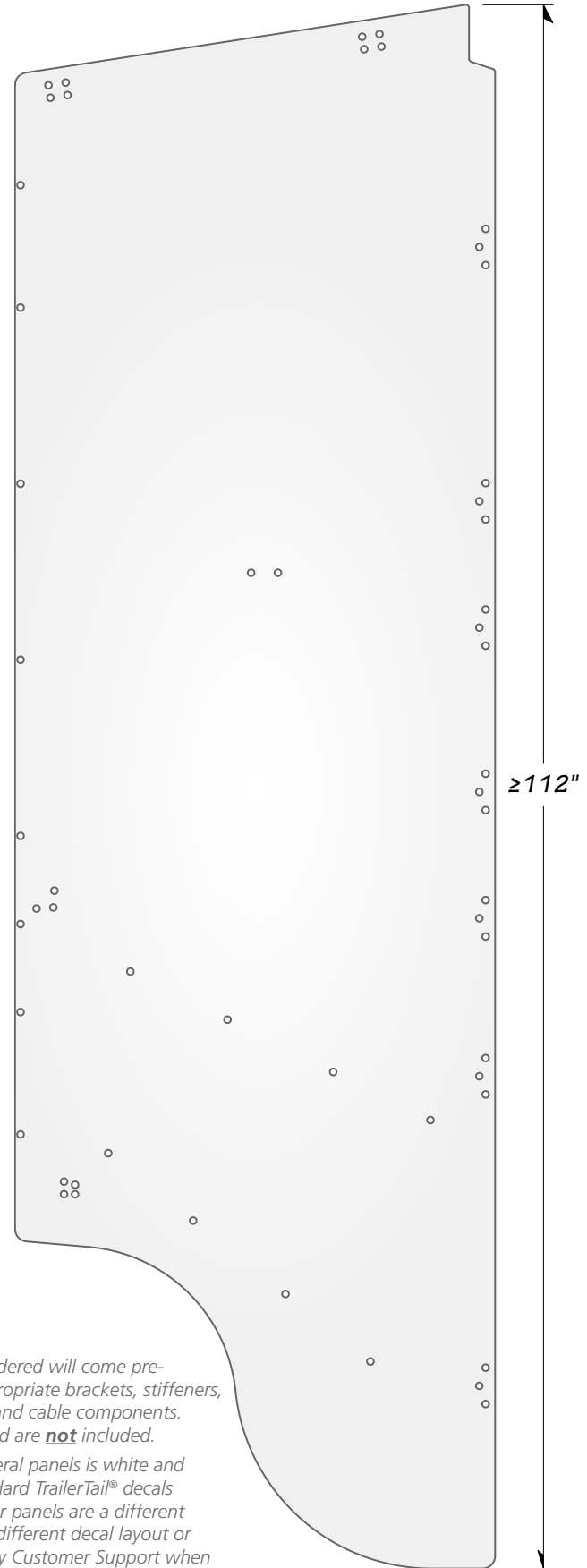

Lateral Panel Part Numbers [†]		Latch Type
RDS P/N	CBS P/N	M, HP or LP
ATD004092	ATD004093	M
(Contact STEMCO)		HP
(Contact STEMCO)		LP

[†]All lateral panels ordered will come pre-assembled with appropriate brackets, stiffeners, mechanical latches and cable components. Mounting hinges and are **not** included.

Default color for lateral panels is white and will come with standard TrailerTail® decals (see page 05). If your panels are a different color or you have a different decal layout or custom decals, notify Customer Support when ordering.

Top Panel

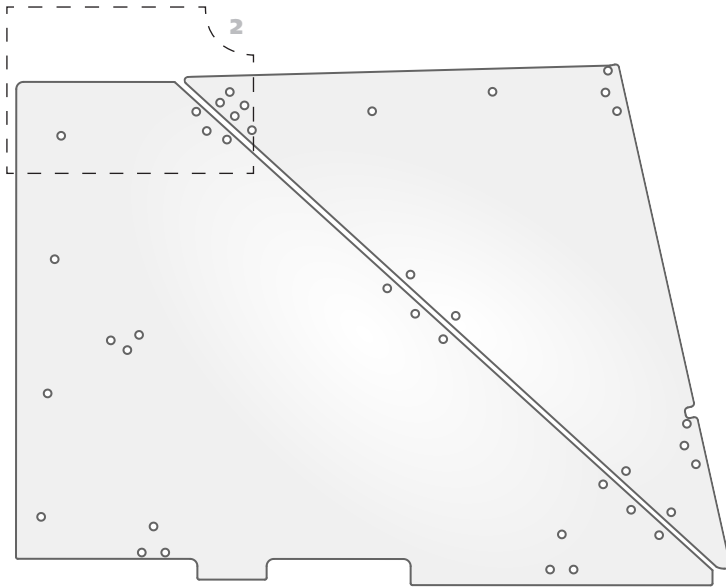

Instructions:

1. Determine your bracket type by choosing the design that best matches your door mounting brackets.
2. Identify your trailer type.
3. Measure the distance between the holes highlighted in blue (Distance A) based on your hole pattern.
4. Determine the family number of your panel from the table below. Flip to the page of that family.

Bracket Type

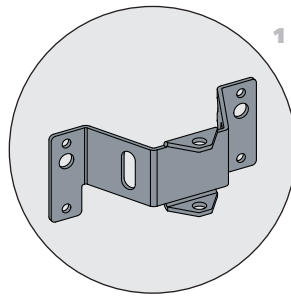

R

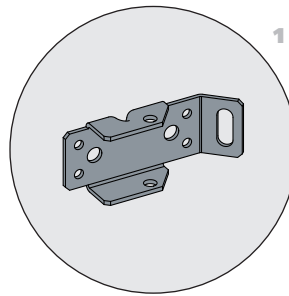

S

Distance A

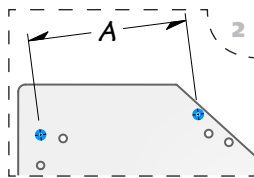

Outside of Rib

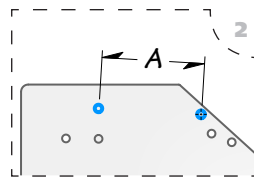

Inside of Rib

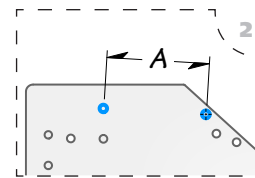

Both

Family	¹ Bracket Type	Trailer Type	² A
TRI #1T*	R	Dry	8 ½" – 11"
TRI #2T	S	Dry	11 ¼"
TRI #3T*	R	Refrigerated	10" – 11"
TRI #4T	R	Refrigerated	7 ¼"

*Indicates most common configuration family.

TRI Family #1T

(Most common family configuration)

Instructions:

1. Measure the distance between the holes highlighted in blue (Distance B).
2. Choose the respective roadside (RDS) or curbside (CBS) part number for your panel using the information above.

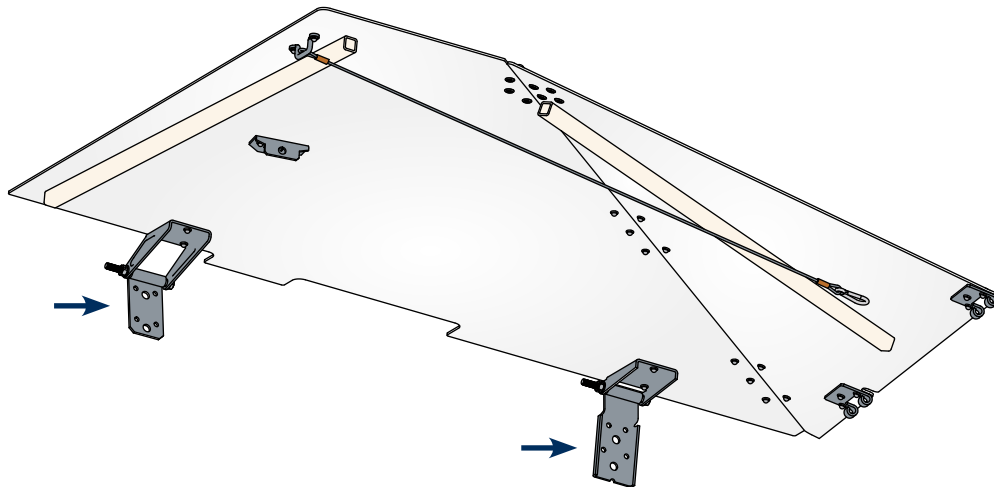
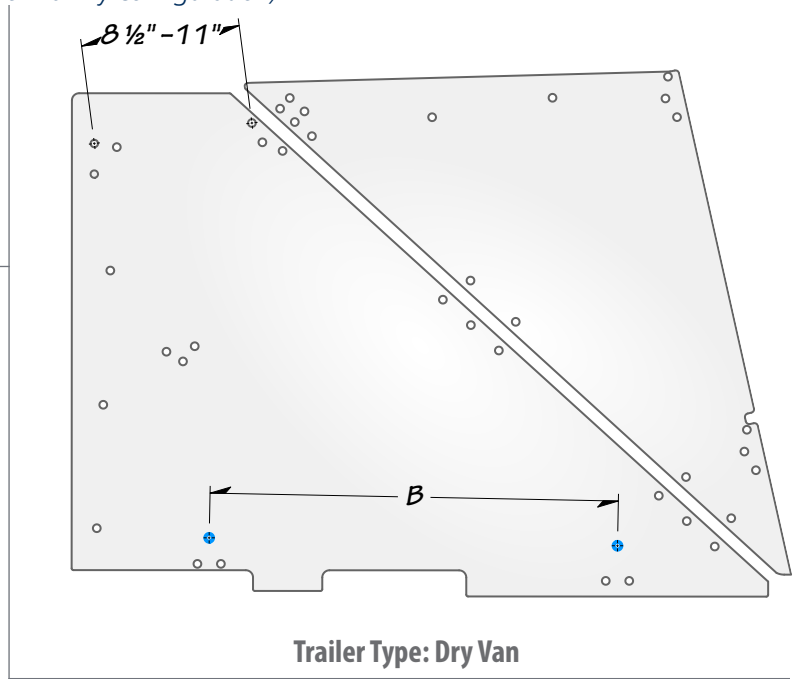

All top panels ordered in this family will come with two triangular shaped panels pre-assembled together with appropriate brackets, stiffeners, and cable components. Mounting hinges are included.

Top Panel Part Numbers†		B
RDS P/N	CBS P/N	
ATD000648	ATD000649	28 3/8"
(Contact STEMCO)		25 3/8"
ATD001318	ATD001319	23 3/8"

†All top panels ordered in this family will come pre-assembled as shown above. Mounting hinges are included.

Panels may not be symmetric between roadside and curbside. Please measure the exact panel you are replacing.

Default color for panels is white. If your panel is a different color, please indicate when ordering.

TRI Family #2T

Instructions:

1. Measure the maximum horizontal width of the panel (Distance C).
2. Choose the respective roadside (RDS) or curbside (CBS) part number for your panel using the information above.

Bracket Type

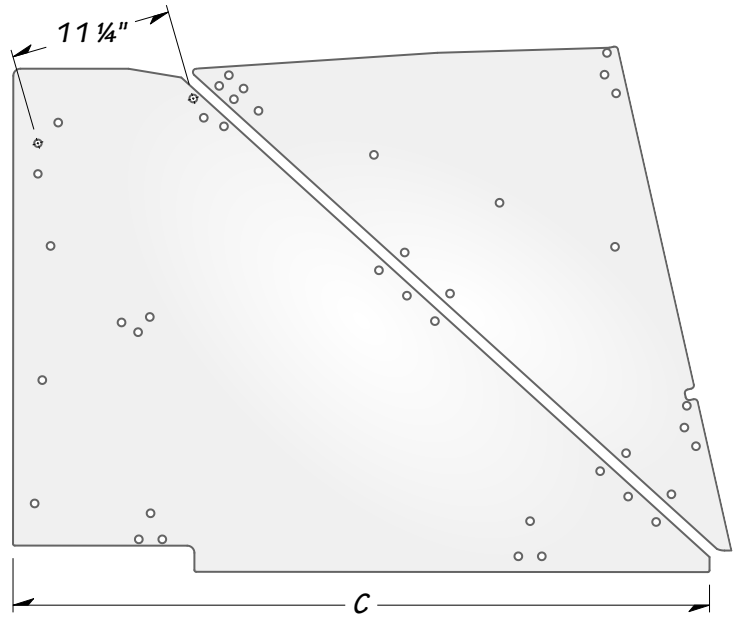
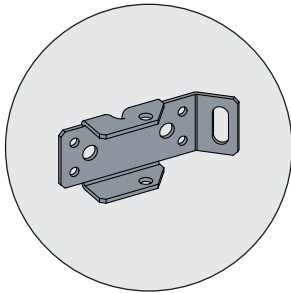

Trailer Type: Dry Van

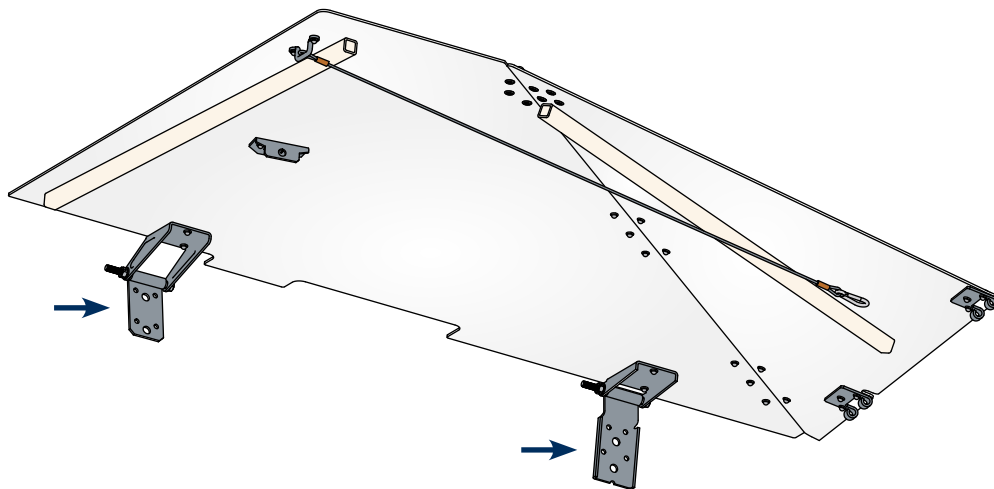

All top panels ordered in this family will come with two triangular shaped panels pre-assembled together with appropriate brackets, stiffeners, and cable components. Mounting hinges are included.

Top Panel Part Numbers†		C
RDS P/N	CBS P/N	
ATD001890	ATD001891	48 3/8"
ATD002186	ATD002187	47 5/8"

†All top panels ordered in this family will come pre-assembled as shown above. Mounting hinges are included.

Panels may not be symmetric between roadside and curbside. Please measure the exact panel you are replacing.

Default color for panels is white. If your panel is a different color, please indicate when ordering.

TRI Family #3T

(Most common family configuration)

Instructions:

1. Measure the distance between the holes highlighted in blue (Distance B).
2. Choose the respective roadside (RDS) or curbside (CBS) part number for your panel using the information above.

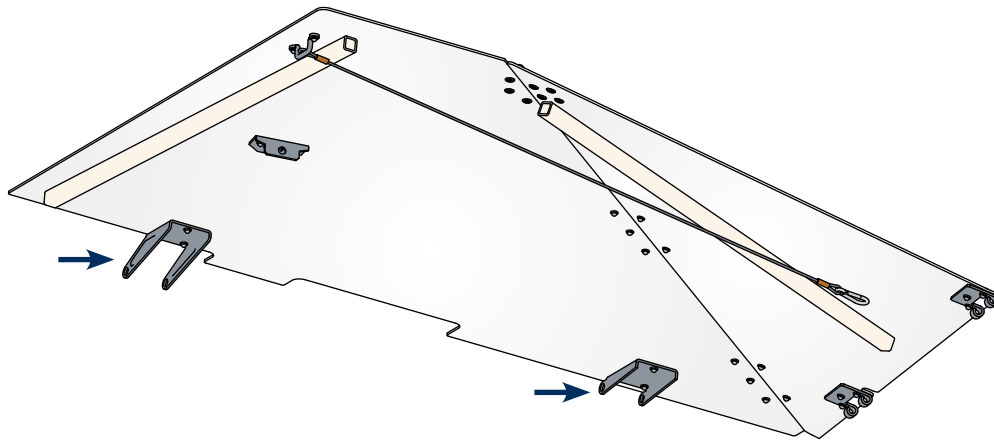
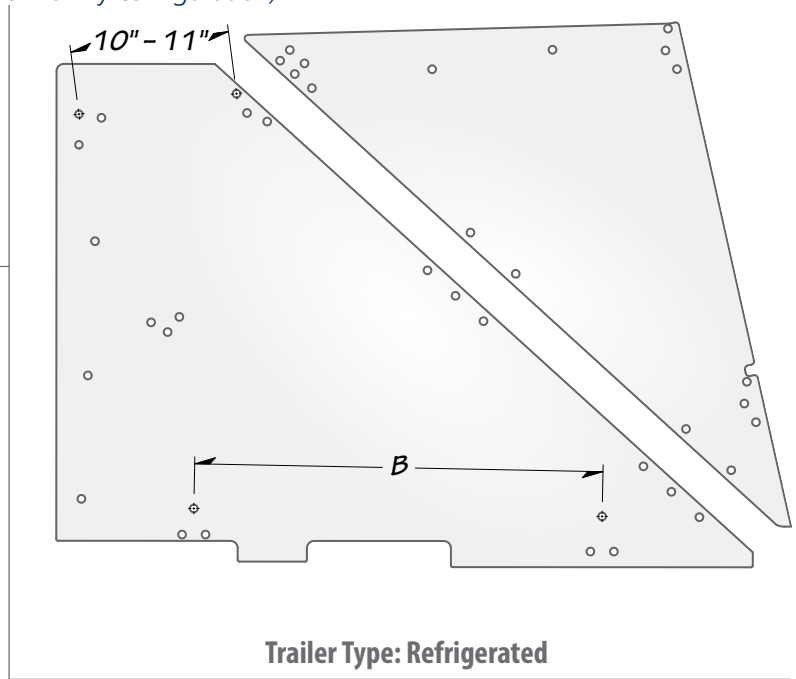

All top panels ordered in this family will come with two triangular shaped panels pre-assembled together with appropriate brackets, stiffeners, and cable components. Mounting hinges are **not** included.

Top Panel Part Numbers†		B
RDS P/N	CBS P/N	
ATD001084	ATD001085	28 3/8"
ATD001602	N/A	30 3/8"
<i>(Contact STEMCO)</i>		25 3/8"

†All top panels ordered in this family will come pre-assembled as shown above. Mounting hinges are **not** included.

Panels may not be symmetric between roadside and curbside. Please measure the exact panel you are replacing.

Default color for panels is white. If your panel is a different color, please indicate when ordering.

TRI Family #4T

Instructions:

1. Choose the respective roadside (RDS) or curbside (CBS) part number for your panel using the information above.

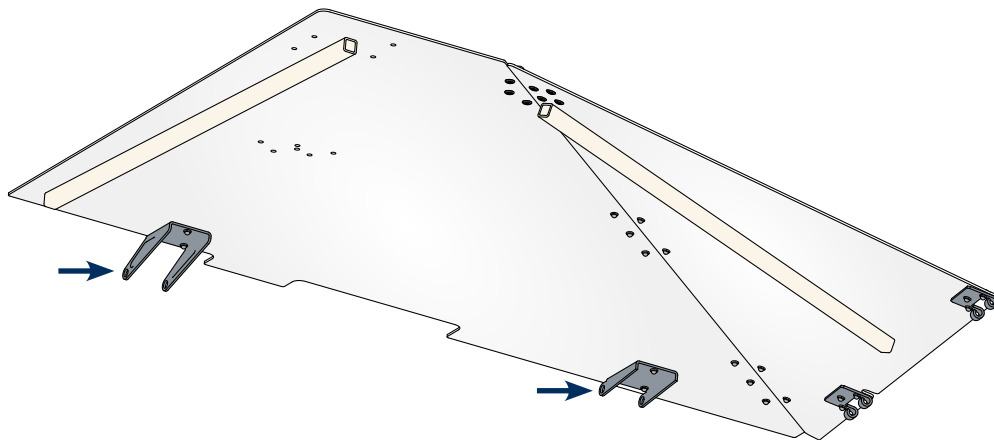
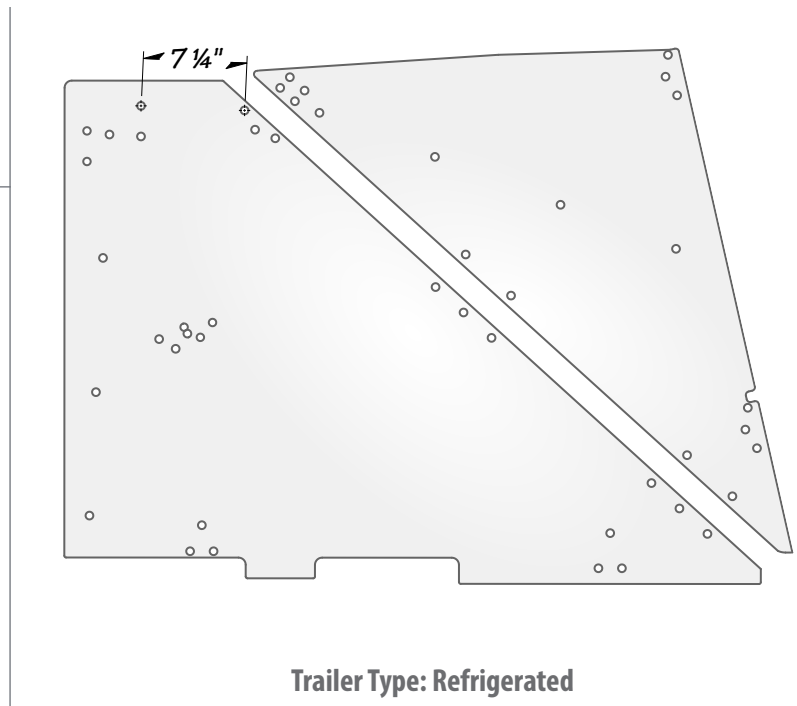

All top panels ordered in this family will come with two triangular shaped panels pre-assembled together with appropriate brackets, stiffeners, and cable components. Several components including mounting hinges are **not** included. Please refer to [ATD002331] *Install Manual - Universal Panels* for details on installing components correctly.

Top Panel Part Numbers†

RDS P/N	CBS P/N
ATD002148	ATD002149

†All top panels ordered in this family will come pre-assembled as shown above. Mounting hinges are **not** included.

Default color for panels is white. If your panel is a different color, please indicate when ordering.

Brackets

Image	Part Number	Description
	ATD000002	<p>Hinge Female A</p> <p><i>Metal bracket pre-rieveted to all replacement top and bottom panels on outside corners of TrailerTail®. Replace only if damaged.</i></p> <p>Connects to:</p> <ul style="list-style-type: none"> ▪ ATD001134 ▪ ATD001136 <p>Connects with:</p> <ul style="list-style-type: none"> ▪ (x1) Bolt, 5/16" ▪ (x1) Nut, 5/16" <p>Attaches to:</p> <ul style="list-style-type: none"> ▪ 1 per top or bottom panel <p>Attaches with:</p> <ul style="list-style-type: none"> ▪ (x3) Ornit rivets, 1/4"
	ATD000003	<p>Hinge Female B</p> <p><i>Metal bracket pre-rieveted to all replacement top and bottom panels on medial corners of TrailerTail®. Replace only if damaged.</i></p> <p>Connects to:</p> <ul style="list-style-type: none"> ▪ ATD001137 <p>Connects with:</p> <ul style="list-style-type: none"> ▪ (x1) Bolt, 5/16" ▪ (x1) Nut, 5/16" <p>Attaches to:</p> <ul style="list-style-type: none"> ▪ 1 per top or bottom panel <p>Attaches with:</p> <ul style="list-style-type: none"> ▪ (x3) Ornit rivets, 1/4"
	ATD000004	<p>Lateral Hinge Female</p> <p><i>Metal bracket used in various locations on TrailerTail®. Does not come included with lateral panel replacements.</i></p> <p>Connects to:</p> <ul style="list-style-type: none"> ▪ ATD001134 ▪ ATD001135 ▪ ATD001136 <p>Connects with:</p> <ul style="list-style-type: none"> ▪ (x1) Bolt, 5/16" ▪ (x1) Nut, 5/16" <p>Attaches to:</p> <ul style="list-style-type: none"> ▪ 4 per lateral panel (refrigerated trailers) <p>Attaches with:</p> <ul style="list-style-type: none"> ▪ (x3) Ornit rivets, 1/4"
	ATD000147	<p>ASY Lateral Hinge</p> <p><i>Pre-assembled metal hinge. Does not come included with lateral panel replacements.</i></p> <p>Attaches to:</p> <ul style="list-style-type: none"> ▪ 4 per lateral panel (dry van trailers) ▪ Trailer door (dry van trailers) <p>Attaches with:</p> <ul style="list-style-type: none"> ▪ (x3) Ornit rivets, 1/4" ▪ (x2) Carriage bolts, 3/8" ▪ (x2) Flange nuts, 3/8"

Image	Part Number	Description
	<p>ATD001134</p>	<p>ASY Hinge Male, Self-Adhering</p> <p><i>Metal bracket used in various locations on TrailerTail®. Does not come included with top and bottom panel replacements for refrigerated trailers or lateral panel replacements. Comes included with top and bottom panel replacements for dry van trailers. Do not use on Wabash refrigerated trailers.</i></p> <p>Connects to:</p> <ul style="list-style-type: none"> ▪ ATD000004 (refrigerated trailers) (non-Wabash) ▪ ATD000002 (refrigerated trailers) (non-Wabash) <p>Connects with:</p> <ul style="list-style-type: none"> ▪ (x1) Bolt, 5/16" ▪ (x1) Nut, 5/16" ▪ (x1) Bolt, 5/16" ▪ (x1) Nut, 5/16" ▪ (x2) Washers, 5/16" <p>Attaches to:</p> <ul style="list-style-type: none"> ▪ Trailer door <p>Attaches with:</p> <ul style="list-style-type: none"> ▪ (x4) Bulb-Tite rivets, 1/4"
	<p>ATD001135</p>	<p>ASY Hinge Male, Extended Mounted, Self-Adhering</p> <p><i>Metal bracket used on lateral panels. Does not come included with lateral panel replacements. Must be used on Wabash refrigerated trailers.</i></p> <p>Connects to:</p> <ul style="list-style-type: none"> ▪ ATD000004 (refrigerated trailers) <p>Connects with:</p> <ul style="list-style-type: none"> ▪ (x1) Bolt, 5/16" ▪ (x1) Nut, 5/16" <p>Attaches to:</p> <ul style="list-style-type: none"> ▪ Trailer door <p>Attaches with:</p> <ul style="list-style-type: none"> ▪ (x4) Bulb-Tite rivets, 1/4"
	<p>ATD001136</p>	<p>ASY Hinge Male, Clearance, Self-Adhering</p> <p><i>Metal bracket used on top and bottom panels. Does not come included with top and bottom panel replacements. Must be used on Wabash refrigerated trailers.</i></p> <p>Connects to:</p> <ul style="list-style-type: none"> ▪ ATD000002 (refrigerated trailers) <p>Connects with:</p> <ul style="list-style-type: none"> ▪ (x1) Bolt, 5/16" ▪ (x1) Nut, 5/16" ▪ (x2) Washers, 5/16" <p>Attaches to:</p> <ul style="list-style-type: none"> ▪ Trailer door <p>Attaches with:</p> <ul style="list-style-type: none"> ▪ (x4) Bulb-Tite rivets, 1/4"

Image	Part Number	Description
	<p>ATD001137</p>	<p>ASY Hinge Male Short, Self-Adhering</p> <p><i>Metal bracket used on top and bottom panels. Does not come included with top and bottom panel replacements for refrigerated trailers. Comes included with top and bottom panel replacements for dry van trailers.</i></p> <p>Connects to:</p> <ul style="list-style-type: none"> ▪ ATD000003 (refrigerated trailers) <p>Connects with:</p> <ul style="list-style-type: none"> ▪ (x1) Bolt, 5/16" ▪ (x1) Nut, 5/16" ▪ (x2) Washers, 5/16" <p>Attaches to:</p> <ul style="list-style-type: none"> ▪ Trailer door <p>Attaches with:</p> <ul style="list-style-type: none"> ▪ (x4) Bulb-Tite rivets, 1/4"
	<p>ATD000152</p>	<p>ASY Origami Hinge Male</p> <p><i>Pre-assembled metal hinge. Only used to connect top or bottom panel assemblies together. Comes included in top and bottom panel replacements. Replace only if damaged.</i></p> <p>Attaches to:</p> <ul style="list-style-type: none"> ▪ 1 per top or bottom panel <p>Attaches with:</p> <ul style="list-style-type: none"> ▪ (x7) Ormit rivets, 1/4"
	<p>ATD001138</p>	<p>ASY Swingarm Hat Platform, Self-Adhering</p> <p><i>Metal bracket used in swingarm assemblies. Does not come included with swingarm replacements.</i></p> <p>Connects to:</p> <ul style="list-style-type: none"> ▪ ATD000154 ▪ ATD000155 ▪ ATD001060 ▪ ATD001061 ▪ ATD001141 ▪ ATD001142 ▪ ATD001622 ▪ ATD001623 <p>Connects with:</p> <ul style="list-style-type: none"> ▪ (x1) Bolt, 5/16" ▪ (x1) Nut, 5/16" ▪ (x2) Washers, 5/16" <p>Attaches to:</p> <ul style="list-style-type: none"> ▪ Trailer door (refrigerated trailers) ▪ Trailer door (dry van trailers) <p>Attaches with:</p> <ul style="list-style-type: none"> ▪ (x4) Bulb-Tite rivets, 1/4" ▪ (x2) Carriage bolts, 3/8" ▪ (x2) Flange nuts, 3/8"

Image	Part Number	Description
	ATD001139	<p>ASY Gas Spring Bracket, Self-Adhering</p> <p>Pre-assembled metal bracket. Does not come included with swingarm replacements.</p> <p>Connects to:</p> <ul style="list-style-type: none"> ▪ ATD000071 ▪ ATD000425 <p>Connects with:</p> <ul style="list-style-type: none"> ▪ Ball stud (included) <p>Attaches to:</p> <ul style="list-style-type: none"> ▪ Trailer door (refrigerated trailers) ▪ Trailer door (dry van trailers) <p>Attaches with:</p> <ul style="list-style-type: none"> ▪ (x4) Bulb-Tite rivets, 1/4" ▪ (x2) Carriage bolts, 3/8" ▪ (x2) Flange nuts, 3/8"
	ATD001527	<p>Swingarm Bracket, Slim</p> <p>Metal bracket used in swingarm assemblies. Does not come included with swingarm replacements.</p> <p>Connects to:</p> <ul style="list-style-type: none"> ▪ ATD002532 ▪ ATD002533 <p>Connects with:</p> <ul style="list-style-type: none"> ▪ (x1) Bolt, 5/16" ▪ (x1) Nut, 5/16" ▪ (x2) Washers, 5/16" <p>Attaches to:</p> <ul style="list-style-type: none"> ▪ Trailer door (dry van trailers) <p>Attaches with:</p> <ul style="list-style-type: none"> ▪ (x2) Carriage bolts, 3/8" ▪ (x2) Flange nuts, 3/8"
	ATD001577	<p>ASY Gas Spring Bracket, Slim, RDS</p> <p>Pre-assembled metal bracket. Does not come included with swingarm replacements.</p> <p>Connects to:</p> <ul style="list-style-type: none"> ▪ ATD000071 ▪ ATD000425 <p>Connects with:</p> <ul style="list-style-type: none"> ▪ Ball stud (included) <p>Attaches to:</p> <ul style="list-style-type: none"> ▪ Trailer door (dry van trailers) <p>Attaches with:</p> <ul style="list-style-type: none"> ▪ (x2) Carriage bolts, 3/8" ▪ (x2) Flange nuts, 3/8"
	ATD001578	<p>ASY Gas Spring Bracket, Slim, CBS</p> <p>Pre-assembled metal bracket. Does not come included with swingarm replacements.</p> <p>Connects to:</p> <ul style="list-style-type: none"> ▪ ATD000071 ▪ ATD000425 <p>Connects with:</p> <ul style="list-style-type: none"> ▪ Ball stud (included) <p>Attaches to:</p> <ul style="list-style-type: none"> ▪ Trailer door (dry van trailers) <p>Attaches with:</p> <ul style="list-style-type: none"> ▪ (x2) Carriage bolts, 3/8" ▪ (x2) Flange nuts, 3/8"

Image	Part Number	Description				
	ATD001140	<p>ASY Striker Bolt Bracket, Self-Adhering</p> <p>Pre-assembled metal bracket used for latching. Flange length is 1". Comes included with 4x4 replacement panels.</p> <table border="0"> <tr> <td>Attaches to:</td> <td>Attaches with:</td> </tr> <tr> <td> <ul style="list-style-type: none"> ▪ Trailer door (refrigerated trailers) ▪ Trailer door (dry van trailers) </td> <td> <ul style="list-style-type: none"> ▪ (x3) Bulb-Tite rivets, 1/4" ▪ (x2) Carriage bolts, 3/8" ▪ (x2) Flange nuts, 3/8" </td> </tr> </table>	Attaches to:	Attaches with:	<ul style="list-style-type: none"> ▪ Trailer door (refrigerated trailers) ▪ Trailer door (dry van trailers) 	<ul style="list-style-type: none"> ▪ (x3) Bulb-Tite rivets, 1/4" ▪ (x2) Carriage bolts, 3/8" ▪ (x2) Flange nuts, 3/8"
Attaches to:	Attaches with:					
<ul style="list-style-type: none"> ▪ Trailer door (refrigerated trailers) ▪ Trailer door (dry van trailers) 	<ul style="list-style-type: none"> ▪ (x3) Bulb-Tite rivets, 1/4" ▪ (x2) Carriage bolts, 3/8" ▪ (x2) Flange nuts, 3/8" 					
	ATD002151	<p>ASY Striker Bolt Bracket, Long Flange, Self-Adhering</p> <p>Pre-assembled metal bracket used for latching. Flange length is 2".</p> <table border="0"> <tr> <td>Attaches to:</td> <td>Attaches with:</td> </tr> <tr> <td> <ul style="list-style-type: none"> ▪ Trailer door (refrigerated trailers) ▪ Trailer door (dry van trailers) </td> <td> <ul style="list-style-type: none"> ▪ (x3) Bulb-Tite rivets, 1/4" ▪ (x2) Carriage bolts, 3/8" ▪ (x2) Flange nuts, 3/8" </td> </tr> </table>	Attaches to:	Attaches with:	<ul style="list-style-type: none"> ▪ Trailer door (refrigerated trailers) ▪ Trailer door (dry van trailers) 	<ul style="list-style-type: none"> ▪ (x3) Bulb-Tite rivets, 1/4" ▪ (x2) Carriage bolts, 3/8" ▪ (x2) Flange nuts, 3/8"
Attaches to:	Attaches with:					
<ul style="list-style-type: none"> ▪ Trailer door (refrigerated trailers) ▪ Trailer door (dry van trailers) 	<ul style="list-style-type: none"> ▪ (x3) Bulb-Tite rivets, 1/4" ▪ (x2) Carriage bolts, 3/8" ▪ (x2) Flange nuts, 3/8" 					
	ATD003210	<p>ASY Striker Bolt Bracket, Dual Flange, 1.3 in, Self-Adhering</p> <p>Pre-assembled metal bracket used for latching. Flange length is 1 1/4". Does not come included with panel replacements.</p> <table border="0"> <tr> <td>Attaches to:</td> <td>Attaches with:</td> </tr> <tr> <td> <ul style="list-style-type: none"> ▪ Trailer door (refrigerated trailers) ▪ Trailer door (dry van trailers) </td> <td> <ul style="list-style-type: none"> ▪ (x3) Bulb-Tite rivets, 1/4" ▪ (x2) Carriage bolts, 3/8" ▪ (x2) Flange nuts, 3/8" </td> </tr> </table>	Attaches to:	Attaches with:	<ul style="list-style-type: none"> ▪ Trailer door (refrigerated trailers) ▪ Trailer door (dry van trailers) 	<ul style="list-style-type: none"> ▪ (x3) Bulb-Tite rivets, 1/4" ▪ (x2) Carriage bolts, 3/8" ▪ (x2) Flange nuts, 3/8"
Attaches to:	Attaches with:					
<ul style="list-style-type: none"> ▪ Trailer door (refrigerated trailers) ▪ Trailer door (dry van trailers) 	<ul style="list-style-type: none"> ▪ (x3) Bulb-Tite rivets, 1/4" ▪ (x2) Carriage bolts, 3/8" ▪ (x2) Flange nuts, 3/8" 					
	ATD003211	<p>ASY Striker Bolt Bracket, Dual Flange, 2.4 in, Self-Adhering</p> <p>Pre-assembled metal bracket used for latching. Flange length is 2 3/8". Does not come included with panel replacements.</p> <table border="0"> <tr> <td>Attaches to:</td> <td>Attaches with:</td> </tr> <tr> <td> <ul style="list-style-type: none"> ▪ Trailer door (refrigerated trailers) ▪ Trailer door (dry van trailers) </td> <td> <ul style="list-style-type: none"> ▪ (x3) Bulb-Tite rivets, 1/4" ▪ (x2) Carriage bolts, 3/8" ▪ (x2) Flange nuts, 3/8" </td> </tr> </table>	Attaches to:	Attaches with:	<ul style="list-style-type: none"> ▪ Trailer door (refrigerated trailers) ▪ Trailer door (dry van trailers) 	<ul style="list-style-type: none"> ▪ (x3) Bulb-Tite rivets, 1/4" ▪ (x2) Carriage bolts, 3/8" ▪ (x2) Flange nuts, 3/8"
Attaches to:	Attaches with:					
<ul style="list-style-type: none"> ▪ Trailer door (refrigerated trailers) ▪ Trailer door (dry van trailers) 	<ul style="list-style-type: none"> ▪ (x3) Bulb-Tite rivets, 1/4" ▪ (x2) Carriage bolts, 3/8" ▪ (x2) Flange nuts, 3/8" 					

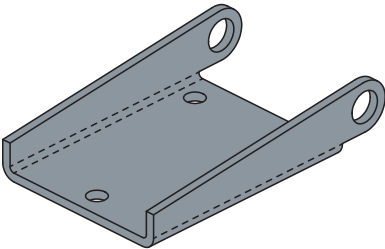
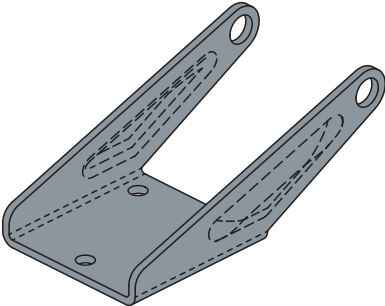
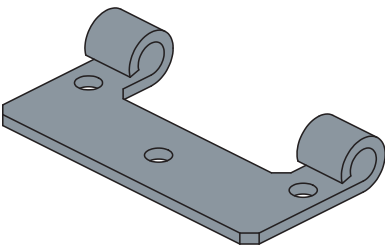
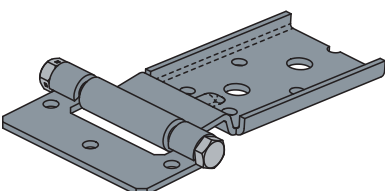
Other Metal Hardware

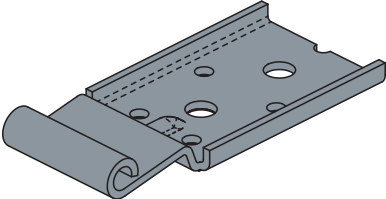
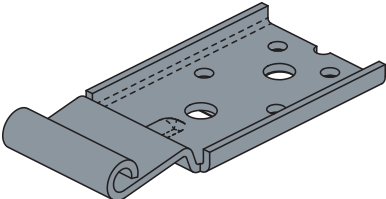
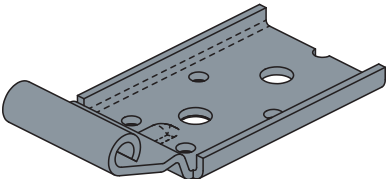
Image	Part Number	Description
	ATD000015	<p>Cable, 43.25 in</p> <p>Cable with silver painted swaged ends used on 4x4 top and bottom panels. Comes included with top and bottom panel replacements. Be sure to measure length of cable for replacement.</p> <p>Attaches to:</p> <ul style="list-style-type: none"> ▪ 4x4 bottom panels ▪ ATD001138
	ATD002772	<p>Cable, 41.125 in</p> <p>Cable with silver painted swaged ends used on 4x4 bottom panels. Comes included with bottom panel replacements. Be sure to measure length of cable for replacement.</p> <p>Attaches to:</p> <ul style="list-style-type: none"> ▪ 4x4 bottom panels ▪ ATD001138
	ATD000016	<p>Cable, 35.375 in</p> <p>Cable with copper swaged ends used on 4x4 lateral panels and Trident top and lateral panels. Comes included with panel replacements. Be sure to measure length of cable for replacement.</p> <p>Attaches to:</p> <ul style="list-style-type: none"> ▪ 4x4 lateral panels ▪ Trident top and lateral panels ▪ ATD001527 ▪ ATD001139
	ATD001529	<p>Cable, 29.75 in</p> <p>Cable with black painted swaged ends used on Trident Slim lateral panels. Comes included with panel replacements. Be sure to measure length of cable for replacement.</p> <p>Attaches to:</p> <ul style="list-style-type: none"> ▪ 4x4 lateral panels ▪ Trident top and lateral panels ▪ ATD001527 ▪ ATD001139
	ATD003173	<p>Cable, 9 in</p> <p>Cable with copper swaged ends used for secondary cable latches. Be sure to measure length of cable for replacement.</p>

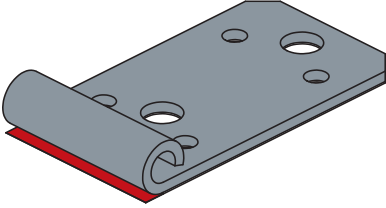
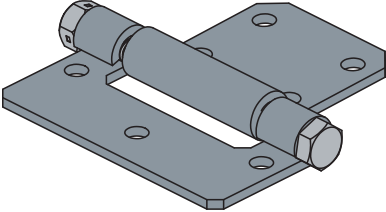
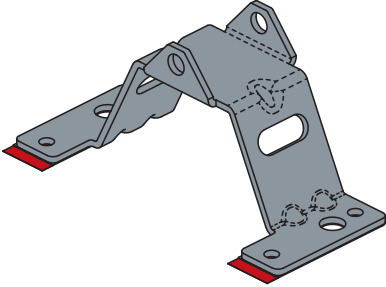
Image	Part Number	Description
	<p>ATD001115</p>	<p>Cable, 13.75 in</p> <p>Cable with copper swaged ends used on Trident swingarm assemblies. Be sure to measure length of cable for replacement.</p> <p>Attaches to:</p> <ul style="list-style-type: none"> ▪ ATD001139 ▪ ATD001577 ▪ ATD001578 ▪ ATD000154 ▪ ATD000155 ▪ ATD002532 ▪ ATD002533
	<p>ATD000019</p>	<p>ASY Rotary Latch, RDS</p> <p>OneTouch™ for roadside manual deployment. Comes included on 4x4 bottom panels and Trident lateral panels.</p> <p>Functions as curbside for Trident Covered lateral panels.</p> <p>Attaches to: Lateral or bottom panel</p> <p>Attaches with: (x4) Ornit rivets, 1/4"</p>
	<p>ATD000020</p>	<p>ASY Rotary Latch, CBS</p> <p>OneTouch™ for curbside manual deployment. Comes included on 4x4 bottom panels and Trident lateral panels.</p> <p>Functions as roadside for Trident Covered lateral panels.</p> <p>Attaches to: Lateral or bottom panel</p> <p>Attaches with: (x4) Ornit rivets, 1/4"</p>
	<p>ATD000154</p>	<p>ASY TT Swingarm, RDS, 33 in</p> <p>Pre-assembled roadside swingarm assembly. Used for most configurations. Measure long vertical tube for size.</p> <p>Connects to:</p> <ul style="list-style-type: none"> ▪ ATD001138 ▪ ATD001527 <p>Connects with:</p> <ul style="list-style-type: none"> ▪ (x2) Bolt, 5/16" ▪ (x2) Nut, 5/16" ▪ (x4) Washers, 5/16" <p>Attaches to:</p> <ul style="list-style-type: none"> ▪ 4x4 top and bottom panels ▪ Trident top and lateral panels <p>Attaches with:</p> <ul style="list-style-type: none"> ▪ (x2) Nuts, 3/8"-24

Image	Part Number	Description
	ATD000155	<p>ASY TT Swingarm, CBS, 33 in</p> <p><i>Pre-assembled curbside swingarm assembly. Used for most configurations. Measure long vertical tube for size.</i></p> <p>Connects to:</p> <ul style="list-style-type: none"> ▪ ATD001138 ▪ ATD001527 <p>Connects with:</p> <ul style="list-style-type: none"> ▪ (x2) Bolt, 5/16" ▪ (x2) Nut, 5/16" ▪ (x4) Washers, 5/16" <p>Attaches to:</p> <ul style="list-style-type: none"> ▪ 4x4 top and bottom panels ▪ Trident top and lateral panels <p>Attaches with:</p> <ul style="list-style-type: none"> ▪ (x2) Nuts, 3/8"-24
	ATD002532	<p>ASY TT Swingarm, Slim, RDS, 33 in</p> <p><i>Pre-assembled roadside swingarm assembly. Used for Trident Slims.</i></p> <p>Connects to:</p> <ul style="list-style-type: none"> ▪ ATD001527 <p>Connects with:</p> <ul style="list-style-type: none"> ▪ (x2) Bolt, 5/16" ▪ (x2) Nut, 5/16" ▪ (x4) Washers, 5/16" <p>Attaches to:</p> <ul style="list-style-type: none"> ▪ Trident top and lateral panels <p>Attaches with:</p> <ul style="list-style-type: none"> ▪ (x2) Nuts, 3/8"-24
	ATD002533	<p>ASY TT Swingarm, Slim, CBS, 33 in</p> <p><i>Pre-assembled curbside swingarm assembly. Used for Trident Slims.</i></p> <p>Connects to:</p> <ul style="list-style-type: none"> ▪ ATD001527 <p>Connects with:</p> <ul style="list-style-type: none"> ▪ (x2) Bolt, 5/16" ▪ (x2) Nut, 5/16" ▪ (x4) Washers, 5/16" <p>Attaches to:</p> <ul style="list-style-type: none"> ▪ Trident top and lateral panels <p>Attaches with:</p> <ul style="list-style-type: none"> ▪ (x2) Nuts, 3/8"-24

Image	Part Number	Description
	ATD001060	<p>ASY TT Swingarm, RDS, 29 in</p> <p><i>Pre-assembled roadside swingarm assembly. Used for some relatively short or tall trailers. Measure long vertical tube for size.</i></p> <p>Connects to:</p> <ul style="list-style-type: none"> ▪ ATD001138 <p>Connects with:</p> <ul style="list-style-type: none"> ▪ (x2) Bolt, 5/16" ▪ (x2) Nut, 5/16" ▪ (x4) Washers, 5/16" <p>Attaches to:</p> <ul style="list-style-type: none"> ▪ 4x4 top and bottom panels <p>Attaches with:</p> <ul style="list-style-type: none"> ▪ (x2) Nuts, 3/8"-24
	ATD001061	<p>ASY TT Swingarm, CBS, 29 in</p> <p><i>Pre-assembled curbside swingarm assembly. Used for some relatively short or tall trailers. Measure long vertical tube for size.</i></p> <p>Connects to:</p> <ul style="list-style-type: none"> ▪ ATD001138 <p>Connects with:</p> <ul style="list-style-type: none"> ▪ (x2) Bolt, 5/16" ▪ (x2) Nut, 5/16" ▪ (x4) Washers, 5/16" <p>Attaches to:</p> <ul style="list-style-type: none"> ▪ 4x4 top and bottom panels <p>Attaches with:</p> <ul style="list-style-type: none"> ▪ (x2) Nuts, 3/8"-24
	ATD001141	<p>ASY TT Swingarm, RDS, 41 in</p> <p><i>Pre-assembled roadside swingarm assembly. Used for drop frame trailers. Measure long vertical tube for size.</i></p> <p>Connects to:</p> <ul style="list-style-type: none"> ▪ ATD001138 <p>Connects with:</p> <ul style="list-style-type: none"> ▪ (x2) Bolt, 5/16" ▪ (x2) Nut, 5/16" ▪ (x4) Washers, 5/16" <p>Attaches to:</p> <ul style="list-style-type: none"> ▪ 4x4 top and bottom panels <p>Attaches with:</p> <ul style="list-style-type: none"> ▪ (x2) Nuts, 3/8"-24

Image	Part Number	Description
	ATD001142	<p>ASY TT Swingarm, CBS, 41 in</p> <p>Pre-assembled curbside swingarm assembly. Used for drop frame trailers. Measure long vertical tube for size.</p> <p>Connects to:</p> <ul style="list-style-type: none"> ▪ ATD001138 <p>Connects with:</p> <ul style="list-style-type: none"> ▪ (x2) Bolt, 5/16" ▪ (x2) Nut, 5/16" ▪ (x4) Washers, 5/16" <p>Attaches to:</p> <ul style="list-style-type: none"> ▪ 4x4 top and bottom panels <p>Attaches with:</p> <ul style="list-style-type: none"> ▪ (x2) Nuts, 3/8"-24
	ATD001622	<p>ASY TT Swingarm, RDS, 37 in</p> <p>Pre-assembled roadside swingarm assembly. Used for legacy TrailerTails®. Measure long vertical tube for size.</p> <p>Connects to:</p> <ul style="list-style-type: none"> ▪ ATD001138 <p>Connects with:</p> <ul style="list-style-type: none"> ▪ (x2) Bolt, 5/16" ▪ (x2) Nut, 5/16" ▪ (x4) Washers, 5/16" <p>Attaches to:</p> <ul style="list-style-type: none"> ▪ 4x4 top and bottom panels <p>Attaches with:</p> <ul style="list-style-type: none"> ▪ (x2) Nuts, 3/8"-24
	ATD001623	<p>ASY TT Swingarm, CBS, 37 in</p> <p>Pre-assembled curbside swingarm assembly. Used for legacy TrailerTails®. Measure long vertical tube for size.</p> <p>Connects to:</p> <ul style="list-style-type: none"> ▪ ATD001138 <p>Connects with:</p> <ul style="list-style-type: none"> ▪ (x2) Bolt, 5/16" ▪ (x2) Nut, 5/16" ▪ (x4) Washers, 5/16" <p>Attaches to:</p> <ul style="list-style-type: none"> ▪ 4x4 top and bottom panels <p>Attaches with:</p> <ul style="list-style-type: none"> ▪ (x2) Nuts, 3/8"-24
	ATD000723	<p>Tie-Rod</p> <p>Pre-assembled linkage. Comes included with swingarm assemblies.</p> <p>Connects to swingarms with:</p> <ul style="list-style-type: none"> ▪ (x1) Nut, 3/8" <p>Attaches to:</p> <ul style="list-style-type: none"> ▪ 4x4 top and bottom panels ▪ Trident top and lateral panels <p>Attaches with:</p> <ul style="list-style-type: none"> ▪ (x1) Nut, 3/8"-24

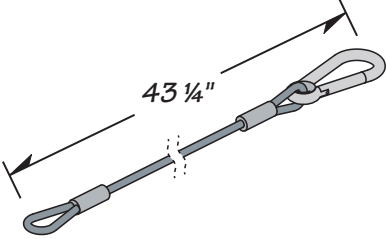
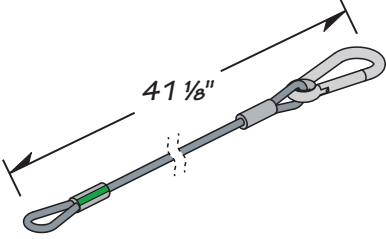
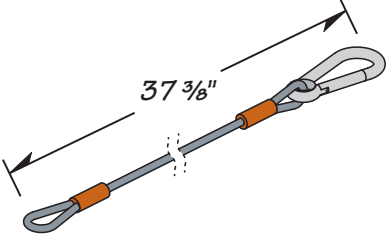
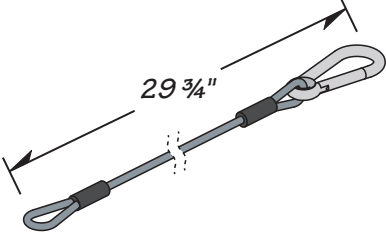
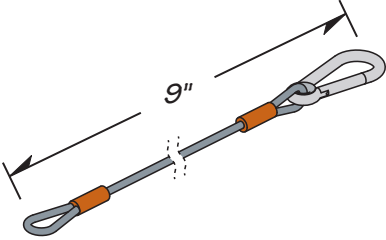
Image	Part Number	Description
	<p>ATD000333</p>	<p>ASY KIT Latching HW TrustLock, 5 Links</p> <p>Assembly kit used to convert Wabash TrustLock® Plus System trailers to a chain link latching system.</p> <p>Includes:</p> <ul style="list-style-type: none"> ▪ (x2) Open Links ▪ (x2) Hook Hold-Backs ▪ (x2) Chain Link Hold-Backs ▪ (x2) Bolts, 5/16" ▪ (x2) Nuts, 5/16"
	<p>ATD000553</p>	<p>ASY KIT Chain Link Extender</p> <p>Assembly kit to increase the chain link by 2 links.</p> <p>Includes:</p> <ul style="list-style-type: none"> ▪ (x2) Open Links ▪ (x2) Chain Link Rings
	<p>ATD003813</p>	<p>ASY KIT Secondary Cable Latch, Retrofit</p> <p>Assembly kit used to retrofit a secondary cable latch to TrailerTails®. Must be used for intermodal transport.</p> <p>Includes:</p> <ul style="list-style-type: none"> ▪ (x2) Cable, 9.0" ▪ (x4) Footman Loops ▪ (x4) Carriage bolts, 1/4" ▪ (x27) Ornit rivets, 1/4" ▪ (x4) Bulb-Tite rivets, 1/4" ▪ (x4) Nuts, 1/4"
	<p>ATD000576</p>	<p>Template Tab</p> <p>Metal bracket used to attach to templates for alignment to trailer frame.</p>

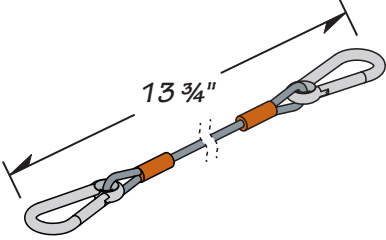
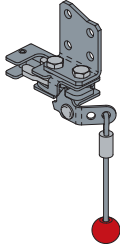
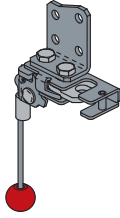
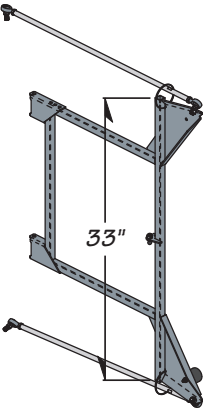
Fasteners

Image	Part Number	Description
	ATD000129	<p>ASY KIT Rivet, Ornit, 0.25 in (x27)</p> <p>Used to attach various components to panels.</p> <p>Includes:</p> <ul style="list-style-type: none"> (x27) Ornit rivets, 1/4"
	ATD003121	<p>ASY KIT Rivet, Ornit, 0.25 in (x2000)</p> <p>Used to attach various components to panels.</p> <p>Includes:</p> <ul style="list-style-type: none"> (x2000) Ornit rivets, 1/4"
	ATD000960	<p>ASY KIT Rivet, Bulb-Tite, 0.25 in (x90)</p> <p>Used to attach metal components to refrigerated trailer doors.</p> <p>Includes:</p> <ul style="list-style-type: none"> (x90) Bulb-Tite rivets, 1/4"
	ATD001856	<p>ASY KIT Bolt, Hex, 0.3125 in x 18, 3.75 in (x30) & Nut, Lock, 0.3125 in x 18 (x31) & Washer, 0.3125 in (x26), Kit 16</p> <p>Assembly kit used to hinge together various metal components.</p> <p>Includes:</p> <ul style="list-style-type: none"> (x30) Bolts, 5/16" (x31) Nuts, 5/16" (x26) Washers, 5/16"
	ATD000121	<p>ASY KIT Nut, Lock, 0.375 in x 24 (x5), Kit 1</p> <p>Used to connect tie-rods to swingarms and panels.</p> <p>Includes:</p> <ul style="list-style-type: none"> (x5) Nuts, 3/8"-24
	ATD001859	<p>ASY KIT Bolt, Carriage, 0.375 in x 16, 1.25 in (x45) & Nut, Flange, 0.375 in x 16 (x45), Kit 19</p> <p>Assembly kit used to attach metal components to dry van trailer doors.</p> <p>Includes:</p> <ul style="list-style-type: none"> (x45) Carriage bolts, 3/8" (x45) Flange nuts, 3/8"

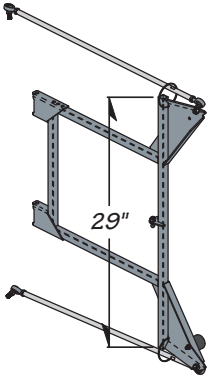
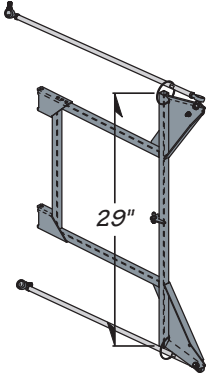
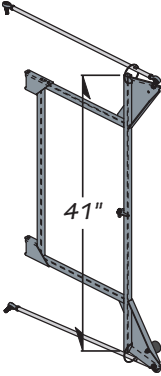
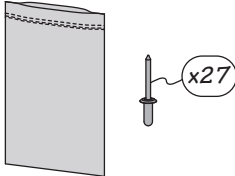
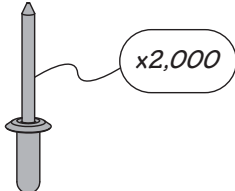
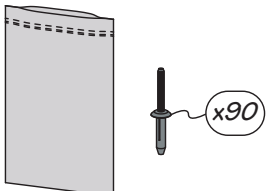
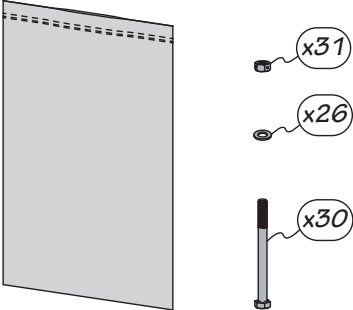
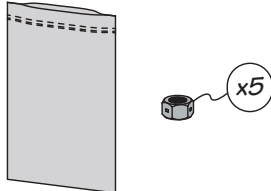
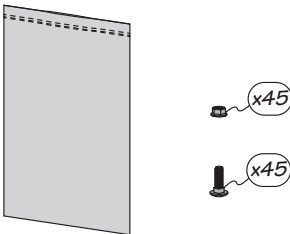
Miscellaneous

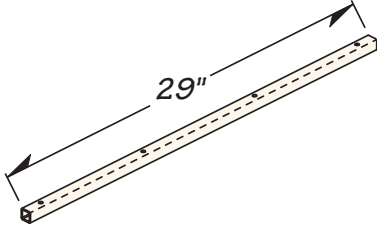
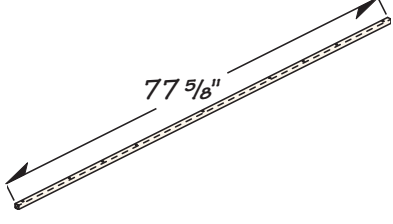
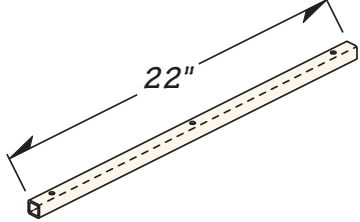
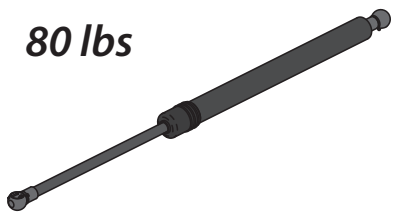
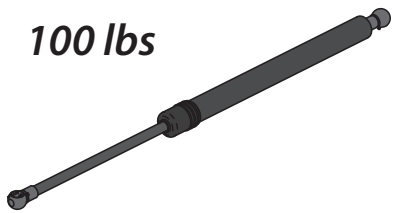
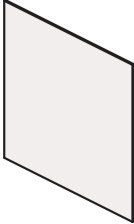
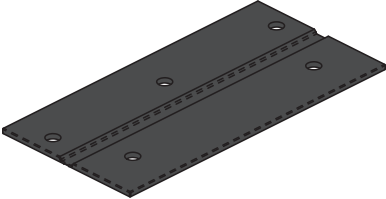
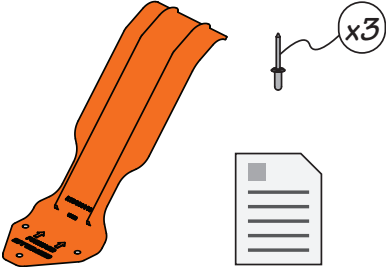

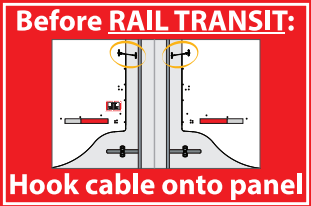



Image	Part Number	Description
	ATD000013	Square Rib, 29 in Stiffening rib used in various locations. Requires: <ul style="list-style-type: none"> (x4) Ornit rivets, 1/4"
	ATD000014	Square Rib, 77.625 in Stiffening rib used on lateral panels. Requires: <ul style="list-style-type: none"> (x7) Ornit rivets, 1/4" (4x4) or (x8) Ornit rivets, 1/4" (Trident)
	ATD002486	Square Rib, 22 in Stiffening rib used in various locations. Requires: <ul style="list-style-type: none"> (x3) Ornit rivets, 1/4"
80 lbs 	ATD000071	TT Gas Spring 80 lbs gas shock used to open TrailerTail® 4x4. Attaches swingarms to: <ul style="list-style-type: none"> ATD001139
100 lbs 	ATD000425	TRI Gas Spring 100 lbs gas shock used to open TrailerTail® Trident. Attaches swingarms to: <ul style="list-style-type: none"> ATD001139 ATD001577 ATD001578

Image	Part Number	Description
	ATD001423	<p>Sheet, Panel, 12 in x 12 in (Patch)</p> <p><i>White colored panel material used to patch tears or creases on TrailerTails®. Use rivets to attach to panel.</i></p>
	ATD002729	<p>Sheet, Panel, 12 in x 12 in (Patch), Black</p> <p><i>Black colored panel material used to patch tears or creases on TrailerTails®. Use rivets to attach to panel.</i></p>
	ATD000017	<p>Living Hinge</p> <p><i>Plastic hinge used on top and bottom panel assemblies. Must be purchased with ATD000021. Replace only if damaged.</i></p> <p><i>Requires:</i></p> <ul style="list-style-type: none"> ▪ (x5) Ornit rivets, 1/4"
	ATD000021	<p>Living Hinge Fabric</p> <p><i>Fabric used as reinforcement material to plastic hinges. Must be purchased with ATD000017. Replace only if damaged.</i></p> <p><i>Requires:</i></p> <ul style="list-style-type: none"> ▪ (x5) Ornit rivets, 1/4"
	ATD003113	<p>ASY Visibility Tab Kit</p> <p><i>Add-on option to improve driver awareness by allowing the driver to determine the deployment state of the TrailerTail when looking in the side-view mirror.</i></p> <p><i>Attaches to:</i></p> <ul style="list-style-type: none"> ▪ Roadside Lateral Panel <p><i>Includes:</i></p> <ul style="list-style-type: none"> ▪ (x3) Ornit rivets, 1/4" ▪ (x1) Install manual

Decals

Image	Part Number	Description
	ATD002384	<p>Decal, TT Equipped, Close Before Reversing, 6 in x 1.3 in</p> <p>Supplemental decal indicating a TrailerTail® is installed on trailer. Warns to close TrailerTail® before driving in reverse to avoid damage. Does not come included with TrailerTail®.</p>
	ATD002326	<p>Decal, TrailerTail By Stemco, Blue on White, 10 in x 2.25 in</p> <p>Default decal with TrailerTail® By Stemco logo. Comes included on lateral panel replacements when white panels are ordered. Replace if damaged or missing.</p>
	ATD002711	<p>Decal, TrailerTail By Stemco, White on Black, 10 in x 2.25 in</p> <p>Black decal with TrailerTail® By Stemco logo. Comes included on lateral panel replacements when black panels are ordered. Replace if damaged or missing.</p>
	ATD000743	<p>Decal, AutoDeploy Instruction Diagram, 9 in x 6 in</p> <p>Default decal for driver notification of AutoDeploy usage. Comes included in install kits for all AutoDeploy orders. Install on front of trailer near AutoDeploy Warning Light Bracket. Replace if damaged or missing.</p>
	ATD000796	<p>Decal, TT Equipped, Rectangular, 5 in x 10 in</p> <p>Default decal for driver notification of TrailerTail®. Comes included in install kits for all OneTouch orders. Install at mid-height on front driver-side corner post. Replace if damaged or missing.</p>
	ATD000797	<p>Decal, TT Open/Close, Triangular, 12 in x 8 in</p> <p>Default decal for driver notification of TrailerTail®. Comes included in install kits for all OneTouch orders. Install on side of trailer near landing gear. Replace if damaged or missing.</p>

Image	Part Number	Description
	<p>ATD002446</p>	<p>Decal, Cable Latch LCV, 4.7 in x 1 in</p> <p>Default decal for driver notification of secondary cable latch usage. Comes included on lateral panels for all AutoDeploy orders with planned Long Combination Vehicle travel. Replace if damaged or missing.</p>
	<p>ATD002692</p>	<p>Decal, Cable Latch Intermodal, 9 in x 6 in</p> <p>Default decal for driver notification of secondary cable latch usage. Comes included on lateral panels for all TrailerTail® orders with planned intermodal travel.</p>
	<p>ATD000060</p>	<p>Decal, DOT Reflective Tape, Silver, 12 in x 0.75 in</p> <p>Conspicuity tape located on stiffening ribs in upper corners of TrailerTail®. Comes included with panel replacements. Replace if damaged or missing.</p>
	<p>ATD000061</p>	<p>Decal, DOT Reflective Tape, Silver, 12 in x 2 in</p> <p>Conspicuity tape located on upper corners of lateral panels. Comes included with lateral panel replacements. Replace if damaged or missing.</p>
	<p>ATD000062</p>	<p>Decal, DOT Reflective Tape, Red/Silver, 18 in x 2 in</p> <p>Conspicuity tape located on bottom of lateral panels. Comes included with lateral panel replacements. Replace if damaged or missing.</p>

AutoDeploy® & ZeroTouch® Components

Image	Part Number	Description
	<p>ATD001561</p>	<p>AutoDeploy Diagnostic Tool</p> <p>Diagnostic tool used to test system components and check for short circuits and cut wires.</p> <p>Compatible with:</p> <ul style="list-style-type: none"> ▪ AutoDeploy ▪ ZeroTouch (when combined with ATD002691)
	<p>ATD002691</p>	<p>Diagnostic Tool Adapter TCS-II</p> <p>Adapter harness enabling diagnostic testing of ZeroTouch wire harness and latches. Used with ATD001561.</p> <p>Compatible with:</p> <ul style="list-style-type: none"> ▪ ZeroTouch <p>Requires:</p> <ul style="list-style-type: none"> ▪ 12V power source
	<p>ATD000495</p>	<p>ASY AutoDeploy Latch Cable Repair Kit</p> <p>Assembly kit containing all required components to repair damaged wiring located between the latch's electrical connector and the door frame grommet. Alternatively, use ATD002699 to replace the entire wire harness.</p> <p>Compatible with:</p> <ul style="list-style-type: none"> ▪ AutoDeploy <p>Includes:</p> <ul style="list-style-type: none"> ▪ (x1) Replacement latch wire ▪ (x2) Heat shrink ▪ (x4) Sealed butt connector ▪ (x3) Wire clamps, 3/16" ▪ (x1) ATD000712 ▪ (x5) Zip ties ▪ (x1) ATD001854 ▪ (x5) Ormit rivets, 1/4"
	<p>ATD002699</p>	<p>ASY AutoDeploy Wire Harness Replacement Kit</p> <p>Assembly kit containing all required components to replace a damaged wire harness. If wiring between rubber grommet and latch is damaged, use ATD000495 instead.</p> <p>Compatible with:</p> <ul style="list-style-type: none"> ▪ AutoDeploy <p>Includes:</p> <ul style="list-style-type: none"> ▪ (x1) Main wire harness, ▪ (x2) Heat shrink ▪ (x2) Ring terminals, #18-22 ▪ (x4) Wire clamps, 3/16" ▪ (x1) Butt connector, #18-22 ▪ (x6) Ormit rivets, 1/4" ▪ (x2) ATD000712 ▪ (x7) Zip ties ▪ (x2) ATD001854 ▪ (x1) Dielectric grease, 1 oz

Image	Part Number	Description
	ATD003268	<p>ASY AutoDeploy Latch Replacement Kit, LP, RDS</p> <p>Assembly kit containing all the required components to quickly replace a roadside electronic latch. Only use for latches with white plastic JST connector.</p> <p>Compatible with:</p> <ul style="list-style-type: none"> AutoDeploy with Low-Profile Latch <p>Includes:</p> <ul style="list-style-type: none"> (x1) Roadside electronic latch (x1) Heat shrink (x1) Wire clamp, 3/16" (x5) Ornit rivets, 1/4"
	ATD003267	<p>ASY AutoDeploy Latch Replacement Kit, LP, CBS</p> <p>Assembly kit containing all the required components to quickly replace a curbside electronic latch. Only use for latches with white plastic JST connector.</p> <p>Compatible with:</p> <ul style="list-style-type: none"> AutoDeploy with Low-Profile Latch <p>Includes:</p> <ul style="list-style-type: none"> (x1) Curbside electronic latch (x1) Heat shrink (x1) Wire clamp, 3/16" (x5) Ornit rivets, 1/4"
	ATD002959	<p>ASY ZeroTouch Latch Replacement Kit, MW TCS-II, RDS</p> <p>Assembly kit containing all required components to replace a roadside electronic latch. Only use for latches with circular M8 connector.</p> <p>Compatible with:</p> <ul style="list-style-type: none"> ZeroTouch <p>Includes:</p> <ul style="list-style-type: none"> (x1) Roadside electronic latch (x1) Heat shrink (x1) Wire clamp, 3/16" (x5) Ornit rivets, 1/4"
	ATD002960	<p>ASY ZeroTouch Latch Replacement Kit, MW TCS-II, CBS</p> <p>Assembly kit containing all required components to replace a curbside electronic latch. Only use for latches with circular M8 connector.</p> <p>Compatible with:</p> <ul style="list-style-type: none"> ZeroTouch <p>Includes:</p> <ul style="list-style-type: none"> (x1) Curbside electronic latch (x1) Heat shrink (x1) Wire clamp, 3/16" (x5) Ornit rivets, 1/4"

Image	Part Number	Description
	ATD003272	<p>ASY AutoDeploy LP Latch Upgrade Kit, RDS</p> <p>Assembly kit containing all the required components to replace a high-profile roadside electronic latch with a low-profile roadside electronic latch.</p> <p>Compatible with:</p> <ul style="list-style-type: none"> AutoDeploy with High-Profile Latch <p>Includes:</p> <ul style="list-style-type: none"> (x1) Roadside electronic latch (x11) Wire clamp, 3/16" (x4) Bulb-Tite rivets, 1/4" (x1) Lateral Panel conversion template (x1) Bottom Panel conversion template (x1) Dual Flange Striker Bolt Bracket, 1.3 in (x1) Dual Flange Striker Bolt Bracket, 2.4 in (x1) Heat shrink (x27) Ornit rivets, 1/4"
	ATD003271	<p>ASY AutoDeploy LP Latch Upgrade Kit, CBS</p> <p>Assembly kit containing all the required components to replace a high-profile curbside electronic latch with a low-profile curbside electronic latch.</p> <p>Compatible with:</p> <ul style="list-style-type: none"> AutoDeploy with High-Profile Latch <p>Includes:</p> <ul style="list-style-type: none"> (x1) Curbside electronic latch (x11) Wire clamp, 3/16" (x4) Bulb-Tite rivets, 1/4" (x1) Lateral Panel conversion template (x1) Bottom Panel conversion template (x1) Dual Flange Striker Bolt Bracket, 1.3 in (x1) Dual Flange Striker Bolt Bracket, 2.4 in (x1) Heat shrink (x27) Ornit rivets, 1/4"

Image	Part Number	Description
	<p>ATD002534 <i>(Discontinued)</i></p>	<p>ASY AutoDeploy Latch Replacement Kit, RDS</p>
	<p>ATD002700 <i>(Discontinued)</i></p>	<p>ASY AutoDeploy Latch Replacement Kit, CBS</p>

Image	Part Number	Description
	<p>ATD002411</p>	<p>ASY VSC+</p> <p>Radar based control unit with curled bracket.</p> <p>Compatible with:</p> <ul style="list-style-type: none"> AutoDeploy <p>Attaches to:</p> <ul style="list-style-type: none"> Trailer floor I-beam <p>Attaches with:</p> <ul style="list-style-type: none"> (x2) Bolts, 1/4" (x2) Nuts, 1/4" (x4) Washers, 1/4"
	<p>ATD002413</p>	<p>ASY VSC+, OEM</p> <p>Radar based control unit with 90° bent bracket.</p> <p>Compatible with:</p> <ul style="list-style-type: none"> AutoDeploy <p>Attaches to:</p> <ul style="list-style-type: none"> Trailer floor I-beam <p>Attaches with:</p> <ul style="list-style-type: none"> (x2) Bolts, 1/4" (x2) Nuts, 1/4" (x4) Washers, 1/4"
	<p>ATD000719</p>	<p>ASY Warning Light</p> <p>Light assembly that alerts the driver of the deployment state of the TrailerTail®.</p> <p>Compatible with:</p> <ul style="list-style-type: none"> AutoDeploy <p>Attaches to:</p> <ul style="list-style-type: none"> Front roadside corner of trailer <p>Attaches with:</p> <ul style="list-style-type: none"> (x2) Ring terminals, #18-22 (x1) Butt connector, #18-22 (x4) Wire clamps, 3/16" (x4) Ornit rivets, 1/4"
	<p>ATD000726</p>	<p>4 LED Amber Light</p> <p>Replacement snap-in LED light for ATD000719.</p> <p>Manufacturer: Optronics MCL-63CAB.</p> <p>Compatible with:</p> <ul style="list-style-type: none"> Vintage AutoDeploy

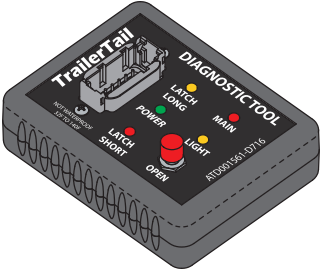
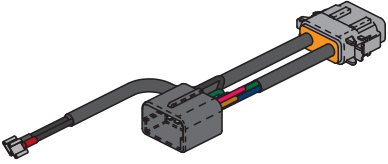
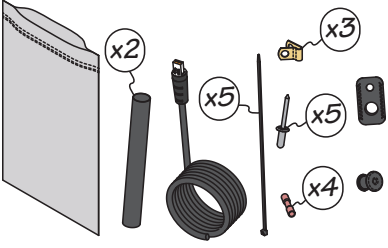
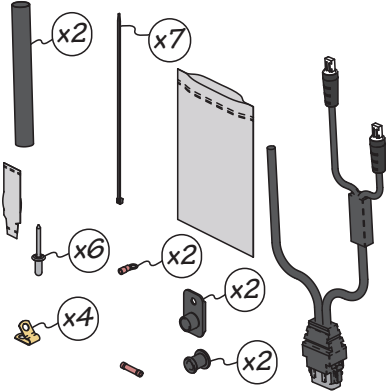
Image	Part Number	Description
	<p>ATD000712</p>	<p>Door Frame Grommet, 5 mm Wire Diameter</p> <p>Rubber grommet used to protect and immobilize wiring through the metal door frame.</p> <p>Compatible with:</p> <ul style="list-style-type: none"> ▪ AutoDeploy ▪ ZeroTouch
		<p>ATD001854</p>
	<p>ATD002974</p>	<p>ASY KIT Wire Clamp, 0.1875 in (x11)</p> <p>Wire clamps used to secure wiring to TrailerTail® panels and front face of trailer.</p> <p>Includes:</p> <p>(x11) Wire clamps, ⅜"</p>
		<p>ATD001615</p>

TrailerTail® 4x4 Parts Diagram

Assembly Overview

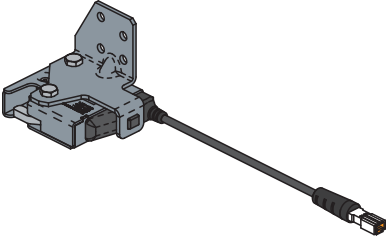
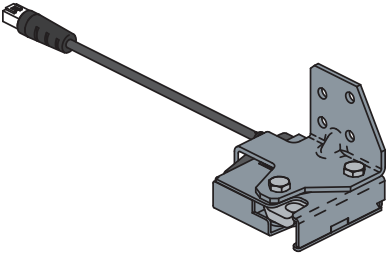

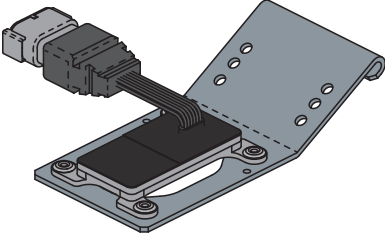
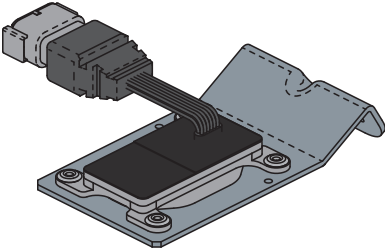
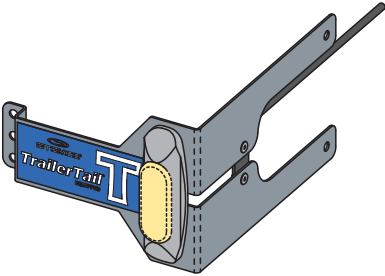
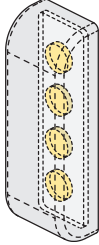
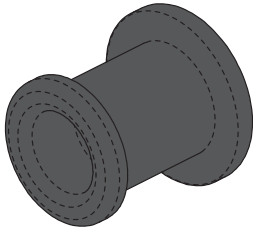
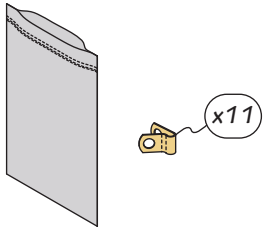
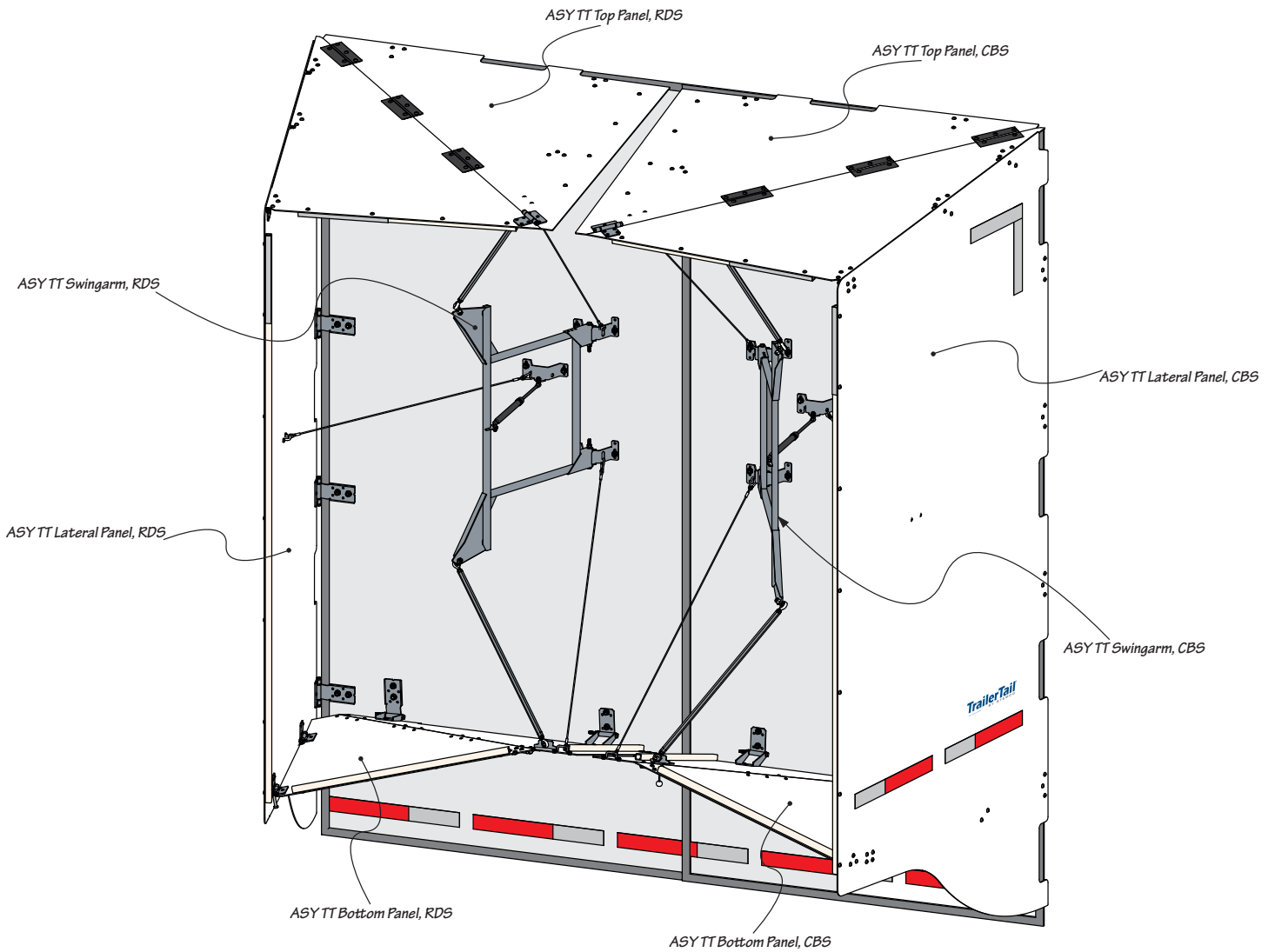
The following assemblies and materials shown are representative of the latest product available from STEMCO. Your product may be different or contain different materials.

TrailerTail 4x4 Lateral Panel Assembly

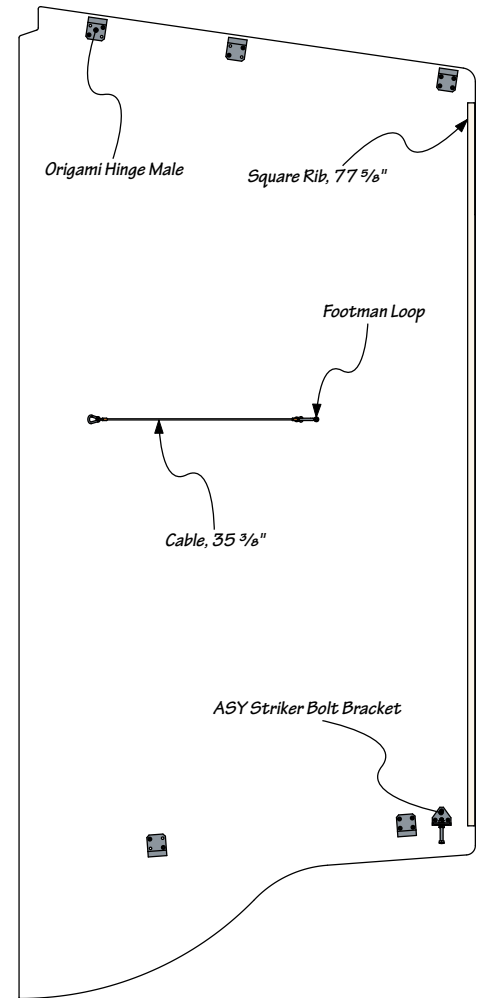
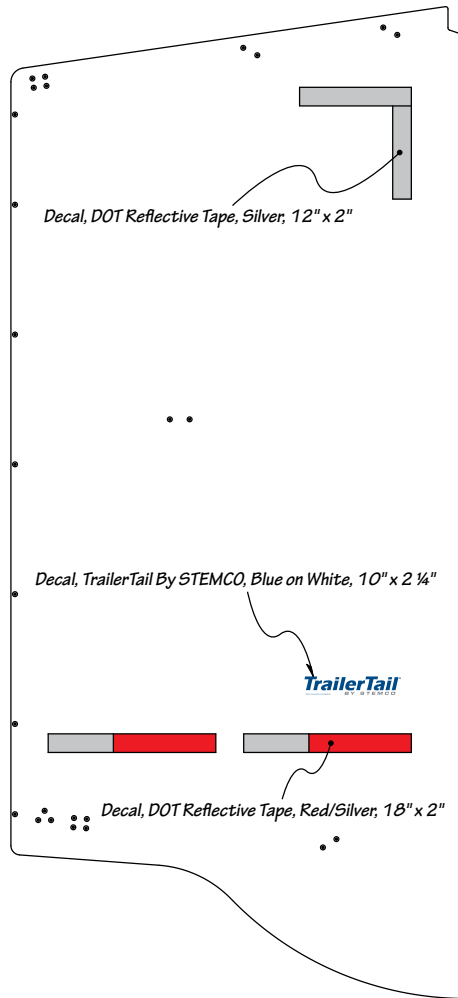
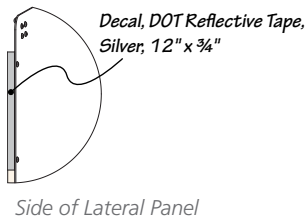

Part Number	Description	Quantity	Page Number [†]
ATD000060	Decal, DOT Reflective Tape, Silver, 12 in x 0.75 in	1	53
ATD000061	Decal, DOT Reflective Tape, Silver, 12 in x 2 in	2	53
ATD002326	Decal, TrailerTail By Stemco, Blue on White, 10 in x 2.25 in	1	52
ATD002711	Decal, TrailerTail By Stemco, White on Black, 10 in x 2.25 in	(1)*	52
ATD000062	Decal, DOT Reflective Tape, Red/Silver, 18 in x 2 in	2	53
N/A	Origami Hinge Male	5	N/A
ATD000014	Square Rib, 77.625 in	1	50
N/A	Footman Loop	1	N/A
ATD000016	Cable, 35.375 in	1	43
N/A	ASY Striker Bolt Bracket	1	N/A

[†]For parts with page numbers or part numbers not listed, contact Stemco TrailerTail® customer support.

*Decals with a black background are included with black panels.

TrailerTail 4x4 Top Panel Assembly

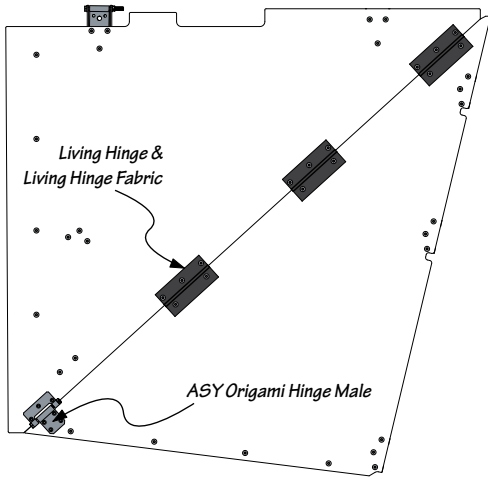

Front of Top Panels (UV side)

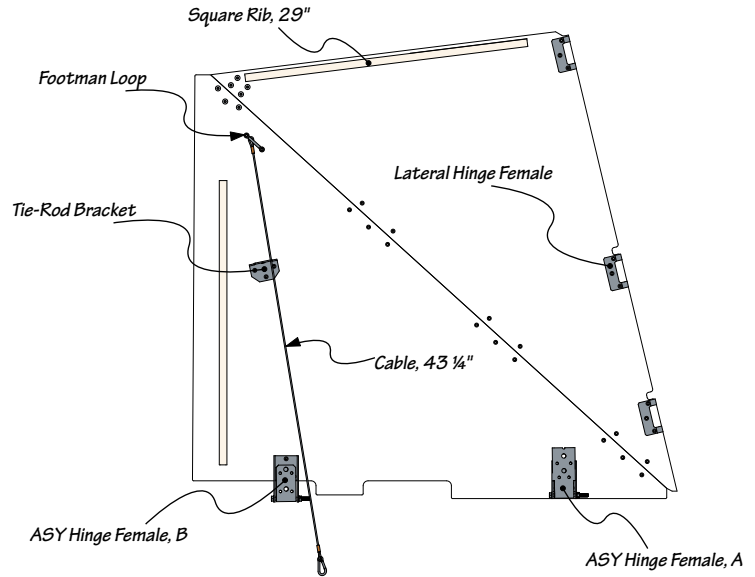

Back of Top Panels (non-UV side)

Dry van configuration

Part Number	Description	Quantity	Page Number [†]
ATD000017	Living Hinge	3	51
ATD000021	Living Hinge Fabric	3	51
ATD000152	ASY Origami Hinge Male	1	40
ATD000013	Square Rib, 29 in	2	50
N/A	Footman Loop	1	N/A
ATD000004	Lateral Hinge Female	3	38
N/A	Tie-Rod Bracket	1	N/A
ATD000015	Cable, 43.25 in	1	43
N/A	ASY Hinge Female, A	1	N/A
N/A	ASY Hinge Female, B	1	N/A
ATD000002	Hinge Female A	(1)*	38
ATD000003	Hinge Female B	(1)*	38

[†]For parts with page numbers or part numbers not listed, contact Stemco TrailerTail® customer support.

*Included with refrigerated configuration.

TrailerTail 4x4 Bottom Panel Assembly

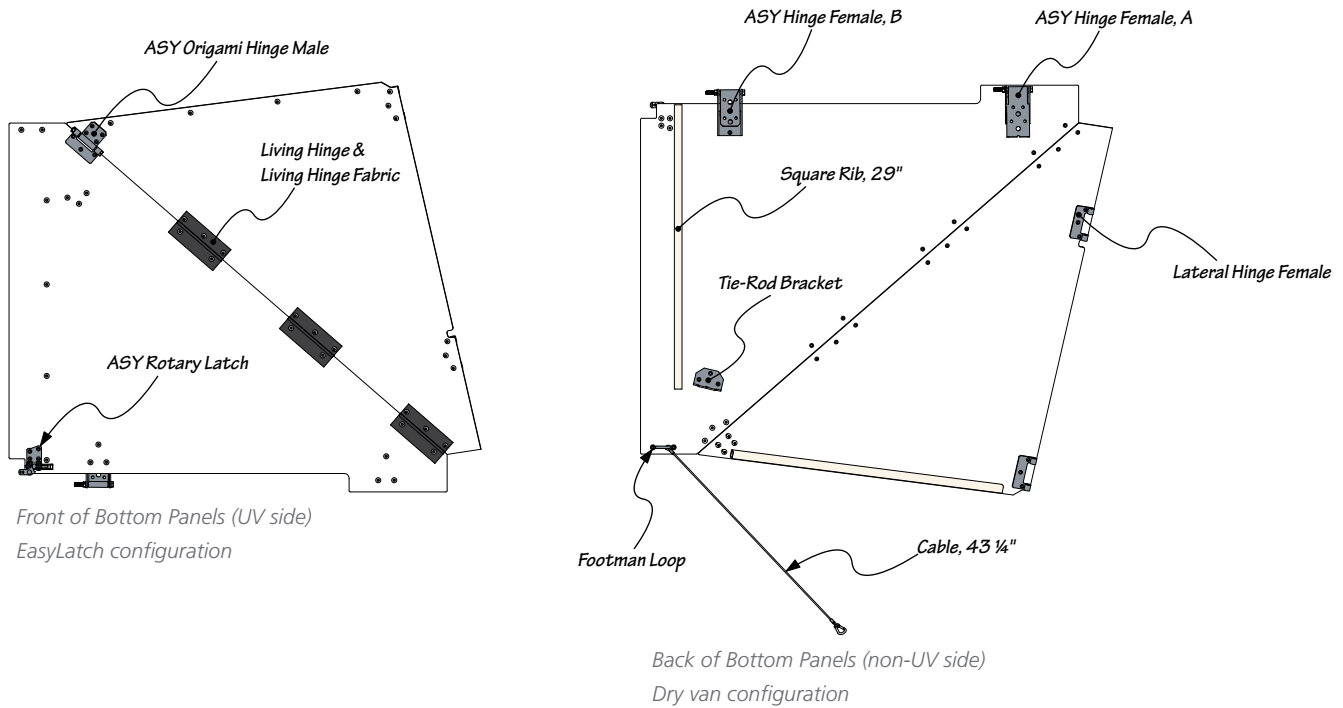

Part Number	Description	Quantity	Page Number [†]
ATD000017	Living Hinge	3	51
ATD000021	Living Hinge Fabric	3	51
ATD000152	ASY Origami Hinge Male	1	40
ATD000013	Square Rib, 29 in	2	50
N/A	Footman Loop	1	N/A
ATD000004	Lateral Hinge Female	2	38
N/A	Tie-Rod Bracket	1	N/A
ATD000015	Cable, 43.25 in	1	43
N/A	ASY Hinge Female, A	1	N/A
N/A	ASY Hinge Female, B	1	N/A
ATD000002	Hinge Female A	(1)*	38
ATD000003	Hinge Female B	(1)*	38
ATD000019	ASY Rotary Latch, RDS	1**	44
ATD000020	ASY Rotary Latch, CBS	1**	44

[†]For parts with page numbers not listed, contact Stemco TrailerTail® customer support.

*Included with refrigerated configuration.

**RDS included on roadside assembly; CBS included on curbside assembly.

TrailerTail® Trident Parts Diagram

Assembly Overview

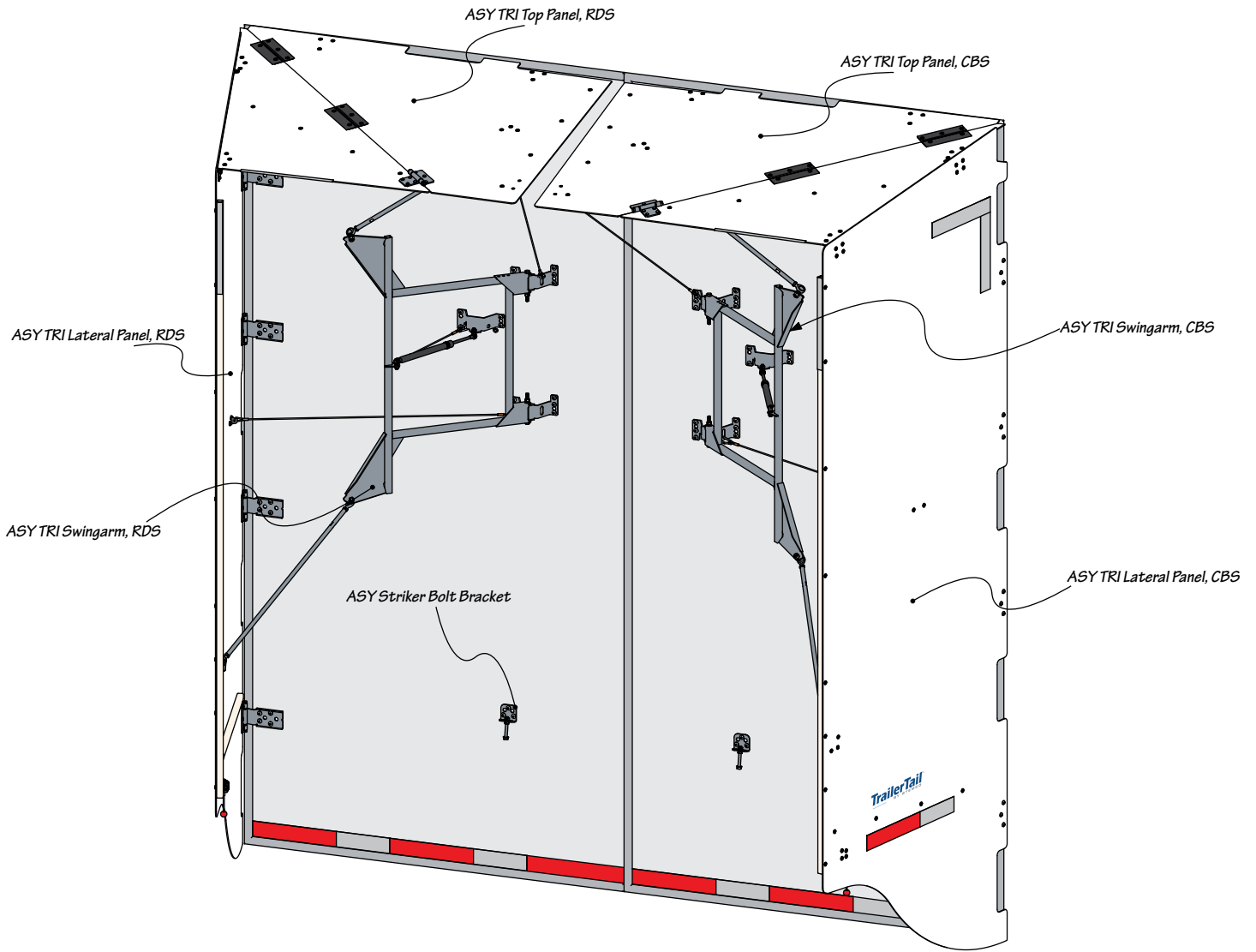

The following assemblies and materials shown are representative of the latest product available from STEMCO. Your product may be different or contain different materials.

TrailerTail Trident Lateral Panel Assembly

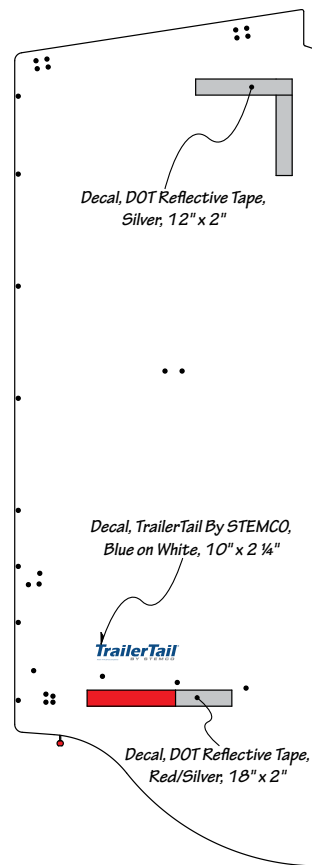
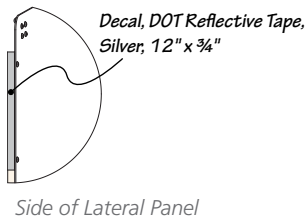

Front of Lateral Panel (UV side)

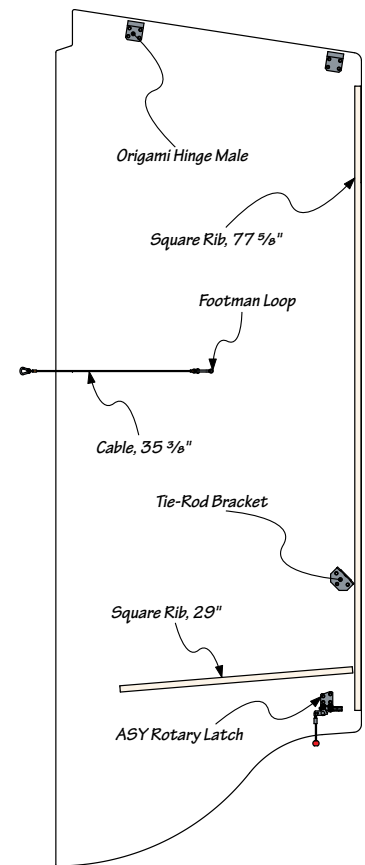

Back of Lateral Panel (non-UV side)
EasyLatch configuration

Part Number	Description	Quantity	Page Number†
ATD000060	Decal, DOT Reflective Tape, Silver, 12 in x 0.75 in	1	53
ATD000061	Decal, DOT Reflective Tape, Silver, 12 in x 2 in	2	53
ATD002326	Decal, TrailerTail By Stemco, Blue on White, 10 in x 2.25 in	1	52
ATD002711	Decal, TrailerTail By Stemco, White on Black, 10 in x 2.25 in	(1)*	52
ATD000062	Decal, DOT Reflective Tape, Red/Silver, 18 in x 2 in	1	53
N/A	Origami Hinge Male	2	N/A
ATD000014	Square Rib, 77.625 in	1	50
N/A	Footman Loop	1	N/A
ATD000016	Cable, 35.375 in	1	43
N/A	Tie-Rod Bracket	1	N/A
ATD000013	Square Rib, 29 in	1	50
ATD000019	ASY Rotary Latch, RDS	1**	44
ATD000020	ASY Rotary Latch, CBS	1**	44

†For parts with page numbers not listed, contact Stemco TrailerTail® customer support.

*Decals with a black background are included with black panels.

**RDS included on roadside assembly; CBS included on curbside assembly.

TrailerTail Trident Top Panel Assembly

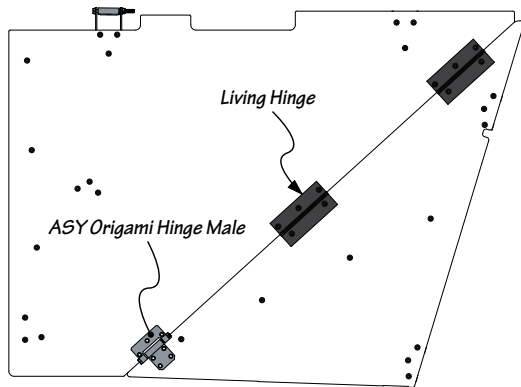

Front of Top Panels (UV side)

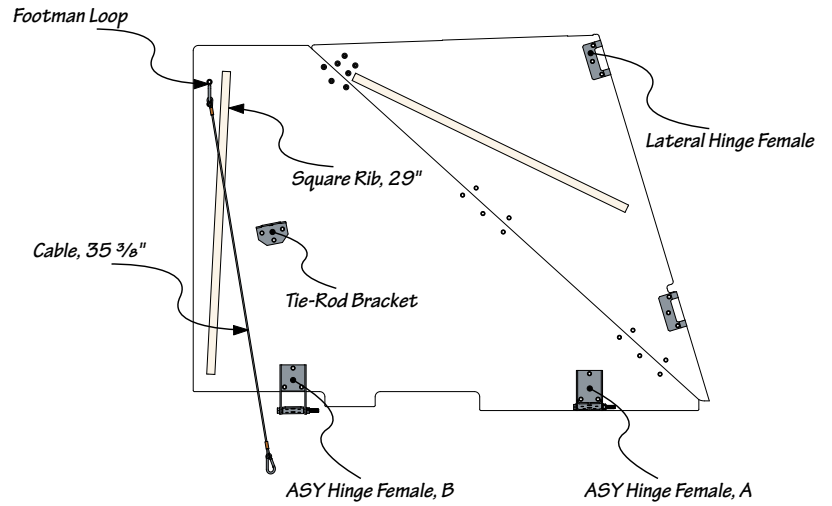

Back of Top Panels (non-UV side)

Dry van configuration

Part Number	Description	Quantity	Page Number [†]
ATD000017	Living Hinge	2	51
ATD000021	Living Hinge Fabric	2	51
ATD000152	ASY Origami Hinge Male	1	40
ATD000013	Square Rib, 29 in	2	50
N/A	Footman Loop	1	N/A
ATD000004	Lateral Hinge Female	2	38
N/A	Tie-Rod Bracket	1	N/A
ATD000016	Cable, 35.375 in	1	43
N/A	ASY Hinge Female, A	1	N/A
N/A	ASY Hinge Female, B	1	N/A
ATD000002	Hinge Female A	(1)*	38
ATD000003	Hinge Female B	(1)*	38

[†]For parts with page numbers not listed, contact Stemco TrailerTail® customer support.

*Included with refrigerated configuration.

Onsite Panel Modifications

Example Cutouts:

Panels ordered from this catalog are standardized to best fit most applications. For all lateral panels, hinge cutouts will need to be made. In some cases, you may need to make additional cutouts to panels to accommodate various trailer features. Such features may include additional lock rods, hazard placards, vent doors, locking hasps, grab handles, etc. Over the next few pages, you will find guidelines to making specific cuts.

TrailerTail® Lateral Panel Hinge Cutouts

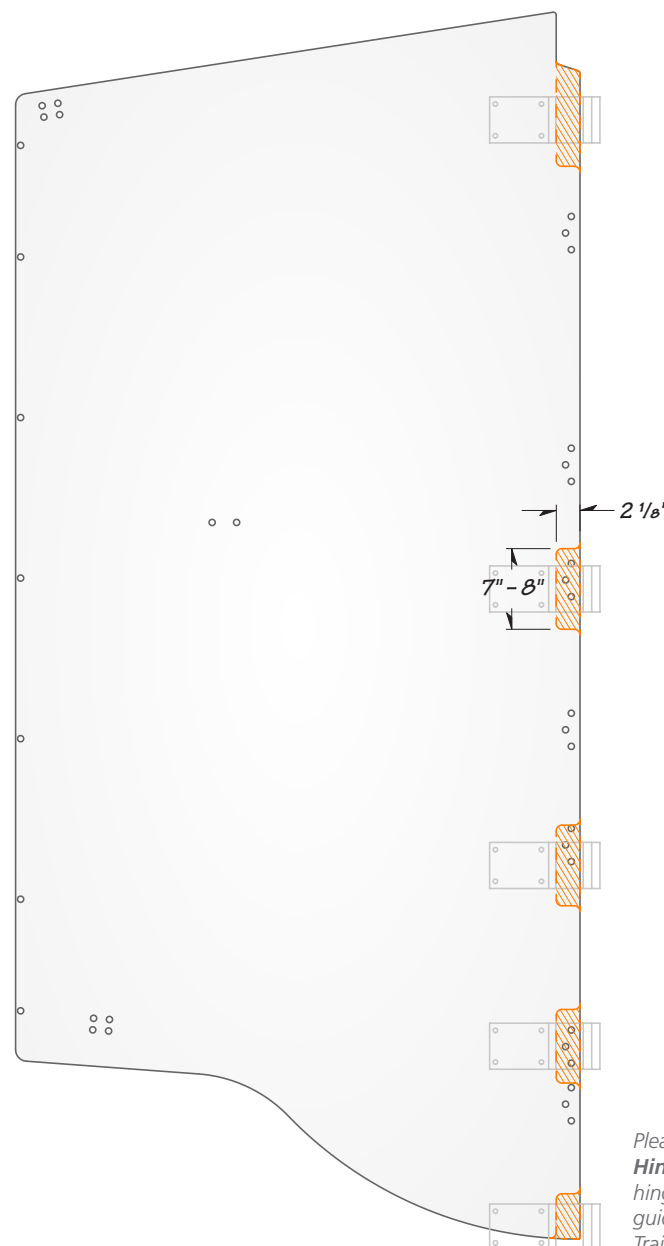

Please refer to **[ATD001095] Install Manual - Hinge Cutout Template** for details on making hinge cutouts on your lateral panels. The same guidelines apply for both TrailerTail® 4x4 and TrailerTail® Trident.

**TrailerTail® 4x4 Lateral Panel
Double Lock Rod / Hazard Placard Cutout**

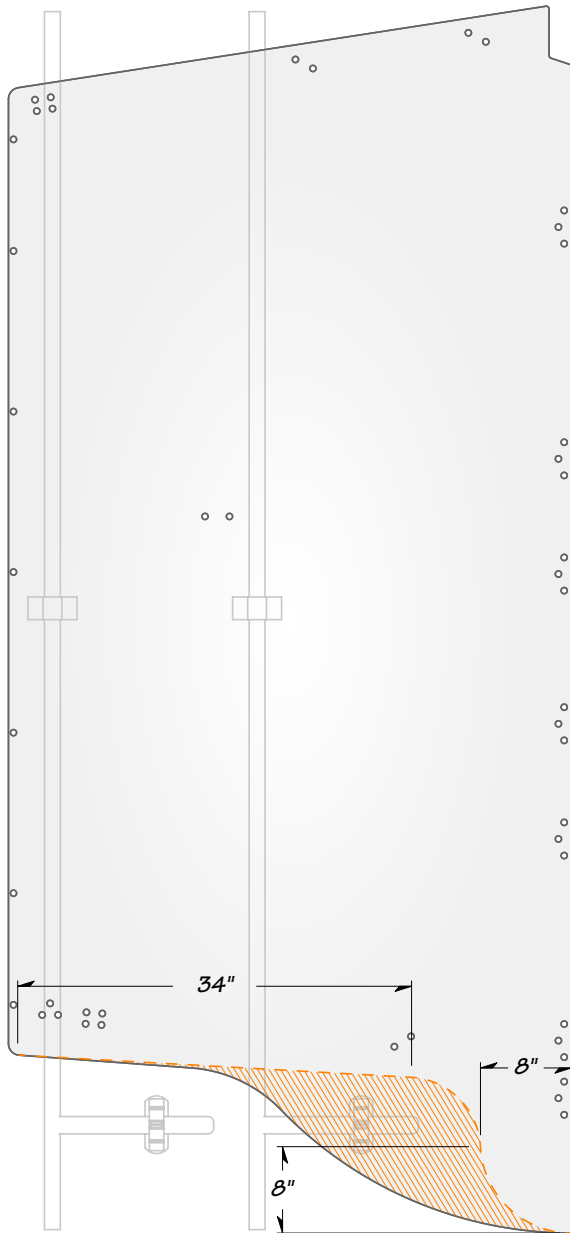

Example of double lock rods.
Cutout for double lock rods is optional. You may choose to leave panel material covering lock rod handles to encourage driver opening of TrailerTail®.

**TrailerTail® Trident Lateral Panel
Double Lock Rod / Hazard Placard Cutout**

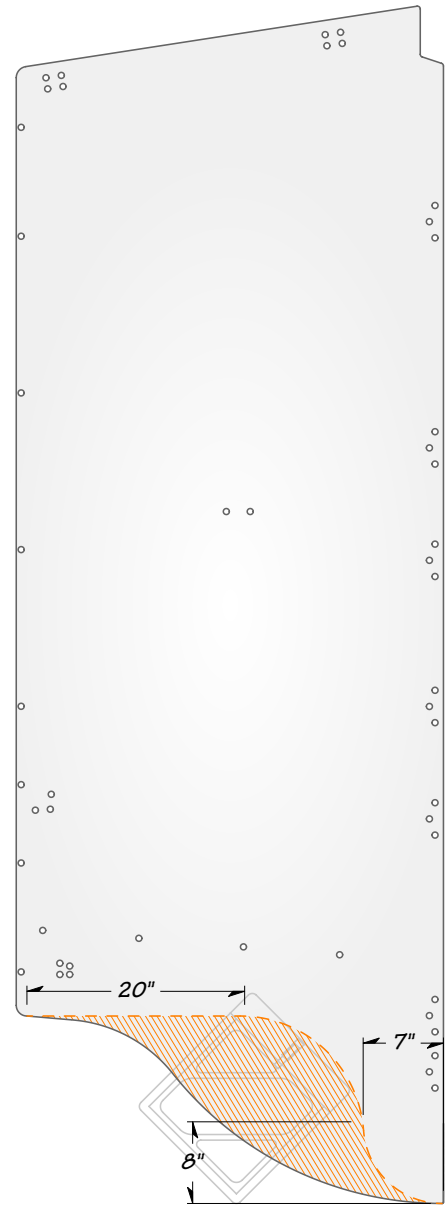

Example of a hazard placard.

**TrailerTail® Lateral Panel
Grab Handle Cutouts**

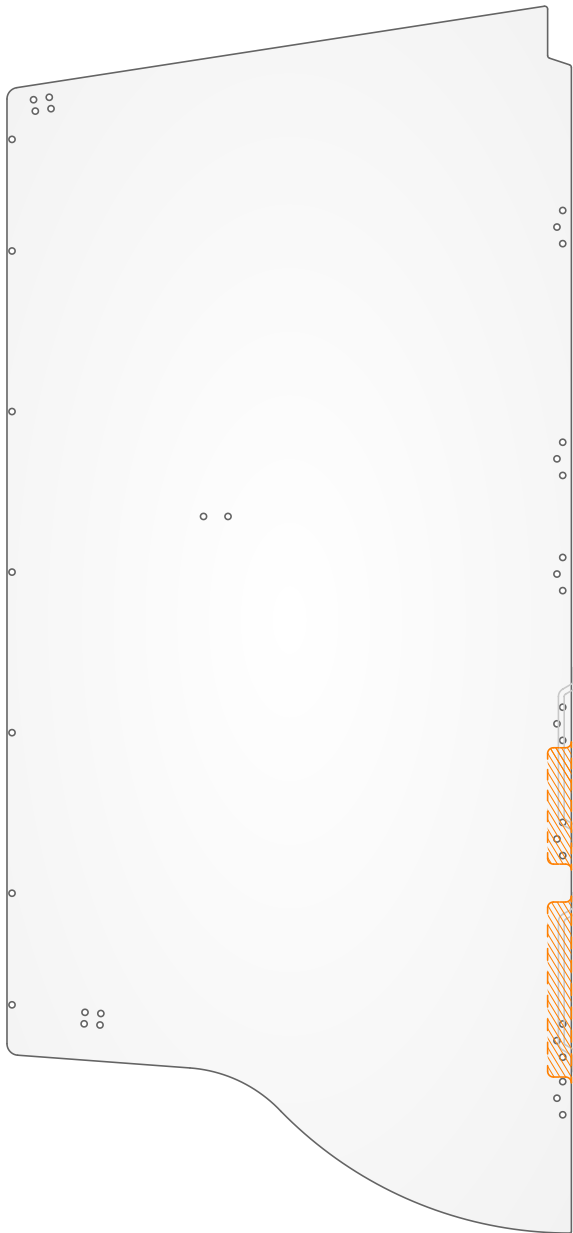

Example of grab handle cutouts. It is acceptable to extend the grab handle cutouts to combine them with the hinge cutouts. Do not cut material where a Lateral Hinge is present.

**TrailerTail® 4x4 Bottom Panel
Vent Door Cutout**

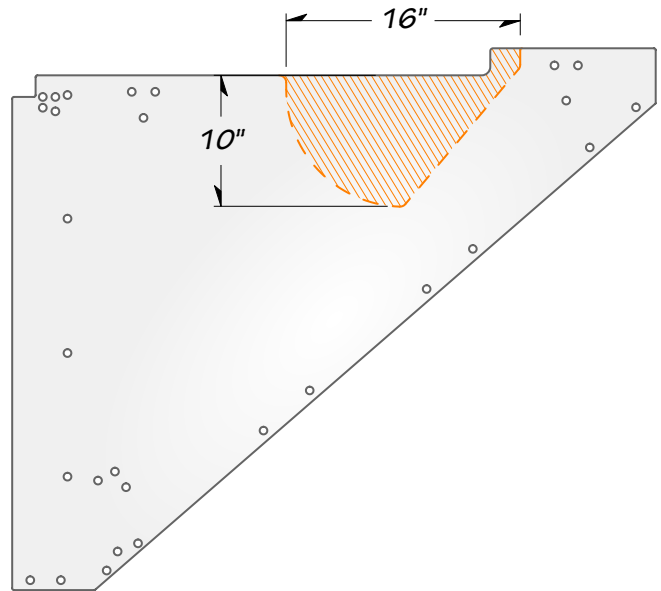

Example of a vent door cutout on the bottom panel. The dimensions of the cutout may vary depending on the size of your vent door.

**TrailerTail® Top Panel
Medial Trim**

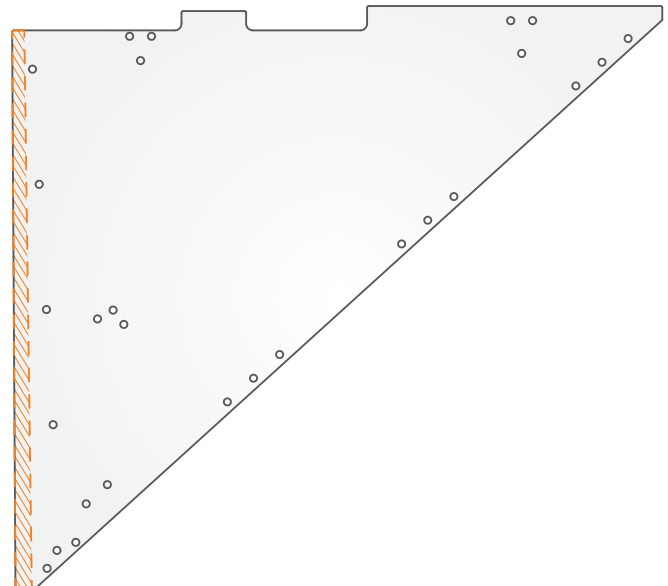

Example of a top panel medial trim. In the case of narrower trailers, your top panels may interfere when closing the TrailerTail®. Use the guidelines to trim your top panels accordingly.

Part Numbers

ATD000002	38, 39	ATD000576	48	ATD001135	38, 39
ATD000003	38, 40	ATD000648	34	ATD001136	38, 39
ATD000004	38, 39	ATD000649	34	ATD001137	38, 40
ATD000013	50	ATD000650	28	ATD001138	40, 43, 44, 45, 46, 47
ATD000014	50	ATD000650D	29	ATD001139	41, 43, 44, 50
ATD000015	43	ATD000651	28	ATD001140	42
ATD000016	43	ATD000651D	29	ATD001141	40, 46
ATD000017	51	ATD000658	16	ATD001142	40, 47
ATD000019	44	ATD000659	16	ATD001260D2	24
ATD000020	44	ATD000663	23	ATD001261D2	24
ATD000021	51	ATD000664	23	ATD001295	08
ATD000045	23	ATD000685	16	ATD001296	08
ATD000045D2	24	ATD000685A	17	ATD001318	34
ATD000046	16	ATD000686	23	ATD001319	34
ATD000046A	17	ATD000686D2	24	ATD001364	28
ATD000049	16	ATD000712	54, 59	ATD001364D	29
ATD000049A	17	ATD000719	58	ATD001365	28
ATD000050	23	ATD000723	47	ATD001365D	29
ATD000050D2	24	ATD000726	58	ATD001372	28
ATD000060	53	ATD000743	52	ATD001372D	29
ATD000061	53	ATD000753	43	ATD001373	28
ATD000062	53	ATD000764	08	ATD001373D	29
ATD000071	41, 50	ATD000764A0	08	ATD001414	19
ATD000121	49	ATD000765	08	ATD001414A	20
ATD000129	49	ATD000765A0	08	ATD001415	19
ATD000137	19	ATD000796	52	ATD001415A	20
ATD000137D2	20	ATD000797	52	ATD001423	51
ATD000138	19	ATD000825	09	ATD001468	21
ATD000138D2	20	ATD000826	09	ATD001469	21
ATD000147	38	ATD000830	21	ATD001527	41, 43, 44, 45
ATD000148	09	ATD000831	21	ATD001529	43
ATD000148B	09	ATD000832	25	ATD001561	54
ATD000149	09	ATD000833	25	ATD001577	41, 44, 50
ATD000149B	09	ATD000947	09	ATD001578	41, 44, 50
ATD000152	40	ATD000948	09	ATD001602	36
ATD000154	40, 44	ATD000960	49	ATD001615	59
ATD000155	40, 44, 45	ATD001060	40, 46	ATD001622	40, 47
ATD000164	14	ATD001061	40, 46	ATD001623	40, 47
ATD000164C	15	ATD001084	36	ATD001690	11
ATD000165	14	ATD001085	36	ATD001690B	11
ATD000165C	15	ATD001095	67	ATD001691	11
ATD000333	48	ATD001109	23	ATD001691B	11
ATD000425	41, 50	ATD001109D2	24	ATD001854	54, 59
ATD000495	54	ATD001115	44	ATD001856	49
ATD000553	48	ATD001134	38, 39		

ATD001859	49	ATD002805	08	ATD003272	56
ATD001890	35	ATD002805B	08	ATD003813	48
ATD001891	35	ATD002809	10	ATD003928	12
ATD001912	07	ATD002810	10	ATD003929	12
ATD001913	07	ATD002814	10	ATD004092	32
ATD001959	19	ATD002815	10	ATD004093	32
ATD001959B	20	ATD002819	10		
ATD001960	19	ATD002820	10		
ATD001960B	20	ATD002824	10		
ATD002001	08	ATD002825	10		
ATD002002	08	ATD002829	11		
ATD002015	25	ATD002829B	11		
ATD002065	09	ATD002830	11		
ATD002066	09	ATD002830B	11		
ATD002089	28	ATD002844	06		
ATD002090	28	ATD002845	06		
ATD002143	30	ATD002849	07		
ATD002144	30	ATD002850	07		
ATD002148	37	ATD002854	07		
ATD002149	37	ATD002855	07		
ATD002151	42	ATD002859	07		
ATD002186	35	ATD002860	07		
ATD002187	35	ATD002911	21		
ATD002255	19	ATD002912	21		
ATD002255B	20	ATD002914	25		
ATD002256	19	ATD002920	21		
ATD002256B	20	ATD002921	23		
ATD002326	52	ATD002921B	24		
ATD002331	30, 37	ATD002922	23		
ATD002366	19	ATD002922B	24		
ATD002384	52	ATD002926	25		
ATD002411	58	ATD002927	25		
ATD002413	58	ATD002931	09		
ATD002446	53	ATD002932	09		
ATD002486	50	ATD002938	28		
ATD002532	41, 44, 45	ATD002939	28		
ATD002533	41, 44, 45	ATD002959	55		
ATD002534	57	ATD002960	55		
ATD002691	54	ATD002974	59		
ATD002692	53	ATD003113	51		
ATD002699	54	ATD003121	49		
ATD002700	57	ATD003173	43		
ATD002711	52	ATD003210	42		
ATD002729	51	ATD003211	42		
ATD002772	43	ATD003267	55		
ATD002804	08	ATD003268	55		
ATD002804B	08	ATD003271	56		

WHEN IT COMES TO WHEEL ENDS, WE HAVE YOU COVERED

STEMCO has provided the trucking industry with reliable hub seals for more than 40 years. Throughout our history, we have recognized the need for tougher, longer life seals that meet the performance, design and price requirements related to selecting the right seal for any fleet. To meet that need, STEMCO has engineered a menu of sealing options designed to meet the varying performance expectations of each fleet, all in an effort to maximize performance and value.

Selecting the right STEMCO seal for the right application.

Discover® is designed for the long haul carrier seeking high performance components. The Discover seal is an excellent choice for fleets running outboard-mounted drums that allow brake changes without seal replacement. The long life characteristics of this seal, proven in testing that exceeds competitive products' performance by five times, make it the industry choice for performance driven fleet managers.

The Voyager® seal is designed for regional route trucks, city delivery and coach applications. Rugged design, simple installation and proven performance make Voyager the right choice for fleets looking for a superior brake job-to-brake job seal. In the everyday stop-and-go traffic environment these vehicles experience, the Voyager seal is the best value.

The Guardian® HP is the standard seal for trailer and axle original equipment manufacturers. The axle installation is durable and unique, and has proven successful for more than 40 years. Today, its enhanced features offer improved cost-per-mile performance. With simple one-step axle installation, Guardian HP is the seal of choice in the trailer industry.

Grit Guard® is always rough and ready and has endured more than forty years of dirty, unfriendly road environments that destroy wheel end components. So with this sixty year plus track record of performance, Grit Guard endures where others fail, and is still the choice for fleets working in grueling environments.



VMRS Codes

Product	Description	ATA/VMRS Code*	STEMCO Part No. Series
Axle Rings	Drive	18-002-014 (STMCO)	310-1000 Series
	Dead	18-001-015 (STMCO)	
Bearing Spacers		18-001-013 (STMCO)	357-5700 Series
Gaskets		18-003-017 (STMCO)	330-3000 Series
Grit Guard® Deflector Rings	Drive	18-002-014 (STMCO)	315-1500 Series
	Dead	18-001-015 (STMCO)	
Hub Caps		18-003-003 (STMCO)	300-, 303-, 340-, 342-, 343-, 348-, 349-, 350-, 352-, 353-, 356-, & 358-0000 Series
Hubodometers		51-002-002 (STMCO)	650-0000 Series
Hubodometer Brackets		51-002-002 (STMCO)	610-0000 Series
Hubodometer Hub Caps		51-002-004 (STMCO)	640-0000 Series
Locating Rings		18-001-013 (STMCO)	356-5600 Series
Misc. Components <i>(including Hub Cap Parts)</i>		None	359-5900 Series
O-Rings		18-003-015 (STMCO)	355-5500 Series
Oil Seals <i>(Standard)</i>	Drive	18-002-005 (STMCO)	320-2000 Series
	Dead	18-001-004 (STMCO)	
Oil Seal Sets:	Drive Axle	18-002-028 (STMCO)	392-9000 Series 309-0900, 391-, 393-0000 Series
	Front Axle	18-001-026 (STMCO)	382-8000 Series 308-0800 & 383-0000 Series
	Trailer, Tag or Pusher Axle	18-004-001 (STMCO)	372-7000 Series 307-0700 & 373-0000 Series
Pro-Torq®	Drive Axle	012-001-005	449-4900 Series
	Trailer, Tag or Pusher Axle	012-002-005	447-4700 Series
Pinion Seals		24-002-017 (STMCO)	429-0000 & 460-0000 Series
Shoulder Bushings		18-001-013 (STMCO)	364-6400 Series
Tools	Fleet Hub Tools	None	551-5300 Series
	Heavy Duty Axle Tools	None	552-5200 Series
	Universal Tool Body & Accessories	None	555-0000 Series
	Universal Tool Heads	None	555-5000 Series

* American Trucking Association/Vehicle Maintenance Reporting Standards

Axle Application Graphics

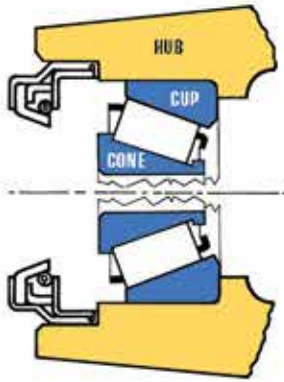

NOTICE

Some STEMCO hub seals are not designed to fit into the seal bore of the hub as the one shown at the left, but are properly sized to fit into the same bore as the bearing cup, as shown on the right. Always refer to the instructions packaged with the seal.

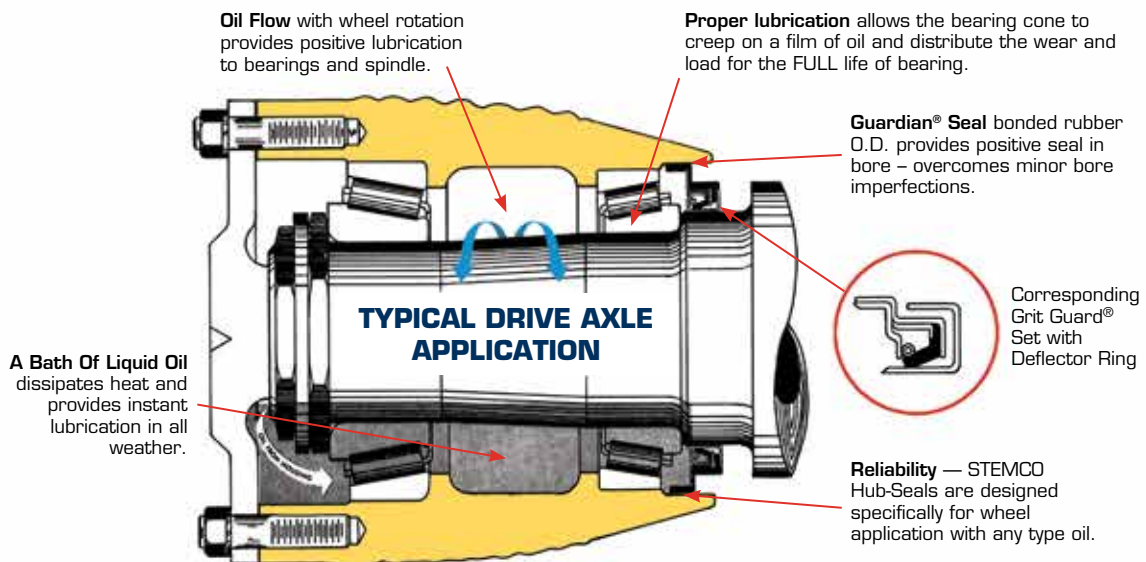
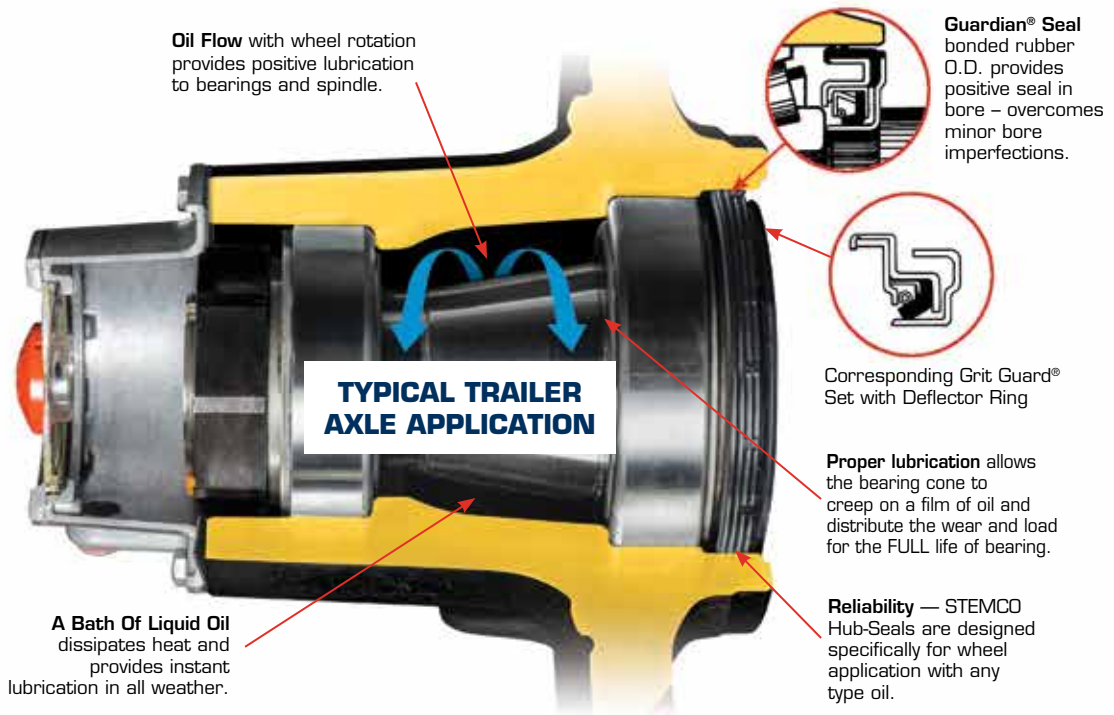
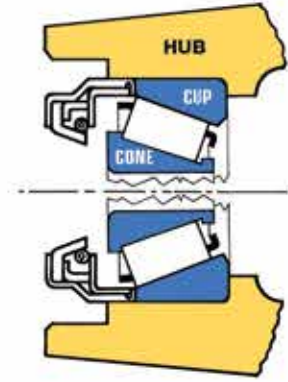

Application Chart

Application	Guardian® Guardian® HP	Grit Guard® Standard	Voyager®	Discover®
19,000# Trailer Axle Standard Forge, Dana, Meritor, Eaton	307-0713	372-7098	373-0113	373-0213
Pro-Par Trailer Axle, Fruehauf, Eaton P-22, Meritor TP, Dana	307-0723	372-7099	373-0123	373-0223
22,500# Trailer Axle, Meritor, Standard Forge, Dana, Eaton	307-0743	372-7097	373-0143	373-0243
20,000# Trailer Axle, Meritor, Shuler	307-0744	372-7095	373-0144	N/A
12,000#, 14,600# Meritor Front Transit	N/A	382-8001	383-0101	N/A
Meritor Center Point	N/A	382-8028	N/A	N/A
GMC F-120 to 1985	N/A	382-8034	N/A	N/A
12,000# Front Axle, Meritor, Eaton, Ford, Freightliner, Kenworth, Western Star, Navistar, Peterbilt, Volvo GM	308-0836	382-8036	383-0136	383-0236
12,000# Mack Front Axle	N/A	382-8039	383-0139 13	383-0239 14
Navistar Front Axle, FA 309, FA 329	308-0853	382-8053	383-0153	N/A
9,000# Front Axle, Navistar, FA 109 Cast Wheel '79 and up	308-0855	382-8056	383-0156	N/A
12,000# Front Axle, Navistar	308-0856	382-8056	383-0156	N/A
7,000#, 9,000# Front Axle, Ford	308-0863	382-8063	N/A	N/A
16,000# Front Axle, Ford, Navistar, Mack, Meritor, White, Kenworth, Western Star, Peterbilt, Volvo GM	308-0864	382-8064	383-0164	383-0264
6,000#, 7,500# Front Axle, Navistar	308-0866	382-8066	383-0166	N/A
Volvo FA 7.5 Front Axle	308-0870	N/A	N/A	N/A
GMC F-120 1985 and up	N/A	382-8071	383-0171	N/A
8,000# GMC Front-Top Kick	N/A	N/A	383-0175	N/A
11,000# GMC Front-Top Kick	N/A	N/A	383-0176	N/A
34,000# Drive Axle, Mack	309-0903	392-9094	393-0103	393-0203
44,000# Drive Axle, Mack	309-0904	392-9112 392-9130	393-0104 393-0104	393-0204 393-0204
34,000# Drive Axle, Eaton, Ford, Navistar, White	309-0912	392-9099	393-0112	393-0212
17,000# Single and 34,000# Tandem, GMC	309-0915	Refer to above 392-9099 set	393-0115	N/A
Meritor Drive-Transit	N/A	392-9034	393-0134	N/A
15,000# Drive Axle, Ford, Meritor F-Series	309-0935	392-9035	N/A	N/A
Mack Drive Axle 50,000# and 60,000#	309-0948	392-9089	393-0148	N/A
GMC H/T 150 and H/T 175 Ford, Meritor H 170, 172, 175	309-0957	392-9057	N/A	N/A
38,000# Drive Axle, Mack, GMC, Eaton, Meritor	309-0960	392-9132	N/A	N/A
34,000# Drive Axle, Meritor	309-0961	392-9095	N/A	N/A
19,000# Drive Axle, Eaton, Navistar, Ford, GMC, White	309-0964	392-9088	N/A	N/A
Van Hool Bus	391-9066	392-9066	N/A	N/A
38,000#, 40,000# and 42,000# Tandem Drive Axles, Ford, Eaton, GMC, Mack, Navistar, White	309-0965	392-9092 392-9096	N/A	N/A
38,000# Drive Axle, Eaton, Meritor, White	309-0970	392-9087	N/A	N/A
38,000#, 46,000# Tandem Axles, Eaton, Ford, Freightliner, Kenworth, Western Star, Peterbilt, Meritor, Navistar, Volvo GM	309-0973 9	392-9131	393-0173	393-0273

- Discontinued Part
- Use 555 Series Tool Heads with Universal Tool Body 555-0001. The Axle Tool Heads Install the Standard/Grit Guard® Rings and Guardian®/SS4 Seals.
- Use 551 Series Tool Heads with new Universal Tool Handle 551-0001. The Hub Tool Installs the Standard Seal, Voyager® and Discover® Seals.

- Use with 5.687" Bore Only.
- Use with 5.500" Bore Only.
- Does not fit Mack Applications.
- Fits Mack Application Only.
- Use with Wabco ABS.

Application Chart

GG/Standard Components Seal/Ring	Inner Bearing	Universal Axle Tool Heads ²	Universal Hub Tool Heads ³	Bearing Guide
2109/1507	663	555-5100	551-5313	570-0023
2023/1503	HM518445	555-5023	551-5401	570-0025
2110/1504	HM218248	555-5039	551-5412	570-0026
2118/1510	665A	555-5069	551-5339 ²⁰	570-0024
2086/1013	6386 or 6389, 6379	555-5060 or 555-5014	551-5420 ¹⁹	570-0020 ²¹
2028/1028	756A	555-5067	551-5385	N/A
2034/1034	HM212047	555-5066	551-5387	570-0019
2036/1036	39581	555-5062	551-5346	570-0017
	HM212044	555-5061	551-5346	570-0018
	HM212049, -X, X1	555-5098	551-5346	570-0020
	HM212047	555-5066	551-5346	570-0019
2039/1038	641 or HM212049	NONE REQ'D	551-5413 ¹⁰	570-0020
2181/1093	641 or HM212049	555-5060	551-5419	570-0020
	H715345	555-5070	551-5419 ¹⁵	570-0021
2199/1093	641	555-5060	551-5344	570-0020
2199/1093	H715345	555-5070	551-5344	570-0021
2133/1036 45284	39581	555-5062	551-5353	570-0017
	555-5064	551-5353	N/A	
2137/1037	6461A	555-5007	551-5327	570-0022
2164/1008	JM207049	555-5088	551-5423	570-0036
	JM205149	555-5089	551-5423 ¹⁸	570-0033
N/A	JF7049A	555-5297	N/A	N/A
2216/1034	HM212047	555-5066	551-5403	570-0019
N/A	JM205149	N/A	551-5417	570-0033
N/A	33212	N/A	551-5418	570-0031
2129/1511	580 or 582	555-5072	551-5415 ¹¹	570-0023
2213/1515 2213/1519	663 or HM516449, -C	555-5072	551-5414 ¹²	570-0023
	HM516449A	555-5073	551-5414 ¹²	570-0023
2102/1501	47685 or 47686	555-5031	551-5416 ¹⁶	570-0023
	47678 or 5760	555-5074	551-5416 ¹⁶	570-0022
---	47686	555-5031	551-5424	570-0023
2061/1066	6580 or 6559	555-5023 or 555-5072	551-5421 ¹⁷	570-0025 or 570-0023
2057/1062	33287	555-5011	551-5353	N/A
2097/1516	687 or 780	555-5004	551-5400	570-0032
2104/1018	495AX	555-5074	551-5383	N/A
	33287	555-5011	551-5383	N/A
2115/1530	598A	555-5071	551-5356	570-0027
	594A	555-5076	551-5356	570-0028
2117/1509	580, 582 or 663A	555-5072	551-5325	N/A
2113/1517	594 or 594A	555-5076	551-5412	570-0028
2115/1107	594A	555-5076	551-5356	570-0028
2131/1508	598	555-5071	551-5363	570-0027
2114/1508	595	555-5072	551-5412	570-0023
	598	555-5071	551-5412	570-0027
2162/1502	683XA or 683	555-5076	551-5333	570-0028
	681A	555-5071	551-5333	570-0027
2106/1525	594 or 594A	555-5076	551-5320	570-0028
	598 or 598A	555-5071	551-5320	570-0027

⁹ HP Design

¹⁰ Use 551-5395 for 320-2039 seal.

¹¹ Use 551-5393 for 320-2129 seal.

¹² Use 551-5364 for 320-2213 seal.

¹³ 383-8139 includes 310-1132.

¹⁴ 383-8239 includes 310-1132.

¹⁵ Use 551-5349 for 320-2181 seal.

¹⁶ Use 551-5318 for 320-2102 seal.

¹⁷ Use 551-5356 for 320-2061 seal.

¹⁸ Use 551-5366 for 320-2164 seal.

¹⁹ Use 551-5311 for 320-2086 seal.

²⁰ Use 551-5321 for 320-2118 seal.

²¹ Does not fit 6379.

Internal Hub Seal Cross Reference

Quick Reference

Guardian® / Guardian®HP Seal No.	Inner Bearing Cone	Universal Tool Head	Standard/ Grit Guard® Set	Voyager® Discover®
307-0713	663	555-5100	372-7098	373-0113 373-0213
307-0723	HM518445	555-5023	372-7099	373-0123 373-0223
307-0743	HM218248	555-5039	372-7097	373-0143 373-0243
307-0744	665A	555-5069	372-7095	373-0144
308-0836	39581	555-5062	382-8036	383-0136 383-0236
	HM212044, 557A	555-5061		
	HM212049, -X	555-5098		
	HM212047	555-5066		
308-0853	641	555-5060	382-8053	383-0153
	HM212049	555-5070		
308-0855	641	555-5060	N/A	N/A
308-0856	H715345	555-5070	382-8056	383-0156
308-0863	39581	555-5062	382-8063	N/A
	45284	555-5064		
308-0864	6461A	555-5007	382-8064	383-0164 383-0264
308-0866	JM207049	555-5088	382-8066	383-0166
	JM205149	555-5089		
308-0870	JF7049A	555-5297	N/A	N/A
309-0903	580	555-5072	392-9094	393-0103 393-0203
	582			
309-0904	663	555-5072	392-9112	393-0104 393-0204
	HM516449,-C			

Guardian® / Guardian®HP Seal No.	Inner Bearing Cone	Universal Tool Head	Standard/ Grit Guard® Set	Voyager® Discover®
309-0912	47685 47686	555-5031	392-9099	393-0112 393-0212
	47678 5760			
309-0915	47685 47686	555-5031	392-9099	N/A
309-0935	33281 Thru 61	555-5002	392-9035	N/A
	33287 62 Up	555-5011		
309-0948	687 780	555-5004	392-9089	393-0148
	495AX			
309-0957	33287	555-5074	392-9057	N/A
	594A	555-5011		
309-0960	594A	555-5076	392-9132	N/A
	598A	555-5071		
309-0961	580 582 663A	555-5072	392-9095	N/A
	594 594A			
309-0964	594 594A	555-5076	392-9088	N/A
309-0965	595	555-5072	392-9096	N/A
	598	555-5071		
309-0970	683XA 683	555-5076	392-9087	N/A
	681A			
309-0973	594 594A	555-5076	392-9131	393-0173 393-0273
	598			
	598A			

Use Universal Tool Body 555-0001 with 555 Series Tool Heads.

Guardian® & Guardian® HP Hub-Seal Components

Oil Seal	Deflector Ring	Guardian® / Guardian® HP Seal
327-2701	317-1743	307-0743
327-2702	317-1702	308-0836
327-2703	317-1703	309-0973
327-2704	317-1704	307-0713
327-2705	317-1705	307-0723
327-2706	317-1729	309-0903
327-2707	317-1707	309-0912
327-2708	317-1708	308-0853
327-2709	317-1709	307-0744
327-2710	317-1710	308-0855
	317-1706	308-0856
327-2711	317-1711	308-0864
327-2712	317-1712	309-0964

Oil Seal	Deflector Ring	Guardian® / Guardian® HP Seal
327-2713	317-1713	309-0965
327-2715	317-1756	309-0915
327-2716	317-1761	309-0970
327-2717	317-1761	309-0960
327-2718	317-1720	309-0904
327-2719	317-1719	309-0961
327-2721	317-1721	308-0863
327-2724	317-1724	309-0957
327-2727	317-1726	308-0866
327-2728	317-1728	309-0935
327-2741	317-1790	309-0948
327-2757	317-1724	308-0870

Guardian® HP

327- Series Oil Seals and **317-** Series Deflector Rings are component parts for the Guardian® Hub Seal. These parts are not sold separately.

Axle Ring to Hub Seal Set Cross Reference

Oil Seal	Axle Ring	Hub-Seal Set
310-1007	320-2096	392-9007
310-1008	320-2018	372-7046
310-1008	320-2105	382-8044
310-1008	320-2164	382-8066
310-1009	320-2181	382-8052
310-1012	320-2012	392-9012
310-1013	320-2086	382-8001
310-1013	320-2109	None
310-1017	320-2017	382-8017
310-1018	320-2029	372-7018
310-1018	320-2029	392-7018
310-1018	320-2104	392-9057
310-1022	320-2023	372-7022
310-1023	320-2023	None
310-1023	320-2173	372-7024
310-1026	320-2131	None
310-1028	320-2166	382-8069
310-1028	320-2028	382-8028
310-1028	320-2041	382-8045
310-1028	320-2009	None
310-1032	320-2032	382-8032
310-1034	320-2034	382-8034
310-1034	320-2216	382-8071
310-1036	320-2032	372-7009
310-1036	320-2046	372-7006
310-1036	320-2031	None
310-1036	320-2036	382-8036
310-1036	320-2119	382-8027
310-1036	320-2133	382-8063
310-1037	320-2118	None
310-1037	320-2137	382-8064
310-1038	320-2039	382-8039
310-1041	320-2023	382-8060
310-1043	320-2041	372-7015
310-1048	320-2110	None
310-1050	320-2022	382-8010
310-1051	320-2031	382-8011
310-1051	320-2125	382-8062
310-1052	320-2050	382-8009
310-1053	320-2109	392-9032
310-1057	320-2109	372-7003
310-1061	320-2056	382-8005

Oil Seal	Axle Ring	Hub-Seal Set
310-1062	320-2057	392-9035
310-1063	320-2057	392-9036
310-1064	320-2136	372-7049
310-1064	320-2072	392-9038
310-1066	320-2061	392-9034
310-1079	320-2009	392-9081
310-1088	320-2213	None
310-1089	320-2099	392-9053
310-1093	320-2199	382-8056
310-1093	320-2181	382-8053
310-1093	320-2058	392-9033
310-1093	320-2113	None
310-1095	320-2001	392-9001
310-1103	320-2001	392-9062
310-1104	320-2077	392-9063
310-1107	320-2119	392-9066
310-1111	320-2106	None
310-1111	320-2115	None
310-1111	320-2162	None
310-1117		See 392-9045 Remarks
310-1123		See 392-9034 Remarks
310-1130	320-2023	372-7062
310-1233	320-2233	392-9111
315-1501	320-2102	392-9099
315-1502	320-2162	392-9087
315-1503	320-2023	372-7099
315-1503	320-2173	372-7091
315-1504	320-2110	372-7097
315-1506	320-2111	372-7096
315-1507	320-2109	372-7098
315-1508	320-2114	392-9096
315-1508	320-2131	392-9092
315-1509	320-2117	392-9095
315-1510	320-2118	372-7095
315-1511	320-2129	392-9094
315-1515	320-2213	392-9112
315-1516	320-2097	392-9089
315-1517	320-2113	392-9088
315-1519	320-2213	392-9130
315-1525	320-2106	392-9131
315-1530	320-2115	392-9132

 Discontinued

Deflector Ring	Guardian®/ Guardian®HP Seal
317-1710	308-0855
317-1743	307-0743
317-1702	308-0836
317-1703	309-0973
317-1704	307-0713
317-1705	309-0904
317-1705	307-0723
317-1706	308-0856
317-1706	309-0903

Deflector Ring	Guardian®/ Guardian®HP Seal
317-1707	309-0912
317-1708	308-0853
317-1709	307-0744
317-1710	308-0855
317-1711	308-0864
317-1712	309-0964
317-1713	309-0965
317-1719	309-0961
317-1721	308-0863

Deflector Ring	Guardian®/ Guardian®HP Seal
317-1724	309-0957
317-1726	308-0866
317-1728	309-0935
317-1756	309-0915
317-1761	309-0970
317-1761	309-0960
317-1790	309-0948
317-1724	308-0870

 317-series deflector rings are component parts for the Guardian® Hub Seal. These parts are not sold separately.

Quick Reference

Standard and Grit Guard® Hub-Seal to Set Cross Reference

Quick Reference

Oil Seal	Axle Ring	Hub-Seal Set	Inner Bearing #	Universal Tool Head	Hub Tool	Comment
320-2001	310-1095	392-9001	758	555-5069	551-5398	
			760	555-5079	551-5398	
	310-1103	392-9062	760	555-5079	551-5398	
For trailer applications, use 310-1045 (set was 370-7019).						
320-2009	310-1028	392-9019	598	555-5071	551-5356	
	310-1079	392-9081	598A	555-5071	551-5356	
320-2012	310-1012	392-9012	47678	555-5074	551-5405	
			47686	555-5031	551-5405	See Set Remarks
			5760	555-5074	551-5405	
320-2017	310-1017	382-8017	39581	555-5062	551-5352	
320-2018	310-1008	372-7046	28995	555-5052	551-5351	
	310-1008	382-8018	45284	555-5064	551-5351	
320-2022	310-1050	382-8010	4595 or 39578	N/A	551-5381	
320-2023	310-1022	372-7022	593	None	551-5401	I-Beam Axle Model 5
	310-1023	372-7023	593 & HM518445	555-5023	551-5401	Pro-Par
	310-1041	382-8060	5760 or 6461	555-5023	551-5401	
	310-1130	372-7062	592A or 593	555-5023	551-5401	Modified No. 5
	315-1503	372-7099	HM518445	555-5023	551-5401	Grit Guard® for Pro-Par only
320-2028	310-1028	382-8028	756A	555-5067	551-5385	
320-2029	310-1018	372-7018	495AX	555-5074	551-5386	
	310-1018	392-9018	495AX	555-5074	551-5386	Ford thru 1969-70 Up use 392-9057
320-2031	310-1036	382-8025	557A OR HM212044	555-5061	551-5388	
	310-1051	382-8011	559 or 3982	None	551-5388	
320-2032	310-1032	382-8032	HM212049	None	551-5388	
	310-1036	372-7009	39250	555-5066	551-5388	
320-2034	310-1034	382-8034	HM212047	555-5066	551-5387	
320-2036	310-1036	382-8036	39581	555-5062	551-5346	
			557A or HM212044	555-5061	551-5346	
			HM212047	555-5066	551-5346	
			HM212049	555-5098	551-5346	
			HM212049X	555-5098	551-5346	
320-2039	310-1038	382-8039	641 or HM212049	None	551-5395 551-5413	Replaced by Voyager® Seal 383-8139
320-2041	310-1028	382-8045	756A	555-5067	551-5398	
	310-1043	372-7015	759	555-5023	551-5398	C&M K-30 Std. Forge TA- 26, A-26-S
320-2046	310-1036	372-7006	567	555-5011	551-5388	
320-2050	310-1052	382-8009	45284 or 45285	555-5036	551-5347	
320-2051	310-1047	372-7008	560S	555-5011	551-5388	
320-2056	310-1061	382-8005	3778	555-5001	551-5302	
320-2057	310-1062	392-9035	33287	555-5011	551-5353	
	310-1063	392-9036	33281	555-5002	551-5353	
320-2058	310-1093	392-9033	663, 749A or 6559	555-5072	551-5303	Gaskets Must Be Ordered Separately
320-2059	See Catalog 392-9053 and/or 392-9089 Remarks.					
320-2061	310-1066	392-9034	6580	555-5023	551-5356	Gasket Sold Separately
			6559	555-5072	551-5356	
320-2072	310-1064	372-7048	3984	555-5097	551-5308	
	310-1064	392-9038	3984	555-5097	551-5308	
320-2077	310-1104	392-9063	188931	555-5054	551-5362	
			387AS or 7451929	555-5062	551-5362	

- Discontinued
- Oil seal installs in bearing cup bore.
- Oil seal installs in bearing cup bore on steel hubs. On spoke wheels use seal bore.
- Voyager® Seal tool.

Standard and Grit Guard® Hub Seal to Set Cross Reference

Oil Seal	Axle Ring	Hub-Seal Set	Inner Bearing #	Universal Tool Head	Hub Tool	Comment
320-2086	310-1013	382-8001 ☒	6386 or 6389 6379	555-5060 555-5014	551-5311	
320-2091 ☒	SEE COMMENTS W/392-9045 SET	392-9045	33287	555-5011	551-5312	
			33281	555-5002		
			495AX	555-5074		
			47686	555-5031		
320-2096 ☒	310-1007 ☒	392-9007	663 or HM516449	555-5072	551-5390	Cast housings use 392-9004
320-2097	315-1516	392-9089	687 or 780	555-5004	551-5400	
320-2102	315-1501	392-9099	47685 or 47686	555-5031	551-5318	Grit Guard® I
			47678	555-5074	551-5318	
320-2104	310-1018	392-9057	495AX	555-5074	551-5383	Ford 1970 Up Thru 1969 use 392-9018
320-2105 ☒	310-1008	382-8044	45284	555-5064	551-5351	
320-2106	315-1525	392-9131	598 or 598A	555-5071	551-5320	Grit Guard® Used with or without Wabco ABS
			594 or 594A	555-5076	551-5320	
320-2109	310-1053	392-9032	580 575	555-5072 555-5074	551-5313 551-5313	
	310-1057 ☒	372-7003	663	555-5031	551-5313	KB-5, KB-6 T-18-W only
	315-1507	372-7098	663	555-5100	551-5313	Grit Guard®
320-2110	315-1504	372-7097	HM218248	555-5039	551-5412	Grit Guard®
320-2111	315-1506	372-7096	787	555-5016	551-5323	Grit Guard®
320-2113	315-1517 ☒	392-9088	594 or 594A	555-5076	551-5412	Grit Guard® I
320-2114	315-1508	392-9096	595	555-5072	551-5412	Grit Guard® I
			598	555-5071	551-5412	
320-2115	310-1113 ☒	392-9020 ☒	665	555-5068	551-5356	I
	310-1107	392-9066	592A/594A	555-5076	551-5356	Van Hool Bus Appl I
	315-1530 ☒	392-9132	592A/594A	555-5076	551-5356	Used with or without Wabco ABS
			592A/598A	555-5071	551-5356	
320-2117	315-1509 ☒	392-9095	582 or 663A	555-5072	551-5325	Grit Guard®
320-2118	315-1510	372-7095	665A	555-5069	551-5321	Grit Guard®
320-2119	310-1036 ☒	382-8027	39581	555-5062	551-5353	
320-2125	310-1051	382-8062	39585	None	551-5388	I
320-2129	315-1511	392-9094	580 or 582	555-5072	551-5393	Grit Guard®
320-2131	315-1508	392-9092	598	555-5071	551-5363	Grit Guard®
320-2133	310-1036 ☒	382-8063	39581	555-5062	551-5353	
			45284	555-5064	551-5353	
320-2136	310-1064 ☒	372-7049	JM511946	555-5055	551-5381	
320-2137	310-1037 ☒	382-8064	6461A	555-5007	551-5327	Replaced by 383-0164
320-2162	315-1502	392-9087	681A	555-5071	551-5333	See Set Remarks
			683	555-5076	551-5333	Grit Guard®
320-2164	310-1008	382-8066	JM207049	555-5088	551-5366	
			JM205149	555-5089	551-5366	
320-2166	310-1028 ☒	382-8069 ☒	6386	None	551-5340	Volvo Front
320-2173	310-1023 ☒	372-7024 ☒	749 or 749S	555-5024	551-5401	
	315-1503	372-7091	749 or 749S	555-5024	551-5401	Grit Guard®
320-2181	310-1009 ☒	382-8052	6386A	555-5060	551-5349	
	310-1093	382-8053 ☒	641 or HM212049	555-5060	551-5349	
			H715345	555-5070	551-5349	
320-2199	310-1093	382-8056 ☒	H715345	555-5070	551-5344	
320-2213	315-1515	392-9112	663 or HM516449,-C	555-5072	551-5364	Grit Guard®
	315-1519 ☒	392-9130	HM516449A	555-5073		
320-2216	310-1034 ☒	382-8071	HM212011/ HM212047	555-5066	551-5403	
320-2233	310-1233 ☒	392-9111	593X/594	555-5076	551-5404	Mack Midliner

Quick Reference

PERFORMANCE AND VALUE LEADER



Value Added Bearing Program

Through strategic alliances and strong global procurement, STEMCO Bearings meet the changing needs of today's market. STEMCO Bearings are the right mix of Performance, Convenience and Value.

Consolidated Wheel End Components Provider

The same company that provides High Performance STEMCO Wheel Seals, Pro-Torq Precision Adjusting Nuts and Hub Caps, can supply your wheel bearing needs; providing safety, reliability and performance from a single source.

STEMCO Quality Bearings

Our worldwide network of manufacturing plants is held to the highest quality standards by STEMCO and meets the ABMA specifications for bearing life calculations.

Expanded Bearing Coverage

The STEMCO product offering includes Tapered Roller Bearings, Radial Ball Bearings, Clutch Release Bearings, Individual Cups and Cones, and STEMCO Matched Bearing Sets.

Long Life Warranty

STEMCO offers a 3 or 5 year limited warranty when used in conjunction with the STEMCO Platinum Performance System or Platinum Performance System Plus.

STEMCO Quality Bearing Reference Guide

HEAVY DUTY TAPERED ROLLER BEARINGS

STEMCO PART NO.	DESCRIPTION
382A	Tapered Roller Cup, Truck
387AS	Tapered Roller Cone, Truck
493	Tapered Roller Cup, Truck
552A	Tapered Roller Cup, Front Axle
555S	Tapered Roller Cone, Front Axle
557S	Tapered Roller Cone, Front Axle
563	Tapered Roller Cup, Front Axle
567	Tapered Roller Cone, Front Axle
572	Tapered Roller Cup, Truck Axle
580	Tapered Roller Cone, Truck Axle
582	Tapered Roller Cone, Truck Axle
592A	Tapered Roller Cup, Truck/Trailer
594	Tapered Roller Cone, Front Axle
594A	Tapered Roller Cone, Front Axle
598A	Tapered Roller Cone, Front Axle
653	Tapered Roller Cup, Trailer/Truck Axle
663	Tapered Roller Cone, Trailer/Truck Axle
665A	Tapered Roller Cone, Trailer/Truck Axle
742	Tapered Roller Cup, Truck Axle
749	Tapered Roller Cone, Truck Axle
3720	Tapered Roller Cup, Front Axle
3782	Tapered Roller Cone, Front Axle
3920	Tapered Roller Cup, Truck Axle
6420	Tapered Roller Cup, Front Axle
6461A	Tapered Roller Cone, Front Axle
6535	Tapered Roller Cup, Truck Axle
6580	Tapered Roller Cone, Truck Axle
15245	Tapered Roller Cup, Truck Axle
15250	Tapered Roller Cup, Truck Axle
25520	Tapered Roller Cup, Truck Axle
25580	Tapered Roller Cone, Truck Axle
25820	Tapered Roller Cup, Truck Axle
25877	Tapered Roller Cone, Truck Axle
28682	Tapered Roller Cone, Truck Axle
39520	Tapered Roller Cup, Truck Axle
39585	Tapered Roller Cone, Truck Axle
39590	Tapered Roller Cone, Truck Axle
45220	Tapered Roller Cup, Front Axle
45280	Tapered Roller Cone, Front Axle
47620	Tapered Roller Cup, Rear Axle
47679	Tapered Roller Cone, Rear Axle
47686	Tapered Roller Cone, Rear Axle
H715311	Tapered Roller Cup, Truck Axle
H715345	Tapered Roller Cone, Truck Axle
HM212011	Tapered Roller Cup, Trailer/Front Axle
HM212047	Tapered Roller Cone, Front Axle
HM212049	Tapered Roller Cone, Trailer/Front Axle
HM218210	Tapered Roller Cup, Trailer Axle
HM218248	Tapered Roller Cone, Trailer Axle
HM516410	Tapered Roller Cup, Rear Axle
HM516449	Tapered Roller Cone, Rear Axle
HM518410	Tapered Roller Cup, Trailer Axle
HM518445	Tapered Roller Cone, Trailer Axle
JM207010	Tapered Roller Cup, Truck Axle
JM207049A	Tapered Roller Cone, Truck Axle
LM102949	Tapered Roller Cone, Front Axle

MATCHED BEARING SETS

STEMCO PART NO.	COMPONENTS
SET047-011	HM212047 / HM212011
SET049-011	HM212049 / HM212011
SET248-210	HM218248 / HM218210
SET445-410	HM518445 / HM518410
SET449-410	HM516449 / HM516410
SET580-72	580 / 572
SET582-72	582 / 572
SET594A-92A	594A / 592A
SET598A-92A	598A / 592A
SET663-53	663 / 653
SET3782-20	3782 / 3720
SET28682-22	28682 / 28622
SET39590-20	39590 / 39520
SET45280-20	45280 / 45220
SET45284-20	45284 / 45220
SET47679-20	47679 / 47620
SET47686-20	47686 / 47620

STEMCO MATCHED BEARING SETS

STEMCO PART NO.	COMPONENTS
ASET047-011	KHM212047 / KHM212011
ASET049-011	KHM212049 / KHM212011
ASET248-210	KHM218248 / KHM218210
ASET445-410	KHM518445 / KHM518410
ASET449A-410	KHM516449A / KHM516410
ASET555S-52A	K555S / K552A
ASET567-563	K567 / K563
ASET580-72	K580 / K572
ASET582-572	K582 / K572
ASET594A-92A	K594A / K592A
ASET598A-92A	K598A / K592A
ASET663-53	K663 / K653
ASET687-672	K687 / K672
ASET3782-20	K3782 / K3720
ASET6461A-20	K6461A / K6420
ASET45280-20	K45280 / K45220
ASET47679-20	K47679 / K47620

BALL/CLUTCH RELEASE/TAPERED BEARING SETS

STEMCO PART NO.	DESCRIPTION
F-01757-C	N1707
02135	N2135
02256A	N2256-N
A16	LM12749 / LM12711
A34	LM12748 / LM12710
A38	LM104949 / LM104911
105-SS1	Ball Bearing, 2 Shields
205-FF	Ball Bearing, 2 Seals
205-SS	Ball Bearing, 2 Shields
206-FF	Ball Bearing, 2 Seals
206-SS	Ball Bearing, 2 Shields
305-FF	Ball Bearing, 2 Seals
305-SS	Ball Bearing, 2 Shields
306-FF	Ball Bearing, 2 Seals
306-SS	Ball Bearing, 2 Shields

BALL, CLUTCH RELEASE AND TAPERED BEARING SETS

STEMCO PART NO.	DESCRIPTION
306-SSL	Ball Bearing, 2 Shields, Snap Ring
308-L	Ball Bearing, Snap Ring
1308-L	Ball Bearing, Snap Ring

* Multiply last 2 numbers by 5 to get Bore Size.

STEMCO "A" LINE BEARINGS

STEMCO PART NO.	INDUSTRY STANDARD PART NO.
ASET049-011	KHM212049 / KHM212011
A212049	KHM212049
A212011	KHM212011
ASET248-210	KHM218248 / KHM248210
A218248	KHM218248
A218210	KHM218210
ASET594A-92A	K594A / K592A
A594A	K594A
A592A	K592A
ASET580-72	K580 / K572
A580	K580
A572	K572
ASET3782-20	K3782 / K3720
A3782	K3782
A3720	K3720
ASET445-410	KHM518445 / KHM518410
A518445	KHM518445
A518410	KHM518410
ASET663-53	K663 / K653
A663	K663
A653	K653
ASET047-011	KHM212047 / KHM212011
A212047	KHM212047
A212011	KHM212011
ASET45280-20	K45280 / K45220
A45280	K45280
A45220	K45220
ASET6461A-20	K6461A / K6420
A6461A	K6461A
A6420	K6420
ASET555S-52A	K555S / K552A
A555S	K555S
A552A	K552A
ASET449A-410	KHM516449A / KHM516410
A516449A	KHM516449A
A516410	KHM516410
ASET47679-20	K47679 / K47620
A47679	K47679
A47620	K47620
ASET567-563	K567 / K563
A567	K567
A563	K563
ASET582-572	K582 / K572
A582	K582
A572	K572
ASET687-672	K687 / K672
A687	K687
A672	K672
ASET598A-92A	K598A / K592A
A598A	K598A
A592A	K592A

Bearings to Hub Seal Set Cross Reference

Quick Reference

Inner Cup & Cone	Outer Cup & Cone	Guardian®/ Guardian® HP Seal No.	Grit Guard®/ Standard Set	Voyager® Discover®
33212	33208			383-0176
382A/387AS	LM104911/ LM104949		392-9063	
493/495AX	3920/ 3984		392-9018	
493/495AX	33287/ 33462	309-0957	392-9057	
493/495AX	39520/ 39590	309-0957	392-9057	
552A/559	552/526		392-9045	
553X/557A	3720/3782	308-0836	382-8011	383-0136 383-0236
563/567	522/528		372-7006	
572/575	572/575		392-9032	
572/580	563/567	309-0903	392-9094*	393-0103 393-0203
572/580	42620/ 42687	309-0961	392-9032	
572/582	563/567	309-0903	392-9095*	
572/582	42620/ 42687	309-0961	392-9094*	393-0103 393-0203
592A/593	65320/ 65390		372-7022 372-7062	
592A/594	572/580	309-0964	392-9088*	
592A/594	572/580	309-0973	392-9131	393-0173 393-0273
592A/594A	572/580	309-0960 309-0964	392-9132* 392-9088*	
592A/594A	572/580	309-0973	392-9131	393-0173 393-0273
592A/594A	572/582	309-0960	392-9132*	
592A/595	572/580	309-0965	392-9096	
592A/598	572/575	309-0965	392-9096*	
592A/598	572/575	309-0973	392-9131	393-0173 393-0273
592A/598A	653/665	309-0965	392-9092*	
592A/598	752/758	309-0965	392-9092*	
592A/598	HM617010/ HM617049	309-0965	392-9092*	
592A/598A	572/580	309-0960	392-9132	
592A/598A	572/580	309-0973	392-9131	393-0173 393-0273
592A/598A	572/582	309-0960	392-9132*	
592A/598	HM617010/ HM617049	309-0960	392-9081 392-9132	
593X/594	593X/594		392-9111	
632/641	3920/3979	308-0853	382-8053	383-0153 N/A
632/641	28622/ 28682	308-0856	382-8056	383-0156 N/A
633/641	65320/ 65385		382-8039	383-8139
652/663	572/575	309-0904	392-9112*	393-0104 393-0204
			392-9007	

Inner Cup & Cone	Outer Cup & Cone	Guardian®/ Guardian® HP Seal No.	Grit Guard®/ Standard Set	Voyager® Discover®
653/663	553X560	307-0713	372-7098*	373-0113 373-0213
653/663	HM212011/ HM212049	307-0713	372-7098*	373-0113 373-0213
			372-7003	
653/663A	42620/ 42687	309-0961	392-9095*	
653/665A	HM212011/ HM212049	307-0744	372-7095*	
672/681A	572/575	309-0970	392-9087*	
672/683	572/580	309-0970	392-9087*	
672/683XA	572/580	309-0970	392-9087*	
672/687	772/780	309-0948	392-9089*	393-0148 N/A
672/687	52618/ 52400	309-0948	392-9089*	393-0148 N/A
742/749	632/643		372-7091* 372-7024	
742/749S	632/643		372-7091* 372-7024	
742/749A	653/663		392-9033	
752/756A	HM212011/ HM212046		382-8028 382-8045	
752/756A	HM212011/ HM212047		382-8028 382-8045	
752/758	663/665		392-9001	
752/759	742/740		372-7015	
752/760	742/749		392-9001	
752/760	742/749		392-9062	
772/780	772/776	309-0948	392-9089*	393-0148 N/A
772/780	854/864	309-0948	392-9089*	393-0148 N/A
772/780	52618/ 52400	309-0948	392-9089*	393-0148 N/A
772/780	77675/ 77375	309-0948	392-9089*	393-0148 N/A
772/782	742/749		392-9053	
832/843	632/636		382-8008	
3720/3778	25820/ 25877		382-8005	
3720/3778	2720/2790		382-8005	
3920/3982	3820/3877		382-8011	
3920/3984	453X/462		392-9038	
4536/4595	414A/418		382-8010	
5735/5760	572/575	309-0912	392-9012	393-0112 393-0212
5735/5760	39520/ 39590		382-8052	
5735/5760	45220/ 45287		382-8060	
6320/6379	552A/557S		382-8001	383-0101
6320/6386	552A/557S		382-8001	383-0101
6320/6386A	532A/537		382-8052	
6320/6389	552A/557S		382-8001	383-0101
6420/6461	612/621		382-8060	

Bearings to Hub Seal Set Cross Reference

Inner Cup & Cone	Outer Cup & Cone	Guardian®/ Guardian® HP Seal No.	Grit Guard®/ Standard Set	Voyager® Discover®
6420/6461A	552A/555S	308-0864	382-8064	383-0164 383-0264
6420/6461A	3920/3979	308-0864	382-8064	383-0164 383-0264
6535/6559	653/663		392-9033	393-0134
			392-9034	✘
6535/6580	653/663		392-9034	✘ 393-0134
28920/28995	25523/ 25580		372-7046	
33462/33281	3920/3982	309-0935	392-9035	
33462/33281	39520/ 39585		392-9036	
33462/33287	3920/3982	309-0935	392-9035	
33472/33281	3925/3984		392-9045	
33472/33287	3925/3982		392-9045	
33821/33895	3120/3196		382-8016	
39520/39578	25520/ 25572		382-8010	
39520/39581	3525/3585	308-0836	382-8036	383-0136 383-0236
		308-0863	382-8063 382-8027	
39520/39581	26820/ 26878		382-8017	
39520/39585	25520/ 25572		382-8062	
45220/45284	2720/2780		382-8044	
45220/45284	2720/2786		382-8009	
45220/45284	2720/2793		382-8009	
45220/45284	2720/2796		382-8009	
45220/45284	25820/ 25880	308-0863	382-8044 382-8063	
45220/45285	2720/2786		382-8009	
45220/45285	2720/2793		382-8009	
45220/45285	2720/2796		382-8009	
47620/47678	39520/39585	309-0912	392-9012 ✘ 392-9099*	393-0112 393-0212
47620/47685	39520/39590	309-0912	392-9099*	393-0112 393-0212
47620/47686	39520/39590	309-0912	392-9099*	393-0112 393-0212
		309-0915	392-9012 ✘ 392-9045	393-0112
127627/ 1889311	49521/188933		392-9063	
7451691/ 7451929	7451813/ 7451814		392-9063	
H715311/ H715345	552A/555S	308-0856	382-8056 ✘	383-0156 N/A
H715311/ H715345	3920/3979	308-0853	382-8053 ✘	383-0153 N/A
HM212010/ HM212049	28622/28682	308-0853	382-8053 ✘	383-0153 N/A
HM212011/ HM212044	3720/3782	308-0836	382-8036	383-0136 383-0236
HM212011/ HM212047	3720/3779		382-8034	

Inner Cup & Cone	Outer Cup & Cone	Guardian®/ Guardian® HP Seal No.	Grit Guard®/ Standard Set	Voyager® Discover®
HM212011/ HM212047	3720/3782	308-0836	382-8036	383-0136 383-0236
HM212011/ HM212047	45220/ 45282		382-8034 382-8071 ✘	383-0171
HM212011/ HM212049	3720/3782	308-0836	382-8036	383-0136 383-0236
			382-8032	
HM212011/ HM212049	45220/ 45280		382-8039 ✘	383-0139 383-0239
HM212011/ HM212049X	3720/3782	308-0836	382-8036	383-0136 383-0236
HM218210/ HM218248	HM212011/ HM212049	307-0743	372-7097	373-0143 373-0243
JM205110/ JM205149	25820/ 25877	308-0866	382-8066	383-0166 383-0175
JM207010/ JM207049	25820/ 25877	308-0866	382-8066	383-0166
HM516410/ HM516449	572/575		392-9007	
HM516410/ HM516449	47620/ 47679	309-0904	392-9112	393-0104 393-0204
			392-9007	
HM516410/ HM516449A	47620/ 47679	309-0904	392-9130	*393-0104 393-0204
HM518410/ HM518445	HM518410/ HM518445	307-0723	372-7099	373-0123 373-0223
JM205149	32207			383-0175
JM205110/ JM204149A	25820/ 25877		382-8066	383-0166
JM511910/ JM510946	JM205110/ JM205149		372-7049	
JF7049A		308-0870		
33212	33208			383-0176

✘ Discontinued

Quick Reference

Guardian® & Guardian® HP Hub-Seals

GUARDIAN HP - TRAILER AXLE

307-0713

Bore Diameter	5.700
Inner Bearing Cup/Cone	653/663
Outer Bearing Cup/Cone	553X/560, HM212011/ HM212049
Spindle Shoulder O.D.	4.000
Width	0.604
Univ. Axle Tool Head	555-5100
Install Handle/Body	555-0001
Grit Guard® Equiv.	372-7098
Voyager® Equiv.	373-0113
Discover® Equiv.	373-0213

Remarks: Do not use on early hubs and wheels that have seal bore diameter greater than 5.758".

▼ Related Parts ▼

Hub Cap w/ Gasket**	Gasket Number**
340-4009	330-3009
340-4013	330-3013

GUARDIAN HP - TRAILER AXLE

307-0723

Bore Diameter	6.008
Inner Bearing Cup/Cone	HM518410/ HM518445
Outer Bearing Cup/Cone	HM518410/ HM518445
Width	0.5629
Univ. Axle Tool Head	555-5023
Install Handle/Body	555-0001
Grit Guard® Equiv.	372-7099
Voyager® Equiv.	373-0123
Discover® Equiv.	373-0223

Remarks: Guardian® set for Pro-Par axle; Also Eaton P-22 and Meritor TP Hub Cap tool #570-7008.

▼ Related Parts ▼

Hub Cap w/ Gasket**	Gasket Number**
340-4075	330-3077
340-4195	330-3118

GUARDIAN HP - TRAILER AXLE

307-0743

Bore Diameter	6.000
Inner Bearing Cup/Cone	HM218210/ HM218248
Outer Bearing Cup/Cone	HM212011/ HM212049
Spindle Shoulder O.D.	4.625
Width	0.584
Univ. Axle Tool Head	555-5039
Install Handle/Body	555-0001
Grit Guard® Equiv.	372-7097
Voyager® Equiv.	373-0143
Discover® Equiv.	373-0243

Remarks: Will not fit Std. Forge Hub mfg. prior to 8/71 nor Kershaw K-22 Axle prior to 1/73, nor Std. Forge A22-S Axle prior to 5/71, nor KBW prior to 1/78.

▼ Related Parts ▼

Hub Cap w/ Gasket**	Gasket Number**
340-4009	330-3009
340-4013	330-3013

GUARDIAN - TRAILER AXLE

307-0744

Bore Diameter	5.753
Inner Bearing Cup/Cone	653/665A
Outer Bearing Cup/Cone	HM212011/ HM212049
Spindle Shoulder O.D.	4.625
Width	0.584
Univ. Axle Tool Head	555-5069
Install Handle/Body	555-0001
Grit Guard® Equiv.	372-7095
Voyager® Equiv.	373-0144

Remarks: Do not use with Budd hubs having seal bore diameter greater than 5.758. When used with Eaton inboard skid control, use 320-2118 & 310-1037.

▼ Related Parts ▼

Hub Cap w/ Gasket**	Gasket Number**
340-4009	330-3009
340-4013	330-3013

Very Important. These seal sets must be installed with the tools listed in this catalog.

Hub caps sold separately.

NOTE: Use 555 series Tool Heads with Universal Axle Tool body 555-0001.

** For hub cap with pipe plug use 343-prefix.

Voyager® & Discover® Hub Seals

Seal Sets
Trailer Axles

Component
Specs

Installation
Tools

Axle
Fasteners

Long-Life
Systems

Cross
Reference

Installation
Instructions

VOYAGER & DISCOVER - FRONT AXLE 373-0113 373-0213

Bore Diameter	5.750
Inner Bearing Cup / Cone	653/663
Outer Bearing Cup / Cone	553X/560, HM212011/ HM212049
Bearing Guide	570-0023
Spindle Shoulder O.D.	4.000
Width	0.9399
Fleet Hub Tool	551-5313
Install Handle/Body	551-0001
Guardian® Equiv.	307-0713
Grit Guard® Equiv.	372-7098

Remarks: Do not use on early hubs and wheels that have seal bore diameter greater than 5.758".

Related Parts

Hub Cap w/ Gasket**	Gasket Number**
340-4009	330-3009
340-4013	330-3013

VOYAGER & DISCOVER - FRONT AXLE 373-0123 373-0223

Bore Diameter	6.008
Inner Bearing Cup / Cone	HM518410/ HM518445
Outer Bearing Cup / Cone	HM518410/ HM518445
Bearing Guide	570-0025
Spindle Shoulder O.D.	4.250
Width	0.995
Fleet Hub Tool	551-5401
Install Handle/Body	551-0001
Guardian® Equiv.	307-0723
Grit Guard® Equiv.	372-7099

Remarks: Fits Pro-Par axle; also Eaton P-22 and Meritor TP. Hub cap tool #570-7008.

Related Parts

Hub Cap w/ Gasket**	Gasket Number**
340-4075	330-3077
340-4195	330-3118

VOYAGER & DISCOVER - FRONT AXLE 373-0143 373-0243

Bore Diameter	6.000
Inner Bearing Cup / Cone	HM218210/ HM218248
Outer Bearing Cup / Cone	HM212011/ HM212049
Bearing Guide	570-0026
Spindle Shoulder O.D.	4.625
Width	0.981
Fleet Hub Tool	551-5412
Install Handle/Body	551-0001
Guardian® Equiv.	307-0743
Grit Guard® Equiv.	372-7097

Remarks: Will not fit Std. Forge Hub mfd. prior to 8/71 nor Kershaw K-22 Axle prior to 1/73, nor x prior to 1/73, nor Std. Forge A22-S KBW prior to 1/78.

Related Parts

Hub Cap w/ Gasket**	Gasket Number**
340-4009	330-3009
340-4013	330-3013

VOYAGER - FRONT AXLE 373-0144

Bore Diameter	5.753
Inner Bearing Cup / Cone	653/665A
Outer Bearing Cup / Cone	HM212011/ HM212049
Bearing Guide	570-0024
Spindle Shoulder O.D.	4.375
Width	0.993
Fleet Hub Tool	551-5339
Install Handle/Body	551-0001
Guardian® Equiv.	307-0744
Grit Guard® Equiv.	372-7095

Remarks: Do not use with Budd hubs having seal bore diameter greater than 5.758. When used with Eaton inboard skid control, use **320-2118** & **310-1037**.

Use Hub tool **551-5321** with **372-7095**

Related Parts

Hub Cap w/ Gasket**	Gasket Number**
340-4009	330-3009
340-4013	330-3013

VOYAGER - FRONT AXLE 373-0191

Bore Diameter	6.032
Inner Bearing Cup / Cone	742/749 or 749S
Outer Bearing Cup / Cone	632/643
Bearing Guide	570-0003
Spindle Shoulder O.D.	4.625
Width	0.981
Fleet Hub Tool	551-5401
Install Handle/Body	551-0001
Grit Guard® Equiv.	372-7091

Remarks: Will not fit S/F A-21-T prior to 6/71. Will not fit Gunitex Wheels R-20-319 or T22-319.

Related Parts

Hub Cap w/ Gasket**	Gasket Number**
340-4011	330-3011
340-4163	330-3104
340-4059	330-3056

Very Important. These seal sets must be installed with the tools listed in this catalog.

Hub caps sold separately.

NOTE: Use 551 series tools with new Universal Hub Tool Handle 551-0001 (installs 320 series Voyager® and Discover® seals).

** For hub cap with pipe plug use 343-prefix.

Standard Hub-Seal Sets

STANDARD - TRAILER AXLE

372-7003

Bore Diameter	5.750
Axle Ring	310-1057
Oil Seal	320-2109
<i>Bore Diameter</i>	5.750
Inner Bearing Cup/Cone	653/663
Outer Bearing Cup/Cone	HM212011/ HM212049, 553X/560
Universal Axle Tool Head	555-5031
Universal Hub Tool Head	551-5313
Installation Handle/Body	555-0001 & 551-0001
Bearing Guide	570-0023
Remarks	N/A

Related Parts

Hub Cap w/ Gasket**	Gasket Number**
340-4015*	330-3015

STANDARD - TRAILER AXLE

372-7006

Bore Diameter	5.003
Axle Ring	310-1036
Oil Seal	320-2046
<i>Bore Diameter</i>	5.003
Inner Bearing Cup/Cone	563/567
Outer Bearing Cup/Cone	522/528
Universal Axle Tool Head	555-5011
Universal Hub Tool Head	551-5388
Installation Handle/Body	555-0001 & 551-0001
Remarks	N/A

Related Parts

Hub Cap w/ Gasket**	Gasket Number**
340-4002	330-3002
340-4009	330-3009
340-4011	330-3011
340-4014	330-3014
340-4024	330-3024

Discontinued

Very Important. These seal sets must be installed with the tools listed in this catalog.

Hub caps sold separately. * Not available with pipe plug. ** For hub cap with pipe plug use 343-prefix.

STANDARD - TRAILER AXLE

372-7015

Bore Diameter	6.437
Axle Ring	310-1043
Oil Seal	320-2041
<i>Bore Diameter</i>	6.437
Inner Bearing Cup/Cone	752/759
Outer Bearing Cup/Cone	742/740
Universal Axle Tool Head	555-5023
Universal Hub Tool Head	551-5398
Installation Handle/Body	555-0001 & 551-0001
Bearing Guide	570-0025
Remarks	N/A

Related Parts

Hub Cap w/ Gasket**	Gasket Number**
340-4054*	330-3017
340-4082	330-3062
340-4064	330-3079

*Not available with pipe plug.

STANDARD - TRAILER AXLE

372-7022

Bore Diameter	6.008
Axle Ring	310-1022
Oil Seal	320-2023
<i>Bore Diameter</i>	6.008
Inner Bearing Cup/Cone	592A/593
Outer Bearing Cup/Cone	65320/65390
Universal Axle Tool Head	None
Universal Hub Tool Head	551-5401
Installation Handle/Body	555-0001 & 551-0001
Bearing Guide	570-0025
Remarks:	Fruehauf No. 5 (Prior to Feb. 1960) includes O-ring 355-5502

Related Parts

Hub Cap w/ Gasket**	Gasket Number**
340-4019	330-3019

STANDARD - TRAILER AXLE

372-7046

Bore Diameter	4.125
Axle Ring	310-1008
Oil Seal	320-2018
<i>Bore Diameter</i>	4.125
Inner Bearing Cup/Cone	28920/28995
Outer Bearing Cup/Cone	25523/25580
Univ. Axle Tool Head	555-5052
Univ. Hub Tool Head	551-5351
Install Handle/Body	555-0001 & 551-0001
Remarks:	N/A

Related Parts

Hub Cap w/ Gasket**	Gasket Number**
340-4157*	330-3102

*Not available with pipe plug.

STANDARD - TRAILER AXLE

372-7049

Bore Diameter	4.500
Axle Ring	310-1064
Oil Seal	320-2136
<i>Bore Diameter</i>	4.500
Inner Bearing Cup/Cone	JM511910/ JM511946
Outer Bearing Cup/Cone	JM205110/ JM205149
Univ. Axle Tool Head	555-5055
Univ. Hub Tool Head	551-5381
Install Handle/Body	555-0001 & 551-0001
Remarks	N/A

Related Parts

Hub Cap w/ Gasket**	Gasket Number**
340-4139*	330-3094

*Not available with pipe plug.

STANDARD - TRAILER AXLE

372-7062

Bore Diameter	6.008
Axle Ring	310-1130
Oil Seal	320-2023
<i>Bore Diameter</i>	6.008
Inner Bearing Cup/Cone	592A/593
Outer Bearing Cup/Cone	65320/65390 HH506310/HH506348
Univ. Axle Tool Head	555-5023
Univ. Hub Tool Head	551-5401
Install Handle/Body	555-0001 & 551-0001
Bearing Guide	570-0025
Remarks:	Fruehauf Modified #5, 2/60 & up.

Related Parts

Hub Cap w/ Gasket**	Gasket Number**
340-4019	330-3019

Grit Guard® Hub-Seal Sets

GRIT GUARD - TRAILER AXLE

372-7091

Bore Diameter	6.032
Axle Ring	315-1503
Oil Seal	320-2173
<i>Bore Diameter</i>	6.032
Inner Bearing Cup/Cone	742/749 or 749S
Outer Bearing Cup/Cone	632/643
Universal Axle Tool Head	555-5024
Universal Hub Tool Head	551-5401
Installation Handle/Body	555-0001 & 551-0001
Bearing Guide	N/A

Remarks: Will not fit S/F A-21-T prior to 6/71. Will not fit Gunite wheels R20-319 or T22-319.

Related Parts

Hub Cap w/ Gasket**	Gasket Number**
340-4011	330-3011
340-4163	330-3104
340-4059	330-3056

For Voyager® Seal No. 309-0173, 6.032" Bore, See Pg. 30

GRIT GUARD - TRAILER AXLE

372-7095

Bore Diameter	5.753
Axle Ring	315-1510
Oil Seal	320-2118
<i>Bore Diameter</i>	5.753
Inner Bearing Cup/Cone	653/665A
Outer Bearing Cup/Cone	HM212011/ HM212049
Universal Axle Tool Head	555-5069
Universal Hub Tool Head	551-5321
Install Handle/Body	555-0001 & 551-0001
Bearing Guide	570-0024

Remarks: Do not use with Budd hubs having seal bore diameter greater than 5.758. When used with Eaton inboard skid control, use **320-2118** and **310-1037**.

Related Parts

Hub Cap w/ Gasket**	Gasket Number**
340-4009	330-3009
340-4013	330-3013
340-4015*	330-3015

For Guardian® Seal No. 307-0744, 5.753" Bore, See Pg. 16
For Voyager® Seal No. 373-0144, 5.753" Bore, See Pg. 18

GRIT GUARD - TRAILER AXLE

372-7096

Bore Diameter	7.135
Axle Ring	315-1506
Oil Seal	320-2111
<i>Bore Diameter</i>	7.135
Inner Bearing Cup/Cone	772/787
Outer Bearing Cup/Cone	6535/6580
Universal Axle Tool Head	555-5016
Universal Hub Tool Head	551-5323
Installation Handle/Body	555-0001 & 551-0001
Bearing Guide	N/A
Remarks:	N/A

Related Parts

Hub Cap w/ Gasket**	Gasket Number**
343-4107	330-3084

GRIT GUARD - TRAILER AXLE

372-7097

Bore Diameter	6.000
Axle Ring	315-1504
Oil Seal	320-2110
<i>Bore Diameter</i>	6.000
Inner Bearing Cup/Cone	HM218210/ HM218248
Outer Bearing Cup/Cone	HM212011/ HM212049
Universal Axle Tool Head	555-5039
Universal Hub Tool Head	551-5412
Installation Handle/Body	555-0001 & 551-0001
Bearing Guide	570-0026

Remarks: Will not fit:
• Std. Forge Hub mfg. prior to 8/71
• Kershaw K-22 axle prior to 1/73
• Std Forge A22-S axle prior to 5/71
• KBW prior to 1/78.

Ring **315-1504** will not fit shoulders less than .625, use **310-1048**.

Related Parts

Hub Cap w/ Gasket**	Gasket Number**
340-4009	330-3009
340-4013	330-3013

For Guardian® HP Seal No. 307-0743, 6.000" Bore, See Pg. 16
For Voyager® Seal No. 373-0143, 6.000" Bore, See Pg. 18
For Discover® Seal No. 373-0243, 6.000" Bore, See Pg. 18

GRIT GUARD - TRAILER AXLE

372-7098

Axle Ring	315-1507
Oil Seal	320-2109
<i>Bore Diameter</i>	5.750
Inner Bearing Cup/Cone	653/663
Outer Bearing Cup/Cone	553X/560 HM212011/ HM212049
Universal Axle Tool Head	555-5100
Universal Hub Tool Head	551-5313
Install Handle/Body	555-0001 & 551-0001
Bearing Guide	570-0023

Remarks: Do not use on early hubs and wheels that have seal bore diameter greater than 5.758".

Related Parts

Hub Cap w/ Gasket	Gasket Number
340-4009	330-3009
340-4013	330-3013
340-4015*	330-3015

For Guardian® HP Seal No. 307-0713, 5.750" Bore, See Pg. 16
For Voyager® Seal No. 373-0113, 5.750" Bore, See Pg. 18
For Discover® Seal No. 373-0213, 5.750" Bore, See Pg. 18

GRIT GUARD - TRAILER AXLE

372-7099

Axle Ring	315-1503
Oil Seal	320-2023
<i>Bore Diameter</i>	6.008
Inner Bearing Cup/Cone	HM518410/ HM518445
Outer Bearing Cup/Cone	HM518410/ HM518445
Universal Axle Tool Head	555-5023
Universal Hub Tool Head	551-5401
Install Handle/Body	555-0001 & 551-0001
Bearing Guide	570-0025

Remarks: Fits Pro-Par axle, Eaton P-22 and Meritor TP.

Hub Cap Tool No. 570-7008

Related Parts

Hub Cap w/ Gasket	Gasket Number
340-4075	330-3077
340-4195	330-3118

For Guardian® HP Seal No. 307-0723, 6.008" Bore, See Pg. 16
For Voyager® Seal No. 373-0123, 6.008" Bore, See Pg. 18
For Discover® Seal No. 373-0223, 6.008" Bore, See Pg. 18

Guardian[®] Hub-Seal Sets

GUARDIAN HP - FRONT AXLE

308-0836

Bore Diameter	4.840
Bearings and Tool Combination:	
Inner Bearing Cup/Cone	39520/39581
Outer Bearing Cup/Cone	3525/3585
Tool Head	555-5062
Bearings and Tool Combination:	
Inner Bearing Cup/Cone	HM212011/ HM212044, 553X/557A
Outer Bearing Cup/Cone	3720/3782
Tool Head	555-5061
Bearings and Tool Combination:	
Inner Bearing Cup/Cone	HM212011/ HM212049 HM212011/ HM212049-X, X1
Outer Bearing Cup/Cone	3720/3782
Tool Head	555-5098
Bearings and Tool Combination:	
Inner Bearing Cup/Cone	HM212011/ HM212047
Outer Bearing Cup/Cone	3720/3782
Tool Head	555-5066
Spindle Shoulder O.D.	3.500
Width	0.840
Install Handle/Body	555-0001
Standard Set Equip.	382-8036
Voyager[®] Equip.	383-0136
Discover[®] Equip.	383-0236

Remarks: Ford 9000# axle. Code N (FD-900), with 15x3 or 15x3-1/2 wedge brakes, use **382-8027** set. GMC only (FE-900), prior to 1960 use, **310-1036** and **320-2031**. Be sure steering adjustment stop bolt does not interfere with ring.

Related Parts

Hub Cap w/ Gasket**	Gasket Number**
340-4009	330-3009
340-4024	330-3024
340-4095	330-3009
340-4028	330-3028
340-4186	330-3120
340-4042	330-3041
340-4249	330-3122
340-4066	330-3041
340-4046	330-3009
340-4034	330-3034
340-4149	330-3097

GUARDIAN - FRONT AXLE

308-0853

Bore Diameter	5.372
Bearings and Tool Combination:	
Inner Bearing Cup/Cone	632/641
Outer Bearing Cup/Cone	3920/3979
Tool Head	555-5060
Bearings and Tool Combination:	
Inner Bearing Cup/Cone	H715311/ H715345
Outer Bearing Cup/Cone	3920/3979
Tool Head	555-5070
Bearings and Tool Combination:	
Inner Bearing Cup/Cone	HM212001/ HM212049
Outer Bearing Cup/Cone	28622/28682
Tool Head	555-5060
Width	0.518
Install Handle/Body	555-0001
Standard Set Equip.	382-8053
Voyager[®] Equip.	383-0153

Related Parts

Hub Cap w/ Gasket**	Gasket Number**
340-4046	330-3009
340-4249	330-3122
340-4095	330-3009

GUARDIAN - FRONT AXLE

308-0855

Bore Diameter	5.875
Inner Bearing Cup/Cone	632/641
Outer Bearing Cup/Cone	28622/28682
Universal Axle Tool Head	555-5060
Width	0.820
Installation Handle/Body	555-0001
Voyager[®] Equip.	383-0156

Remarks: Use with FA-109 1979 & up spoke wheel number 45493-C2. Must be used with hydraulic brakes after 75. FA-109 comes with hydraulic brakes. IHC application.

Related Parts

Hub Cap w/ Gasket**	Gasket Number**
340-4249	330-3122

GUARDIAN - FRONT AXLE

308-0856

Bore Diameter	5.875
Inner Bearing Cup/Cone	H715311/ H715345, 632/641
Outer Bearing Cup/Cone	28622/28682, 552A/555S
Universal Axle Tool Head	555-5070
Spindle Shoulder O.D.	4.500
Width	0.820
Install Handle/Body	555-0001
Standard Set Equip.	382-8056
Voyager[®] Equip.	383-0156

Related Parts

Hub Cap w/ Gasket**	Gasket Number**
340-4249	330-3122
340-4046	330-3009
340-4095	330-3009

GUARDIAN - FRONT AXLE

308-0863

Bore Diameter	4.542
Bearings and Tool Combination:	
Inner Bearing Cup/Cone	39520/39581
Outer Bearing Cup/Cone	3525/3585
Universal Axle Tool Head	555-5062
Remarks	Ford 9000# 1975 to 1984
Bearings and Tool Combination:	
Inner Bearing Cup/Cone	45220/45284
Outer Bearing Cup/Cone	25820/25880
Universal Axle Tool Head	555-5064
Remarks	Ford 9000# 1984 up
Spindle Shoulder O.D.	3.500
Width	0.760
Standard Set Equip.	382-8063
Install Handle/Body	555-0001

Related Parts

Hub Cap w/ Gasket**	Gasket Number**
340-4186	330-3120

Guardian® Hub-Seal Sets

GUARDIAN - FRONT AXLE 308-0864

Bore Diameter	5.903
Inner Bearing Cup/Cone	6420/6461A
Outer Bearing Cup/Cone	552A/555S, 3920/3979
Universal Axle Tool Head	555-5007
Spindle Shoulder O.D.	4.375
Width	0.955
Install Handle/Body	555-0001
Standard Set Equip.	382-8064
Voyager® Equip.	383-0164
Discover® Equip.	383-0264

Related Parts

Hub Cap w/ Gasket**	Gasket Number**
340-4046	330-3009
340-4249	330-3122
340-4049	330-3042
343-4249	330-3122
340-4066	330-3041
340-4095	330-3009
340-4149	330-3097
340-4098	330-3009

GUARDIAN - FRONT AXLE 308-0866

Bore Diameter	3.875
Bearings and Tool Combination:	
Inner Bearing Cup/Cone	JM207010/ JM207049A
Outer Bearing Cup/Cone	25820/25877
Tool Head	555-5088
Bearings and Tool Combination:	
Inner Bearing Cup/Cone	JM205110/ JM205149A
Outer Bearing Cup/Cone	25820/25877
Tool Head	555-5089
Width	0.495
Install Handle/Body	555-0001
Standard Set Equip.	382-8066
Voyager® Equip.	383-0166

Related Parts

Hub Cap w/ Gasket**	Gasket Number**
340-4065	330-3040

GUARDIAN - FRONT AXLE 308-0870

Bore Diameter	5.512
Inner Bearing Cup/Cone	JF7049A
Universal Axle Tool Head	555-5927
Spindle Shoulder O.D.	3.937
Width	0.820
Installation Handle/Body	555-0001
Remarks: Volvo FA 7.5 Front Axle	

Very Important. These seal sets must be installed with the tools listed in this catalog.

Hub caps sold separately.

NOTE: Use 555 series Tool Heads with Universal Axle Tool body 555-0001 (installs axle/deflector rings).

NOTE: Use 551 series tools with new Universal Hub Tool Handle 551-0001 (installs 320 series Voyager® and Discover® seals).

* Not available with pipe plug.

** For hub cap with pipe plug use 343-prefix.

 Discontinued

Voyager® & Discover® Hub-Seals

VOYAGER - FRONT AXLE

383-0101

Bore Diameter 5.625

Bearings and Tool Combination:

Inner Bearing Cup/Cone 6320/6386 or 6389

Outer Bearing Cup/Cone 552A/557S

Fleet Hub Tool 551-5420

Bearing Guide 570-0020

Bearings and Tool Combination:

Inner Bearing Cup/Cone 6320/6379

Outer Bearing Cup/Cone 552A/557S

Bearing Guide N/A

Spindle Shoulder O.D. 4.000

Width 0.6250

Install Handle/Body 551-0001

Standard Set Equiv. 382-8001 

Remarks: Bearing spacer not part of set. Purchase from dealer if damaged or worn. When used on tag or pusher axle with inner cone 6379, bearing spacer is not used.

▼ **Related Parts** ▼

Hub Cap w/ Gasket**	Gasket Number**
343-4080	330-3060

VOYAGER & DISCOVER - FRONT AXLE

383-0136

383-0236

Bore Diameter 4.840

Bearings and Tool Combination:

Inner Bearing Cup/Cone 39520/39581

Outer Bearing Cup/Cone 3525/3585

Bearing Guide 570-0017

Bearings and Tool Combination:

Inner Bearing Cup/Cone HM212011/
HM212044
553X/557A

Outer Bearing Cup/Cone 3720/3782

Bearing Guide 570-0018

Bearings and Tool Combination:

Inner Bearing Cup/Cone HM212011/
HM212049,
HM212011/
HM212049X, X1

Outer Bearing Cup/Cone 3720/3782

Bearing Guide 570-0020

Bearings and Tool Combination:

Inner Bearing Cup/Cone HM212011/
HM212047

Outer Bearing Cup/Cone 3720/3782

Bearing Guide 570-0019

Fleet Hub Tool 551-5346

Spindle Shoulder O.D. 3.500

Width 0.932

Install Handle/Body 551-0001

Guardian® Equiv. 308-0836

Standard Set Equiv. 382-8036

Remarks: Ford 9000# axle. Code N (FD-900), with 15x3 or 15x3-1/2 wedge brakes, use **382-8027** set. GMC only (FE-900), prior to 1960, use **310-1036** and **320-2031** sets. Be sure steering adjustment stop bolt does not interfere with ring.

▼ **Related Parts** ▼

Hub Cap w/ Gasket**	Gasket Number**
340-4009	330-3009
340-4024	330-3024
340-4095	330-3009
340-4028	330-3028
340-4186	330-3028
340-4042	330-3041
340-4249	330-3122
340-4249	330-3122
340-4066	330-3041
340-4046	330-3009
340-4034	330-3034
340-4149	330-3097
343-4025	330-3025

VOYAGER & DISCOVER - FRONT AXLE

383-0139

383-0239

Bore Diameter 5.120

Bearings and Tool Combination:

Inner Bearing Cup/Cone 632/641

Outer Bearing Cup/Cone 65320/65385

Fleet Hub Tool 551-5413

Bearing Guide 570-0020

Bearings and Tool Combination:

Inner Bearing Cup/Cone HM212011/
HM212049

Outer Bearing Cup/Cone 45220/45280

Spindle Shoulder O.D. 4.000

Width 0.968

Install Handle/Body 551-0001

Standard Set Equiv. 382-8039 

Remarks: **383-0139** must be used with **310-1132** ring. Must be ordered as **383-8139** to receive **310-1132** ring. Replacement o-ring for **310-1132** is **355-5507**.

▼ **Related Parts** ▼

Hub Cap w/ Gasket**	Gasket Number**
343-4025	330-3025
340-4031	330-3031

Must be ordered as 383-8139 to receive 310-1132 ring

Very Important. These seal sets must be installed with the tools listed in this catalog.

Hub caps sold separately.

NOTE: Use 555 series Tool Heads with Universal Axle Tool body 555-0001 (installs axle/deflector rings).

NOTE: Use 551 series tools with new Universal Hub Tool Handle 551-0001 (installs 320 series Voyager® and Discover® seals).

* Not available with pipe plug.

** For hub cap with pipe plug use 343-prefix.

 Discontinued

Voyager® & Discover® Hub-Seals

VOYAGER - FRONT AXLE 383-0153

Bore Diameter	5.375
Bearings and Tool Combination:	
Inner Bearing Cup/Cone	632/641
Outer Bearing Cup/Cone	3920/3979
Bearing Guide	570-0020
Bearings and Tool Combination:	
Inner Bearing Cup/Cone	H715311/H715345
Outer Bearing Cup/Cone	3920/3979
Bearing Guide	570-0021
Bearings and Tool Combination:	
Inner Bearing Cup/Cone	HM212011/HM212049
Outer Bearing Cup/Cone	28622/28682
Bearing Guide	570-0020
Width	0.820
Fleet Hub Tool	551-5419
Install Handle/Body	551-0001
Guardian® Equiv.	308-0853
Standard Set Equiv.	382-8053
Remarks: Use Hub tool with 551-5349 with 382-8053 .	

Related Parts

Hub Cap w/ Gasket**	Gasket Number**
340-4046	330-3009
340-4249	330-3122
340-4095	330-3009

VOYAGER - FRONT AXLE 383-0156

Bore Diameter	5.875
Inner Bearing Cup/Cone	H715311/H715345, 632/641
Outer Bearing Cup/Cone	552A/555S, 28622/28682
Bearing Guide	570-0021
Spindle Shoulder O.D.	4.500
Width	0.988
Fleet Hub Tool	551-5344
Install Handle/Body	551-0001
Guardian® Equiv.	308-0856
Standard Set Equiv.	382-8056 ☒
Remarks: Use 308-0855 for FA109 1979 & up Spoke wheel number 454593-C2. 308-0855 must be used with hydraulic brakes after '75. FA-109 comes with hydraulic brakes.	

Related Parts

Hub Cap w/ Gasket**	Gasket Number**
340-4046	330-3009
340-4249	330-3122
340-4095	330-3009

VOYAGER & DISCOVER - FRONT AXLE 383-0164 383-0264

Bore Diameter	5.903
Inner Bearing Cup/Cone	6420/6461A
Outer Bearing Cup/Cone	552A/555S, 3979/3920
Fleet Hub Tool	551-5327
Bearing Guide	570-0022
Spindle Shoulder O.D.	4.375
Width	1.03
Install Handle/Body	551-0001
Guardian® Equiv.	308-0864
Standard Set Equiv.	382-8064
Remarks: Mack	

Related Parts

Hub Cap w/ Gasket**	Gasket Number**
340-4249	330-3122
340-4046	330-3042
340-4049	330-3042
343-4249	330-3122
340-4066	330-3041
340-4095	330-3009
340-4149	330-3097
340-4098	330-3009

VOYAGER - FRONT AXLE 383-0166

Bore Diameter	3.875
Bearings and Tool Combination:	
Inner Bearing Cup/Cone	JM207010/JM207049A/
Outer Bearing Cup/Cone	25820/25877
Bearing Guide	570-0036
Bearings and Tool Combination:	
Inner Bearing Cup/Cone	JM205110/JM205149A
Outer Bearing Cup/Cone	25820/25877
Bearing Guide	570-0033
Spindle Shoulder O.D.	2.875
Width	0.750
Fleet Hub Tool	551-5423
Install Handle/Body	551-0001
Guardian® Equiv.	308-0866
Standard Set Equiv.	382-8066 ☒
Remarks: Use Hub tool 551-5366 with 382-8066	

Related Parts

Hub Cap w/ Gasket**	Gasket Number**
340-4065	330-3040

VOYAGER - FRONT AXLE 383-0171

Bore Diameter	5.000
Inner Bearing Cup/Cone	HM212011/HM212047
Outer Bearing Cup/Cone	45220/45282
Fleet Hub Tool	551-5403
Bearing Guide	570-0019
Spindle Shoulder O.D.	3.625
Width	0.820
Install Handle/Body	551-0001
Standard Set Equiv.	382-8071 ☒
Remarks: GMC F-120, F-120D axles, 1985 Up. With 5" seal bore.	

Related Parts

Hub Cap w/ Gasket**	Gasket Number**
340-4042	330-3041
340-4066	330-3041

VOYAGER - FRONT AXLE 383-0175

Bore Diameter	3.939
Inner Bearing Cup/Cone	JM205149
Outer Bearing Cup/Cone	32207
Tool Head	551-5417
Bearing Guide	570-0033
Spindle Shoulder O.D.	2.359
Width	0.500
Install Handle/Body	551-0001
Remarks: GMC Topkick	

VOYAGER - FRONT AXLE 383-0176

Bore Diameter	4.725
Inner Bearing Cup/Cone	33212
Outer Bearing Cup/Cone	33208
Tool Head	551-5418
Bearing Guide	570-0031
Spindle Shoulder O.D.	2.948
Width	0.5629
Install Handle/Body	551-0001
Remarks: GMC Topkick	

Standard Hub-Seal Sets

STANDARD - STEER AXLE 382-8001



Axle Ring	310-1013
Oil Seal	320-2086
<i>Bore Diameter</i>	5.625
Bearings and Tool Combination:	
Inner Bearing Cup/Cone	6320/6386 or 6389
Outer Bearing Cup/Cone	552A/557S
Bearing Guide	570-0020
Univ. Axle Tool Head	555-5060
Bearings and Tool Combination:	
Inner Bearing Cup/Cone	6320/6379
Outer Bearing Cup/Cone	552A/557S
Univ. Axle Tool Head	555-5014
Fleet Hub Tool	551-5311
Install Handle/Body	555-0001 & 551-0001
Remarks: Discontinued. Replaced by 383-0101	

Related Parts

Hub Cap w/ Gasket**	Gasket Number**
343-4080	330-3060

For Voyager® Seal No. 383-0101, 5.625" Bore, See Pg. 30

STANDARD - STEER AXLE 382-8005

Axle Ring	310-1061 
Oil Seal	320-2056 
<i>Bore Diameter</i>	3.671
Inner Bearing Cup/Cone	3720/3778
Outer Bearing Cup/Cone	25820/25877, 2720/2790
Universal Axle Tool Head	555-5001
Fleet Hub Tool	551-5302
Installation Handle/Body	555-0001 & 551-0001

Remarks: Oil Seal **320-2056** installs in bearing cup bore.

NOTE: Use 555 series Tool Heads with Universal Axle Tool body 555-0001 (installs axle/deflector rings).

NOTE: Use 551 series tools with new Universal Hub Tool Handle 551-0001 (installs 320 series Voyager® and Discover® seals).

* Not available with pipe plug.

** For hub cap with pipe plug use 343-prefix.

 Discontinued

STANDARD - STEER AXLE 382-8009



Axle Ring	310-1052 
Oil Seal	320-2050 
<i>Bore Diameter</i>	4.125
Inner Bearing Cup/Cone	45220/45284, 45220/45285
Outer Bearing Cup/Cone	2720/2786, 2720/2793, 2720/2796
Universal Axle Tool Head	555-5036
Fleet Hub Tool	551-5347
Install Handle/Body	555-0001 & 551-0001

Remarks: Axle ring must extend 1/16" over bearing cone. Oil seal **320-2050** installs in bearing cup bore.

Related Parts

Hub Cap w/ Gasket**	Gasket Number**
340-4198	330-3119

STANDARD - STEER AXLE 382-8010

Axle Ring	310-1050 
Oil Seal	320-2022 
<i>Bore Diameter</i>	4.500
Inner Bearing Cup/Cone	4536/4595, 39520/39578
Outer Bearing Cup/Cone	414A/418, 25520/25572
Universal Axle Tool Head	NONE
Fleet Hub Tool	551-5381
Install Handle/Body	555-0001 & 551-0001

Remarks: Includes O-ring **355-5505**. With 2.5" inner bearing journal, June, '71 up, use **382-8062** set.

Related Parts

Hub Cap w/ Gasket**	Gasket Number**
343-4025	330-3025

STANDARD - STEER AXLE 382-8011



Axle Ring	310-1051
Oil Seal	320-2031
<i>Bore Diameter</i>	5.000
Inner Bearing Cup/Cone	552A/559, 3920/3982
Outer Bearing Cup/Cone	552/526, 3820/3877
Universal Axle Tool Head	NONE
Fleet Hub Tool	551-5388
Install Handle/Body	555-0001 & 551-0001
Bearing Guide	570-0019

Remarks: Includes O-ring **355-5506**.

Related Parts

Hub Cap w/ Gasket**	Gasket Number**
340-4025	330-3025
340-4031	330-3031

STANDARD - STEER AXLE 382-8017

Axle Ring	310-1017 
Oil Seal	320-2017 
<i>Bore Diameter</i>	4.437
Inner Bearing Cup/Cone	39520/39581
Outer Bearing Cup/Cone	26820/26878
Universal Axle Tool Head	555-5062
Fleet Hub Tool	551-5352
Install Handle/Body	555-0001 & 551-0001
Bearing Guide	570-0017

Remarks: Oil Seal **320-2017** installs in bearing cup bore.

Related Parts

Hub Cap w/ Gasket**	Gasket Number**
340-4042	330-3041
340-4066	330-3041

Standard Hub-Seal Sets

STANDARD - STEER AXLE 382-8027

Axle Ring	310-1036
Oil Seal	320-2119
<i>Bore Diameter</i>	4.450
Inner Bearing Cup/Cone	39520/39581
Outer Bearing Cup/Cone	3525/3585
Universal Axle Tool Head	555-5062
Fleet Hub Tool	551-5353
Install Handle/Body	555-0001 & 551-0001
Bearing Guide	570-0017

Remarks: Ford 9000# axle, Code N (FD-900), with 15x3 or 15x3.5 wedge brakes. With other brakes, use **382-8036** set (4.842" seal bore).

Related Parts	
Hub Cap w/ Gasket**	Gasket Number **
340-4024	330-3024

STANDARD - STEER AXLE 382-8028

Axle Ring	310-1028
Oil Seal	320-2028
<i>Bore Diameter</i>	6.375
Inner Bearing Cup/Cone	752/756A
Outer Bearing Cup/Cone	HM212011/ HM212046, HM212011/ HM212047
Universal Axle Tool Head	555-5067
Fleet Hub Tool	551-5385
Install Handle/Body	555-0001 & 551-0001

Remarks: Ford axle code F. 1970 and up, use **382-8045** set.

Related Parts	
Hub Cap w/ Gasket**	Gasket Number **
340-4036	330-3035
340-4046	330-3009
340-4095	330-3009
343-4092	330-3025

STANDARD - STEER AXLE 382-8032

Axle Ring	310-1032
Oil Seal	320-2032
<i>Bore Diameter</i>	5.000
Inner Bearing Cup/Cone	HM212011/ HM212049
Outer Bearing Cup/Cone	3720/3782
Universal Axle Tool Head	NONE
Fleet Hub Tool	551-5388
Install Handle/Body	555-0001 & 551-0001
Bearing Guide	570-0020

Remarks: Includes O-ring **355-5507**.

Related Parts	
Hub Cap w/ Gasket**	Gasket Number **
340-4024	330-3024
343-4034	330-3034

STANDARD - STEER AXLE 382-8034

Axle Ring	310-1034
Oil Seal	320-2034
<i>Bore Diameter</i>	4.812
Inner Bearing Cup/Cone	HM212011/ HM212047
Outer Bearing Cup/Cone	37820/3779, 45220/45282
Universal Axle Tool Head	555-5066
Fleet Hub Tool	551-5387
Install Handle/Body	555-0001 & 551-0001
Bearing Guide	570-0019

Remarks: Oil seal **320-2034** installs in bearing cup bore. GMC F-120 before 1985. See **382-8071** for later models.

Related Parts	
Hub Cap w/ Gasket**	Gasket Number **
340-4042	330-3041
340-4066	330-3041

STANDARD - STEER AXLE 382-8036

Axle Ring	310-1036
Oil Seal	320-2036
<i>Bore Diameter</i>	4.840
Bearings and Tool Combination:	
Inner Bearing Cup/Cone	39520/39581
Outer Bearing Cup/Cone	3525/3585
Univ. Axle Tool Head	555-5062
Bearing Guide	570-0017

Bearings and Tool Combination:	
Inner Bearing Cup/Cone	HM212011/ HM212044 (533X/557A PRE 1959)
Outer Bearing Cup/Cone	3720/3782
Univ. Axle Tool Head	555-5061
Bearing Guide	570-0018

Bearings and Tool Combination:	
Inner Bearing Cup/Cone	HM212011/ HM212049 HM212011/HM212049X-X1
Outer Bearing Cup/Cone	3720/3782
Univ. Axle Tool Head	555-5098
Bearing Guide	570-0020

Bearings and Tool Combination:	
Inner Bearing Cup/Cone	HM212011/HM212047
Outer Bearing Cup/Cone	3720/3782
Univ. Axle Tool Head	555-5066
Bearing Guide	570-0019

Fleet Hub Tool 551-5346
Install Handle/Body 555-0001 & 551-0001

Remarks: 9000# axle, 15x3 or 15x3.5 wedge brakes use **382-8027** set. GMC only (FE-900), prior to 1960, use **310-1036** and **320-2031**.

Related Parts	
Hub Cap w/ Gasket**	Gasket Number **
340-4009	330-3009
340-4024	330-3024
340-4095	330-3009
340-4028	330-3028
340-4186	330-3028
340-4042	330-3041
340-4249	330-3122
340-4066	330-3041
340-4034	330-3034
340-4149	330-3097

For Guardian® Seal No. 308-0836, 4.840" Bore, See Pg. 26
For Voyager® Seal No. 383-0136, 4.840" Bore, See Pg. 30
For Discover® Seal No. 383-0236, 4.840" Bore, See Pg. 30

Standard Hub-Seal Sets

STANDARD - STEER AXLE
382-8039 

Axle Ring	310-1038
Oil Seal	320-2039
<i>Bore Diameter</i>	5.125
Inner Bearing Cup/Cone	663/641, HM212011/ HM212049
Outer Bearing Cup/Cone	65320/65385, 45220/45280
Universal Axle Tool Head	NONE
Fleet Hub Tool	551-5395
Install Handle/Body	555-0001 & 551-0001
Bearing Guide	570-0029
Remarks:	Discontinued. Use 838-1039 or 383-0239 instead.

▼ Related Parts ▼

Hub Cap w/ Gasket**	Gasket Number**
343-4025	330-3025
340-4031	330-3031

For Voyager® Seal No. 383-0139, 5.120" Bore, See Pg. 30
For Discover® Seal No. 383-0239, 5.120" Bore, See Pg. 30

STANDARD - STEER AXLE
382-8044

Axle Ring	310-1008
Oil Seal	320-2105 
<i>Bore Diameter</i>	4.175
Inner Bearing Cup/Cone	45220/45284
Outer Bearing Cup/Cone	2720/2780, 25820/25880
Universal Axle Tool Head	555-5064
Fleet Hub Tool	551-5351
Install Handle/Body	555-0001 & 551-0001
Remarks	N/A

▼ Related Parts ▼

Hub Cap w/ Gasket**	Gasket Number**
340-4065	330-3040

NOTE: Use 555 series Tool Heads with Universal Axle Tool body 555-0001 (installs axle/deflector rings).

NOTE: Use 551 series tools with new Universal Hub Tool Handle 551-0001 (installs 320 series Voyager® and Discover® seals).

* Not available with pipe plug.

** For hub cap with pipe plug use 343-prefix.

 Discontinued

STANDARD - STEER AXLE
382-8045

Axle Ring	310-1028 
Oil Seal	320-2041
<i>Bore Diameter</i>	6.437
Inner Bearing Cup/Cone	752/756A
Outer Bearing Cup/Cone	HM212011/ HM212046, HM212011/ HM212047
Universal Axle Tool Head	555-5067
Fleet Hub Tool	551-5398
Install Handle/Body	555-0001 & 551-0001
Remarks	N/A

▼ Related Parts ▼

Hub Cap w/ Gasket**	Gasket Number**
340-4036	330-3035
340-4046	330-3009
340-4095	330-3009
340-4092	330-3025

STANDARD - STEER AXLE
382-8052

Axle Ring	310-1009 
Oil Seal	320-2181
<i>Bore Diameter</i>	5.372
Inner Bearing Cup/Cone	6320/6386A, 5735/5760
Outer Bearing Cup/Cone	532A/537, 39520/39590
Universal Axle Tool Head	555-5060
Fleet Hub Tool	551-5349
Install Handle/Body	555-0001 & 551-0001
Bearing Guide	570-0020
Remarks:	Axle ring 310-1009 includes machined shoulder bushing 364-6414 . This shoulder bushing is reusable if not removed or damaged. Service with 382-8053 or 308-0853 .

▼ Related Parts ▼

Hub Cap w/ Gasket**	Gasket Number**
340-4066	330-3041
343-4099	330-3080

STANDARD - STEER AXLE
382-8053 

Axle Ring	310-1093
Oil Seal	320-2181
<i>Bore Diameter</i>	5.372
Bearings and Tool Combination:	
Inner Bearing Cup/Cone	632/641
Outer Bearing Cup/Cone	3920/3979
Univ. Axle Tool Head	555-5060
Bearing Guide	570-0020
Bearings and Tool Combination:	
Inner Bearing Cup/Cone	H715311/ H715345
Outer Bearing Cup/Cone	3920/3979
Univ. Axle Tool Head	555-5070
Bearing Guide	570-0021
Bearings and Tool Combination:	
Inner Bearing Cup/Cone	HM212011/ HM212049
Outer Bearing Cup/Cone	28622/28682
Univ. Axle Tool Head	555-5060
Bearing Guide	570-0020
Fleet Hub Tool	551-5349
Install Handle/Body	555-0001 & 551-0001
Remarks:	Discontinued. Replace with 308-0853 or 383-0153

▼ Related Parts ▼

Hub Cap w/ Gasket**	Gasket Number**
340-4046	330-3009
340-4249	330-3122
340-4095	330-3009

For Guardian® Seal No. 308-0853, 5.372" Bore, See Pg. 26
For Voyager® Seal No. 383-0153, 5.375" Bore, See Pg. 30

STANDARD - STEER AXLE
382-8056 

Axle Ring	310-1093
Oil Seal	320-2199
<i>Bore Diameter</i>	5.875
Inner Bearing Cup/Cone	H715311/H715345, 632/641
Outer Bearing Cup/Cone	552A/555S, 28622/28682
Univ. Axle Tool Head	555-5070
Fleet Hub Tool	551-5344
Install Handle/Body	555-0001 & 551-0001
Bearing Guide	570-0021
Remarks:	Discontinued. Replace with 308-0856 or 383-0156

▼ Related Parts ▼

Hub Cap w/ Gasket**	Gasket Number**
340-4046	330-3009
340-4249	330-3122
340-4095	330-3009

For Guardian® Seal No. 308-0856, See Pg. 26
For Voyager® Seal No. 383-0156, See Pg. 30

Standard Hub-Seal Sets

STANDARD - STEER AXLE 382-8060

Axle Ring	310-1041
Oil Seal <i>Bore Diameter</i>	320-2023 6.008
Inner Bearing Cup/Cone	5735/5760, 6420/6461
Outer Bearing Cup/Cone	45220/45287, 612/621
Universal Axle Tool Head	NONE
Fleet Hub Tool	551-5401
Install Handle/Body	555-0001 & 551-0001
Bearing Guide	570-0022
Remarks:	Includes O-ring 355-5510

Related Parts

Hub Cap w/ Gasket**	Gasket Number**
343-4025	330-3025

STANDARD - STEER AXLE 382-8062

Axle Ring	310-1051
Oil Seal <i>Bore Diameter</i>	320-2125 4.437
Inner Bearing Cup/Cone	39520/39585
Outer Bearing Cup/Cone	22520/25572
Universal Axle Tool Head	NONE
Fleet Hub Tool	551-5388
Install Handle/Body	555-0001 & 551-0001
Bearing Guide	570-0019
Remarks:	Includes O-ring 355-5506 . Oil seal 320-2125 installs in bearing cup bore. Prior to June 1971, use 382-8010 set.

Related Parts

Hub Cap w/ Gasket**	Gasket Number**
343-4025	330-3025

STANDARD - STEER AXLE 382-8063

Axle Ring	310-1036
Oil Seal <i>Bore Diameter</i>	320-2133 4.542
Bearings and Tool Combination:	
Remarks:	Ford 9000# 1975-84
Inner Bearing Cup/Cone	39520/39581
Outer Bearing Cup/Cone	3525/3585
Univ. Axle Tool Head	555-5062
Bearing Guide	570-0017
Bearings and Tool Combination:	
Remarks:	Ford 9000# 1984 up
Inner Bearing Cup/Cone	45220/45284
Outer Bearing Cup/Cone	25820/25880
Univ. Axle Tool Head	555-5064
Bearing Guide	N/A
Fleet Hub Tool	551-5353
Install Handle/Body	555-0001 & 551-0001

Related Parts

Hub Cap w/ Gasket**	Gasket Number**
340-4186	330-3120

For Guardian® Seal No. 308-0863, See Pg. 26

STANDARD - STEER AXLE 382-8064

Axle Ring	310-1037
Oil Seal <i>Bore Diameter</i>	320-2137 5.903
Inner Bearing Cup/Cone	6420/6461A
Outer Bearing Cup/Cone	552A/555S, 3979/3920
Univ. Axle Tool Head	555-5007
Fleet Hub Tool	551-5327
Install Handle/Body	555-0001 & 551-0001
Bearing Guide	570-0022
Remarks:	Mack

Related Parts

Hub Cap w/ Gasket**	Gasket Number**
340-4249	330-3122
340-4046	330-3009
340-4049	330-3042
343-4249	330-3122
340-4066	330-3041
340-4095	330-3009
340-4149	330-3097
340-4098	330-3009

For Guardian® Seal No. 308-0864, 5.903" Bore, See Pg. 26
For Voyager® Seal No. 383-0164, 5.903" Bore, See Pg. 30
For Discover® Seal No. 383-0264, 5.903" Bore, See Pg. 30

STANDARD - STEER AXLE 382-8066

Axle Ring	310-1008
Oil Seal <i>Bore Diameter</i>	320-2164 3.875
Bearings and Tool Combination:	
Inner Bearing Cup/Cone	JM207010/ JM207049A
Outer Bearing Cup/Cone	25820/25877
Univ. Axle Tool Head	555-5088
Fleet Hub Tool	551-5366
Bearing Guide	570-0036
Bearings and Tool Combination:	
Inner Bearing Cup/Cone	JM207010/ JM207049A
Outer Bearing Cup/Cone	25820/25877
Univ. Axle Tool Head	555-5089
Bearing Guide	570-0033
Install Handle/Body	555-0001 & 551-0001
Remarks	N/A

Related Parts

Hub Cap w/ Gasket**	Gasket Number**
340-4065	330-3040

For Guardian® Seal No. 308-0866, 3.875" Bore, See Pg. 26
For Voyager® Seal No. 383-0166, See Pg. 30

STANDARD - STEER AXLE 382-8071

Axle Ring	310-1034
Oil Seal <i>Bore Diameter</i>	320-2216 5.000
Inner Bearing Cup/Cone	HM212011/ HM212047
Outer Bearing Cup/Cone	45220/45282
Universal Axle Tool Head	555-5066
Fleet Hub Tool	551-5403
Install Handle/Body	555-0001 & 551-0001
Bearing Guide	570-0019
Remarks:	Discontinued. Replace with 383-0171

Related Parts

Hub Cap w/ Gasket**	Gasket Number**
340-4042	330-3041
340-4066	330-3041

For Voyager® Seal No. 383-0171, 5.000" Bore, See Pg. 26

Seal Sets
Front Axles

Component
Specs

Installation
Tools

Axle
Fasteners

Long-Life
Systems

Cross
Reference

Installation
Instructions

Guardian® & Guardian® HP Hub-Seal Sets

GUARDIAN HP - DRIVE AXLE

309-0903

Bore Diameter	5.750
Inner Bearing Cup/Cone	572/580, 572/582
Outer Bearing Cup/Cone	563/567
Spindle Shoulder O.D.	4.5
Width	0.516
Universal Axle Tool Head	555-5072
Install Handle/Body	555-0001
Grit Guard® Equiv.	392-9094
Voyager® Equiv.	393-0103
Discover® Equiv.	393-0203

Remarks: Mack Western 11QJA-191, -192 hub and drum assembly, or Motor Wheel 87125 hub or 87119-B or 87226-F hub and drum assembly with 582 inner cone must use OEM bearing spacer 35AX-1411.

Install OEM spacer before installing axle ring. Press axle on until flush with bearing side of bearing spacer.

GUARDIAN - DRIVE AXLE

309-0904

Bore Diameter	6.250
Bearings and Tool Combination:	
Inner Bearing Cup/Cone	652/663 HM516410/ HM516449,-C
Outer Bearing Cup/Cone	572/575 47620/47679
Univ. Axle Tool Head	555-5072
Grit Guard® Equiv.	392-9112

Bearings and Tool Combination:

Inner Bearing Cup/Cone	HM516410/ HM516449A
Outer Bearing Cup/Cone	47620/47679
Univ. Axle Tool Head	555-5073
Grit Guard® Equiv.	392-9130

Spindle Shoulder O.D.	4.25
Width	0.548
Install Handle/Body	555-0001
Voyager® Equiv.	393-0104
Discover® Equiv.	393-0204

Remarks: Use OEM bearing spacer 35AX790 or 35AX1411.

Use Grit Guard set **392-9130** with inner bearing HM516449A.

Use **309-0904** only with ABS Brakes. Ref.: Tech Tip 15.

GUARDIAN - DRIVE AXLE

309-0912

Bore Diameter	5.690
Bearings and Tool Combination:	
Inner Bearing Cup/Cone	47620/47685 47620/47686
Outer Bearing Cup/Cone	39520/39590
Univ. Axle Tool Head	555-5031
Bearings and Tool Combination:	
Inner Bearing Cup/Cone	47620/47678 5735/5760
Outer Bearing Cup/Cone	39520/39590 572/575
Univ. Axle Tool Head	555-5074
Spindle Shoulder O.D.	3.875
Width	0.555
Install Handle/Body	555-0001
Grit Guard® Equiv.	392-9099
Voyager® Equiv.	393-0112
Discover® Equiv.	393-0212

Remarks: Do not use OEM oil seal spacer ring. Use with 5.687" bore only. Will not replace **320-2102** on GMC-Chev.

For GMC/Chev. with 5.500" bore, use **309-0915**.
For Navistar w/ 39585 outer cone, use **392-9099**.

GUARDIAN - DRIVE AXLE

309-0915

Bore Diameter	5.500
Inner Bearing Cup/Cone	47620/47686
Outer Bearing Cup/Cone	39520/39590
Spindle Shoulder O.D.	3.875
Width	0.736
Univ. Axle Tool Head	555-5031
Install Handle/Body	555-0001
Grit Guard® Equiv.	392-9099
Voyager® Equiv.	393-0115

Remarks: Do not use OEM oil seal spacer ring. Use with 5.500" bore only. GMC.

GUARDIAN - DRIVE AXLE

309-0935

Bore Diameter	4.750
Bearings and Tool Combination:	
Inner Bearing Cup/Cone	33462/33287 1962 up
Outer Bearing Cup/Cone	3920/3982
Univ. Axle Tool Head	555-5011
Bearings and Tool Combination:	
Inner Bearing Cup/Cone	33462/33281 thru 1961
Outer Bearing Cup/Cone	3929/3982
Univ. Axle Tool Head	555-5002
Spindle Shoulder O.D.	3.437
Width	0.541
Install Handle/Body	555-0001
Grit Guard® Equiv.	392-9035

GUARDIAN - DRIVE AXLE

309-0948

Bore Diameter	7.3750 Only
Bearings and Tool Combination:	
Inner Bearing Cup/Cone	672/687
Outer Bearing Cup/Cone	772/780 52618/52400
Bearings and Tool Combination:	
Inner Bearing Cup/Cone	772/780
Outer Bearing Cup/Cone	772/776 77675/77375 854/864
Spindle Shoulder O.D.	5.250
Width	0.7350
Univ. Axle Tool Head	555-5004
Install Handle/Body	555-0001
Grit Guard® Equiv.	392-9089
Voyager® Equiv.	393-0148

Remarks: **309-0048** and **392-9089** will not fit S582 or S652 after June, 1998

Only use **393-0148** on these axles after June, 1998.

GUARDIAN - DRIVE AXLE

309-0957

Bore Diameter	5.500
Bearings and Tool Combination:	
Remarks	Ford 1970 Up. Thru 1969 use 392-9018 .
Inner Bearing Cup/Cone	493/495AX
Outer Bearing Cup/Cone	39520/39590
Univ. Axle Tool Head	555-5074

Bearings and Tool Combination:

Remarks	GMC 1982 Up. Thru 1981 use 392-9018 .
Inner Bearing Cup/Cone	33462/33287
Outer Bearing Cup/Cone	3920/3982
Univ. Axle Tool Head	555-5011

Spindle Shoulder O.D.	3.937
Width	0.745
Install Handle/Body	555-0001

Very Important. These seal sets must be installed with the tools listed in this catalog.

NOTE: Use 555 series Tool Heads with Universal Axle Tool body 555-0001 (installs axle/deflector rings).

Guardian® & Guardian® HP Hub-Seal Sets

GUARDIAN - DRIVE AXLE 309-0960

Bore Diameter	6.251
Bearings and Tool Combination:	
Remarks	GMC - Some Alum. hubs use 309-0973 seal.
Inner Bearing Cup/Cone	592A/598A
Outer Bearing Cup/Cone	572/580, 572/582
Tool Head	555-5071
Grit Guard® Equiv.	392-9132
Bearings and Tool Combination:	
Remarks	GMC - Some Alum. hubs use 309-0973 seal.
Inner Bearing Cup/Cone	592A/594A
Outer Bearing Cup/Cone	572/580, 572/582
Univ. Axle Tool Head	555-5076
Grit Guard® Equiv.	392-9132
Bearings and Tool Combination:	
Remarks	Mack application
Inner Bearing Cup/Cone	592A/598A
Outer Bearing Cup/Cone	HM617010/ HM617049
Univ. Axle Tool Head	555-5071
Grit Guard® Equiv.	392-9081 (Standard)
Spindle Shoulder O.D.	4.767
Width	0.668
Install Handle/Body	555-0001

GUARDIAN HP - DRIVE AXLE 309-0961

Bore Diameter	6.064
Inner Bearing Cup/Cone	572/580 572/582 653/663A
Outer Bearing Cup/Cone	47620/42687 47620/42688
Spindle Shoulder O.D.	4.262
Width	0.562
Univ. Axle Tool Head	555-5072
Install Handle/Body	555-0001
Grit Guard® Equiv.	392-9095
Remarks	None

GUARDIAN HP - DRIVE AXLE 309-0964

Bore Diameter	6.250
Inner Bearing Cup/Cone	592A/594 592A/594A
Outer Bearing Cup/Cone	572/580
Spindle Shoulder O.D.	4.500
Width	0.600
Univ. Axle Tool Head	555-5076
Install Handle/Body	555-0001
Grit Guard® Equiv.	392-9088
Remarks	None

GUARDIAN HP - DRIVE AXLE 309-0965

Bore Diameter	6.250
Bearings and Tool Combination:	
Inner Bearing Cup/Cone	592A/595
Outer Bearing Cup/Cone	572/580
Tool Head	555-5072
Grit Guard® Equiv.	392-9096
Bearings and Tool Combination:	
Inner Bearing Cup/Cone	592A/598
Outer Bearing Cup/Cone	572/575
Univ. Axle Tool Head	555-5071
Grit Guard® Equiv.	392-9096
Bearings and Tool Combination:	
Inner Bearing Cup/Cone	592A/598
Outer Bearing Cup/Cone	752/758, 653/665 HM617010/HM617049
Univ. Axle Tool Head	555-5071
Grit Guard® Equiv.	392-9092
Spindle Shoulder O.D.	4.375
Width	0.600
Install Handle/Body	555-0001
Remarks: On Eaton 42D, replace OEM bearing spacer with 357-5706 if damaged. Dimensions: OD 4.375, ID 4.150, width .688	

GUARDIAN - DRIVE AXLE 309-0970

Bore Diameter	7.000
Bearings and Tool Combination:	
Inner Bearing Cup/Cone	672/681A
Outer Bearing Cup/Cone	572/575, 572/580
Univ. Axle Tool Head	555-5071
Grit Guard® Equiv.	392-9087
Bearings and Tool Combination:	
Inner Bearing Cup/Cone	672/683 672/683XA
Outer Bearing Cup/Cone	572/580
Univ. Axle Tool Head	555-5076
Spindle Shoulder O.D.	4.767
Width	1.175
Install Handle/Body	555-0001
Remarks: Some axles may require bushings. Shoulders with 4.375" diameter use 364-6402 bushing. Shoulders with 4.5" diameter use 364-6435 bushing. If axle has factory installed shoulder bushing, leave it in place and reuse if not damaged.	

GUARDIAN HP - DRIVE AXLE 309-0973

Bore Diameter	6.310
Bearings and Tool Combination:	
Inner Bearing Cup/Cone	592A/598A
Outer Bearing Cup/Cone	572/580
Tool Head	555-5071
Bearings and Tool Combination:	
Inner Bearing Cup/Cone	592A/598
Outer Bearing Cup/Cone	572/575
Univ. Axle Tool Head	555-5071
Bearings and Tool Combination:	
Inner Bearing Cup/Cone	592A/594
Outer Bearing Cup/Cone	572/580
Univ. Axle Tool Head	555-5076
Bearings and Tool Combination:	
Inner Bearing Cup/Cone	592A/594A
Outer Bearing Cup/Cone	572/580
Univ. Axle Tool Head	555-5076
Spindle Shoulder O.D.	4.767
Width	0.91
Install Handle/Body	555-0001
Grit Guard® Equiv.	392-9131
Voyager® Equiv.	393-0173
Discover® Equiv.	393-0273

Remarks: Will not work on Freightliner with Wagner Anti-Skid or Motorola 22-14670-14 Electronic Speedometers. Use **320-2106** and **310-1111**.

Special note for Dodge, Freightliner, Kenworth and Peterbilt using this set on Eaton axles w/ Meritor hubs or wheels: Eaton 18 series single or 38D tandem with 4.375 spindle shoulder require shoulder bushing **364-6402** to be installed before axle ring. Eaton 19 series single or 44D tandem with 4.500 spindle shoulder require shoulder bushing **364-6435** be to installed before axle ring. Shoulder bushings and axle rings must be installed flush with spindle shoulder face. Shoulder bushings are not part of set and must be ordered separately. If axle has factory installed shoulder bushing, leave it in place and reuse if not damaged. Shoulder bushings are not required on Eaton axles if shoulder is already machined to 4.767. For wheel ends using 681A to 4.767. X bearing refer to **392-9087** set. Hub cap **340-4119** and gasket **330-3090** available for tag and pusher use. **364-6402** OD 4.776, ID 4.369, Width .980 **364-6435** OD 4.767, ID 4.500, Width .950.

Voyager® & Discover® Hub-Seals

VOYAGER & DISCOVER - DRIVE AXLE

393-0103
393-0203

Bore Diameter	5.750
Inner Bearing Cup/Cone	572/580, 572/582
Outer Bearing Cup/Cone	563/567
Spindle Shoulder O.D.	4.500
Width	1.003
Fleet Hub Tool	551-5415
Install Handle/Body	551-0001
Bearing Guide	570-0023
Guardian® Equiv.	309-0903
Grit Guard® Equiv.	392-9094

Remarks: Mack Western 11QJA-191, -192 hub and drum assembly or motor wheel 87125 hub or 87119-B or 87226-F hub and drum assembly with 582 inner cone must use OEM bearing spacer 35AX-1411.

Related Parts

Discover® Wheel Seal 393-0203

VOYAGER & DISCOVER - DRIVE AXLE

393-0104
393-0204

Bore Diameter	6.250
Inner Bearing Cup/Cone	652/663, HM516410/ HM516449,-C
Outer Bearing Cup/Cone	572/575, 47620/47679
Spindle Shoulder O.D.	4.250
Width	1.290
Fleet Hub Tool	551-5414
Install Handle/Body	551-0001
Bearing Guide	570-0023
Guardian® Equiv.	309-0904
Grit Guard® Equiv.	392-9112

Remarks: Mack application, use OEM bearing spacer, #35AX790 or 35AX1411. Note: For cast axle housing only. With HM516449A see **392-9130** set.

Related Parts

Discover® Wheel Seal 393-0204

VOYAGER & DISCOVER - DRIVE AXLE

393-0112
393-0212

Bore Diameter	5.690
Bearings and Tool Combination:	
Inner Bearing Cup/Cone	47620/47685
Bearings and Tool Combination:	
Inner Bearing Cup/Cone	47620/47686 47620/47678 5735/5760
Outer Bearing Cup/Cone	39520/39590 39520/39585 572/575
Bearing Guide	570-0023 570-0022
Spindle Shoulder O.D.	3.875
Width	0.820
Fleet Hub Tool	551-5416
Install Handle/Body	551-0001
Guardian® Equiv.	309-0912
Grit Guard® Equiv.	392-9099

Remarks: Not for use with 5.500" bores. See **309-0915**.

Related Parts

Discover® Wheel Seal 393-0212

VOYAGER - DRIVE AXLE

393-0115

Bore Diameter	5.500
Inner Bearing Cup/Cone	47620/47686
Outer Bearing Cup/Cone	39520/39590
Spindle Shoulder O.D.	3.875
Width	0.705
Fleet Hub Tool	551-5424
Install Handle/Body	551-0001
Bearing Guide	570-0023
Guardian® Equiv.	309-0915
Grit Guard® Equiv.	392-9099

Remarks: Do not use OEM oil seal spacer ring. Use with 5.5" bore only. GMC. Use Hub tool **557-5518** with **392-9099**

Voyager® & Discover® Hub-Seals

Seal Sets
Front Axles

Component
Specs

Installation
Tools

Axle
Fasteners

Long-Life
Systems

Cross
Reference

Installation
Instructions

VOYAGER - DRIVE AXLE

393-0134

Bore Diameter	6.000
Bearings and Tool Combination:	
Inner Bearing Cup/Cone	6535/6580
Outer Bearing Cup/Cone	653/663
Bearing Guide	570-0025
Bearings and Tool Combination:	
Inner Bearing Cup/Cone	6535/6559
Outer Bearing Cup/Cone	653/663
Bearing Guide	570-0023
Spindle Shoulder O.D.	4.875
Width	0.790
Fleet Hub Tool	551-5421
Install Handle/Body	551-0001
Grit Guard® Equiv.	392-9034
Remarks	None

VOYAGER - DRIVE AXLE

393-0148

Bore Diameter	7.375
Inner Bearing Cup/Cone	672/687, 772/780
Outer Bearing Cup/Cone	772/780, 52618/52400, 772/776, 776575/77375, 854/864
Spindle Shoulder O.D.	5.250
Width	1.000
Fleet Hub Tool	551-5400
Install Handle/Body	551-0001
Bearing Guide	570-0032
Guardian® Equiv.	309-0948
Grit Guard® Equiv.	392-9089
Remarks	None

Very Important. These seal sets must be installed with the tools listed in this catalog.

NOTE: Use 555 series Tool Heads with Universal Axle Tool body 555-0001 (installs axle/deflector rings).

VOYAGER & DISCOVER - DRIVE AXLE

393-0173

393-0273

Bore Diameter	6.310
Bearings and Tool Combination:	
Inner Bearing Cup/Cone	592A/598A
Outer Bearing Cup/Cone	572/580
Bearing Guide	570-0027
Bearings and Tool Combination:	
Inner Bearing Cup/Cone	592A/598
Outer Bearing Cup/Cone	572/575
Bearing Guide	570-0027
Bearings and Tool Combination:	
Inner Bearing Cup/Cone	592A/594
Outer Bearing Cup/Cone	572/580
Bearing Guide	570-0028
Bearings and Tool Combination:	
Inner Bearing Cup/Cone	592A/594A
Outer Bearing Cup/Cone	572/580
Bearing Guide	570-0028
Spindle Shoulder O.D.	4.767
Width	1.1270
Fleet Hub Tool	551-5320
Install Handle/Body	551-0001
Guardian® Equiv.	309-0973
Grit Guard® Equiv.	392-9131
Remarks: For Dodge, Freightliner, Kenworth and Peterbilt using this set on Eaton axles with Meritor hubs or wheels:	
Eaton 18 series single or 38D tandem with 4.375 spindle shoulder require shoulder bushing 364-6402 to be installed before axle ring.	
Eaton 19 series single or 44D tandem with 4.500 spindle shoulder require shoulder bushing 364-6435 to be installed before axle ring.	
Shoulder bushings and axle rings must be installed flush with spindle shoulder face.	
Shoulder bushings are not part of set and must be ordered separately. If axle has factory installed shoulder bushing, leave it in place and reuse if not damaged.	
Shoulder bushings are not required on Eaton axles if shoulder is already machined to 4.767.	
For wheel ends using 681A inner bearing refer to 392-9087 set.	
Hub cap 340-4119 and gasket 330-3090 available for tag and pusher use.*	
364-6402 - OD 4.776, ID 4.369, Width .980	
364-6435 - OD 4.767, ID 4.500, Width .950.	

▼ **Related Parts** ▼

Discover® Wheel Seal 393-0273

Standard Hub-Seal Sets

STANDARD - DRIVE AXLE 392-9001	
Axle Ring	310-1095
Oil Seal	320-2001
<i>Bore Diameter</i>	6.500
Bearings and Tool Combination:	
Inner Bearing Cup/Cone	752/758
Outer Bearing Cup/Cone	663/665
Univ. Axle Tool Head	555-5069
Bearing Guide	570-0024
Bearings and Tool Combination:	
Inner Bearing Cup/Cone	752/760
Outer Bearing Cup/Cone	742/749
Univ. Axle Tool Head	555-5079
Bearing Guide	570-0026
Spindle Shoulder O.D.	4.875
Width	0.790
Fleet Hub Tool	551-5398
Install Handle/Body	555-0001 & 551-0001
Remarks	None

STANDARD - DRIVE AXLE 392-9007	
Axle Ring	310-1007
Oil Seal	320-2096
<i>Bore Diameter</i>	6.250
Inner Bearing Cup/Cone	652/663, HM516410/HM516449
Outer Bearing Cup/Cone	572/575, 47620/47679
Universal Axle Tool Head	551-5072
Fleet Hub Tool	551-5390
Install Handle/Body	555-0001 & 551-0001
Bearing Guide	570-0023
Remarks:	For steel axle housing only. Cast housings use 310-1088 and 320-2213 .
Related Parts	
Grit Guard® Hub Seal	310-1007

STANDARD - DRIVE AXLE 392-9012	
Axle Ring	310-1012
Oil Seal	320-2012
<i>Bore Diameter</i>	5.690
Bearings and Tool Combination:	
Inner Bearing Cup/Cone	47620/47686
Outer Bearing Cup/Cone	39520/39590
Univ. Axle Tool Head	555-5031
Bearing Guide	570-0023
Bearings and Tool Combination:	
Inner Bearing Cup/Cone	47620/47678 5735/5760
Outer Bearing Cup/Cone	39520/39585 572/575
Univ. Axle Tool Head	555-5074
Bearing Guide	570-0022
Fleet Hub Tool	551-5405
Install Handle/Body	555-0001 & 551-0001
Remarks:	Discontinued. Replaced by 309-9012 and Voyager 393-0112

Related Parts	
Guardian® HP Wheel Seal	309-0912
Voyager® Wheel Seal	393-0112
<small>For Guardian® Seal No. 309-0912, 5.690" Bore, See Pg. 26 For Voyager® Seal No. 393-0112, 5.690" Bore, See Pg. 30</small>	

STANDARD - DRIVE AXLE 392-9018	
Axle Ring	310-1018
Oil Seal	320-2029
<i>Bore Diameter</i>	5.375
Inner Bearing Cup/Cone	493/495AX
Outer Bearing Cup/Cone	3920/3984
Universal Axle Tool Head	555-5074
Fleet Hub Tool	551-5386
Install Handle/Body	555-0001 & 551-0001
Bearing Guide	570-0022
Remarks:	This seal set used on Ford applications thru 1969 and GMC/Chev thru 1981. Ford 1970 & up and GMC 1982 & up use 392-9057 .

STANDARD - DRIVE AXLE 392-9032	
Axle Ring	310-1053
Oil Seal	320-2109
<i>Bore Diameter</i>	5.750
Bearings and Tool Combination:	
Inner Bearing Cup/Cone	572/580
Outer Bearing Cup/Cone	563/567
Univ. Axle Tool Head	555-5072
Bearing Guide	570-0023
Bearings and Tool Combination:	
Inner Bearing Cup/Cone	572/575
Outer Bearing Cup/Cone	572/575
Univ. Axle Tool Head	555-5074
Bearing Guide	570-0022
Fleet Hub Tool	551-5313
Install Handle/Body	555-0001 & 551-0001
Remarks	None

Related Parts	
Grit Guard® Hub Seal	320-2109
Grit Guard® Hub Seal	310-1053

STANDARD - DRIVE AXLE 392-9033	
Axle Ring	310-1093
Oil Seal	320-2058
<i>Bore Diameter</i>	5.500
Bearings and Tool Combination:	
Inner Bearing Cup/Cone	742/749A
Outer Bearing Cup/Cone	653/663
Univ. Axle Tool Head	555-5072
Bearing Guide	570-0023
Bearings and Tool Combination:	
Inner Bearing Cup/Cone	6535/6559
Fleet Hub Tool	551-5303
Install Handle/Body	555-0001 & 551-0001
Remarks:	Gaskets 330-3067 , 330-3065 , 330-3071 , order retainer separately. Match correct gasket to retainer. Axle ring 310-1093 installs over OEM bearing spacer flush with the bearing side. Do not use OEM seal spacer with STEMCO oil seal.

Related Parts	
Grit Guard® Hub Seal	310-1093

Standard Hub-Seals Sets

STANDARD - DRIVE AXLE 392-9034 ❌	
Axle Ring	310-1066
Oil Seal	320-2061
<i>Bore Diameter</i>	6.003
Bearings and Tool Combination:	
Inner Bearing Cup/Cone	6535/6580
Outer Bearing Cup/Cone	653/663
Univ. Axle Tool Head	555-5023
Bearing Guide	570-0025
Bearings and Tool Combination:	
Inner Bearing Cup/Cone	6535/6559
Outer Bearing Cup/Cone	653/663
Univ. Axle Tool Head	555-5072
Bearing Guide	570-0023
Fleet Hub Tool	551-5356
Install Handle/Body	555-0001 & 551-0001
Remarks: Discontinued. Replaced by 329-9034	
▼ Related Parts ▼	

Voyager® Wheel Seal 393-0134
For Voyager® Seal No. 393-0134, See Pg. 30

STANDARD - DRIVE AXLE 392-9035	
Axle Ring	310-1062 ❌
Oil Seal	320-2057 ❌
<i>Bore Diameter</i>	4.625
Bearings and Tool Combination:	
Inner Bearing Cup/Cone	33462/33281 (thru 1961)
Outer Bearing Cup/Cone	3920/3982
Univ. Axle Tool Head	555-5002
Bearings and Tool Combination:	
Inner Bearing Cup/Cone	33462/33287 (1962 and up)
Outer Bearing Cup/Cone	3920/3982
Univ. Axle Tool Head	555-5011
Fleet Hub Tool	551-5353
Install Handle/Body	555-0001 & 551-0001
Remarks: Oil Seal 320-2057 installs in bearing cup bore. The 309-0935 fits in the seal bore (4.750)	
▼ Related Parts ▼	

Guardian® HP Wheel Seal 309-0935
Grit Guard® Hub Seal 310-1062 ❌

For Guardian® Seal No. 309-0935, 4.750" Bore, See Pg. 30

STANDARD - DRIVE AXLE 392-9036	
Axle Ring	310-1063 ❌
Oil Seal	320-2057 ❌
<i>Bore Diameter</i>	4.625
Bearings and Tool Combination:	
Inner Bearing Cup/Cone	33462/33281
Outer Bearing Cup/Cone	39520/39585
Univ. Axle Tool Head	555-5002
Bearings and Tool Combination:	
Inner Bearing Cup/Cone	33462/33287
Univ. Axle Tool Head	555-5011
Fleet Hub Tool	551-5353
Bearing Guide	570-0021
Install Handle/Body	555-0001 & 551-0001
Remarks: Oil Seal 320-2057 installs in bearing cup bore.	
▼ Related Parts ▼	

Grit Guard® Hub Seal 310-1063 ❌

STANDARD - DRIVE AXLE 392-9038	
Axle Ring	310-1064 ❌
Oil Seal	320-2072 ❌
<i>Bore Diameter</i>	4.437
Inner Bearing Cup/Cone	3920/3984
Outer Bearing Cup/Cone	453X/462
Universal Axle Tool Head	555-5097
Fleet Hub Tool	551-5308
Install Handle/Body	555-0001 & 551-0001
Bearing Guide	570-0020
Remarks: Oil Seal 320-2072 installs into bearing cup bore.	
▼ Related Parts ▼	

Grit Guard® Hub Seal 310-1064 ❌

STANDARD - DRIVE AXLE 392-9045	
Axle Ring	<i>See Remarks</i>
Oil Seal	320-2091 ❌
<i>Bore Diameter</i>	5.500
Bearings and Tool Combination:	
Inner Bearing Cup/Cone	33472/33287
Outer Bearing Cup/Cone	3925/3982
Univ. Axle Tool Head	555-5011
Bearing Guide	N/A
Bearings and Tool Combination:	
Inner Bearing Cup/Cone	33472/33281
Outer Bearing Cup/Cone	3925/3984
Univ. Axle Tool Head	555-5002
Bearing Guide	N/A
Bearings and Tool Combination:	
Inner Bearing Cup/Cone	493/495AX
Outer Bearing Cup/Cone	39520/39590
Univ. Axle Tool Head	555-5074
Bearing Guide	570-0022
Bearings and Tool Combination:	
Inner Bearing Cup/Cone	47620/47686
Outer Bearing Cup/Cone	39520/39590
Univ. Axle Tool Head	555-5031
Bearing Guide	570-0023
Fleet Hub Tool	551-5312
Bearing Guide	570-0021
Install Handle/Body	555-0001 & 551-0001
Remarks: Check type of OEM axle ring used. Stepped type OEM ring No. 3874372 must be replaced with the same OEM number.	
Flat type axle ring No. 3880944 can be replaced with either the OEM ring or STEMCO part No. 310-1117 .	
*Axle Ring must be ordered separately. It is not part of set No. 392-9045 .	
Oil seal 320-2091 seals on OEM spacer sleeve, GMC or Chev. No. 3874372. Replace if worn. Obtain from GMC-Chev. dealer. 1966 15000 uses 33287 & 3982 cones. 1967 up uses 33281 & 3984 cones.	
▼ Related Parts ▼	

Grit Guard® Hub Seal 310-1063

Very Important. These seal sets must be installed with the tools listed in this catalog.

NOTE: Use 555 series Tool Heads with Universal Axle Tool body 555-0001 (installs axle/deflector rings).

❌ Discontinued

Standard Hub-Seal Sets

STANDARD - DRIVE AXLE

392-9053

Axle Ring	310-1089
Oil Seal	320-2099
<i>Bore Diameter</i>	7.250
Inner Bearing Cup/Cone	772/782
Outer Bearing Cup/Cone	742/749
Universal Axle Tool Head	555-5016
Fleet Hub Tool	551-5317
Install Handle/Body	555-0001 & 551-0001

Remarks: Replace worn seal with **320-2059** (component of **320-2099**). Press oil seal into retainer so leather lip points toward oil side. Do not hammer on seal. National AR-23 ring must be removed

Related Parts

Grit Guard® Hub Seal	310-1089
Grit Guard® Hub Seal	320-2099

STANDARD - DRIVE AXLE

392-9057

Axle Ring	310-1018
Oil Seal	320-2104
<i>Bore Diameter</i>	5.500
Bearings and Tool Combination:	
Inner Bearing Cup/Cone	33462/33287
Outer Bearing Cup/Cone	3920/3982
Univ. Axle Tool Head	555-5011

Bearings and Tool Combination:

Inner Bearing Cup/Cone	493/495AX
Outer Bearing Cup/Cone	39520/39590
Univ. Axle Tool Head	555-5074
Fleet Hub Tool	551-5383
Install Handle/Body	555-0001 & 551-0001

Remarks: This seal set used on Ford 1970 & up and GMC 1982 & up. Ford prior to 1970 & GMC prior to 1982 use **392-9018**.

Related Parts

Guardian® HP Hub Seal	309-0957
------------------------------	----------

For Guardian® Seal No. 309-0957, See Pg. 30

STANDARD - DRIVE AXLE

392-9062

Axle Ring	310-1103
Oil Seal	320-2001
<i>Bore Diameter</i>	6.500
Bore Diameter	6.500
Inner Bearing Cup/Cone	752/760
Outer Bearing Cup/Cone	742/749
Universal Axle Tool Head	555-5079
Fleet Hub Tool	551-5398
Install Handle/Body	555-0001 & 551-0001
Bearing Guide	570-0026
Remarks	None

Related Parts

Grit Guard® Hub Seal	310-1089
Grit Guard® Hub Seal	320-2099

STANDARD - DRIVE AXLE

392-9063

Axle Ring	310-1104 
Oil Seal	320-2077
<i>Bore Diameter</i>	3.937
Bearings and Tool Combination:	
Inner Bearing Cup/Cone	127627/ 188931
Outer Bearing Cup/Cone	149521/ 188933
Univ. Axle Tool Head	555-5054

Bearings and Tool Combination:

Inner Bearing Cup/Cone	382A/387AS 7451691/ 7451929
Outer Bearing Cup/Cone	LM104911/ LM104949 7451813/ 7451814
Univ. Axle Tool Head	555-5062
Fleet Hub Tool	551-5362
Install Handle/Body	555-0001 & 551-0001
Bearing Guide	570-0017
Remarks	None

STANDARD - DRIVE AXLE

392-9066

Axle Ring	310-1107
Oil Seal	320-2115
<i>Bore Diameter</i>	6.000
Inner Bearing Cup/Cone	592A/594A
Universal Axle Tool Head	555-5076
Fleet Hub Tool	551-5356
Install Handle/Body	555-0001 & 551-0001
Bearing Guide	570-0028
Remarks:	Van Hool Bus application

STANDARD - DRIVE AXLE

392-9081

Axle Ring	310-1079
Oil Seal	320-2009
<i>Bore Diameter</i>	6.251
Inner Bearing Cup/Cone	592A/598A
Outer Bearing Cup/Cone	HM617010/ HM617049
Universal Axle Tool Head	555-5071
Fleet Hub Tool	551-5356
Install Handle/Body	555-0001 & 551-0001
Bearing Guide	570-0027
Remarks	Mack Only



Related Parts

Guardian® HP Hub Seal	309-0960
------------------------------	----------

For Guardian® Seal No. 309-0960, 6.251" Bore, See Pg. 30

STANDARD - DRIVE AXLE

392-9111

Axle Ring	310-1233 
Oil Seal	320-2233 
<i>Bore Diameter</i>	5.906
Inner Bearing Cup/Cone	593X/594
Outer Bearing Cup/Cone	593X/594
Universal Axle Tool Head	555-5076
Fleet Hub Tool	551-5404
Install Handle/Body	555-0001 & 551-0001
Bearing Guide	570-0028

Remarks: Mack Midliner. Mack slinger ring models 1987 & earlier.

Grit Guard® Hub-Seals Sets

GRIT GUARD - DRIVE AXLE 392-9087

Axle Ring	315-1502
Oil Seal	320-2162
<i>Bore Diameter</i>	7.000
Bearings and Tool Combination:	
Inner Bearing Cup/Cone	672-681A
Outer Bearing Cup/Cone	572/575, 572/580
Univ. Axle Tool Head	555-5071
Bearing Guide	570-0027
Bearings and Tool Combination:	
Inner Bearing Cup/Cone	672/682, 672/683XA
Outer Bearing Cup/Cone	572/580
Univ. Axle Tool Head	555-5076
Bearing Guide	570-0028
Fleet Hub Tool	551-5333
Install Handle/Body	555-0001 & 551-0001

Remarks: Special note for all Meritor R-143 & White Western Star 44D prior to Sept. 1973. These axles have 4.500 spindle shoulder diameter and require shoulder bushings **364-6435** to be installed before axle ring. Shoulder bushing and axle rings must be installed flush with spindle shoulder face. Shoulder bushings are not part of set and must be ordered separately. If axle has factory installed shoulder bushing, leave it in place & reuse if not damaged.

Related Parts

Guardian® HP Hub Seal	309-0970
------------------------------	----------

For Guardian® Seal No. 309-0970, 7.000" Bore, See Pg. 30

GRIT GUARD - DRIVE AXLE 392-9088

Axle Ring	315-1517
Oil Seal	320-2113
<i>Bore Diameter</i>	6.000
Inner Bearing Cup/Cone	592A/594, 592A/594A
Outer Bearing Cup/Cone	572/580
Universal Axle Tool Head	555-5076
Fleet Hub Tool	551-5412
Install Handle/Body	555-0001 & 551-0001
Bearing Guide	570-0028

Remarks: Oil seal **320-2113** installs in bearing cup bore.

Related Parts

Guardian® HP Wheel Seal	309-0964
--------------------------------	----------

For Guardian® Seal No. 309-0964, 6.250" Bore, See Pg. 30

GRIT GUARD - DRIVE AXLE 392-9089

Axle Ring	315-1516
Oil Seal	320-2097
<i>Bore Diameter</i>	7.375
Inner Bearing Cup/Cone	372/687, 772/780
	772/780, 52618/52400, 772/776, 77675/77375, 524/864
Outer Bearing Cup/Cone	
Universal Axle Tool Head	555-5004
Fleet Hub Tool	551-5400
Install Handle/Body	555-0001 & 551-0001
Bearing Guide	570-0032

Remarks: Use OEM bearing spacer #37AX335. **320-2059** is a component of **320-2097**. Must replace with the **320-2097** seal.

392-9089 and **309-0948** will not fit S582 or S652 after June 1998. Only use **393-0148** on these axles after June 1998. Won't fit 58,000 Mack 2000/2001.

Related Parts

Guardian® HP Wheel Seal	309-0948
Voyager® Wheel Seal	393-0148

For Guardian® Seal No. 309-0948, 7.375" Bore, See Pg. 30
For Voyager® Seal No. 393-0148, 7.375" Bore, See Pg. 30

GRIT GUARD - DRIVE AXLE 392-9092

Axle Ring	315-1508
Oil Seal	320-2131
<i>Bore Diameter</i>	6.250
Inner Bearing Cup/Cone	592A/598
	752/758, 653/665, HM617010/ HM617049
Outer Bearing Cup/Cone	
Universal Axle Tool Head	555-5071
Fleet Hub Tool	551-5363
Install Handle/Body	555-0001 & 551-0001
Bearing Guide	570-0027

Remarks: Mack

Related Parts

Guardian® HP Wheel Seal	309-0965
--------------------------------	----------

For Guardian® Seal No. 309-0965, 6.250" Bore, See Pg. 30

GRIT GUARD - DRIVE AXLE 392-9094

Axle Ring	315-1511
Oil Seal	320-2129
<i>Bore Diameter</i>	5.750
Inner Bearing Cup/Cone	572/580, 572/582
Outer Bearing Cup/Cone	563/567
Universal Axle Tool Head	555-5072
Fleet Hub Tool	551-5393
Install Handle/Body	555-0001 & 551-0001
Bearing Guide	570-0023

Remarks: Mack Western 11QJA- 191, -192 hub and drum assembly or motor wheel 87125 hub or 87119-B or 87226-F hub and drum assembly with 582 inner cone must use OEM bearing spacer 35AX-1411. Install OEM bearing spacer before installing axle ring. Press axle ring on until flush with bearing side of bearing spacer.

Related Parts

Guardian® HP Wheel Seal	309-0903
Voyager® Wheel Seal	309-0103
Discover® Wheel Seal	309-0203

For Guardian® Seal No. 309-0903, 5.750" Bore, See Pg. 30
For Voyager® Seal No. 393-0103, 5.750" Bore, See Pg. 30
For Discover® Seal No. 393-0203, 5.750" Bore, See Pg. 30

GRIT GUARD - DRIVE AXLE 392-9095

Axle Ring	315-1509
Oil Seal	320-2117
<i>Bore Diameter</i>	6.064
Inner Bearing Cup/Cone	572/580, 572/582, 653/663A
Outer Bearing Cup/Cone	42620/42687
Universal Axle Tool Head	555-5072
Fleet Hub Tool	551-5325
Install Handle/Body	555-0001 & 551-0001
Remarks	None

Related Parts

Guardian® HP Wheel Seal	309-0961
--------------------------------	----------

For Guardian® Seal No. 309-0961, 6.064" Bore, See Pg. 30

NOTE: Use 555 series Tool Heads with Universal Axle Tool body 555-0001 (installs axle/deflector rings).

NOTE: Use 551 series tools with new Universal Hub Tool Handle 551-0001 (installs 320 series Voyager® and Discover® seals).

Discontinued

Grit Guard® Hub-Seal Sets

GRIT GUARD - DRIVE AXLE

392-9096

Axle Ring	315-1508
Oil Seal	320-2114
<i>Bore Diameter</i>	6.000

Bearings and Tool Combination:

Inner Bearing Cup/Cone	592A/595
Outer Bearing Cup/Cone	572/580
Univ. Axle Tool Head	555-5072
Bearing Guide	570-0023

Bearings and Tool Combination:

Inner Bearing Cup/Cone	592A/598
Outer Bearing Cup/Cone	572/575
Univ. Axle Tool Head	555-5071
Bearing Guide	570-0027

Fleet Hub Tool

Install Handle/Body	555-0001 & 551-0001
----------------------------	---------------------

Remarks: Oil seal **320-2114** installs in bearing cup bore. For use with Eaton 42D replace OEM bearing spacer with **357-5706** if damaged.

Dimensions: OD 4.375, ID 4.150, width .688.

Related Parts

Guardian® HP Wheel Seal	309-0965
--------------------------------	----------

For Guardian® Seal No. 309-0965, 6.250" Bore, See Pg. 30

NOTE: Use 555 series Tool Heads with Universal Axle Tool body 555-0001 (installs axle/deflector rings).

NOTE: Use 551 series tools with new Universal Hub Tool Handle 551-0001 (installs 320 series Voyager® and Discover® seals).

 Discontinued

GRIT GUARD - DRIVE AXLE

392-9099

Axle Ring	315-1501
Oil Seal	320-2102
<i>Bore Diameter</i>	5.250

Bearings and Tool Combination:

Inner Bearing Cup/Cone	47620/47685, 47620/47686
Outer Bearing Cup/Cone	39520/39590
Univ. Axle Tool Head	555-5031
Bearing Guide	570-0023

Bearings and Tool Combination:

Inner Bearing Cup/Cone	47620/47678
Outer Bearing Cup/Cone	39520/39585
Univ. Axle Tool Head	555-5074
Bearing Guide	570-0022

Fleet Hub Tool

Install Handle/Body	555-0001 & 551-0001
----------------------------	---------------------

Remarks: Oil seal 320-2102 installs in bearing cup bore. Do not use OEM oil seal spacer ring. This set will not fit early axles with 5760 inner bearing cone.

Related Parts

Guardian® HP Wheel Seal	309-0915
Voyager® Wheel Seal	393-0115
Guardian® HP Wheel Seal	309-0912
Voyager® Wheel Seal	393-0112
Discover® Wheel Seal	393-0212

For Guardian® Seal No. 309-0915, 5.500" Bore, See Pg. 30
For Voyager® Seal No. 309-0115, 5.500" Bore, See Pg. 30
For Guardian® Seal No. 309-0912, 5.690" Bore, See Pg. 30
For Voyager® Seal No. 309-0112, 5.690" Bore, See Pg. 30
For Discover® Seal No. 309-0212, 5.690" Bore, See Pg. 30

GRIT GUARD - DRIVE AXLE

392-9112

Axle Ring	315-1515
Oil Seal	320-2213
<i>Bore Diameter</i>	6.251

Inner Bearing Cup/Cone	652/663 HM516410/ HM516449,-C
-------------------------------	-------------------------------------

Outer Bearing Cup/Cone	572/575 47620/47679
-------------------------------	------------------------

Universal Axle Tool Head	555-5072
---------------------------------	----------

Fleet Hub Tool	551-5364
-----------------------	----------

Install Handle/Body	555-0001 & 551-0001
----------------------------	---------------------

Bearing Guide	570-0023
----------------------	----------

Remarks: Mack application, use OEM bearing spacer #35AX790 or 35AX1411.

For cast axle housing only. With HM516449A see **392-9130**. Only **309-0904** can be used with ABS Brakes.

Related Parts

Guardian® HP Wheel Seal	309-0904
Voyager® Wheel Seal	393-0104
Guardian® HP Wheel Seal	393-0204

For Guardian® Seal No. 309-0904, 6.25" Bore, See Pg. 30
For Voyager® Seal No. 309-0104, 6.25" Bore, See Pg. 30
For Discover® Seal No. 309-0204, 6.25" Bore, See Pg. 30

GRIT GUARD - DRIVE AXLE

392-9130

Axle Ring	315-1519 
Oil Seal	320-2213
<i>Bore Diameter</i>	6.251

Inner Bearing Cup/Cone	HM516410/ HM516449A
-------------------------------	------------------------

Outer Bearing Cup/Cone	572/575 47620/47679
-------------------------------	------------------------

Bearing Guide	570-0023
----------------------	----------

Universal Axle Tool Head	555-5073
---------------------------------	----------

Fleet Hub Tool	551-5364
-----------------------	----------

Install Handle/Body	555-0001 & 551-0001
----------------------------	---------------------

Remarks: Mack application, seal set for use with HM516449A only. Do not use bearing spacer. **309-0904**, **393-0104** and **393-0204** can be used with ABS Brakes. Reference Tech Tip #015.

Related Parts

Guardian® HP Wheel Seal	309-0904
Voyager® Wheel Seal	393-0104
Guardian® HP Wheel Seal	393-0204

For Guardian® Seal No. 309-0904, 6.25" Bore, See Pg. 30
For Voyager® Seal No. 309-0104, 6.25" Bore, See Pg. 30
For Discover® Seal No. 309-0204, 6.25" Bore, See Pg. 30

Grit Guard® Hub-Seal Sets

Seal Sets
Front Axles

Component
Specs

Installation
Tools

Axle
Fasteners

Long-Life
Systems

Cross
Reference

Installation
Instructions

GRIT GUARD - DRIVE AXLE

392-9131

Axle Ring	315-1525*
Oil Seal	320-2106
<i>Bore Diameter</i>	6.310
Bearings and Tool Combination:	
Inner Bearing Cup/Cone	592A/598A
Outer Bearing Cup/Cone	572/580
Univ. Axle Tool Head	555-5071
Bearing Guide	570-0027
Bearings and Tool Combination:	
Inner Bearing Cup/Cone	592A/598
Outer Bearing Cup/Cone	572/575
Univ. Axle Tool Head	555-5071
Bearing Guide	570-0027
Bearings and Tool Combination:	
Inner Bearing Cup/Cone	592A/594
Outer Bearing Cup/Cone	572/580
Univ. Axle Tool Head	555-5076
Bearing Guide	570-0028
Bearings and Tool Combination:	
Inner Bearing Cup/Cone	592A/594A
Outer Bearing Cup/Cone	572-580
Univ. Axle Tool Head	555-5076
Bearing Guide	570-0028
Fleet Hub Tool	551-5320
Install Handle/Body	555-0001 & 551-0001

Remarks: Special note for Dodge, Freightliner, Kenworth & Peterbilt using this set on Eaton axles with Meritor hubs or wheels: Eaton 18 series single or 38D tandem with 4.375 spindle shoulder require shoulder bushing **364-6402** to be installed before axle ring. Eaton 19 series single or 44D tandem with 4.500 spindle shoulder require shoulder bushing **364-6435** to be installed before axle ring. Shoulder bushings & axle rings must be installed flush with spindle shoulder face. Shoulder bushings are not part of set & must be ordered separately. If axle has factory installed shoulder bushing, leave it in place & reuse if not damaged. Shoulder bushings are not required on Eaton axles if shoulder is already machined to the diameter for the **315-1525** axle ring. For wheel ends using 681A inner bearing refer to **392-9087** set. Hub cap **340-4119** & gasket **330-3090** available for tag and pusher use. This set fits ABS Systems (Anti-lock Brake System).

* Will not fit on Freightliner with Wagner Anti-Skid or Motorola 22-14670-14 Electronic Speedometers. Use 310-1111 standard axle ring with 320-2106 oil seal.

Related Parts

Guardian® HP Wheel Seal	309-0973
Voyager® Wheel Seal	393-0173
Guardian® HP Wheel Seal	309-0273

For Guardian® Seal No. 309-0973, 6.130" Bore, See Pg. 30
For Voyager® Seal No. 309-0173, 6.130" Bore, See Pg. 30
For Discover® Seal No. 309-0273, 6.130" Bore, See Pg. 30

GRIT GUARD - DRIVE AXLE

392-9132

Axle Ring	315-1530
Oil Seal	320-2115
<i>Bore Diameter</i>	6.000
Bearings and Tool Combination:	
Inner Bearing Cup/Cone	592A/598A
Outer Bearing Cup/Cone	572/582
Univ. Axle Tool Head	555-5071
Bearing Guide	570-0027
Bearings and Tool Combination:	
Inner Bearing Cup/Cone	592A/594A
Outer Bearing Cup/Cone	580
Univ. Axle Tool Head	555-5076
Bearing Guide	570-0028
Fleet Hub Tool	551-5356
Install Handle/Body	555-0001 & 551-0001

Remarks: Oil seal **320-2115** installs in bearing cup bore. Aluminum hubs use **392-9131** set. REF: **392-9081**

Related Parts

Guardian® HP Wheel Seal 309-0960

For Guardian® Seal No. 309-0960, 6.251" See Pg. 30

NOTE: Use 555 series Tool Heads with Universal Axle Tool body 555-0001 (installs axle/deflector rings).

NOTE: Use 551 series tools with new Universal Hub Tool Handle 551-0001 (installs 320 series Voyager® and Discover® seals).

 Discontinued

Grit Guard® Hub-Seal Sets

GRIT GUARD - DRIVE AXLE

392-9096

Axle Ring 315-1508

Oil Seal 320-2114
Bore Diameter 6.000

Bearings and Tool Combination:

Inner Bearing Cup/Cone 592A/595

Outer Bearing Cup/Cone 572/580

Univ. Axle Tool Head 555-5072

Bearing Guide 570-0023

Bearings and Tool Combination:

Inner Bearing Cup/Cone 592A/598

Outer Bearing Cup/Cone 572/575

Univ. Axle Tool Head 555-5071

Bearing Guide 570-0027

Fleet Hub Tool 551-5412

Install Handle/Body 555-0001 & 551-0001

Remarks: Oil seal **320-2114** installs in bearing cup bore. For use with Eaton 42D replace OEM bearing spacer with **357-5706** if damaged.

Dimensions: OD 4.375, ID 4.150, width .688.

▼ Related Parts ▼

Guardian® HP Hub Seal 309-0965

For Guardian® Seal No. 309-0965, 6.25" Bore, See Pg. 30

GRIT GUARD - DRIVE AXLE

392-9099

Axle Ring 315-1501

Oil Seal 320-2102
Bore Diameter 5.250

Bearings and Tool Combination:

Inner Bearing Cup/Cone 47620/47685,
47620/47686

Outer Bearing Cup/Cone 39520/39590

Univ. Axle Tool Head 555-5031

Bearing Guide 570-0023

Bearings and Tool Combination:

Inner Bearing Cup/Cone 47620/47678

Outer Bearing Cup/Cone 39520/39585

Univ. Axle Tool Head 555-5074

Bearing Guide 570-0022

Fleet Hub Tool 551-5318

Install Handle/Body 555-0001 & 551-0001

Remarks: Oil seal 320-2102 installs in bearing cup bore. Do not use OEM oil seal spacer ring. This set will not fit early axles with 5760 inner bearing cone.

▼ Related Parts ▼

Guardian® HP Hub Seal 309-0915

Voyager® HP Hub Seal 393-0115

Guardian® HP Hub Seal 309-0912

Voyager® HP Hub Seal 393-0112

Discover® HP Hub Seal 393-0212

For Guardian® Seal No. 309-0915, 5.5" Bore, See Pg. 30

For Voyager® Seal No. 309-0115, 5.5" Bore, See Pg. 30

For Guardian® Seal No. 309-0912, 5.69" Bore, See Pg. 30

For Voyager® Seal No. 309-0112, 5.69" Bore, See Pg. 30

For Discover® Seal No. 309-0212, 5.69" Bore, See Pg. 30

GRIT GUARD - DRIVE AXLE

392-9112

Axle Ring 315-1515

Oil Seal 320-2213
Bore Diameter 6.251

Inner Bearing Cup/Cone 652/663
HM516410/
HM516449,-C

Outer Bearing Cup/Cone 572/575
47620/47679

Bearing Guide 570-0023

Universal Axle Tool Head 555-5072

Fleet Hub Tool 551-5364

Install Handle/Body 555-0001 & 551-0001

Remarks: Mack application, use OEM bearing spacer #35AX790 or 35AX1411.

For cast axle housing only. With HM516449A see **392-9130**. Only **309-0904** can be used with ABS Brakes.

▼ Related Parts ▼

Guardian® HP Hub Seal 309-0904

Voyager® HP Hub Seal 393-0104

Guardian® HP Hub Seal 393-0204

For Guardian® Seal No. 309-0904, 6.25" Bore, See Pg. 30

For Voyager® Seal No. 309-0104, 6.25" Bore, See Pg. 30

For Discover® Seal No. 309-0204, 6.25" Bore, See Pg. 30

GRIT GUARD - DRIVE AXLE

392-9130

Axle Ring 315-1519 

Oil Seal 320-2213
Bore Diameter 6.251

Inner Bearing Cup/Cone HM516410/
HM516449A

Outer Bearing Cup/Cone 572/575
47620/47679

Bearing Guide 570-0023

Universal Axle Tool Head 555-5073

Fleet Hub Tool 551-5364

Install Handle/Body 555-0001 & 551-0001

Remarks: Mack application, seal set for use with HM516449A only. Do not use bearing spacer. **309-0904**, **393-0104** and **393-0204** can be used with ABS Brakes. Ref Tech Tip #015.

▼ Related Parts ▼

Guardian® HP Hub Seal 309-0904

Voyager® HP Hub Seal 393-0104

Guardian® HP Hub Seal 393-0204

For Guardian® Seal No. 309-0904, 6.25" Bore, See Pg. 30

For Voyager® Seal No. 309-0104, 6.25" Bore, See Pg. 30

For Discover® Seal No. 309-0204, 6.25" Bore, See Pg. 30

NOTE: Use 555 series Tool Heads with Universal Axle Tool body 555-0001 (installs axle/deflector rings).

NOTE: Use 551 series tools with new Universal Hub Tool Handle 551-0001 (installs 320 series Voyager® and Discover® seals).

 Discontinued

Technologically Advanced Sealing Solutions

Unitized Pinion Seals



Easy Installation

The single piece, unitized design is installed in one step using the yoke bolt to install the press-fit OD.

Repair Sleeves Not Required

The unitized design incorporates a wear ring to provide an ideal running surface for the sealing lip, thus eliminating the need for repair sleeves that often change the seal lip angle during operation, resulting in reduced life.

Eliminate Yoke Wear

Sealing lips are contained in a manner that prevents yoke surface contact from the lip. New yokes will remain new at the sealing point.

Repair 'Grooved' Yokes

The ID with a wide contact area includes SMART anti-rotational features to prevent the seal from spinning on the yoke and the fully unitized design makes most yokes reusable.

Eliminate Leak Paths

Bore sealant on the OD and the wide contact area on the ID eliminate leak paths to avoid premature failures.

Reduce Contamination Failures

To promote long life, a labyrinth path with multiple dust lips prevents contamination ingress into the sealing lip and oil.

Long-Life Performance

The fluoroelastomer rubber on the main sealing lip withstands the high heat consistent with pinion seal applications.

Specifications & Interchange

Part Number/ Application	Bore ID/ Yoke Shaft OD	Tool Number	OE Number	SKF Number	National Number	Design Type
STEMCO No. 429-0002 Mack Front Input	4.500/3.500	551-5360	88AX458	34882 34891	415991N	1
STEMCO No. 429-0003 Eaton 400 Rear Input	4.564/ 2.625	551-5001	127721 79470	26373 26378	9773	2
STEMCO No. 429-0004 Eaton 400 Front Output	3.625/2.625	551-5003	127720 63910	26200 26209 26239	475003N	3
Eaton 344, 404, 405, 454 Front Output			127592	26762		3
STEMCO No. 429-0005 Meritor SQ100 RT46-160 Front Input	3.751/3.003	551-5004	A11205Y2729 A1205P2590 A1205E1227	29865 29867 30007	4810V 100495 415281N	1
STEMCO No. 429-0006 Eaton 402 Front Input	4.003/2.937	551-5002	127719 A1205U1737	29292 29322 29316	416654 475012N	3
Eaton 40, 461-653 series Front Output			210737	29380		
STEMCO No. 429-0007 Meritor R145/160 RT46-160 Front Input	4.249/3.253	551-5006	A11205X2728 A1205R2592 A1205P1368 A1205B1926	32385 32397 32410	4543V 100494 416470N	1
STEMCO No. 429-0008 Mack Front Output	3.537/2.751	551-5007	88AX456 A1205A1925	27295 27558	4874N 475322N	1
STEMCO No. 429-0009 Mack Rear Input	3.996/2.751	551-5008	88AX457	27542 27565	415272N	1
STEMCO No. 429-0010 Meritor SQ100 Rear Input	4.935/3.003	551-5009	A11250Z2730 A1205N2588 A1205H2426	30145 30153	3905 4562V 100263	2
STEMCO No. 429-0011 Meritor RT 46-160, 180, 380 Series, Front & Rear Input	5.501/3.253	551-5011	A1205Q2591	32870	4544V 100557	2
STEMCO No. 429-0012 Eaton 344, 404, 405 & 454 Front and Rear Input	4.564/3.000	551-5012	127591	29528		2

Design Types

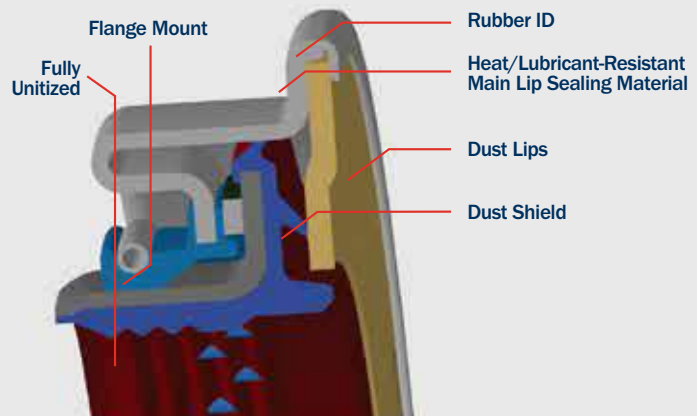
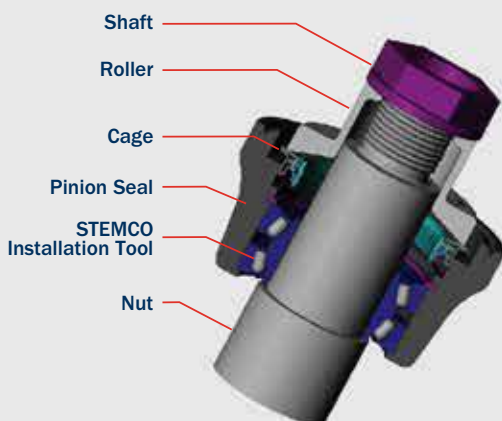
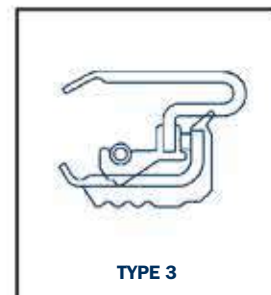
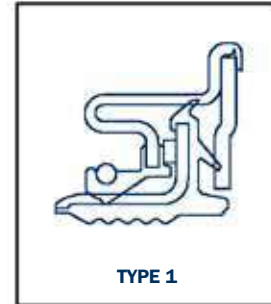

Pinion Seal Specifications

Pinion Seal Specifications by Set Number

Set Number	Bore ID	Yoke Shaft OD	Wear Sleeve	Dust Seal	Oil Seal	Spline OD	Tool Number
460-6001	3.625	2.625	419-1946	429-2945	429-2944	1-3/4 1-31/32	589-8999 589-8994
460-6002	4.562	2.625	419-1946		429-2983	1-3/4 1-31/32	589-8998 589-8987
460-6003	3.937	2.937	419-1981	429-2978	429-2977	2	589-8997
460-6004	3.542	2.750	419-1982	429-2980	429-2979	1-3/4 1-7/8	589-8996 589-8993
460-6006	4.000	2.937	419-1940	429-2937	429-2938	2 2-5/32	589-8990 589-8989
460-6007	4.000	3.000	419-1939	429-2937	429-2938	1-31/32	589-8988
460-6011	4.250	3.250	419-1941		429-2941	2-1/4	
460-6012	4.250	3.000	419-1901		429-2901	Any	
460-6083	4.250	3.250	419-1983		429-2941	2-1/4	
460-6084	4.000	2.937	419-1984	429-2937	429-2938	2 2-5/32	589-8990 589-8989

Component part numbers discontinued, sold as sets only

Oil Seal & Dust Seal are an integral unit

Use Tool 589-8984, 589-8985 or 589-8986

For additional pinion seal information, refer to Pinion Seal catalog 572-0004.

Axle Ring Specifications

CAUTION: Dimensions shown in this section are nominal and are for parts identification only. Not intended for ring/seal combination design purposes.

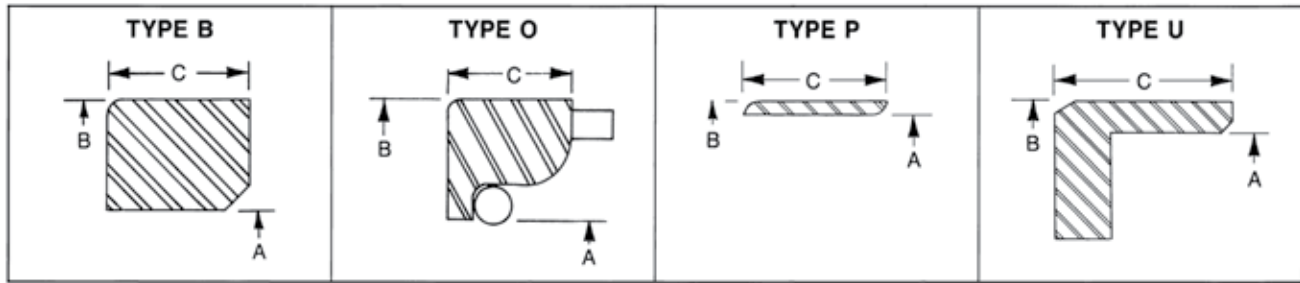

Note: "A" dimension is the shoulder size. The axle ring I.D. is sized to provide a press fit.

Axle Ring Dimensions by Part Number

STEMCO Axle Ring Number	Type	A For Shoulder Or Spindle O.D.	B Axle Ring O.D.	C Width
310-1007	P	5.000	5.120	.812
310-1008	P	2.878	2.980	.500
310-1009	B	4.000	4.600	.687
310-1012	P	3.875	4.040	.812
310-1013	P	4.000	4.127	.520
310-1017	P	3.250	3.348	.500
310-1018	P	3.937	4.035	.831
310-1022	O	3.500	4.375	.632
310-1023	P	4.250	4.344	.547
310-1026	P	4.375	4.480	.750
310-1027	B	3.500	4.120	.500
310-1028	P	4.875	4.954	.500
310-1032	O	2.625	3.625	.600
310-1034	P	3.625	3.732	.500
310-1036	P	3.500	3.625	.524
310-1037	P	4.375	4.480	.562
310-1038	O	2.625	4.040	.750
310-1041	O	3.000	4.375	.812
310-1043	B	4.503	4.955	.500
310-1045	B	4.250	4.948	.531
310-1048	P	4.625	4.730	.593
310-1050	O	2.125	3.187	.717
310-1051	O	2.500	3.625	.625
310-1052	B	3.125	3.355	.519

STEMCO Axle Ring Number	Type	A For Shoulder Or Spindle O.D.	B Axle Ring O.D.	C Width
310-1053	P	4.000	4.121	.750
310-1057	B	3.750	4.120	.562
310-1058	P	4.823	4.948	.750
310-1061	P	2.671	2.775	.562
310-1062	P	3.437	3.619	.687
310-1063	P	3.500	3.625	.687
310-1064	P	3.125	3.250	.750
310-1066	P	4.875	4.948	1.000
310-1067	P	5.250	5.375	.812
310-1079	P	4.767	4.948	.812
310-1080	O	3.250	4.375	.625
310-1088	P	4.250	4.369	.812
310-1089	U	5.235	5.368	.908
310-1091	P	3.875	3.972	.812
310-1093	P	4.500	4.597	.687
310-1103	P	4.875	4.948	.750
310-1104	B	2.844	3.125	.600
310-1107	P	4.750	4.864	.750
310-1111	P	4.767	4.872	.650
310-1117	B	3.840	4.163	.625
310-1123	U	4.600	4.865	1.000
310-1130	P	4.250	4.344	.437
310-1132	O	2.625	4.000	.750
310-1233	P	4.724	4.818	.650

⊗ Discontinued

Axle Ring Specifications

CAUTION: Dimensions shown in this section are nominal and are for parts identification only. Not intended for ring/seal combination design purposes.

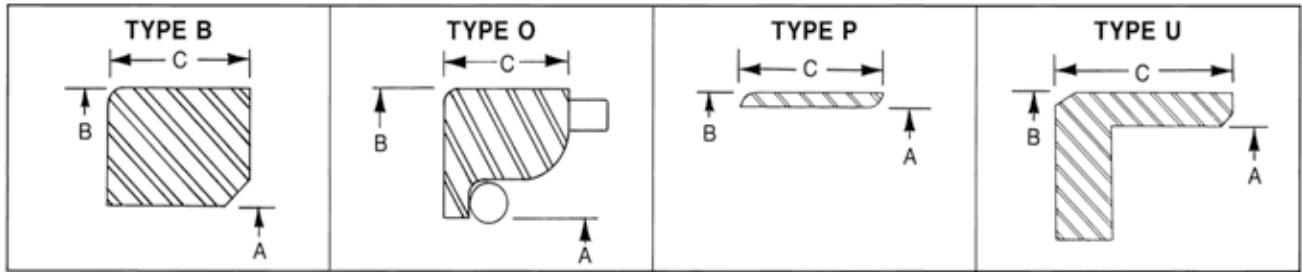

Axle Ring Dimensions By Shoulder or Spindle O.D.

A For Shoulder Or Spindle O.D.	Type	B Axle Ring O.D.	C Width	STEMCO Axle Ring Number
2.125	O	3.187	.717	310-1050
2.500	O	3.625	.625	310-1051
2.625	O	3.625	.600	310-1032
2.625	O	4.040	.750	310-1038
2.625		4.000	.750	310-1132
2.671	P	2.775	.562	310-1061
2.844	B	3.125	.600	310-1104
2.878	P	2.980	.500	310-1008
3.000	O	4.375	.812	310-1041
3.125	B	3.355	.519	310-1052
3.125	P	3.250	.750	310-1064
3.250	P	3.348	.500	310-1017
3.250	O	4.375	.625	310-1080
3.347	O	4.375	.875	310-1006
3.437	P	3.619	.687	310-1062
3.500	O	4.375	.632	310-1022
3.500	B	4.120	.500	310-1027
3.500	P	3.625	.524	310-1036
3.500	P	3.625	.687	310-1063
3.625	P	3.732	.500	310-1034
3.750	B	4.125	.562	310-1057
3.840	B	4.163	.625	310-1117
3.875	B	4.375	.500	310-1005
3.875	P	4.040	.812	310-1012
3.875	P	3.972	.812	310-1091

A For Shoulder Or Spindle O.D.	Type	B Axle Ring O.D.	C Width	STEMCO Axle Ring Number
3.937	P	4.035	.831	310-1018
4.000	B	4.600	.687	310-1009
4.000	P	4.127	.520	310-1013
4.000	P	4.121	.750	310-1053
4.250	P	4.344	.547	310-1023
4.250	B	4.948	.531	310-1045
4.250	P	4.369	.812	310-1088
4.250	P	4.344	.437	310-1130
4.375	P	4.480	.750	310-1026
4.375	P	4.480	.562	310-1037
4.500	P	4.597	.687	310-1093
4.503	B	4.955	.500	310-1043
4.600	U	4.865	1.000	310-1123
4.625	P	4.730	.593	310-1048
4.724	P	4.818	.650	310-1233
4.750	P	4.864	.750	310-1107
4.767	P	4.948	.812	310-1079
4.767	P	4.848	.650	310-1111
4.823	P	4.948	.750	310-1058
4.875	P	4.954	.500	310-1028
4.875	P	4.948	1.000	310-1066
4.875	P	4.948	.750	310-1103
5.000	P	5.120	.812	310-1007
5.235	U	5.368	.908	310-1089
5.250	P	5.375	.812	310-1067

Discontinued

Decimal Equivalents

1/32	.0313
1/16	.0625
3/32	.0938
1/8	.1250
5/32	.1563
3/16	.1875
7/32	.2188
1/4	.2500

9/32	.2813
5/16	.3125
11/32	.3438
3/8	.3750
13/32	.4063
7/8	.8750
15/32	.4688
1/2	.5000

17/32	.5315
9/16	.5625
19/32	.5938
5/8	.6250
21/32	.6563
11/16	.6875
23/32	.7188
3/4	.7500

25/32	.7813
13/16	.8125
27/32	.8438
7/16	.4375
29/32	.9063
15/16	.9375
31/32	.9688
1	1.0000

Grit Guard® Deflector Ring Specifications

CAUTION Dimensions shown in this section are nominal and are for parts identification only. Not intended for ring/seal combination design purposes.

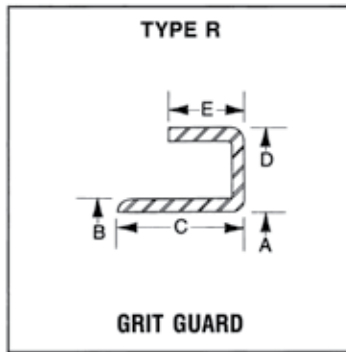

Deflector Ring Dimensions by Part Number

Grit Guard® Deflector Ring	Deflector Ring Type	A For Shoulder O.D.	B Seal Area O.D.	C Width	D Flange O.D.	E Flange Width
315-1501	R	3.875	3.972	1.052	5.250	0.520
315-1502	R	4.767	4.854	1.008	6.147	0.630
315-1503	R	4.250	4.338	0.667	5.625	0.453
315-1504	R	4.625	4.730	0.730	5.875	0.430
315-1506	R	5.250	5.364	0.905	6.875	0.625
315-1507	R	4.000	4.127	0.603	5.625	0.365
315-1508	R	4.375	4.480	0.875	6.125	0.500
315-1509	R	4.262	4.375	0.811	5.630	0.468
315-1510	R	4.375	4.480	0.682	5.625	0.500
315-1511	R	4.500	4.597	0.950	5.685	0.437
315-1515	R	4.250	4.341	0.937	6.000	0.470
315-1516	R	5.250	5.375	1.110	7.125	0.395
315-1517	R	4.500	4.597	0.818	6.125	0.493
315-1519	R	4.250	4.341	1.187	6.000	0.470
315-1525	R	4.767	4.854	0.915	6.031	0.537
315-1530	R	4.767	4.872	0.915	5.935	0.400

Deflector Ring Dimensions by Shoulder O.D.

A For Shoulder O.D.	Deflector Ring Type	B Seal Area O.D.	C Width	D Flange O.D.	E Flange Width	Grit Guard® Deflector Ring
3.875	R	3.972	1.052	5.250	0.520	315-1501
4.000	R	4.115	0.603	5.625	0.365	315-1507
4.250	R	4.341	1.187	6.000	0.470	315-1519
4.250	R	4.338	0.667	5.625	0.453	315-1503
4.250	R	4.369	0.937	6.000	0.470	315-1515
4.262	R	4.373	0.811	5.630	0.468	315-1509
4.375	R	4.480	0.682	5.625	0.500	315-1510
4.375	R	4.480	0.875	6.125	0.500	315-1508
4.500	R	4.597	0.950	5.685	0.437	315-1511
4.500	R	4.597	0.825	6.125	0.500	315-1517
4.625	R	4.730	0.745	5.875	0.490	315-1504
4.767	R	4.872	0.915	5.935	0.400	315-1530
4.767	R	4.854	1.008	6.147	0.630	315-1502
4.767	R	4.854	0.915	6.031	0.537	315-1525
5.250	R	5.375	1.110	7.125	0.395	315-1516
5.250	R	5.364	0.905	6.875	0.625	315-1506

Oil Seal Specifications

CAUTION Dimensions shown in this section are nominal and are for parts identification only. Not intended for ring/seal combination design purposes.

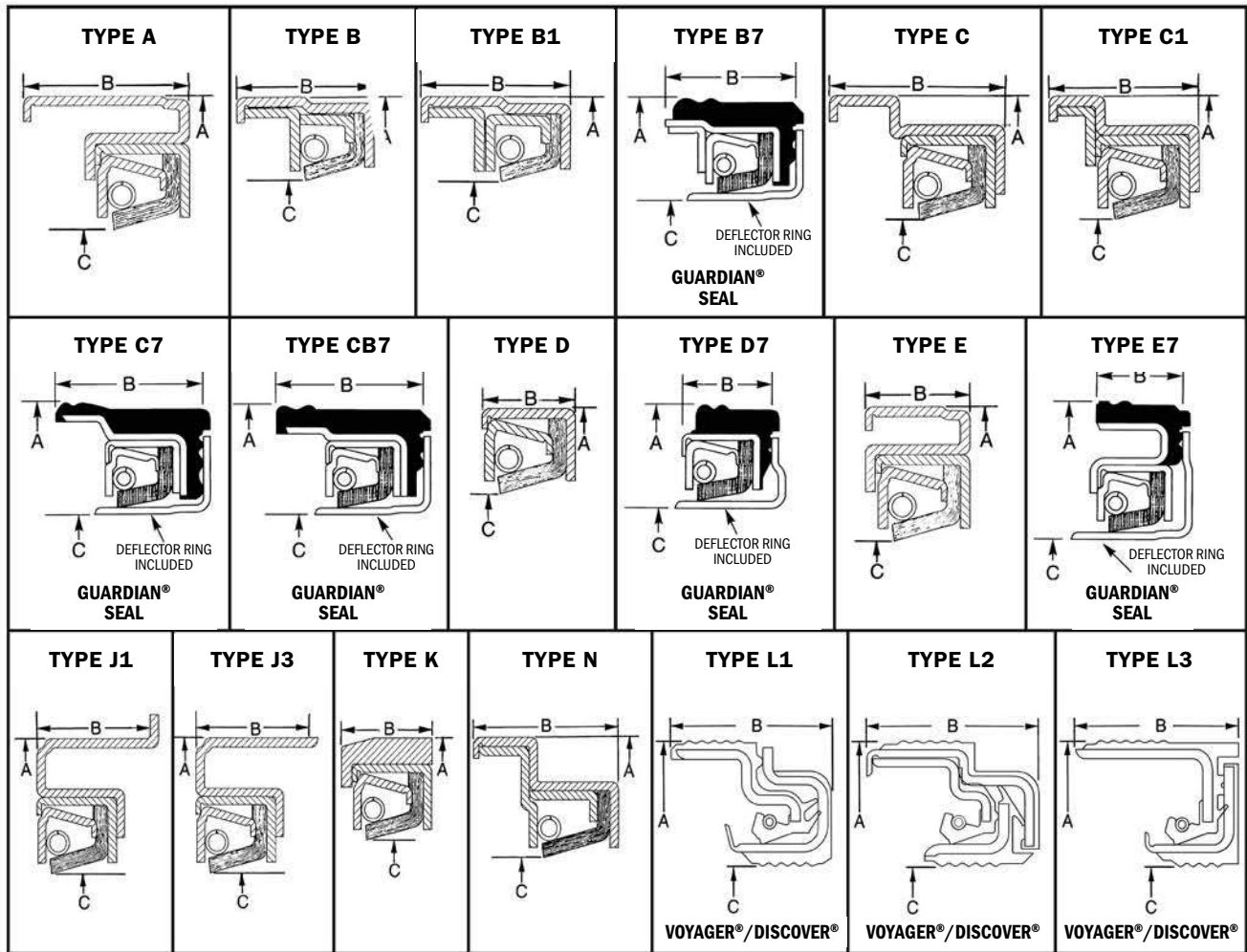

Guardian®/Guardian®HP Hub Oil Seal Dimensions by Part Number

Guardian® Seal Number	Type	A for Bore Diameter	B Width	C for Shoulder O.D.
307-0713	E7	5.750	.604	4.000
307-0723	E7	6.008	.563	4.250
307-0743	D7	6.000	.584	4.625
307-0744	C7	5.753	1.015	4.375
308-0836	CB7	4.840	.840	3.500
308-0853	D7	5.372	.518	4.500
308-0855	CB7	5.875	.820	4.500
308-0856	CB7	5.875	.820	4.500
308-0863	B7	4.542	.760	3.500
308-0864	E7	5.903	.955	4.375
308-0866	D7	3.875	.495	2.875
308-0870	E7	5.512	.820	3.937
309-0903	D7	5.750	.516	4.500

Guardian® Seal Number	Type	A for Bore Diameter	B Width	C for Shoulder O.D.
309-0904	E7	6.250	.548	4.250
309-0912	E7	5.690	.555	3.875
309-0915	E7	5.500	.736	3.875
309-0935	D7	4.750	.541	3.437
309-0948	E7	7.375	.735	5.250
309-0957	E7	5.500	.745	3.937
309-0960	D7	6.251	.668	4.767
309-0961	E7	6.064	.562	4.262
309-0964	E7	6.250	.600	4.500
309-0965	E7	6.250	.600	4.375
309-0970	C7	7.000	1.175	4.767
309-0973	C7	6.310	.910	4.767

1 Deflector ring width is .855.

2 Deflector ring width is .685.

3 Guardian® HP.

Oil Seal Specifications

Oil Seal Dimensions by Part Number

STEMCO Seal Number	Type	A for Bore Diameter	B Width	C for Axle Ring O.D. +/- .010
320-2001	A	6.500	.906	4.955
320-2007	D	6.250	.565	5.126
320-2009	C	6.251	1.127	4.955
320-2012	A	5.690	.612	4.041
320-2017	B	4.437	.812	3.358
320-2018	B	4.125	.780	2.980
320-2021	A	6.312	1.192	4.955
320-2022	A	4.500	.625	3.187
320-2023	N	6.008	.914	4.377
320-2028	A	6.375	.864	4.955
320-2029	A	5.375	.947	4.041
320-2031	A	5.000	.890	3.623
320-2032	E	5.000	.539	3.623
320-2034	B	4.812	.875	3.730
320-2036	N	4.840	.875	3.625
320-2039	B	5.125	.984	4.041
320-2041	A	6.437	.906	4.955
320-2046	A	5.003	.890	3.623
320-2050	B1	4.125	.664	3.361
320-2051	A	5.000	.734	3.623
320-2056	B1	3.671	.843	2.775
320-2057	C1	4.625	.934	3.623
320-2058	D	5.500	.565	4.600
320-2059	D	6.250	.572	5.377
320-2061	C1	6.003	.895	4.955
320-2072	B	4.437	.812	3.250
320-2077	D	3.937	.473	3.125
320-2086	A	5.625	.600	4.127
320-2091	A	5.500	.600	4.166
320-2096	B	6.250	1.063	5.126

⊗ Discontinued

STEMCO Seal Number	Type	A for Bore Diameter	B Width	C for Axle Ring O.D. +/- .010
320-2097	J3	7.375	.750	5.377
320-2099	K	7.250	.828	5.377
320-2102	B	5.250	1.043	3.972
320-2104	C1	5.500	1.000	4.041
320-2105	B	4.175	.780	2.980
320-2106	N	6.310	1.141	4.872
320-2109	N	5.750	.866	4.127
320-2110	N	6.000	.818	4.733
320-2111	C1	7.135	1.093	5.377
320-2113	N	6.000	1.062	4.629
320-2114	N	6.000	1.062	4.481
320-2115	N	6.000	1.062	4.871
320-2117	J1	6.064	.583	4.377
320-2118	N	5.753	.912	4.480
320-2119	B1	4.450	.816	3.623
320-2125	B1	4.437	.816	3.623
320-2129	N	5.750	.825	4.615
320-2131	N	6.250	1.023	4.485
320-2133	B1	4.542	.816	3.623
320-2136	A	4.500	.625	3.247
320-2137	N	5.903	1.056	4.485
320-2162	C1	7.000	1.320	4.872
320-2164	B	3.875	.750	2.980
320-2166	N	6.125	.724	4.955
320-2173	N	6.032	.875	4.377
320-2181	B1	5.372	.937	4.600
320-2199	N	5.875	.903	4.600
320-2213	J1	6.251	.562	4.377
320-2216	N	5.000	.820	3.732
320-2233	N	5.906	.913	4.818

Voyager®/Discover® Oil Seal Dimensions by Part Number

Voyager®/Discover® Seal Number	Type	A for Bore Diameter	B Width	C for Shoulder O.D.
373-0113	L2	5.750	.940	4.000
373-0123	L1	6.008	.995	4.250
373-0143	L1	6.000	.981	4.625
373-0144	L3	5.753	.993	4.375
373-0191	L2	6.032	.960	4.250
383-0101	L2	5.625	.625	4.000
383-0136	L1	4.840	.932	3.500
383-0139	L2	5.120	.968	4.000
383-0153	L3	5.375	.975	4.500
383-0156	L2	5.875	.988	4.500
383-0164	L2	5.903	1.030	4.375
383-0166	L3	3.875	.750	2.875
383-0171	L2	5.000	.820	3.625
383-0175	L2	3.939	.500	2.359
383-0176	L2	4.725	.563	2.948
393-0103	L2	5.750	1.006	4.500

Voyager®/Discover® Seal Number	Type	A for Bore Diameter	B Width	C for Shoulder O.D.
393-0104	L2	6.250	1.290	4.250
393-0112	L2	5.690	.820	3.875
393-0115	L3	5.500	.705	3.875
393-0134	L2	6.000	.790	4.875
393-0148	L2	7.375	1.000	5.250
393-0173	L1	6.310	1.127	4.767
373-0213	L2	5.750	.940	4.000
373-0223	L1	6.008	.995	4.250
373-0243	L1	6.000	.981	4.625
383-0236	L1	4.840	.932	3.500
383-0239	L2	5.120	.968	4.000
383-0264	L2	5.903	1.030	4.375
393-0203	L2	5.750	1.006	4.500
393-0204	L2	6.250	1.290	4.250
393-0273	L2	6.310	1.127	4.767
393-0212	L2	5.690	.820	3.875

1 383-0139 must be used with 310-1132 ring, available in Kit #383-8139.

2 383-0239 must be used with 310-1132 ring, available in Kit #383-8239.

Oil Seal Specifications

Guardian® Hub Oil Seal Dimensions By Bore Diameter

A for Bore Diameter	Guardian® Type	B Width	C for Shoulder O.D.	Guardian® Seal Number
3.875	D7	.495	2.875	308-0866
4.542	B7	.760	3.500	308-0863
4.750	D7	.541	3.437	309-0935
4.840	CB7	.840	3.500	308-0836
5.372	D7	.518	4.500	308-0853
5.500	E7	.736	3.875	309-0915
5.500	E7	.745	3.937	309-0957
5.512	E7	.820	3.937	308-0870
5.690	E7	.555	3.875	309-0912
5.750	E7	.604	4.000	307-0713
5.750	D7	.516	4.500	309-0903
5.753	C7	1.015	4.375	307-0744
5.875	CB7	.820	4.500	308-0855 1

A for Bore Diameter	Guardian® Type	B Width	C for Shoulder O.D.	Guardian® Seal Number
5.875	CB7	.820	4.500	308-0856 2
5.903	E7	.955	4.375	308-0864
6.000	D7	.584	4.625	307-0743
6.008	E7	.563	4.250	307-0723
6.064	E7	.562	4.262	309-0961
6.250	E7	.548	4.250	309-0904
6.250	E7	.600	4.500	309-0964
6.250	E7	.600	4.375	309-0965
6.251	D7	.668	4.767	309-0960
6.310	C7	.910	4.767	309-0973
7.000	C7	1.175	4.767	309-0970
7.375	E7	.735	5.250	309-0948

1 Deflector ring width is .885. 2 Deflector ring width is .685.

Oil Seal Dimensions By Bore Diameter

A for Bore Diameter	Seal Type	B Width	C for Axle Ring O.D. +/- .010	STEMCO Oil Seal Number
3.671	B1	.843	2.775	320-2056 ☒
3.875	B	.750	2.980	320-2164
3.937	D	.473	3.125	320-2077
4.125	B	.780	2.980	320-2018
4.125	B1	.664	3.361	320-2050 ☒
4.175	B	.780	2.980	320-2105 ☒
4.437	B	.812	3.250	320-2072 ☒
4.437	B	.812	3.358	320-2017 ☒
4.437	B1	.816	3.623	320-2125 ☒
4.450	B1	.816	3.623	320-2119 ☒
4.500	A	.625	3.187	320-2022 ☒
4.500	A	.625	3.247	320-2136 ☒
4.542	B1	.816	3.623	320-2133
4.625	C1	.934	3.623	320-2057 ☒
4.812	B	.875	3.730	320-2034 ☒
4.840	N	.875	3.625	320-2036 ☒
5.000	E	.539	3.623	320-2032 ☒
5.000	A	.734	4.623	320-2051 ☒
5.000	A	.890	3.623	320-2031
5.000	N	.820	3.732	320-2216 ☒
5.003	A	.890	3.623	320-2046 ☒
5.125	B	.984	4.041	320-2039 ☒
5.250	B	1.043	3.972	320-2102
5.372	B1	.937	4.600	320-2181
5.375	A	.947	4.041	320-2029 ☒
5.500	C1	1.000	4.041	320-2104
5.500	A	.600	4.166	320-2091 ☒
5.500	D	.565	4.600	320-2058 ☒
5.625	A	.600	4.127	320-2086 ☒
5.690	A	.612	4.041	320-2012 ☒

A for Bore Diameter	Seal Type	B Width	C for Axle Ring O.D. +/- .010	STEMCO Oil Seal Number
5.750	N	.866	4.127	320-2109
5.750	N	.825	4.615	320-2129
5.753	N	.912	4.480	320-2118
5.875	N	.903	4.600	320-2199
5.903	N	1.056	4.485	320-2137 ☒
5.906	N	.913	4.818	320-2233 ☒
6.000	B	1.062	4.481	320-2114
6.000	B	1.062	4.629	320-2113
6.000	N	.818	4.733	320-2110
6.000	B	1.062	4.871	320-2115
6.003	C1	.895	4.955	320-2061
6.008	N	.914	4.377	320-2023
6.032	N	.875	4.377	320-2173
6.064	J1	.583	4.377	320-2117 ☒
6.250	N	1.023	4.485	320-2131
6.250	D	.565	5.126	320-2007 ☒
6.250	B	1.063	5.126	320-2096 ☒
6.250	D	.572	5.377	320-2059
6.251	J1	.562	4.377	320-2213
6.251	C	1.127	4.955	320-2009
6.310	N	1.141	4.872	320-2106
6.312	A	1.192	4.955	320-2021 ☒
6.375	A	.864	4.955	320-2028 ☒
6.437	A	.906	4.955	320-2041
6.500	A	.906	4.955	320-2001
7.000	C1	1.320	4.872	320-2162
7.135	C1	1.093	5.377	320-2111
7.250	K	.828	5.377	320-2099
7.375	J1	.750	5.377	320-2097

☒ Discontinued

Hub Cap Specifications

Bolt-on Hub Caps By Bolt Circle

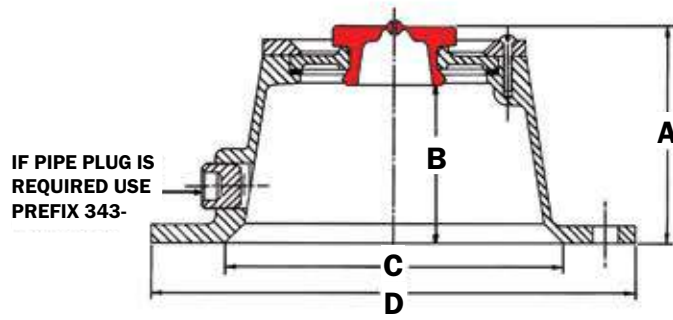

How to Determine Bolt Circle

Count the number of mounting holes; measure diameter of bolts; measure bolt circle (select 2 holes opposite each other and measure from the center of one bolt to the center of the one opposite). On odd number holes, measure inside diameter of hub and add twice the distance from the bore to the center of bolt hole.

Bolt Circle	Bolt Size	No. of Bolts	A Height	B Inside Depth	C Flange I.D.	D Flange O.D.	Hub Cap Includes Gasket	Gasket Number
3-5/8	5/16	4	2-1/4	1-1/2	2-1/2	4-1/2	340-4065	330-3040
3-7/8	5/16	6	2-1/4	1-1/2	2-3/4	4-1/2	340-4198	330-3119
4	1/4	4	2-1/8	1-3/8	3-1/8	4-9/16	340-4157 ¹	330-3102
4-1/16	3/16	6	2-5/8	1-7/8	3-5/16	4-1/2	340-4139 ¹	330-3094
4-1/2	5/16	6	2-5/8	1-7/8	3-1/2	5-1/4	340-4024	330-3024
4-1/2	5/16	6	2-5/8	1-7/8	3-1/2	5-1/4	343-4308	330-3024
4-1/2	6mm	6	2-5/8	1-7/8	3-1/2	5-1/4	340-4263	330-3024
5	1/4	4	3-1/8	2-3/8	4	5-3/4	340-4028	330-3028
5	5/16	4	2-1/8	1-3/8	4	5-3/4	340-4186	330-3120
5-1/8	5/16	6	2-7/8	2-1/8	3-3/4	5-3/4	340-4066	330-3041
5-1/8	5/16	6	1-7/8	1-1/8	4	5-11/16	340-4042	330-3041
5-1/4	3/8	3	2-7/8	2-1/8	4-3/8	6	340-4002	330-3002
5-1/4	3/8	3	3-1/2	2-3/4	4-1/8	Not Round	340-4019	330-3019
5-1/4	5/16	6	2-7/8	2-1/8	4-3/8	6	340-4031	330-3031
5-1/2	5/16	6	1-1/4	1-1/8	4-7/16	6-3/16	340-4098	330-3009
5-1/2	5/16	5	2-11/16	1-15/16	4-3/8	6-1/4	340-4013	330-3013
5-1/2	5/16	6	1-13/16	1-11/16	4-7/16	6-3/16	340-4249 ²	330-3122
5-1/2	5/16	6	1-13/16	1-1/16	4-9/16	6-3/16	340-4095	330-3009
5-1/2	5/16	6	2-5/16	1-9/16	4-9/16	6-3/16	340-4046	330-3009
5-1/2	5/16	6	2-11/16	1-15/16	4-3/8	6-1/4	340-4009	330-3009
5-1/2	5/16	6	2-11/16	1-15/16	4-3/8	6-1/4	343-4122	330-3009
5-1/2	5/16	6	1-13/16	1-1/16	4-9/16	6-3/16	343-4309	330-3009
5-1/2	5/16	6	2-11/16	1-15/16	4-3/8	6-1/4	343-4342	330-3009
5-17/32	3/8	6	1-13/16	1-9/16	4-7/16	6-3/16	343-4250 ²	330-3122
5-17/32	3/8	6	2-5/16	1-9/16	4-9/16	6-3/16	343-4281 ²	330-3122
5-9/16	5/16	6	1-13/16	1-11/16	4-7/16	6-3/16	340-4249 ²	330-3122
5-9/16	5/16	3	2-7/8	2-1/8	3-3/4	6-3/8	340-4049	330-3042
5-9/16	5/16	6	2-7/8	2-1/8	3-11/16	6-3/8	340-4149	330-3097
5-7/8	5/16	6	1-3/8	5/8	4-1/4	6-1/2	343-4025 ²	330-3025
5-7/8	5/16	6	1-5/8	1-7/16	4-1/2	6-37/64	340-4092	330-3025
5-7/8	5/16	6	2-3/8	1-5/8	5-1/8	Not Round	340-4036	330-3035
6	5/16	6	2-5/8	1-7/8	5	6-3/4	340-4059	330-3056

¹ Cannot be made with pipe plug.







² Made with pipe plug only.

³ Fits 5-1/2 and 5-9/16 bolt circles.

(Continued Next Page)

Hub Cap Specifications

Bolt-on Hub Caps By Bolt Circle

Bolt Circle	Bolt Size	No. of Bolts	A Height	B Inside Depth	C Flange I.D.	D Flange O.D.	Hub Cap Includes Gasket	Gasket Number
6	5/16	6	2-1/2	1-3/4	4-15/16	6-7/8	343-4176	330-3060
6	3/8	6	3-3/16	2-3/8	4-15/16	6-7/8	343-4080 	330-3060
6-1/8	3/8	3	2-11/16	1-15/16	4-5/16	7	340-4011	330-3011
6-1/8	5/16	6	2-11/16	1-15/16	4-5/16	7	340-4163 	330-3104
6-5/8	1/4	6	2-13/16	2-1/16	5-5/16	7-1/8	340-4034	330-3034
6-3/4	5/16	6	3-11/16	2-15/16	5-7/16	7-1/2	340-4195	330-3118
6-3/4	3/8	6	2-11/16	1-15/16	5	7-3/4	343-4064 	330-3079
6-7/8	7/16	7	2-11/16	1-15/16	5	7-3/4	340-4082	330-3062
7	5/8	8	2-1/16	1-5/16	4-5/16	8-1/4	340-4119 	330-3090
7	13/16	8	2-1/16	1-5/16	4-5/16	8-1/4	340-4305 	330-3090
7-1/4	1/4	6	2-7/8	2-1/8	6-1/4	7-7/8	343-4107 	330-3084
110/mm	8.5mm	6	67.3mm	47.0mm	88.4mm	133.3mm	343-4295 	330-3130

 Cannot be made with pipe plug.

 Made with pipe plug only.

4009 Hub Cap Variations

Application	Part Number	Description
Oil	343-4350	Cast aluminum hub cap with PSI face & side fill plug
Oil	347-4009	Cast aluminum hub cap with hubo window & side fill plug
Oil	348-4009	Cast aluminum hub cap with Sentinel® Technology and side fill plug
Oil	356-4009	Integrated Sentinel®
Grease/Oil	340-4009	Cast aluminum hub cap with large red fill plug & no side fill plug
Grease/Oil	343-4009	Cast aluminum hub cap with large red fill plug & side fill plug
Grease/Oil	300-4009	Cast aluminum hub cap with large red fill plug & no side fill plug in 50 unit bulk pack
Grease/Oil	303-4009	Cast aluminum hub cap with large red fill plug & side fill plug in 50 unit bulk pack
Grease	340-4350	Cast aluminum hub cap with PSI face & no side fill plug
Grease	340-5096	Stamped steel hub cap with vent
Grease	340-5097	Stamped steel hub cap with no vent
Grease	342-4009	Cast aluminum hub cap with dirt exclusion window & no side fill plug
Grease	347-4278	Cast aluminum hub cap with hubo window & no side fill plug
Grease	347-5096	Stamped steel hub cap with hubo mounting hole & vent
Grease	349-4009	Cast aluminum hub cap with Sentinel® Technology and no side fill plug
Grease	352-4009	Cast aluminum hub cap with solid top (duckbill vent) & no side fill plug
Grease	358-4009	Integrated Sentinel®

Bulk Hub Caps

STEMCO Part Number	Standard Part Number	Bulk Quantity	Gasket Number
300-4009	340-4009	25	330-3009 (Included)
303-4009	343-4009	25	330-3009 (Included)
300-5097	340-4009	25	330-3009 (Included)

Hub Cap Specifications

Hub Caps By Cap Number

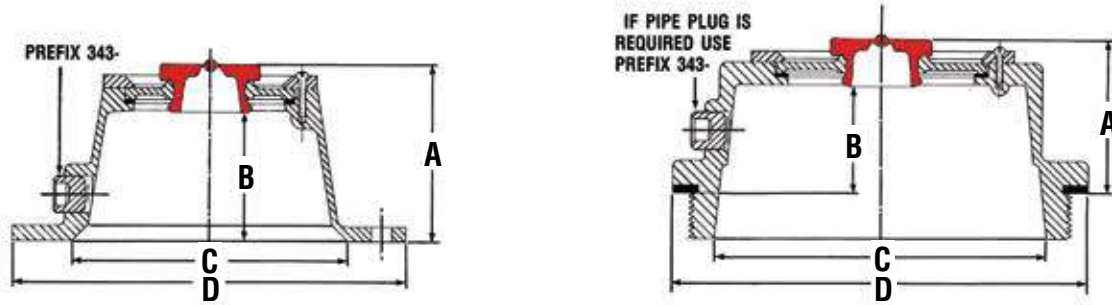

Hub Cap Includes Gasket	Bolt Circle	Bolt Size	No. of Bolts	A Height	B Inside Depth	C Flange I.D.	D Flange O.D.	Gasket Number	Window Kit
340-4002	5-1/4"	3/8"	3	2-7/8"	2-1/8"	4-3/8"	6"	330-3002	359-5999
340-4009 ⁴	5-1/2"	5/16"	6	2-11/16"	1-15/16"	4-3/8"	6-1/4"	330-3009	359-5995
340-4011	6-1/8"	3/8"	3	2-11/16"	1-15/16"	4-5/16"	7"	330-3011	359-5995
340-4013 ⁴	5-1/2"	5/16"	5	2-11/16"	1-15/16"	4-3/8"	6-1/4"	330-3013	359-5995
340-4015	Blank	--	--	2-11/16"	1-15/16"	4-3/8"	6-1/4"	330-3015	359-5995
340-4019	5-1/4"	3/8"	3	3-1/2"	2-3/4"	4-1/8"	Not Round	330-3019	359-5995
340-4024	4-1/2"	5/16"	6	2-5/8"	1-7/8"	3-1/2"	5-1/4"	330-3024	359-5999
343-4025 ²	5-7/8"	5/16"	6	1-3/8"	5/8"	4-1/4"	6-1/2"	330-3025	359-5999
340-4028	5"	1/4"	4	3-1/8"	2-3/8"	4"	5-3/4"	330-3028	359-5999
340-4031	5-1/4"	5/16"	6	2-7/8"	2-1/8"	4-3/8"	6"	330-3031	359-5999
340-4034	6-5/8"	1/4"	6	2-13/16"	2-1/16"	5-5/16"	7-1/8"	330-3034	359-5999
340-4036	5-7/8"	5/16"	6	2-3/8"	1-5/8"	5-1/8"	Not Round	330-3035	359-5995
340-4042	5-1/8"	5/16"	6	1-7/8"	1-1/8"	4"	5-11/16"	330-3041	359-5999
340-4046	5-1/2"	5/16"	6	2-5/16"	1-9/16"	4-9/16"	6-3/16"	330-3009	359-5995
340-4054 ¹	Blank	None	--	2-1/8"	1-3/8"	4-1/32"	8-5/8"	330-3017	359-5995
340-4059	6"	5/16"	6	2-5/8"	1-7/8"	5"	6-3/4"	330-3056	359-5995
343-4064 ²	6-3/4"	3/8"	6	2-11/16"	1-15/16"	5"	7-3/4"	330-3079	359-5995
340-4065	3-5/8"	5/16"	4	2-1/4"	1-1/2"	2-3/4"	4-1/2"	330-3040	359-5990
340-4066	5-1/8"	5/16"	6	2-7/8"	2-1/8"	3-3/4"	5-3/4"	330-3041	359-5999
340-4075 ⁴		6-1/4 x 8 UN (M)		2-5/16"	1-9/16"	5-3/4"	6-7/8"	330-3077	359-5995
343-4080 ²	6"	3/8"	6	3-3/16"	2-3/8"	4-15/16"	6-7/8"	330-3060	359-5999
340-4082	6-7/8"	7/16"	7	2-11/16"	1-15/16"	5"	7-3/4"	330-3062	359-5995
340-4092	5-7/8"	5/16"	6	1-5/8"	1-7/16"	4-1/2"	6-37/64"	330-3025	359-5912
340-4095	5-1/2"	5/16"	6	1-13/16"	1-1/16"	4-9/16"	6-3/16"	330-3009	359-5995
340-4098	5-1/2"	5/16"	6	1-1/4"	1-1/8"	4-7/16"	6-3/16"	330-3009	359-5912
343-4107 ²	7-1/4"	1/4"	6	2-7/8"	2-1/8"	6-1/4"	7-7/8"	330-3084	359-5995
340-4119 ¹	7"	5/8"	8	2-1/16"	1-5/16"	4-5/16"	8-1/4"	330-3090	359-5995
343-4122 ⁵	5-1/2"	5/16"	6	2-11/16"	1-15/16"	4-3/8"	6-1/4"	330-3009	359-5995
340-4139 ²	4-1/16"	3/16"	6	2-5/8"	1-7/8"	3-5/16"	4-1/2"	330-3094	359-5999
340-4149	5-9/16"	5/16"	6	2-7/8"	2-1/8"	3-11/16"	6-3/8"	330-3097	359-5999
340-4157 ¹	4"	1/4"	4	2-1/8"	1-3/8"	3-1/8"	4-9/16"	330-3102	NONE
340-4163 ¹	6-1/8"	5/16"	6	2-11/16"	1-15/16"	4-5/16"	7"	330-3104	359-5995
343-4176	6"	5/16"	6	2-1/2"	1-3/4"	4-15/16"	6-7/8"	330-3060	359-5999

¹ Cannot be made with pipe plug.

² Made with pipe plug only.

⁴ Hub cap available with hubo window, order 347-prefix. Also available 347-4342, which is 4195 hub cap for grease applications and 347-4343 which is 4075 hub cap for grease applications, 347-4278 for 4009 grease hub cap application.

⁵ 4009 hub cap with magnetic pipe plug (359-5984).

(Continued Next Page)

Hub Cap Specifications

Hub Caps By Cap Number (Cont.)

Hub Cap Includes Gasket	Bolt Circle	Bolt Size	No. of Bolts	A Height	B Inside Depth	C Flange I.D.	D Flange O.D.	Gasket Number	Window Kit
340-4186	5"	5/16"	4	2-1/8"	1-3/8"	4"	5-3/4"	330-3120	359-5999
340-4195 ⁴	6-3/4"	5/16"	6	3-11/16"	2-15/16"	5-7/16"	7-1/2"	330-3118	359-5995
340-4198	3-7/8"	5/16"	6	2-1/4"	1-1/2"	2-3/4"	4-1/2"	330-3119	NONE
340-4249 ⁸	5-1/2"	5/16"	6	1-13/16"	1-11/16"	4-7/16"	6-3/16"	330-3122	359-5912
343-4250 ^{2 7}	5-17/32"	3/8"	6	1-13/16"	1-9/16"	4-7/16"	6-3/16"	330-3122	NONE
340-4263 ¹	4-1/2"	6mm	6	2-5/8"	1-7/8"	3-1/2"	5-1/4"	330-3024	359-5999
343-4281 ⁸	5-17/32"	3/8"	6	2-5/16"	1-9/16"	4-9/16"	6-3/16"	330-3122	359-5995
343-4295 ²	110mm	8.5mm	6	67.3mm	47.0mm	88.4mm	133.3mm	330-3130	359-5999
343-4308 ^{2 10}	4-1/2"	5/16"	6	2-5/8"	1-7/8"	3-1/2"	5-1/4"	330-3024	NONE
343-4309 ^{2 8}	5-1/2"	5/16"	6	1-13/16"	1-1/16"	4-9/16"	6-3/16"	330-3009	359-6100
340-4320 ¹	"	6-1/4 x 8 UN (M)		2-5/16"	1-9/16"	5-3/4"	6-7/8"	330-3077	NONE
343-4342 ^{2 9}	5-1/2"	5/16"	6	2-11/16"	1-15/16"	4-3/8"	6-1/4"	330-3009	359-6100
340-4975 ^{1 10}		6-1/4 x 8 UN (M)		2-5/16"	1-9/16"	5-3/4"	6-7/8"	330-3077	NONE
340-4976 ^{1 10}		6-1/4 x 8 UN (M)		2-5/16"	1-9/16"	5-3/4"	6-7/8"	330-3077	NONE
340-4977 ^{1 1}		6-1/4 x 8 UN (M)		2-5/16"	1-9/16"	5-3/4"	6-7/8"	330-3077	NONE
343-5111	3-5/8"	5/16"	4	2-1/4"	1-1/2"	2-3/4"	4-1/2"	330-3040	NONE

¹ Cannot be made with pipe plug.

² Made with pipe plug only.

⁸ Hub cap can be used with 5-1/2 or 5-9/16 bolt circle with 5/16 inch bolts.

⁴ Hub cap available with hubo window, order 347-prefix. Also available 347-4342, which is 4195 hub cap for grease applications, 347-4343 which is 4075 hub cap for grease applications and 347-4278 which is 4009 hub cap for grease applications. Also available with hubo window when ordered with 347 prefix. See options below.

⁶ Lexan hub caps, order in multiples of 25.

⁷ 4249 with recessed vent plug.

⁸ 4095 with small vent plug 359-5915.

⁹ 4009 with small vent plug 359-5915.

¹⁰ 4024 with small vent plug.

¹¹ 4975 individually boxed.

Torque Specifications

Hub Cap Mounting Bolts			
Bolt Size	Torque	Bolt Size	Torque
3/16"	8-10 ft. lbs.	1/2"	20-24 ft. lbs.
1/4"	8-12 ft. lbs.	3/4"	24-28 ft. lbs.
5/16"	12-16 ft. lbs.	7/8"	26-30 ft. lbs.
3/8"	16-20 ft. lbs.	6 MM	8-12 ft. lbs.
7/16"	18-22 ft. lbs.	8.5 MM	12-16 ft. lbs.

Threaded Hub Caps	
Part No.	Part No.
XXX-4075	100 ft. lbs.
340-4975	50-60 ft. lbs.
340-4976	50-60 ft. lbs.
640-0003	50-60 ft. lbs.

Hubo Window Options		
STEMCO Base Part No.	Grease Cap Part No.	Oil Cap Part No.
4009	347-4278	347-4009
4075	347-4343	347-4075
4195	347-4342	347-4195

Hub Cap Components		
Part No.	Description	Torque
359-6032	#8 Torx Screw	25 in. lbs. Maximum
359-5984	3/8" Mag Plug	5-9 ft. lbs. Maximum
359-5985	3/8" Pipe Plug	5-9 ft. lbs. Maximum

EXTEND SEAL & BEARING LIFE BY PREVENTING CONTAMINATION



SENTINEL®

Sentinel® Technology provides an unmatched filtering system to eliminate contamination of lubricant from grime, dirt or water.

Sentinel® Hub Cap

Provides a tamper-proof hub cap system for maximum protection and maintenance-free performance.

Integrated Sentinel® Hub Cap

Tamper-proof hub cap that integrates the Sentinel® features into the window with fewer components and greater wheel end visibility.

Sentinel® ESP (Extended Service Plug)

Allows economical retrofitting of wheel ends with the benefits of STEMCO's exclusive Sentinel® Technology.

Sentinel® ESP Filtered Vent

Drive axles to be retrofitted to benefit from STEMCO's exclusive Sentinel® Technology.



How Sentinel® Technology Works

- To relieve vacuum, the Sentinel® interior check valve lifts slightly, drawing air through the water-resistant expanded PTFE fabric filter into the wheel end, while the duck-bill check valve remains closed, blocking dirt, grime and other contaminants from entering.
- An added O-ring increases plug retention.
- To relieve pressure, the Sentinel® duck-billed pressure relief valve opens, allowing pressure to vent out, while the umbrella check valve remains closed, stopping lubricant from leaking out and contaminants from flowing in.

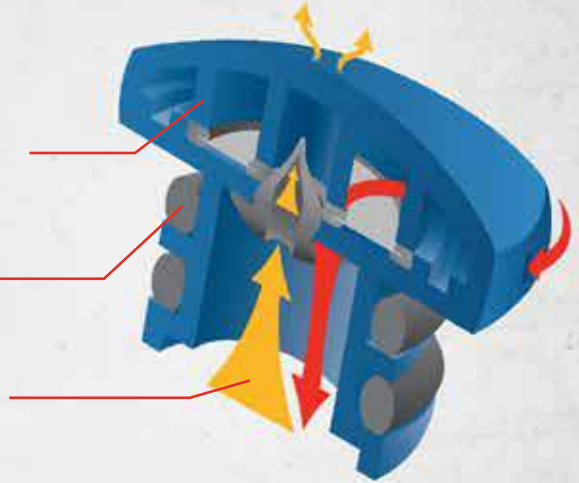

Sentinel® Technology

- Prevents dirt and water from contaminating the oil, thereby extending seal and bearing life.
- Dramatically reduces contaminant build-up on hub cap windows, allowing for an accurate determination of lube levels.
- Eliminates early oil breakdown by preventing water contamination as a result of submerged axles.
- Provides maximum protection for maintenance-free wheel end systems.
- Improves performance and lowers overall maintenance costs.

Sentinel® Hub Cap

STEMCO Base Part No.	Oil Cap	Grease Cap	Bolt Circle	Bolt Size	No. of Bolts	Gasket No.	Oil Window Kit	Grease Window Kit
4009	348-4009	349-4009	5-1/2"	5/16"	6	330-3009	359-6112	359-6120
4013	348-4013	349-4013	5-1/2"	5/16"	5	330-3013	359-6112	359-6120
4046	348-4046	349-4046	5-1/2"	5/16"	6	330-3009	359-6112	359-6120
4075	348-4075	349-4075		6-1/4" x 8 UN(M)		330-3077	359-6112	359-6120
4095	348-4095	349-4095	5-1/2"	5/16"	6	330-3009	359-6112	359-6120
4195	348-4195	349-4195	6-3/4"	5/16"	6	330-3118	359-6112	359-6120
4281	348-4281	N/A	5-17/32"	3/8"	6	330-3122	359-6112	359-6120



Window kit consists of window, gasket, window ring assembly/gasket and Sentinel Cap Cover P/N **359-6103**.

Integrated Sentinel® Hub Cap

STEMCO Base Part No.	Oil Cap	Grease Cap	Bolt Circle	Bolt Size	No. of Bolts	Gasket No.	Oil Window Kit	Grease Window Kit
4009	356-4009	358-4009	5-1/2"	5/16"	6	330-3009	359-6145	359-6146
4013	356-4013	358-4013	5-1/2"	5/16"	5	330-3013	359-6145	359-6146
4024	356-4024	358-4024	4-1/2"	5/16"	6	330-3024	359-6143	359-6144
4025	356-4025	358-4025	5-7/8"	5/16"	6	330-3025	359-6143	359-6144
4046	356-4046	358-4046	5-1/2"	5/16"	6	330-3009	359-6145	359-6146
4075	356-4075	358-4075		6-1/4" x 8 UN(M)		330-3077	359-6145	359-6146
4080	356-4080	358-4080	6	3/8"	6	330-3060	359-6143	359-6144
4095	356-4095	358-4095	5-1/2"	5/16"	6	330-3009	359-6145	359-6146
4119	356-4119	358-4119	7	5/8"	8	330-3090	359-6145	359-6146
4150	356-4150	358-4150	4-1/2"	5/16"	5	330-3150	359-6143	359-6144
4195	356-4195	358-4195	6-3/4"	5/16"	6	330-3118	359-6145	359-6146



Hub Cap Specifications



Sentinel® ESP (EXTENDED SERVICE PLUG)

STEMCO Part No.	Description
359-6124	ESP Plug Blister Pack (2/pk)
359-6125	ESP Plugs Bulk Pack of 50



Sentinel® ESP Filtered Vent

STEMCO Part No.	Description
359-6137	Drive Axle Breather Vent (3/8" adapter)



350-4065

Hub Caps with Sentinel® ESP Plug

Sentinel® ESP Part No.	Description	Bolt Circle	Bolt Size	No. of Bolts	Gasket Part No.
350-4065 ¹	4065 Cap, no side fill plug	3-5/8"	5/16"	4	330-3040
353-4065 ¹	4065 Cap, with side fill plug	3-5/8"	5/16"	4	330-3040

¹ Cannot use standard 340 or 343-4065 cap with ESP™ Plug. The casting has been modified to accept the ESP™, therefore the above part numbers must be ordered to use this application with the ESP™ Plug.

Bulk Pack Hub Caps with Sentinel® ESP Plug

Sentinel® ESP Part No.	Description	Bolt Circle	Bolt Size	No. of Bolts	Gasket Part No.
300-5009	4009 Cap, no side fill plug Bulk Pack (25/Box)	5-1/2"	5/16"	6	330-3009
303-5009	4009 Cap, with side fill plug Bulk Pack (25/Box)	5-1/2"	5/16"	6	330-3009

PSI Ready Hub Cap



Grease
Hub Cap
340 Series

STEMCO Base Part No.	Grease Cap	Oil Cap	Oil Cap with Magnetic Pipe Plug
4009	340-4370	343-4370	343-4373
4075	340-4371	343-4371	343-4374
4195	340-4372	343-4372	343-4375
4384	340-4384	N/A	N/A
Window Kits	359-6141	359-6140	—



Oil
Hub Cap
343 Series

Window kit consists of window, gasket and PSI retainer ring/gasket.

Hubo Bracket for Sentinel® and PSI Hub Caps

STEMCO Part No.	STEMCO Base Part No.	PSI Hub Cap Part No. (Grease)	PSI Hub Cap Part No. (Oil)	Stud Size	Height
610-0084	4195	340-4372	343-4372	5/16"	5"
610-0028	4009	340-4370	343-4370	5/16"	5"
610-0090	4075	340-4371	343-4371	²	1 7/8"

² Bracket mounts on top of window ring w/4 replacement screws included w/bracket.

Hub Cap Specifications

Popular Hub Cap Options with Bolt Specifications

STEMCO Base Part No.	Prefix												
	4009	4013	4024	4046	4075	4095	4195	4249	4281	4370	4371	4372	
Standard Hub Cap, No Side Fill	340	■	■	■	■	■	■	■	■		■	■	■
Dirt Exclusion, Grease	342	■	■	■		■	■	■	■				
Standard Hub Cap, Side Fill	343	■	■	■	■	■	■	■	■		■	■	■
Standard Hub Cap, Hubo Window	347	■	■			■	■	■					
Sentinel® Hub Cap	348	■	■		■	■	■	■		■			
Sentinel® Hub Cap Grease	349	■	■		■	■	■	■		■			
Solid Aluminum Grease / Vented	352	■					■	■					
Integrated Sentinel® Oil	356	■	■	■	■	■	■	■					
Integrated Sentinel® Grease	358	■	■	■	■	■	■	■					
Bolt Circle		5-1/2"	5-1/2"	4-1/2"	5-1/2"			6-3/4"	5-1/2"	5-17/32"	5-1/2"		6-3/4"
Bolt Size		5/16"	5/16"	5/16"	5/16"	6-1/4" x 8 UN(M)	5-1/2" x 5/16"	5/16"	5/16"	3/8"	5/16"	6-1/4" x 8 UN(M)	5/16"
Number of Bolts		6	5	6	6			6	6	6	6		6

■ PSI Hub Cap

Hub Cap Crossover

Competitive Part No.	Competitor's Name	STEMCO Part No.	Competitive Part No.	Competitor's Name	STEMCO Part No.	Competitive Part No.	Competitor's Name	STEMCO Part No.
1282	C/R	340-4975	401911P	Mechanex/Barrier	340-4975	DG-6F4.5	Dual Dynamics	340-4024
1612	C/R	343-4024	506085	Eaton	343-4024	DG-6F4.5P	Dual Dynamics	343-4013
1623	C/R	343-4066	506089	Eaton	343-4249	DG-6F4.5PC	Dual Dynamics	343-4024
1627	C/R	343-4019	64002	TriSeal	343-4019	DG-6F4.5S	Dual Dynamics	347-4075
1642	C/R	343-4013	64009	TriSeal	343-4009	DG-6FL	Dual Dynamics	340-4249
1643	C/R	343-4249	64009H	TriSeal	347-4009	DG-6FP	Dual Dynamics	347-4009
1665	C/R	343-4042	64013	TriSeal	343-4013	DG-6FPC	Dual Dynamics	340-4024
1681	C/R	343-4186	64024	TriSeal	343-4024	DG-6P	Dual Dynamics	340-4009
1682	C/R	343-4075	64029	TriSeal	343-4186	DG-6PS	Dual Dynamics	343-4009
1696	C/R	343-4195	64034	TriSeal	343-4034	DG-6PSC	Dual Dynamics	340-4046
1703	C/R	343-4249	64042	TriSeal	343-4042	DG-7.5P	Dual Dynamics	340-4195
1711	C/R	343-4024	64046	TriSeal	343-4046	DG-7.5PS	Dual Dynamics	343-4195
1723	C/R	343-4066	64046	TriSeal	343-4095	DG-P	Dual Dynamics	340-4075
1727	C/R	343-4019	64046	TriSeal	343-4249	DG-PS	Dual Dynamics	343-4075
1742	C/R	343-4013	64066	TriSeal	343-4066	DG-PSC	Dual Dynamics	343-4249
1743	C/R	343-4009	64075A	TriSeal	343-4075	H075	National	343-4075
1743	C/R	343-4046	64075G	TriSeal	342-4075	HS1643	Mechanex/Barrier	343-4249
1743	C/R	343-4095	64075P	TriSeal	340-4975	HU009A	National	343-4009
1753	C/R	343-4249	64249	TriSeal	343-4249	HU009A	National	343-4046
1765	C/R	343-4042	812928	Eaton	343-4095	HU013A	National	343-4013
1770	C/R	343-4034	815214	Eaton	343-4195	HU019A	National	343-4019
1781	C/R	343-4186	821338	Eaton	343-4009	HU024A	National	343-4024
1788	C/R	343-4249	821907	Eaton	343-4009	HU028A	National	343-4186
1800	C/R	347-4009	C40-4009	C/R	340-4009	HU034A	National	343-4034
1801	C/R	347-4013	C40-4009BP	C/R	300-4009	HU042A	National	343-4042
1811	C/R	343-4024	C40-4975	C/R	340-4975	HU066A	National	343-4066
1823	C/R	343-4042	C40-4975BP	C/R	340-4975	HU110A	National	343-4095
1842	C/R	343-4013	C40-5097BP	C/R	340-5097	HU110A	National	343-4249
1843	C/R	343-4009	C43-4009	C/R	343-4009	P411601	Mechanex/Barrier	343-4009
1843	C/R	343-4046	C43-4009BP	C/R	303-4009	P411605	Mechanex/Barrier	343-4095
1843	C/R	343-4095	C43-4013	C/R	343-4013	P411605	Mechanex/Barrier	343-4249
1865	C/R	343-4066	C43-4024	C/R	343-4024	P411608	Mechanex/Barrier	343-4013
1870	C/R	343-4034	C43-4042	C/R	343-4042	P411620	Mechanex/Barrier	343-4066
1890	C/R	343-4249	C43-4075	C/R	343-4075	P411622	Mechanex/Barrier	343-4042
340-009	National	340-4009	C43-4095	C/R	343-4095	P411629	Mechanex/Barrier	343-4186
340-009BK	National	300-4009	C43-4098	C/R	343-4098	P411630	Mechanex/Barrier	343-4024
340-975	National	340-4975	C43-4249	C/R	343-4249	P411640	Mechanex/Barrier	343-4034
340-975BK	National	340-4975	DG-5/6P	Dual Dynamics	340-4013	P411655	Mechanex/Barrier	343-4075
343-009	National	343-4009	DG-5/6PS	Dual Dynamics	343-4013	P411688	Mechanex/Barrier	343-4095
343-009BK	National	303-4009	DG-6F	Dual Dynamics	340-4046	P411967	Mechanex/Barrier	343-4046

Hub Cap Specifications

Stamped Steel Grease Hub Caps



340-5094



340-5096



340-5097

Hub Cap Includes Gasket	Bolt Circle	Bolt Size	No. of Bolts	A Height	B Inside Depth	C Flange I.D.	D Flange O.D.	Gasket Number
340-5094	5-1/2"	5/16"	6	2-1/2"	2-13/32"	4-3/8"	6-1/4"	330-3009
340-5096 ¹	5-1/2"	5/16"	6	2-1/2"	2-13/32"	4-3/8"	6-1/4"	330-3009
340-5097	5-1/2"	5/16"	6	2-1/2"	2-13/32"	4-3/8"	6-1/4"	330-3009
340-0044 ²	4-1/2"	5/16"	6	2"	1-15/16"	3-5/16"	5-3/16"	330-3024

¹ With Dirt Exclusion Vent

² Painted Black

Solid Grease Hub Cap/Duckbill Vented

STEMCO Part No.	Bolt Circle	Bolt Size	No. of Bolts	Gasket Number
352-4009	5-1/2"	5/16"	6	330-3009
352-4195	6-3/4"	5/16"	6	330-3118
362-4009 ¹	5-1/2"	5/16"	6	330-3009
362-4195 ¹	6-3/4"	5/16"	6	330-3118

¹ No Duckbill Vent



352-4195

Non-Vented Grease Hub Caps

STEMCO Part No.	Application	Bolt Circle Diameter	Bolt Size	No. of Bolts	Gasket Number
340-4321	4009 "N" Series Grease-Trailer	5-1/2"	5/16"	6	330-3009
340-4322	4195 "P" Series Grease-Trailer	6-3/4"	5/16"	6	330-3118



340-4321

Dirt Exclusion Grease Hub Caps

Hub Cap Includes Gasket	Bolt Circle	Bolt Size	No. of Bolts	A Height	B Inside Depth	C Flange I.D.	D Flange O.D.	Gasket Number	Window Kit ¹
342-4009	5-1/2"	5/16"	6	2-11/16"	1-15/16"	4-3/8"	6-1/4"	330-3009	359-6095
342-4013	5-1/2"	5/16"	5	2-11/16"	1-15/16"	4-3/8"	6-1/4"	330-3013	359-6095
342-4024	4-1/2"	5/16"	6	2-5/8"	1-7/8"	3-1/2"	5-1/4"	330-3024	359-6094
342-4075		6-1/4" x 8 UN(M)		2-5/16"	1-9/16"	5-3/4"	6-7/8"	330-3077	359-6095
342-4095	5-1/2"	5/16"	6	1-13/16"	1-1/6"	4-9/16"	6-3/16"	330-3009	359-6095
342-4195	6-3/4"	5/16"	6	3-11/16"	2-15/16"	5-7/16"	7-1/2"	330-3118	359-6095
342-4249	5-1/2"	5/16"	6	1-13/16"	1-11/16"	4-7/16"	6-3/16"	330-3122	359-6096



342-4009

¹ Window Kit consists of window, gasket and window ring gasket.

Hub Cap Specifications

4075 Hub Cap Variations



340-4075



570-7008



340-4975

Application	Part No.	Description
Oil	340-4975	Clear polycarbonate hub cap
Oil	343-4075	Cast aluminum hub cap with side fill plug
Oil	343-4371	Cast aluminum hub cap with PSI face & side fill plug
Oil	347-4075	Cast aluminum hub cap with hubo window and side fill plug
Oil	348-4075	Cast aluminum hub cap with Sentinel® Technology & side fill plug
Oil	353-4075	Cast aluminum hub cap with Sentinel® ESP plug & side fill plug
Oil	356-4075	Integrated Sentinel®
Grease/Oil	340-4075	Cast aluminum hub cap & no side fill plug
Grease	342-4075	Cast aluminum hub cap with dirt exclusion window
Grease	340-4320	Solid cast aluminum hub cap & no side fill plug
Grease	340-4371	Cast aluminum hub cap with PSI face & no side fill plug
Grease	340-4976	Clear polycarbonate hub cap with solid face—no vent
Grease	347-4343	Cast aluminum hub cap with hubo window and no side fill plug
Grease	349-4075	Cast aluminum hub cap with Sentinel® Technology & no side fill plug
Grease	350-4075	Cast aluminum hub cap with Sentinel® ESP & no side fill plug
Grease	358-4075	Integrated Sentinel®

Screw-on Caps must have O-rings (330-3077). Use 570-7008 tool to tighten pro-par hub caps.

Vented Hubodometer® Hub Caps

Hub Cap Includes Gasket	Gasket Part No.	Bolt Circle Diameter	Number of Holes	Bolt Diameter	Aluminum Equivalent
640-0001*	641-0005	5-1/2"	6	5/16	347-4009
640-0002*	641-0017	5-1/2"	5	5/16	347-4013
640-0003*	330-3077		6-1/4" x 8 UN(M)		347-4075



640-0001



640-0003

Accessories

Description	Part No.
1 - Pipe plug with O-ring	641-0001
2 - Magnetic Pipe Plug	359-5984
3 - Supporting hub cap flange 6 hole	641-0003

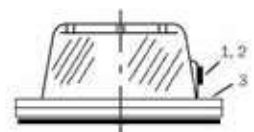

Hub Cap Specifications

Typical 4-3/8" Window Component Parts

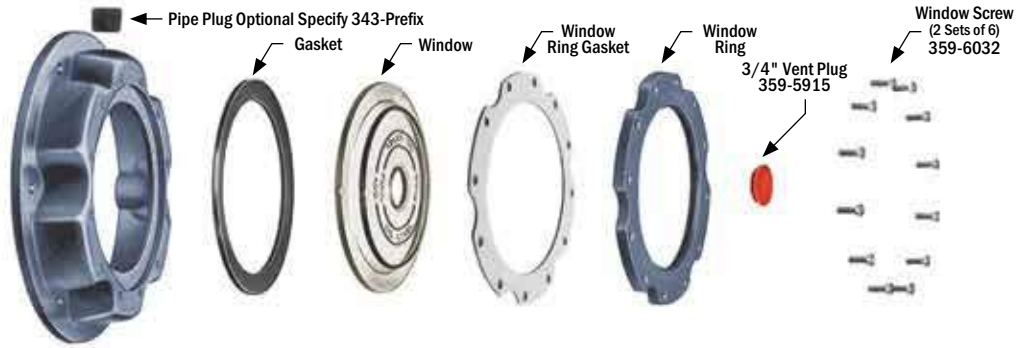

Typical 2-3/4" & 3-1/2" Window Component Parts

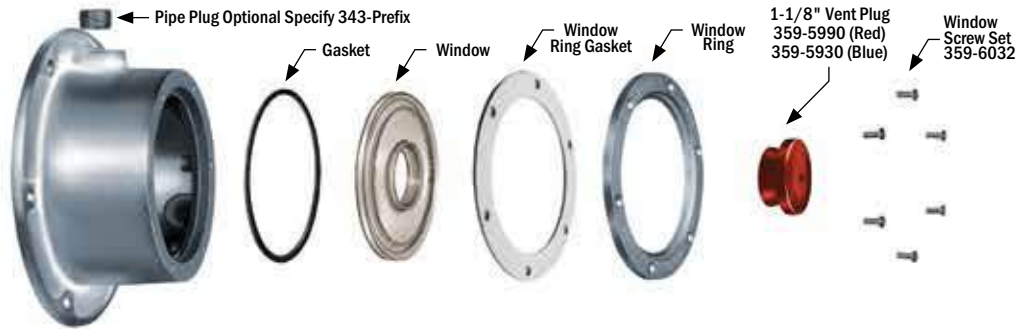

Standard Hub Cap Replacement Components

3/8" Pipe Plug ²	Gasket	Window Diameter	Window	Window Ring Gasket	Window Ring	Vent Plug	Window Kit ³	Screw Set 6/Set
359-5985	359-5996	2-3/4"	359-5983	359-3136	359-5997 ⁴	359-5990 ⁴	359-5999	359-6032
359-5985	359-5991	3-1/2"	359-5994	359-3127	359-5992	359-5990 ⁴	359-5995	359-6032
359-5985	359-5991	3-1/2"	—	359-3127	359-5992	None	359-6117	359-6032
359-5985	359-5968	4-3/8"	359-5918	359-3137	359-5970	359-5915	359-5912	359-6032 ⁴
359-5985	359-5991	3-1/2"	359-6049 ⁴	359-3127	359-5992	359-5915	359-6100 ⁴	359-6032

- ¹ Window kit consists of window, gasket, window ring gasket and vent plug.
- ² Magnetic pipe plug part number 359-5984.
- ³ 5 hole window ring.
- ⁴ Blue vent plug part number 359-5930.
- ⁵ Window with recessed vent plug.
- ⁶ Two sets required.

Dirt Exclusion Grease Hub Cap Replacement Components

Window Diameter	Window	Gasket	Window Ring	Window Ring Gasket	Screw Set 6/Set	Window Kit
2-3/4"	359-6086	359-5996	359-5997	359-3136	359-6032	359-6094
3-1/2"	359-6087	359-5991	359-5992	359-3127	359-6032	359-6095
4-3/8"	359-6088	359-5968	359-5970	359-3137	359-6032 ⁷	359-6096

- ⁷ Two sets required.

Sentinel® Hub Cap Replacement Components

Window Diameter	Window Kit ⁸	Gasket	Window Ring Gasket	Screw Set 6/Set	Magnetic Pipe Plug
3-1/2"	359-6112 ⁹	359-5991	359-3127	359-6032	359-5984
3-1/2"	359-6120 ¹⁰	359-5991	359-3127	359-6032	359-5984

- ⁸ Window kit consists of window, gasket, window ring with gasket and Sentinel® red cap cover part number 359-6103.
- ⁹ Window kit for oil application.
- ¹⁰ Window kit for grease application.

Hub Cap Specifications

Blank Hub Caps

IF PIPE PLUG IS
REQUIRED USE
PREFIX 343-

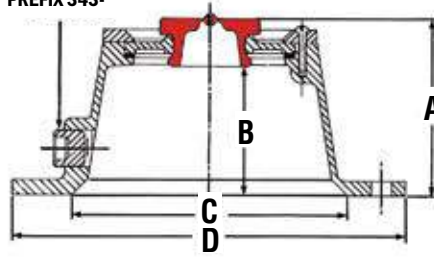

Hub Cap Includes Gasket	Bolt Circle	Bolt Size	No. of Bolts	A Height	B Inside Depth	C Flange I.D.	D Flange O.D.	Gasket Number
340-4054	None	Blank	None	2-1/8"	1-3/8"	4-1/32"	8-5/8"	330-3017

Hub Cap Interchange

This STEMCO hub cap interchange is arranged with hub caps in descending inside depth so that a cap can be replaced by any cap above it within its bolt circle group and without fear of spindle interference.

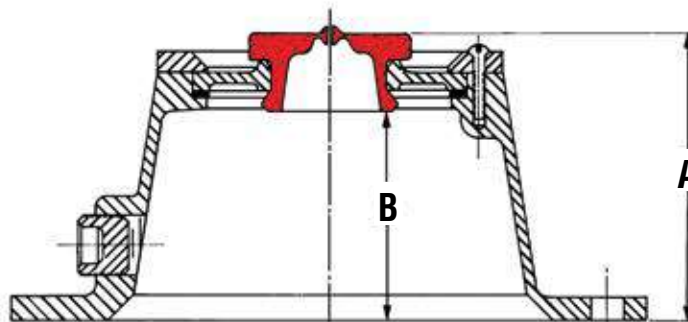

5" Bolt Circle with Four 1/4" Mounting Bolts

Cap No.	Inside (B)	Outside (A)
340-4028	2-3/8"	3-1/8"

5-9/16" Bolt Circle with Three 5/16" Mounting Bolts

Cap No.	Inside (B)	Outside (A)
340-4049	2-1/8"	2-7/8"

5-1/8" Bolt Circle with Six 5/16" Mounting Bolts

Cap No.	Inside (B)	Outside (A)
340-4066	2-1/8"	2-7/8"
340-4042	1-1/8"	1-7/8"

5-9/16" Bolt Circle with Six 5/16" Mounting Bolts

Cap No.	Inside (B)	Outside (A)
340-4149	2-1/8"	2-7/8"
340-4249 ■	1-11/16"	1-13/16"

5-1/2" Bolt Circle with Six 5/16" Mounting Bolts

Cap No.	Inside (B)	Outside (A)
340-4009	1-15/16"	2-11/16"
340-4249 ■	1-11/16"	1-13/16"
340-4046	1-9/16"	2-5/16"
340-4281 ■	1-9/16"	2-5/16"
340-4098	1-1/8"	1-1/4"
340-4095	1-1/16"	1-13/16"

5-7/8" Bolt Circle with Six 5/16" Mounting Bolts

Cap No.	Inside (B)	Outside (A)
340-4036	1-5/8"	2-3/8"
340-4092	1-7/16"	1-5/8"
343-4025	5/8"	1-3/8"

NOTE: STEMCO does not recommend vehicle widths.

■ Hub cap fits both 5-1/2" and 5-9/16" bolt circle with six 5/16" mounting bolts.

Flange Gasket Specifications

Drive Axle Flange Gasket Dimensions

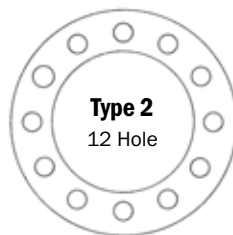
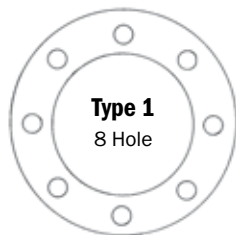

STEMCO Gasket No.	Type	I.D.	O.D.	Bolt Circle	Bolt Size	Number of Bolts
330-3036	1	5-1/2"	8-5/8"	7"	3/4"	8
330-3105	2	5-11/16"	7-7/16"	6-1/2"	1/2"	12
330-3106	1	6"	8-1/4"	7"	5/8"	8
330-3107	1	5-5/8"	8-1/2"	7"	3/4"	8
330-3108	1	4"	5-9/16"	4-3/4"	7/16"	8
330-3109	1	4-1/2"	6-1/8"	5-5/16"	1/2"	8
330-3110	1	5-3/8"	7-3/8"	6-3/8"	9/16"	8
330-3111	1	5-3/4"	8-3/8"	7"	5/8"	8
330-3112	1	4"	6-7/16"	5-1/2"	5/8"	8
330-3113	2	4-1/2"	6-1/16"	5-1/4"	1/2"	12
330-3114	2	5"	6-1/2"	5-11/16"	7/16"	12
330-3115	2	4-1/4"	6-1/8"	5-1/4"	1/2"	12

Drive Axle Flange Gasket Applications

STEMCO Part No.	Same As	Part No.	Application
330-3036	--	--	Eaton 38,000# tandem. IHC-RA355.
330-3105	Euclid	E 2340	All Meritor Standard Q wheel ends except some SQHP.
	Meritor	2208Z416	
	White	476375	
330-3106	Euclid	E 2341	All Meritor Standard R wheel ends.
	Meritor	2208W412	
330-3107	Euclid	E 2431	All E18, E19, E38D & 44D series.
	Meritor	2208X440	
330-3108	Euclid	E 2432	Eaton 15 series.
330-3109	Euclid	E 2433	Eaton 30000# Tandem Meritor Standard SFHD & H wheel ends Eaton 17000# singles.
330-3110	Euclid	E 2434	Mack 38000# Tandem axles.
330-3111	Euclid	E 2435	All Meritor Standard R wheel ends, STD series, SUD series, U wheel ends, SFD 4600, SQHP, SQ100, SQ100P, 4640 Eaton.
	Meritor	2208W413	
	Kenworth	K134 - 171	
	White	453157	
330-3112	Euclid	E 2436	IHC 34000# - RA 351 axles.
330-3113	Euclid	E 2437	Meritor Standard L-172 Eaton 18 series and 34D.
330-3114	Euclid	E 2438	Meritor Standard L wheel ends except L-172, SJHD, SLHD.
	Meritor	2208Z422	
	White	467836	
330-3115	G.M.C.	236Z158	Fits 1965 - 1974 G.M.C. - Chev. 18000# Single or 34000# Tandem Eaton 14569.

DEFEND YOUR WHEEL END

**100% Corrosion Free Hub Cap**

Stainless Steel Reinforcement Inserts

Protection Against Water and Contamination

Available with Sentinel® Technology

No More Window Leaks

Exceptional chemical bond between the hubcap body and window for strength and no leaks

Superior Sealing Performance

Between hub cap and hub due to offset sealing boss on flange

Longer Life Wheel End

Magnetic plug option pulls abrasive material away from critical components

Superior Design

- **Permanent Window Bond**
 Ultrasonically welded for maximum contaminant exclusion
- **Sealing Ring**
 Added line of defense against contaminants
- **Reinforcement Insert**
 Offers structural integrity even under the most grueling conditions
- **Corrosion Free Materials**
 Composite materials reinforced with stainless steel inserts make for a durable and long-lasting hubcap that is extremely resistant to impact and corrosion.

Options

- **Window Options**
 Oil OR Grease
- **With or Without Side Fill Plug**
- **Designed for Easy Hubodometer Bracket Installation**
 Integrates seamlessly with other STEMCO Wheel End products like the Hubodometer, DataTrac Pro, and TracBat.
- **Sentinel Technology – Contaminant Resistant Tamper Free**
 Removable Plugs (Red Plug or ESP)
 Sentinel Technology



Defender™ Hub Cap Cross Reference

SKF Cross Reference	Aluminum Part No.	Defender Part No.	Description	QTY
1612	300-4024	360-4024	Red Rubber Plug "FF" - Bulk	20
1612	340-4024	361-4024	Red Rubber Plug "FF"	1
1612	303-4024	363-4024	Red Rubber Plug - "FF" - w/ side fill - Bulk	20
1612	343-4024	364-4024	Red Rubber Plug - "FF" - w/ fill plug	1
1612	356-4024	366-4024	Sentinel Oil - "FF" w/ magnetic fill plug - Bulk	20
1612	356-4024	367-4024	Sentinel Oil - "FF" w/ magnetic fill plug	1
1612	358-4024	369-4024	Sentinel Grease "FF"	1
1643	300-4009	360-4009	Red Rubber Plug "N" - Bulk	20
1643	340-4009	361-4009	Red Rubber Plug "N"	1
1643	303-4009	363-4009	Red Rubber Plug "N" w/ side fill - Bulk	20
1643	343-4009	364-4009	Red Rubber Plug "N" w/ fill plug	1
1643	356-4009	366-4009	Sentinel Oil - "N" w/ magnetic fill plug - Bulk	20
1643	356-4009	367-4009	Sentinel Oil - "N" w/ magnetic fill plug	1
1643	358-4009	368-4009	Sentinel Grease "N" - Bulk	20
1643	358-4009	369-4009	Sentinel Grease "N"	1
1696	340-4195	360-4195	Red Rubber Plug "P" - Bulk	20
1696	340-4195	361-4195	Red Rubber Plug "P"	1
1696	343-4195	363-4195	Red Rubber Plug "P" w/ side fill - Bulk	20
1696	343-4195	364-4195	Red Rubber Plug "P" w/ fill plug	1
1696	356-4195	366-4195	Sentinel Oil - "P" w/ magnetic fill plug - Bulk	20
1696	356-4195	367-4195	Sentinel Oil - "P" w/ magnetic fill plug	1
1696	358-4195	368-4195	Sentinel Grease "P" - Bulk	20
1696	358-4195	369-4195	Sentinel Grease "P"	1

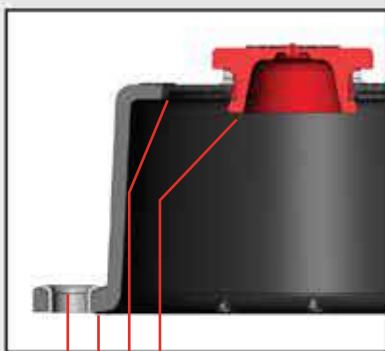

- Vent
- Permanent Bond
- Sealing Ring
- Stainless Steel Insert



- Vent
- Side Fill Plug
- Stainless Inserts

PROGRAMMABLE FOR ANY TIRE SIZE



DataTrac® Pro Shown Actual Size

DataTrac® PRO



Program over 2500 specific tire models and sizes ensuring customer gets reliable mileage information.

Always Have The Part Number

Stock only one part number with the programmable DataTrac® Pro and program the customer's specific requirement for any tire. With DataTrac® Pro you can also pre-set your own mileage and eliminate lead-time and pre-set charges.

Schedule Maintenance

The DataTrac® Pro is an indispensable tool for scheduling maintenance based on actual mileage rather than time.

Large, Easy-to-Read LCD Display

The display makes data retrieval simple and accurate. Optional flexibility of trip and life readings for precise data collection and management. Numbers automatically position upright for easy verification of mileage.

Compact Size

The compact size makes it easy to mount and dismount tires without removing the DataTrac® Pro from the wheel.

No Moving Parts

Provides improved reliability and durability for the most demanding vocational applications. Each unit is marked with a unique serial number providing additional security and data control.

Calibration and Installation

STEMCO calibrations are based at the mid-life of the tire tread (not the depth of new tire tread), one more reason we can guarantee +/-2% accuracy over the life of the tire. For proper calibration, all you need to know is the tire make, model and size. Refer to the chart for some of the most popular tires.

Hub caps and hub cap mounts and universal brackets are available for all popular makes and models. For quick and easy installation, use any of three different options: (1) aluminum hub cap with hub window, (2) grilamid Hubodometer hub cap or (3) bracket.

Warranty

STEMCO DataTrac® Pro is warranted for 500,000 miles or four years, when installed in accordance with its specifications.

An Indispensable Tool for:

- Scheduling maintenance
- Determining lease charges
- Validating guarantees
- Calculating costs-per-mile

Product	Part No.
DataTrac® Pro	600-9999
Programmer	801-6000

Application Cross-Reference

Tire Make	Tire Model	Tire Size	STEMCO Mechanical Hubo Miles / KM	Veeder-root P/N miles / KM	DataTrac®Pro Miles/KM	*DataTrac®Pro REV - Mile/KM
Bridgestone	M726	11R22.5	650-0598/650-0537	777717-494/777727-306	600-5499/600-4310	499 / 310
Bridgestone	M726	11R24.5	650-0584/650-0528	777717-475/777727-294	600-5476/600-4296	476 / 296
Bridgestone	M726	255/70R22.5	650-0622/650-0549	777717-572/777727-350	600-5564/600-4351	564 / 351
Bridgestone	M726	285/75R24.5	650-0595/650-0537	777717-494/777727-306	600-5499/600-4310	499 / 310
Bridgestone	M726	295/75R22.5	650-0605/650-0541	777717-510/777727-316	600-5514/600-4320	514 / 320
Bridgestone	R194	11R22.5	650-0605/650-0541	777717-514/777727-316	600-5513/600-4319	513 / 319
Bridgestone	R194	11R24.5	650-0593/650-0534	777717-490/777727-306	600-5489/600-4304	489 / 304
Bridgestone	R194	255/70R22.5	650-0627/650-0552	777717-572/777727-359	600-5580/600-4361	580 / 361
Bridgestone	R194	285/75R24.5	650-0605/650-0541	777717-514/777727-316	600-5513/600-4319	513 / 319
Bridgestone	R194	295/75R22.5	650-0612/650-0545	777717-525/777727-326	600-5529/600-4328	529 / 328
GoodYear	G104	255/70R22.5	650-0627/650-0552	777717-572/777727-359	600-5579/600-4360	579 / 360
GoodYear	G124	11R22.5	650-0601/650-0537	777717-500/777727-310	600-5505/600-4314	505 / 314
GoodYear	G124	255/70R22.5	650-0626/650-0549	777717-572/777727-359	600-5572/600-4356	572 / 356
GoodYear	G167	11R22.5	650-0598/650-0537	777717-500/777727-310	600-5501/600-4311	501 / 311
GoodYear	G167	295/75R22.5	650-0605/650-0541	777717-514/777727-326	600-5515/600-4320	515 / 320
GoodYear	G314	11R22.5	650-0605/650-0541	777717-510/777727-312	600-5512/600-4318	512 / 318
GoodYear	G314	11R24.5	650-0593/650-0534	777717-484/777727-300	600-5488/600-4303	488 / 303
GoodYear	G314	285/75R24.5	650-0605/650-0541	777717-510/777727-316	600-5514/600-4320	514 / 320
GoodYear	G314	295/75R22.5	650-0613/650-0545	777717-520/777727-326	600-5529/600-4328	529 / 328
GoodYear	G362	11R24.5	650-0584/650-0528	777717-475/777727-300	600-5478/600-4297	478 / 297
GoodYear	G362	285/75R24.5	650-0598/650-0537	777717-500/777727-310	600-5501/600-4311	501 / 311
GoodYear	G362	295/75R22.5	650-0605/650-0541	777717-514/777727-326	600-5515/600-4320	515 / 320
GoodYear	G372	11R24.5	650-0584/650-0528	777717-475/777727-297	600-5476/600-4296	476 / 296
GoodYear	G372	285/75R24.5	650-0598/650-0537	777717-494/777727-310	600-5497/600-4309	497 / 309
GoodYear	G372	295/75R22.5	650-0605/650-0541	777717-510/777727-316	600-5512/600-4318	512 / 318
Michelin	XDA2	11R22.5	650-0598/650-0537	777717-500/777727-310	600-5502/600-4312	502 / 312
Michelin	XDA2	11R24.5	650-0587/650-0528	777717-475/777727-294	600-5480/600-4298	480 / 298
Michelin	XDA2	255/70R22.5	650-0625/650-0549	777717-572/777727-350	600-5566/600-4352	566 / 352
Michelin	XDA2	275/80R22.5	650-0605/650-0541	777717-510/777727-326	600-5519/600-4323	519 / 323
Michelin	XDA2	275/80R24.5	650-0598/650-0537	777717-500/777727-310	600-5502/600-4312	502 / 312
Michelin	XZA2	11R22.5	650-0601/650-0539	777717-510/777727-316	600-5510/600-4317	510 / 317
Michelin	XZA2	11R24.5	650-0591/650-0532	777717-484/777727-300	600-5485/600-4302	485 / 302
Michelin	XZA2	275/80R22.5	650-0610/650-0545	777717-520/777727-326	600-5526/600-4327	526 / 327
Michelin	XZA2	275/80R24.5	650-0601/650-0539	777717-510/777727-316	600-5509/600-4316	509 / 316
Michelin	XZE	255/70R22.5	650-0626/650-0549	777717-572/777727-359	600-5574/600-4357	574 / 357

RELIABLE MILEAGE INFORMATION WITH GUARANTEED ACCURACY



STEMCO's drive-less Hubodometer® offers road-proven accuracy backed by a 500,000 mile warranty.

An Indispensable Tool

The STEMCO Hubodometer® is an indispensable tool for scheduling maintenance, determining lease charges, validating guarantees, and calculating costs per mile.

Reliable Mileage Information

Hubodometers® are calibrated to perform on over 2,500 specific tire models and sizes to further ensure reliable mileage information.

Spring-loaded Counterweight

Virtually eliminates spin when tires hit bumps and potholes, your assurance of greater accuracy.

Preset Your Hubodometer®

STEMCO will preset your Hubodometer® with the mileage data you require for a nominal charge. Allow 3 days for shipping.

500,000 Mile Warranty

Guaranteed over-life-of-tire accuracy backed by 500,000 mile warranty.

Construction and Design

- **Main shaft is independent of front cover**, greatly reducing failure caused by frontal impact.
- **Unit is sealed for added durability** in a moisture-controlled environment of polycarbonate and steel.
- **Externally pinioned odometer mechanism** utilizes low-friction molded components. These features, plus nine permanently lubricated bronze bearings, eliminate wear and ensure long life.
- **Worm drive** rotates parts less frequently, reducing wear.
- **Rugged construction.** Naval brass on steel. No plastic drive components.

Superior Design Guarantees $\pm 2\%$ Accuracy

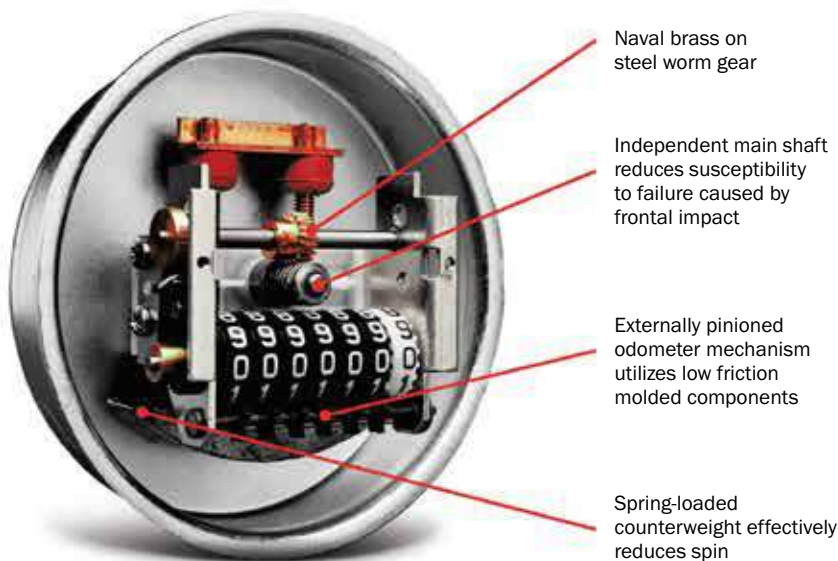

Calibration and Installation

To ensure accurate calibration, we've worked with the engineering staff of all major tire manufacturers. We have compiled fleet data on more than 2,500 tire models and sizes. In addition, STEMCO calibrations are based at the mid-life of tire tread (not the depth of new tire tread), one more reason we can guarantee $\pm 2\%$ accuracy over the life of the tire.

For proper calibration of any STEMCO Hubodometer®, all you need to know is tire make, model and size. With this information and our Tire Classification catalog (which includes radials and low-profile tires), you can quickly determine the part number for the correct Hubodometer®.

STEMCO offers a pre-set Hubodometer® program at a nominal cost. Pre-set orders are shipped within three working days from the Longview, Texas warehouse. For more information, contact STEMCO Customer Service.

Warranty

The STEMCO Hubodometer® is warranted for 500,000 miles when installed in accordance with its specifications. See your STEMCO distributor for details.

Hub Caps & Brackets

Hub caps, hub cap mounts and universal brackets are available for all popular makes and models. For quick and easy installation, use any of three different options: (1) aluminum hub cap with hubo window, (2) grilamid Hubodometer® hub cap or (3) bracket.



Aluminum Hub cap with Hubo Window



Grilamid Hubodometer® Hub Cap



Bracket Installation

Hubodometer® Specifications

Popular Hubodometers® (in order of popularity)



Part No.	RPM	Blank Tenths Part No.	Part No.	RPKM	Install Torque
650-0610	522	650-0611	650-0537	310	
650-0598	500	650-0600	650-0532	300	
650-0613	532	650-0614	650-0539	315	
650-0601	504	650-0602	650-0545	324	
650-0605	513	650-0606	650-0541	320	
650-0587	480	650-0588	650-0549	357	

Hubodometer® Brackets

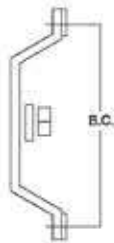

Style A



Style C

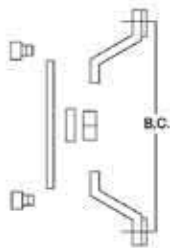

Universal Mount

Part No.	Bolt Circle	Stud Size	Height	Description	Style
6100001	5-1/4"	1/2"	1-11/16"		A
6100002	5-1/2"	5/8"	1-11/16"		A
6100003	6-3/8" - 6-1/2"	1/2" - 9/16"	1-11/16"		A
6100005	7-1/4"	9/16"	1-11/16"		A
6100006	7"	5/8"	1-11/16"		A
6100007	7"	3/4"	1-11/16"		A
6100008	7-1/2"	5/8"	1-9/16"		A
6100009	7-1/2"	5/8"	3-11/16"		A
6100010	8-5/8"	5/8"	5-7/16"	Mack Mount	A
6100011	5-1/2" - 7-1/2"	1/2"	1-3/4"	Universal Mount	
6100013	5-1/2"	7/16"	1/4"		A
6100014	7-5/8"	5/8"	4-3/8"		A
6100015	2-1/2" - 6-1/2"	9/16"	1-1/8"	Car Mount (5 Stud)	C
6100016	2-1/2" - 6-1/2"	5/16" - .343	1-1/8"	Universal Truck Mount (5 Stud)	C
6100017	5-7/32"	5/8"	1-11/16"		A
6100022	3-9/16"	1/2"	1/2"	Strap and Lock Assembly	
6100023	3-15/16"	1/2"	1"		A
6100024	5-1/2"	5/16" - 18 thd	4-1/2"	Hardware for Berg Cap	
6100025	4-1/2" - 9"	3/16"	1-11/16"	TMK-90 Truck Mount	
6100028	5-1/2"	5/16"	5"	Sentinel and PSI Caps - 4 Leg	
6100029	6-3/4"	5/16"	6"	Sentinel, PSI, AirGo Caps - 4 Leg	
6100032	7-1/4"	9/16"	1-1/2"		A
6100058	6-1/2"	1/2"	4-1/2"		A
6100059	4"	9/16"	1-1/2"	For Golf Carts	A
6100065	5-1/2"	5/16"	3-1/2"	Fits 4009 Hubcap	A
6100066	6-1/2"	5/8"	5-1/4"		A
6100079	7-1/4"	3/4"	1-11/16"		A
6100084	6-3/4"	5/16"	5"	Sentinel and PSI Caps - 4 Leg, f/4195	
6100090	N/A	N/A	N/A	Mounts on Top of Window Ring	
6100093	262 mm (10.31")	M10	N/A	Meritor Planetary Axle-DTrac Only	
6100094	246 mm (9.70")	M10	N/A	MAN Planetary Axle-DTrac Only	
6410023	N/A	N/A	N/A	Refurb Kit f/MAN Bracket	

Hubodometer® Hub Caps - For Trailer Installations



640-0001



640-0003

▣ Vented

Hub Cap Includes Gasket	Gasket Part No.	Bolt Circle Diameter	Number of Holes	Bolt Diameter	Aluminum Equivalent
640-0001 ▣	641-0005	5-1/2"	6	5/16"	347-4009
640-0002 ▣	641-0017	5-1/2"	5	5/16"	347-4013
640-0003 ▣	330-3077		6-1/4" x 8 UN(M)		347-4075

AUTOMATICALLY ELIMINATES AIR SYSTEM SLUDGE



The STEMCO Moisture Ejector provides a proven, inexpensive way to help assure the constant removal of oil, carbon, dirt, sludge and water from the air system.

The Moisture Ejector Operates Continuously

One-second blasts of air occur every time the air compressor governor cuts in and out. These high pressure blasts can powerfully eject over 3 oz. of water, oil and solid contaminants. Over and over, water and other contaminants are purged from the air system.

Reliable Operation

In addition to automatic activation, your STEMCO Moisture Ejector can perform reliably for up to five years. Long after some moisture removal systems clog up or lose efficiency.

Eliminates Daily Chore of Purging Moisture from the Wet Tank

How the Product Operates

- The STEMCO Moisture Ejector is connected at the air tank drain with a special 1/4" N.P.T. nipple which is included with ejector.
 - The actuating end connects to the governor unloader port or brake actuating line.
 - The STEMCO Moisture Ejector operates automatically each time the air compressor "cuts in" and "cuts out" when connected to the governor unloader port.
- A. Air tank pressure furnishes ejection power.
 - B. Up to three ounces (or 5.42 cubic inches) of liquid material can be ejected each time the ejector operates.
 - C. The powerful valve action also ejects foreign matter, carbon compounds, and alkali scales which form in air systems.

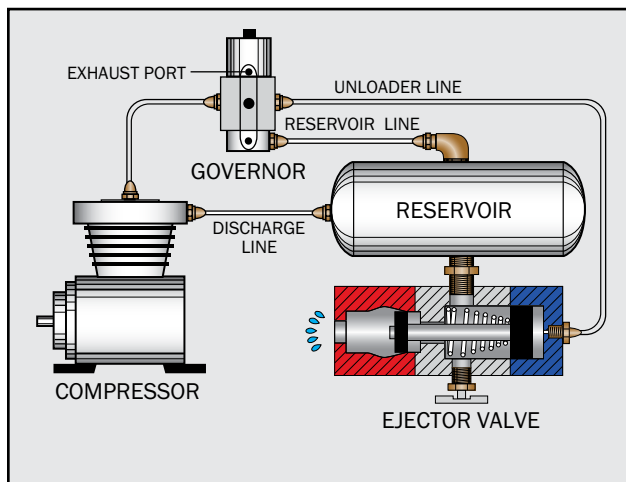
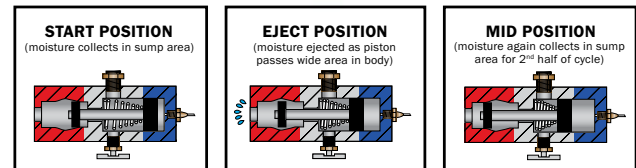

STEMCO Moisture Ejector

Description	Part No.
Ejector w/Threaded End Cap	900-1062
Special-Mounting Nipple (1/4" N.P.T.)	900-1069
Ejector Rebuild Kit	900-1080

Simple Installation

The STEMCO Moisture Ejector is most commonly installed at the wet or primary reservoir drain port. Remove manual drain valve and install STEMCO Moisture Ejector with special 1/4" N.P.T. nipple which is included with the valve. Recommended actuator line is 1/4" O.D. tubing which connects from the actuating port of the STEMCO Moisture Ejector to the unloader port of the governor.

DO NOT remove the threaded nipple supplied with the ejector or change the diameter of the orifice in the actuating end of the unit. The double acting ejector is "balanced" and must have the special nipple and proper orifice size to function properly.

Preventive Maintenance

To assure proper operation and long life of your STEMCO Moisture Ejector, the compartment on the blue actuating end of the unit should be cleaned out at least once in the fall of the year.

This is accomplished by simply removing the actuating air line fitting (blue end) and "blowing-out" with an air hose and nozzle or removing the blue actuating end cap and wiping it out.



Depend on Our Universal Axle Tool for Quick, Accurate Installations

Recognizing that most seal failures can be traced to improper installation, STEMCO has designed its Universal Axle Tool to make the procedure simpler, quicker and more consistent. Proper installation also reduces the possibility of more costly spindle damage.

Single Body with Interchangeable Heads

The STEMCO Universal Tool saves space and is easy to use.

Built to Last

Heavy duty steel body and induction-hardened heads provide years of useful service.

Easier Handling

Each Universal Tool has a sturdy handle for easier handling of the tool body.

Simplifies Installations

Simplifies Standard, Grit Guard®, and Guardian® ring installation for quicker turnarounds.

Universal Axle Tools by Guardian® Seal Number

Guardian® Seal	Inner Bearing Cone Number	Inner Bearing Cone ID or Spindle OD	Universal Axle Tool Head
307-0713 1	663	3.250	555-5100
307-0723 1	HM518445	3.500	555-5023
307-0743 1	HM218248	3.542	555-5039
307-0744	665A	3.375	555-5069
308-0836 1	39581	2.250	555-5062
	HM212044,557A	2.375	555-5061
	HM212049,-X	2.625	555-5098
	HM212047	2.500	555-5066
308-0853	641/HM212049	2.625	555-5060
	H715345	2.812	555-5070
308-0855	641	2.625	555-5060
308-0856	H715345	2.812	555-5070
308-0863	39581	2.250	555-5062
	45284	2.000	555-5064
308-0864 1	6461A	3.000	555-5007
308-0866	JM207049	2.165	555-5088
	JM205149	1.968	555-5089
308-0870	JF7049A	2.756	555-5297
309-0903 1	580/582	3.250	555-5072
309-0904 1	663/HM516449,-C	3.250	555-5072
	HM516449A	3.250	555-5073
309-0912	47685/47686	3.250	555-5031
	47678/5760	3.000	555-5074

Guardian® Seal	Inner Bearing Cone Number	Inner Bearing Cone ID or Spindle OD	Universal Axle Tool Head
309-0915	47685/47686	3.250	555-5031
	47678	3.000	555-5074
309-0935	33287	2.875	555-5011
	33281	2.812	555-5002
309-0948	687/780	4.000	555-5004
309-0957	495AX	3.000	555-5074
	33287	2.875	555-5011
309-0960	594A	3.750	555-5076
	598A	3.625	555-5071
309-0961	580/582/663A	3.250	555-5072
309-0964	594/594A	3.750	555-5076
309-0965	595	3.250	555-5072
	598	3.625	555-5071
309-0970	683XA/683	3.750	555-5076
	681A	3.625	555-5071
309-0973 1	594/594A	3.750	555-5076
	598/598A	3.625	555-5071
381-0148 2	H414245A	2.688	555-5291
381-0150 2	HM212047	2.500	555-5295
391-0138 2	32219	3.740	555-5292
391-0139 2	32216	3.150	555-5296
391-9066 2	594A	3.750	555-5076

1 HP Design
2 SS4 Seal

Use Universal Tool Body 555-0001 with 555 Series Tool Heads.

Universal Axle Tools by Axle/Deflector Ring Number

Axle Ring	Seal Set	Inner Bearing Cone Number	Inner Bearing Cone ID or Spindle OD	Universal Axle Tool Head
310-1007	392-9007	663, HM516449	3.250	555-5072
	372-7046	28995	2.469	555-5052
310-1008	382-8018	45284	2.000	555-5064
	382-8044	45284	2.000	555-5064
	382-8066	JM207049	2.165	555-5088
	382-8066	JM205149	1.968	555-5089
310-1009	382-8052	6386A	2.625	555-5060
310-1012	392-9012	47686	3.250	555-5031
	392-9012	5760,47678	3.000	555-5074
310-1013	382-8001	6379	2.562	555-5014
	382-8001	6386, 6389	2.625	555-5060
310-1017	None	663	3.250	555-5100
	382-8017	39581	2.250	555-5062
310-1018	392-9018	495AX	3.000	555-5074
	392-9057	495AX	3.000	555-5074
310-1022	392-9057	33287	2.875	555-5011
	372-7022	593	3.500	N/A
310-1023	372-7024	749, 749S	3.347	555-5024
	None	HM518445	3.500	555-5023

Axle Ring	Seal Set	Inner Bearing Cone Number	Inner Bearing Cone ID or Spindle OD	Universal Axle Tool Head
310-1026	None	595	3.250	555-5072
	None	598	3.625	555-5071
310-1027	None	663	3.250	555-5031
310-1028	382-8028	756A	3.125	555-5067
	382-8045	756A	3.125	555-5067
310-1032	382-8032	HM212049	2.625	N/A
310-1034	382-8071	HM212047	3.625	555-5066
	372-7006	567	2.875	555-5011
	382-8027	39581	2.250	555-5062
	310-1036	382-8036	557A, HM212044	2.375
HM212047			2.500	555-5066
HM212049,-X			2.625	555-5098
310-1037	382-8063	39581	2.250	555-5062
		45284	2.000	555-5064
310-1037	382-8064	6461A	3.000	555-5007
	None	665A	3.375	555-5069
310-1038	382-8039	HM212049, 641	2.625	N/A
310-1041	382-8060	5760, 6461	3.000	N/A
310-1043	372-7015	759	3.500	555-5023

Use Universal Tool Body 555-0001 with 555 Series Tool Heads.

Universal Axle Tools

Universal Axle Tools by Axle/Deflector Ring Number

Axle Ring	Seal Set	Inner Bearing Cone Number	Inner Bearing Cone ID or Spindle OD	Universal Axle Tool Head
310-1045	None	760	3.562	555-5079
310-1048	None	HM218248	3.542	555-5039
310-1050	382-8010	39578, 4595	2.125	N/A
310-1051	382-8011	559, 3982	2.500	N/A
	382-8062	39585	2.500	N/A
310-1052	382-8009	45284, 45285	2.000	555-5036
	392-9032	580	3.250	555-5072
310-1053	392-9032	575	3.000	555-5074
310-1057	372-7003	663	3.250	555-5031
310-1061	382-8005	3778	1.875	555-5001
310-1062	392-9035	33281	2.812	555-5002
	392-9035	33287	2.875	555-5011
310-1063	392-9036	33281	2.812	555-5002
310-1064	372-7049	JM511946	2.557	555-5055
	392-9038	3984	2.625	555-5097
310-1066	392-9034	6580	3.500	555-5023
	392-9034	6559	3.250	555-5072
310-1079	392-9081	598A	3.625	555-5071
310-1088	None	663, HM516449	3.250	555-5072
	392-9053	782	4.125	555-5016
310-1093	382-8053	641, HM212049	2.625	555-5060
	382-8053	H715345	2.812	555-5070
	382-8056	H715345	2.812	555-5070
	382-8056	641	2.625	555-5060
	None	580, 582	3.250	555-5072
	None	594, 594A	3.750	555-5076
310-1103	392-9062	760	3.562	555-5079
310-1104	392-9063	387AS, 7451929	2.250	555-5062
	392-9063	188931	2.265	555-5054
310-1107	392-9066	594A	3.750	555-5076
310-1111	None	598A, 598	3.625	555-5071
	None	594, 594A	3.750	555-5076
	None	683	3.750	555-5076
	None	681A	3.625	555-5071
310-1117	None	495AX	3.000	555-5074
	None	47686	3.250	555-5031
310-1130	372-7062	592A, 593	3.500	555-5023
310-1132	383-8139	663/641		
	383-8239	HM212011/ HM212049	2.625	N/A
310-1233	392-9111	594/593X	3.750	555-5076
315-1501	392-9099	47685, 47686	3.250	555-5031
	392-9099	47678	3.000	555-5074
	392-9087	681A	3.625	555-5071
315-1502	392-9087	683	3.750	555-5076
	392-9097	594A, 598A	3.625	555-5071
315-1503	372-7091	749, 749S	3.347	555-5024
	372-7099	HM518445	3.500	555-5023
315-1504	372-7097	HM218248	3.542	555-5039
315-1506	372-7096	787	4.125	555-5016
315-1507	372-7098	663	3.250	555-5100

Axle Ring	Seal Set	Inner Bearing Cone Number	Inner Bearing Cone ID or Spindle OD	Universal Axle Tool Head
315-1508	392-9092	598	3.625	555-5071
	392-9096	598	3.625	555-5071
	392-9096	595	3.250	555-5072
315-1509	392-9095	582, 663A	3.250	555-5072
315-1510	372-7095	665A	3.375	555-5069
315-1511	392-9094	580, 582	3.250	555-5072
315-1515	392-9112	663, HM516449	3.250	555-5072
		687, 780	4.000	555-5004
315-1516	392-9089	594, 594A	3.750	555-5076
315-1517	392-9088	594, 594A	3.750	555-5076
315-1519	392-9130	HM516449A	3.250	555-5073
315-1525	392-9131	598A	3.625	555-5071
		594A	3.750	555-5076
315-1530	392-9132	594A	3.750	555-5076
		598A	3.625	555-5071



Use Universal Tool Body 555-0001 with 555 Series Tool Heads.

Universal Axle Tools

Universal Axle Tools by Tool Head Number

Universal Axle Tool Head No.	Inner Cone	Guardian® Seal Axle Ring or Deflector Ring	Universal Axle Tool Head No.	Inner Cone	Guardian® Seal Axle Ring or Deflector Ring	Universal Axle Tool Head No.	Inner Cone	Guardian® Seal Axle Ring or Deflector Ring
555-5001	3778	310-1061	555-5061	HM212044 557A	308-0836 310-1036	555-5074	47678 5760 495AX 42688 575	309-0912 309-0957 310-1012 310-1018 310-1053 310-1117 315-1501
555-5002	33281	309-0935 310-1062	555-5062	39581 387AS 7451929	308-0836 308-0863 310-1017 310-1036 310-1068 310-1104			
555-5004	687 780	309-0948 315-1516 310-1067	555-5064	45284	308-0863 310-1008 310-1036	555-5076	594A 594 693 683XA 683 598A	309-0960 309-0964 309-0970 309-0973 310-1093 310-1107 310-1111 310-1233 315-1502 315-1517 315-1525 315-1530 391-9066
555-5007	6461A	308-0864 310-1026 ¹ 310-1037	555-5066	HM212047	308-0836 310-1034 310-1036			
555-5011	33287 567	309-0935 309-0957 310-1036 310-1062	555-5067	756A	310-1028			
555-5014	6379	310-1013	555-5069	665A 758	307-0744 310-1037 310-1095 315-1510	555-5079	760	310-1045 310-1095 310-1103
555-5016	782, 787	310-1089 315-1506	555-5070	H715345	308-0853 308-0856 310-1093			
555-5023	HM518445 759 6580 592A 593	307-0723 310-1023 310-1043 310-1066 310-1130 315-1503	555-5071	598 598A 681A	309-0960 309-0965 309-0970 309-0973 310-1026 310-1028 310-1079 310-1111 315-1502 315-1508 315-1525 315-1530	555-5081		310-1007
555-5024	749 749S	310-1005 315-1503				555-5088	JM207049	308-0866 310-1008
555-5031	47685 47686 663	309-0912 309-0915 310-1012 310-1027 310-1057 310-1091 310-1117 315-1501	555-5072	H715345 580 582 663-A, HM516449,-A 595 598 6559	308-0856 309-0903 309-0904 309-0961 309-0965 310-1007 310-1026 310-1028 310-1053 310-1066 310-1088 310-1093 315-1508 315-1509 315-1511 315-1515	555-5089	JM205149	308-0866 310-1008
555-5036	45284, 45285	310-1052				555-5098	HM212049,-X	308-0836 310-1036
555-5039	HM218248	307-0743 310-1048 315-1504	555-5100	663, 6386	307-0713 310-1013 310-1028 315-1507	555-5098		
555-5052	28995	310-1008	555-5291	H414245A	381-0148	555-5291		
555-5054	188931	310-1068 310-1104	555-5292	32219	391-0138	555-5292		
555-5055	JM511946	310-1064	555-5295	HM212047	381-0150	555-5295		
555-5060	641 HM212049 6386A 6386 6389	308-0853 308-0855 310-1009 310-1013 310-1093	555-5296	32216	391-0139	555-5296		
			555-5297	JF7049A	308-0870	555-5297		
			555-5073	HM516449A	315-1519			

¹ This tool is used with the 310-1026 ring ONLY on Rogers Bros. Spindle R3329. For other options with the 310-1026 ring see 555-5071 and 555-5072.

Fleet Hub Tools

Fleet Hub Tools by Standard/Grit Guard® Oil Seal Number

Oil Seal	Hub Tool	Hub-Seal Sets
320-2001	551-5398	392-9001, 392-9062
320-2007	551-5326	372-7045
320-2009	551-5356	392-9019, 392-9081
320-2012	551-5405	392-9012
320-2017	551-5352	382-8017
320-2018	551-5351	372-7046, 382-8018
320-2021	551-5385	392-9021
320-2022	551-5381	382-8010
320-2023	551-5401	372-7020, 372-7022, 372-7062, 372-7099, 382-8060
320-2028	551-5385	382-8028, 392-9043
320-2029	551-5386	372-7018, 382-8029, 392-9018
320-2031	551-5388	372-7055, 372-7056, 382-8011, 382-8025
320-2032	551-5388	372-7009, 382-8032
320-2034	551-5387	382-8034
320-2036	551-5346	382-8036
320-2039	551-5395	382-8023, 382-8039
320-2041	551-5398	372-7004, 372-7015, 372-7017, 382-8045
320-2046	551-5388	372-7005, 372-7006
320-2050	551-5347	382-8009
320-2051	551-5388	372-7008
320-2056	551-5302	382-8005
320-2057	551-5353	392-9035, 392-9036
320-2058	551-5303	392-9033
320-2059	551-5317	See 392-9053 Remarks
320-2061	551-5356	392-9034
320-2072	551-5308	372-7048, 392-9038
320-2077	551-5362	392-9063
320-2086	551-5311	382-8001
320-2091	551-5312	See 392-9045 Remarks
320-2096	551-5390	392-9007

Oil Seal	Hub Tool	Hub-Seal Sets
320-2097	551-5400	392-9089
320-2099	551-5317	392-9053
320-2102	551-5318	392-9099
320-2104	551-5383	392-9057
320-2105	551-5351	382-8044
320-2106	551-5320	392-9131
320-2109	551-5313	372-7003, 372-7098, 392-9032
320-2110	551-5412	372-7097
320-2111	551-5323	372-7096
320-2113	551-5412	392-9088
320-2114	551-5412	392-9096
320-2115	551-5356	392-9020, 392-9066, 392-9132
320-2116	551-5317	382-8047
320-2117	551-5325	392-9095
320-2118	551-5321	372-7095
320-2119	551-5353	382-8027
320-2125	551-5388	382-8062
320-2129	551-5393	392-9094
320-2131	551-5363	392-9092
320-2133	551-5353	382-8063
320-2136	551-5381	372-7049
320-2137	551-5327	382-8064
320-2162	551-5333	392-9087
320-2164	551-5366	382-8066
320-2166	551-5340	382-8069
320-2173	551-5401	372-7024, 372-7026, 372-7027, 372-7028, 372-7091
320-2181	551-5349	382-8053, 382-8052
320-2199	551-5344	382-8056
320-2213	551-5364	392-9112, 392-9130
320-2216	551-5403	382-8071
320-2233	551-5404	392-9111

Note: In order for STEMCO warranty to apply, the product must be correctly installed with an installation tool manufactured by STEMCO.

Fleet Hub Tools by Voyager® & Discover® Number

Voyager®/Discover®	Hub Tool
373-0113	551-5313
373-0213	
373-0123	551-5401
373-0223	
373-0143	551-5412
373-0243	
373-0144	551-5339
373-0191	
383-0101	551-5420
383-0136	
383-0236	551-5346
383-0139	
383-0239	551-5413
383-0153	
383-0156	551-5419
383-0164	
383-0264	551-5344
383-0166	
383-0171	551-5327
383-0175	
	551-5423
	551-5403
	551-5417

Voyager®/Discover®	Hub Tool
383-0176	551-5418
393-0103	551-5415
393-0203	
393-0104	551-5414
393-0204	
393-0112	551-5416
393-0212	
393-0115	551-5424
393-0134	
393-0148	551-5421
393-0173	
393-0273	551-5400
320-2058	
320-2059	551-5320
320-2061	
320-2072	551-5303
320-2077	
320-2086	551-5317
320-2091	
320-2096	551-5356
	551-5308
	551-5362
	551-5311
	551-5312
	551-5390

Use Universal Tool Body 555-0001 with 555 Series Tool Heads.

Fleet Hub Tools by Tool Head Number

Tool No.	Seal No.	Tool No.	Seal No.	Tool No.	Seal No.
551-5302	320-2056	551-5351	320-2018	551-5400	320-2097
551-5303	320-2058		320-2105		393-0148
551-5308	320-2072	551-5353	320-2057	551-5401	320-2023
551-5311	320-2086		320-2119		320-2173
551-5312	320-2091		320-2133		373-0123
551-5313	373-0113	320-2009	373-0191		
	373-0213	320-2061	373-0223		
	320-2109	320-2115	320-2216		
551-5317	320-2059	551-5362	320-2077	551-5403	383-0171
	320-2099	551-5363	320-2131	551-5404	320-2233
	320-2116	551-5364	320-2213	551-5405	320-2012
551-5318	320-2102		393-0104	551-5412	320-2110
551-5320	320-2106		393-0204		320-2113
	393-0173	551-5366	320-2164		320-2114
	393-0273	551-5381	320-2022		373-0143
551-5321	320-2118		320-2136	373-0243	
551-5323	320-2111	551-5383	320-2104	551-5413	383-0139
551-5325	320-2117	551-5385	320-2028	551-5414	383-0239
551-5327	320-2137	551-5386	320-2029		393-0104
	383-0164	551-5387	320-2034	393-0204	
	383-0264	551-5388	320-2031	551-5415	393-0103
551-5333	320-2162		320-2032		393-0203
551-5339	373-0144		320-2046		393-0112
551-5344	320-2199		320-2125		393-0212
	383-0156	551-5390	320-2096	551-5417	383-0175
551-5346	320-2036	551-5393	320-2129	551-5418	383-0176
	383-0136		383-0103	551-5419	383-0153
	383-0236		383-0203	551-5420	383-0101
551-5347	320-2050	551-5395	320-2039	551-5421	393-0134
551-5349	320-2181	551-5398	320-2001	551-5423	383-0166
			320-2041	551-5424	393-0115

Note: In order for STEMCO warranty to apply, the product must be correctly installed with an installation tool manufactured by STEMCO.

Use Universal Tool Body 555-0001 with 555 Series Tool Heads.

Bearing Guides By Cone Number

Tool No.	Seal No.	Tool No.	Seal No.	Tool No.	Seal No.	Tool No.	Seal No.
387AS	570-0017	663	570-0023	5584	570-0019	47685	570-0023
495AX	570-0022	663A	570-0023	5760	570-0022	47686	570-0023
555S	570-0017	665	570-0024	6386	570-0020	188931	570-0017
557A	570-0018	665A	570-0024	6386A	570-0020	7451929	570-0017
559	570-0019	681A	570-0027	6389	570-0020	H715345	570-0021
575	570-0022	683	570-0028	6461	570-0022	HM212044	570-0018
580	570-0023	683XA	570-0028	6461A	570-0022	HM212046	570-0019
582	570-0023	687	570-0032	6559	570-0023	HM212047	570-0019
593	570-0025	748S	570-0022	6580	570-0025	HM212049	570-0020
594	570-0028	749A	570-0023	33212	570-0031	HM212049X	570-0020
594A	570-0028	758	570-0024	33281	570-0021	HM218248	570-0026
595	570-0023	759	570-0025	39250	570-0019	HM516449,-A,-C	570-0023
598	570-0027	760	570-0026	39581	570-0017	HM518445	570-0025
598A	570-0027	843	570-0022	30585	570-0019	JM205149A	570-0033
623	570-0017	3982	570-0019	42687	570-0022	JM207049A	570-0036
639	570-0019	3984	570-0020	42688	570-0022		
641	570-0020	3994	570-0020	47678	570-0022		

High impact, accurate guides designed to align the STEMCO seal with the hub bore, thereby eliminating the cocked seal. To be used with the designated hub tool designed for the seal being installed.

Miscellaneous Tools

Tool	Tool No.	Tool	Tool No.
Dial Indicator	102-5003	Grease Template Fill Tool	359-4000

Heavy Duty Axle Tools

Heavy Duty Axle Tools By Guardian® Seal Number

Guardian® Seal	Inner Cone	Outer Cone	Tool Number
307-0713 I	663	560	552-5212
		HM212049	552-5359
307-0723 I	HM518445	HM518445	552-5239
307-0743 I	HM218248	HM212049	552-5236
307-0744	665A	HM212049	552-5233
308-0836 I	HM212044	3782	552-5206
	557A	3782	552-5206
	HM212049-X	3782	552-5288
	HM212047	3782	552-5230
308-0853	H715345	3979	552-5223
308-0856	H715345	28682	552-5223
		555S	552-5223
308-0864 I	6461A	555S	552-5220
		3979	552-5220
309-0903 I	580	567	552-5221
		582	552-5221
309-0904 I	663	575	552-5226
		HM516449-C	47679
309-0912	47685	39590	552-5359
		47686	39590

Guardian® Seal	Inner Cone	Outer Cone	Tool Number	
309-0915	47685	39590	552-5359	
		47686	39590	552-5359
309-0960	598A	580/582	552-5214	
		594A	580/582	552-5216
309-0961	580	42687	552-5221	
		582	42687	552-5221
		663A	42687	552-5221
309-0964	594	580	552-5216	
		594A	580	552-5216
309-0965	598	575	552-5215	
		758	552-5215	
		665	552-5215	
		HM617049	552-5215	
309-0970	681A	575/580	552-5214	
		580	552-5216	
		580	552-5216	
309-0973 I	598A	580	552-5214	
		575	552-5215	
		580	552-5216	
		580	552-5216	
		580	552-5216	

Note: In order for STEMCO warranty to apply, the product must be correctly installed with an installation tool manufactured by STEMCO.

Note: If heavy duty tool is not listed for a specific ring/seal use the 555 series tool head for that application.

I HP Design

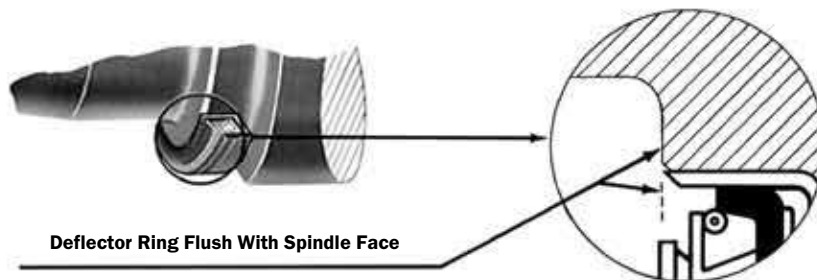

Heavy Duty Axle Tools

Heavy Duty Axle Tools By Axle/Deflector Ring Number

Axle Ring/ Deflector Ring	Set Number	Inner Cone	Outer Cone	Tool Number
310-1007	392-9007	663, HM516449	575, 47679	552-5226
310-1012	392-9012	47686	39590	552-5359
310-1013	None	663	HM212049 560	552-5359
310-1023	None	HM518445	HM518445	552-5239
310-1026	None	598	575	552-5215
310-1034	382-8071 382-8034	HM212047	3779, 45282	552-5230
310-1036	372-7009	39250	4395	552-5231
	382-8025	557A	3782	552-5206
	382-8036	HM212044 HM212047 HM212049,-X	3782	552-5206 552-5230 552-5288
310-1037	None	665A	HM212049	552-5233
	382-8064	6461A	555S, 3979	552-5220
310-1043	372-7015	759	740	552-5237 
310-1048	None	HM218248	HM212049	552-5236
310-1053	392-9032	580	567	552-5221
310-1057	372-7003	663	HM212049	552-5359
310-1061	382-8005	3778	25877	552-5242
			2790	552-5243
310-1064	372-7048	3984	462	552-5247
	372-7049	JM511946	JM205149	552-5273
	392-9038	3984	462	552-5247
310-1088	None	663, HM516449	575, 47679	552-5226
310-1091	None	47685, 47686	39590	552-5359
310-1093	382-8053	H715345	3979, 28682	552-5223
	382-8056	H715345	28682, 555S	552-5223
	None	580, 582	567	552-5221
	None	594	580	552-5216

Axle Ring/ Deflector Ring	Set Number	Inner Cone	Outer Cone	Tool Number
310-1111	None	598A	582	552-5214
	None	681A	580	552-5214
		683	580	552-5216
	None	598A	580	552-5214
		598	575	552-5215
	594, 594A	560, 580	552-5216	
310-1117	392-9045	47686	39590	552-5359
310-1130	372-7062	593	65390 HH506348	552-5239
310-1233	392-9111	593X/594	593X/594	552-5216
315-1501	392-9099	47685, 47686	39590	552-5359
315-1502	392-9087	681A	580	552-5214
		683	580	552-5216
		681A	575	552-5215
	392-9132	598A	582	552-5214
392-9131	598	575	552-5215	
	594, 594A 598A	580 580	552-5216 552-5214	
315-1503	372-7099	HM518445	HM518445	552-5239
315-1504	372-7097	HM218248	HM212049	552-5236
315-1506	372-7096	787	6580	552-5268 
315-1507	372-7098	663	HM212049	552-5359
315-1508	392-9096	598	575	552-5215
315-1509	392-9095	580, 582, 663A	42687	552-5221
315-1510	372-7095	665A	HM212049	552-5233
315-1511	392-9094	580, 582	567	552-5221
315-1515	392-9112	663, HM516449,-C	575, 47679	552-5226
315-1516	392-9089	780	776, 864	552-5271
315-1517	392-9088	594	580	552-5216
315-1525	392-9131	598	575	552-5215
		594, 594A	580	552-5216
		598A	580	552-5214

Note: If heavy duty tool is not listed for a specific ring/seal use the 555 series tool head for that application.

 Discontinued

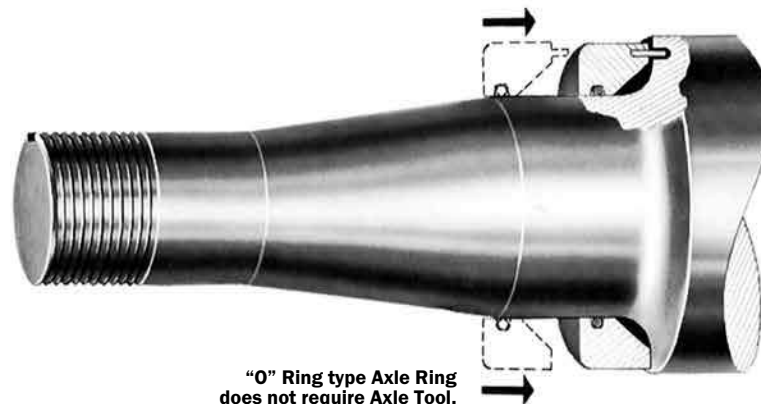

Heavy Duty Axle Tools

Heavy Duty Axle Tools By Tool Number

Tool Number	Inner Cone	Outer Cone	Deflector Ring	Tool Number	Inner Cone	Outer Cone	Deflector Ring
552-5214	598A, 681A	580, 582, 575	309-0970 309-0973 315-1502 315-1525 315-1530	552-5223	H715345	3979, 28682	308-0853 308-0855 308-0856 309-0903 310-1093
552-5215	598, 598A, 681A	575	309-0965 309-0973 310-1026 315-1502 315-1508 315-1525 315-1530	552-5226	663, HM516449,-C	575, 47679	309-0904 310-1007 315-1515
552-5216	594A, 594, 683, -XA	HM516449, 580, 560, 582, 575	309-0960 309-0964 309-0970 309-0973 310-1093 315-1502 315-1517 315-1525	552-5230	HM212047	3779, 45282	310-1034
			552-5220	6461A	555S, 3979	308-0864 310-1037	552-5233
552-5221	580, 582	567, 575	308-0856 309-0903 310-1053 315-1511	552-5236	HM218248	HM212049	307-0743 315-1504
				552-5239	HM518445	HM518445	307-0723 310-1023 315-1503
				552-5288	HM212049, -X, X1	3782	308-0836 310-1036
				552-5359	663, 47685, 47686	560, HM212049, 39590	307-0713 309-0912 309-0915 310-1012 310-1013 310-1057 310-1117 315-1501 315-1507

Note: In order for STEMCO warranty to apply, the product must be correctly installed with an installation tool manufactured by STEMCO.

Note: Hammer Assembly 552-5357, replaceable tips, 552-5358.

ADVANCED AXLE SPINDLE NUTS

PRO-TORQ®



Longer Tread Life

Fleets save tires, wheels track truer. PRO-TORQ® controls axial motion, holding bearing end play near zero while maintaining exact cup and cone alignment on the spindle. This is good news for radial tires. PRO-TORQ® delivers the adjustment precision which experts agree is needed to maximize radial tire life.

Extended Wheel Seal and Bearing Service

PRO-TORQ® supports seal, bearing and axle manufacturers' specifications. With the tight control on wheel bearing adjustment from PRO-TORQ®, fleets minimize premature seal failure and improve extended seal and brake lining programs. PRO-TORQ® compensates for normal bearing wear, permitting precise .001" back-off increments at scheduled preventative maintenance intervals. This keeps bearings properly aligned, running cooler and lasting longer.

Improves ABS

Reliable low end play bearing adjustment and axial motion control with PRO-TORQ® helps ensure accurate wheel end sensor monitoring of wheel speeds on antilock braking systems.

	Spindle Nut Applications	Replacement Keeper Part Number	Thread Size	Outer Bearing Cone/Cup	Tool Socket
Trailer Axle	STEMCO No. 447-4723 Fruehauf Pro-par, Meritor TP <i>*Axle date code post January 1, 2006</i>	450-4723	3.480" – 12	HM518445/ HM518410	4-13/16" – 8 point (OTC# 1941)
	STEMCO No. 447-4724 22,500#-23,000# Eaton, EST 230-P, EST 225-P, P-22	450-4723	3-1/2" – 12	HM518445/ HM518410	4-13/16" – 8 point (OTC# 1941)
	STEMCO No. 447-4743 17,000#-22,500# Meritor, Dana, Eaton, Std Forge, Ingersoll	450-4743	2-5/8" – 16	HM212049/ HM212011	3-3/4" – 8 point (OTC# 1925)
	STEMCO No. 449-4973 Dana Est-230-P, *P22 Axles or TQ <i>*Axle date code prior to January 1, 2006</i>	450-4973	3-1/4" – 12	HM518445/ HM518410	4-3/8" – 8 point (OTC# 1917)
Steer Axle	STEMCO No. 448-4836 12,000# Meritor, Navistar	450-4836	1-1/2" – 12	3782/3720	2-1/2" – 6 point (OTC# 1921)
	STEMCO No. 448-4837 12,000# Eaton, Ford, Meritor	450-4837	1-1/2" – 18	3782/3720	2-1/2" – 6 point (OTC# 1921)
	STEMCO No. 448-4838 Meritor	450-4837	1-1/2" – 12	3782/3720	2-1/2" – 6 point (OTC# 1921)
	STEMCO No. 448-4839 12,000#, 14,300# Mack	450-4839	1-5/8" – 12	45280/45220	2-5/8" – 6 point (OTC# 1922)
	STEMCO No. 448-4864 18,000#, 20,000# Mack	450-4864	2" – 12	555S/552A	3" – 6 point (OTC# 1906)
	STEMCO No. 448-4865 Meritor FL Series	450-4865	1-3/4" – 12	555S/552A 3720/3979	3" – 6 point (OTC# 1906)
Drive Axle	STEMCO No. 449-4904 34,000#, 38,000#, 44,000# Mack	450-4904	2-7/8" – 12	47679/47620 575/572 567/563	4-1/8" – 6 point (OTC# 1915)
	STEMCO No. 449-4973 34,000#-46,000# Eaton, Meritor, Dana, Navistar, 50,000# Mack	450-4973	3-1/4" – 12	580/572	4-3/8" – 8 point (OTC# 1917)
	STEMCO No. 449-4974 Meritor, Eaton, Ford, Navistar	450-4743	2-5/8" – 12	3984/3920 39590/39520	3-3/4" – 8 point (OTC# 1925)
	STEMCO No. 449-4975 19,000# Dana, Navistar, Bluebird	450-4975	2-5/8" – 12	3984/3920 39590/39520	3-3/4" – 8 point (OTC# 1925)

Good Wear Resistance
Bearing contact surface is induction hardened. No washers required.

Flat Contact Surface
Improves wheel bearing cup and cone alignment.

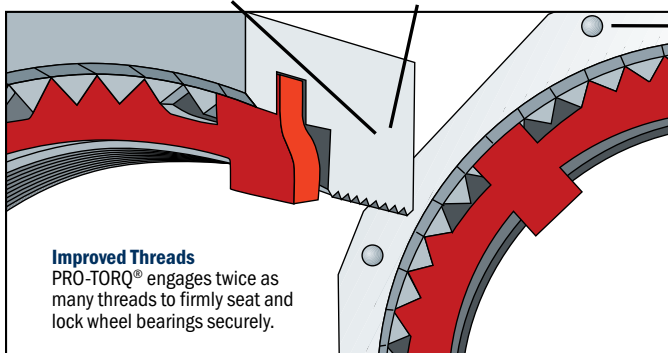

Improved Threads
PRO-TORQ® engages twice as many threads to firmly seat and lock wheel bearings securely.

Highly Visible Adjustment Marks
Give mechanics precise control of nut backoff amount during installation.

Infinite Locking Positions
Nut and spring steel keeper mate and lock at any point on the axle spindle in .001" axial increments.

PRO-TORQ®

Cost Saving Installation

For more than 10 years, leading fleets have chosen PRO-TORQ® to deliver the longer service life they expect from today's tires, wheel seals and bearings. PRO-TORQ® minimizes variability in wheel bearing adjustment, which means extended maintenance intervals and trouble-free performance from steer, drive and trailer axle wheel ends.

Tight Control on Bearing Adjustment

PRO-TORQ® gives fleets the ability to standardize wheel end maintenance practices and makes repeatable, close tolerance bearing adjustment a reality. From mechanic to mechanic, PRO-TORQ® single nut systems and adjustment procedure will consistently secure the nut with wheel bearing adjustment accuracy in the range of .001-.003" end play.

PRO-TORQ® avoids the extremes of both preload and excessive bearing end play. It gives fleets the tightest adjustment standard in the industry.

Faster to Install, Easier to Lock

PRO-TORQ® assures that bearings are "positive" locked in precise position the first time. That's because PRO-TORQ® uses only one nut — no jamming, juggling or time wasted while repositioning multiple nut assemblies.

Clearance in the threads of traditional "jamming" type nuts can result in a wide range of final settings. A mechanic can unintentionally impose preload on a bearing by overtightening the jamnut. As a result, the outer bearing cone can be pushed further up the spindle and out of its intended position.

PRO-TORQ® takes the guesswork out of bearing adjustment.

ADVANCED AXLE SPINDLE FASTENER



Simplified & Fully Unitized Design

Fully unitized design means no special tooling is required. No clips, keepers, snap rings, or screws to install.

Free Spinning

ZIP-TORQ™ free spins onto the axle, engaging the extra wide tang with the axle keyway.

Prevents Back Off

Locking features prevent back off.

Secure Adjustment, Easy Removal

The fastener cannot be rotated by hand after wheelend adjustment is complete. Once the locking features are disengaged, the fastener is removable by hand.

Consistent Endplay

2-1-1 adjustment provides consistent endplay measurement of between .001" - .005", which matches TMC recommendations.

ZIP-TORQ® Cross Reference

Zip-Torq® Part No.	Description	Thread Size	Outer Bearing Cone/Cup	Tool Socket	Pro-Torq® Cross Ref.
Trailer Axle					
400-4723	"P" Parallel Trailer 22,500#	3.480" -12	HM518445/ HM518410 SET415	4-1/8" Six Point (OTC# 1915)	447-4723
400-4743	"N" Tapered Trailer 17,000# - 22,500#	2-5/8" -16	HM212049/ HM212011 SET413	3-1/4" Six Point (OTC# 1908)	447-4743
Steer Axle					
400-4836	"FF" Steer 12,000#	1-1/2" -12	3782/3720 SET406	2-1/8" Six Point (OTC# 1976)	448-4836
400-4837	"FF" Steer 12,000#	1-1/2" -18	3782/3720 SET406	2-1/8" Six Point (OTC# 1976)	448-4837
Drive Axle					
400-4973	"R" Drive 34,000# - 46,000#, 50,000#	3-1/4" -12	580/572 SET401	4" Six Point (OTC# 1914)	449-4973

ZIP-TORQ® Features



Superior Wear Resistance

Bearing contact surface is induction hardened.
No washers required.

Flat Contact Surface

Improves wheel bearing cup and cone alignment.

Infinite Locking Positions

Nut and spring steel keeper mate and lock at any point on the axle spindle in .002" axial increments.

Highly Visible Adjustment Marks

Give mechanics precise control of nut backoff amount during installation.

How Does ZIP-TORQ® Work?

The STEMCO ZIP-TORQ® axle fastener is the latest innovation from STEMCO. ZIP-TORQ is a unitized spindle nut that uses a patented self-locking ratchet system to secure the wheelend and prevent back off. ZIP-TORQ consistently delivers accurate endplay between .001" - .005" using the STEMCO 2-1-1 method.

Unitized Design

Increased simplicity and safety for end users gives you the confidence that your installation will be done right, every time.

Highly Compatible

While ZIP-TORQ is an innovative new product, you won't need to purchase new equipment to install your axle fasteners because ZIP-TORQ is compatible with most automated installation equipment.

Reliably Consistent

Works with preset and endplay applications. ZIP-TORQ minimizes variability in wheel bearing adjustment, which means extended maintenance intervals and trouble-free performance from steer, drive and trailer axle wheel ends.

Easy & Fast Install

ZIP-TORQ meets or exceeds the installation time of PRO-TORQ®, meaning even faster scheduled maintenance is possible.

Extend Your Warranty

ZIP-TORQ is also compatible with STEMCO PPS+ programs, so you can still package your wheelend products to get the best warranty offered in the industry.

Install with Confidence

STEMCO offers installation videos and manuals online – available in the STEMCO app and on the website.

PRO-TORQ® Trailer Axle Fasteners

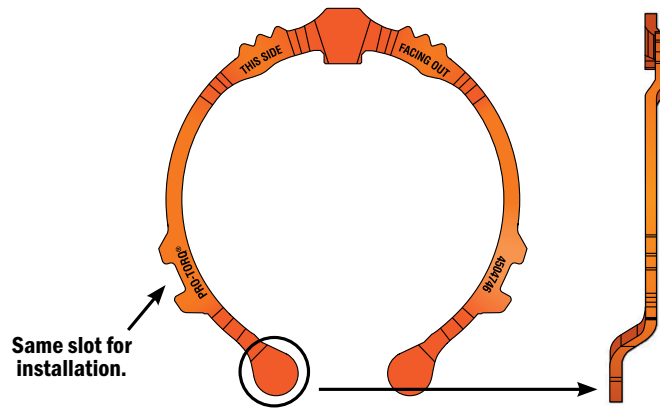

Protrusion Feature
Prevents Backward Installation

450-4743 Updated Design
450-4723 Updated Design
449-4973 Updated Design

TRAILER AXLE FASTENERS **447-4723**

Replacement Keeper No.	450-4723 TANG
Tool Socket	4-13/16" – 8 point (OTC# 1941)
Thread Size	3.480" – 12
Outer Bearing Cup/Cone	HM518445/ HM518410

▼ Axles ▼

Dana Spicer	P-22 <input type="checkbox"/>
Fruehauf	PROPAR Series
Hendrickson	HP
Ingersoll	F24H
Meritor	TP Series

Axle date code Prior to Jan. 1, 2006

TRAILER AXLE FASTENERS **447-4724**

Replacement Keeper No.	450-4723 TANG
Tool Socket	4-13/16" – 8 point (OTC# 1941)
Thread Size	3-1/2" – 12
Outer Bearing Cup/Cone	HM518445/ HM518410

▼ Axles ▼

Eaton	EST 230-P, EST 225-P, P-22
--------------	-------------------------------

TRAILER AXLE FASTENERS **447-4743**

Replacement Keeper No.	450-4743 TANG
Tool Socket	3-3/4" – 8 point (OTC# 1925)
Thread Size	2-5/8" – 16
Outer Bearing Cup/Cone	HM212049/ HM212011

▼ Axles ▼

Dana Spicer	D-20, D-21, D-22, DD-21, DD-22, K-21, K-22, K-25, K-30
Eaton	C, C2, CD, CD2, CE, ESA-225J, EST, EST-225J, EST-230J, ETA 230C, ETA 225D, ETA 225J, H23L, H25R, HCE, HJ, HJE, J, JE, JH, LA-15, T-18C, 20L-77, 22L, 22R, 23L, 23R, 25R

Hendrickson	HN
Ingersoll	A22T
Meritor	RL Series, RQ Series, TK Series, TKL Series, TKLD Series, TL Series, TLD Series, TN Series, TND Series, TQ Series, TQC Series, TQD Series

Standard Forge	A25, A26, 17,000 and 18,000 lb. Trade
-----------------------	--

TRAILER AXLE FASTENERS **448-4836**

Replacement Keeper No.	450-4836 D-FLAT
Tool Socket	2-1/2" – 6 point (OTC# 1921)
Thread Size	1-1/2" – 12
Outer Bearing Cup/Cone	3782/3720

▼ Axles ▼

Dana Spicer	D10
Eaton	X-115
Fruehauf	Model 5, TKF
Meritor	T-1100
Standard Forge	T 8.5-S

TRAILER AXLE FASTENERS **449-4973**

Replacement Keeper No.	450-4973 TANG
Tool Socket	4-3/8" – 8 point (OTC# 1917)
Thread Size	3-1/4" – 12
Outer Bearing Cup/Cone	580/572 HM518445/ HM518410 <input type="checkbox"/>

▼ Axles ▼

Dana Spicer	EST-230-P, P-22 TQ <input type="checkbox"/>
Meritor	TR

Axle date code Prior to Jan. 1, 2006

PRO-TORQ® Steer Axle Fasteners

STEER AXLE FASTENERS

448-4836

Replacement Keeper No.	450-4836 D-FLAT
Tool Socket	2-1/2" – 6 point (OTC# 1921)
Thread Size	1-1/2" – 12
Outer Bearing Cup/Cone	3782/3720

▼ Axles ▼

Meritor	FD 900, FD 901, FD 961, FE 900, FE 903, FF 900, FF 901, FF 921, FF 931, FF 932, FF 933, FF 941, FF 942, FF 943, FF 944, FF 952, FF 961, FG 941
NAVISTAR	I100S

STEER AXLE FASTENERS

448-4838

PRO-TORQ Fastener Number	448-4836 TANG
Replacement Keeper No.	450-4837
Tool Socket	2-1/2" – 6 point (OTC# 1921)
Thread Size	1-1/2" – 12
Outer Bearing Cup/Cone	3782/3720

▼ Axles ▼

Meritor	Steer
----------------	-------

STEER AXLE FASTENERS

448-4863

Replacement Keeper No.	450-4863 D-FLAT
Tool Socket	3-1/2" – 6 point (OTC# 1910)
Thread Size	2-1/4" – 12

▼ Axles ▼

ArvinMeritor® FH	Steering Spindle 16,500 lbs GAW
-------------------------	---------------------------------

STEER AXLE FASTENERS

448-4837

Replacement Keeper No.	450-4837 TANG
Tool Socket	2-1/2" – 6 point (OTC# 1921)
Thread Size	1-1/2" – 18
Outer Bearing Cup/Cone	3782/3720

▼ Axles ▼

Eaton	EFA-12F4, EFA-13F5, E-1200I, FE 931, 12K, 13.2K
Ford	SIFCO 12,000 lb., FORD 6,000 lb.
Meritor	FE-931

STEER AXLE FASTENERS

448-4839

Replacement Keeper No.	450-4839 D-FLAT
Tool Socket	2-5/8" – 6 point (OTC# 1922)
Thread Size	1-5/8" – 12
Outer Bearing Cup/Cone	45220/45280

▼ Axles ▼

Mack Front	FAW12, FAWL12, FAW537, FAW5371, FAW14.3, FAW538, FAW10.5, FAW536, FAW5361
-------------------	---

STEER AXLE FASTENERS

448-4864

Replacement Keeper No.	450-4864 D-FLAT
Tool Socket	3" – 6 point (OTC# 1906)
Thread Size	2" – 12
Outer Bearing Cup/Cone	552A/555S

▼ Axles ▼

Mack Front	FA18, FAW18, FAW616, FA616, FA20, FAW20, FAW617, FA617, FAW16, FAW614
-------------------	---

STEER AXLE FASTENERS

448-4840

Replacement Keeper No.	450-4836 D-FLAT
Tool Socket	2-1/2" – 6 point (OTC# 1921)
Thread Size	1-1/2" – 18
Outer Bearing Cup/Cone	3782/3720

▼ Axles ▼

Hendrickson Auxiliary	13,000# Ultra Axle
------------------------------	--------------------

STEER AXLE FASTENERS

448-4865

Replacement Keeper No.	450-4865 D-FLAT
Tool Socket	3" – 6 point (OTC# 1906)
Thread Size	1-3/4" – 12
Outer Bearing Cup/Cone	552A/555S, 3979/3720

▼ Axles ▼

Meritor Front	FL
----------------------	----

PRO-TORQ® Drive Axle Fasteners

DRIVE AXLE FASTENERS 447-4743	
Replacement Keeper No.	450-4743 TANG
Tool Socket	3-3/4" – 8 point (OTC# 1925)
Thread Size	2-5/8" – 16
Outer Bearing Cup/Cone	HM212049/ HM212011

▼ Axles ▼	
Meritor	F Series, H Series

DRIVE AXLE FASTENERS 449-4904	
Replacement Keeper No.	450-4904 TANG
Tool Socket	4-1/8" – 6 point (OTC# 1915)
Thread Size	2-7/8" – 12
Outer Bearing Cup/Cone	563/567, 572/575, 47620/47679

▼ Axles ▼	
MACK	S-34, S-38, S-44, S-462, SW-56, SW-57, SW-441

DRIVE AXLE FASTENERS 449-4973	
Replacement Keeper No.	450-4973 TANG
Tool Socket	4-3/8" – 8 point (OTC# 1917)
Thread Size	3-1/4" – 12
Outer Bearing Cup/Cone	580/572

▼ Axles ▼	
Dana Spicer	W 230-S, W 460-S D 380, D 381, D 380-P, D 381-P, D 400, D 401, D 400-P, D 440-P, D 401-P, D 402-P, D 451-P, D 460-P, D 480-P, D 485-P DP 380, DP 381, DP 380-P, DP 381-P, DP 340, DP 341, DP 400-P, DP 401-P, DP 440-P, DP 460-P, DP 480-P, DP 550, DP 580-P, DP 650-P DS 340, DS 341, DS 344, DS 380, DS 381, DS 380-P, DS 381-P, DS 400-P, DS 401-P, DS 404-P, DS 400-P, DS 460-P, DS 480-P, DS 454-P DT 340, DT 341, DT 380, DT 381, DT 380-P, DT 381-P, DT 400-P, DT 440-P, DT 460-P, DT 480-P RS 341, RS 381, RS 402, RS 401, RS 460, RS 461, RT 402 44, 440P, 480P, 1911, 1919, 2011, 19500, 20500, 20501
Eaton	
MACK	50,000#
Meritor	Q Series, QHD, QHR, QT Series, R Series, RL-170, RS Series, RT Series, S Series, S 170, S 280, SQ 100, SQ 100-P, SQD, SQDD, SQHD, SQHP, SQHR, SQR, SQW, SR 170, SR 270, SR 280, SRD, SRDD, SRHD, SSHD, SSHP, SP, STD, STDD, STHD, SU 170, SU 270, SU 280, SUHD, SW 170, SW 270, SW 280, T Series, U Series, 58000 Series, 59000 Series, 200
NAVISTAR	14227, 14308, 14309, 14311, 14338, 14342, 14943, 14348, 14364, 14368, 14494

DRIVE AXLE FASTENERS 449-4974	
Replacement Keeper No.	450-4743 TANG Fits 3/8" Keyway
Tool Socket	3-3/4" – 8 point (OTC# 1925)
Thread Size	2-5/8" – 12
Outer Bearing Cup/Cone	3984/3920, 39590/39520

▼ Axles ▼	
Eaton	D, DT, 32M, 34M, MF, MR, RP, RT, 17800, 17801
Ford	18,000# Rear
Meritor	H-145, H-162, H-172, H-240, H-262, H-350, H-362, L-172
NAVISTAR	14044, 14186, 14351, RA44

DRIVE AXLE FASTENERS 449-4975	
Replacement Keeper No.	450-4975 TANG Fits 5/16" Keyway
Tool Socket	3-3/4" – 8 point (OTC# 1925)
Thread Size	2-5/8" – 12
Outer Bearing Cup/Cone	3984/3920, 39590/39520

▼ Axles ▼	
Dana	J190S
Ford	
GMC	
NAVISTAR	
Rear Axle School Bus Application	19,000#

Seal Section

Component Specs

Installation Tools

Axle Fasteners

Long-Life Systems

Cross Reference

Installation Instructions

PRO-TORQ® Interchange Guide

PRO-TORQ® Advanced Axle Fasteners

Seal
Section

Component
Specs

Installation
Tools

Axle
Fasteners

Long-Life
Systems

Cross
Reference

Installation
Instructions

Axilok	STEMCO
AX 12-1500	448-4836
AX 12-3250	449-4973
AX 12-3480	447-4723
AX 12-3500	447-4724
AX 16-2625	447-4743
AX 18-1500	448-4837
Batco	STEMCO
06-201	447-4743
06-203	447-4743
06-204	448-4836
06-210	448-4836
06-226	447-4723
06-348	448-4837
06-354	448-4836
06-358	448-4836
06-403	447-4743
06-404	447-4743
06-411	449-4973
06-412	449-4973
06-424	447-4743
06-425	447-4743
06-470	449-4974
06-472	449-4974
06-482	449-4973
06-484	449-4973
BWP	STEMCO
M-682	447-4743
M-684	447-4743
M-685	448-4836
M-1524	448-4836
M-1956	448-4836
M-1959	448-4836
M-1972	447-4743
M-1974	447-4743
M-1978	449-4973
M-1980	449-4973
M-1984	447-4743
M-1986	447-4743
M-1990	449-4973
M-1992	449-4973
M-1996	447-4723
Ceromet	STEMCO
150012	448-4836
150018	448-4837
262512	449-4974
262516C	447-4743
325012	449-4973
348012	447-4723
348012E	447-4724
K1501	450-4836
K1502	450-4837
K2625	450-4743
K3250	450-4973
K3480	450-4723
Dana	STEMCO
10284	447-4743
10286	447-4743
10406	447-4743
10408	447-4743

Eaton	STEMCO
F-940	447-4743
F-941	447-4743
F-1529	447-4743
F-1530	447-4743
X-115	448-4836
11249	449-4973
19186	447-4743
31927	449-4973
34090	447-4743
128333	448-4837
820394	447-4743
820395	447-4743
E-540	447-4743
E-572	447-4743
E-576	448-4836
E-1087	448-4836
E-2296	448-4836
E-2299	448-4836
E-2303	449-4973
E-2305	449-4973
E-2420	447-4743
E-2422	447-4743
E-2460	447-4743
E-2466	449-4973
E-2468	449-4973
E-2550	447-4723
E-4861	448-4837
E-6140	449-4973
Ford	STEMCO
D5HZ-3104A	448-4837
D7HZ-4255A	449-4974
D7HZ-4245A	449-4974
E4HS-4255-AA	449-4973
F2HS-3276-AA	448-4837
Fruehauf	STEMCO
ACE-8510-001	447-4723
530088	448-4836
K-B Axle	STEMCO
KBE-10227	447-4743
Kershaw	STEMCO
10284	447-4743
10286	447-4743
Leland	STEMCO
L-176	447-4743
L-178	447-4743
L-195	448-4836
L-1331	448-4836
L-1334	448-4836
L-1347	447-4743
L-1349	447-4743
L-1353	449-4973
L-1355	449-4973
L-1359	447-4743
L-1361	447-4743
L-1365	449-4973
L-1367	449-4973
L-1395	447-4723

Meritor	STEMCO
A-1227-A-105	448-4836
A-1227-S-331	449-4973
1227-B-106	448-4836
1227-B-756	447-4743
1227-B-1484	447-4723
1227-C-549	447-4743
1227-E-1045	449-4974
1227-K-947	448-4837
1227-K-1389	447-4723
1227-L-194	448-4836
1227-M-715	449-4974
1227-R-330	449-4973
1227-R-1240	449-4973
1227-T-228	447-4743
1227-T-540	447-4743
1227-U-541	448-4836
1227-W-517	449-4973
1227-X-102	448-4836
1227-Z-1040	449-4974
1227-P-1160	447-4743
Navistar	STEMCO
1607743C1	448-4836
1607744C1	449-4973
2037474C1	448-4837
2501559C1	449-4974
Spicer	STEMCO
M10HN101	447-4743
M10HN102	447-4743
M10HN128	448-4836
M10HN158	447-4743
M103102-001	447-4743
Std. Forge	STEMCO
103100-1	447-4743
103102-001	447-4743
103103-002	447-4743
103104-001	447-4743
103105	448-4836
105013	447-4743
Transit	STEMCO
TP-157	448-4836
TP-431	448-4836
TP-489	447-4743
TP-490	447-4743
TP-1572	449-4973
TP-1943	449-4973
TP-1970	448-4836
TP-1973	448-4836
TP-1977	449-4973
TP-1978	449-4973
TP-1988	447-4743
TP-1989	447-4743
TP-1997	447-4743
TP-1999	447-4743

PRO-TORQ[®] Axle Fastener Warranty

PRO-TORQ[®]



STEMCO warrants that all product shall conform to descriptions on purchase orders, and shall be free of defects in materials and workmanship which would be discovered by following STEMCO's standards of manufacture and inspection at the time said product was manufactured. This warranty shall remain in effect for one year following shipment of product. This warranty is limited to repairing or replacing product which the parties investigation show were defective at the time of delivery.

All product subject to this warranty will be returned, F.O.B.: STEMCO LP, 300 Industrial Blvd., Longview, TX 75602, for examination, repair, or replacement.

This warranty does not cover any defect, malfunction, or failure caused by or resulting from improper or unauthorized service maintenance, installation, repair, or use not within the working specifications for which product was designed, or from abuse, neglect, tampering with, or any other cause beyond the control of STEMCO.

PRO-TORQ[®] is the registered trademark of STEMCO.

Specifications contained in this catalog were in effect at the time the publication was approved for printing, and are subject to change without notice or liability.

INDUSTRY CHANGING WHEEL END PERFORMANCE

PLATINUM PERFORMANCE SYSTEM™



Flexible Options to Fit Your Installation Preferences

STEMCO's Platinum Performance System™ an integrated system of products and performance. With the Platinum Performance System, you can extend your wheel end to a three-year or five year limited warranty.

Simply The Best

Benefit from unprecedented product performance with STEMCO's exclusive patented Guardian® HP or Discover® seal; PRO-TORQ® or ZIP-TORQ® advanced axle fastener; and the tamper-proof Sentinel® hub cap. Receive extended bearing warranty by adding STEMCO heavy duty bearings.

Higher Performance Equals Less Maintenance

When you specify the Platinum Performance System, you are assured of performance that will protect your fleet and maintenance budget. The unprecedented performance of this STEMCO system will lower your maintenance costs by reducing down-time and protecting your wheel end investment.

Two Seven-Year Wheel End Offerings

The Tire Inflation package guarantees the life of the Aeris® Automatic Tire Inflation System, Guardian® HP or Discover Seal, PRO-TORQ or ZIP-TORQ axle fastener, Sentinel hub cap, and STEMCO bearings for up to seven years. The Light Weight Performance package guarantees the life of the STEMCO CentriFuse® Drum and Hub Assembly, STEMCO Crewson Automatic Brake Adjustor, as well as the wheel end products stated above for up to seven years. These long-life systems provide a seven year limited parts and labor warranty by simply adding select components to the industry leading five year Platinum Performance System Plus offering. STEMCO's Platinum Performance System is an integrated system of product and performance.

These new packages are designed to lower operating costs, reduce downtime, and increase revenue by keeping tires properly inflated and reducing weight up to 150 pounds per tandem axle trailer. The Platinum Performance Plus, Platinum Performance Plus 7 Tire Inflation and Platinum Performance Plus 7 Light Weight are for OEM Distributors only.



Long Life Wheel Ends

Industry's Best Parts and Labor Warranty

PLATINUM PERFORMANCE SYSTEM™	AFTERMARKET PLATINUM PERFORMANCE SYSTEM™	PLATINUM PLUS PERFORMANCE SYSTEM™	PLATINUM PLUS 7 PERFORMANCE SYSTEM™ TIRE INFLATION	PLATINUM PLUS 7 PERFORMANCE SYSTEM™ LIGHT WEIGHT
<ul style="list-style-type: none"> Guardian HP or Discover Seal PRO-TORQ or ZIP-TORQ Axle Fastener Sentinel Hub Cap STEMCO Bearings (Optional) Available for Aftermarket 	<ul style="list-style-type: none"> Guardian HP or Discover Seal PRO-TORQ or ZIP-TORQ Axle Fastener Defender Sentinel Hub Cap STEMCO Bearings (Optional) 	<ul style="list-style-type: none"> Guardian HP or Discover Seal PRO-TORQ or ZIP-TORQ Axle Fastener Sentinel Hub Cap STEMCO Bearings 	<ul style="list-style-type: none"> Aeris Automatic Tire Inflation System Guardian HP or Discover Seal PRO-TORQ or ZIP-TORQ Axle Fastener Sentinel Hub Cap STEMCO Bearings 	<ul style="list-style-type: none"> STEMCO CentriFuse Drum and Hub Assembly STEMCO Crewson Automatic Brake Adjuster Guardian HP or Discover Seal PRO-TORQ or ZIP-TORQ Axle Fastener Sentinel Hub Cap STEMCO Bearings
3 Year	3 Year	5 Year †	7 Year †	7 Year †

† Platinum Performance Plus, Platinum Performance Plus 7: Tire Inflation, and Platinum Performance Plus 7: Light Weight are for OEM Distributors only.

STEMCO's Platinum Performance System™

- Lower your operating costs, reduce downtime and increase revenue.
- STEMCO Platinum Performance System Plus 7 Light Weight removes up to 150 pounds of trailer weight, dramatically increasing payload.
- Light Weight and Tire Inflation Platinum Performance Systems help improve fuel efficiency performance.

Industry's Best Parts and Labor Warranty

When you specify the Platinum Performance System™, you are assured of performance that will protect your fleet and your maintenance costs by reducing down-time and protecting your wheel end investment. Available on both tapered and parallel axles.

The newly redesigned Guardian® HP seal, and STEMCO manufactured precision bearings allow us to confidently move from a five to a seven year warranty on wheel end components based on major improvements in reliability and durability.

Extend Your Wheel End Performance in the Aftermarket

With the Platinum Performance System, gain a three year Aftermarket limited wheel end warranty.

Extend Your Aftermarket Wheel End Performance To Three Additional Years	
Retrofit	Refurbishment
Replace components with: <ul style="list-style-type: none"> Discover or Guardian HP Oil Seal Sentinel Hub Cap PRO-TORQ or ZIP-TORQ Axle Fastener 	Replace components with: <ul style="list-style-type: none"> Discover or Guardian HP Oil Seal Sentinel Hub Cap PRO-TORQ Keeper
Receive: Three Year Limited Parts Warranty on components stated above. Wheel ends already equipped with PRO-TORQ can refurbish the axle fastener by replacing the PRO-TORQ Keeper and receive limited warranty coverage.	
Additional Warranty Coverage: <ul style="list-style-type: none"> Add STEMCO New Brake Shoes Add Aeris® Automatic Tire Inflation System 	

Cross Reference

Information contained in this section is furnished as a guide.
Verify specific application elsewhere in this catalog when possible.

Competitive Part No.	Competitor's Name	STEMCO Misc Products	STEMCO Std/ Grit Guard®	STEMCO Guardian®	STEMCO Voyager®	STEMCO Discover®
003102611	Western Star	310-1037 ☒				
01005503	Dexter		372-7097	307-0743	373-0143	373-0243
02000655	Timpte	330-3009				
02009111	Timpte		372-7097	307-0743	373-0143	373-0243
02009913	Timpte	340/343-4009				
027003942	GMC/Volvo	343-4249				
027023479	Western Star	343-4095				
027074450	GMC/Volvo	320-2106				
027074962	GMC/Volvo		392-9131	309-0973	393-0173	393-0273
027077882	Western Star	310-1111 ☒				
027125816	GMC/Volvo		392-9131	309-0973	393-0173	393-0273
06-201	Batco	447-4743				
06-203	Batco	447-4743				
06-204	Batco	448-4836				
06-210	Batco	448-4836				
06-226	Batco	447-4723				
06-348	Batco	448-4837				
06-354	Batco	448-4836				
06-358	Batco	448-4836				
06-403	Batco	447-4743				
06-404	Batco	447-4743				
06-411	Batco	449-4973				
06-412	Batco	449-4973				
06-424	Batco	447-4743				
06-425	Batco	447-4743				
06-470	Batco	449-4974				
06-472	Batco	449-4974				
06-482	Batco	449-4973				
06-484	Batco	449-4973				
1008569	Eaton	330-3009				
100858201	Eaton		382-8036	308-0836	383-0136	383-0236
100858401	Eaton		382-8036	308-0836	383-0136	383-0236
10284	Dana	447-4743				
10284	Kershaw	447-4743				
10286	Dana	447-4743				
10286	Kershaw	447-4743				
103100-1	Std. Forge	447-4743				
103102-001	Std. Forge	447-4743				
103103-002	Std. Forge	447-4743				
103104-001	Std. Forge	447-4743				
103105	Std. Forge	448-4836				
10406	Dana	447-4743				
10408	Dana	447-4743				
105013	Std. Forge	447-4743				
10895522	GMC/Volvo			308-0870		
11249	Eaton	449-4973				
11724	Dexter	320-2110				
119427	Eaton	460-6002				
119429	Eaton	460-6006				
119431	Eaton	460-6001				
119457	Eaton	460-6002				
1199A1665	Meritor		392-9021 ☒			
1199B1614	Meritor		392-9021 ☒			
1199B1666	Meritor	310-1111 ☒				
1199E1669	Meritor	315-1502				
1199G1151	Meritor	310-1095 ☒				
1199J2428	Meritor		392-9087	309-0970		

☒ Discontinued part numbers, refer to Engineering Changes for more information.

1 When using HM516449A, use 392-9130 set.

2 Use 0912 w/ 5.687 bore only; Use 0915 w/ 5.50 bore only.

3 Obsolete set, components still available.

4 Order kit # 383-8139 for Voyager® and 383-8239 for Discover®.

(Continued Next Page)

Cross Reference

Information contained in this section is furnished as a guide.
Verify specific application elsewhere in this catalog when possible.

Competitive Part No.	Competitor's Name	STEMCO Misc Products	STEMCO Std/ Grit Guard®	STEMCO Guardian®	STEMCO Voyager®	STEMCO Discover®
1199N2926	Meritor					
1199R2722	Meritor	310-1018				
1199S3633	Meritor	310-1008				
1199U2517	Meritor	310-1037 ☒				
1199V1296	Meritor	310-1012/1091				
1199Y3431	Meritor	315-1502				
1199Z3094	Meritor	315-1504				
1199Z3146	Meritor		392-9087	309-0970		
1204	C/R		382-8025 ☒☒			
1205	C/R		392-9018			
1207	C/R		392-9096	309-0965		
1208	C/R		392-9132	309-0960		
1211	C/R		392-9131	309-0973	393-0173	393-0273
1212	C/R		392-9062			
1213	C/R		392-9087	309-0970		
1214	C/R		392-9099	309-0912/0915 ☒	393-0112	393-0212
1215	C/R		392-9131	309-0973	393-0173	393-0273
1216	C/R		392-9087	309-0970		
1219	C/R		392-9057	309-0957		
121SR19	Mack	330-3009				
1225L948	Meritor	364-6435				
1227-B-106	Meritor	448-4836				
1227-B-756	Meritor	447-4743				
1227-B-1484	Meritor	447-4723				
1227-C-549	Meritor	447-4743				
1227-E-1045	Meritor	449-4974				
1227-K-1389	Meritor	447-4723				
1227-L-194	Meritor	448-4836				
1227-M-715	Meritor	449-4974				
1227-R-330	Meritor	449-4973				
1227-R-1240	Meritor	449-4973				
1227-T-228	Meritor	447-4743				
1227-T-540	Meritor	447-4743				
1227-U-541	Meritor	448-4836				
1227-W-517	Meritor	449-4973				
1227-X-102	Meritor	448-4836				
1227-Z-1040	Meritor	449-4974				
1227-P-1160	Meritor	447-4743				
12375801	A M General	340-4296 ☒				
1244N1210	Meritor	310-1066				
1244U879	Meritor	310-1089				
127043	Eaton	320-2106				
127044	Eaton	310-1111 ☒				
127719	Eaton	460-6006				
127720	Eaton	460-6001				
127721	Eaton	460-6002				
128113	Crane	330-3009				
128333	Eaton	448-4837				
1282	C/R	340-4975				
1283	C/R	640-0003				
1284	C/R	349-4975				
128355	Eaton	320-2102				
128356	Eaton	315-1501				
1306	C/R		392-9038			
1307	C/R		392-9035	309-0935		
1308	C/R		392-9099	309-0912/0915 ☒	393-0112	393-0212
1311	C/R	349-4024				

☒ Discontinued part numbers, refer to Engineering Changes for more information.

☒ When using HM516449A, use 392-9130 set.

☒ Use 0912 w/ 5.687 bore only; Use 0915 w/ 5.50 bore only.

☒ Obsolete set, components still available.

☒ Order kit # 383-8139 for Voyager® and 383-8239 for Discover®.

(Continued Next Page)

Cross Reference

Information contained in this section is furnished as a guide.
Verify specific application elsewhere in this catalog when possible.

Competitive Part No.	Competitor's Name	STEMCO Misc Products	STEMCO Std/ Grit Guard®	STEMCO Guardian®	STEMCO Voyager®	STEMCO Discover®
1321	C/R		392-9018			
1322	C/R		392-9057	309-0957		
1343	C/R	349-4009				
13567	Crane	320-2137				
13568	Crane	320-2106				
1399	C/R	349-4195				
1436860008	Westport	343-4024				
1436860010	Westport	343-4249				
1436860011	Westport	343-4095				
1436900006	Westport		382-8036	308-0836	383-0136	383-0236
1436900007	Westport		372-7097	307-0743	373-0143	373-0243
150012	Ceromet	448-4836				
150018	Ceromet	448-4837				
15507089	GMC		382-8064	308-0864	383-0164	383-0264
15511620	GMC/Volvo	359-5970				
15519908	GMC/Volvo		382-8071		383-0171	
15519910	GMC/Volvo	320-2216 ☒				
15520072	GMC/Volvo		382-8009			
15520073	GMC/Volvo	343-4198				
15527755	GMC/Volvo		382-8063	308-0863		
15527780	GMC/Volvo		382-8053 ☒	308-0853	383-0153	
15527781	GMC/Volvo		392-9033 ☒			
15534441	GMC/Volvo	359-5968				
1554331C1	Navistar		382-8036	308-0836	383-0136	383-0236
15550869	GMC/Volvo		392-9131	309-0973	393-0173	393-0273
15556130	GMC/Volvo	343-4249				
15556131	GMC/Volvo	330-3122				
15557677	GMC/Volvo		392-9131	309-0973	393-0173	393-0273
15557678	GMC/Volvo		392-9099	309-0912	393-0112	393-0212
15587578	GMC/Volvo	340-4263				
15587579	GMC/Volvo	340-4263				
15588691	GMC/Volvo					
15588692	GMC/Volvo					
15588693	GMC/Volvo					
15611171	GMC/Volvo		382-8029 ☒			
15611171	GMC/Volvo		392-9018			
15663537	GMC/Volvo		382-8036	308-0836	383-0136	383-0236
15679880	GMC/Volvo		392-9131	309-0973	393-0173	393-0273
15679881	GMC/Volvo		392-9099	309-0912	393-0112	393-0212
15687419	GMC/Volvo		382-8064	308-0864	383-0164	383-0264
15703555	GMC/Volvo		392-9099	309-0912	393-0112	393-0212
15844467	GMC/Volvo			308-0870		
15965961	GMC/Volvo	320-2029 ☒				
15965962	GMC/Volvo	310-1018				
15982869	GMC/Volvo		392-9131	309-0973	393-0173	393-0273
1600	C/R	347-4009				
1607743C1	Navistar	448-4836				
1607744C1	Navistar	449-4973				
1608	C/R	340-4065				
1609948C1	Navistar	320-2106				
1611843C91	Navistar		382-8036	308-0836	383-0136	383-0236
1612	C/R	343-4024				
1612823C1	Navistar		382-8056 ☒	308-0856	383-0156	
1612877C91	Navistar		382-8064	308-0864	383-0164	383-0264
1613	C/R	343-4249				
1615304C1	Navistar		382-8036	308-0836	383-0136	383-0236
1615305C1	Navistar		392-9131	309-0973	393-0173	393-0273

☒ Discontinued part numbers, refer to Engineering Changes for more information.

1 When using HM516449A, use 392-9130 set.

2 Use 0912 w/ 5.687 bore only; Use 0915 w/ 5.50 bore only.

3 Obsolete set, components still available.

4 Order kit # 383-8139 for Voyager® and 383-8239 for Discover®.

(Continued Next Page)

Cross Reference

Information contained in this section is furnished as a guide.
Verify specific application elsewhere in this catalog when possible.

Competitive Part No.	Competitor's Name	STEMCO Misc Products	STEMCO Std/ Grit Guard®	STEMCO Guardian®	STEMCO Voyager®	STEMCO Discover®
1623	C/R	343-4066				
1627	C/R	343-4019				
1630	C/R	343-4014				
1642	C/R	343-4013				
1643	C/R	343-4009				
1643	C/R	343-4249				
1644	C/R	343-4009				
1649628C1	Navistar		372-7097	307-0743	373-0143	373-0243
1654330C1	Navistar		392-9099	309-0912/0915	393-0112	393-0212
1654331C1	Navistar		382-8036	308-0836	383-0136	383-0236
1655102C1	Navistar		382-8056 ☒	308-0856	383-0156	
1657081C91	Navistar	343-4249				
1659759C91	Navistar		382-8066	308-0866	383-0166	
1660383C91	Navistar	340-4332				
1660994C1	Navistar		382-8064	308-0864	383-0164	383-0264
1663974C91	Navistar		392-9036 ☒			
166437R91	Navistar		392-9099	309-0912/0915	393-0112	393-0212
1665	C/R	343-4042				
1669	C/R	343-4025				
1670	C/R	343-4072				
1680802C1	Navistar		392-9131	309-0973	393-0173	393-0273
1681	C/R	343-4186				
1682	C/R	343-4075				
1685942C91	Navistar		392-9088	309-0964		
1688203C1	Navistar		382-8036	308-0836	383-0136	383-0236
1691	C/R	340-4098				
16911843C91	Navistar		382-8036	308-0836	383-0136	383-0236
1696	C/R	343-4195				
1698	C/R	340-4080				
1698	C/R	343-4164				
1702	C/R	343-4036				
1703	C/R	343-4249				
1704	C/R	343-4049				
1711	C/R	343-4024				
1715	C/R	343-4028				
1720	C/R	343-4082				
1723	C/R	343-4066				
1727	C/R	343-4019				
1732	C/R	340-4070 ☒ ☒				
1736	C/R	343-4012 ☒				
1737	C/R	340-4015				
1738	C/R	343-4011				
1741	C/R	343-4059				
1742	C/R	343-4013				
1743	C/R	343-4009				
1743	C/R	343-4046				
1743	C/R	343-4095				
1753	C/R	343-4249				
1754	C/R	343-4057				
1764	C/R	340-4037 ☒				
1769	C/R	343-4025				
1770	C/R	343-4034				
1781	C/R	343-4186				
1787	C/R	343-4092				
1788	C/R	343-4249				
1790	C/R	343-4098				
1798	C/R	343-4080				

☒ Discontinued part numbers, refer to Engineering Changes for more information.

☒ When using HM516449A, use 392-9130 set.

☒ Use 0912 w/ 5.687 bore only; Use 0915 w/ 5.50 bore only.

☒ Obsolete set, components still available.

☒ Order kit # 383-8139 for Voyager® and 383-8239 for Discover®.

(Continued Next Page)

Cross Reference

Information contained in this section is furnished as a guide.
Verify specific application elsewhere in this catalog when possible.

Competitive Part No.	Competitor's Name	STEMCO Misc Products	STEMCO Std/ Grit Guard®	STEMCO Guardian®	STEMCO Voyager®	STEMCO Discover®
1800	C/R	347-4009				
1801	C/R	347-4013				
1803	C/R	343-4149				
1808	C/R	343-4065				
1811	C/R	343-4024				
1823	C/R	343-4042				
1827	C/R	343-4002				
1842	C/R	343-4013				
1843	C/R	343-4009				
1843	C/R	343-4046				
1843	C/R	343-4095				
1865	C/R	343-4066				
1869	C/R	343-4025				
1870	C/R	343-4034				
1881	C/R	343-4028				
1890	C/R	343-4249				
1898	C/R	343-4080				
19186	Eaton	447-4743				
19QJ238	Mack	343-4025				
19QJ29302A	Mack	343-4024/4308				
19QJ29304	Mack	343-4095				
19QJ29304A	Mack	343-4095/4309				
19QJ310	Mack	343-4025				
19QJ313	Mack	343-4009				
19QJ318	Mack	343-4098				
19QJ319	Mack	343-4249				
19QJ324	Mack	343-4095				
19QJ325	Mack	343-4092				
19QJ325P2	Mack	343-4092/4312				
19QJ332	Mack	343-4249				
19QJ334	Mack	343-4024				
19QJ335	Mack	343-4264				
19QJA29302	Mack	343-4024				
19QJA29304	Mack	343-4095				
19QJA310	Mack	343-4025				
19QJA310P1	Mack	343-4025				
19QJA315	Mack	343-4057				
19QJA319	Mack	343-4249				
19QJA320	Mack	343-4249				
2009947C91	Navistar	343-4281				
2029409	GMC/Volvo	320-2102				
2033466C91	Navistar	343-4065				
2033863C91	Navistar	343-4009				
2034224	GMC/Volvo		382-8032			
2034230	GMC/Volvo		382-8017			
2034237	GMC/Volvo		392-9057	309-0957		
203452	Manac	330-3009/3067				
203453	Manac	343-4009				
203467	Manac	315-1504				
203469	Manac	310-1048				
203470	Manac	320-2110				
2036166	GMC/Volvo	315-1501				
2037474C1	Navistar	448-4837				
2039149	GMC/Volvo		382-8017			
2039419	GMC/Volvo		382-8017			
2045996	GMC/Volvo		382-8001 ☒		383-0101	
2056780	GMC/Volvo	359-5991				

☒ Discontinued part numbers, refer to Engineering Changes for more information.

1 When using HM516449A, use 392-9130 set.

2 Use 0912 w/ 5.687 bore only; Use 0915 w/ 5.50 bore only.

3 Obsolete set, components still available.

4 Order kit # 383-8139 for Voyager® and 383-8239 for Discover®.

(Continued Next Page)

Cross Reference

Information contained in this section is furnished as a guide.
Verify specific application elsewhere in this catalog when possible.

Competitive Part No.	Competitor's Name	STEMCO Misc Products	STEMCO Std/ Grit Guard®	STEMCO Guardian®	STEMCO Voyager®	STEMCO Discover®
2059246	GMC/Volvo	359-5995				
2064489	GMC/Volvo		392-9057	309-0957		
2071314	Crane	310-1037 ☒				
2071319	Crane	310-1111 ☒				
2071760	Crane	315-1502				
2078026	GMC/Volvo		392-9132	309-0960		
2079222	GMC/Volvo	359-5990				
2094440	GMC/Volvo	320-2029 ☒				
2099450	GMC/Volvo	320-2104				
2208A885	Meritor	330-3060				
2208C575	Meritor	330-3009				
2208C835	Meritor	330-3040				
2208E889	Meritor	330-3024				
2208N820	Meritor	330-3097				
2208U1113	Meritor	330-3118				
2222	National					
2245A27	Meritor	310-1089				
2297M6981	Meritor	315-1525				
2302130	GMC/Volvo	310-1123				
231206	National		392-9111			
2317614	GMC/Volvo		392-9131	309-0973	393-0173	393-0273
23590	C/R PlusXL				383-0175	
240694R1	Navistar	359-6032				
2413360	GMC/Volvo		392-9053			
2428573	GMC/Volvo	343-4042				
2444414	GMC/Volvo	343-4066				
2455044	GMC/Volvo	330-3009				
2455048	GMC/Volvo	310-1012 ☒				
2455091	GMC/Volvo	310-1034 ☒				
2455092	GMC/Volvo	320-2034 ☒				
2455093	GMC/Volvo	330-3041				
2455943	GMC/Volvo	320-2017				
2455944	GMC/Volvo	310-1017				
2456738	GMC/Volvo	320-2008 ☒				
2456739	GMC/Volvo	310-1079				
2477708	GMC/Volvo	320-2036 ☒				
2485338	GMC/Volvo	310-1018				
2498220	GMC/Volvo		382-8064	308-0864	383-0164	383-0264
2501559C1	Navistar	449-4974				
254032C91	Navistar		392-9053			
260421C1	Navistar	343-4092				
26209	C/R	429-0004				
26220	C/R	429-0004				
26239	C/R	429-0004				
262512	Ceromet	449-4974				
262516C	Ceromet	447-4743				
26373	C/R	429-0003				
26378	C/R	460-6002				
2674	National		382-8044			
26762	C/R	429-0004				
2708026	GMC/Volvo		392-9132	309-0960		
27295	C/R	429-0008				
27430	C/R					
27438	C/R		382-8043 ☒			
27461	C/R	460-6005 ☒				
27467	C/R	460-6005 ☒				
27500	C/R	460-6005 ☒				

☒ Discontinued part numbers, refer to Engineering Changes for more information.

1 When using HM516449A, use 392-9130 set.

2 Use 0912 w/ 5.687 bore only; Use 0915 w/ 5.50 bore only.

3 Obsolete set, components still available.

4 Order kit # 383-8139 for Voyager® and 383-8239 for Discover®.

(Continued Next Page)

Cross Reference

Information contained in this section is furnished as a guide.
Verify specific application elsewhere in this catalog when possible.

Competitive Part No.	Competitor's Name	STEMCO Misc Products	STEMCO Std/ Grit Guard®	STEMCO Guardian®	STEMCO Voyager®	STEMCO Discover®
27542	C/R	429-0009				
27558	C/R	460-6004				
27565	C/R	429-0009				
2757682	GMC/Volvo		392-9096	309-0965		
277428C91	Navistar	320-2029 ☒				
278616C91	Navistar	320-2117				
280886C91	Navistar		392-9099	309-0912/0915 ☒	393-0112	393-0212
283109C1	Navistar	359-5995				
283110C1	Navistar	359-5990				
283111C1	Navistar	359-5997				
283112C1	Navistar	359-5992				
283113C1	Navistar	359-5996				
283114C1	Navistar	359-5991				
28425	C/R		392-9063			
28426	C/R		392-9063			
286517C91	Navistar	320-2137 ☒				
286518C1	Navistar	310-1037				
28745	C/R		382-8066	308-0866	383-0166	
28758	C/R		382-8066	308-0866	383-0166	
28820	C/R		372-7046			
28828	C/R		382-8018 ☒ ☒			
28830	C/R		382-8044			
28832	C/R		382-8044			
29288	C/R	460-6003				
29292	C/R	460-6006				
29316	C/R	429-0006				
29322	C/R	429-0006				
29380	C/R	429-0006				
29381	C/R	429-0013 ☒				
29480	C/R PlusXL				383-0176	
29528	C/R	429-0012				
2960381	Dodge		392-9010 ☒			
296393C91	Navistar		382-8036	308-0836	383-0136	383-0236
296395C91	Navistar		392-9088	309-0964		
296409C91	Navistar	320-2010 ☒				
296436C1	Navistar	330-3036				
296438C91	Navistar		372-7099	307-0713	373-0113	373-0213
296441C91	Navistar		392-9095	309-0961		
29865	C/R	429-0005				
29867	C/R	429-0005				
29912	C/R	460-6007				
29961	C/R	460-6007				
29QJ110A	Mack		382-8023 ☒			
29QJ123	Mack		382-8023 ☒			
29QJ127	Mack	310-1041				
29QJ210	Mack	310-1051				
29QJ211	Mack	310-1038 ☒				
29QJ212	Mack	310-1037 ☒				
29QJ219	Mack	310-1111 ☒				
29QJ222	Mack	315-1516				
29QJ229	Mack	310-1111 ☒				
29QJ230	Mack	310-1089				
29QJ233	Mack	310-1079				
29QJ235	Mack	310-1103				
29QJ2930	Mack	315-1502				
29QJ29301	Mack	315-1502				
29QJ29302	Mack	310-1036				

☒ Discontinued part numbers, refer to Engineering Changes for more information.

☑ When using HM516449A, use 392-9130 set.

☒ Use 0912 w/ 5.687 bore only; Use 0915 w/ 5.50 bore only.

☒ Obsolete set, components still available.

☒ Order kit # 383-8139 for Voyager® and 383-8239 for Discover®.

(Continued Next Page)

Cross Reference

Information contained in this section is furnished as a guide.
Verify specific application elsewhere in this catalog when possible.

Competitive Part No.	Competitor's Name	STEMCO Misc Products	STEMCO Std/ Grit Guard®	STEMCO Guardian®	STEMCO Voyager®	STEMCO Discover®
29QJ29304	Mack	310-1093 ⓧ				
29QJ29305	Mack	315-1501				
30007	C/R	429-0005				
30057	C/R	460-6012				
301	NOK		372-7098	307-0713	373-0113	373-0213
301401	Pioneer Weston		372-7098	307-0713	373-0113	373-0213
30153	C/R	429-0010				
302	NOK		372-7099	307-0723	373-0123	373-0223
302200	Pioneer Weston		372-7099	307-0723	373-0123	373-0223
302402	Pioneer Weston		372-7099	307-0723	373-0123	373-0223
303	NOK		372-7097	307-0743	373-0143	373-0243
303100	Pioneer Weston		372-7097	307-0743	373-0143	373-0243
30323	NOK		372-7018 ⓧ			
30323	NOK		382-8029 ⓧ			
30323	NOK		392-9018			
303403	Pioneer Weston		372-7097	307-0743	373-0143	373-0243
304	NOK		392-9131	309-0973	393-0173	393-0273
30445	C/R	429-0010				
304404	Pioneer Weston		372-7095	307-0744	373-0144	
305	NOK		382-8036	308-0836	383-0136	383-0236
305132C92	Navistar	343-4186				
305133C1	Navistar	330-3028				
305387C1	Navistar	310-1089				
305405	Pioneer Weston		392-9094	309-0903		
306	NOK		392-9099	309-0912/0915 ⓧ	393-0112	393-0212
306408	Pioneer Weston		392-9087	309-0970		
307	NOK		392-9088	309-0964		
307408	Pioneer Weston		392-9131	309-0973	393-0173	393-0273
308	NOK		392-9132	309-0960		
308408	Pioneer Weston		392-9132	309-0960		
309409	Pioneer Weston		392-9099	309-0912/0915 ⓧ	393-0112	393-0212
30QJ256	Mack	315-1511				
30QJ258	Mack	315-1515				
3102611	GMC/Volvo	310-1037 ⓧ				
310410	Pioneer Weston		392-9088	309-0964		
311411	Pioneer Weston		392-9096	309-0965		
31175	C/R		382-8009			
31182 ⓧ	C/R	<i>Same as 31175 used for worn hubs or oversize seal bore</i>				
31203	C/R		382-8009			
312100	Pioneer Weston		382-8036	308-0836	383-0136	383-0236
31244	C/R	320-2022				
31244	C/R		382-8010			
31264 ⓧ	C/R	320-2125				
31266	C/R		382-8062			
31269	C/R		382-8010			
31270	C/R		382-8010			
31271	C/R		382-8010			
31281	C/R		372-7049			
31288	C/R		392-9038			
31299	C/R		392-9038			
31301	C/R		392-9038			
31307	C/R		372-7048 ⓧ			
31307	C/R		392-9038			
3130997908	Bluebird		382-8036	308-0836	383-0136	383-0236
314755C91	Navistar	343-4066				
315100	Pioneer Weston		382-8064	308-0864	383-0164	383-0264

ⓧ Discontinued part numbers, refer to Engineering Changes for more information.

ⓧ When using HM516449A, use 392-9130 set.

ⓧ Use 0912 w/ 5.687 bore only; Use 0915 w/ 5.50 bore only.

ⓧ Obsolete set, components still available.

ⓧ Order kit # 383-8139 for Voyager® and 383-8239 for Discover®.

(Continued Next Page)

Cross Reference

Information contained in this section is furnished as a guide.
Verify specific application elsewhere in this catalog when possible.

Competitive Part No.	Competitor's Name	STEMCO Misc Products	STEMCO Std/ Grit Guard®	STEMCO Guardian®	STEMCO Voyager®	STEMCO Discover®
317100 31927 319506C91	Pioneer Weston Eaton Navistar	449-4973	382-8056 ⓧ	308-0856	383-0156	
31955 31960 31961	C/R C/R C/R		382-8053 ⓧ 382-8035 ⓧ 382-8035 ⓧ	308-0853	383-0153	
3208J1076 32385 32397	Meritor C/R C/R	330-3041 429-0007 429-0007				
324043R91 32410 32449	Navistar C/R C/R	460-6011	392-9033 ⓧ 382-8017			
32452 32453 32467	C/R C/R C/R		382-8010 382-8010 382-8010			
32470 32477 32501	C/R C/R C/R		382-8017 382-8017 382-8010			
325012 32502 32510	Ceromet C/R C/R	449-4973	382-8010 382-8017			
32540 32564 326283C91	C/R C/R Navistar		382-8017 382-8017 392-9095	309-0961		
32710 32870 32QJ112B	C/R C/R Mack	429-0011	392-9038 392-9092	309-0965		
32QJ127A 32QJ131A 32QJ179	Mack Mack Mack		392-9131 382-8064	309-0973 308-0864	393-0173 383-0164	393-0273 383-0264
32QJ225 32QJ228 32QJ235	Mack Mack Mack	320-2106 320-2039 ⓧ 320-2009 320-2023				
32QJ237 32QJ238 32QJ240	Mack Mack Mack	320-2106	382-8010			
32QJ241 32QJ243 32QJ245	Mack Mack Mack	320-2097 320-2129 320-2213 320-2137				
32QJ246 32QJ248 32QJ249	Mack Mack Mack		382-8011 382-8039 ⓧ		383-0139	383-0239
32QJ251 32QJ252 32QJ260	Mack Mack Mack	320-2118 320-2099 320-2001	382-8064	308-0864	383-0164	383-0264
32QJ262 32QJ263 32QJ265	Mack Mack Mack		382-8039 ⓧ 392-9094 392-9081	309-0903 309-0960	383-0139 393-0103	383-0239 393-0203
32QJ267 32QJ268 32QJ269	Mack Mack Mack		392-9131 392-9094 382-8036	309-0973 309-0903 308-0836	393-0173 393-0103 383-0136	393-0273 393-0203 383-0236
32QJ270 32QJ271 32QJ276	Mack Mack Mack		382-8064 392-9112 ¶ 392-9089	308-0864 309-0904 309-0948	383-0164 393-0104 393-0148	383-0264 393-0204
32QJ29302 32QJ29315 32QJ29316	Mack Mack Mack	320-2036 ⓧ	382-8036 392-9131	308-0836 309-0973	383-0136 393-0173	383-0236 393-0273

ⓧ Discontinued part numbers, refer to Engineering Changes for more information.

¶ When using HM516449A, use 392-9130 set.

¶ Use 0912 w/ 5.687 bore only; Use 0915 w/ 5.50 bore only.

¶ Obsolete set, components still available.

¶ Order kit # 383-8139 for Voyager® and 383-8239 for Discover®.

(Continued Next Page)

Cross Reference

Information contained in this section is furnished as a guide.
Verify specific application elsewhere in this catalog when possible.

Competitive Part No.	Competitor's Name	STEMCO Misc Products	STEMCO Std/ Grit Guard®	STEMCO Guardian®	STEMCO Voyager®	STEMCO Discover®
32QJ29318	Mack		392-9094	309-0904	393-0104	393-0204
32QJ29320	Mack		382-8064	308-0864	383-0164	383-0264
330783408	Western Star		392-9131	309-0973	393-0173	393-0273
331471C91	Navistar	320-2102				
33254	C/R	429-0011				
33751	C/R	429-0014				
337711C92	Navistar		392-9099	309-0912/0915	393-0112	393-0212
338877R91	Navistar		392-9036			
340107C92	Navistar		392-9088	309-0964		
34046	Eaton	447-4743	392-9088	309-0964		
34090	Eaton					
340929C91	Navistar		392-9036			
341SR36	Mack	310-1088				
341SR38	Mack	310-1007				
341SR41	Mack		392-9095	309-0961		
34383	C/R		392-9035	309-0935		
34384	C/R PlusXL		392-9035	309-0935		
34385	C/R		392-9035	309-0935		
34386	C/R		392-9035	309-0935		
34387	C/R Classic		392-9035	309-0935		
348012	Ceromet	447-4723				
348012E	Ceromet	447-4724				
34882	C/R	429-0002				
34885	C/R		382-8063	308-0863		
34891	C/R	429-0002				
34971	C/R PlusXL		382-8063	308-0863		
34972	C/R		382-8063	308-0863		
34975	C/R Classic		382-8063	308-0863		
34980	C/R		382-8063	308-0863		
34994	C/R PlusXL		392-9036			
34999	C/R		392-9036			
35000	C/R Classic		392-9036			
35001	C/R LongLife		392-9036			
35012	C/R		392-9036			
35029	C/R		392-9036			
35058	C/R PlusXL		382-8036	308-0836	383-0136	383-0236
35059	C/R		382-8036	308-0836	383-0136	383-0236
35060	C/R		382-8035			
35062	C/R		382-8036	308-0836	383-0136	383-0236
35066	C/R Classic		382-8036	308-0836	383-0136	383-0236
35072	C/R	Same as 35066 used for worn hubs or oversize seal bore				
35075	C/R		372-7005			
35075	C/R		372-7006			
35075	C/R		382-8025			
35093	C/R		372-7005			
35093	C/R		372-7006			
35093	C/R		372-7009			
35102	C/R		382-8036	308-0836	383-0136	383-0236
35103	C/R LongLife		382-8036	308-0836	383-0136	383-0236
357	National	330-3077				
35810	C/R		392-9035	309-0935		
35820	C/R					
359922C91	Navistar		382-8064	308-0864	383-0164	383-0264
362402R91	Navistar		382-8032			
36274	C/R					
36282	C/R		382-8034			
36285	C/R w/455035		382-8032			

ⓧ Discontinued part numbers, refer to Engineering Changes for more information.

■ When using HM516449A, use 392-9130 set.

■ Use 0912 w/ 5.687 bore only; Use 0915 w/ 5.50 bore only.

■ Obsolete set, components still available.

■ Order kit # 383-8139 for Voyager® and 383-8239 for Discover®.

(Continued Next Page)

Cross Reference

Information contained in this section is furnished as a guide.
Verify specific application elsewhere in this catalog when possible.

Competitive Part No.	Competitor's Name	STEMCO Misc Products	STEMCO Std/ Grit Guard®	STEMCO Guardian®	STEMCO Voyager®	STEMCO Discover®
36285	C/R		382-8034			
36314	C/R		392-9037			
36357	C/R w/455037		382-8011			
36357	C/R		382-8071		383-0171	
36358	C/R Classic		382-8071		383-0171	
36363	C/R		382-8011			
36364	C/R		382-8011			
36365	C/R		382-8011			
36365	C/R Classic		382-8071		383-0171	
36369	C/R		382-8011			
36370	C/R		382-8011			
36378	C/R		372-7005 ⓧ			
36378	C/R		372-7006			
36378	C/R		382-8025 ⓧ			
36382	C/R		382-8034			
364SZ100	Mack		382-8036	308-0836	383-0136	383-0236
364SZ202	Mack		392-9131	309-0973	393-0173	393-0273
364SZ203	Mack		392-9095	309-0961		
364SZ206	Mack		382-8036	308-0836	383-0136	383-0236
36506	Eaton		392-9099	309-0912/0915	393-0112	393-0212
370001A	National		382-8036	308-0836	383-0136	383-0236
370002A	National		372-7006			
370002A	National		372-7009 ⓧ			
370002A	National		382-8025 ⓧ			
370003A	National		392-9131	309-0973	393-0173	393-0273
370004A	National		392-9001			
370005A	National		392-9020 ⓧ			
370005A	National		392-9132	309-0960		
370006A	National		392-9087	309-0970		
370007A	National		382-8028			
370007A	National		392-9043 ⓧ			
370008A	National		372-7018 ⓧ			
370008A	National		382-8029 ⓧ			
370008A	National		392-9018			
370009A	National		392-9057	309-0957		
370010A	National		372-7046			
370010A	National		382-8018 ⓧ			
370011A	National		382-8011			
370011A	National		382-8071		383-0171	
370012A	National		382-8032			
370012A	National		382-8034			
370013A	National		372-7005 ⓧ			
370014A	National		372-7049			
370014A	National		382-8010			
370014A	National		382-8062			
370015A	National		382-8052			
370018A	National		382-8017			
370019A	National		392-9092	309-0965		
370020A	National		382-8060			
370021A	National		392-9088	309-0964		
370022A	National		392-9094	309-0903	393-0103	393-0203
370023A	National		392-9099 ⓧ	309-0912/0915	393-0112	393-0212
370024A	National		392-9099 ⓧ	309-0915	393-0115	
370025A	National		372-7097	307-0743	373-0143	373-0243
370026A	National		372-7022			
370027A	National		372-7025 ⓧ			
370027A	National		392-9021 ⓧ			

ⓧ Discontinued part numbers, refer to Engineering Changes for more information.

1 When using HM516449A, use 392-9130 set.

2 Use 0912 w/ 5.687 bore only; Use 0915 w/ 5.50 bore only.

3 Obsolete set, components still available.

4 Order kit # 383-8139 for Voyager® and 383-8239 for Discover®.

5 Seal 320-2102 installs in bearing cup bore or use Guardian® 309-0912 in seal bore.

(Continued Next Page)

Cross Reference

Information contained in this section is furnished as a guide.
Verify specific application elsewhere in this catalog when possible.

Competitive Part No.	Competitor's Name	STEMCO Misc Products	STEMCO Std/ Grit Guard®	STEMCO Guardian®	STEMCO Voyager®	STEMCO Discover®
370027A	National		392-9046 ☒			
370028A	National		392-9007			
370029A	National		372-7008 ☒			
370030A	National		392-9095	309-0961		
370031A	National		392-9112 ☒	309-0904	393-0104	393-0204
370033A	National		382-8039 ☒		383-0139	383-0239
370033A	National		392-9010 ☒			
370034A	National		392-9131	309-0973	393-0173	393-0273
370036A	National		372-7003			
370036A	National		372-7098	307-0713	373-0113	373-0213
370036A	National		392-9032			
370037A	National		372-7095	307-0744	373-0144	
370038A	National					
370039A	National					
370043A	National					
370046A	National		392-9038			
370047A	National		392-9035	309-0935		
370048A	National		382-8064	308-0864	383-0164	383-0264
370051A	National					
370054A	National		382-8044			
370057A	National		372-7004 ☒			
370057A	National		382-8045			
370057A	National		392-9019 ☒ ☒			
370063A	National					
370064A	National					
370065A	National		372-7099	307-0723	373-0123	373-0223
370066A	National		382-8001 ☒		383-0101	
370069A	National		392-9048 ☒ ☒	309-0948	393-0148	
370078A	National					
370086A	National					
370094A	National					
370106A	National		392-9045			
370107A	National		372-7091 ☒		373-0191	
370109A	National					
370119A	National					
370120A	National		392-9053			
370121A	National		392-9062			
370124A	National		382-8053 ☒	308-0853	383-0153	
370131A	National		382-8056 ☒	308-0856	383-0156	
370132A	National		382-8063	308-0863		
370145A	National		382-8009			
370150A	National		382-8066	308-0866	383-0166	
370165A	National		392-9099	309-0912/0915		
370166A	National					
370169A	National		392-9036			
370173A	National		392-9081	309-0960		
370175A	National					
370178A	National		392-9033 ☒			
370179A	National		382-8027			
370181A	National		392-9132	309-0960		
370182A	National		382-8064	308-0864	383-0164	383-0264
370191A	National					
370192A	National		372-7015			
370192A	National		372-7017 ☒			
370195A	National		392-9034 ☒		393-0134	
370198A	National		382-8039 ☒		383-0139	383-0239
370199A	National				383-0175	

☒ Discontinued part numbers, refer to Engineering Changes for more information.

☒ When using HM516449A, use 392-9130 set.

☒ Use 0912 w/ 5.687 bore only; Use 0915 w/ 5.50 bore only.

☒ Obsolete set, components still available.

☒ Order kit # 383-8139 for Voyager® and 383-8239 for Discover®.

(Continued Next Page)

Cross Reference

Information contained in this section is furnished as a guide.
Verify specific application elsewhere in this catalog when possible.

Competitive Part No.	Competitor's Name	STEMCO Misc Products	STEMCO Std/ Grit Guard®	STEMCO Guardian®	STEMCO Voyager®	STEMCO Discover®
370211A 370212A 370215A	National National National				383-0176	
370219A 370220A 370338A	National National National		392-9111 372-7095	307-0744	373-0144	
370349A 370349A 370349A	National National National		372-7003 372-7098 392-9032	307-0713	373-0113	373-0213
37532 37532 37561	C/R C/R C/R		382-8032 382-8035 ☒ 382-8035 ☒			
376590A 3796564 3796575	National GMC/Volvo GMC/Volvo		372-7099 392-9057 392-9057	307-0723 309-0957 309-0957	373-0123	373-0223
380001A 380003A 380019C91	National National Navistar		382-8036 392-9131 392-9099	308-0836 309-0973 309-0912/0915	383-0136 393-0173 393-0112	383-0236 393-0273 393-0212
380022A 380023A 380025A	National National National		392-9094 392-9099 372-7097	309-0903 309-0912/0915 307-0743	393-0103 393-0112 373-0143	393-0203 393-0212 373-0243
380031A 380036A 380036A	National National National		392-9112 ¶ 372-7003 372-7098	309-0904 307-0713	393-0104 373-0113	393-0204 373-0213
380036A 380048A 380065A	National National National		392-9032 382-8064 372-7099	308-0864 307-0723	383-0164 373-0123	383-0264 373-0223
380131A 3827712 383706C91	National Dodge Navistar		382-8056 ☒ 382-8063 392-9001	308-0856 308-0863	383-0156	
383716C91 383718C1 383727C1	Navistar Navistar Navistar	320-2046 ☒ 310-1008 330-3040				
383728C1 383733C1 386590A	Navistar Navistar National	330-3056 330-3001	372-7099	307-0723	373-0123	373-0223
38703 38706 38709	C/R C/R C/R		392-9010 ☒ 392-9010 ☒ 392-9010 ☒			
38736 38745 38747	C/R C/R C/R		392-9099 392-9099	309-0912/0915 309-0912/0915	393-0112 393-0112	393-0212 393-0212
38748 38750 38774	C/R C/R Classic C/R		392-9099 392-9099 392-9099	309-0915 309-0915 309-0912/0915	393-0115 393-0112	393-0212 393-0212
38776 38777 38778	C/R PlusXL C/R C/R		392-9099 392-9099 392-9099	309-0912 309-0912/0915 309-0912/0915	393-0112 393-0112 393-0112	393-0212 393-0212 393-0212
38779 38780 38782	C/R C/R Classic C/R		392-9099 392-9099 392-9099	309-0912/0915 309-0912/0915 309-0912/0915	393-0112 393-0112 393-0112	393-0212 393-0212 393-0212
38783 388250C91 39378	C/R LongLife Navistar C/R	343-4025	392-9099 392-9018	309-0912	393-0112	393-0212
39380 39380 39380	C/R C/R C/R		372-7018 ☒ 382-8029 ☒ 392-9018			

☒ Discontinued part numbers, refer to Engineering Changes for more information.

¶ When using HM516449A, use 392-9130 set.

¶ Use 0912 w/ 5.687 bore only; Use 0915 w/ 5.50 bore only.

☒ Obsolete set, components still available.

¶ Order kit # 383-8139 for Voyager® and 383-8239 for Discover®.

(Continued Next Page)

Cross Reference

Information contained in this section is furnished as a guide.
Verify specific application elsewhere in this catalog when possible.

Competitive Part No.	Competitor's Name	STEMCO Misc Products	STEMCO Std/ Grit Guard®	STEMCO Guardian®	STEMCO Voyager®	STEMCO Discover®
39381	C/R		382-8039 ☒		383-0139	383-0239
39385	C/R		372-7018 ☒			
39385	C/R		382-8029 ☒			
39385	C/R		392-9018			
3941956	Volvo		392-9131	309-0973	393-0173	393-0273
39420	C/R		392-9057	309-0957		
3942006	Volvo		382-8036	308-0836	383-0136	383-0236
39423	C/R		392-9057	309-0957		
39425	C/R		392-9057	309-0957		
39426	C/R		308-0870	308-0870		
39430	C/R		392-9018			
39448886	GMC/Volvo	320-2050				
394735C91	Navistar	343-4092				
3948884	GMC/Volvo	310-1052				
394894C91	Navistar		382-8036	308-0836	383-0136	383-0236
396526C91	Navistar		392-9096	309-0965		
3974846	Navistar		392-9045			
398124C1	Navistar	310-1089				
39975	C/R		382-8039 ☒		383-0139	383-0239
39977	C/R		382-8023 ☒			
39977	C/R		382-8039 ☒		383-0139	383-0239
39979	C/R PlusXL		382-8039 ☒		383-0139	383-0239
39980	C/R		382-8039 ☒		383-0139	383-0239
39981	C/R		382-8039 ☒		383-0139	383-0239
39988	C/R Classic		382-8039 ☒		383-0139	383-0239
39990	C/R		382-8039 ☒		383-0139	383-0239
3W5687	Caterpillar	343-4009				
3W6998	Caterpillar	330-3009				
4000531R91	Navistar	460-6011				
40023	C/R		382-8029 ☒			
40035	C/R		382-8052			
40036	C/R		382-8029 ☒			
40040	C/R		382-8052			
40049	C/R		382-8039 ☒		383-0139	383-0239
40051	C/R		382-8039 ☒		383-0139	383-0239
40052	C/R		382-8039 ☒		383-0139	383-0239
40077	C/R		382-8001 ☒		383-0101	
40078	C/R		382-8001 ☒		383-0101	
40080	C/R		382-8001 ☒		383-0101	
40082	C/R		382-8001 ☒		383-0101	
400855C91	Navistar		382-8028			
40086	C/R Classic		382-8001 ☒		383-0101	
40088	C/R		382-8001 ☒		383-0101	
40090	C/R LongLife		382-8001 ☒		383-0101	
40091	C/R PlusXL		382-8001 ☒		383-0101	
40108	C/R		392-9032			
401265	Mechanex/Barrier	330-3077				
40129	C/R PlusXL		372-7098	307-0713	373-0113	373-0213
40130	C/R		372-7098	307-0713	373-0113	373-0213
40130	C/R		392-9032			
40133	C/R		372-7098	307-0713	373-0113	373-0213
40133	C/R		392-9032			
40136	C/R		372-7003			
40136	C/R Classic		372-7098	307-0713	373-0113	373-0213
40136	C/R		392-9032			
40139	C/R	Same as 40136 used for worm hubs or oversize seal bore				
40146	C/R		372-7098	307-0713	373-0113	373-0213

☒ Discontinued part numbers, refer to Engineering Changes for more information.

1 When using HM516449A, use 392-9130 set.

2 Use 0912 w/ 5.687 bore only; Use 0915 w/ 5.50 bore only.

3 Obsolete set, components still available.

4 Order kit # 383-8139 for Voyager® and 383-8239 for Discover®.

(Continued Next Page)

Cross Reference

Information contained in this section is furnished as a guide.
Verify specific application elsewhere in this catalog when possible.

Competitive Part No.	Competitor's Name	STEMCO Misc Products	STEMCO Std/ Grit Guard®	STEMCO Guardian®	STEMCO Voyager®	STEMCO Discover®
40147	C/R LongLife		372-7098	307-0713	373-0113	373-0213
401502	Mechanex/Barrier	330-3014 ☒				
401503	Mechanex/Barrier	330-3002				
401504	Mechanex/Barrier	330-3024				
401507	Mechanex/Barrier	330-3041				
401508	Mechanex/Barrier	330-3018 ☒				
401508	Mechanex/Barrier	330-3028				
401508	Mechanex/Barrier	330-3120				
401510	Mechanex/Barrier	330-3041				
401511	Mechanex/Barrier	330-3060				
401514	Mechanex/Barrier	330-3034				
401516	Mechanex/Barrier	330-3025				
401516	Mechanex/Barrier	330-3035				
401519	Mechanex/Barrier	330-3012				
401524	Mechanex/Barrier	330-3122				
401911P	Mechanex/Barrier	340-4975				
40210	C/R		392-9099	309-0912/0915	393-0112	393-0212
40350	C/R		392-9018			
40360	C/R		392-9099	309-0912/0915	393-0112	393-0212
405367C91	Navistar	460-6004				
407505	Eaton		382-8044			
410324472709	Mack		392-9111			
41035000787789	Mack		392-9111			
411601P	Midland	343-4009				
411604P	Midland	343-4008				
411605P	Midland	343-4095				
411605P	Midland	343-4098				
411605P	Midland	343-4249				
411608P	Midland	343-4013				
411610P	Midland	340-4014 ☒				
411616P	Midland	343-4002				
411620P	Midland	343-4066				
411622P	Midland	343-4042				
411625P	Midland	343-4018				
411627P	Midland	343-4028				
411629P	Midland	343-4186				
411630P	Midland	343-4024				
411635P	Midland	343-4065				
411640P	Midland	343-4034				
411644P	Midland	343-4092				
411646P	Midland	343-4025				
411650P	Midland	343-4012 ☒				
411655P	Midland	343-4075				
411688P	Midland	343-4095				
411845P	Midland	343-4149				
411883P	Midland	343-4080				
411917P	Midland	340-4119				
411967P	Midland	343-4046				
4131005	Trailmobile	330-3009				
4131008	Trailmobile	330-3013				
4131012	Trailmobile	330-3019				
4131013	Trailmobile	330-3024				
4131018	Trailmobile	330-3077				
4131024	Trailmobile	330-3104				
4131025	Trailmobile	330-3067				
4131026	Trailmobile	330-3118				

☒ Discontinued part numbers, refer to Engineering Changes for more information.

1 When using HM516449A, use 392-9130 set.

2 Use 0912 w/ 5.687 bore only; Use 0915 w/ 5.50 bore only.

3 Obsolete set, components still available.

4 Order kit # 383-8139 for Voyager® and 383-8239 for Discover®.

(Continued Next Page)

Cross Reference

Information contained in this section is furnished as a guide.
Verify specific application elsewhere in this catalog when possible.

Competitive Part No.	Competitor's Name	STEMCO Misc Products	STEMCO Std/ Grit Guard®	STEMCO Guardian®	STEMCO Voyager®	STEMCO Discover®
4131027	Trailmobile	330-3122				
4131056	Trailmobile	330-3056				
4131096	Trailmobile	343-4095				
4131097	Trailmobile	343-4195				
4131100	Trailmobile	343-4009				
4131103	Trailmobile	343-4013				
4131107	Trailmobile	343-4019				
4131111	Trailmobile	343-4059				
4131115	Trailmobile	343-4075				
4131121	Trailmobile	340-4163				
4131122	Trailmobile	359-5981				
4131123	Trailmobile	359-5990				
4131124	Trailmobile	343-4249				
4131128	Trailmobile	343-4009				
4131135	Trailmobile		372-7098	307-0713	373-0113	373-0213
4131144	Trailmobile		372-7099	307-0723	373-0123	373-0223
4131145	Trailmobile		372-7091		373-0191	
4131150	Trailmobile		372-7097	307-0743	373-0143	373-0243
4131151	Trailmobile		372-7095	307-0744	373-0144	
4131159	Trailmobile		372-7091		373-0191	
4131160	Trailmobile		372-7095	307-0744	373-0144	
4131162	Trailmobile		372-7097	307-0743	373-0143	373-0243
4131163	Trailmobile		372-7098	307-0713	373-0113	373-0213
4131164	Trailmobile		372-7099	307-0723	373-0123	373-0223
4131166	Trailmobile		392-9088	309-0964		
4131167	Trailmobile		392-9132	309-0960		
4131169	Trailmobile		392-9132	309-0960		
4131170	Trailmobile		392-9131	309-0973	393-0173	393-0273
4131171	Trailmobile		392-9131	309-0973	393-0173	393-0273
4131173	Trailmobile		392-9099	309-0912/0915	393-0112	393-0212
4131188	Trailmobile		392-9087	309-0970		
4131189	Trailmobile		392-9087	309-0970		
4131191	Trailmobile		392-9012	309-0912	393-0112	393-0212
4131192	Trailmobile		392-9099	309-0912/0915	393-0112	393-0212
4131193	Trailmobile		392-9088	309-0964		
4131194	Trailmobile		392-9094	309-0903		
4131197	Trailmobile		392-9112	309-0904		
4131199	Trailmobile		392-9081	309-0960		
4131204	Trailmobile		382-8064	308-0864		
4131206	Trailmobile		382-8056 ⓧ	308-0856		
4131210	Trailmobile		372-7098	307-0713	373-0113	373-0213
4131211	Trailmobile		372-7099	307-0723	373-0123	373-0223
4131212	Trailmobile		372-7097	307-0743	373-0143	373-0243
4131213	Trailmobile		372-7095	307-0744	373-0144	
4131214	Trailmobile		382-8036	308-0836	383-0136	383-0236
4131215	Trailmobile		382-8056 ⓧ	308-0856	383-0156	
4131216	Trailmobile		382-8064	308-0864	383-0164	383-0264
4131220	Trailmobile		382-8036	308-0836	383-0136	383-0236
4131223	Trailmobile		392-9088	309-0964		
4131224	Trailmobile		392-9087	309-0970		
4131225	Trailmobile		392-9112	309-0904	393-0104	393-0204
4131226	Trailmobile		392-9131	309-0973	393-0173	393-0273
4131227	Trailmobile		392-9132	309-0960		
4131229	Trailmobile		392-9112	309-0904	393-0104	393-0204
4131230	Trailmobile		392-9132	309-0960		
4131231	Trailmobile		392-9131	309-0973	393-0173	393-0273
4131232	Trailmobile		392-9088	309-0964		

ⓧ Discontinued part numbers, refer to Engineering Changes for more information.

1 When using HM516449A, use 392-9130 set.

2 Use 0912 w/ 5.687 bore only; Use 0915 w/ 5.50 bore only.

3 Obsolete set, components still available.

4 Order kit # 383-8139 for Voyager® and 383-8239 for Discover®.

(Continued Next Page)

Cross Reference

Information contained in this section is furnished as a guide.
Verify specific application elsewhere in this catalog when possible.

Competitive Part No.	Competitor's Name	STEMCO Misc Products	STEMCO Std/ Grit Guard®	STEMCO Guardian®	STEMCO Voyager®	STEMCO Discover®
4131234	Trailmobile		372-7098	307-0713	373-0113	373-0213
4131235	Trailmobile		372-7097	307-0743	373-0143	373-0243
4131236	Trailmobile		372-7099	307-0723	373-0123	373-0223
4131243	Trailmobile	359-5915				
4131244	Trailmobile	359-5995				
4131249	Trailmobile		382-8036	308-0836	383-0136	383-0236
4131250	Trailmobile		382-8056 ☒	308-0856	383-0156	
4131251	Trailmobile		382-8064	308-0864	383-0164	383-0264
414467C91	Navistar		372-7095	307-0744	373-0144	
414467C93	Navistar	320-2118				
415027	National		372-7006			
415027	National		382-8025 ☒			
415058	National		392-9112	309-0904	393-0104	393-0204
415060	National		392-9096	309-0965		
415200	National		392-9033 ☒			
415371	National		392-9088	309-0964		
415371	National		392-9094	309-0903	393-0103	393-0203
41550	C/R		392-9045			
416125	National		382-8011			
416125	National		382-8071			
416130	National		382-8052			
416297	National		392-9038			
416865	National		392-9007			
416888	National		392-9033 ☒			
416892	National		392-9088	309-0964		
416895C1	Navistar	310-1093 ☒				
417134	National		382-8018 ☒			
417158	National		382-8066	308-0866	383-0166	
417172	National		382-8010			
417352	National		382-8017			
417491	National		382-8045			
417505	National		392-9099	309-0912/0915	393-0112	393-0212
417506	National		392-9057	309-0957		
417530	National		382-8053 ☒	308-0853	383-0153	
417531	National		382-8056 ☒	308-0856	383-0156	
41AX207	Mack		382-8060			
41SR31	Mack	343-4049				
42478	Great Dane		372-7097	307-0743	373-0143	373-0243
42525	Great Dane		372-7099	307-0723	373-0123	373-0223
42550	C/R		392-9045			
42622	C/R		372-7062			
42622	C/R		372-7099	307-0723	373-0123	373-0223
42623	C/R		372-7062			
42623	C/R Classic		372-7099	307-0723	373-0123	373-0223
42624	C/R		372-7091		373-0191	
42625	C/R	Same as 42623 used for worn hubs or oversize seal bore				
42627	C/R PlusXL		372-7099	307-0723	373-0123	373-0223
426297	National		392-9038			
42630	C/R		372-7099	307-0723	373-0113	373-0213
42631	C/R LongLife		372-7099	307-0723	373-0123	373-0223
42644	C/R		392-9112 ☒	309-0904	393-0104	393-0204
42650	C/R		392-9112 ☒	309-0904	393-0104	393-0204
42671	C/R		392-9112 ☒	309-0904	393-0104	393-0204
42672	C/R Classic		392-9112 ☒	309-0904	393-0104	393-0204
42673	C/R PlusXL		392-9112 ☒	309-0904	393-0104	393-0204
426834C1	Navistar	343-4065				
42699	C/R		392-9095	309-0961		

☒ Discontinued part numbers, refer to Engineering Changes for more information.

☐ When using HM516449A, use 392-9130 set.

☑ Use 0912 w/ 5.687 bore only; Use 0915 w/ 5.50 bore only.

☒ Obsolete set, components still available.

☑ Order kit # 383-8139 for Voyager® and 383-8239 for Discover®.

(Continued Next Page)

Cross Reference

Information contained in this section is furnished as a guide.
Verify specific application elsewhere in this catalog when possible.

Competitive Part No.	Competitor's Name	STEMCO Misc Products	STEMCO Std/ Grit Guard®	STEMCO Guardian®	STEMCO Voyager®	STEMCO Discover®
427552R91	Navistar	320-2036 ⓧ				
427553R91	Navistar	343-4066				
427555R2	Navistar	310-1036				
42800	C/R		392-9095	309-0961		
428119C91	Navistar	320-2102				
428120C1	Navistar	315-1501				
428121C1	Navistar	310-1095 ⓧ				
428455C91	Navistar	320-2106				
428456C1	Navistar	315-1502				
431615R3	Navistar	310-1021 ⓧ				
431616R92	Navistar	320-2113				
431619R91	Navistar		372-7098	307-0713	373-0113	373-0223
431620R91	Navistar	343-4009				
431620R92	Navistar	343-4009				
431621R2	Navistar	330-3009/3067				
431622R1	Navistar	320-2109				
43751	C/R		372-7095	307-0744	373-0144	
43752	C/R Classic		372-7095	307-0744	373-0144	
43753	C/R		372-7095	307-0744	373-0144	
43754	C/R PlusXL		372-7095	307-0744	373-0144	
43760	C/R		382-8064	308-0864	383-0164	383-0264
43761	C/R PlusXL		382-8064	308-0864	383-0164	383-0264
43762	C/R		382-8064	308-0864	383-0164	383-0264
43763	C/R		382-8064	308-0864	383-0164	383-0264
43764	C/R Classic		382-8064	308-0864	383-0164	383-0264
43765	C/R LongLife					
43795	C/R		392-9095	309-0961		
43800	C/R w/455034		382-8060			
43820	C/R		392-9092	309-0965		
43820	C/R		392-9096	309-0965		
43860	C/R Classic		392-9096	309-0965		
43861	C/R		392-9096	309-0965		
43865	C/R		392-9092	309-0965		
43875	C/R		392-9131	309-0973	393-0173	393-0273
44068	Great Dane	343-4009				
447550C91	Navistar		372-7005 ⓧ			
447551C91	Navistar		392-9131	309-0973	393-0173	393-0273
447551C92	Navistar	310-1013				
447554C91	Navistar					
447556C91	Navistar		382-8053 ⓧ	308-0853	383-0153	
447558C91	Navistar		382-8018 ⓧ			
447559C91	Navistar		382-8028			
447559C92	Navistar	320-2028 ⓧ				
447560C91	Navistar		382-8029 ⓧ			
447561C91	Navistar		382-8036	308-0836	383-0136	383-0236
447561C92	Navistar	320-2036 ⓧ				
447562C91	Navistar		382-8064	308-0864	383-0164	383-0264
447563C91	Navistar		392-9001			
447563C92	Navistar	320-2001				
447564C91	Navistar		392-9088	309-0964		
447564C92	Navistar	320-2113				
447565C91	Navistar		392-9010 ⓧ			
447567C91	Navistar		392-9095	309-0961		
447567C92	Navistar	320-2117				
447568C91	Navistar		392-9021 ⓧ			
447568C92	Navistar	320-2021 ⓧ				
447569C91	Navistar		392-9096	309-0965		

ⓧ Discontinued part numbers, refer to Engineering Changes for more information.

1 When using HM516449A, use 392-9130 set.

2 Use 0912 w/ 5.687 bore only; Use 0915 w/ 5.50 bore only.

3 Obsolete set, components still available.

4 Order kit # 383-8139 for Voyager® and 383-8239 for Discover®.

(Continued Next Page)

Cross Reference

Information contained in this section is furnished as a guide.
Verify specific application elsewhere in this catalog when possible.

Competitive Part No.	Competitor's Name	STEMCO Misc Products	STEMCO Std/ Grit Guard®	STEMCO Guardian®	STEMCO Voyager®	STEMCO Discover®
447569C92	Navistar		392-9096	309-0965		
447574C91	Navistar		392-9131	309-0973	393-0173	393-0273
447574C92	Navistar		392-9131	309-0973	393-0173	393-0273
44916	C/R PlusXL		382-8053 ⓧ	308-0853	383-0153	
44919	C/R		382-8053 ⓧ	308-0853	383-0153	
44920	C/R		382-8053 ⓧ	308-0853	383-0153	
44922	C/R Classic		382-8053 ⓧ	308-0853	383-0153	
44930	C/R		392-9033 ⓧ			
44963	C/R		392-9033 ⓧ			
44964	C/R Classic		392-9033 ⓧ			
44967	C/R		392-9033 ⓧ			
44968	C/R		392-9033 ⓧ			
44975	C/R		392-9033 ⓧ			
450023	C/R	330-3109				
45010	C/R		392-9033 ⓧ			
450155	C/R	330-3106				
450208	C/R	310-1022				
450293	C/R	330-3122				
450358	National	460-6004				
450409	C/R	310-1057				
45066	C/R		392-9094	309-0903	393-0103	393-0203
45069	C/R		392-9094	309-0903	393-0103	393-0203
45070	C/R		392-9094	309-0903	393-0103	393-0203
450741	C/R	330-3025				
450742	C/R	330-3012				
450743	C/R	330-3042				
450744	C/R	330-3056				
450747	C/R	330-3007				
450748	C/R	330-3041				
450749	C/R	330-3028				
450751	C/R	330-3009/3067				
450752	C/R	330-3060				
450755	C/R	330-3024				
450757	C/R	330-3037				
450760	C/R	330-3008				
450762	C/R	330-3062				
450765	C/R	330-3040				
450767	C/R	330-3015				
450768	C/R	330-3034				
450769	C/R	330-3011				
450775	C/R	330-3013				
450777	C/R	330-3019				
450778	C/R	330-3031				
450781	C/R	330-3097				
450788	C/R	330-3122/3067				
450875	C/R	330-3105				
450876	C/R	330-3106				
450877	C/R	330-3107				
450878	C/R	330-3108				
450879	C/R	330-3109				
45093	C/R PlusXL		392-9094	309-0903	393-0103	393-0203
45095			382-8056 ⓧ	308-0856	383-0156	
45097	C/R		392-9094	309-0903	393-0103	393-0203
45098	C/R		392-9094	309-0903	393-0103	393-0203
450980	C/R	330-3110				
450981	C/R	330-3111				
450982	C/R	330-3112				

ⓧ Discontinued part numbers, refer to Engineering Changes for more information.

1 When using HM516449A, use 392-9130 set.

2 Use 0912 w/ 5.687 bore only; Use 0915 w/ 5.50 bore only.

3 Obsolete set, components still available.

4 Order kit # 383-8139 for Voyager® and 383-8239 for Discover®.

(Continued Next Page)

Cross Reference

Information contained in this section is furnished as a guide.
Verify specific application elsewhere in this catalog when possible.

Competitive Part No.	Competitor's Name	STEMCO Misc Products	STEMCO Std/ Grit Guard®	STEMCO Guardian®	STEMCO Voyager®	STEMCO Discover®
450983	C/R	330-3113				
450984	C/R	330-3114				
450985	C/R	330-3115				
45099	C/R Classic		392-9094	309-0903	393-0103	393-0203
45102	C/R		382-8056 ⓧ	308-0856	383-0156	
45103	C/R Classic		382-8056 ⓧ	308-0856	383-0156	
45108	C/R		392-9094	309-0903	393-0103	393-0203
45115	C/R		392-9088	309-0964		
45149	C/R		392-9088	309-0964		
45150	C/R		392-9088	309-0964		
45152	C/R		392-9131	309-0973	393-0173	393-0273
45157	C/R PlusXL		392-9088	309-0964		
45158	C/R		392-9088	309-0964		
45160	C/R Classic		392-9088	309-0964		
45162	C/R		372-7017 ⓧ			
453027C1	Navistar		392-9001			
453644	C/R	330-3122/3067				
453645	C/R	330-3025				
453646	C/R	330-3105				
4543V	National	460-6011				
455001	C/R	310-1050				
455004	C/R	310-1035 ⓧ				
455011	C/R	310-1010 ⓧ				
455014	C/R	310-1029 ⓧ				
455019	C/R	310-1095 ⓧ				
455022	National		372-7008 ⓧ			
455023	C/R	357-5706				
455030	C/R	310-1044 ⓧ				
455031	C/R	310-1038 ⓧ				
455033	C/R	310-1011 ⓧ				
455034	C/R	310-1041				
455035	C/R	310-1032 ⓧ				
455037	C/R	310-1051				
455052	C/R	310-1051				
455058	National		392-9112	309-0904	393-0104	393-0204
455060	National		392-9096	309-0965		
455062	National		392-9088	309-0964		
455068	National		392-9019			
455070	National		392-9007			
455091	National		392-9034 ⓧ			
455137	National		382-8017			
455173	National		392-9036			
455188	National		382-8023 ⓧ			
455188	National		382-8039 ⓧ		383-0139	383-0239
455200	National		392-9033 ⓧ			
455209	National		382-8060			
455211	National		372-7097	307-0743	373-0143	373-0243
455285	National		392-9007			
455355	National		382-8066	308-0866	383-0166	
455513	National		382-8001 ⓧ			
455547	National		392-9010 ⓧ			
455858	National		392-9035	309-0935		
455958	National		392-9099	309-0912/0915	393-0112	393-0212
4563V	National	460-6003				
4564V	National	460-6005 ⓧ				
456618	National		392-9099	309-0912/0915	393-0112	393-0212
456865N	National		392-9007			

ⓧ Discontinued part numbers, refer to Engineering Changes for more information.

■ When using HM516449A, use 392-9130 set.

■ Use 0912 w/ 5.687 bore only; Use 0915 w/ 5.50 bore only.

■ Obsolete set, components still available.

■ Order kit # 383-8139 for Voyager® and 383-8239 for Discover®.

(Continued Next Page)

Cross Reference

Information contained in this section is furnished as a guide.
Verify specific application elsewhere in this catalog when possible.

Competitive Part No.	Competitor's Name	STEMCO Misc Products	STEMCO Std/ Grit Guard®	STEMCO Guardian®	STEMCO Voyager®	STEMCO Discover®	
45742	Great Dane	330-3009					
45951	Great Dane	320-2110					
45952	Great Dane	315-1504					
46200	C/R		392-9094	309-0903	393-0103	393-0203	
46211	C/R		392-9094	309-0903	393-0103	393-0203	
46300	C/R PlusXL		372-7097	307-0743	373-0143	373-0243	
46304	C/R		372-7097	307-0743	373-0143	373-0243	
46305	C/R Classic		372-7097	307-0743	373-0143	373-0243	
46306	C/R		372-7097	307-0743	373-0143	373-0243	
46308	C/R LongLife		372-7097	307-0743	373-0143	373-0243	
46324	C/R		392-9088	309-0964			
46331	C/R		392-9088	309-0964			
46390	C/R		372-7022				
46390	C/R		372-7099	307-0723	373-0123	373-0223	
465510C91	Navistar	320-2164					
46841	Victor		372-7099	307-0723	373-0123	373-0223	
469844C1	Navistar		382-8066	308-0866	383-0166		
469845C1	Navistar		392-9036				
47017	Great Dane	347-4009					
47245	C/R		392-9111				
472HH101	Dana	460-6007					
47394	C/R		372-7098	307-0713	373-0113	373-0213	
47394	C/R		392-9032				
47483	C/R		392-9066				
47548	Great Dane	343-4195					
47549	Great Dane	343-4009					
47550	Great Dane	343-4075					
47555	Great Dane		372-7099	307-0723	373-0123	373-0223	
47556	Great Dane		372-7097	307-0743	373-0113	373-0213	
47690	C/R		392-9132	309-0960			
47691/47692	C/R PlusXL		392-9131	309-0973	393-0173	393-0273	
47693	C/R LongLife		392-9131	309-0973	393-0173	393-0273	
47694	C/R		<i>Narrow version of 47695 for ABS</i>				
47695	C/R		392-9131	309-0973	393-0173	393-0273	
47696	C/R		392-9131	309-0973	393-0173	393-0273	
47697	C/R Classic		392-9131	309-0973	393-0173	393-0273	
47698	C/R	<i>Same as 47697 used for worn hubs or oversize seal bore</i>					
47699	C/R		392-9087	309-0970			
47802	Victor		392-9096	309-0965			
47803	Victor		392-9132	309-0960			
48000	C/R Classic		392-9132	309-0960			
48001	C/R		392-9132	309-0960			
48001	C/R		392-9081				
48002	C/R PlusXL		392-9081	309-0960			
48086	Victor		372-7097	307-0743	373-0143	373-0243	
48088	Victor		372-7098	307-0713	373-0113	373-0213	
48089	Victor		392-9131	309-0973	393-0173	393-0273	
48090	Victor		382-8036	308-0836	383-0136	383-0236	
48091	Victor		392-9099	309-0912/0915	393-0112	393-0212	
48093	Victor		392-9088	309-0964			
48095	Victor		392-9094	309-0903	393-0103	393-0203	
48096	Victor		392-9035	309-0935			
48097	Victor		382-8056 ☒	308-0856	383-0156		
48098	Victor		392-9112	309-0904	393-0104	393-0204	
48297	C/R		372-7025 ☒				
48297	C/R		392-9021 ☒				
48297	C/R		392-9046 ☒				

☒ Discontinued part numbers, refer to Engineering Changes for more information.

1 When using HM516449A, use 392-9130 set.

2 Use 0912 w/ 5.687 bore only; Use 0915 w/ 5.50 bore only.

3 Obsolete set, components still available.

4 Order kit # 383-8139 for Voyager® and 383-8239 for Discover®.

(Continued Next Page)

Cross Reference

Information contained in this section is furnished as a guide.
Verify specific application elsewhere in this catalog when possible.

Competitive Part No.	Competitor's Name	STEMCO Misc Products	STEMCO Std/ Grit Guard®	STEMCO Guardian®	STEMCO Voyager®	STEMCO Discover®
48298	C/R	320-2001 w/310-1021				
48690	C/R Classic				393-0134	
48691	C/R		392-9034 ☒		393-0134	
48693	C/R		392-9034 ☒		393-0134	
48700	C/R		392-9034 ☒		393-0134	
48701	C/R		392-9034 ☒		393-0134	
4874N	National	460-6004				
48769	C/R		392-9019 ☒			
48776	C/R		392-9019 ☒			
48792	C/R		392-9019 ☒			
48794	C/R		382-8028			
48796	C/R		382-8045			
48844	C/R		392-9001	309-0960		
48882	C/R		392-9132			
48883	C/R		382-8028			
48884	C/R		392-9001			
48884	C/R		392-9062			
48886	C/R		382-8045			
49050	C/R		392-9131	309-0973	393-0173	393-0273
490577C92	Navistar		382-8056 ☒	308-0856	383-0156	
490578C91	Navistar	320-2181				
49966	C/R		392-9007			
500200C91	Navistar	320-2199				
5010196	Trailmobile	320-2110				
5010198	Trailmobile	315-1504				
50124	C/R		392-9007			
50148	C/R	320-2001				
50150	C/R	320-2001				
504081	C/R		392-9094	309-0903	393-0103	393-0203
506085	Eaton	343-4024				
506089	Eaton	343-4249				
506161	Eaton	330-3024				
50640	C/R		392-9131	309-0973	393-0173	393-0273
506635	Eaton	310-1048				
506775	Eaton		382-8064	308-0864	383-0164	383-0264
5076	C/R		392-9018			
507842C91	Navistar	320-2199				
507844C91	Navistar	320-2164				
509053	C/R		382-8017			
509154C91	Navistar		382-8045			
510589C91	Navistar	343-4049				
510589C93	Navistar	343-4101 ☒				
512656C1	Navistar	310-1048				
512657C1	Navistar	320-2110				
5141050	GMC/Volvo		382-8017			
521162	C/R		382-8052			
52658	C/R		392-9089	309-0948	393-0148	
52660 ☒	C/R		392-9089	309-0948	393-0148	
52664	C/R		392-9089	309-0948	393-0148	
527501	White		382-8010			
527502	White		382-8035 ☒			
527503	White		382-8034			
530088	Fruehauf	448-4836				
530480	Fruehauf		372-7099	307-0723	373-0123	373-0223
54395	C/R		392-9001			
54533HA	Navistar		392-9036			
5465	National		392-9057	309-0957		

☒ Discontinued part numbers, refer to Engineering Changes for more information.

☒ When using HM516449A, use 392-9130 set.

☒ Use 0912 w/ 5.687 bore only; Use 0915 w/ 5.50 bore only.

☒ Obsolete set, components still available.

☒ Order kit # 383-8139 for Voyager® and 383-8239 for Discover®.

(Continued Next Page)

Cross Reference

Information contained in this section is furnished as a guide.
Verify specific application elsewhere in this catalog when possible.

Competitive Part No.	Competitor's Name	STEMCO Misc Products	STEMCO Std/ Grit Guard®	STEMCO Guardian®	STEMCO Voyager®	STEMCO Discover®
5471	National		372-7025 ☒			
5471	National		392-9021 ☒			
5471	National		392-9046 ☒			
5473	National		392-9001			
547915C91	Navistar		392-9099	309-0912/0915	393-0112	393-0212
5481	National		372-7025 ☒			
5481	National		392-9131	309-0973	393-0173	393-0273
548347C91	Navistar		392-9131	309-0973	393-0173	393-0273
548347C92	Navistar		392-9131	309-0973	393-0173	393-0273
54935	C/R		392-9001			
5495	National		392-9087	309-0970		
55122	C/R					
55172	C/R					
55175	C/R		392-9053			
55177	C/R		392-9053			
56153R91	Navistar		392-9021 ☒			
562932C1	Navistar		382-8028			
5667	National		392-9099	309-0915		
5751	National		392-9038			
578913C1	Navistar	320-2041				
58394	Eaton		392-9088	309-0964		
587989C91	Navistar		382-8056 ☒	308-0856	383-0156	
589822C91	Navistar		382-8053 ☒	308-0853	383-0153	
591587C1	Navistar		382-8056 ☒	308-0855		
594962C1	Navistar		392-9131	309-0973	393-0173	393-0273
594963C1	Navistar		392-9099	309-0912/0915	393-0112	393-0212
594964C1	Navistar		382-8064	308-0864	383-0164	383-0264
594965C1	Navistar		382-8066	308-0866	383-0166	
594966C1	Navistar		382-8053 ☒	308-0853	383-0153	
596555C1	Navistar		382-8036	308-0836	383-0136	383-0236
596556C1	Navistar		392-9001			
60501012	Trailmobile		372-7097	307-0743	373-0143	373-0243
61001G	TriSeal	330-3001				
61002G	TriSeal	330-3019				
61006G	TriSeal	330-3006				
61009G	TriSeal	330-3009				
61011G	TriSeal	330-3011				
61012G	TriSeal	330-3012				
61014G	TriSeal	330-3014 ☒				
61015G	TriSeal	330-3015				
61017G	TriSeal	330-3017				
61018G	TriSeal	330-3018 ☒				
61022G	TriSeal	330-3022				
61024G	TriSeal	330-3024				
61025G	TriSeal	330-3025				
61026G	TriSeal	330-3026 ☒				
61027G	TriSeal	330-3102				
61028G	TriSeal	330-3028				
61031G	TriSeal	330-3031				
61032G	TriSeal	330-3032				
61034G	TriSeal	330-3034				
61036G	TriSeal	330-3036				
61037G	TriSeal	330-3037				
61039G	TriSeal	330-3039				
61040G	TriSeal	330-3040				
61041G	TriSeal	330-3041				
61042G	TriSeal	330-3042				

☒ Discontinued part numbers, refer to Engineering Changes for more information.

1 When using HM516449A, use 392-9130 set.

2 Use 0912 w/ 5.687 bore only; Use 0915 w/ 5.50 bore only.

3 Obsolete set, components still available.

4 Order kit # 383-8139 for Voyager® and 383-8239 for Discover®.

(Continued Next Page)

Cross Reference

Information contained in this section is furnished as a guide.
Verify specific application elsewhere in this catalog when possible.

Competitive Part No.	Competitor's Name	STEMCO Misc Products	STEMCO Std/ Grit Guard®	STEMCO Guardian®	STEMCO Voyager®	STEMCO Discover®
61044G	TriSeal	330-3044				
61045G	TriSeal	330-3045				
61046G	TriSeal	330-3046				
61047G	TriSeal	330-3047 ☒				
61054G	TriSeal	330-3054				
61056G	TriSeal	330-3056				
61060G	TriSeal	330-3060				
61062G	TriSeal	330-3062				
61066G	TriSeal	330-3066				
61067G	TriSeal	330-3067				
61076G	TriSeal	330-3076 ☒				
61077G	TriSeal	330-3077				
61079G	TriSeal	330-3079				
61080G	TriSeal	330-3080				
61090G	TriSeal	330-3090				
61094G	TriSeal	330-3094				
61105G	TriSeal	330-3105				
61106G	TriSeal	330-3106				
61107G	TriSeal	330-3107				
61108G	TriSeal	330-3108				
61109G	TriSeal	330-3109				
61111G	TriSeal	330-3111				
61112G	TriSeal	330-3112				
61113G	TriSeal	330-3113				
61114G	TriSeal	330-3114				
62001	TriSeal	355-5501 ☒				
62002	TriSeal	355-5502 ☒				
62003	TriSeal	355-5503 ☒				
62005	TriSeal	355-5505 ☒				
62006	TriSeal	355-5506 ☒				
62007	TriSeal	355-5507 ☒				
62010	TriSeal	355-5510 ☒				
62016	TriSeal	355-5516 ☒				
6270	National		372-7018 ☒			
6270	National		382-8029 ☒			
6270	National		392-9018			
63003	TriSeal	310-1003 ☒				
63005	TriSeal	310-1005				
63006	TriSeal	310-1006 ☒				
63007	TriSeal	310-1007				
63008	TriSeal	310-1008				
63009	TriSeal	310-1009				
63010	TriSeal	310-1010 ☒				
63011	TriSeal	310-1011 ☒				
63012	TriSeal	310-1012 ☒				
63013	TriSeal	310-1013				
63014	TriSeal	310-1014 ☒				
63017	TriSeal	310-1017				
63018	TriSeal	310-1018				
63021	TriSeal	310-1021 ☒				
63026	TriSeal	310-1026 ☒				
63028	TriSeal	310-1028 ☒				
63029	TriSeal	310-1029 ☒				
63032	TriSeal	310-1032 ☒				
63034	TriSeal	310-1034 ☒				
63035	TriSeal	310-1035 ☒				
63037	TriSeal	310-1037 ☒				

☒ Discontinued part numbers, refer to Engineering Changes for more information.

■ When using HM516449A, use 392-9130 set.

■ Use 0912 w/ 5.687 bore only; Use 0915 w/ 5.50 bore only.

■ Obsolete set, components still available.

■ Order kit # 383-8139 for Voyager® and 383-8239 for Discover®.

(Continued Next Page)

Cross Reference

Information contained in this section is furnished as a guide.
Verify specific application elsewhere in this catalog when possible.

Competitive Part No.	Competitor's Name	STEMCO Misc Products	STEMCO Std/ Grit Guard®	STEMCO Guardian®	STEMCO Voyager®	STEMCO Discover®
63038	TriSeal	310-1038 ⓧ				
63041	TriSeal	310-1041				
63043	TriSeal	310-1043				
63044	TriSeal		310-1044 ⓧ			
63047	TriSeal		310-1047 ⓧ			
63050	TriSeal		310-1050			
63051	TriSeal		310-1051			
63052	TriSeal		310-1052			
63053	TriSeal		310-1053			
63054	TriSeal		310-1054 ⓧ			
63057	TriSeal		310-1057			
63062	TriSeal		310-1062			
63063	TriSeal		310-1063			
63064	TriSeal		310-1064			
63079	TriSeal		310-1079			
63080	TriSeal		310-1080 ⓧ			
63083	TriSeal		310-1083 ⓧ			
63088	TriSeal		310-1088			
63091	TriSeal		310-1091 ⓧ			
63092	TriSeal		310-1092 ⓧ			
63093	TriSeal		310-1093 ⓧ			
63095	TriSeal		310-1095 ⓧ			
63H13	Crane		343-4264			
63H16	Crane		343-4095			
63H7	Crane		343-4009			
64002	TriSeal		343-4019			
64006	TriSeal		343-4006			
64009	TriSeal		343-4009			
64009H	TriSeal		347-4009			
64012	TriSeal		343-4012 ⓧ			
64013	TriSeal		343-4013			
64014	TriSeal		340-4014 ⓧ			
64018	TriSeal		343-4018 ⓧ			
64024	TriSeal		343-4024			
64025	TriSeal		343-4025			
64028	TriSeal		343-4028			
64029	TriSeal		343-4186			
64034	TriSeal		343-4034			
64042	TriSeal		343-4042			
64046	TriSeal		343-4046			
64046	TriSeal		343-4095			
64046	TriSeal		343-4249			
64049	TriSeal		343-4049			
64059	TriSeal		343-4059			
64065	TriSeal		343-4065			
64066	TriSeal		343-4066			
64075A	TriSeal		343-4075			
64075G	TriSeal		342-4075			
64075P	TriSeal		340-4975			
64092	TriSeal		343-4092			
64098	TriSeal		343-4098			
64249	TriSeal		343-4249			
64656	Eaton		460-6006			
64999	TriSeal		359-5990			
65000U	TriSeal			382-8053 ⓧ	308-0853	383-0153
65000W	TriSeal			382-8052		
65000W	TriSeal			382-8053 ⓧ	308-0853	383-0153

ⓧ Discontinued part numbers, refer to Engineering Changes for more information.

1 When using HM516449A, use 392-9130 set.

2 Use 0912 w/ 5.687 bore only; Use 0915 w/ 5.50 bore only.

3 Obsolete set, components still available.

4 Order kit # 383-8139 for Voyager® and 383-8239 for Discover®.

(Continued Next Page)

Cross Reference

Information contained in this section is furnished as a guide.
Verify specific application elsewhere in this catalog when possible.

Competitive Part No.	Competitor's Name	STEMCO Misc Products	STEMCO Std/ Grit Guard®	STEMCO Guardian®	STEMCO Voyager®	STEMCO Discover®
65005	TriSeal			382-8009		
65011W	TriSeal			392-9035	309-0935	
65011W	TriSeal		392-9036			
65016	TriSeal		382-8017			
65024U	TriSeal		392-9099	309-0915		
65027	TriSeal		392-9045			
65027U	TriSeal		392-9045			
65028	TriSeal		372-7025 ☒			
65028	TriSeal		392-9046 ☒			
65030U	TriSeal		392-9089	309-0948	393-0148	
65030W	TriSeal		392-9089	309-0948	393-0148	
65044	TriSeal		392-9007			
65052W	TriSeal		392-9099	309-0912/0915	393-0112	393-0212
65054W	TriSeal		392-9057	309-0957		
65055W	TriSeal		382-8044			
65056U	TriSeal		392-9131	309-0973	393-0173	393-0273
65056W	TriSeal		392-9131	309-0973	393-0173	393-0273
65060U	TriSeal		372-7097	307-0743	373-0143	373-0243
65060W	TriSeal		372-7097	307-0743	373-0143	373-0243
65065W	TriSeal		392-9020 ☒			
65065W	TriSeal		392-9132	309-0960		
65069	TriSeal		382-8027			
65070	TriSeal		392-9054 ☒			
65071U	TriSeal		392-9112	309-0904	393-0104	393-0204
65071U	TriSeal		392-9130	309-0904	393-0104	393-0204
65071W	TriSeal		392-9112	309-0904	393-0104	393-0204
65072W	TriSeal		392-9088	309-0964		
65073W	TriSeal		372-7005 ☒			
65073W	TriSeal		372-7006			
65073W	TriSeal		372-7008 ☒			
65073W	TriSeal		372-7056 ☒			
65073W	TriSeal		382-8011			
65078U	TriSeal		382-8056 ☒	308-0856	383-0156	
65078W	TriSeal		382-8056 ☒	308-0856	383-0156	
65084W	TriSeal		392-9088	309-0964		
65092U	TriSeal		382-8064	308-0864	383-0164	383-0264
65092W	TriSeal		382-8064	308-0864	383-0164	383-0264
65111U	TriSeal		392-9035	309-0935		
65116U	TriSeal		382-8017			
65120U	TriSeal					
65152U	TriSeal		392-9099	309-0912/0915	393-0112	393-0212
65156U	TriSeal		392-9131	309-0973	393-0173	393-0273
65165U	TriSeal		392-9081	309-0960		
65165U	TriSeal		392-9132	309-0960		
65172U	TriSeal		392-9088	309-0964		
65184U	TriSeal		392-9096	309-0965		
65261U	TriSeal		372-7098	307-0713	373-0113	373-0213
65261W	TriSeal		372-7003			
65261W	TriSeal		372-7098	307-0713	373-0113	373-0213
65262U	TriSeal		372-7099	307-0723	373-0123	373-0223
65262W	TriSeal		372-7022			
65262W	TriSeal		372-7099	307-0723	373-0123	373-0223
65262W	TriSeal		382-8060			
65263U	TriSeal		382-8036	308-0836	383-0136	383-0236
65263W	TriSeal		382-8036	308-0836	383-0136	383-0236
65267	TriSeal		382-8029 ☒			
65267	TriSeal		392-9018			

☒ Discontinued part numbers, refer to Engineering Changes for more information.

☒ When using HM516449A, use 392-9130 set.

☒ Use 0912 w/ 5.687 bore only; Use 0915 w/ 5.50 bore only.

☒ Obsolete set, components still available.

☒ Order kit # 383-8139 for Voyager® and 383-8239 for Discover®.

(Continued Next Page)

Cross Reference

Information contained in this section is furnished as a guide.
Verify specific application elsewhere in this catalog when possible.

Competitive Part No.	Competitor's Name	STEMCO Misc Products	STEMCO Std/ Grit Guard®	STEMCO Guardian®	STEMCO Voyager®	STEMCO Discover®
65269W	TriSeal		392-9001			
65269W	TriSeal					
65270U	TriSeal		392-9094	309-0903	393-0103	393-0203
65270W	TriSeal		392-9094	309-0903	393-0103	393-0203
65271W	TriSeal		372-7026 ☒			
65271W	TriSeal		372-7027 ☒			
65271W	TriSeal		372-7028 ☒			
65271W	TriSeal		372-7091 ☒		373-0191	
65272W	TriSeal		392-9094	309-0903	393-0103	393-0203
65275	TriSeal		392-9010 ☒			
65276	TriSeal		392-9099	309-0912/0915	393-0112	393-0212
65277W	TriSeal		392-9095	309-0961		
65280	TriSeal		372-7046			
65280	TriSeal		382-8018 ☒			
65283U	TriSeal		392-9087	309-0970		
65283W	TriSeal		392-9087	309-0970		
65285W	TriSeal		392-9092	309-0965		
65287W	TriSeal		382-8028			
65287W	TriSeal		392-9043 ☒			
65289	TriSeal		382-8032			
65291U	TriSeal		382-8034			
65291W	TriSeal		382-8034			
65292	TriSeal		382-8035 ☒			
65293	TriSeal		382-8010			
65294	TriSeal		382-8023 ☒			
65294	TriSeal		382-8039 ☒			
65294U	TriSeal		382-8023 ☒			
65294U	TriSeal		382-8039 ☒		383-0139	383-0239
65297W	TriSeal		392-9054 ☒			
65298U	TriSeal		372-7095 ☒	307-0744	373-0144	
65298W	TriSeal		372-7095 ☒	307-0744	373-0144	
65299	TriSeal		372-7004 ☒			
65299	TriSeal		372-7015			
65299	TriSeal		372-7017 ☒			
65299	TriSeal		382-8045			
657810	GMC/Volvo		392-9057	309-0957		
6584S	National		382-8017			
663043R91	Navistar		392-9010 ☒			
663477	GMC/Volvo		382-8017			
663484	GMC/Volvo		382-8018 ☒ ☒			
6635S	National		392-9095	309-0961		
6638S	National		382-8036	308-0836	383-0136	383-0236
67003	TriSeal	357-5706 ☒				
67006	TriSeal	356-5606				
67007	TriSeal	364-6402				
67008	TriSeal	364-6435				
67009	TriSeal	310-1103				
67013	TriSeal	310-1013				
67014	TriSeal	310-1114 ☒				
67023	TriSeal	310-1023 ☒				
67036	TriSeal	310-1036				
67038	TriSeal	310-1038 ☒				
67048	TriSeal	310-1048				
67067	TriSeal	310-1067				
67090	TriSeal	310-1111 ☒				
67093	TriSeal	310-1093 ☒				
67094	TriSeal	310-1111 ☒				

☒ Discontinued part numbers, refer to Engineering Changes for more information.

1 When using HM516449A, use 392-9130 set.

2 Use 0912 w/ 5.687 bore only; Use 0915 w/ 5.50 bore only.

3 Obsolete set, components still available.

4 Order kit # 383-8139 for Voyager® and 383-8239 for Discover®.

(Continued Next Page)

Cross Reference

Information contained in this section is furnished as a guide.
Verify specific application elsewhere in this catalog when possible.

Competitive Part No.	Competitor's Name	STEMCO Misc Products	STEMCO Std/ Grit Guard®	STEMCO Guardian®	STEMCO Voyager®	STEMCO Discover®
674237 675711 6780S	GMC/Volvo White National		382-8028 392-9088 382-8018 ☒	309-0964		
68013 68023 680272R92	TriSeal TriSeal Navistar	315-1507 315-1503 343-4046				
680272R92 680299R1 680299R91	Navistar Navistar Navistar	343-4249 310-1028 ☒	382-8028			
6804010425 68048 68088	Freightliner TriSeal TriSeal	343-4281 315-1504 315-1515				
68093 68094 6809970049	TriSeal TriSeal Freightliner	315-1517 ☒ 315-1502 330-3040				
681277 681365R2 6814010225	White Navistar Freightliner	310-1079 343-4095	392-9095	309-0961		
6819970046 6819970046 6819970446	Mercedes Freightliner Freightliner		392-9099 392-9099 382-8036	309-0912/0915 309-0912/0915 308-0836	393-0112 393-0112 383-0136	393-0212 393-0212 383-0236
6819970546 682809 683590	Freightliner GMC/Volvo GMC/Volvo		392-9131 382-8010 392-9018	309-0973	393-0173 393-0173	393-0273
683591 68380 685215	GMC/Volvo Eaton GMC/Volvo	320-2106	392-9057 392-9096	309-0957 309-0965		
685216 68537R1 68537R91	GMC/Volvo Navistar Navistar	320-2106	392-9021 ☒ 392-9021 ☒			
686059 6864S 686996	GMC/Volvo National GMC/Volvo	343-4066	392-9057	309-0957		
6872S 6872S 6873S	National National National		392-9021 ☒ 392-9131 392-9001	309-0973	393-0173	393-0273
688316 688319 69307R91	GMC/Volvo GMC/Volvo Navistar	320-2091 ☒ 320-2091 ☒	392-9035	309-0935		
69502 69507 69510	TriSeal TriSeal TriSeal	320-2041	372-7004 ☒ 372-7009 ☒ 372-7098	307-0713	373-0113	373-0213
69512 69514 69517	TriSeal TriSeal TriSeal		372-7015 372-7017 ☒ 372-7020 ☒			
69520 69522 69523	TriSeal TriSeal TriSeal		372-7099 372-7025 ☒ 372-7026 ☒	307-0723	373-0123	373-0223
69524 69538 69539	TriSeal TriSeal TriSeal		372-7027 ☒ 372-7028 ☒ 372-7049			
69541 69589 69590	TriSeal TriSeal TriSeal		372-7091 ☒ 372-7005 ☒ 372-7006		373-0191	
69591 69593 69594	TriSeal TriSeal TriSeal		372-7008 ☒ 372-7003 372-7022			

☒ Discontinued part numbers, refer to Engineering Changes for more information.

☒ When using HM516449A, use 392-9130 set.

☒ Use 0912 w/ 5.687 bore only; Use 0915 w/ 5.50 bore only.

☒ Obsolete set, components still available.

☒ Order kit # 383-8139 for Voyager® and 383-8239 for Discover®.

(Continued Next Page)

Cross Reference

Information contained in this section is furnished as a guide.
Verify specific application elsewhere in this catalog when possible.

Competitive Part No.	Competitor's Name	STEMCO Misc Products	STEMCO Std/ Grit Guard®	STEMCO Guardian®	STEMCO Voyager®	STEMCO Discover®
69596	TriSeal		372-7099	307-0723	373-0123	373-0223
69597	TriSeal		372-7098	307-0713	373-0113	373-0213
69598	TriSeal		372-7097	307-0743	373-0143	373-0243
69599	TriSeal		372-7095	307-0744	373-0144	
69603	TriSeal		382-8009			
69604	TriSeal		382-8010			
69611	TriSeal		382-8017			
69612	TriSeal		382-8018 ⓧ			
69616	TriSeal		382-8023 ⓧ			
69622	TriSeal		382-8032			
69625	TriSeal		382-8035 ⓧ			
69628	TriSeal		382-8039 ⓧ		383-0139	383-0239
69636	TriSeal		382-8027			
69640	TriSeal		382-8045			
69642	TriSeal		382-8063	308-0863		
69644	TriSeal		382-8062			
69645	TriSeal		382-8066	308-0866	383-0166	
69689	TriSeal		382-8011			
69690	TriSeal		382-8028			
69691	TriSeal		382-8052			
69692	TriSeal		382-8053 ⓧ	308-0853	383-0153	
69693	TriSeal		382-8034			
69695	TriSeal		382-8044			
69696	TriSeal		382-8056 ⓧ	308-0856	383-0156	
69697	TriSeal		382-8064	308-0864	383-0164	383-0264
69698	TriSeal		382-8060			
69699	TriSeal		382-8036	308-0836	383-0136	383-0236
69705	TriSeal		392-9010 ⓧ			
69706	TriSeal		392-9099	309-0912/0915	393-0112	393-0212
69711	TriSeal		392-9018			
69730	TriSeal		392-9038			
69743	TriSeal		392-9045			
69750	TriSeal		392-9007			
69751	TriSeal		392-9020 ⓧ			
69753	TriSeal		392-9054 ⓧ			
69759	TriSeal		392-9062			
69780	TriSeal		392-9019			
69781	TriSeal		392-9089	309-0948	393-0148	
69782	TriSeal		392-9062			
69783	TriSeal		392-9001			
69784	TriSeal		392-9043 ⓧ			
69785	TriSeal		392-9035	309-0935		
69786	TriSeal		392-9036			
69787	TriSeal		392-9057	309-0957		
69788	TriSeal		392-9112	309-0904	393-0104	393-0204
69789	TriSeal		392-9087	309-0970		
69790	TriSeal		392-9032			
69791	TriSeal		392-9088	309-0964		
69792	TriSeal		392-9092	309-0965		
69794	TriSeal		392-9099	309-0912/0915	393-0112	393-0212
69795	TriSeal		392-9095	309-0961		
69797	TriSeal		392-9096	309-0965		
69798	TriSeal		392-9132	309-0960		
69799	TriSeal		392-9131	309-0973	393-0173	393-0273
698764R1	Navistar		372-7098	307-0713	373-0113	373-0213
70012600E	Trailmobile	343-4009				
700126CD	Trailmobile	343-4013				

ⓧ Discontinued part numbers, refer to Engineering Changes for more information.

1 When using HM516449A, use 392-9130 set.

2 Use 0912 w/ 5.687 bore only; Use 0915 w/ 5.50 bore only.



3 Obsolete set, components still available.

4 Order kit # 383-8139 for Voyager® and 383-8239 for Discover®.

(Continued Next Page)

Cross Reference

Information contained in this section is furnished as a guide.
Verify specific application elsewhere in this catalog when possible.

Competitive Part No.	Competitor's Name	STEMCO Misc Products	STEMCO Std/ Grit Guard®	STEMCO Guardian®	STEMCO Voyager®	STEMCO Discover®
7003942 7006S 701661	Western Star National GMC/Volvo	343-4249	392-9087	309-0970		
701679 7023479 705400P	GMC/Volvo Meritor Mechanex/Barrier	315-1502 320-2115 343-4095	382-8036	308-0836	383-0136	383-0236
70541 70596 70597	TriSeal TriSeal TriSeal		372-7091  372-7099 372-7098	307-0723 307-0713	373-0191 373-0123 373-0113	373-0223 373-0213
70598 70599 7074450	TriSeal TriSeal Western Star	320-2106	372-7097 372-7095	307-0743 307-0744	373-0143 373-0144	373-0243
70781 70788 70789	TriSeal TriSeal TriSeal		392-9089 392-9112 392-9087	309-0948 309-0904 309-0970	393-0148 393-0104	393-0204
70791 70794 70796	TriSeal TriSeal TriSeal		392-9088 392-9099 392-9094	309-0964 309-0912/0915 309-0903	393-0112 393-0103	393-0212 393-0203
70797 70798 70799	TriSeal TriSeal TriSeal		392-9096 392-9132 392-9131	309-0965 309-0960 309-0973	393-0173	393-0273
710356 710536 712832	GMC/Volvo GMC/Volvo GMC/Volvo	382-8034	382-8017 382-8017			
712834 719021 720659	GMC/Volvo C/R GMC/Volvo	330-3077	392-9099 372-7097	309-0912/0915 307-0743	393-0112 373-0143	393-0212 373-0243
730001 730003 730003	National National National	330-3028 330-3025 330-3035				
730004 730005 730006	National National National	330-3024 330-3008  330-3046				
730008 730009 730016	National National National	330-3040 330-3019 330-3041				
730017 730018 730019	National National National	330-3044 330-3006 330-3031				
730022 730024 730026	National National National	330-3011 330-3060 330-3012				
730027 730030 730031	National National National	330-3034 330-3056 330-3037				
730149 733067 733105	National National National	330-3097 330-3009/3067 330-3105				
733106 733107 733108	National National National	330-3106 330-3107 330-3108				
733109 733110 733111	National National National	330-3109 330-3110 330-3111				
733112 733113 733114	National National National	330-3112 330-3113 330-3114				

 Discontinued part numbers, refer to Engineering Changes for more information.

 When using HM516449A, use 392-9130 set.

 Use 0912 w/ 5.687 bore only; Use 0915 w/ 5.50 bore only.

 Obsolete set, components still available.

 Order kit # 383-8139 for Voyager® and 383-8239 for Discover®.

(Continued Next Page)

Cross Reference

Information contained in this section is furnished as a guide.
Verify specific application elsewhere in this catalog when possible.

Competitive Part No.	Competitor's Name	STEMCO Misc Products	STEMCO Std/ Grit Guard®	STEMCO Guardian®	STEMCO Voyager®	STEMCO Discover®
733115	National	330-3115				
7378	National		392-9087	309-0970		
741147	GMC/Volvo		392-9032			
745400P	Mechanex/Barrier		372-7099	307-0723	373-0123	373-0223
747400P	Mechanex/Barrier		372-7098	307-0713	373-0113	373-0213
747400P	Mechanex/Barrier		392-9032			
749400P	Mechanex/Barrier		372-7095	307-0744	373-0144	
755400P	Mechanex/Barrier		372-7097	307-0743	373-0143	373-0243
761400P	Mechanex/Barrier		392-9131	309-0973	393-0173	393-0273
770400P	Mechanex/Barrier		392-9099	309-0912/0915	393-0112	393-0212
771723C91	Navistar		392-9088	309-0964		
775698C91	Navistar		392-9131	309-0973	393-0173	393-0273
780055C91	Navistar	320-2092 ⓧ				
780316C91	Navistar		382-8053 ⓧ	308-0853	383-0153	
781265C91	Navistar	343-4249				
781565C92	Navistar	343-4250				
785400P	Mechanex/Barrier		392-9094	309-0903	393-0103	393-0203
7866S	National		382-8028			
7866S	National		392-9043 ⓧ			
794408C91	Navistar		382-8064	308-0864	383-0164	383-0264
79470	Eaton	460-6002				
7EQ1175A	Ford		392-9018			
7EQH1175	Ford		392-9099	309-0912/0915	393-0112	393-0212
8061231	GMC/Volvo	330-3009				
8069924	GMC/Volvo	343-4024				
806994	GMC/Volvo	343-4024				
810196	Eaton	320-2137				
810197	Eaton	310-1037 ⓧ				
812928	Eaton	343-4095				
815214	Eaton	343-4195				
815215	Eaton		372-7099	307-0723	373-0123	373-0223
815312	Eaton	330-3106				
815996	Eaton	343-4264				
81774	C/R	310-1111 ⓧ				
820394	Eaton	447-4743				
820395	Eaton	447-4743				
821187	Eaton	340-5098				
821338	Eaton	343-4009				
821345	Eaton	310-1036				
821346	Eaton	320-2036 ⓧ				
821601	Eaton		372-7097	307-0743	373-0143	373-0243
821604	Eaton	315-1504				
821610	Eaton	320-2110				
821615	Eaton	340-4119				
821907	Eaton	343-4009				
847	NOK		382-8036	308-0836	383-0136	383-0236
848	NOK		392-9099	309-0915	393-0115	
849	NOK		392-9099	309-0912/0915	393-0112	393-0212
850	NOK		372-7098	307-0713	373-0113	373-0213
851	NOK		372-7099	307-0723	373-0123	373-0223
852	NOK		392-9112	309-0904	393-0104	393-0204
853	NOK		372-7095	307-0744	373-0144	
854	NOK		392-9092	309-0965		
854945	GMC/Volvo	460-6005 ⓧ				
855	NOK		382-8053 ⓧ	308-0853	383-0153	
856	NOK		392-9094	309-0903	393-0103	393-0203
857	NOK		382-8056 ⓧ	308-0856	383-0156	

ⓧ Discontinued part numbers, refer to Engineering Changes for more information.

1 When using HM516449A, use 392-9130 set.

2 Use 0912 w/ 5.687 bore only; Use 0915 w/ 5.50 bore only.

3 Obsolete set, components still available.

4 Order kit # 383-8139 for Voyager® and 383-8239 for Discover®.

(Continued Next Page)

Cross Reference

Information contained in this section is furnished as a guide.
Verify specific application elsewhere in this catalog when possible.

Competitive Part No.	Competitor's Name	STEMCO Misc Products	STEMCO Std/ Grit Guard®	STEMCO Guardian®	STEMCO Voyager®	STEMCO Discover®
858	NOK		392-9088	309-0964		
858381	GMC/Volvo	343-4024				
858381	Western Star	343-4024				
859	NOK		372-7097	307-0743	373-0143	373-0243
860	NOK		392-9132	309-0960		
861	NOK		392-9131	309-0973	393-0173	393-0273
86109	Trailmobile	347-4009				
862500	GMC/Volvo	343-4009				
862500	Western Star	343-4009				
862501	Western Star	330-3009/3067				
862739C91	Navistar		392-9036			
862935C1	Navistar	310-1063				
863	NOK		382-8064	308-0864	383-0164	383-0264
864643C91	Navistar		392-9099	309-0912/0915		
864643C92	Navistar		392-9099	309-0912/0915		
864784C91	Navistar		392-9099	309-0912/0915		
8668	Trailmobile	340/343-4009				
868861R1	Navistar	330-3024				
870485C91	Navistar		392-9088	309-0964		
870889C91	Navistar		382-8064	308-0864	383-0164	383-0264
870890C91	Navistar		382-8064	308-0864	383-0164	383-0264
8720	Trailmobile	330-3009				
875188R2	Navistar		392-9099	309-0912/0915		
876235R91	Navistar		382-8029			
88319	NOK			309-0973	393-0173	393-0273
88327	Eaton		392-9062			
8872	National		382-8064	308-0864	383-0164	383-0264
8873095	GMC/Volvo	460-6006				
8873424	GMC/Volvo	310-1014				
889246	White	460-6007				
88AX110	Mack		382-8023			
88AX110	Mack		382-8039		383-0139	383-0239
88AX177	Mack		392-9094	309-0903	393-0103	393-0203
88AX305	Mack		382-8023			
88AX305	Mack		382-8039		383-0139	383-0239
88AX354P2	Mack	429-0009				
88AX372	Mack		392-9098	309-0948	393-0148	
88AX374	Mack		392-9007			
88AX375	Mack		392-9089	309-0948	393-0148	
88AX376	Mack		392-9089	309-0948	393-0148	
88AX378	Mack		392-9007			
88AX382	Mack		392-9089	309-0948	393-0148	
88AX402	Mack		392-9089	309-0948	393-0148	
88AX403	Mack		392-9089	309-0948	393-0148	
88AX404	Mack		392-9089	309-0948	393-0148	
88AX405	Mack		392-9112	309-0904	393-0104	393-0204
88AX407	Mack		392-9094	309-0903	393-0103	393-0203
88AX418	Mack		392-9112	309-0904	393-0104	393-0204
88AX420	Mack		392-9131	309-0973	393-0173	393-0273
88AX421	Mack		392-9094	309-0903	393-0103	393-0203
88AX424	Mack		392-9089	309-0948	393-0148	
88AX427	Mack		392-9096	309-0965		
88AX432	Mack	320-2009				
88AX443	Mack		392-9081	309-0960		
88AX448	Mack		392-9112	309-0904	393-0104	393-0204
88AX450	Mack		392-9132	309-0960		
88AX456	Mack	429-0008				

ⓧ Discontinued part numbers, refer to Engineering Changes for more information.

■ When using HM516449A, use 392-9130 set.

■ Use 0912 w/ 5.687 bore only; Use 0915 w/ 5.50 bore only.

■ Obsolete set, components still available.

■ Order kit # 383-8139 for Voyager® and 383-8239 for Discover®.

(Continued Next Page)

Cross Reference

Information contained in this section is furnished as a guide.
Verify specific application elsewhere in this catalog when possible.

Competitive Part No.	Competitor's Name	STEMCO Misc Products	STEMCO Std/ Grit Guard®	STEMCO Guardian®	STEMCO Voyager®	STEMCO Discover®
88AX457	Mack	429-0009				
88AX458	Mack	429-0002				
88AX461	Mack		392-9131	309-0973	393-0173	393-0273
88AX466	Mack		392-9112	309-0904	393-0104	393-0204
88AX467	Mack		392-9094	309-0903	393-0103	393-0203
88AX469	Mack		382-8064	308-0864	383-0164	383-0264
88AX59	Mack		392-9032			
88AX59P3	Mack		392-9032			
88AX65	Mack		392-9007			
88AX70	Mack		382-8011			
88AX72	Mack		392-9019 ⓧ			
88AX97	Mack		382-8011			
88AZ110	Mack	320-2039 ⓧ				
88AZ110P1	Mack		382-8039 ⓧ		383-0139	383-0239
891016	Western Star	320-2001				
896941R91	Navistar		382-8064	308-0864	383-0164	383-0264
8976S	National		382-8009			
898235R92	Navistar	320-2114				
898235R93	Navistar		392-9096	309-0965		
900868	Trailmobile	343-4075				
9015S	National		392-9131	309-0973	393-0173	393-0273
9022299832	Heil	343-4075				
9022299868	Heil		372-7099	307-0723	373-0123	373-0223
90501017	Trailmobile		372-7097	307-0743	373-0143	373-0243
90501018	Trailmobile	320-2023				
90501019	Trailmobile	315-1503				
9128S	National		392-9045			
9156004	GMC/Volvo	310-1010				
921010001	Western Star	330-3097				
921010002	GMC/Volvo	343-4024				
921010003	GMC/Volvo	343-4046				
921010005	GMC/Volvo	343-4042				
921010006	GMC/Volvo	343-4042				
921010007	GMC/Volvo	343-4042				
921010008	GMC/Volvo	343-4042				
921010009	GMC/Volvo	340/343-4009				
921010024	GMC/Volvo	340-4119				
921010034	GMC/Volvo	343-4095				
921010043	GMC/Volvo	343-4281				
921015015	GMC/Volvo	343-4009				
921020001	GMC/Volvo	330-3097				
921030002	GMC/Volvo	359-5990				
925172R91	Navistar		382-8028			
925173R91	Navistar		382-8028			
92794	GMC/Volvo	460-6005 ⓧ				
93333R91	Navistar		382-8017			
9339S	National		382-8036	308-0836	383-0136	383-0236
940010001	GMC/Volvo		382-8064	308-0864	383-0164	383-0264
940010002	GMC/Volvo	320-2099				
940010002	Western Star	320-2099				
940010003	GMC/Volvo		392-9062			
940010004	GMC/Volvo	320-2036 ⓧ				
940010004	Western Star	320-2036 ⓧ				
940010005	GMC/Volvo	320-2137				
940010005	Western Star	320-2137				
940010006	GMC/Volvo		372-7097	307-0743	373-0143	373-0243
940010007	GMC/Volvo		392-9053			

ⓧ Discontinued part numbers, refer to Engineering Changes for more information.

1 When using HM516449A, use 392-9130 set.

2 Use 0912 w/ 5.687 bore only; Use 0915 w/ 5.50 bore only.

3 Obsolete set, components still available.

4 Order kit # 383-8139 for Voyager® and 383-8239 for Discover®.

(Continued Next Page)

Cross Reference

Information contained in this section is furnished as a guide.
Verify specific application elsewhere in this catalog when possible.

Competitive Part No.	Competitor's Name	STEMCO Misc Products	STEMCO Std/ Grit Guard®	STEMCO Guardian®	STEMCO Voyager®	STEMCO Discover®
940010010	GMC/Volvo		382-8036	308-0836	383-0136	383-0236
940010011	GMC/Volvo		392-9087	309-0970		
940010013	GMC/Volvo		392-9087	309-0970		
940010013	Western Star	320-2162				
940010014	GMC/Volvo		382-8036	308-0836	383-0136	383-0236
940010015	GMC/Volvo		392-9087	309-0970		
940010017	GMC/Volvo		392-9099	309-0912		
940010019	GMC/Volvo		392-9131	309-0973	393-0173	393-0273
940010021	GMC/Volvo		382-8036	308-0836	383-0136	383-0236
940010022	GMC/Volvo		392-9131	309-0973	393-0173	393-0273
940010022	Western Star		392-9131	309-0973	393-0173	393-0273
940010028	GMC/Volvo		392-9131	309-0973	393-0173	393-0273
940010029	GMC/Volvo		382-8036	308-0836	383-0136	383-0236
940010030	GMC/Volvo		392-9131	309-0973	393-0173	393-0273
940010034	GMC/Volvo		392-9131	309-0973	393-0173	393-0273
940010038	GMC/Volvo		382-8064	308-0864	383-0164	383-0264
940010039	GMC/Volvo		382-8036	308-0836	383-0136	383-0236
940010040	GMC/Volvo		392-9131	309-0973	393-0173	393-0273
940013401	GMC/Volvo	310-1048				
940013406	GMC/Volvo	320-2110				
940013406	Western Star	320-2110				
940013409	GMC/Volvo		372-7097	307-0743	373-0143	373-0243
940013410	GMC/Volvo		372-7097	307-0743	373-0143	373-0243
940013412	Western Star		372-7097	307-0743	373-0143	373-0243
940013602	GMC/Volvo		392-9081	309-0960		
940013604	GMC/Volvo		382-8036	308-0836	383-0136	383-0236
940013606	GMC/Volvo		382-8045			
940013802	GMC/Volvo	320-2109				
940013804	GMC/Volvo	320-2110				
940013902	Western Star		382-8064	308-0864	383-0164	383-0264
940015001	Western Star		382-8036	308-0836	383-0136	383-0236
940040001	GMC/Volvo	310-1089				
940040001	Western Star	310-1089				
940040002	Western Star	310-1103				
940040003	GMC/Volvo	310-1095				
940040004	Western Star	310-1036				
940040007	GMC/Volvo	315-1502				
940040007	Western Star	315-1502				
940043401	Western Star	310-1048				
940043802	GMC/Volvo	315-1504				
94RU150	Mack	359-5990				
94RU19309	Mack	330-3024				
94RU262	Mack	330-3025				
94RU263	Mack	330-3009/3067				
94RU263P2	Mack	330-3097				
94RU263P3	Mack	330-3122				
94RU264	Mack	330-3046				
94RU265	Mack	330-3008				
94RU266	Mack	330-3031				
94RU267	Mack	330-3046				
94RU278	Mack	330-3012				
95357	Eaton		392-9099	309-0912/0915		
9584	National		392-9035	309-0935		
966446R91	Navistar	460-6001				
968191R92	Navistar	343-4036				
971118R1	Navistar					
972401R91	Navistar		392-9099	309-0912/0915		

Ⓢ Discontinued part numbers, refer to Engineering Changes for more information.

1 When using HM516449A, use 392-9130 set.

2 Use 0912 w/ 5.687 bore only; Use 0915 w/ 5.50 bore only.

3 Obsolete set, components still available.

4 Order kit # 383-8139 for Voyager® and 383-8239 for Discover®.

(Continued Next Page)

Cross Reference

Information contained in this section is furnished as a guide.
Verify specific application elsewhere in this catalog when possible.

Competitive Part No.	Competitor's Name	STEMCO Misc Products	STEMCO Std/ Grit Guard®	STEMCO Guardian®	STEMCO Voyager®	STEMCO Discover®
972424R91	Navistar	460-6012				
974526R91	Navistar		392-9131	309-0973	393-0173	393-0273
974644R1	Navistar		392-9021 ☒			
974644R1	Navistar		392-9046 ☒			
974644R91	Navistar		392-9021 ☒			
974644R91	Navistar		392-9046 ☒			
982259R91	Navistar		392-9001			
983006R91	Navistar		392-9095	309-0961		
983570R1	Navistar		392-9131	309-0973	393-0173	393-0273
992481C91	Navistar		382-8066	308-0866	383-0166	
992484C91	Navistar		382-8056 ☒	308-0856	383-0156	
992485C91	Navistar		382-8056 ☒	308-0856	383-0156	
A11244C393	Meritor	310-1095 ☒				
A1205A1925	Meritor	460-6004				
A1205B1250	Meritor	320-2110				
A1205B1926	Meritor	460-6011				
A1205B2264	Meritor		382-8036	308-0836	383-0136	383-0236
A1205B574	Meritor		392-9057	309-0957		
A1205C1381	Meritor	320-2105				
A1205C1719	Meritor		382-8071			
A1205C1875	Meritor		372-7098	307-0713	373-0113	373-0213
A1205C1875	Meritor		392-9032			
A1205C1927	Meritor	460-6007				
A1205C2343	Meritor		372-7097	307-0743	373-0143	373-0243
A1205D1070	Meritor	320-2137				
A1205D2526	Meritor		392-9099	309-0912	393-0112	393-0212
A1205D2578	Meritor		382-8064	308-0864	383-0164	383-0264
A1205E1071	Meritor	320-2036 ☒				
A1205E1253	Meritor		392-9057	309-0957		
A1205E1799	Meritor		372-7098	307-0713	373-0113	373-0213
A1205E2475	Meritor		382-8036	308-0836	383-0136	383-0236
A1205F136	Meritor		382-8001 ☒		383-0101	
A1205F2554	Meritor		382-8066	308-0866	383-0166	
A1205G1515	Meritor		382-8063	308-0863		
A1205G2191	Meritor		372-7097	307-0743	373-0143	373-0243
A1205G2503	Meritor		392-9099	309-0912	393-0112	393-0212
A1205G631	Meritor		382-8036	308-0836	383-0136	383-0236
A1205G735	Meritor		392-9038			
A1205H1100	Meritor	320-2061				
A1205H762	Meritor		382-8028			
A1205J1934	Meritor	460-6005 ☒				
A1205J2194	Meritor		392-9131	309-0973	393-0173	393-0273
A1205J2350	Meritor		392-9132	309-0960		
A1205J2428	Meritor	460-6011				
A1205J634	Meritor		392-9095	309-0961		
A1205J998	Meritor	460-6001				
A1205K1285	Meritor	320-2106				
A1205K2013	Meritor		382-8001 ☒		383-0101	
A1205K2351	Meritor		372-7099	307-0723	373-0123	373-0223
A1205K999	Meritor		372-7097	307-0743	373-0143	373-0243
A1205L1338	Meritor		382-8036	308-0836	383-0136	383-0236
A1205L1546	Meritor		392-9034 ☒		393-0134	
A1205L1598	Meritor		372-7097	307-0743	373-0143	373-0243
A1205L2352	Meritor		392-9131	309-0973	393-0173	393-0273
A1205L714	Meritor	460-6003				
A1205M1339	Meritor		382-8064	308-0864		
A1205M1625	Meritor		392-9033 ☒			

☒ Discontinued part numbers, refer to Engineering Changes for more information.

1 When using HM516449A, use 392-9130 set.

2 Use 0912 w/ 5.687 bore only; Use 0915 w/ 5.50 bore only.

3 Obsolete set, components still available.

4 Order kit # 383-8139 for Voyager® and 383-8239 for Discover®.

(Continued Next Page)

Cross Reference

Information contained in this section is furnished as a guide.
Verify specific application elsewhere in this catalog when possible.

Competitive Part No.	Competitor's Name	STEMCO Misc Products	STEMCO Std/ Grit Guard®	STEMCO Guardian®	STEMCO Voyager®	STEMCO Discover®
A1205M897	Meritor		372-7098	307-0713	373-0113	
A1205N1912	Meritor		382-8036	308-0836	383-0136	383-0236
A1205N898	Meritor		372-7095	307-0744	373-0144	
A1205P1108	Meritor		382-8064	308-0864	383-0164	383-0264
A1205P1212	Meritor		372-7097	307-0743	373-0143	373-0243
A1205P1888	Meritor		372-7099	307-0723	373-0123	373-0223
A1205P276	Meritor		392-9038			
A1205P666	Meritor		392-9034 ☒		393-0134	
A1205Q1889	Meritor		372-7099	307-0713	373-0123	373-0223
A1205Q1915	Meritor	460-6012				
A1205Q2487	Meritor		392-9131	309-0973	393-0173	393-0273
A1205R1630	Meritor		392-9087	309-0970		
A1205R2410	Meritor		392-9131	309-0973	393-0173	393-0273
A1205R2566	Meritor		372-7097	307-0743	373-0143	373-0243
A1205S2307	Meritor		382-8064	308-0864	383-0164	383-0264
A1205S669	Meritor		382-8018 ☒			
A1205T1502	Meritor		392-9038			
A1205T1814	Meritor		392-9007			
A1205T436	Meritor		382-8029 ☒			
A1205T670	Meritor		392-9033 ☒			
A1205T696	Meritor		392-9131	309-0973	393-0173	393-0273
A1205T774	Meritor		392-9053			
A1205U1061	Meritor		392-9131	309-0973	393-0173	393-0273
A1205U1659	Meritor	320-2099				
A1205U1711	Meritor	320-2133				
A1205U1737	Meritor	460-6006				
A1205U2101	Meritor		392-9131	309-0973	393-0173	393-0273
A1205U2205	Meritor		372-7062			
A1205U2491	Meritor		382-8036	308-0836	383-0136	383-0236
A1205U697	Meritor		392-9087	309-0970		
A1205V1192	Meritor	320-2086				
A1205V2102	Meritor		382-8044			
A1205V2180	Meritor		392-9131	309-0973	393-0173	393-0273
A1205V2492	Meritor		392-9131	309-0973	393-0173	393-0273
A1205W1349	Meritor		392-9099	309-0912/0915		
A1205W1375	Meritor		382-8036	308-0836	383-0136	383-0236
A1205W1557	Meritor		392-9035	309-0935		
A1205W1557	Meritor		392-9036			
A1205X1662	Meritor		372-7097	307-0743	373-0143	373-0243
A1205X2702	Meritor		372-7097	307-0743	373-0143	373-0243
A1205X700	Meritor		392-9001			
A1205Y1559	Meritor		372-7018 ☒			
A1205Y1559	Meritor		392-9018			
A1205Y1715	Meritor		382-8044			
A1205Y1975	Meritor		372-7099	307-0723	373-0123	373-0223
A1205Y727	Meritor	460-6006				
A1205Z1638	Meritor		382-8045			
A1205Z1742	Meritor	320-2104				
A1205Z1820	Meritor		392-9053			
A1205Z2470	Meritor		392-9099	309-0912/0915		
A1205Z364	Meritor		382-8001 ☒			
A1205Z780	Meritor	382-8064	308-0864			
A1244C393	Meritor	310-1095 ☒				
A1244V1556	Meritor	310-1093 ☒				
A-1227-A-105	Meritor	448-4836				
A-1227-S-331	Meritor	449-4973				
A1805E369	Meritor		382-8017			

☒ Discontinued part numbers, refer to Engineering Changes for more information.

1 When using HM516449A, use 392-9130 set.

2 Use 0912 w/ 5.687 bore only; Use 0915 w/ 5.50 bore only.

3 Obsolete set, components still available.

4 Order kit # 383-8139 for Voyager® and 383-8239 for Discover®.

(Continued Next Page)

Cross Reference

Information contained in this section is furnished as a guide.
Verify specific application elsewhere in this catalog when possible.

Competitive Part No.	Competitor's Name	STEMCO Misc Products	STEMCO Std/ Grit Guard®	STEMCO Guardian®	STEMCO Voyager®	STEMCO Discover®
A1805S615	Meritor		392-9094	309-0903	393-0103	393-0203
A1805U723	Meritor		382-8017			
A1805V542	Meritor		392-9131	309-0973	393-0173	393-0273
A1805W725	Meritor		372-7018 ☒			
A1805W725	Meritor		392-9018			
A205F1032	Meritor		392-9033 ☒			
A205F1043	Meritor		392-9033 ☒			
A2208N820	Meritor	330-3097				
A3262A1353	Meritor	343-4176				
A3262C133	Meritor	343-4009				
A3262D264	Meritor	343-4249				
A3262F214	Meritor	343-4049				
A3262G1177	Meritor	343-4095				
A3262G215	Meritor	343-4024				
A3262H1048	Meritor	347-4009				
A3262H398	Meritor	343-4009				
A3262J1180	Meritor	343-4195				
A3262J166	Meritor	343-4080				
A3262M1183	Meritor	341-4009				
A3262Q277	Meritor	343-4065				
A3262Q407	Meritor	343-4075				
A3262T1216	Meritor	343-4024				
A545634	Fruehauf		372-7003			
ACA5207	Fruehauf		372-7099	307-0723	373-0123	373-0223
ACA52071	Fruehauf		372-7099	307-0723	373-0123	373-0223
ACE55171	Fruehauf		372-7099	307-0723	373-0123	373-0223
ACE-8510-001	Fruehauf	447-4723				
ACF006562	Fruehauf		372-7099	307-0723	373-0123	373-0223
ACF6562	Fruehauf		372-7099	307-0723	373-0123	373-0223
AR10	National	310-1041				
AR12	National	310-1038 ☒				
AR2	National	310-1022				
AR20	National	310-1095 ☒				
AR4	National	310-1051				
AR5	National	310-1050				
AR6	National	310-1032 ☒				
AX12-1500	Axilok	448-4836				
AX12-3250	Axilok	449-4973				
AX12-3480	Axilok	447-4723				
AX12-3500	Axilok	447-4724				
AX16-2625	Axilok	447-4743				
AX18-1500	Axilok	448-4837				
AXA0043	Fruehauf		372-7099	307-0723	373-0123	373-0223
B370131BGO	National		382-8056 ☒	308-0856	383-0156	
B6J1175A	Ford		392-9038			
B6Q1175A	Ford		392-9035	309-0935		
C3TA1190A	Ford		382-8005			
C3TZ1190A	Ford		382-8005			
C3TZ1190C	Ford		382-8018 ☒			
C5TA1190B	Ford		382-8064	308-0864	383-0164	383-0264
C5TA1190D	Ford		382-8027			
C5TZ1190B	Ford		382-8064	308-0864	383-0164	383-0264
C5TZ1190D	Ford		382-8027			
C9HA1190A	Ford		382-8044			
C9HA1190B	Ford		382-8045			
C9HS1131A	Ford	343-4092				
C9HZ1175A	Ford		392-9096	309-0965		

☒ Discontinued part numbers, refer to Engineering Changes for more information.

1 When using HM516449A, use 392-9130 set.

2 Use 0912 w/ 5.687 bore only; Use 0915 w/ 5.50 bore only.

3 Obsolete set, components still available.

4 Order kit # 383-8139 for Voyager® and 383-8239 for Discover®.

(Continued Next Page)

Cross Reference

Information contained in this section is furnished as a guide.
Verify specific application elsewhere in this catalog when possible.

Competitive Part No.	Competitor's Name	STEMCO Misc Products	STEMCO Std/ Grit Guard®	STEMCO Guardian®	STEMCO Voyager®	STEMCO Discover®
C9HZ1175B	Ford		392-9088	309-0964		
C9HZ1190A	Ford		382-8044			
C9HZ1190B	Ford		382-8045			
D0HA1131T	Ford	343-4028				
D0HA1131U	Ford	343-4024				
D0HA1153M	Ford	330-3012				
D0HA1153R	Ford	330-3024				
D0HA1153S	Ford	330-3040				
D0HA1153T	Ford	330-3028				
D0HA1190S	Ford	320-2105				
D0HA3B304C	Ford	310-1008				
D0HZ1131A	Ford	343-4065				
D0HZ1131B	Ford	343-4186				
D0HZ1131C	Ford	343-4024				
D0HZ1131F	Ford	343-4092				
D0HZ1131G	Ford	343-4028				
D0HZ1131K	Ford	343-4049				
D0HZ1153A	Ford	330-3040				
D0HZ1153B	Ford	330-3028				
D0HZ1153C	Ford	330-3024				
D0HZ1153D	Ford	330-3009				
D0HZ1153G	Ford	330-3012				
D0HZ1153J	Ford	330-3040				
D0HZ1153K	Ford	330-3028				
D0HZ1173A	Ford	310-1064				
D0HZ1175A	Ford		392-9038			
D0HZ1175B	Ford		392-9035	309-0935		
D0HZ1175C	Ford		392-9057	309-0957		
D0HZ1175D	Ford		392-9099	309-0912, 0915		
D0HZ1175E	Ford		392-9096	309-0965		
D0HZ1175F	Ford		392-9088	309-0964		
D0HZ1190A	Ford		382-8044			
D0HZ1190B	Ford		382-8036	308-0836	383-0136	383-0236
D0HZ1190C	Ford		382-8045			
D0HZ1A131A	Ford	359-5990				
D0TZ1175A	Ford		392-9038			
D0TZ1175B	Ford		392-9035	309-0935		
D0TZ1175C	Ford		392-9018			
D0TZ1175D	Ford		392-9099	309-0912, 0915		
D0TZ1175E	Ford		392-9057	309-0957		
D1HA1131EA	Ford	343-4124				
D1HA1131FA	Ford	343-4186				
D1HA1131KA	Ford	343-4249				
D1HA1190AA	Ford		382-8036	308-0836	383-0136	383-0236
D1HA1190BA	Ford		382-8045			
D1HA1190DA	Ford		382-8028			
D1HS1175BA	Ford		392-9096	309-0965		
D1HS1175CA	Ford		392-9095	309-0961		
D1HS1190AA	Ford		382-8063	308-0863		
D1HZ1190A	Ford		382-8036	308-0836	383-0136	383-0236
D1HZ1190B	Ford		382-8045			
D2HA4813AA	Ford	460-6007				
D3HS1175BA	Ford	320-2102				
D3TA1190B1A	Ford		382-8063	308-0863		
D5H-3104A	Ford	448-4837				
D5HA1175AA	Ford	320-2106				
D5HZ1175A	Ford		392-9131	309-0973	393-0173	393-0273

Ⓢ Discontinued part numbers, refer to Engineering Changes for more information.

■ When using HM516449A, use 392-9130 set.

■ Use 0912 w/ 5.687 bore only; Use 0915 w/ 5.50 bore only.

■ Obsolete set, components still available.

■ Order kit # 383-8139 for Voyager® and 383-8239 for Discover®.

(Continued Next Page)

Cross Reference

Information contained in this section is furnished as a guide.
Verify specific application elsewhere in this catalog when possible.

Competitive Part No.	Competitor's Name	STEMCO Misc Products	STEMCO Std/ Grit Guard®	STEMCO Guardian®	STEMCO Voyager®	STEMCO Discover®
D5HZ1190A	Ford		382-8063	308-0863		
D5HZ1190B	Ford		382-8036	308-0836	383-0136	383-0236
D5HZ1190C	Ford		382-8064	308-0864	383-0164	383-0264
D5HZ1190D	Ford		382-8064	308-0864	383-0164	383-0264
D5HZ1190E	Ford		382-8063	308-0863		
D7HD1173AA	Ford	310-1089				
D7HD1175AA	Ford	320-2099				
D7HT1173BA	Ford	315-1502				
D7HT1175BA	Ford	320-2001				
D7HZ1175D	Ford		392-9131	309-0973	393-0173	393-0273
D7HZ1175E	Ford		392-9001			
D7HZ4255A	Ford	449-4974				
D7HZ4245A	Ford	449-4974				
D8HT1173AA	Ford	315-1501				
DG516P	Dual Dynamics	340-4013				
DG516PS	Dual Dynamics	343-4013				
DG6F	Dual Dynamics	340-4046				
DG6F4.5	Dual Dynamics	340-4024				
DG6FL	Dual Dynamics	340-4249				
DG6P	Dual Dynamics	340-4009				
DG6PS	Dual Dynamics	343-4009				
DGP	Dual Dynamics	340-4075				
DGPS	Dual Dynamics	343-4075				
E-540	Euclid	447-4743				
E-572	Euclid	447-4743				
E-576	Euclid	448-4836				
E-1087	Euclid	448-4836				
E-2296	Euclid	448-4836				
E-2299	Euclid	448-4836				
E-2303	Euclid	449-4973				
E-2305	Euclid	449-4973				
E-2420	Euclid	447-4743				
E-2422	Euclid	447-4743				
E-2460	Euclid	447-4743				
E-2466	Euclid	449-4973				
E-2468	Euclid	449-4973				
E-2550	Euclid	447-4723				
E-4861	Euclid	448-4837				
E-6140	Euclid	449-4973				
E0HZ1A131B	Ford	359-5915				
E1HT1175BA	Ford		392-9131	309-0973	393-0173	393-0273
E1HZ1175A	Ford		392-9131	309-0973	393-0173	393-0273
E1HZ1175B	Ford		392-9131	309-0973	393-0173	393-0273
E2HT1190AA	Ford		382-8036	308-0836	383-0136	383-0236
E2HT1190BA	Ford		382-8064	308-0864	383-0164	383-0264
E2HZ1175A	Ford		392-9131	309-0973	393-0173	393-0273
E2HZ1177A	Ford		392-9131	309-0973	393-0173	393-0273
E2HZ4478A	Ford	460-6004				
E3HS1131AA	Ford	343-4009				
E3HZ1190A	Ford		382-8027			
E3HZ1190B	Ford		382-8036	308-0836	383-0136	383-0236
E3HZ1190C	Ford		382-8064	308-0864	383-0164	383-0264
E3HZ4676A	Ford	460-6002				
E4HS-4255-AA	Ford	449-4973				
E4HT1175AA	Ford		392-9131	309-0973	393-0173	393-0273
E4HZ1131A	Ford	343-4186				
E4HZ1131B	Ford	343-4186				

Ⓢ Discontinued part numbers, refer to Engineering Changes for more information.

1 When using HM516449A, use 392-9130 set.

2 Use 0912 w/ 5.687 bore only; Use 0915 w/ 5.50 bore only.

3 Obsolete set, components still available.

4 Order kit # 383-8139 for Voyager® and 383-8239 for Discover®.

(Continued Next Page)

Cross Reference

Information contained in this section is furnished as a guide.
Verify specific application elsewhere in this catalog when possible.

Competitive Part No.	Competitor's Name	STEMCO Misc Products	STEMCO Std/ Grit Guard®	STEMCO Guardian®	STEMCO Voyager®	STEMCO Discover®
E4HZ1175B	Ford		392-9131	309-0973	393-0173	393-0273
E5HT1175CA	Ford		392-9099	309-0912, 0915 2		
E5HT1175GA	Ford		392-9131	309-0973	393-0173	393-0273
E5HT1190AA	Ford		382-8063	308-0863		
E5HZ1131A	Ford	343-4046				
E5HZ1131B	Ford	343-4095				
E5HZ1190A	Ford		382-8063	308-0863		
E5TZ1177B	Ford		392-9035	309-0935		
E6HT1175AA	Ford		392-9099	309-0912, 0915 2		
E6HZ1175C	Ford		392-9099	309-0912, 0915 2		
E6HZ1175E	Ford		392-9099	309-0912, 0915 2		
E6HZ1190A	Ford		382-8063	308-0863		
E6HZ1190D	Ford		382-8036	308-0836	383-0136	
E7HT1175AA	Ford		392-9035	309-0935		
E7HT1190AA	Ford		382-8036	308-0836	383-0136	383-0236
E7HZ1175A	Ford		392-9035	309-0935		
E7HZ1190A	Ford		382-8036	308-0836	383-0136	383-0236
E8HS1175BA	Ford		392-9131	309-0973	393-0173	393-0273
E8HS1175CA	Ford		392-9131	309-0973	393-0173	393-0273
E8HS1190CA	Ford		382-8036	308-0836	383-0136	383-0236
E8TW1177BA	Ford		392-9035	309-0935		
E8TZ1175A	Ford		382-8017			
E8TZ1177B	Ford		392-9035	309-0935		
FOHT1190AA	Ford		382-8036	308-0836	383-0136	383-0236
FOTZ1177A	Ford		392-9035	309-0935		
FOTZ1177AA	Ford		392-9035	309-0935		
F-940	Eaton	447-4743				
F-941	Eaton	447-4743				
F-1529	Eaton	447-4743				
F-1530	Eaton	447-4743				
F18571	Eaton		382-8064	308-0864	383-0164	383-0264
F18572	Eaton		382-8064	308-0864	383-0164	383-0264
F1HS1175AA	Ford		392-9099	309-0912, 0915 2		
F1HT1131AA	Ford	343-4065				
F1HZ1175A	Ford		392-9099	309-0912, 0915 2		
F1HZ1175C	Ford		392-9096	309-0965		
F1HZ1175D	Ford		392-9088	309-0964		
F2HS1131AA	Ford	343-4281				
F2HS1190AA	Ford		382-8064	308-0864	383-0164	383-0264
F2HS3276AA	Ford	448-4837				
F2HT1175AA	Ford		392-9099	309-0912, 0915 2		
F2HZ1175A	Ford		392-9035	309-0935		
F2HZ1175B	Ford		392-9099	309-0912, 0915 2		
F2HZ1175C	Ford		392-9131	309-0973	393-0173	393-0273
F2TZ1175A	Ford		382-8017			
F3HS1175AA	Ford		392-9099	309-0912, 0915 2		
F3HT1131BA	Ford	343-4124				
F3HT1153AA	Ford	330-3024				
F3HT1175AA	Ford		392-9035	309-0935		
F3HZ1131C	Ford	343-4024				
F3TW1177CA	Ford		392-9035	309-0935		
F4HS1175BA	Ford		392-9131	309-0973	393-0173	393-0273
F4TZ1177B	Ford		392-9035	309-0935		
F4TZ1177C	Ford		392-9035	309-0935		
H075	National	343-4075				
HI004320	Monon	347-4009				
HI004323	Monon	320-2110				

2 Discontinued part numbers, refer to Engineering Changes for more information.

1 When using HM516449A, use 392-9130 set.

2 Use 0912 w/ 5.687 bore only; Use 0915 w/ 5.50 bore only.

3 Obsolete set, components still available.

4 Order kit # 383-8139 for Voyager® and 383-8239 for Discover®.

(Continued Next Page)

Cross Reference

Information contained in this section is furnished as a guide.
Verify specific application elsewhere in this catalog when possible.

Competitive Part No.	Competitor's Name	STEMCO Misc Products	STEMCO Std/ Grit Guard®	STEMCO Guardian®	STEMCO Voyager®	STEMCO Discover®
H1004324	Monon	315-1504				
H1004325	Monon	343-4009				
H1004326	Monon	330-3009				
HI036513	Monon				373-0113	
HS1643	Mechanex/Barrier	343-4249				
HS34386	Mechanex/Barrier		392-9035	309-0935		
HS34972	Mechanex/Barrier		382-8063	308-0863		
HS34999	Mechanex/Barrier		392-9036			
HS35059	Mechanex/Barrier		382-8036	308-0836	383-0136	383-0236
HS36357	Mechanex/Barrier		382-8011			
HS36357	Mechanex/Barrier		382-8071			
HS38748	Mechanex/Barrier		392-9099	309-0912/0915 2		
HS38779	Mechanex/Barrier		392-9099	309-0912/0915 2		
HS40133	Mechanex/Barrier		372-7098	307-0713	373-0113	373-0213
HS40133	Mechanex/Barrier		392-9032			
HS42622	Mechanex/Barrier		372-7099	307-0723	373-0123	373-0223
HS42671	Mechanex/Barrier		392-9112	309-0904	393-0104	393-0204
HS43753	Mechanex/Barrier		372-7095	307-0744	373-0144	
HS43763	Mechanex/Barrier		382-8064	308-0864	383-0164	383-0264
HS43861	Mechanex/Barrier		392-9096	309-0965		
HS44919	Mechanex/Barrier		382-8053 3	308-0853	383-0153	
HS44963	Mechanex/Barrier		392-9033 3			
HS45097	Mechanex/Barrier		392-9094	309-0903	393-0103	393-0203
HS45102	Mechanex/Barrier		382-8056 3	308-0856	383-0156	
HS45158	Mechanex/Barrier		392-9088	309-0964		
HS453795	Mechanex/Barrier	330-3009				
HS455031	Mechanex/Barrier	310-1038 3				
HS455037	Mechanex/Barrier	310-1051				
HS456301	Mechanex/Barrier	310-1011 3				
HS46304	Mechanex/Barrier		372-7097	307-0743	373-0143	373-0243
HS47245	Mechanex/Barrier		392-9111			
HS47694	Mechanex/Barrier		392-9131	309-0973	393-0173	393-0173
HD47695	Mechanex/Barrier		392-9131	309-0973	393-0173	393-0173
HS48001	Mechanex/Barrier		392-9132	309-0960		
HU007A	National	340-4370				
HU008A	National	343-4006				
HU008A	National	343-4008				
HU009A	National	343-4009				
HU009A	National	343-4046				
HU009A	National	343-4098				
HU011A	National	343-4011				
HU012A	National	343-4012 3				
HU013A	National	343-4013				
HU014A	National	340-4014 3				
HU019A	National	343-4002				
HU019A	National	343-4019				
HU024A	National	343-4024				
HU028A	National	343-4028				
HU028A	National	343-4186				
HU031A	National	340-4031				
HU034A	National	343-4034				
HU036A	National	343-4025				
HU036A	National	343-4036				
HU036A	National	343-4092				
HU037A	National	343-4037				
HU039A	National	343-4198				
HU042A	National	343-4042				

3 Discontinued part numbers, refer to Engineering Changes for more information.

1 When using HM516449A, use 392-9130 set.

2 Use 0912 w/ 5.687 bore only; Use 0915 w/ 5.50 bore only.





3 Obsolete set, components still available.

4 Order kit # 383-8139 for Voyager® and 383-8239 for Discover®.

(Continued Next Page)

Cross Reference

Information contained in this section is furnished as a guide.
Verify specific application elsewhere in this catalog when possible.

Competitive Part No.	Competitor's Name	STEMCO Misc Products	STEMCO Std/ Grit Guard®	STEMCO Guardian®	STEMCO Voyager®	STEMCO Discover®
HU057A	National	343-4057				
HU065A	National	343-4065				
HU066A	National	343-4066				
HU070A	National	340-4070 				
HU110A	National	343-4095				
HU110A	National	343-4249				
HU149A	National	343-4049				
HU149A	National	343-4101 				
K1501	Ceromet	450-4836				
K1502	Ceromet	450-4837				
K2625	Ceromet	450-4743				
K3250	Ceromet	450-4973				
K3480	Ceromet	450-4723				
KBE-10227	Fruehauf	448-4836				
L-176	Leland	447-4743				
L-178	Leland	447-4743				
L-195	Leland	448-4836				
L-1331	Leland	448-4836				
L-1334	Leland	448-4836				
L-1347	Leland	447-4743				
L-1349	Leland	447-4743				
L-1353	Leland	449-4973				
L-1355	Leland	449-4973				
L-1359	Leland	447-4743				
L-1361	Leland	447-4743				
L-1365	Leland	449-4973				
L-1367	Leland	449-4973				
L-1395	Leland	447-4723				
M10312-001	Spicer-Dana	447-4743				
M10HG108	Spicer-Dana	330-3009				
M10HG109	Spicer-Dana	330-3084				
M10HG111	Spicer-Dana	330-3062				
M10HG113	Spicer-Dana	330-3017				
M10HG115	Spicer-Dana	330-3056				
M10HG119	Spicer-Dana	330-3102				
M10GH124	Spicer-Dana	330-3024				
M10HG127	Spicer-Dana	330-3079				
M10HH101	Spicer-Dana	320-2109				
M10HH102	Spicer-Dana	320-2110				
M10HH1031	Spicer-Dana	320-2046 				
M10HH107	Spicer-Dana		372-7097	307-0743	373-0143	373-0243
M10HH111	Spicer-Dana	320-2111				
M10HH119	Spicer-Dana	320-2041				
M10HH125	Spicer-Dana	320-2173				
M10HH128	Spicer-Dana	320-2018				
M10HH138	Spicer-Dana	320-2023				
M10HH140	Spicer-Dana	320-2051 				
M10HH153	Spicer-Dana		372-7097	307-0743	373-0143	373-0243
M10HH154	Spicer-Dana		382-8036	308-0836	383-0136	383-0236
M10HH157	Spicer-Dana		372-7099	307-0723	373-0123	373-0223
M10HK124	Spicer-Dana	340/343-4009				
M10HK127	Spicer-Dana	343-4082				
M10HK128	Spicer-Dana	340-4054				
M10HK143	Spicer-Dana	340-4157				
M10HK162	Spicer-Dana	343-4075				
M10HK170	Spicer-Dana	343-4024				
M10HK174	Spicer-Dana	343-4064				

 Discontinued part numbers, refer to Engineering Changes for more information.

 When using HM516449A, use 392-9130 set.

 Use 0912 w/ 5.687 bore only; Use 0915 w/ 5.50 bore only.

 Obsolete set, components still available.

 Order kit # 383-8139 for Voyager® and 383-8239 for Discover®.

(Continued Next Page)

Cross Reference

Information contained in this section is furnished as a guide.
Verify specific application elsewhere in this catalog when possible.

Competitive Part No.	Competitor's Name	STEMCO Misc Products	STEMCO Std/ Grit Guard®	STEMCO Guardian®	STEMCO Voyager®	STEMCO Discover®
M10HK182	Spicer-Dana	340/343-4009				
M10HK184	Spicer-Dana	343-4009				
M10HK185	Spicer-Dana	343-4249				
M10HN101	Spicer-Dana	447-4743				
M10HN102	Spicer-Dana	447-4743				
M10HN128	Spicer-Dana	448-4836				
M10HN158	Spicer-Dana	447-4743				
M10HS101	Spicer-Dana	315-1504				
M10HS102	Spicer-Dana	315-1507				
M10HS103	Spicer-Dana	310-1036				
M10HS104	Spicer-Dana	310-1013				
M10HS106	Spicer-Dana	315-1506				
M10HS109	Spicer-Dana	310-1043				
M10HS112	Spicer-Dana	315-1503				
M10HS118	Spicer-Dana	310-1008				
M10HS125	Spicer-Dana	310-1047 				
M-682	BWP	447-4743				
M-684	BWP	447-4743				
M-685	BWP	448-4836				
M-1524	BWP	448-4836				
M-1956	BWP	448-4836				
M-1959	BWP	448-4836				
M-1972	BWP	447-4743				
M-1974	BWP	447-4743				
M-1978	BWP	449-4973				
M-1980	BWP	449-4973				
M-1984	BWP	447-4743				
M-1986	BWP	447-4743				
M-1990	BWP	449-4973				
M-1992	BWP	449-4973				
M-1996	BWP	447-4723				
NP026773	TIMKEN	HM212011				
NP034946	TIMKEN	594A				
NP053874	TIMKEN	572				
NP174964	TIMKEN	HM518445				
NP363298	TIMKEN	592A				
NP435398	TIMKEN	3720				
NP503727	TIMKEN	HM218210				
NP593561	TIMKEN	HM518410				
NP840302	TIMKEN	580				
NP874005	TIMKEN	3782				
NP899357	TIMKEN	HM212049				
NP965350	TIMKEN	HM218248				
R20148201	Strick	340/343-4009				
R20148202	Strick	330-3009				
R20148216	Strick	320-2110				
R20148217	Strick	315-1504				
R20148218	Strick	343-4195				
R20148219	Strick	330-3118				
R20148220	Strick	347-4009				
R20148222	Strick		372-7097	307-0743	373-0143	373-0243
R20148223-4	Strick		372-7099	307-0723	373-0123	373-0223
R20148225	Strick	343-4075				
R20148227	Strick	340/343-4009				
R20148501	Strick	640-0001				
SS46842	Victor		372-7098	307-0713	373-0113	373-0213
SS46842-1	Victor		372-7098	307-0713	373-0113	373-0213

 Discontinued part numbers, refer to Engineering Changes for more information.

 When using HM516449A, use 392-9130 set.

 Use 0912 w/ 5.687 bore only; Use 0915 w/ 5.50 bore only.

 Obsolete set, components still available.

 Order kit # 383-8139 for Voyager® and 383-8239 for Discover®.

(Continued Next Page)

Cross Reference

Information contained in this section is furnished as a guide.
Verify specific application elsewhere in this catalog when possible.

Competitive Part No.	Competitor's Name	STEMCO Misc Products	STEMCO Std/ Grit Guard®	STEMCO Guardian®	STEMCO Voyager®	STEMCO Discover®
SS46847	Victor		372-7095	307-0744	373-0144	
SS47889	Victor		392-9096	309-0965		
SS48087	Victor		372-7099	307-0723	373-0123	373-0223
SS64227-2	Victor		372-7006			
SS64227-2	Victor		382-8025 ☒			
SS64229	Victor		382-8025 ☒			
SS64231	Victor		372-7008 ☒			
SS64234-1	Victor		382-8001			
SS64236	Victor		372-7097	307-0743	373-0143	373-0243
SS64238-2	Victor		392-9062			
SS64238-3	Victor		392-9062			
SS64240-1	Victor		372-7015			
SS64240-3	Victor		382-8045			
SS64410	Victor		372-7025 ☒			
SS64412	Victor		382-8025 ☒			
SS64412-1	Victor		382-8071 ☒		383-0171	
SS64414	Victor		382-8036	308-0836	383-0136	383-0236
SS64415	Victor		382-8053 ☒	308-0853	383-0153	
SS64415-1	Victor		382-8052			
SS64429	Victor		372-7006			
SS64443	Victor		392-9095	309-0961		
SS64452	Victor		392-9094	309-0903	393-0103	393-0203
SS64456	Victor		372-7006			
SS64456	Victor		382-8025 ☒			
SS64462	Victor		382-8052			
SS64464	Victor		382-8009			
SS64471	Victor		372-7049			
SS64487	Victor		382-8019			
SS64491	Victor		382-8011			
SS64495	Victor		392-9010 ☒			
SS64495-1	Victor		382-8039 ☒		383-0139	383-0239
SS64502	Victor		382-8017			
SS64511	Victor		382-8034			
SS64517	Victor		382-8064	308-0864	383-0164	383-0264
SS64530	Victor		382-8036	308-0836	383-0136	383-0236
SS64534	Victor		382-8044			
SS64538	Victor		382-8063	308-0863		
SS64539	Victor		382-8056 ☒	308-0856	383-0156	
SS64542	Victor		392-9094	309-0903	393-0103	393-0203
SS64546	Victor		392-9087	309-0970		
SS64553	Victor		392-9096	309-0965		
SS64558	Victor		392-9035	309-0935		
SS64558-1	Victor		392-9036			
SS64561	Victor		392-9038			
SS64564	Victor		392-9038			
SS64567	Victor		392-9112	309-0904	393-0104	
SS64569	Victor		392-9089	309-0948	393-0148	
SS64571	Victor		392-9007			
SS64584	Victor		392-9099	309-0915		
SS64589	Victor		392-9057	309-0957		
SS64603	Victor		392-9131	309-0973	393-0173	393-0273
SS68001	Victor		372-7098	307-0713	373-0113	373-0213
SS68002	Victor		372-7099	307-0723	373-0123	373-0223
SS68003	Victor		372-7097	307-0743	373-0143	373-0243
SS68004	Victor		392-9132	309-0960		
SS68005	Victor		372-7024 ☒	372-7091	373-0191	
SS68006	Victor		392-9131	309-0973	393-0173	393-0273

☒ Discontinued part numbers, refer to Engineering Changes for more information.

☒ When using HM516449A, use 392-9130 set.

☒ Use 0912 w/ 5.687 bore only; Use 0915 w/ 5.50 bore only.



☒ Obsolete set, components still available.

☒ Order kit # 383-8139 for Voyager® and 383-8239 for Discover®.

(Continued Next Page)

Cross Reference

Information contained in this section is furnished as a guide.
Verify specific application elsewhere in this catalog when possible.

Competitive Part No.	Competitor's Name	STEMCO Misc Products	STEMCO Std/ Grit Guard®	STEMCO Guardian®	STEMCO Voyager®	STEMCO Discover®
SS68008	Victor		372-7097	307-0743	373-0143	373-0243
T11501317	Dodge		392-9057	309-0957		
T13501317	Dodge		392-9099	309-0912/0915 		
TP-157	Transit	448-4836				
TP-431	Transit	448-4836				
TP-489	Transit	447-4743				
TP-490	Transit	447-4743				
TP-1572	Transit	449-4973				
TP-1943	Transit	449-4973				
TP-1970	Transit	448-4836				
TP-1973	Transit	448-4836				
TP-1977	Transit	449-4973				
TP-1978	Transit	449-4973				
TP-1988	Transit	447-4743				
TP-1989	Transit	447-4743				
TP-1997	Transit	447-4743				
TP-1999	Transit	447-4743				
UH0389EO UZ208EO	NOK	429-0005				
UZ0255EO	NOK	460-6012				
UZ0301EO	NOK		372-7098	307-0713	373-0113	373-0213
UZ0302EO	NOK		372-7099	307-0723	373-0123	373-0223
UZ0303EO	NOK		372-7097	307-0743	373-0143	373-0243
UZ0304EO	NOK		392-9131	309-0973	393-0173	393-0273
UZ0305EO	NOK		382-8036	308-0836	383-0136	383-0236
UZ0306EO	NOK		392-9099	309-0912	393-0112	393-0212
UZ0307EO	NOK		392-9088	309-0964		
UZ0308EO	NOK		392-9081	309-0960		
V10895522	GMC/Volvo			308-0870		
V8027329	GMC/Volvo	343-4095				
V8027330	GMC/Volvo		382-8064	308-0864	383-0164	383-0264
W03HH101	Dana		382-8064	308-0864	383-0164	383-0264
W03HH102	Dana		382-8036	308-0836	383-0136	383-0236
W03HK100	Dana	343-4249				
X-115	Eaton	448-4836				
Z1026AC	Eaton	310-1038 				
Z1026AD	Eaton	310-1041				
Z1026L	Eaton	310-1050				
Z1026R	Eaton	310-1011 				
Z1026T	Eaton		392-9112	309-0604	393-0104	393-0204
Z1026U	Eaton		392-9088	309-0964		

 Discontinued part numbers, refer to Engineering Changes for more information.

 When using HM516449A, use 392-9130 set.

 Use 0912 w/ 5.687 bore only; Use 0915 w/ 5.50 bore only.

 Discontinued set, components still available.

 Order kit # 383-8139 for Voyager® and 383-8239 for Discover®.

Wheel Bearing Adjustment

STEMCO Endorses TMC's Recommended

Wheel Bearing Adjustment Procedure For Standard Axle Fasteners

Proper wheel bearing adjustment is critical to the performance of wheel seals and other related wheel end products. For that reason, we are proud to be a part of TMC's Wheel End Task Force. We are happy to bring these standards to you in the form of this technical guide.

Working together, in this way, STEMCO helps keep your rigs rolling. The following seven step bearing adjustment recommendation was developed by TMC's Wheel End Task Force. It represents the combined input of manufacturers of wheel end components.

Wheel Bearing Adjustment

STEP 1 Bearing Lubrication:

Lubricate the wheel bearing with clean lubricant of the same type used in the axle sump or hub assembly.

STEP 2 Initial Adjusting:

Nut Torque: Tighten the adjusting nut to a torque of 200 ft-lbs. while rotating the wheel.

STEP 3 Initial Back-Off:

Back the adjusting nut off one full turn.

STEP 4 Re-Torque Adjustment:

Re-Torque adjusting nut to 50 ft-lbs while rotating the wheel.

STEP 5 Final Back-Off:

See Chart A above right.

STEP 6 Jam Nut Torque:

See Chart B below right.

STEP 7 Acceptable End Play:

Refer to Page 21 for measuring end play.

Chart A

Axle Type	Threads Per Inch	Final Back-Off
Steer <i>Single Nut</i>	12	¼ Turn *
	18	¼ Turn *
Steer <i>Double Nut</i>	14	½ Turn
	18	½ Turn
Drive	12	¼ Turn
	16	¼ Turn
Trailer	12	¼ Turn
	16	¼ Turn

*Install cotter pin to lock axle nut in position.

Chart B

Axle Type	Nut Size & Type	Torque Specifications
Steer <i>Double Nut</i>	Less Than 2-5/8"	200 - 300 ft-lbs
Drive	Dowel Type Washer	300 - 400 ft-lbs
	Tang Type Washer	200 - 275 ft-lbs
Trailer	2-5/8" And Larger	200 - 300 ft-lbs

Bearing Adjustment Procedure for Single Castellated Nut

STEP 1 Torque the Castellated Nut to 200 ft/lbs.

STEP 2 Back the nut off 1/2 to 1 full turn and rotate wheel assembly.

STEP 3 Re-torque Castellated Nut to 75 ft/lbs while wheel assembly is rotated.

STEP 4 Lock Castellated Nut in place with a new cotter pin through one of the two holes drilled in the axle. If at 75 ft-lbs you are not on a hole, back the nut off to the closest hole and lock in place with the cotter pin.

STEP 5 Due to Castellated Nut configuration, variation in bearing adjustment can be significant.

STEP 6 Always check end play after final adjustment and lock down.

*For Single Nut Systems see 571-2994.

PRO-TORQ® and Bearing Adjustment

PRO-TORQ® Installation Procedure for Hubs with Manually Adjusted Wheel Bearings

STEP 1 Remove The Keeper From The Nut:

Use a screwdriver to carefully pry the keeper arm from the undercut groove on each side until the keeper is released.



STEP 2 Seat the Bearing:

WITH HUB OR HUB/DRUM ONLY

Using a torque wrench:

1. (A) Tighten the nut to 200 ft-lbs.
Spin the wheel at least one full rotation.
- (B) Tighten the nut to 200 ft-lbs.
Spin the wheel at least one full rotation.
- (C) Tighten the nut to 200 ft-lbs.

WITH HUB/DRUM/WHEELS:

Using a torque wrench:

1. Tighten the nut to 200 ft-lbs while the wheel is rotating.
2. Back the nut off one full turn.



STEP 3 Adjust The Bearing:

WITH HUB OR HUB/DRUM ONLY

Using a torque wrench:

1. (A) Tighten the nut to 100 ft-lbs.
Spin the wheel at least one full rotation.
- (B) Tighten the nut to 100 ft-lbs.
Spin the wheel at least one full rotation.
- (C) Tighten the nut to 100 ft-lbs.
2. Back the nut off one raised face mark (according to chart).

WITH HUB/DRUM/WHEELS

Using a torque wrench:

1. Tighten the nut to 100 ft-lbs while the wheel is rotating.
2. Back the nut off one raised face mark (according to chart)



Final Backoff	
Part Numbers	Backoff
Trailer Axle Nut 447-4723, 447-4724, 449-4973	1/8 turn
Trailer Axle Nut 447-4743	1/4 turn
Steering Spindle Nut 448-4836, 448-4838, 448-4839, 448-4863, 448-4864, 448-4865	1/4 turn
Steering Spindle Nut 448-4837, 448-4840	1/3 turn
Drive Axle Nut 449-4904, 449-4973, 449-4974, 449-4975	1/8 turn

PRO-TORQ® and Bearing Adjustment

STEP 4 Install the Keeper:

ORANGE SIDE FACING OUT

1. Insert the keeper tab into the undercut groove of the nut and engage the keyway tang in the axle keyway. Insert keeper tab with the orange side facing out.
2. Engage the mating teeth.
3. Compress and insert the keeper arms, one at a time, into the undercut groove with a screwdriver.

FOR STEERING SPINDLE NUT

448-4836, 448-4839, 448-4840, 448-4863, 448-4864, and 448-4865

1. Align the flat of the keeper with the milled flat on the spindle and insert the single keeper tab into the undercut groove of the nut. Insert keeper tab with the orange side facing out.
2. Engage the mating teeth.
3. Compress and insert the keeper arms, one at a time, into the undercut groove with a screwdriver.

Recommended practice is to replace the keeper each time the PRO-TORQ nut assembly is removed for maintenance purposes.

STEP 5 Inspect the Installation:

Failure to follow this instruction could cause the wheel to come off and cause bodily injury. Make sure that the keeper tab and keeper arms are fully seated into the undercut groove. Inspect keyway tang to insure it does not contact the bottom of the keyway. If contact exists, immediately notify your PRO-TORQ® representative.

This procedure will consistently produce a bearing setting of .001" to .003" end play.

STEP 6 Acceptable End Play:

The dial indicator should be attached to the hub or brake drum with its magnetic base. Adjust the dial indicator so that its plunger is against the end of the spindle with its line of action approximately parallel to the axis of the spindle. Grasp the wheel or hub assembly at the 3 o'clock and 9 o'clock positions. Push and pull the wheel-end assembly in and out while oscillating the wheel approximately 45 degrees. Stop oscillating the hub so that the dial indicator tip is in the same position as it was before oscillation began. Read the bearing end-play as the total indicator movement.

*Acceptable end-play is .001"-.005". For single nut self-locking systems, consult manufacturers' specifications. STEMCO assumes no responsibility for bearing warranty.

PRO-TORQ®
ADVANCED AXLE FASTENER

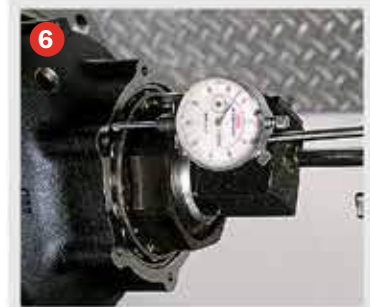

WARNING

Failure to follow this instruction could cause the wheel to come off and cause bodily injury. The PRO-TORQ Spindle Nut is sold as an assembly with the keeper in place. **DO NOT** attempt to place the nut on the spindle or tighten or loosen the nut on the spindle while the keeper is locked inside the nut. Doing so may deform the keeper and allow the nut to unthread during operation. **DO NOT** bend or manipulate keyway tang in any way. Doing so may cause the tang to break off in service. Failure to back off the nut will cause the bearings to run hot and be damaged.

IMPORTANT

PRO-TORQ Installation Procedure for PreSet® or LMS® Hubs:

PRO-TORQ spindle nuts may be used with PreSet or LMS hub assemblies. When used with these systems, it is important to follow the hub manufacturers' product specific installation instructions. For PreSet and LMS hub assemblies, torque the PRO-TORQ spindle nut to a minimum of 250 ft. lbs. Engage the keeper. If the keeper can not be engaged, advance the spindle nut until it can be engaged. **DO NOT BACK OFF THE SPINDLE NUT.**

ZIP-TORQ® and Bearing Adjustment

ZIP-TORQ® Axle Fastener Installation Procedure & Bearing Adjustment

IMPORTANT

ZIP-TORQ® Installation Procedure for PreSet® or LMS® Hubs:

ZIP-TORQ® axle fasteners may be used with PreSet® or LMS® hub assemblies. When used with these systems, it is important to follow the hub manufacturers' product specific installation instructions. For PreSet and LMS hub assemblies, torque the ZIP-TORQ axle fastener to a minimum of 250 ft. lbs. **DO NOT BACK OFF THE AXLE FASTENER.** This procedure will consistently produce a bearing setting of .001" to .005" end play.

Failure to follow this instruction could cause the wheel to come off and cause bodily injury. The ZIP-TORQ® axle fastener is sold as an assembly. For unitized hub or spacer system follow manufacturer recommended torque procedure.

STEP 1 *Seat the Bearing:*

WITH HUB OR HUB/DRUM ONLY

Using a torque wrench:

- A. (1)** Tighten the fastener to 200 ft-lbs.
Spin the wheel at least one full rotation.
- (2)** Tighten the fastener to 200 ft-lbs.
Spin the wheel at least one full rotation.
- (3)** Tighten the fastener to 200 ft-lbs.

B. Back the fastener off one full turn.

WITH HUB/DRUM/WHEELS:

Using a torque wrench:

- A.** Tighten the fastener to 200 ft-lbs while the wheel is rotating.
- B.** Back the fastener off one full turn.

Tools Required For Installation		
ZIP-TORQ® Part No.	Tool Socket (3/4" Drive Required)	OTC Part No.
Trailer Axle Fastener		
400-4723	4-1/8" Six Point	1915
400-4743	3-1/4" Six Point	1908
400-4973	4" Six Point	1914
Steering Axle Fastener		
400-4836	2-1/8" Six Point	1976
400-4837		
Drive Axle Fastener		
400-4973	4" Six Point	1914

NOTE: Ford application 12,000 lbs. SIFCO Steer Axle requires OEM inner washer to be installed prior to installation of ZIP-TORQ® fastener system.

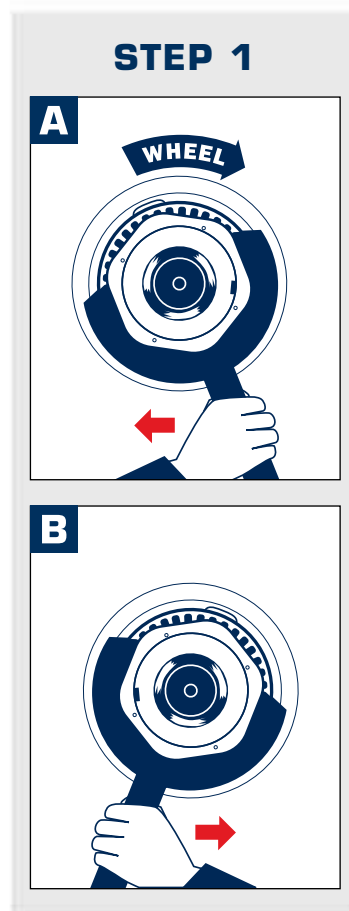

ZIP-TORQ® and Bearing Adjustment

STEP 2 Adjust The Bearing:

WITH HUB OR HUB/DRUM ONLY

Using a torque wrench:

- A. (1)** Tighten the fastener to 100 ft-lbs.
Spin the wheel at least one full rotation.
- (2)** Tighten the fastener to 100 ft-lbs.
Spin the wheel at least one full rotation.
- (3)** Tighten the fastener to 100 ft-lbs.
- B.** Back the fastener off one face mark (according to chart).

WITH HUB/DRUM/WHEELS

Using a torque wrench:

- A.** Tighten the fastener to 100 ft-lbs while the wheel is rotating.
- B.** Back the fastener off one face mark (according to chart).

WARNING Failure to follow this instruction could cause the wheel to come off and cause bodily injury. Failure to back off the fastener will cause the bearing to run hot and be damaged.

Final Backoff

ZIP-TORQ® Part Numbers	Backoff
Trailer Axle Fastener	
400-4723, 400-4973	1/8 turn
400-4743	1/4 turn
Steering Axle Fastener	
400-4836	1/4 turn
400-4837	1/3 turn
Drive Axle Fastener	
400-4973	1/8 turn

STEP 3 Inspect the Installation:

Failure to follow this instruction could cause the wheel to come off and cause bodily injury.

Inspect keyway tang to insure it does not contact the bottom of the keyway. If contact exists, immediately notify your ZIP-TORQ® representative.

STEP 4 Acceptable End-Play:

The dial indicator should be attached to the hub or brake drum with its magnetic base. Adjust the dial indicator so that its plunger is against the end of the spindle with its line of action approximately parallel to the axis of the spindle. Grasp the wheel or hub assembly at the 3 o'clock and 9 o'clock positions. Push and pull the wheel end assembly in and out while oscillating the wheel approximately 45 degrees. Stop oscillating the hub so that the dial indicator tip is in the same position as it was before oscillation began. Read the bearing end-play as the total indicator movement.

*Acceptable end-play is .001"-.005". For single nut self-locking systems, consult manufacturers' specifications. STEMCO assumes no responsibility for bearing warranty.

STEP 2

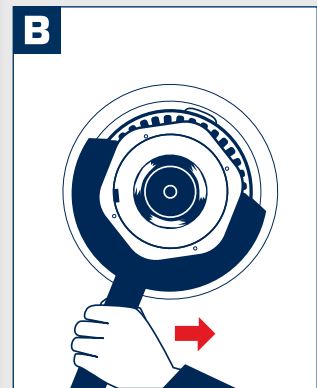
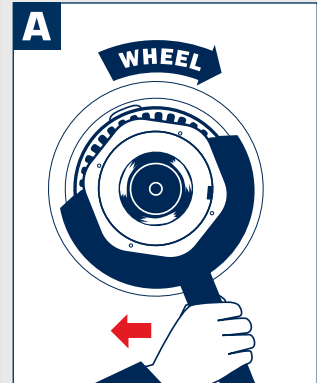

STEP 3

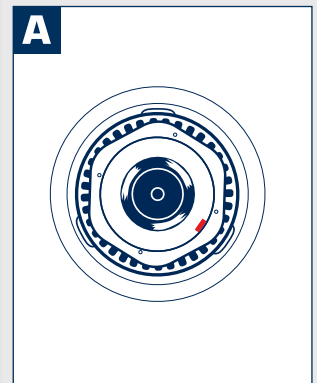

Guardian®/Guardian®HP Installation



STEP 1 Remove all burrs from the hub bore and spindle. Thoroughly clean the entire wheel cavity. Apply a thin layer of No. 2 sealant to the OD of the spindle shoulder. Place the seal assembly on the spindle so the words "Oil Bearing Side" are exposed to the oil. **[Photo 1]**
Warning: Do not install the seal into the hub bore.



STEP 2 Using the recommended STEMCO Universal Axle Tool, drive the seal assembly on until the tool bottoms against the shoulder. **[Photo 2]** Make sure the ring is flush with the axle shoulder. Ensure seal fully contacts the wear ring flange. Wipe away any excess sealant.



STEP 3 Dip the inner bearing in oil and place on the spindle, use same oil used in the wheel end. **NOTE: The OD of the seal must be coated with a thin coat of lubricant. NOTE: When using grease, pre-pack the inner bearing before placement into the hub.**

STEP 4 With the wheel mounted on a wheel dolly, carefully push the wheel onto the spindle until it contacts the seal. **[Photo 3]** Dip the outer bearing in oil and place it on the spindle. **NOTE: When using grease, pre-pack the outer bearing before placement into the hub. Tighten the inner spindle nut hand tight and remove the wheel dolly.**



STEP 5 Tighten the inner nut to 200 ft/lbs. **[Photo 4]** Rotate the wheel several times and then back-off nut one full turn. Make final bearing adjustment according to TMC recommended bearing adjustment procedure. Install the appropriate axle fastener.

STEP 6 Install the hub cap with a new gasket and fill the cavity with lubricant to the proper level. On drive axles, be sure the differential oil level is high enough (manufacturer's recommended level) to ensure oil flow through the tube to the wheels. It is recommended to jack-up one side and then the other until flow starts. Failure to tip drive axle can cause low lubricant level in the hub and lead to bearing failure. Make certain the breather plug is clear. Recheck steers and trailers to insure proper fill levels.

Standard/Grit Guard® Seal Installation

STEP 1 Remove all burrs and thoroughly clean the spindle. Apply a thin layer of No. 2 sealant to the OD of the spindle shoulder. Place the axle ring on the spindle.



STEP 2 Using the recommended STEMCO Universal Axle Tool, drive the axle ring on until the tool bottoms against the spindle shoulder. **[Photo 1]** Make certain the axle ring is flush with the shoulder. Wipe away any excess sealant.

STEP 3 Remove all burrs from the hub bore and thoroughly clean the entire wheel cavity.



STEP 4 With the wheel in horizontal position, pre-lube the inner bearing and place it into the bearing cup. **[Photo 2]** *Note: When using grease, pre-pack the inner bearing before placement into the hub.*

STEP 5 Apply a thin layer of No. 2 sealant to the OD of the seal and position the seal in the hub. Using the recommended STEMCO Universal Hub Tool held in a vertical position, drive the seal into the seal bore until it is bottomed-out. **[Photo 3]** Check the clearance between the bearing cone and seal (at least 1/32" is required).



STEP 6 With the wheel mounted on a dolly, carefully align the bore with the spindle. **[Photo 4]** Gently push the wheel assembly onto the spindle to the proper position. Pre-lube the outer bearing and push it into the bearing cup. *Note: When using grease, pre-pack the outer bearing before placement into the hub.*



STEP 7 Assemble the inner nut and tighten it to 200 ft/lbs. **[Photo 5]** Rotate the wheel several times and then back-off nut one full turn. Make final bearing adjustment according to TMC recommended bearing adjustment procedure. Install the appropriate axle fastener.

STEP 8 Install the hub cap with a new gasket and fill the cavity with lubricant to the proper level. On drive axles, be sure the differential oil level is high enough (manufacturer's recommended level) to ensure oil flow through the tube to the wheels. It is recommended to jack-up one side and then the other until flow starts. Make certain the breather plug is clear. Recheck steers and trailers to insure proper fill levels.



Voyager®/Discover® Hub-Seal Installation



STEP 1 Remove all burrs from the hub bore and spindle. Thoroughly clean hub cavity and spindle. **Note: Do not apply any sealant to the spindle shoulder. Apply a light coat of lubricant to spindle surfaces.**



STEP 2 With the wheel in horizontal position, pre-lube the inner bearing and place it into the bearing cup. **[Photo 1]**
Note: When using grease, pre-pack the inner bearing before placement into the hub.



STEP 3 Place the seal on the recommended STEMCO Installation Tool, with the correct head, so that the words "Air Side" face into the tool. Place the tool (with the seal correctly mounted in the tool head) over the hub bore. Use a heavy hammer to drive against the end of the tool. Drive seal into bore until complete bottoming is assured. **[Photo 2]** Remove Tool. Apply a thin layer of lubricant on the ID surface of the seal. **Note: Do not apply lubricant to the OD of the seal.**



STEP 4 With the wheel mounted on a dolly, carefully align the bore with the spindle. **[Photo 3]** Gently push the wheel assembly onto the spindle to the proper position. Be careful not to bump the top of the seal against the axle. Fill the hub cavity with lubricant until it runs over the outer bearing cup. Coat the outer bearing with lubricant and place it on the spindle and into the bearing cup. **Note: When using grease, pre-pack the outer bearing before placement into the hub. Note: Support the hub with the lifting device until the outer bearing and wheel-end fastener have been installed to a hand tight condition to prevent cocking of the hub/seal.**

STEP 5 Assemble the inner nut and tighten it to 200 ft./lbs. **[Photo 4]** Rotate the wheel several times and then back-off nut one full turn. Make final bearing adjustment according to TMC recommended bearing adjustment procedure. Install the appropriate axle fastener.

STEP 6 Install the hub cap with a new gasket and fill the cavity with lubricant to the proper level. On drive axles, be sure the differential oil level is high enough (manufacturer's recommended level) to ensure oil flow through the tube to the wheels. It is recommended to jack-up one side and then the other until flow starts. Make certain the breather plug is clear. Recheck steers and trailers to insure proper fill levels.

Unitized Pinion Seal Installation

STEP 1 Remove yoke.

STEP 2 Remove old seal and wear ring (if applicable).

STEP 3 Remove all burrs and thoroughly clean cage bore.

Note: If installing the seal into a worn cage bore, apply a thin layer of No. 2 sealant to the OD of the seal before installation.

STEP 4 Align installation tool with the seal and spline as shown. Hand tighten bolt/nut.

STEP 5 Tighten until the seal flange bottoms into the cage -or- installation tool bottoms into cage (non-flange seals).

Take care not to overtighten bolt/nut.

STEP 6 Remove burrs and thoroughly clean yoke. Lube the seal ID. Install yoke as shown.

STEP 7 Refer to axle manufacturer for yoke assembly torque requirements.



Bearing Removal and Installation

Bearing Removal

- STEP 1** Remove hub/wheel assembly from vehicle in accordance with recommended practices.
- STEP 2** Remove inboard and outboard bearing cones and set aside for inspection.
- STEP 3** Using a mild steel drift or cup driver, carefully drive out the bearing cups.
- *Caution should be used when driving bearing cups, as drifts and other tools can damage hub bearing bores. Be careful not to score bores while removing cups, especially when using aluminum hubs.*

Bearing Inspection

- STEP 1** Inspect the hub bearing bores and shoulders for damage. The bores should be smooth and free from scoring, burrs, indications of cup spinning, or other forms of damage. Remove any burrs or raised areas using emery cloth, a file, or other appropriate tool.
- STEP 2** Measure the bearing cup bore and compare to manufacturer specifications.
- STEP 3** Inspect bearing cups and cones for damage. Bearings should be free from chips, contamination, and signs of excessive wear or excessive heat. Refer to bearing damage analysis literature for identifying possible bearing issues.
- STEP 4** Inspect axle spindle bearing journals for any signs of damage or excessive wear. Remove any raised areas or burrs using emery cloth, a file, or other appropriate tool.
- STEP 5** Journals should be measured and compared with manufacturer specifications.

Bearing Installation

- STEP 1** Thoroughly clean bearing cups and cones prior to installation.
- *Do not use compressed air to spin bearing rollers as injury may result if cage does not retain the rollers.*
- STEP 2** Lightly coat the outside of bearing cups with oil.
- STEP 3** Using a cup driver, carefully drive bearing cups into hub bearing bores. Be sure to drive cup firmly against cup shoulder in hub.
- *If a cup driver is not available, a mild steel drift can be used to install bearing cups.*
 - *Caution should be used when driving bearing cups, as drifts and other tools can damage bearings.*
 - *NEVER use a bearing cone to drive a bearing cup. This can damage the bearings and cause premature failure.*
- STEP 4** Use a feeler gauge to check for gaps between cup and shoulder.
- STEP 5** Inspect bearing cups to ensure no damage occurred during installation.
- STEP 6** Lubricate bearing cones according to recommended practices and proceed with installation of wheel assembly.



DataTrac® Pro Installation

How It Works

DataTrac Pro is an advanced mileage counter that relies on Earth's gravity for counting wheel revolutions. The DataTrac® Pro unit monitors its orientation to Earth's gravitational pull and uses this reference to recognize and count revolutions.

Programming The Unit

Distribution or End User with a Programmer

The unit is shipped from the factory with a Revs/Mile value of zero. Dashes (- - -) on the display indicate that the unit has NOT been programmed. It MUST be programmed before it is installed on a wheel end (The DataTrac Pro distributor should have a programmer or can sell you a programmer).

The programmer can set the DataTrac PRO's:

- 1) Revolutions/Mile (or per Km) - Use Stemco's catalog to determine the Revolutions/Mile for each Tire Make/Model.
- 2) Distance Unit of Measure - Miles or Km (Life miles only or including Trip Miles)
- 3) Mileage Preset - Set the mileage to match the current mileage of the vehicle the unit will be mounted to.

When programming is complete, (as indicated on the programmer screen) immediately lift the DataTrac PRO up and confirm the display shows the correct Tire Revolutions (shown as "REV###" on the screen). If not, repeat the programming. The DataTrac Pro can be programmed/reprogrammed as many times as desired until there is approximately 2 miles on the unit.

Installing The Unit

Install the DataTrac PRO unit using the appropriate STEMCO bracket and hardware. The nut furnished with the unit is a locking nut and must not be torqued over 15-ft lbs.

Reading The Display

The display will turn on when the vehicle is at rest. Numbers will automatically orient to read upright. This is also indicated by the icon display, e.g. mile, km, acre. The mileage reading is always in the same direction as the icon.

In order to conserve power the display turns off at any time a vibration is detected. This means that the display will be off while the vehicle is moving. As soon as all vibration or motion stops the display will reactivate in about 5 seconds.

Display Modes

The DataTrac Pro unit comes equipped with three display modes: LIFE and TRIP (if programmed), and REV. To toggle the display between LIFE, TRIP and REV Modes, use the palm of your hand to cover the round bubble on the face of the unit for at least 1 second, and then uncover it. If the unit is in bright sunlight, the bubble may have to be covered with your palm to block more light from reaching the sensor. TRIP mode is displayed with tenths resolution and is indicated by display of the TRIP icon (only if unit is programmed for TRIP).

To reset the TRIP display, toggle between LIFE, TRIP and REV Modes 5 times, quickly. Note that the unit cannot toggle faster than every 1.5 seconds. To view the revolutions of the unit simply repeat the process that is used to view trip and then a screen that shows (REV XXX) will show up. The XXX is the number of revolutions per KM or MILE that the unit is programmed for. On units without TRIP there are only two screens, all others have three screens (LIFE, TRIP, and REV). As with the TRIP mode the unit will return to the mileage after 10 seconds if left in the revolutions screen.

DataTrac® PRO



Install DataTrac Pro on wheel end.



Display turns on when the vehicle is at rest.



Display turns off when vibration is detected (vehicle moving) to conserve energy.



LIFE mode shows mileage without tenths.



TRIP mode shows mileage with tenths and TRIP icon.



REV Mode shows RPM or RPK unit Programmed for.

STEMCO® Warranty

STEMCO® Standard Components 1-Year Warranty

STEMCO warrants to Buyer that all components sold will be free from defects in material and workmanship. This warranty is limited to components installed on vehicles licensed for on-highway use under normal use and service. This warranty extends for a period of one year from the date of manufacture.

The Buyer's exclusive remedy under this warranty shall be the repair or replacement of STEMCO components, but not the cost of removal or installation. STEMCO reserves the right to require that all warranty claim components are available and/or returned for review and evaluation. STEMCO shall not be liable for any claim, whether arising from breach of contract or warranty or claims of negligence or negligent manufacture, in excess of the purchase price. In no event shall STEMCO be liable for special, incidental, indirect, or consequential, or collateral, losses or damages of any kind.

This limited warranty is in lieu of all other warranties or conditions, expressed or implied, including any implied warranty of merchantability or fitness for particular purpose. This is the only warranty offered by STEMCO and no STEMCO employee or representative is authorized to extend additional warranty terms on behalf of STEMCO.

Platinum Performance System™ Warranty

<p>PLATINUM PERFORMANCE SYSTEM™</p> <p>Trailer: Unlimited Mileage</p> <p>Tractor: Unlimited Mileage</p> <p>3 Year Warranty</p>	<p>PLATINUM PLUS PERFORMANCE SYSTEM™</p> <p>Trailer: Unlimited Mileage</p> <p>5 Year Warranty</p>	<p>PLATINUM PLUS 7 PERFORMANCE SYSTEM™</p> <p>Trailer: Unlimited Mileage</p> <p>7 Year Warranty</p>
--	--	--

500,000 Mile Warranty

HUBODOMETER®
GUARANTEED OVER-LIFE-OF-TIRE ACCURACY

The STEMCO Hubodometer® is warranted for 500,000 miles when installed in accordance with its specifications.

4 Year/500,000 Mile Warranty

DataTrac® **DataTrac® PRO**

DataTrac® is warranted for 4 years / 500,000 miles when installed in accordance with its specifications.

TQMSM Training



WHEN IT COMES TO TRAINING WE HOLD OURSELVES TO A HIGHER STANDARD

STEMCO WHEEL END PRODUCTS™

- Wheel end failure analysis and rebuild
- Proper seal and bearing installation
- Single and double nut adjustment procedures
- Oil and grease lubrication best practices

STEMCO BRAKE PRODUCTS™

- Foundation basics
- Brake balance
- Auto Brake Adjusters

STEMCO SUSPENSION PRODUCTS™

- King pin replacement for Qwik Kits and Plus Kits
- Complete break down and rebuild training

STEMCO INNOVATIVE TIRE & MILEAGE SOLUTIONS | ITMS™

- Tire inflation management
- Mileage management
- Tire pressure monitoring
- Trailer aerodynamics

To request training on any or all of these products,
contact your local STEMCO District Sales Manager.

Proud Member of

