

PARTS LIST:

1	Driver/Left Sidebar	4	10mm x 35mm Bolt Plates
1	Passenger/Right Sidebar	4	12-1.75mm x 120mm Gr.10.9 Hex Bolts
1	Driver/Left Front Mounting Bracket	4	12mm x 32mm OD x 3mm Flat Washers
1	Passenger/Right Front Mounting Bracket	4	12mm Lock Washers
1	Driver/Left Rear Mounting Bracket	4	10-1.5mm x 30mm Hex Bolts
1	Passenger/Right Rear Mounting Bracket	12	10mm x 30mm OD x 2.5mm Flat Washers
1	Driver/Left Front Support Bracket	8	10mm Lock Washers
1	Passenger/Right Front Support Bracket	8	10mm Hex Nuts
1	Driver/Left Rear Support Bracket	8	8-1.25mm x 25mm Hex Bolts
1	Passenger/Right Rear Support Bracket	8	8mm Lock Washers
4	12mm x 48mmOD x 5mm Spacers	8	8mm x 24mm OD x 2mm Flat Washers
4	10mm Plastic Retainers		

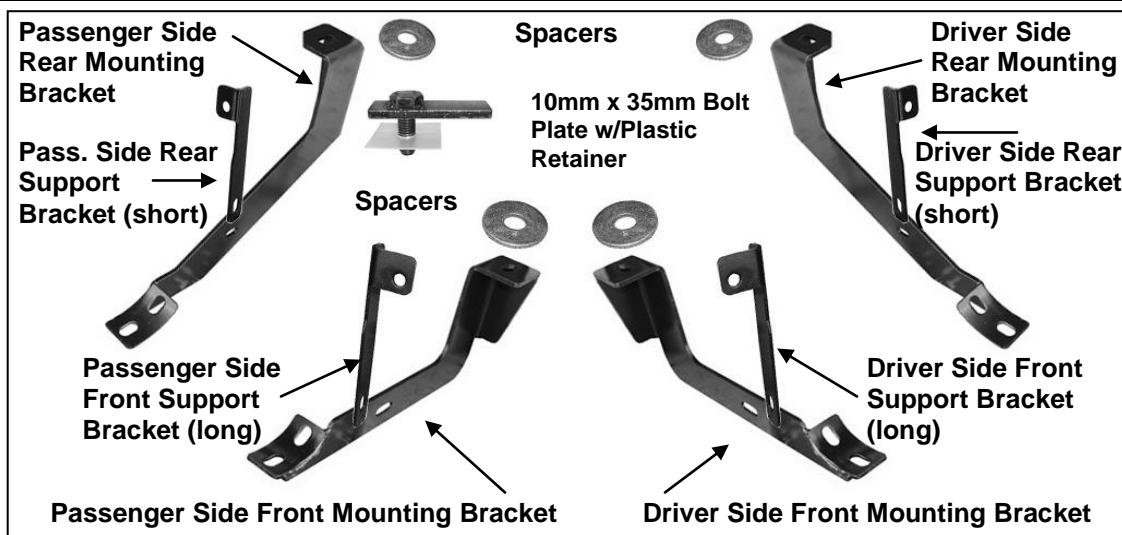

PROCEDURE:

- 1. REMOVE CONTENTS FROM BOX. VERIFY ALL PARTS ARE PRESENT. READ INSTRUCTIONS CAREFULLY BEFORE STARTING INSTALLATION.**
- Starting toward the front of the driver side, remove the factory front body mount bolt with attached washer. Remove but do not discard the factory rubber bushing from the factory bolt.
- Select the driver side front Mounting Bracket. Insert (1) 12-1.75mm x 120mm Hex Bolt with (1) 12mm ID x 32mm OD x 3mm Flat Washer and (1) 12mm Lock Washer through the Mounting Bracket. Place (1) Spacer Plate onto the 12mm Hex Bolt then slide the rubber bushing onto the Hex Bolt. Make sure that the Spacer Plate is between the Mounting Bracket and the factory rubber bushing, **(Figure 3)**. Hold the front Mounting Bracket, (with hardware, factory washer and rubber bushing), up in position and hang it from the body mount by threading the hex bolt into the body mount. Snug but do not tighten hardware at this time. **IMPORTANT:** On 05 and newer model years, the large washer on the factory body mount bolt is removable, (do not discard-must reinstall), and the bolt is long enough to go through the Mounting Bracket and properly thread into the body mount. It is the installer's responsibility to check length and to determine whether to use the factory or replacement hex bolt.
- Repeat Steps 2-3 for rear Mounting Bracket installation.
- Remove the tape covering the factory hole in the back side of the rocker panel near the Mounting Bracket. Thread (1) Plastic Retainer part way onto (1) 10mm x 35mm Bolt Plate. Insert the Bolt Plate into the factory hole on the rocker panel, **(Figure 1)**. Hold the Bolt Plate in

place with one hand and continue to thread the Plastic Retainer down against the sheetmetal until it holds the Bolt Plate in place, **(Figure 2)**. **IMPORTANT:** The Plastic Retainer is designed to prevent the Bolt Plate from falling into the body cavity and to aid in installing the Bracket.

6. Locate the driver side front Support Bracket (long) and attach it to the Bolt Plate with (1) 10mm Lock Washer, (1) 10mm Flat Washer and (1) 10mm Hex Nut, **(Figure 3)**. **NOTE:** Place Support Bracket against the front facing side of the Mounting Bracket with the bent tab facing towards the **front** of the vehicle. Snug but do not tighten hardware at this time.
7. Attach the lower end of the front Support Bracket to the Mounting Bracket using (1) 10mm x 30mm Hex Head Bolt, (1) 10mm Lock Washer, (2) 10mm Flat Washers and (1) 10mm Hex Nut, **(Figure 3)**. Do not tighten hardware at this time.
8. Next, move to the rear Mounting Bracket location. Remove the tape covering the hole in the inner rocker panel and install (1) Bolt Plate as described in **Step 5**. Locate the driver side rear Support Bracket (short) and attach it to the Bolt Plate with (1) 10mm Lock Washer, (1) 10mm Flat Washer and (1) 10mm Hex Nut, **(Figure 4)**. **NOTE:** Place Support Bracket against the front facing side of the Mounting Bracket with the bent tab facing towards the **rear** of the vehicle. Repeat **Step 7** to attach the lower end of the Support Bracket to the Mounting Bracket, **(Figure 4)**. Snug but do not tighten hardware at this time
9. With assistance, carefully position the driver Sidebar onto the Mounting Brackets. Partially attach the Sidebar to the front and rear Mounting Brackets with the included (4) 8mm x 25mm Hex Head Bolts, (4) 8mm Lock Washers, and (4) 8mm Flat Washers, **(Figure 5)**. Do not tighten hardware at this time.
10. Properly level and adjust the Sidebar and tighten all hardware at this time.
11. Repeat steps 2-10 for the passenger/right sidebar installation.
12. Do periodic inspections to the installation to make sure that all hardware is secure and tight.

To protect your investment, wax this product after installing. Regular waxing is recommended to add a protective layer over the finish. Do not use any type of polish or wax that may contain abrasives that could damage the finish.

For stainless steel: Aluminum polish may be used to polish small scratches and scuffs on the finish. Mild soap may be used also to clean the Sidebar.

For gloss black finishes: Mild soap may be used to clean the Sidebar.

Driver Side Installation Pictured

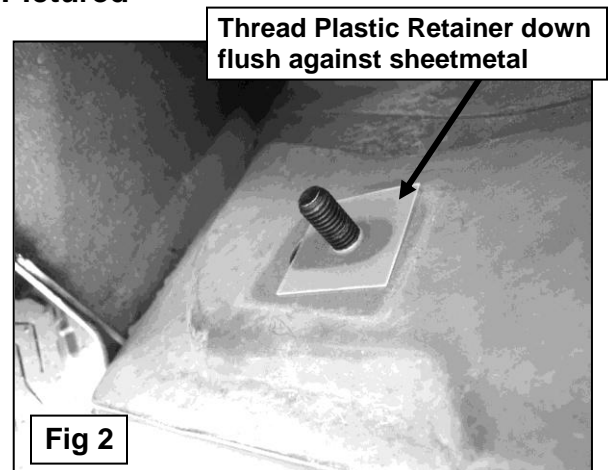
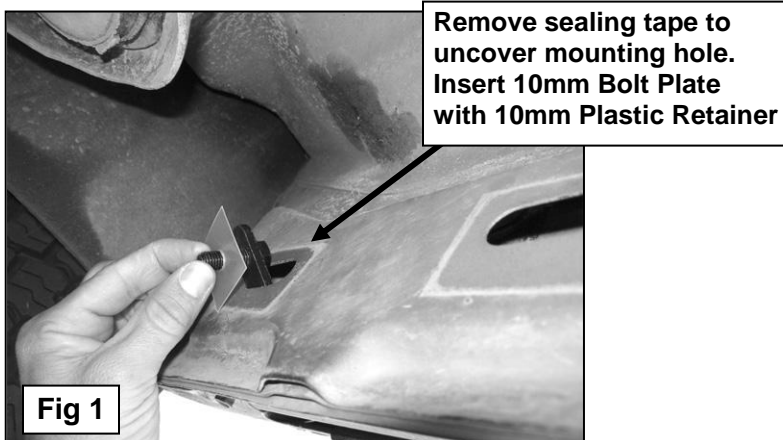

Driver Side Installation Pictured

IMPORTANT: Insert (1) Steel Spacer between each front and rear Mounting Bracket and factory rubber bushing (driver side front Mounting Bracket pictured)

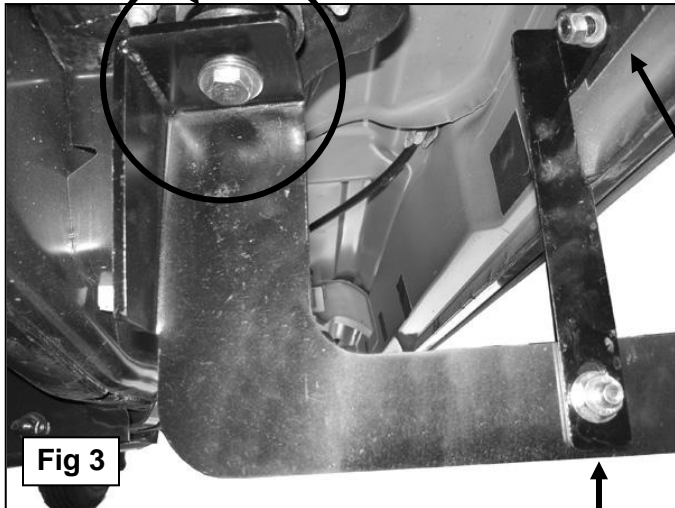
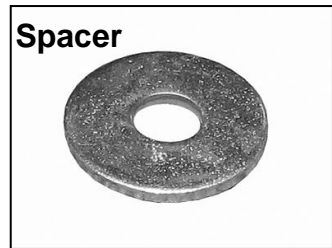

10mm x 35mm Bolt Plate
10mm Flat Washer
10mm Lock Washer
10mm Hex Nut

IMPORTANT: Insert (1) Steel Spacer between each front and rear Mounting Bracket and factory rubber bushing (driver side rear Mounting Bracket pictured)

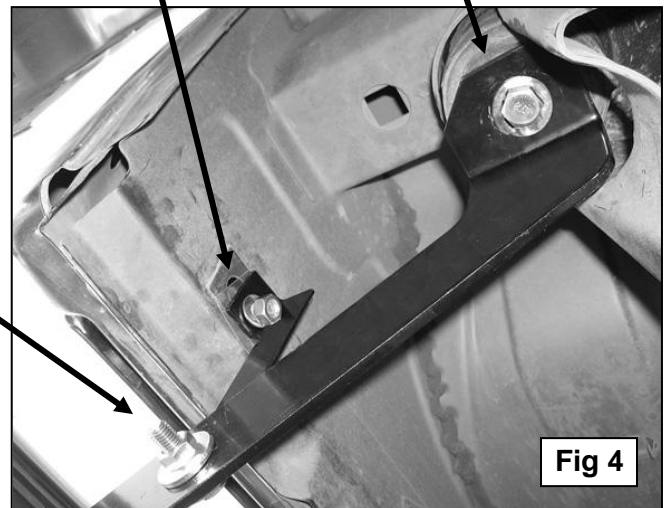

10mm x 30mm Hex Bolt
10mm Flat Washer
10mm Lock Washer
10mm Hex Nut

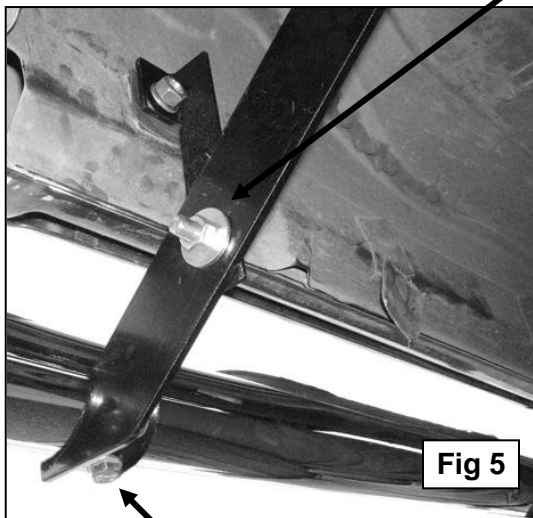

8mm x 25mm Hex Bolt
8mm Flat Washer
8mm Lock Washer

