



INSTALLATION INSTRUCTIONS

PINNACLE 4" BENT END SIDE STEPS

02-08 DODGE RAM 1500 QUAD CAB

03-09 RAM 2500-3500 QUAD CAB

PARTS LIST:

1	Driver/Left Sidebar	4	14mm Spacer
1	Passenger/Right Sidebar	4	10mm Plastic Retainers
1	Driver/Left Front Mounting Bracket	4	10mm x 35mm Bolt Plates
1	Driver/Left Front Support Bracket	4	12-1.75mm x 120mm Gr.10.9 Hex Bolts
1	Passenger/Right Front Mounting Bracket	4	12mm x 32mm OD x 3mm Flat Washers
1	Passenger/Right Front Support Bracket	4	12mm Lock Washers
1	Driver/Left Rear Mounting Bracket	4	10-1.5mm x 30mm Hex Bolts
1	Driver/Left Rear Support Bracket	12	10mm x 30mm OD x 2.5mm Flat Washers
1	Passenger/Right Rear Mounting Bracket	8	10mm Nylon Lock Nuts
1	Passenger/Right Rear Support Bracket	8	8-1.25mm x 25mm Combo Hex Bolts

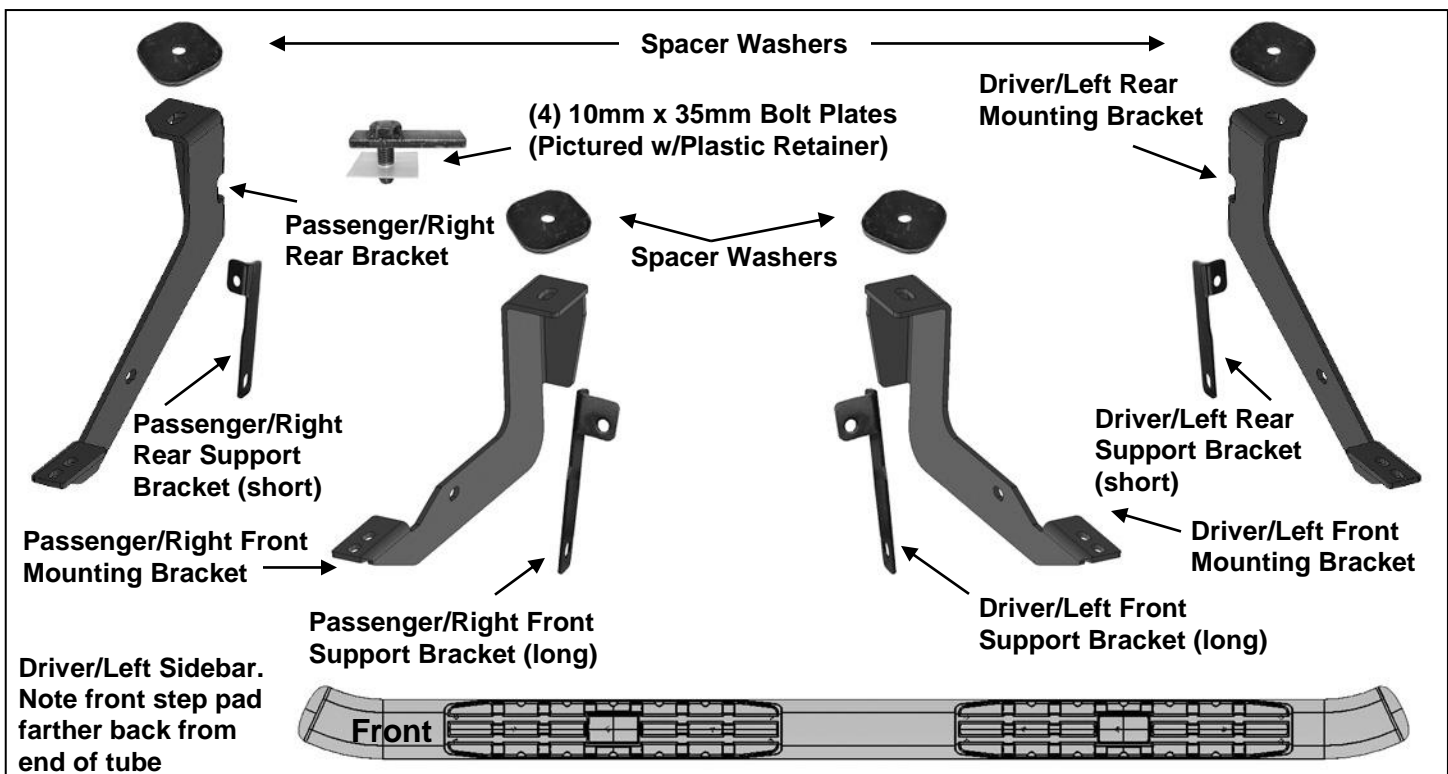

PROCEDURE:

- 1. REMOVE CONTENTS FROM BOX. VERIFY ALL PARTS ARE PRESENT. READ INSTRUCTIONS CAREFULLY BEFORE STARTING INSTALLATION. ASSISTANCE IS RECOMMENDED.**
- Starting toward the front of the passenger side, remove the factory front body mount bolt with washer, **(Figure 1)**. Remove but do not discard the rubber bushing from the factory bolt.
- Select the passenger side front Mounting Bracket. Insert (1) 12mm x 120mm Hex Bolt with (1) 12mm Flat Washer and (1) 12mm Lock Washer through the Mounting Bracket. Place (1) Large Spacer Washer, **(Figure 2A)**, onto the Bolt then slide the rubber bushing onto the Hex Bolt against the Washer. Make sure that the Spacer Washer is between the Bracket and the factory rubber bushing, **(Figure 2B)**.
- Hold the Bracket and hardware up in place and attach to the factory body mount, **(Figure 3)**. Snug but do not tighten hardware at this time. **IMPORTANT:** On 2005 and newer model years, the large washer on the factory body mount bolt may be removable, (do not discard-must reinstall), and the bolt is long enough to go through the Mounting Bracket and properly thread

into the body mount. It is the installer's responsibility to check length and to determine whether to reuse the factory body bolt or the included replacement 12mm x 120mm Hex Bolt.

5. Remove the tape covering the factory hole in the back side of the lower body panel near the Mounting Bracket, **(Figures 1 & 3)**. Thread (1) Plastic Retainer part way onto (1) 10mm x 35mm Bolt Plate, **(Figure 4)**. Insert the Bolt Plate into the factory hole on the body panel, **(Figure 5A)**. Hold the Bolt Plate in place with one hand and continue to thread the Plastic Retainer down against the sheet metal to hold the Bolt Plate in place, **(Figure 5B)**. **IMPORTANT:** The Plastic Retainer is designed to prevent the Bolt Plate from falling into the body panel and to aid in Bracket installation.
6. Select the passenger side front Support Bracket (long), **(Figure 6)**. Attach the Bracket to the Bolt Plate with (1) 10mm Flat Washer, (1) 10mm Lock Washer and (1) 10mm Hex Nut, **(Figure 7)**. **NOTE:** Place the lower flat end of the Support Bracket against the front facing side of the Mounting Bracket. The bent tab on the top of the Support Bracket should face the **front** of the vehicle. Do not tighten hardware at this time.
7. Attach the flat lower end of the front Support Bracket to the front of the Mounting Bracket with (1) 10mm x 30mm Hex Bolt, (2) 10mm Flat Washers, (1) 10mm Lock Washer and (1) 10mm Hex Nut, **(Figure 7)**. Do not tighten hardware at this time.
8. Move to the rear body mount at the back of the cab. Select the passenger side rear Mounting Bracket and (1) Spacer Washer. Repeat **Steps 2—4** for rear Mounting Bracket installation, **(Figure 8)**.
9. Remove the tape covering the hole in the inner rocker panel and install (1) Bolt Plate as described in **Step 5**. Select the passenger side rear Support Bracket, (short), **(Figure 6)**. Attach the bent end of the top of the Bracket to the Bolt Plate with (1) 10mm Flat Washer, (1) 10mm Lock Washer and (1) 10mm Hex Nut, **(Figure 9)**. **NOTE:** Place Support Bracket against the front facing side of the Mounting Bracket. The bent tab on the top of the rear Support Bracket should face the **rear** of the vehicle.
10. Repeat **Step 7** to attach the flat lower end of the Support Bracket to the front of the rear Mounting Bracket, **(Figure 10)**. Snug but do not tighten hardware at this time
11. With assistance, carefully position the passenger Sidebar onto the Mounting Brackets. Partially attach the Sidebar to the front and rear Mounting Brackets with the included (4) 8mm x 25mm Combo Hex Bolts, **(Figure 11)**. Do not tighten hardware at this time.
12. Properly level and adjust the Sidebar and tighten all hardware at this time.
13. Repeat **Steps 2—12** for the driver/left Sidebar installation.
14. Do periodic inspections to the installation to make sure that all hardware is secure and tight.

To protect your investment, wax this product after installing. Regular waxing is recommended to add a protective layer over the finish. Do not use any type of polish or wax that may contain abrasives that could damage the finish.

For stainless steel: Aluminum polish may be used to polish small scratches and scuffs on the finish. Mild soap may be used also to clean the Sidebar.

For gloss black finishes: Mild soap may be used to clean the Sidebar.

Passenger Side Installation Pictured

Remove body mount
bolt and washer

Remove sealing tape to
uncover mounting hole

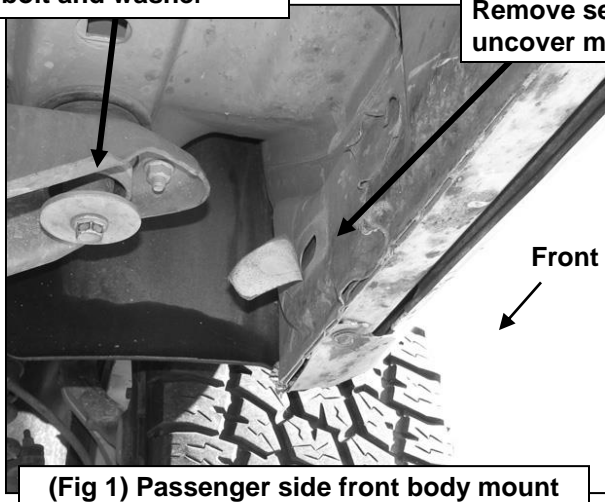

IMPORTANT: Insert (1) Spacer Washer
between each front and rear Mounting Bracket
and factory rubber bushing (passenger side
front Mounting Bracket pictured)

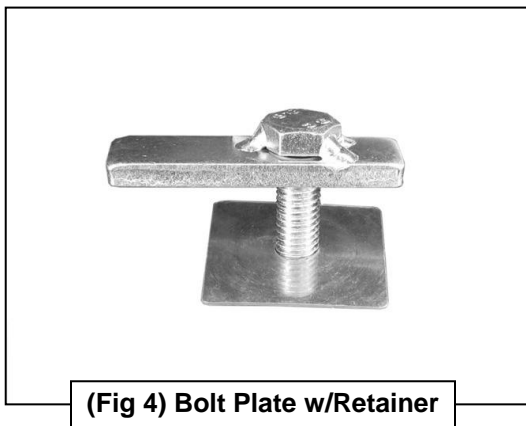
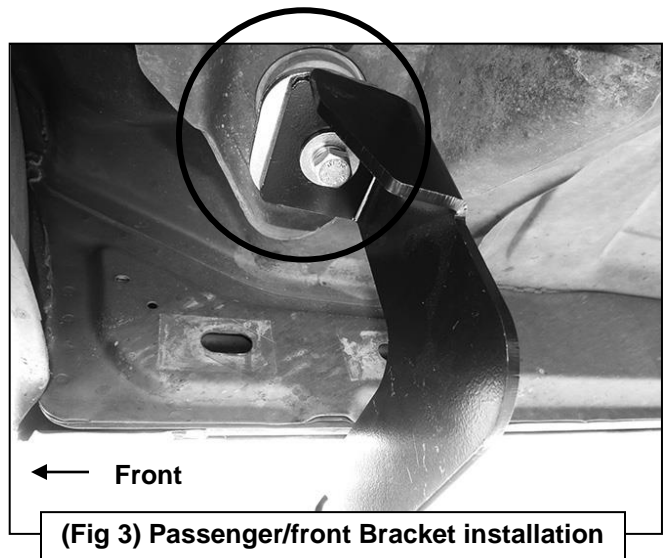

Passenger Side Installation Pictured

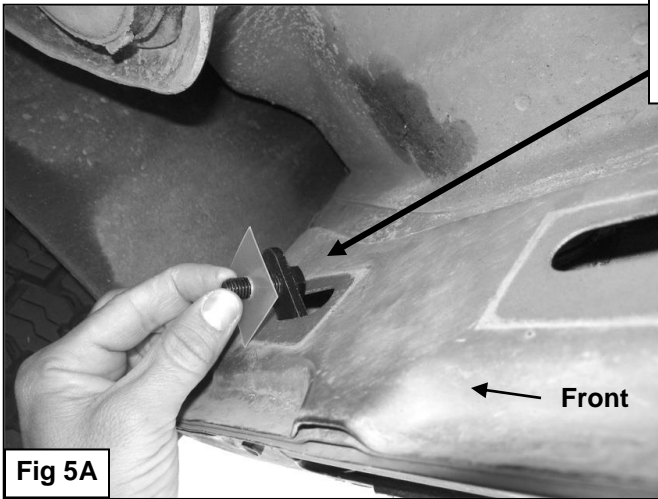

Fig 5A



Fig 5B

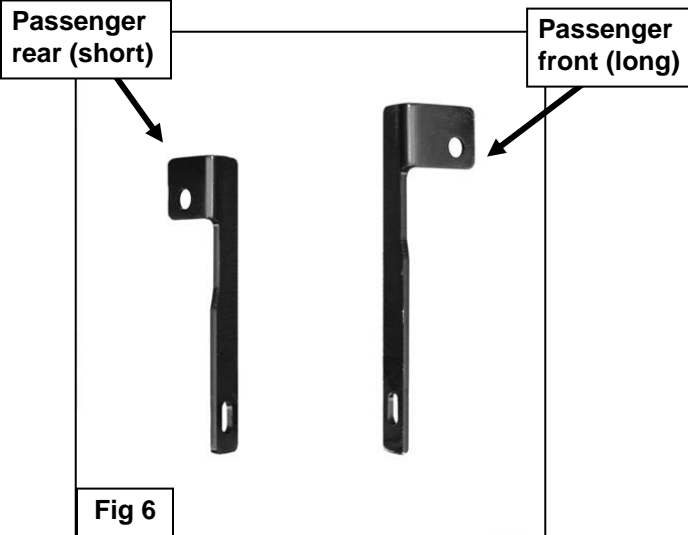

Fig 6

10mm Flat Washer
10mm Lock Washer
10mm Hex Nut

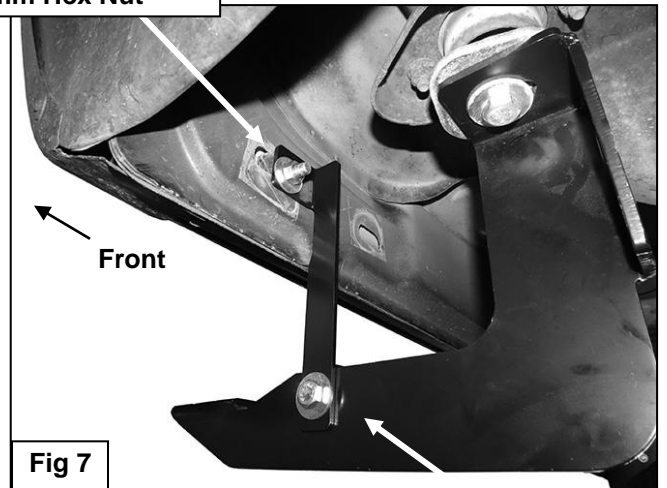
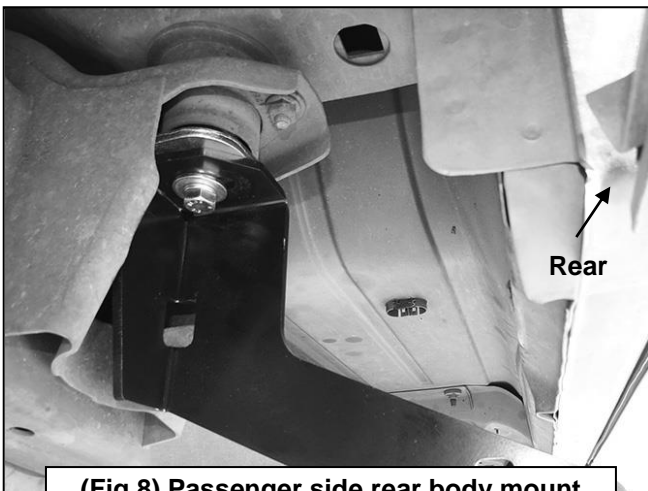

Fig 7

10mm x 30mm Hex Bolt
(2) 10mm Flat Washers
10mm Lock Washer
10mm Hex Nut



(Fig 8) Passenger side rear body mount

Passenger Side Installation Pictured

10mm Flat Washer
10mm Lock Washer
10mm Hex Nut

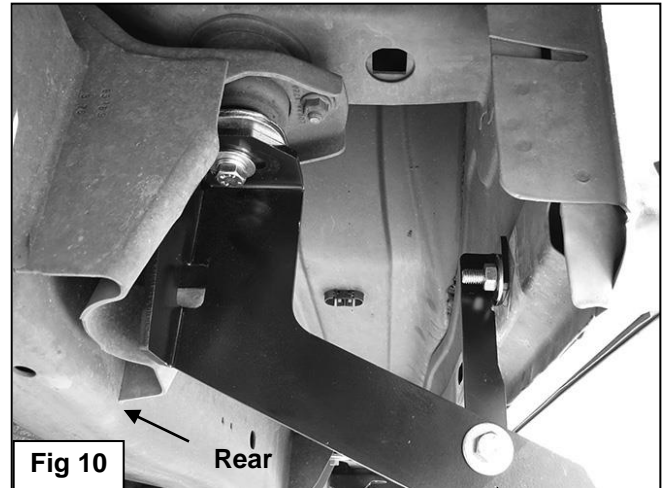
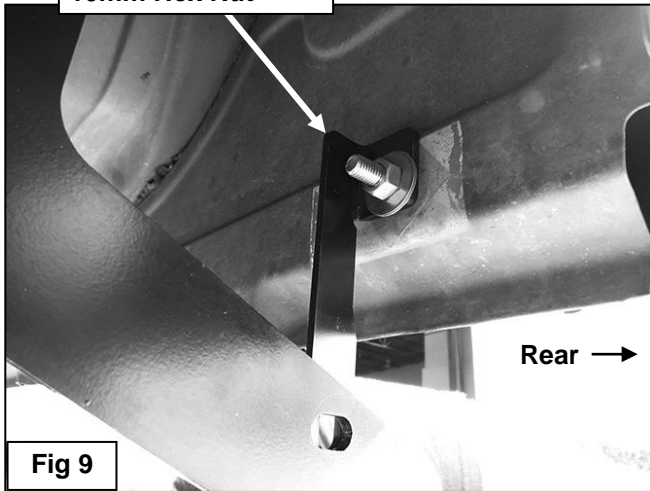

10mm x 30mm Hex Bolt
(2) 10mm Flat Washers
10mm Lock Washer
10mm Hex Nut

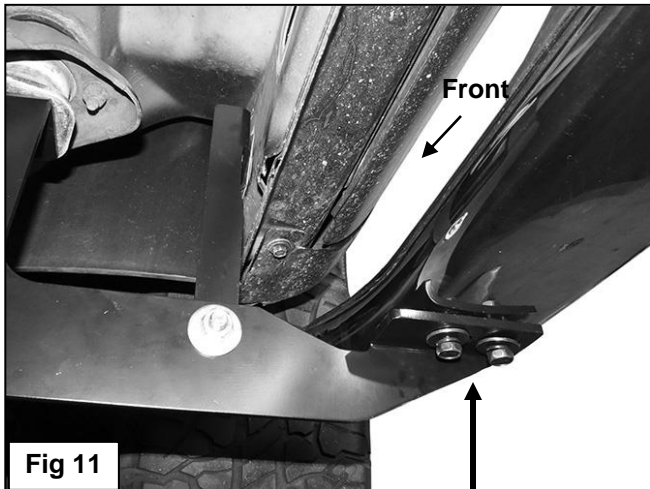

Attach Sidebar to each Bracket with:
(2) 8mm x 25mm Combo Hex Bolts



Complete Installation