

# INSTALLATION INSTRUCTIONS

## SIDEBAR

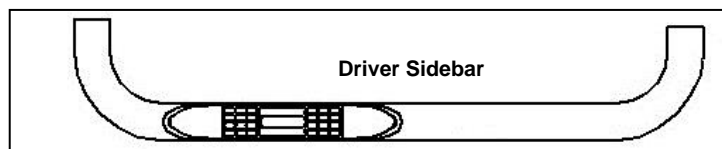
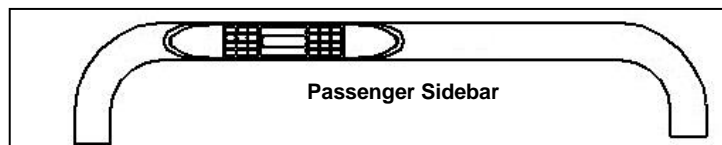
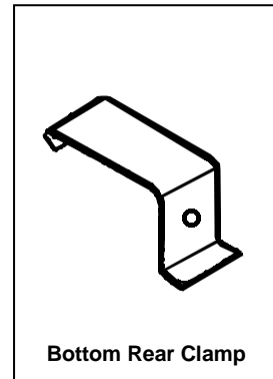
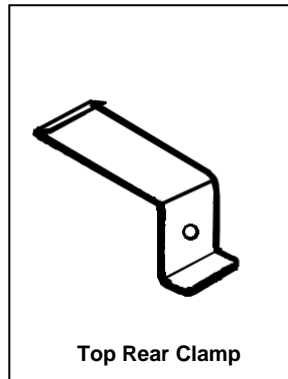
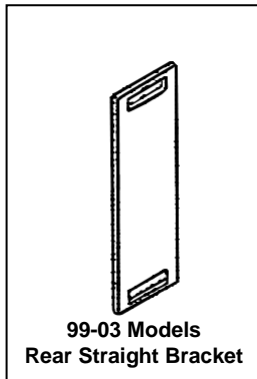
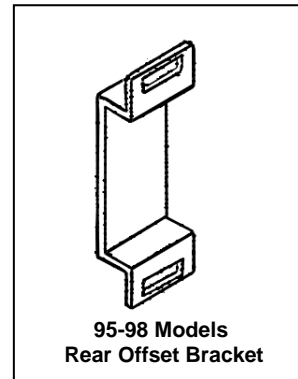
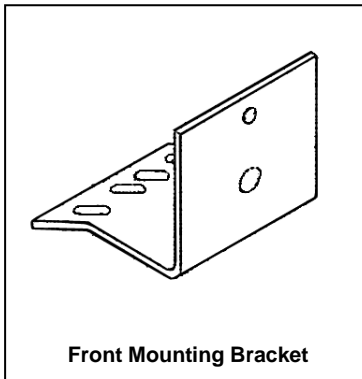
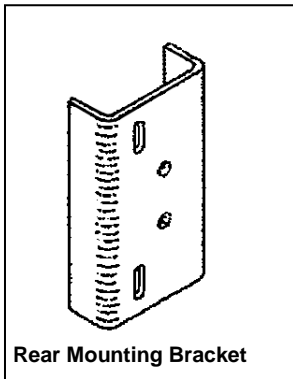
95-04 TOYOTA TACOMA REG/EXT CAB 4WD or PRERUNNER

(excl 2WD)

PART NUMBER

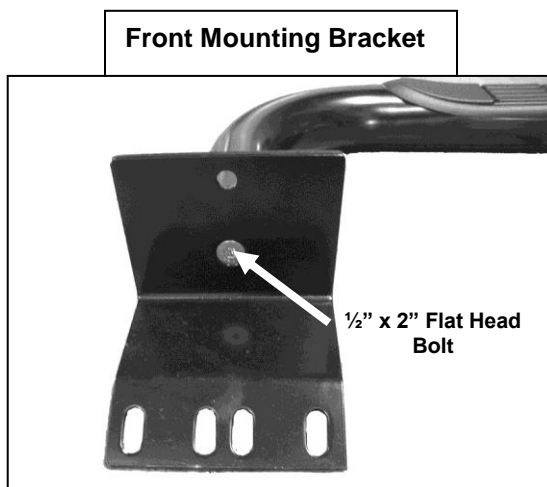
### PARTS LIST:

1	Driver/Left Sidebar	2	1/2" x 2" Flat Head Bolts (front mount)
1	Passenger/Right Sidebar	2	1/2" x 2" Hex Head Bolts (rear mount)
2	Rear Mounting Brackets	2	12-1.75mm x 40mm Hex Head Bolts
2	Front Mounting Brackets	4	1/2" ID x 1 3/8" OD x 3/32" Flat Washers
1	Rear Offset Brackets	4	12mm ID x 29mm OD x 3mm Flat Washers
2	Straight Brackets	2	1/2" Lock Washers
2	Top Rear Clamp	4	12mm Lock Washers
2	Bottom Rear Clamp	4	12mm Hex Nuts
2	Plastic Retainers	4	10-1.50mm x 45mm Hex Head Bolts
2	12-1.75mm Bolt Plates	4	10mm Lock Washers
		4	10mm ID x 26mm OD x 3mm Flat Washers

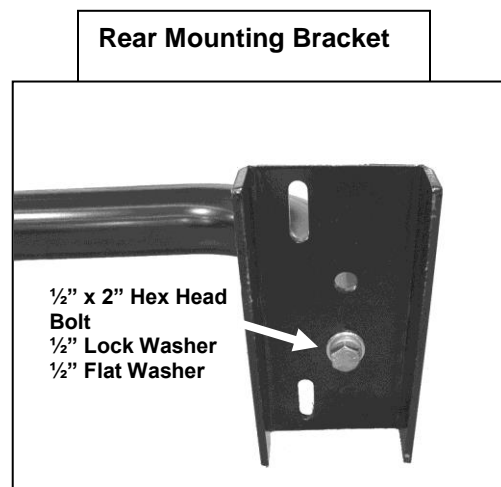


## PROCEDURE:

1. REMOVE CONTENTS FROM BOX. VERIFY ALL PARTS ARE PRESENT. READ INSTRUCTIONS CAREFULLY BEFORE STARTING INSTALLATION.
2. Locate passenger Sidebar and place on a clean working area. Attach front Mounting Bracket to Sidebar using the included (1)  $\frac{1}{2}$ " x 2" Flat Head Bolts (**Figure 1**). **NOTE:** Use the counter sunk hole on the front Mounting Bracket.
3. Attach rear Mounting Bracket to Sidebar using the included (1)  $\frac{1}{2}$ " x 2" Hex Head Bolt, (1)  $\frac{1}{2}$ " Lock Washer, and (1)  $\frac{1}{2}$ " Flat Washers (**Figure 2**). **NOTE:** Make sure the rear Mounting Bracket is positioned so the slots are towards the middle of the bar (front of vehicle) and with 90° bends away from the bar (towards the frame). Use the bottom round hole to attach it to Sidebar.
4. From underside of vehicle, locate the factory rectangular hole in the frame towards the front of the vehicle and insert (1) 12mm Bolt Plate (**Figure 3**).
5. To secure the Bolt Plate in place, put a Plastic Retainer on Bolt and thread tight against the frame (**Figure 4**).
6. With help, position the Sidebar up to vehicle frame and place top hole of front Mounting Bracket over previously installed Bolt Plate. Secure Mounting Bracket to Bolt Plate using the included (1) 12mm Hex Nut, (1) 12mm Lock Washer, and (1) 12mm Flat Washer (**Figure 5**). Do not tighten at this time.
7. Depending on your vehicle, place either the Rear Straight Bracket or the Rear Offset Bracket on the inner side of frame. Hook Top Rear Clamp on the upper slotted hole on the Straight Bracket. **NOTE:** Hook on the Top Rear Clamp should be facing up to the floor panel of the vehicle. Hook Bottom Rear Clamp onto the lower slotted hole on the Straight Bracket. **NOTE:** Hook on the Bottom Rear Clamp should be facing downwards to the ground (**Figure 6 & 7**).
8. Hold Clamp Assembly in place while you attach Rear Mounting Bracket to top and bottom Clamps using the included (2) 10mm x 45mm Hex Head Bolts, (2) 10mm Lock Washers, and (2) 10mm Flat Washers (**Figure 6 & 7**). Do not tighten at this time.  
**Regular Cab Models:** Place Rear Offset Bracket against back side of frame on the driver side, so recessed area clears brake lines. Position rear Straight Bracket against backside of frame on the passenger side.  
**95-98 Extended Cab Models:** Place Rear Offset Bracket against backside of frame on the passenger side and rear Straight Bracket against the backside of frame on the driver side.  
**93-03 Extended Cab Models:** Place rear Straight Bracket against the backside of frame on the passenger and driver side.
9. Attach bottom side of front Mounting Bracket to factory hole on the cross member which lines up with hole on the Mounting Bracket. **NOTE:** Slots may vary from vehicle to vehicle.
10. Level and align Sidebar properly; then tighten all hardware at this time.
11. Do periodic inspections to the installation to make sure that all hardware is secure and tight.

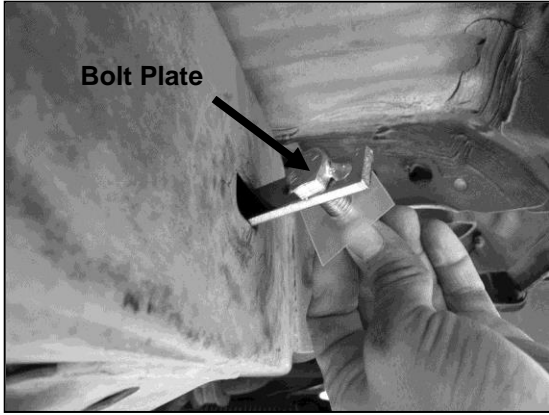


**Figure 1**



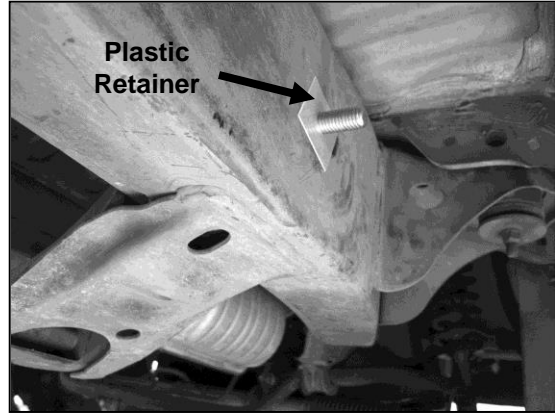
**Figure 2**

**(99-03 Extended Cab Passenger Side Installation Shown)**



**Figure 3**

**(Bolt Plate)  
12mm Lock Washer  
12mm Flat Washer  
12mm Hex Nut**

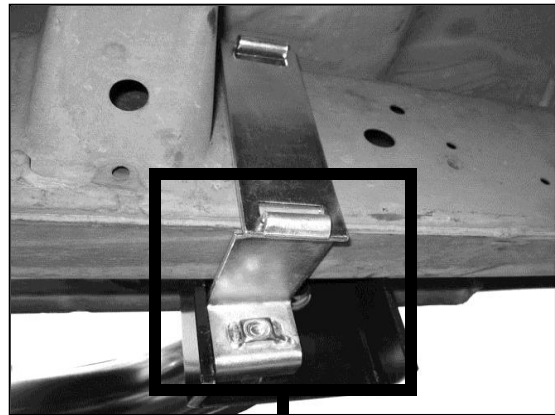


**Figure 4**

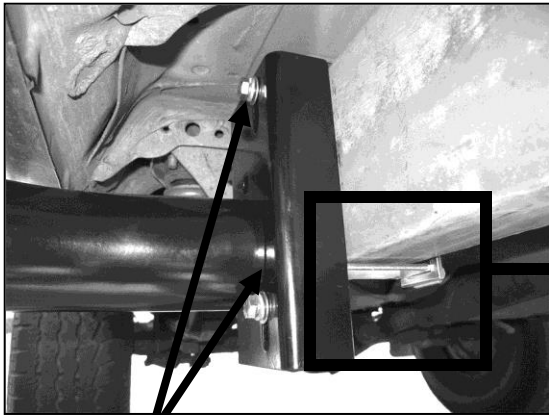


**Figure 5**

**(Bolt Plate)  
12mm Lock Washer  
12mm Flat Washer  
12mm Hex Nut**



**Figure 6**



**Figure 7**

**10mm x 45mm Hex Bolts  
10mm Lock Washer  
10mm Flat Washer**

