

**3" SIDEBARS BODY BOLT MOUNT
1999-2015 SILVERADO/SIERRA 15-3500 EXTENDED & DOUBLE CAB**

PARTS LIST:

| Qty | Description | Qty | Description |
|-----|-----------------------------------------|-----|--------------------------------------------|
| 1 | Driver/Left Sidebar | 1 | Driver/Left Rear Mounting Bracket |
| 1 | Passenger/Right Sidebar | 1 | Passenger/Right Rear Mounting Bracket |
| 1 | Driver/Left Front Mounting Bracket | 4 | 1/2" x 2" Hex Bolts |
| 1 | Passenger/Right Front Mounting Bracket | 4 | 1/2" Lock Washers |
| 1 | Driver/Left Center Support Bracket | 4 | 1/2" x 1-1/2" OD x 1/8" Large Flat Washers |
| 1 | Passenger/Right Center Support Bracket | 6 | 8-1.25mm x 25mm Hex Bolts |
| 1 | Driver/Left Center Mounting Bracket | 6 | 8mm Lock Washers |
| 1 | Passenger/Right Center Mounting Bracket | 6 | 8mm x 24mm x 2mm flat washer |

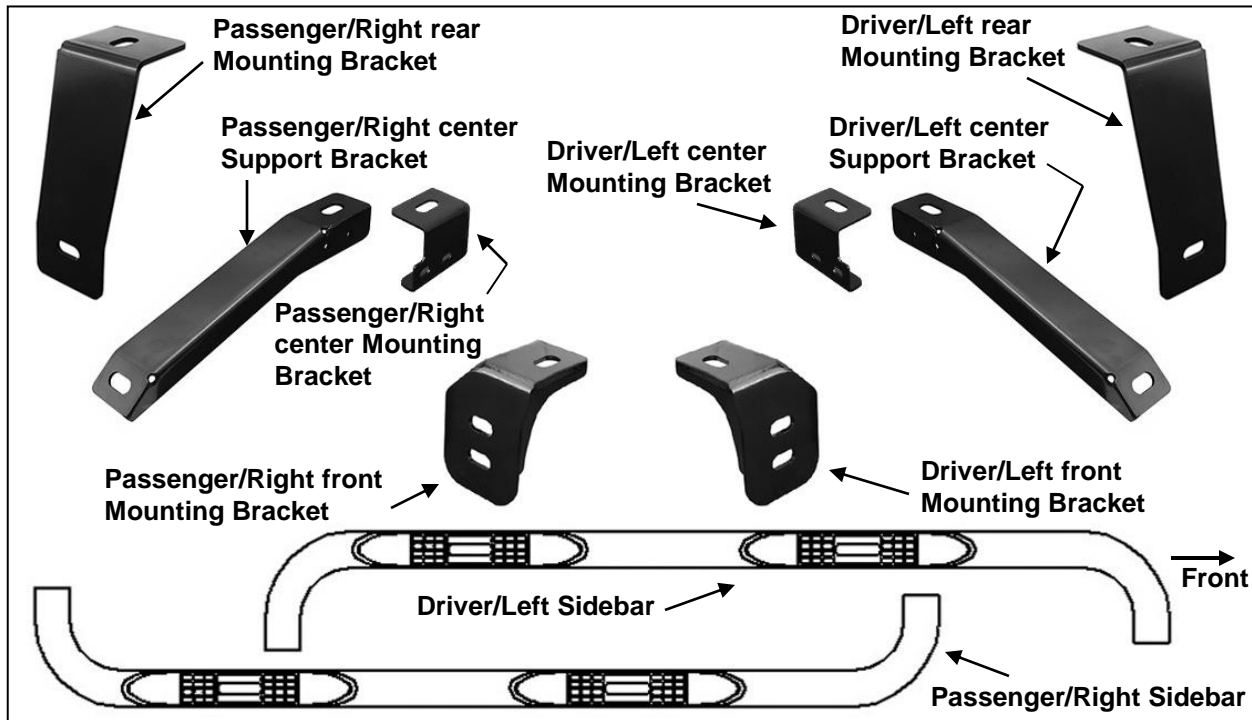

PROCEDURE:

REMOVE CONTENTS FROM BOX. VERIFY ALL PARTS ARE PRESENT. READ THE "FACTORY BODY BOLT REMOVAL INSTRUCTIONS" AND INSTALLATION INSTRUCTIONS CAREFULLY BEFORE STARTING INSTALLATION. ASSISTANCE IS RECOMMENDED.

1. Start installation on the front, driver side of the vehicle. Remove the front body mount bolt, **(Figure 1)**.
2. Select the driver side front Mounting Bracket, **(Figure 2A)**. Insert the factory body mount bolt through the Mounting Bracket, factory washer if equipped and up into the mount. Snug but do not fully tighten the body bolt at this time, **(Figure 2B)**. **VERY IMPORTANT!** To prevent unnecessary noise, adjust the position of all Mounting Brackets so that once tightened, the Mounting Brackets cannot come in contact with the factory steel body mount bracket.
3. Move to the center body mount. Remove the body bolt as previously described. Determine correct procedure for your model and year.

2014-On 1500 Double Cab:

- a. Select the driver/left Support Bracket, **(Figure 3A)**. Repeat **Step 2** to install the Center Support Bracket only, **(Figure 3B)**.

1999-2013 1500, 1999-2015 25-3500:

- a. Select the driver side Center Mounting Bracket, **(Figure 3A)**. Attach the Mounting Bracket to the body mount as previously described in **Step 2**, **(Figure 3C)**. Make sure the Bracket is straight and tighten the body bolt.

**3" SIDEBARS BODY BOLT MOUNT
1999-2015 SILVERADO/SIERRA 15-3500 EXTENDED & DOUBLE CAB**

- b. Select the driver side Center Support Bracket, **(Figure 3A)**. Bolt the Support Bracket to the inside of the Mounting Bracket with (2) 8mm Hex Bolts, (2) 8mm Lock Washers and (2) 8mm Flat Washers, **(Figure 3C)**. Leave 8mm hardware loose.
4. Move toward the rear of the vehicle. Select the driver side Rear Mounting Bracket, **(Figure 4)**. Bolt the rear Mounting Bracket in place as previously described in **Step 2, (Figure 7)**.
5. With assistance, position the diver/left Sidebar up to the front Mounting Bracket. Determine the correct mounting hole to use:
2014-On 1500 Double Cab: Attach the Sidebar to the top slot in the front Bracket, **(Figures 2A & 5)**.
1999-2013 1500, 1999-2015 25-3500: Attach the Sidebar to the bottom slot in the front Bracket, **(Figures 2A & 5)**.
6. Attach the front and rear of the Sidebar to the Brackets with the included (2) 1/2" x 2" Hex Bolts, (2) 1/2" Lock Washers and (2) 1/2" Flat Washers, **(Figures 5 & 7)**. Do not tighten hardware at this time.
7. Attach the center Mounting Bracket to the Sidebar with the included (1) 8mm x 25mm Hex Bolt, (1) 8mm Lock Washer and (1) 8mm Flat Washer, **(Figure 6)**. If the Bracket does not line up with the insert, it may be necessary to loosen the body bolt slightly to move the Bracket. Do not tighten the 8mm hardware at this time.
8. Level and adjust the Sidebar and tighten all hardware. Check all mounting locations for clearance between the factory steel body mount brackets and the Mounting Brackets. Adjust Brackets if necessary and once satisfied with fit, fully tighten all hardware.
9. Repeat **Steps 1—8** for passenger Sidebar installation.
10. Do periodic inspections to the installation to make sure that all hardware is secure and tight.

To protect your investment, wax this product after installing. Regular waxing is recommended to add a protective layer over the finish. Do not use any type of polish or wax that may contain abrasives that could damage the finish.

For stainless steel: Aluminum polish may be used to polish small scratches and scuffs on the finish. Mild soap may be used also to clean the Sidebar.

For gloss black finishes: Mild soap may be used to clean the Sidebar.

Driver side installation pictured

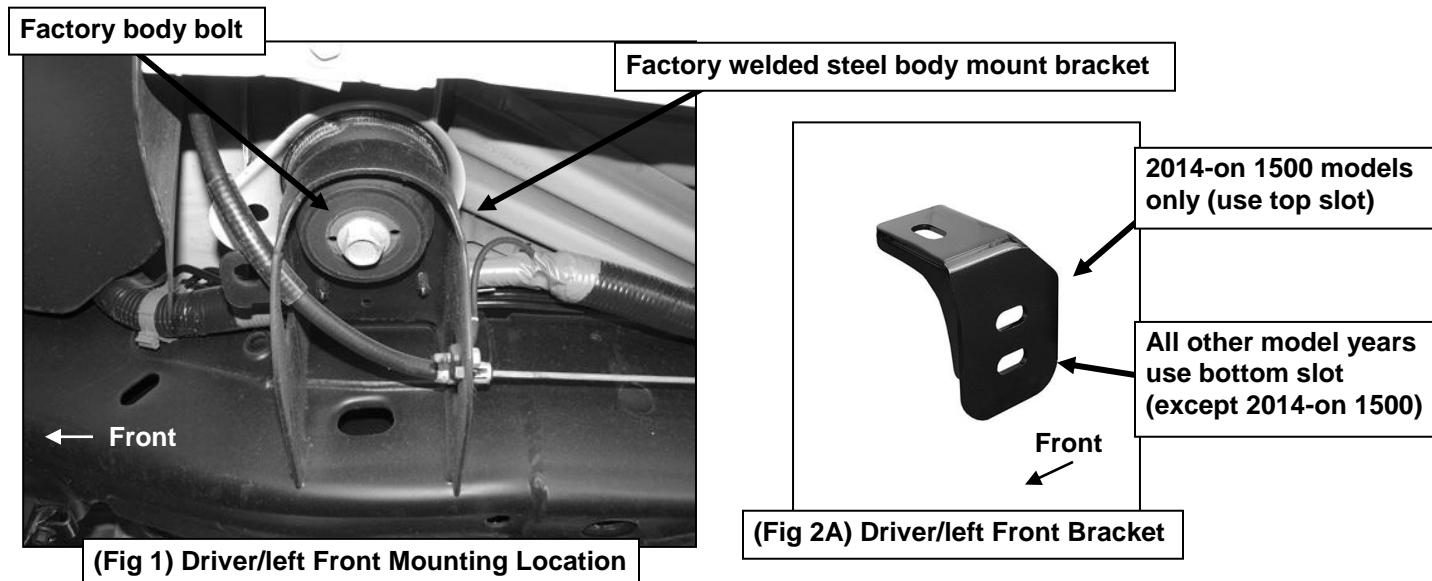

**3" SIDEBARS BODY BOLT MOUNT
1999-2015 SILVERADO/SIERRA 15-3500 EXTENDED & DOUBLE CAB
Driver side installation pictured**

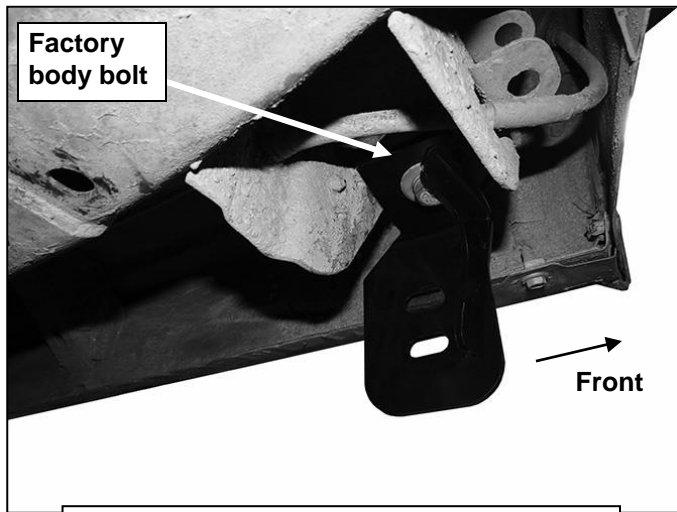

(Fig 2B) Driver/left Front Bracket installed

**2014-on 1500 models only
(Mounting Bracket not required)**

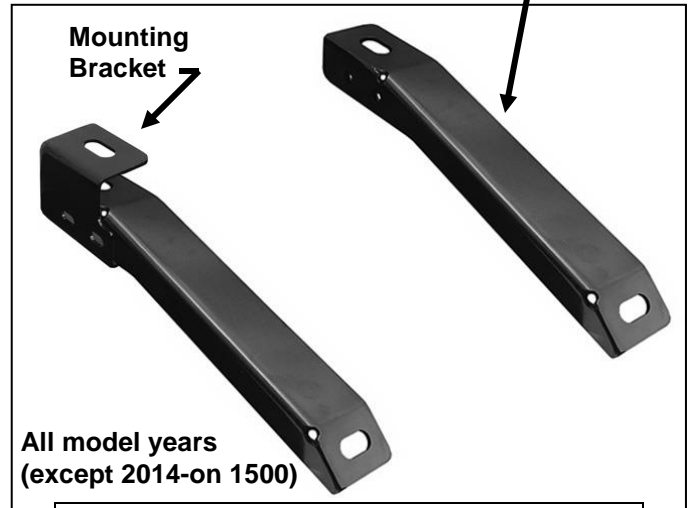

(Fig 3A) Driver/left Center Bracket assembly

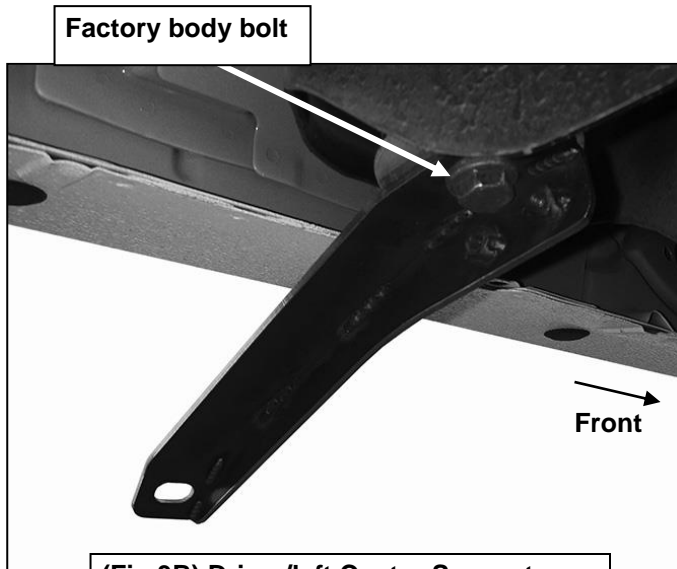

(Fig 3B) Driver/left Center Support Bracket only as installed on 2014 1500

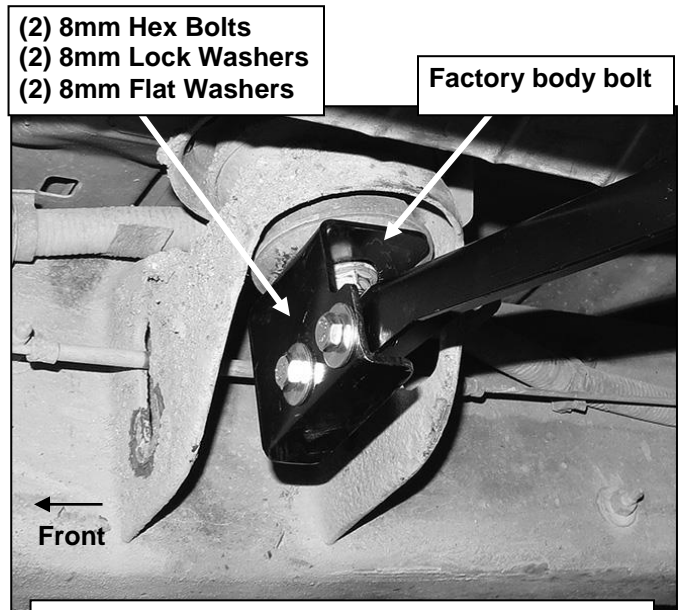

(Fig 3C) Driver/left Center Bracket assembly as installed on all model years (except 2014 1500)

3" SIDEBARS BODY BOLT MOUNT
1999-2015 SILVERADO/SIERRA 15-3500 EXTENDED & DOUBLE CAB
Driver side installation pictured



(Fig 4) Driver/left rear Bracket

Factory body bolt

1/2" x 2" Hex Bolt
1/2" Lock Washer
1/2" Flat Washer

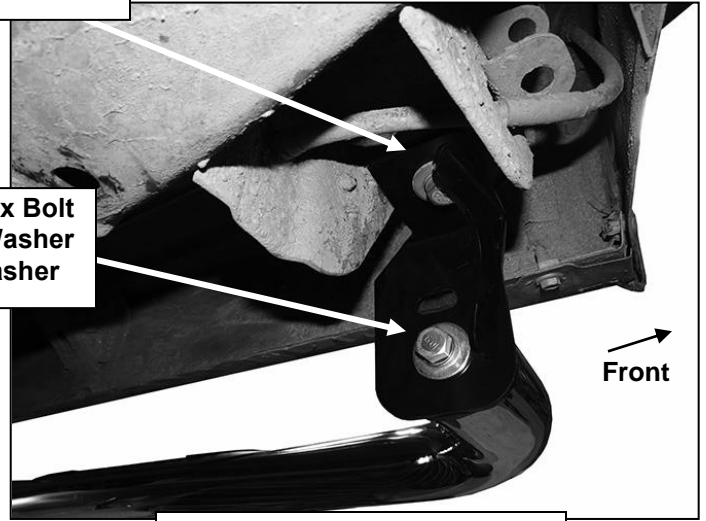

(Fig 5) Driver/left front Bracket

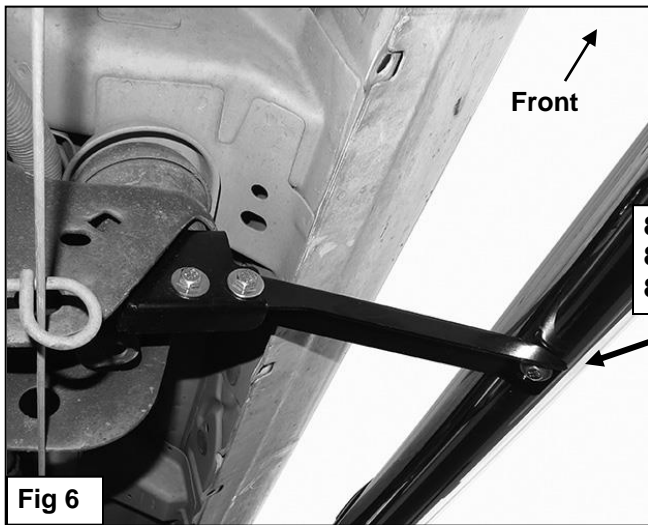

Fig 6

8mm x 25mm Hex Bolt
8mm Lock Washer
8mm Flat Washer

Factory body bolt

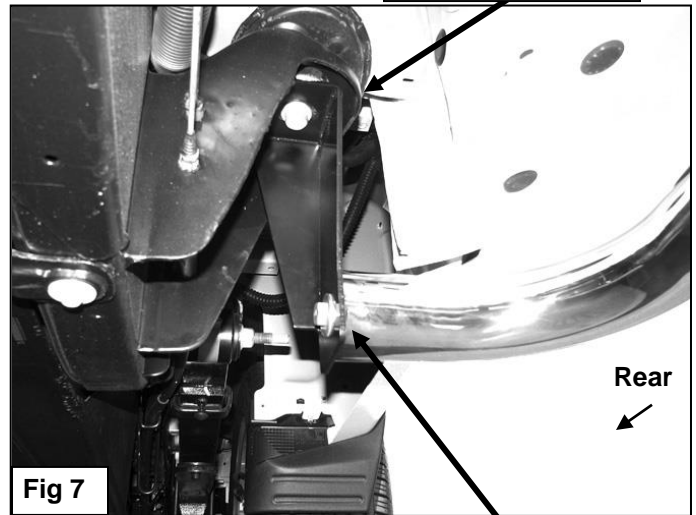

Fig 7

1/2" x 2" Hex Bolt
1/2" Lock Washer
1/2" Flat Washer



Complete Installation