

PARTS LIST:

2	Bed Rails	1	Allen Wrench
4	80mm Rectangular Threaded Plates	4	10-1.50mm x 50mm Allen Head Bolts
4	50mm Parallelogram Threaded Plates	4	10mm x 20mm OD x 2mm Stainless Steel Flat Washers

PROCEDURE:

1. **REMOVE CONTENTS FROM BOX. VERIFY ALL PARTS ARE PRESENT. READ INSTRUCTIONS CAREFULLY BEFORE STARTING INSTALLATION. CUTTING MAY BE REQUIRED. VERIFY BEDRAIL IS CORRECT LENGTH TO COVER STAKE POCKETS BEFORE CUTTING!**
2. On models with factory equipped plastic bedside covers, determine if there is a separate removable cover over each of the stake pockets.
 - a. **On vehicles with removable covers:** Remove the small plastic cover over each stake pocket, **(Figure 1)**.
 - b. **On vehicles without removable covers:** Locate the center of the stake pocket. Carefully cut or drill a small opening in the plastic cover in the center of the stake pocket. **WARNING**, verify exact location of stake pocket before drilling/cutting plastic cover or damage to top of bedside may result. Gradually enlarge the opening to the size of the stake pocket only, **(Figure 2)**. **IMPORTANT, DO NOT** cut along factory lines molded into the plastic cover as these lines may not represent the correct location or size of the stake pocket and may be larger than the actual stake pocket opening.
3. Attach (1) 10mm Bolt, (1) 10mm Flat Washer, and (1) Threaded Plate to each end of Bed Rail as shown in **Figure 3**. **NOTE:** Depending upon your vehicle, use the correct size Threaded Plate. For small stake pockets, use the parallelogram-shaped plate, **(Figure 4A)**. For larger stake pockets, use the rectangular-shaped plate, **(Figure 4B)**. Leave hardware loose.
4. Position the Bed Rail onto the top of the bed. Attach the front of the Bed Rail by tilting the Bolt and/or Bedrail until one side of the Plate engages the lip on the pocket, **(Figure 4A & 4B)**. Once one side of the Threaded Plate is in place under the lip, slide the Plate completely into the stake pocket until the opposite end of the Plate is clear and is in place across the pocket. Repeat this Step to install the remaining end of the Bed Rail.
5. To tighten the Threaded Plates, start at the front and pull up on the Bed Rail to hold the plate in place and centered across the pocket. Keep pulling up on the Bed Rail to prevent the Plate from moving/rotating while tightening the Mounting Bolt. Tighten the Bolt until it is snug but do not fully tighten at this time, **(Figure 5A & 5B)**. Repeat this Step to tighten the rear Bolt on the Bedrail. Once properly centered and aligned, fully tighten both Mounting Bolts.
6. Repeat **Steps 2 – 5** for opposite side Bed Rail installation.
7. Do periodic inspections to the installation to make sure that all hardware is secure and tight.

To protect your investment, wax this product after installing. Regular waxing is recommended to add a protective layer over the finish. Do not use any type of polish or wax that may contain abrasives that could damage the finish.

For stainless steel: Aluminum polish may be used to polish small scratches and scuffs on the finish. Mild soap may be used also to clean the Bedrails.

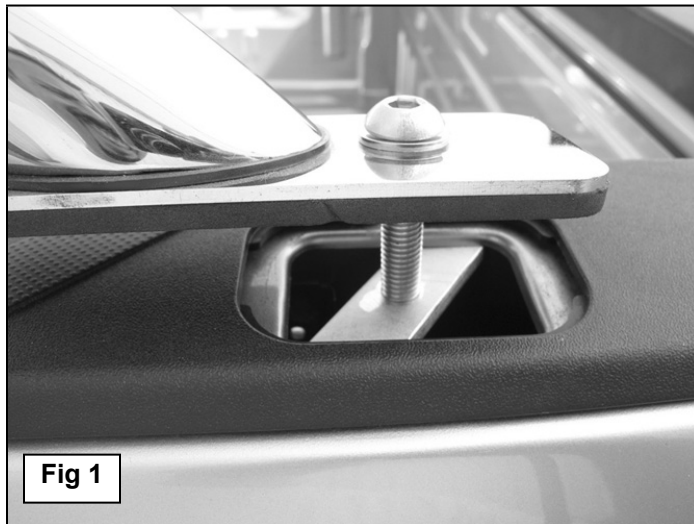

Remove cover if equipped. Note, on some vehicles, size of opening in cover may be larger than actual stake pocket

Fig 1

Dotted line represents approximate size of stake pocket hidden under plastic cover

Determine location of center of stake pocket before cutting cover. Start with a small hole and gradually enlarge the hole to the size of the stake pocket only. Do not follow lines molded into cover!

Note that size of stake pocket may be smaller than line molded into cover by factory. Determine location of stake pocket before cutting cover. Picture for example only, actual vehicle may be different.

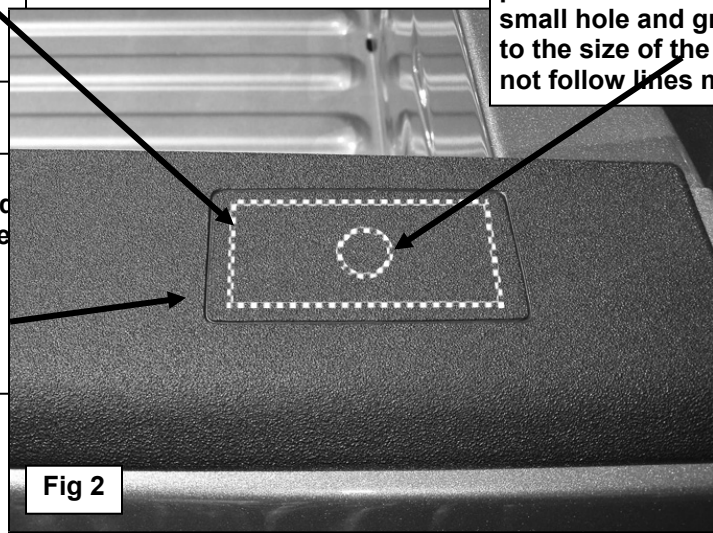

Fig 2

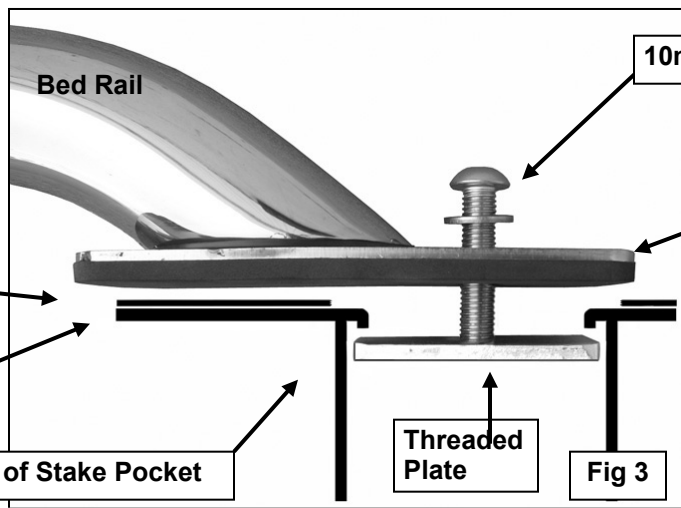
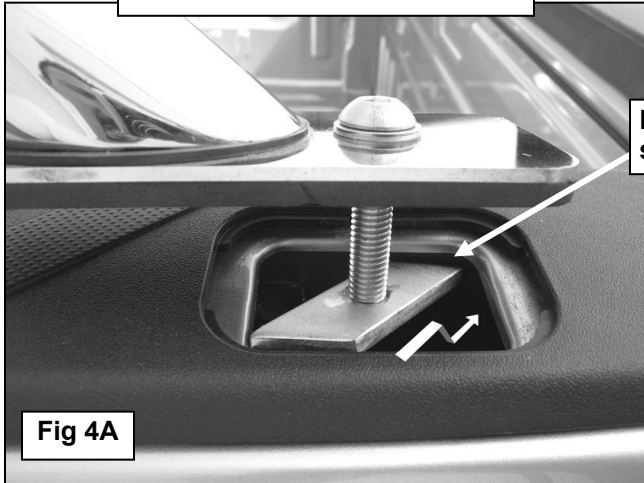
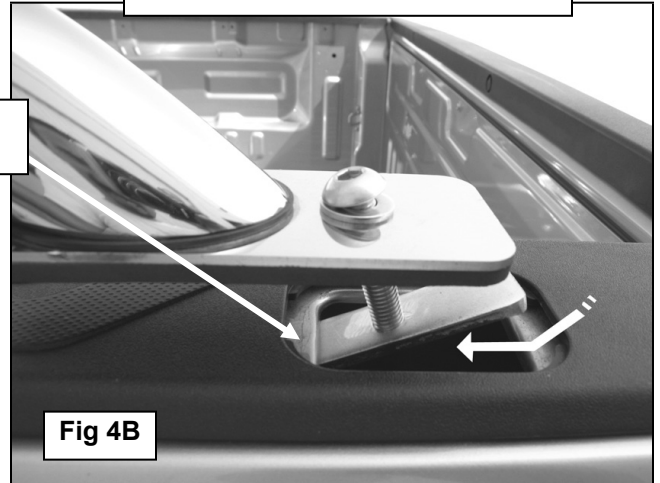

Fig 3

Small Stake Pocket Pictured



Oversized Stake Pocket Pictured



Small Stake Pocket Pictured

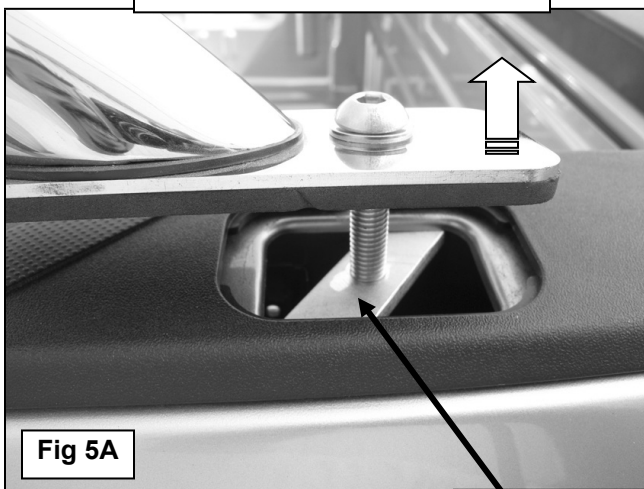

Oversized Stake Pocket Pictured

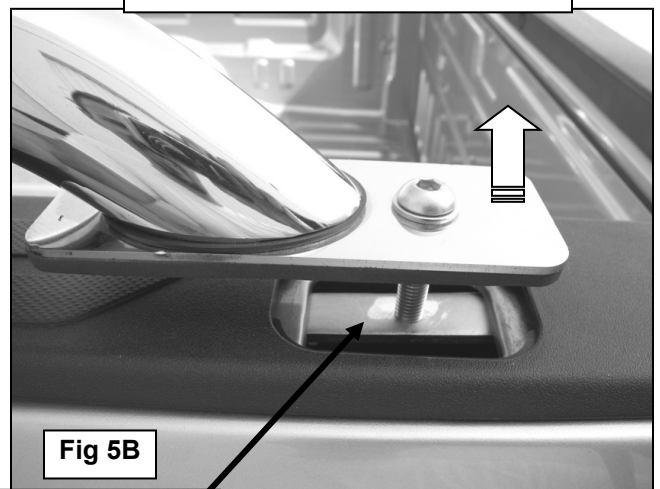

Pull up on Bedrail as you tighten the mounting screw to hold the threaded plate in place against inside of stake pocket

Complete Installation

