

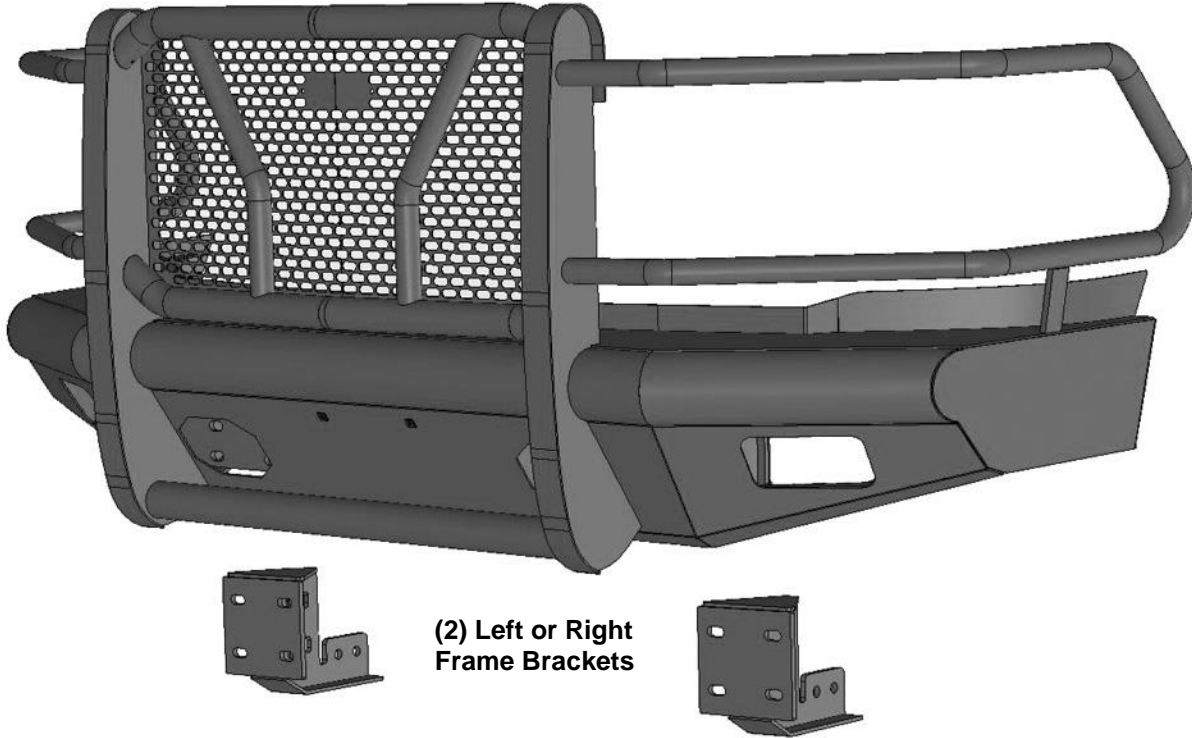

## HEAVY DUTY FRONT BUMPER 2010-15 DODGE RAM 2500-3500

### PARTS LIST:

1	Heavy Duty Front Bumper Assembly	16	12mm x 37mm OD x 3mm Flat Washers
2	Frame Mounting Brackets	8	12mm Nylon Lock Nuts
8	12-1.75mm x 50mm	2	License Plate Mounting Plugs



### PROCEDURE:

- 1. REMOVE CONTENTS FROM BOX. VERIFY ALL PARTS ARE PRESENT. READ INSTRUCTIONS CAREFULLY BEFORE STARTING INSTALLATION. BUMPER IS HEAVY, ASSISTANCE IS HIGHLY RECOMMENDED. CUTTING MAY BE REQUIRED.**
- Open the front hood and temporarily remove the top plastic cover between the radiator and the grille. Also remove the plastic radiator grille for easier access to top bumper bracket bolts, **(Figure 1)**. **NOTE:** Pay close attention to the type and location of all factory hardware for reinstallation. Move the grille and cover to a clean, stable work area. On models with factory fog lights, unplug both lights and release the wiring harness from the back of the bumper, **(Figure 2)**. Move the wiring harness out of the way during bumper installation. Carefully remove both fog lights from the back of the bumper. **NOTE:** Fog lights can also be removed once the bumper has been removed from vehicle.
- Release the clips attaching the lower splash guard to the back of the front bumper, (if equipped). Locate the factory bumper bolts attaching the outer bumper to the inner brackets, **(Figure 3 & 4)**. With assistance, remove the bumper assembly, **(Figure 5)**. Next, remove the (2) tow hooks.
- Remove the driver side inner bumper bracket and lower frame extension from the ends of the frame, **(Figures 5—7)**. **NOTE:** Lower frame extensions cannot be reinstalled.
  - a. IMPORTANT:** On models equipped with a diesel engine, the intercooler will need to be moved out of the way to remove the bumper bracket. Assistance is highly recommended to avoid damaging the intercooler.
  - b.** Remove the hex bolts attaching the hanging brackets to the inside of the frame, **(Figure 6)**. Loosen the hex bolts attaching the brackets to the intercooler. Remove the double bolt plates and bumper brackets, **(Figure 7)**. If the intercooler cannot be moved enough to clear the double bolt plates, loosen the intercooler hoses. If the double bolt plates still cannot be removed, it will

**HEAVY DUTY FRONT BUMPER  
2010-15 DODGE RAM 2500-3500**

be necessary to temporarily remove the intercooler. **WARNING:** Be very careful to avoid damaging the intercooler.

5. Select (1) Frame Mounting Bracket. Line up the holes in the Bracket with the outside of the frame. Reuse the factory bumper bracket hardware to attach the Bracket to the outside of the frame, (**Figures 8 & 9**). **NOTE:** Insert the factory double bolt plates through the Bumper Bracket and back through the frame from outside to inside through the frame. Snug but do not fully tighten hardware at this time. Repeat this Step to install the passenger side Frame Bracket.
  - a. On models equipped with diesel engine, reinstall the intercooler and mounting brackets at this time. Fully tighten intercooler bracket hardware only, (**Figure 7**).
6. With assistance, line up the Heavy Duty Bumper assembly with the (2) Frame Mounting Brackets. Attach the Bumper to the (2) Brackets with (8) 12mm Hex Bolts, (16) 12mm Flat Washers and (8) 12mm Nylon Lock Nuts, (**Figure 9**). **NOTE:** Stands or blocks are highly recommended to support weight of bumper during installation. Snug but do not fully tighten hardware at this time.
7. With assistance, align and adjust the Heavy Duty Bumper to the vehicle and tighten all hardware.
8. On models with factory fog lights, carefully snap each fog light into the (3) mounting tabs on the back of the Bumper, (**Figure 10**).
9. Reinstall and properly secure all fog light wiring. Reinstall the grille and top cover.
10. Select (1) factory tow hook. Reuse the factory hardware to attach the tow hook to the mounting plate behind the front of the bumper, (**Figure 11**). Repeat to install the remaining tow hook.
11. Remove license plate, (if required), from factory bumper. Install (2) Plastic License Plate Plugs into the holes in the Heavy Duty Bumper. Reuse factory screws to attach license plate to Plugs.
12. Use a sharp knife or hacksaw blade to cut off lower portion of fender liner to match Bumper profile as desired.
13. Do periodic inspections to the installation to make sure that all hardware is secure and tight.

**To protect your investment**, wax this product after installing. Regular waxing is recommended to add a protective layer over the finish. Do not use any type of polish or wax that may contain abrasives that could damage the finish. Mild soap may be used to clean the Bumper Assembly.

**Driver Side Installation Pictured**

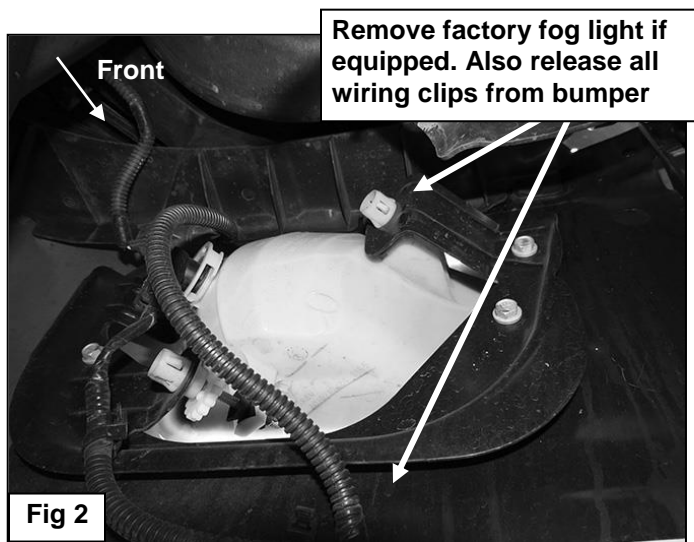
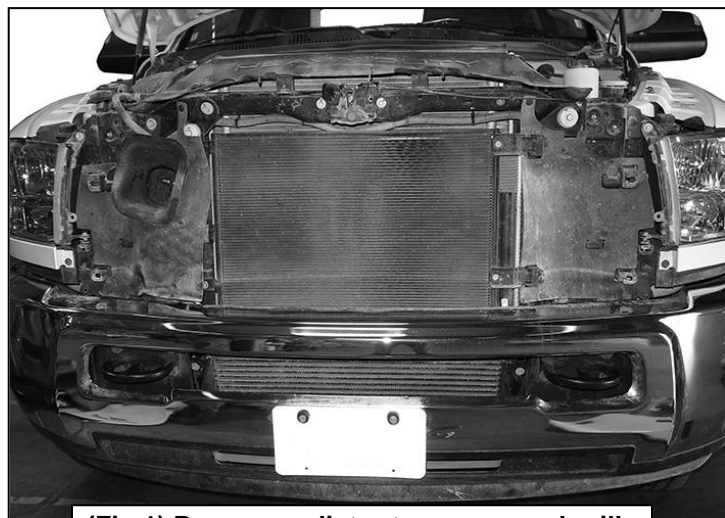

**HEAVY DUTY FRONT BUMPER  
2010-15 DODGE RAM 2500-3500**

**Driver Side Installation Pictured**



**(Fig 3) Remove driver side top bumper hardware**

**Remove lower frame extension  
(pictured from below)**

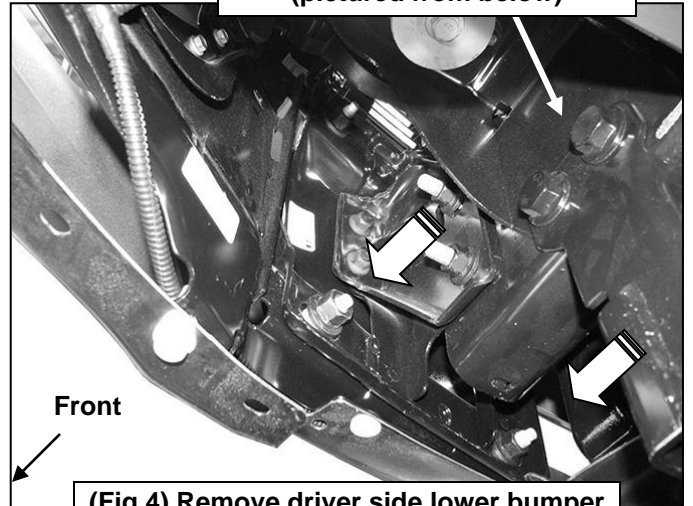

**(Fig 4) Remove driver side lower bumper  
bracket hardware (pictured from below)**

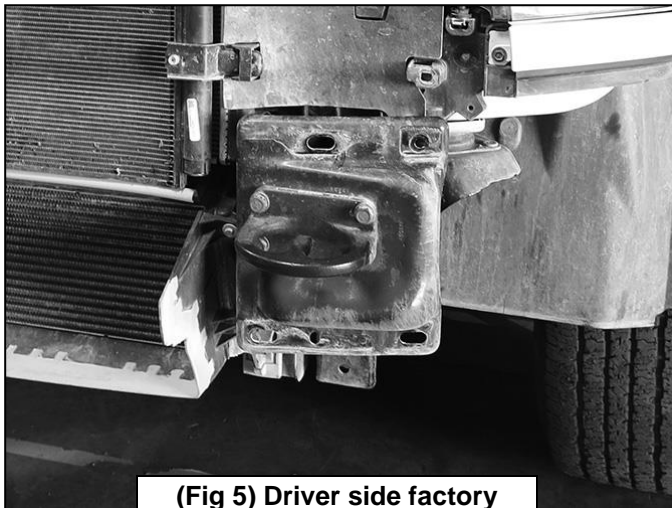

**(Fig 5) Driver side factory  
bumper bracket and tow hook**

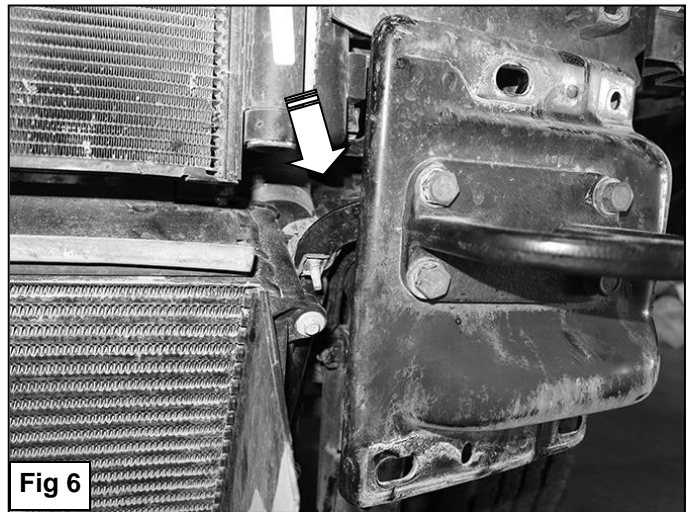

**Fig 6**

**Diesel models, loosen top support bracket  
hardware at frame and intercooler (large  
arrow). Temporarily remove lower hanging  
intercooler bracket from side of frame**

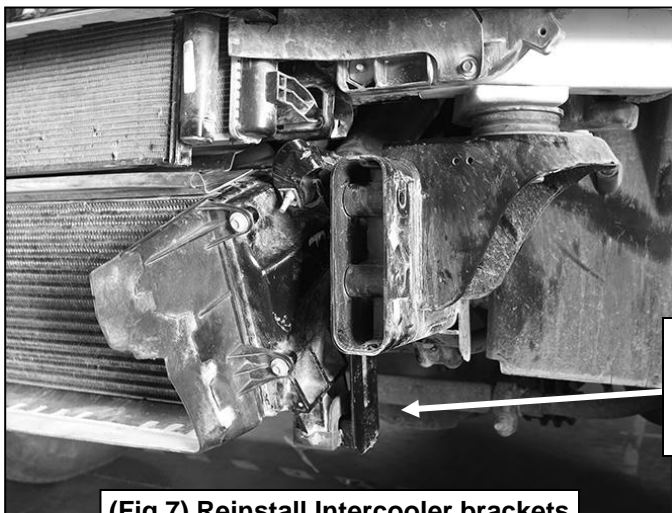

**(Fig 7) Reinstall Intercooler brackets**

**Driver Side Installation Pictured**

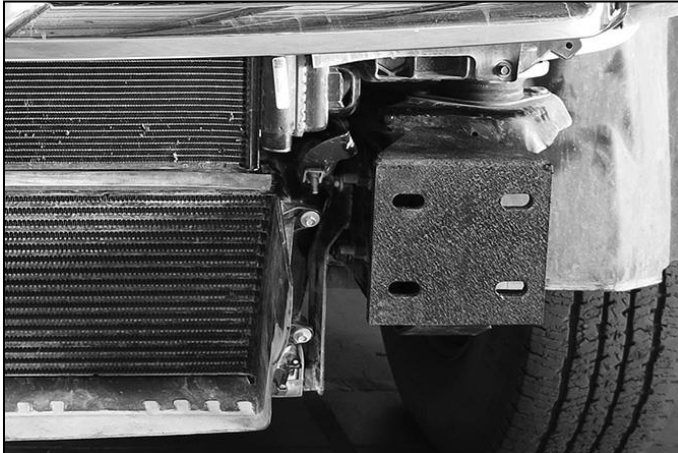

**(Fig 8) Reuse factory bumper bracket hardware to attach Frame Mounting Bracket to outside of frame**

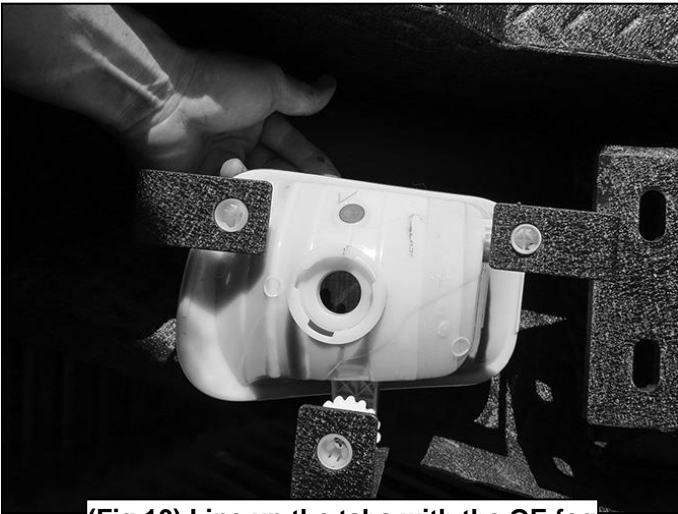

**(Fig 10) Line up the tabs with the OE fog light if equipped. Carefully push the fog light into the mounting tabs**



- (4) 12mm x 50mm Hex Bolts**
- (8) 12mm Flat Washers**
- (4) 12mm Nylon Lock Nuts**

**Factory double bolt plate**

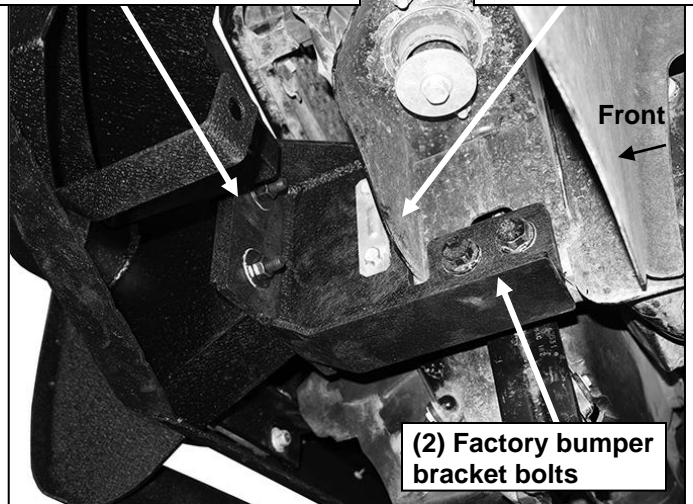

**(Fig 9) Reuse factory bumper bracket hardware to attach Frame Mounting Bracket to outside of frame**

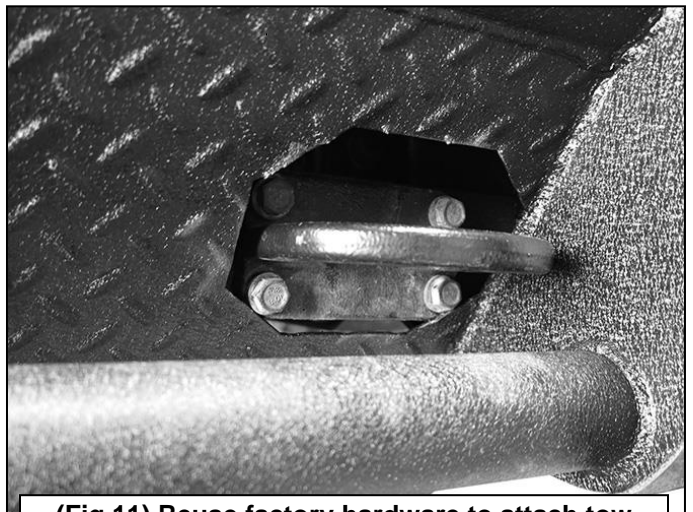

**(Fig 11) Reuse factory hardware to attach tow hook to mounting plates on Heavy Duty Bumper**