

**PARTS LIST:**

1	Driver/left side T6 Sidebar (76in)	30	8mm x 24mm x 2mm Washers
1	Passenger/right side T6 Sidebar (76in)	12	8mm Lock Washers
6	Universal Mounting Brackets (left or right)	12	8-1.25mm Hex Nuts
6	8mm x 35mm Double Bolt Plates	18	8-1.25mm Nylon Lock Nuts

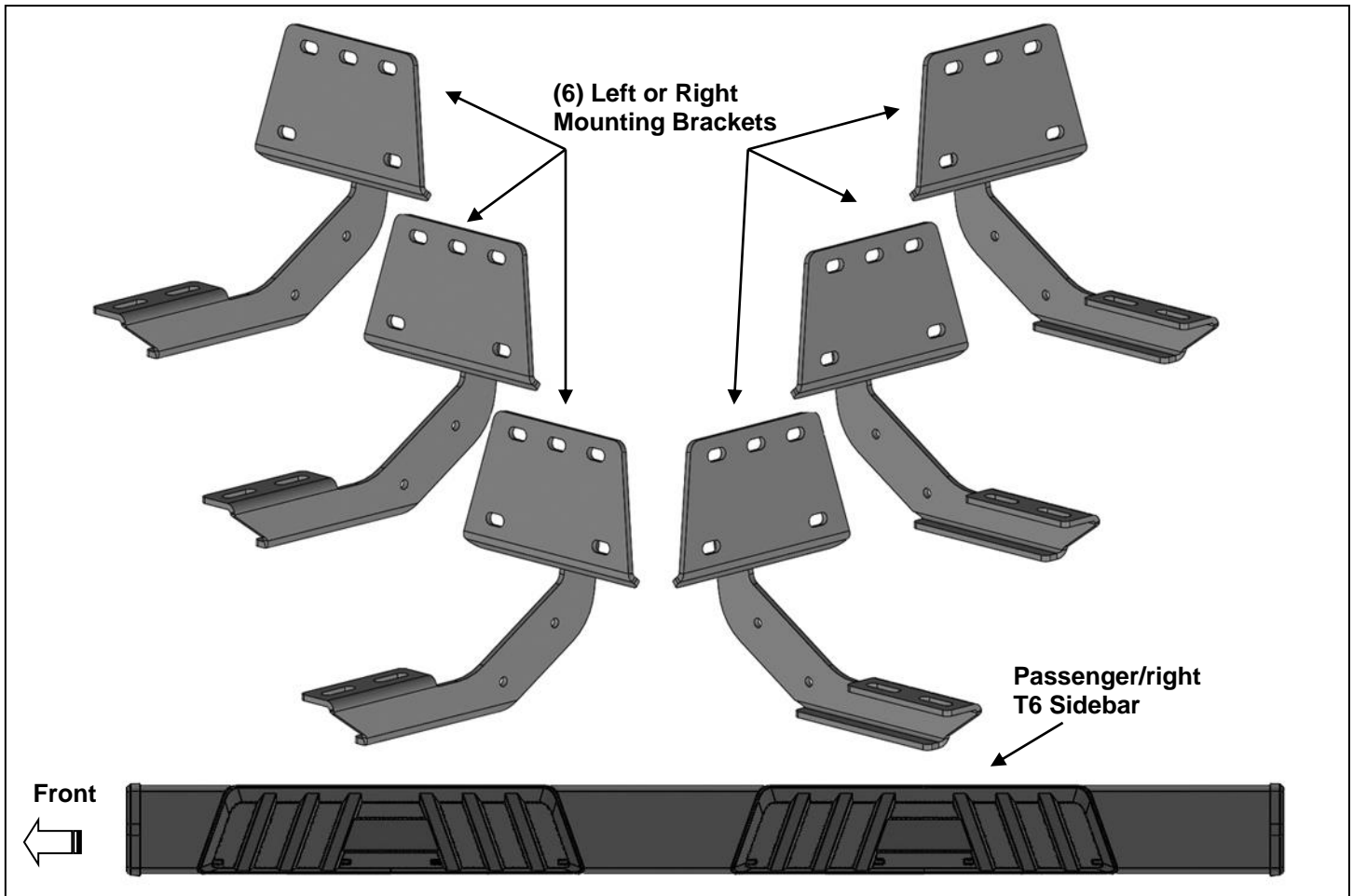

**PROCEDURE:**

**REMOVE CONTENTS FROM BOX. VERIFY ALL PARTS ARE PRESENT. READ INSTRUCTIONS CAREFULLY BEFORE STARTING INSTALLATION. ASSISTANCE IS RECOMMENDED.**

1. Start the installation under the Passenger side of the vehicle. Locate the front (3) factory studs along the inner side of the body panel, **(Figure 1)**. **NOTE:** Use a wire brush or die to remove paint buildup on the threaded studs.
2. Select (1) Mounting Bracket. **NOTE:** All (6) Brackets are universal and will fit left or right side. Attach the Mounting Bracket to the (3) factory studs with (3) 8mm Flat Washers and (3) 8mm Nylon Lock Nuts, **(Figures 2 & 3)**. Leave brackets loose at this time.
3. Repeat **Steps 1 & 2** to install the Universal Brackets in the center and rear mounting locations along the body panel, **(Figures 4—7)**.
4. Carefully unwrap and select the Passenger/right T6 Sidebar. Use the illustration above to help determine the correct Sidebar. Place the Sidebar on top of the Brackets. **IMPORTANT:** Do not slide, (front to back or rotate), the Sidebar on the Brackets or damage to the finish on the Sidebar may result. Locate the channel openings in the bottom of the Sidebar. Select (3) 8mm Double Bolt Plates, **(Figure 8)**. Insert the Bolt Plates into the channel in the bottom of the Sidebar closest to the Brackets, **(Figure 9)**. Lift the Sidebar up and guide the studs through the Brackets.

5. Attach the Sidebar to the Brackets with (6) 8mm Flat Washers, (6) 8mm Lock Washers and (6) 8mm Hex Nuts, **(Figures 10—13)**.
6. Level and adjust the Sidebar as necessary and fully tighten all hardware.
7. Repeat **Steps 1—6** for Driver/left side T6 Sidebar installation.
8. Do periodic inspections to the installation to make sure that all hardware is secure and tight.

**To protect your investment**, wax this product after installing. Regular waxing is recommended to add a protective layer over the finish. Do not use any type of polish or wax that may contain abrasives that could damage the finish. Mild soap may be used also to clean the Sidebar.

**Passenger/right Side Installation Pictured**

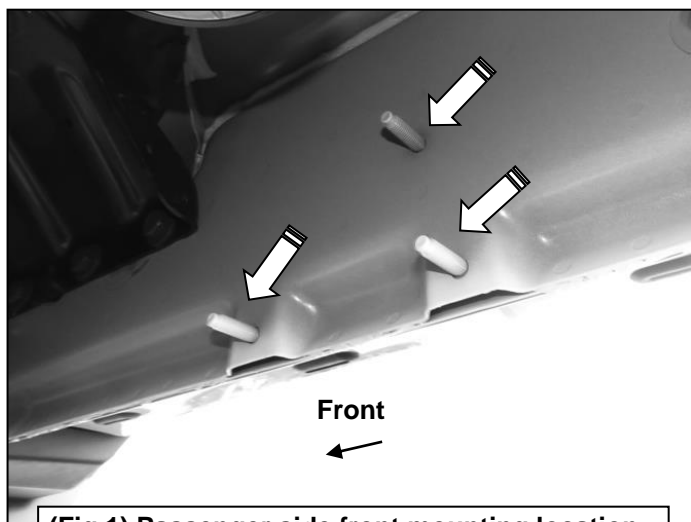

**(Fig 1) Passenger side front mounting location**

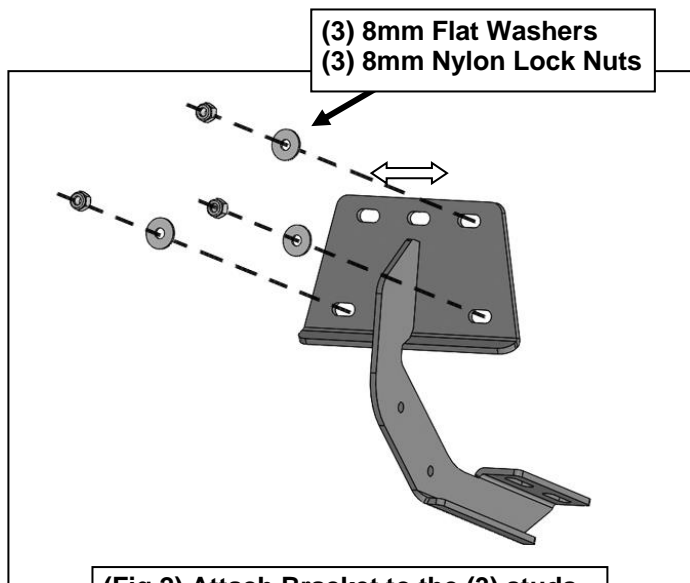

**(Fig 2) Attach Bracket to the (3) studs**

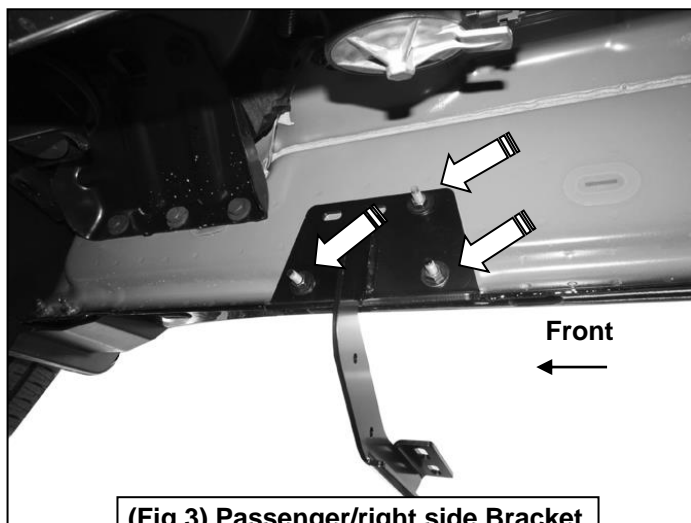

**(Fig 3) Passenger/right side Bracket attached to front mounting location**

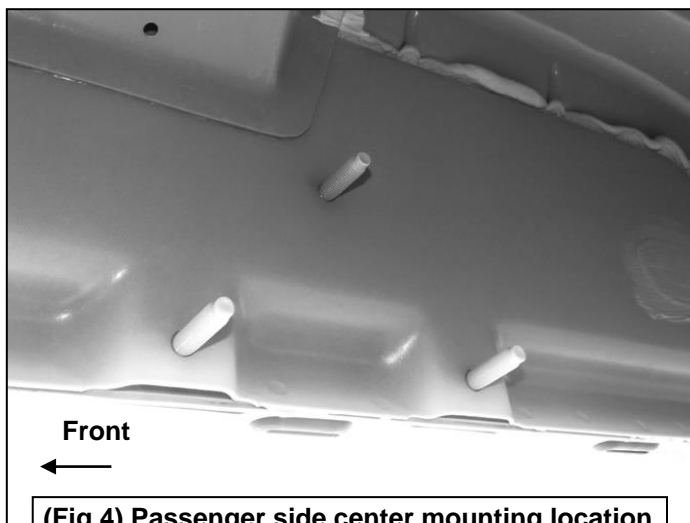

**(Fig 4) Passenger side center mounting location**

Passenger/right Side Installation Pictured

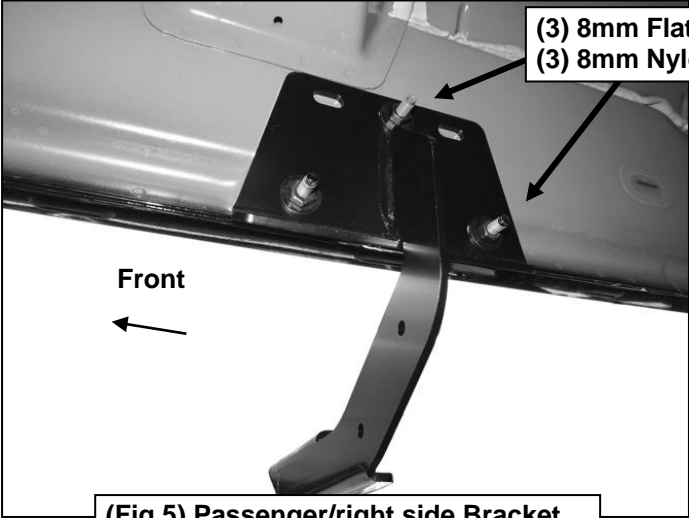

(Fig 5) Passenger/right side Bracket attached to center mounting location

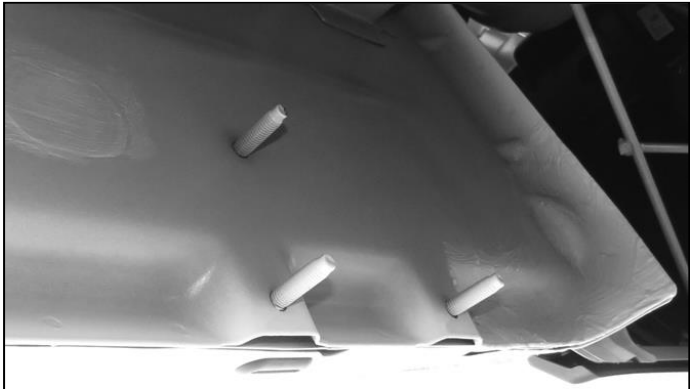

(Fig 6) Passenger side rear mounting location

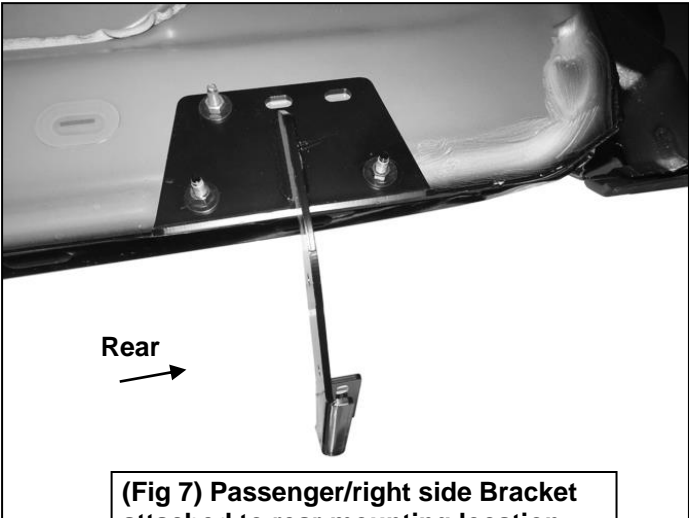

(Fig 7) Passenger/right side Bracket attached to rear mounting location

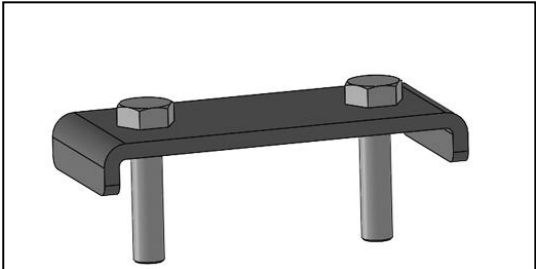

(Fig 8) 8mm Double Bolt Plate

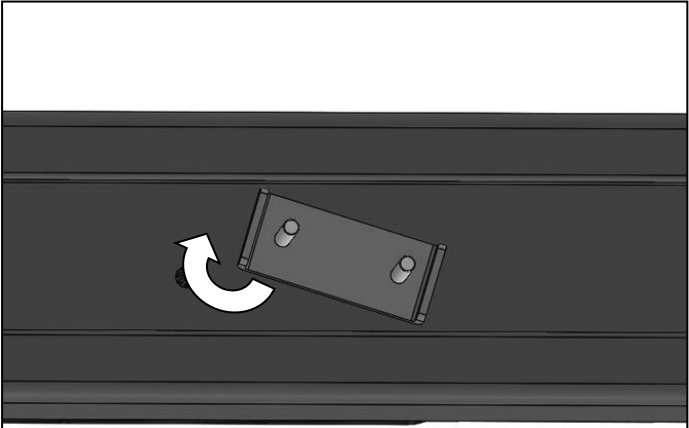

(Fig 9) Insert 8mm Double Bolt Plate through the channel opening in the bottom of the Sidebar

Passenger/right Side Installation Pictured

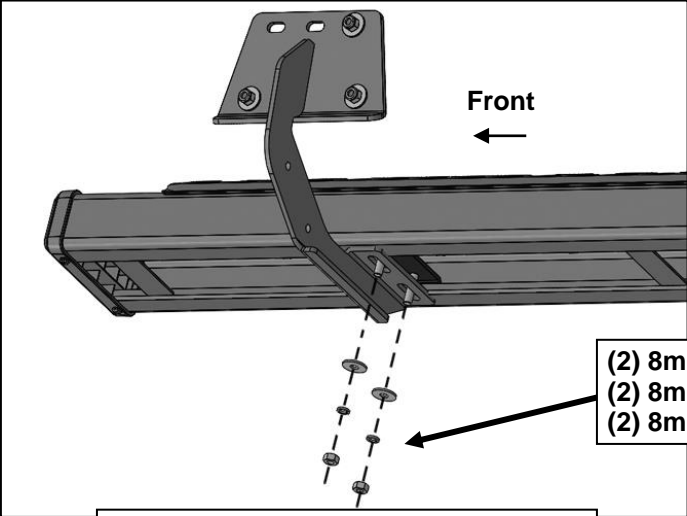

- (2) 8mm Flat Washers
- (2) 8mm Lock Washers
- (2) 8mm Hex Nuts

(Fig 10) Passenger Sidebar attached to front Mounting Bracket illustrated

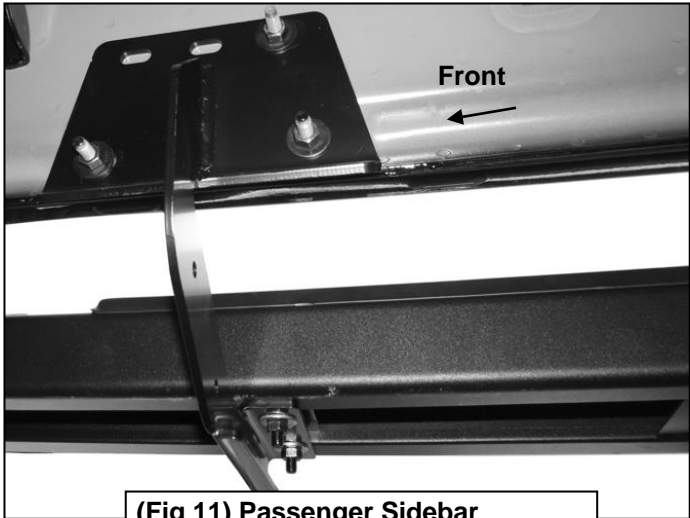

(Fig 11) Passenger Sidebar attached to front Mounting Bracket

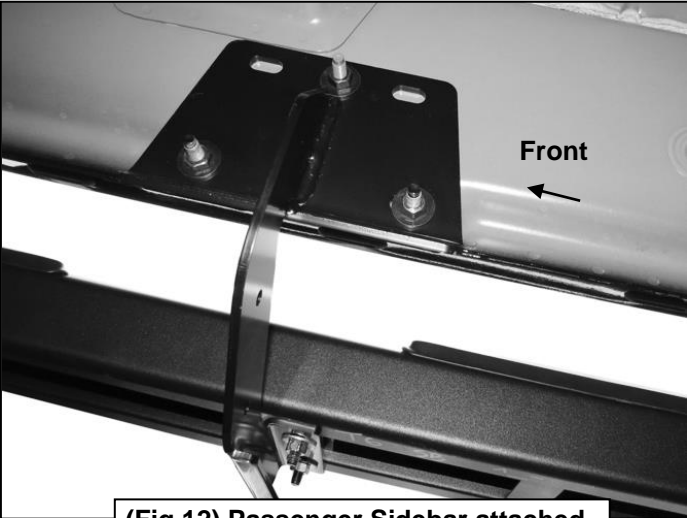

(Fig 12) Passenger Sidebar attached to center Mounting Bracket



(Fig 13) Driver/left Sidebar attached to rear Mounting Bracket