

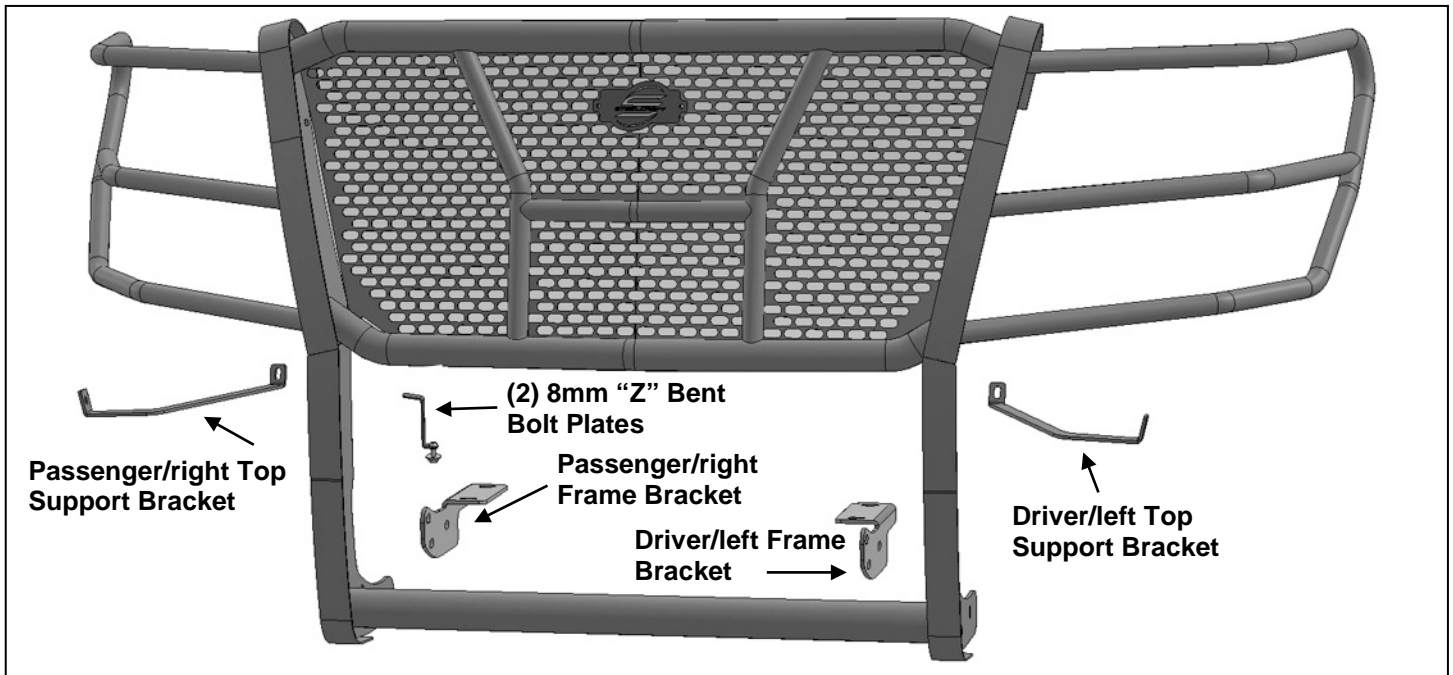

**INSTALLATION INSTRUCTIONS**  
**GRILLE GUARD**  
**2016-18 NISSAN TITAN "XD" DIESEL AND GAS ENGINE**

**PARTS LIST:**

1	Grille Guard	6	12mm Hex Nuts
1	Driver/left Frame Bracket	2	8-1.25mm x 25mm "Z" Bolt Plates
1	Passenger/right Frame Bracket	2	8-1.25mm x 25mm Button Head Bolts
1	Driver/left Top Support Bracket	6	8mm x 24mm OD x 2mm Flat Washers
1	Passenger/right Top Support Bracket	4	8mm Lock Washers
4	12-1.25mm x 55mm <b>SPECIAL Fine Thread</b> Hex Bolts	4	8mm Hex Nuts
6	12-1.75mm x 35mm Hex Bolts	1	5mm Wrench
16	12mm x 32mm OD x 3mm Large Flat Washers	1	2.5mm Wrench
10	12mm Lock Washers		



**PROCEDURE:**

1. REMOVE CONTENTS FROM BOX. VERIFY ALL PARTS ARE PRESENT. READ INSTRUCTIONS CAREFULLY. MINOR CUTTING IS REQUIRED. ASSISTANCE IS RECOMMENDED. FOR "XD" GAS AND DIESEL MODELS ONLY, EXCLUDES NON-XD 2017-ON MODELS. INSTALLATION MAY INTERFERE WITH FORWARD FACING FRONT SENSORS AND CAMERA.
2. Starting from under the front of the vehicle, remove the factory tow hooks if equipped, (Figures 1 & 2).  
**NOTE:** Tow hooks cannot be reinstalled.
3. Select the passenger/right Frame Mounting Bracket, (Figure 3). Use the included (2) 12-1.25mm x 55mm **SPECIAL Fine Thread** Hex Bolts, (2) 12mm Lock Washers and (2) 12mm Flat Washers to attach the Mounting Bracket to the holes in the bottom of the frame, (Figures 3 & 4). Do not tighten hardware at this time. Repeat to install the driver/left Frame Bracket.
4. Open the hood and remove the plastic cover from the top of the radiator, (Figure 5). Next, remove the clips attaching the top and center of the grille. Leave the bottom of the grille attached at this time.  
**NOTE:** The grille is held in place with several plastic lock clips. Insert a flat blade screwdriver into the slot in the lock clip and rotate approximately 1/4-turn to release lock clips.
5. Select (1) 8mm "Z" Bolt Plate, (Figure 6). Locate the factory hole in the radiator core support, (Figures 7 & 10). Insert the Bolt Plate from the back and out through the front of the core support, (Figure 8). Tilt the grille forward slightly for access. Temporarily hold the Bolt Plate in place with (1) 8mm Flat Washer, (1) 8mm Lock Washer and (1) 8mm Hex Nut, (Figure 9). Leave hardware loose at this time. Repeat to install the driver/left Bolt Plate.
6. Push the grille assembly back against the Bolt Plate hardware. Mark the locations where the plastic tabs on the underside/back of the top cover on the grille hit the 8mm hardware, (Figure 9). Temporarily remove the grille assembly and move it to a clean, stable work surface, (Figure 10).

7. Use a sharp knife or hacksaw blade to carefully cut the plastic tabs off of the underside of the cover to clear the hardware, **(Figure 9)**. **IMPORTANT:** The cover must fit tight against the radiator core support. Only remove the plastic material under the cover interfering with the fit of the cover.
8. Reattach the grille assembly at the bottom only, do not reattach the top of the grille at this time.
9. With assistance, position the Grille Guard onto the outside of the Frame Mounting Brackets. Attach the Grille Guard to the Brackets with the included (6) 12-1.75mm x 35mm Coarse Thread Hex Bolts, (12) 12mm Flat Washers, (6) 12mm Lock Washers and (6) 12mm Hex Nuts, **(Figures 11 & 12)**. Do not tighten hardware at this time.
10. Select the passenger/right Top Support Bracket, **(Figure 13)**. Insert the Support Bracket through the correct opening in the grille so that the Bracket will properly line up with the factory hole in the radiator core support, (See **Step 6**), and the upright on Grille Guard, **(Figures 14 & 15)**. Reinstall the 8mm Bolt Plate into the factory hole in the passenger side of the radiator core support. Carefully pull the top of the grille forward to access the 8mm Bolt Plate, **(Figure 9)**. Attach the inner end of the Top Support Bracket to the Bolt Plate with (1) 8mm Flat Washer, (1) 8mm Lock Washer and (1) 8mm Hex Nut, **(Figures 14 & 15)**. Attach the outer end of the Top Bracket to the upright with (1) 8mm x 25mm Button Head Bolt, (2) 8mm Flat Washers, (1) 8mm Lock Washer and (1) 8mm Hex Nut, **(Figure 15)**. Do not tighten at this time. Repeat to install the driver/left Top Support Bracket.
11. Level and adjust the Grille Guard and tighten all hardware at this time including all Top Support Bracket hardware.
12. Reattach the grille assembly and the plastic cover on the radiator.
13. On models with grille mounted factory camera, remove screen covering opening in Grille Guard, **(Figure 16)**.
14. Do periodic inspections to the installation to make sure that all hardware is secure and tight.

**To protect your investment**, wax this product after installing. Regular waxing is recommended to add a protective layer over the finish. Do not use any type of polish or wax that may contain abrasives that could damage the finish.

**For stainless steel:** Aluminum polish may be used to polish small scratches and scuffs on the finish. Mild soap may be used also to clean the Grille Guard.

**For gloss black finishes:** Mild soap may be used to clean the Grille Guard.

### Passenger/right side installation pictured

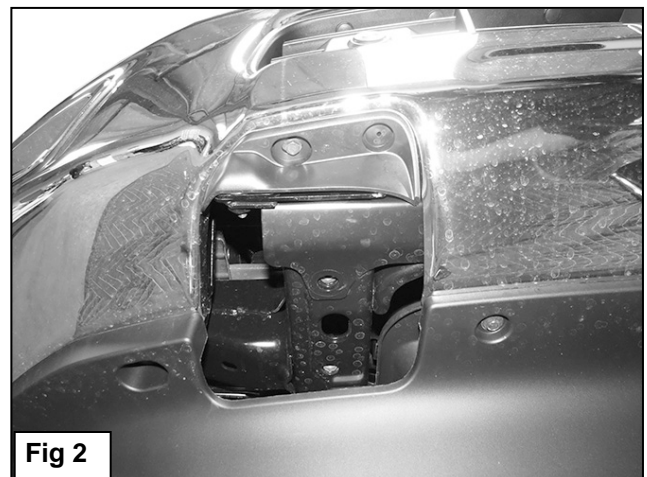
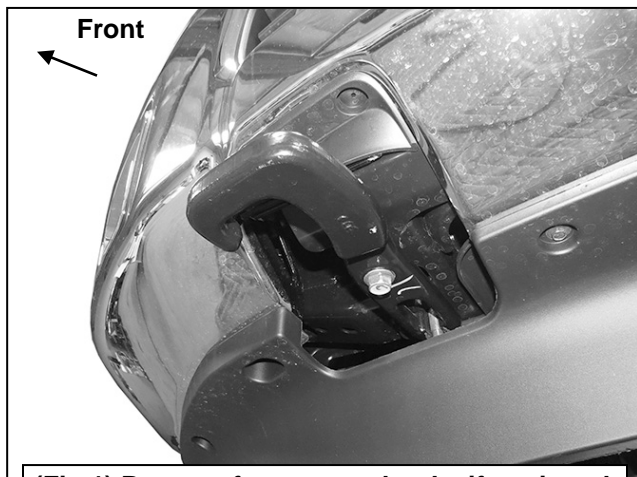

### Passenger/right side installation pictured

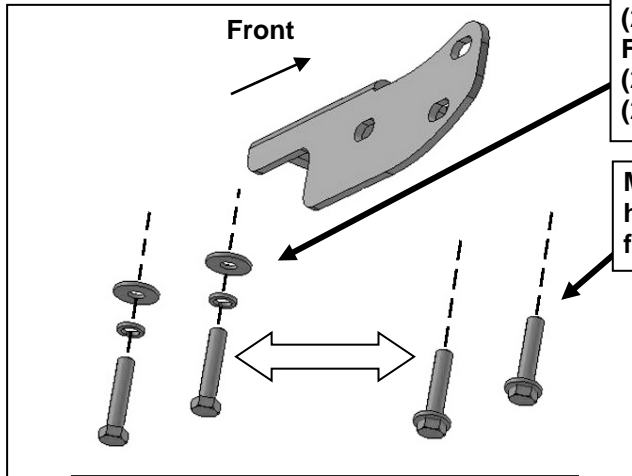

(Fig 3) Passenger/right Frame Bracket

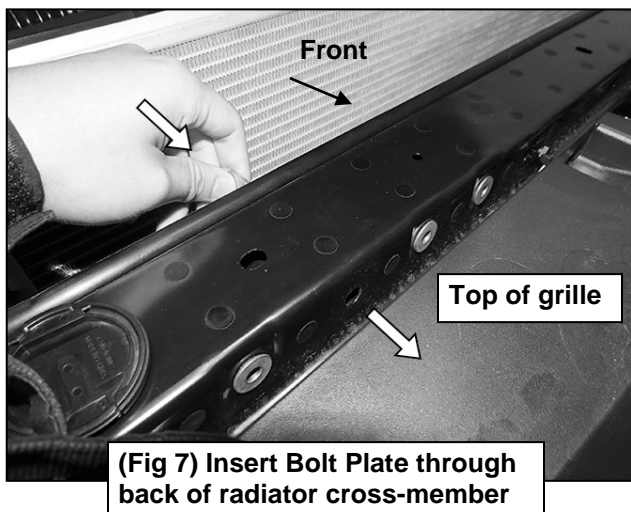
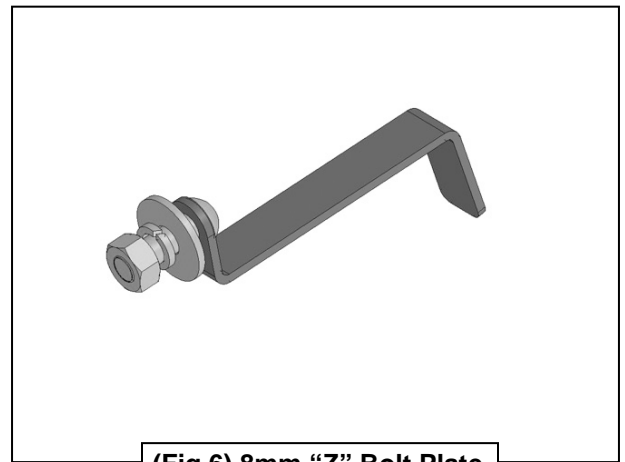
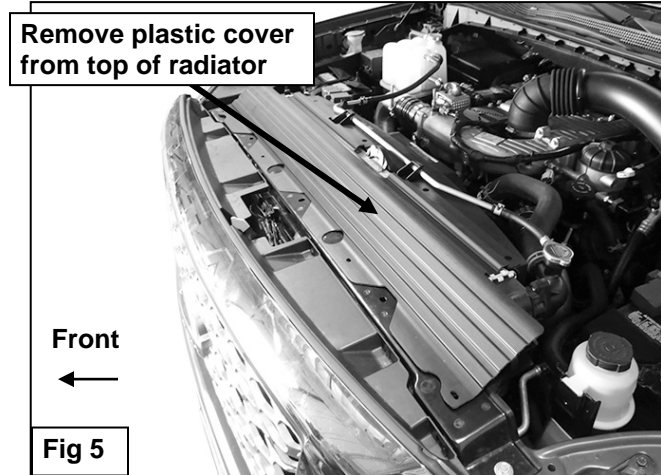

**Passenger/right side installation pictured**

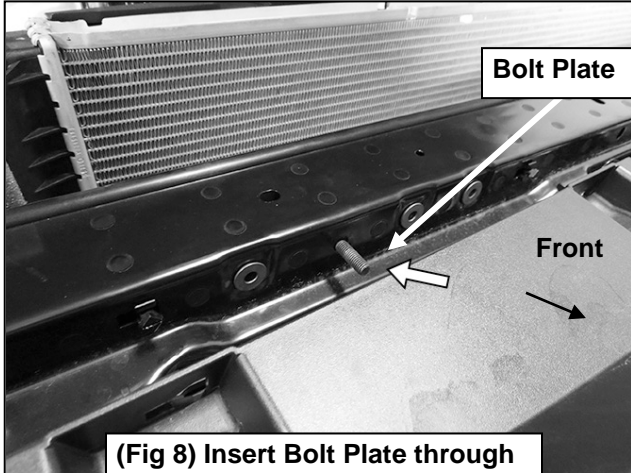

**(Fig 8) Insert Bolt Plate through back of radiator cross-member**

Dashed line indicates location of plastic tab under top of grille

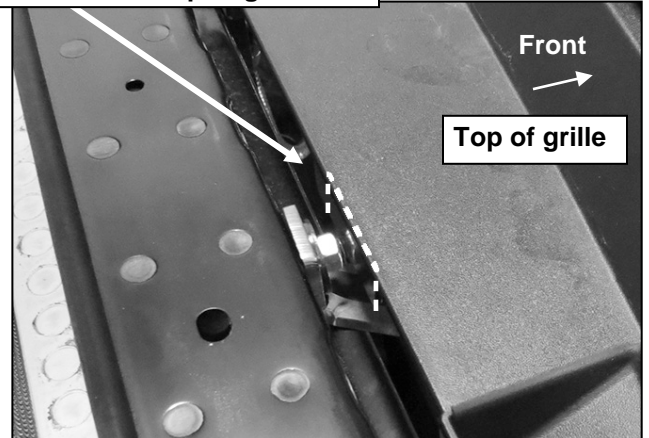

**(Fig 9) Mark plastic to cut to clear Top Bracket**

Top Support Brackets attach to holes (arrows) in radiator cross-member (see Fig 8)

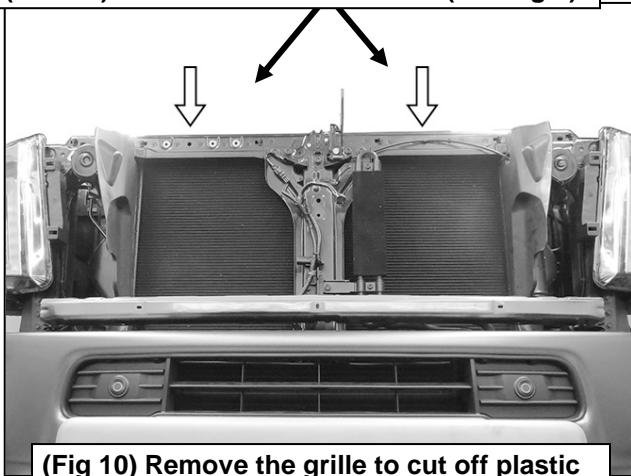

**(Fig 10) Remove the grille to cut off plastic tabs to clear Support Brackets. Once properly cut, Reattach grille at bottom only**

- (3) 12mm x 35mm Hex Bolts
- (6) 12mm Flat Washers
- (3) 12mm Lock Washers
- (3) 12mm Hex Nuts

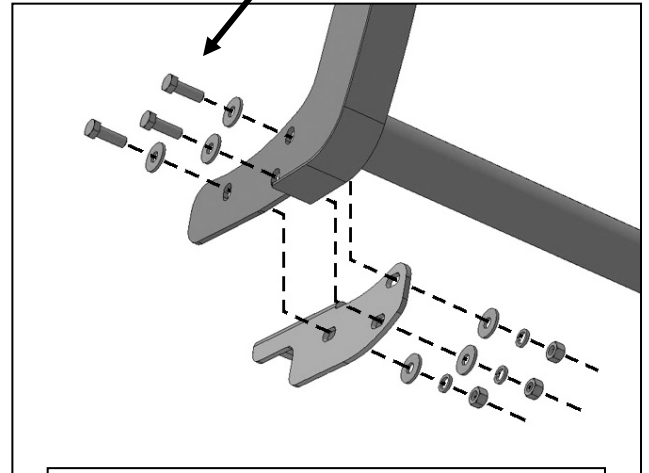

**(Fig 11) Attach Grille Guard to Frame Brackets (passenger/right side illustrated)**

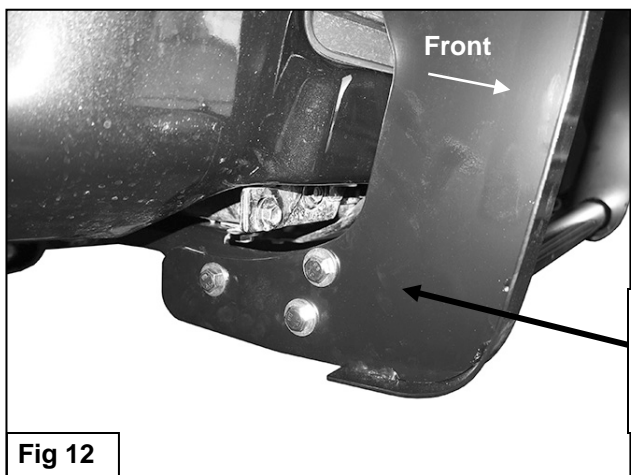

- (3) 12mm x 35mm Hex Bolts
- (6) 12mm Flat Washers
- (3) 12mm Lock Washers
- (3) 12mm Hex Nuts

**Fig 12**

### Passenger/right side installation pictured

8mm Flat Washer  
8mm Lock Washer  
8mm Hex Nut

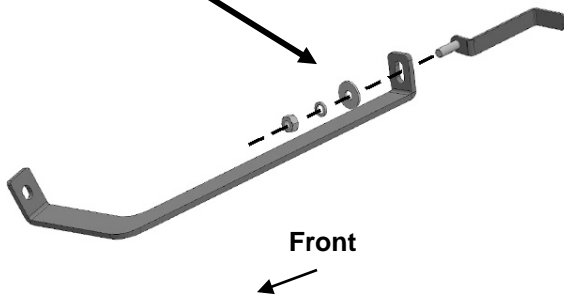

(Fig 13) Passenger/right Top Support Bracket

8mm Z Bolt Plate  
8mm Flat Washer  
8mm Lock Washer  
8mm Hex Nut

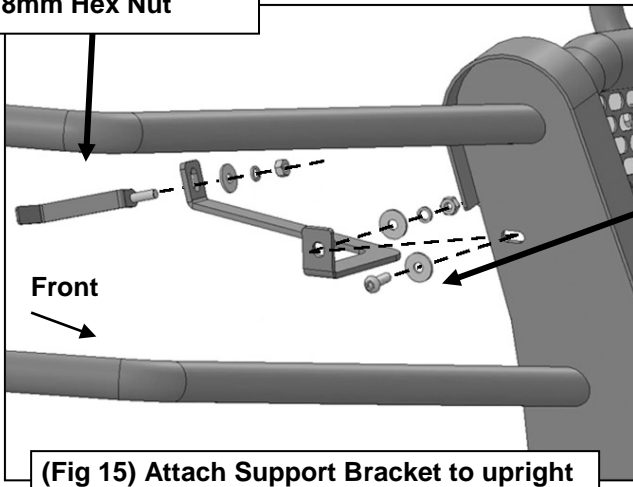

(Fig 15) Attach Support Bracket to upright

8mm x 25mm Button  
Head Bolt  
(2) 8mm Flat Washers  
8mm Lock Washer  
8mm Hex Nut

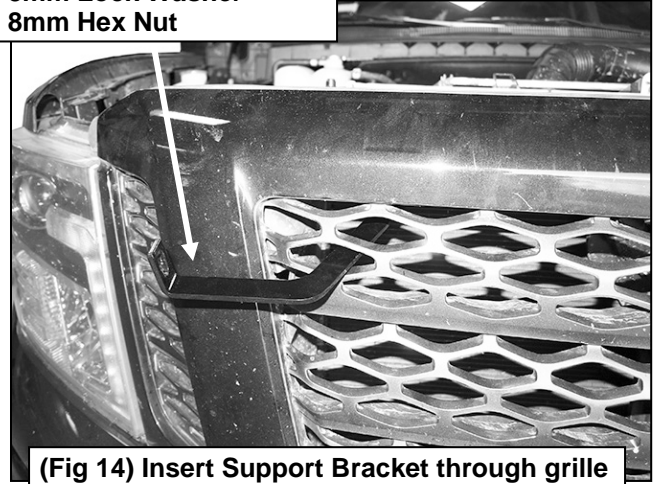

(Fig 14) Insert Support Bracket through grille

8mm x 25mm Button  
Head Bolt  
(2) 8mm Flat Washers  
8mm Lock Washer  
8mm Hex Nut

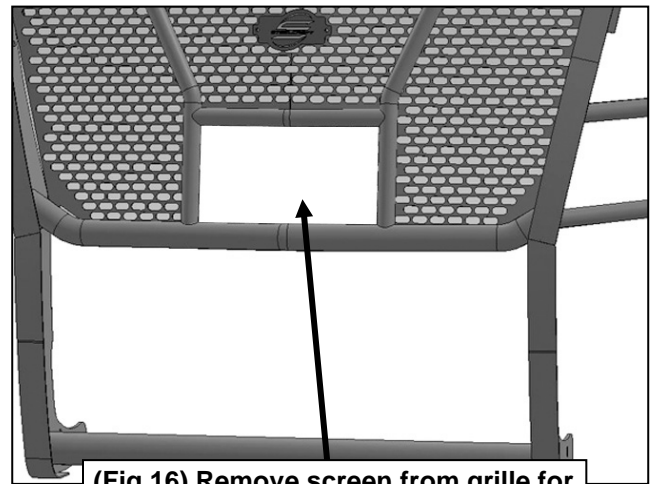

(Fig 16) Remove screen from grille for models with grille mounted camera



Installation Complete