



INSTALLATION INSTRUCTIONS

**3 INCH SIDEBAR
2019 FORD RANGER SUPERCAB**

PARTS LIST:

1	Driver/Left Sidebar	12	10-1.5mm x 25mm Hex Bolts
1	Passenger/Right Sidebar	12	10mm Lock Washers
2	Front Mounting Brackets	12	10mm x 27mm x 3mm Flat Washers
4	Center/Rear Mounting Brackets	12	8-1.25mm x 25mm Combo Bolts

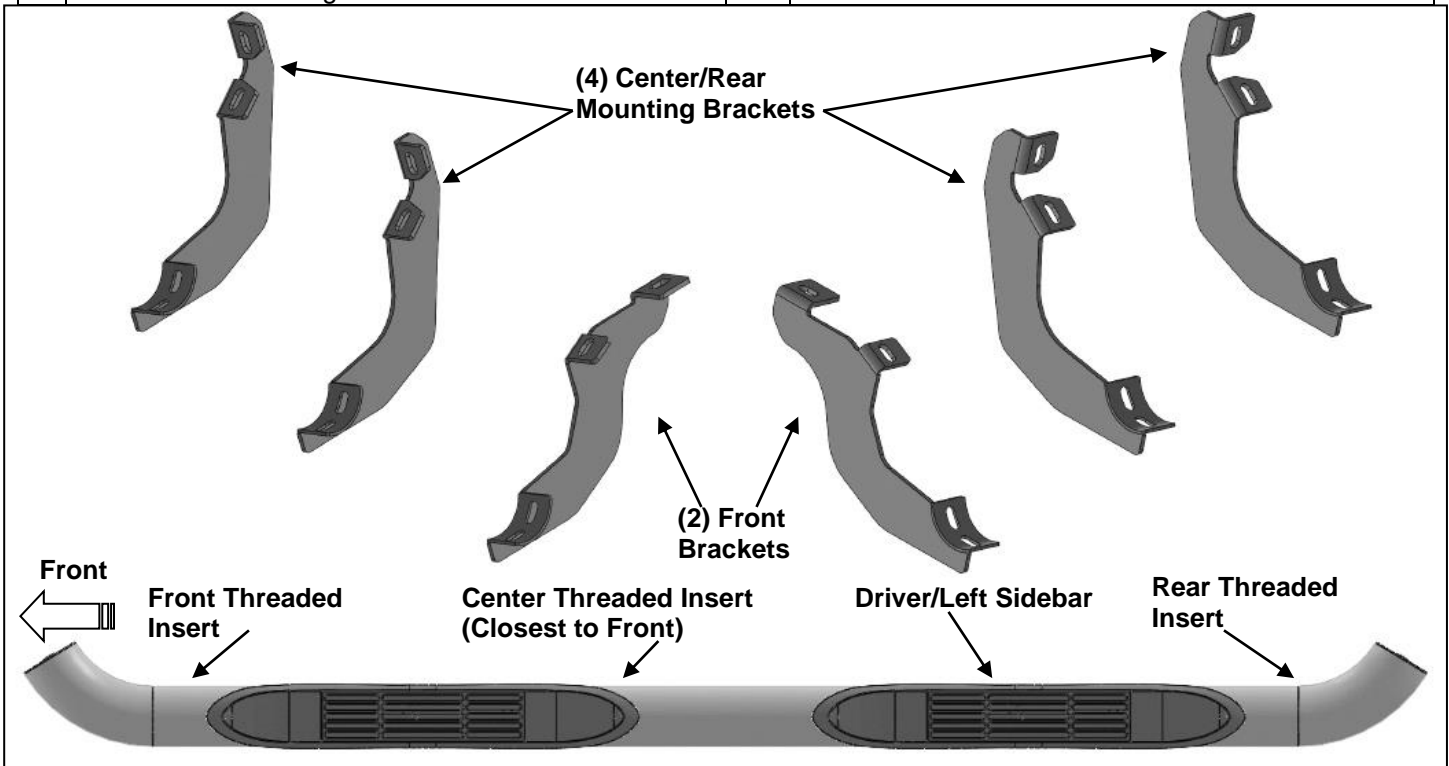

PROCEDURE:

1. REMOVE CONTENTS FROM BOX. VERIFY ALL PARTS ARE PRESENT. READ INSTRUCTIONS CAREFULLY BEFORE STARTING INSTALLATION.
2. Starting from underneath the Driver/Left side inner rocker panel, locate the threaded mounting holes on the rocker panel, **(Figure 1)**. Remove the plastic plugs covering the mounting holes. Select the Passenger/Right Front Mounting Bracket, **(Figure 2)**. Attach with (2) 10mm Hex Bolts, (2) 10mm Lock Washers and (2) 10mm Flat Washers, **(Figures 2 & 3)**. Do not tighten hardware at this time.
3. Locate the Center threaded mounting holes. Select (1) Center/Rear Mounting Bracket. Attach with (2) 10mm Hex Bolts, (2) 10mm Lock Washers and (2) 10mm Flat Washers, **(Figures 4—6)**. Do not tighten hardware at this time.
4. Repeat **Step 3** to install Rear Mounting Bracket, **(Figures 5, 7 & 8)**.
5. Unwrap the Driver/Left Sidebar. Attach Sidebar to the mounting brackets with (6) 8mm Combo Bolts. Do not tighten hardware at this time, **(Figures 9—12)**. **IMPORTANT:** Do not slide or rotate Sidebar on cradles, or damage to the finish may result.
6. Level and adjust Sidebar and tighten all hardware.
7. Repeat **Steps 2—6** for Passenger/Right side installation.
8. Do periodic inspections to the installation to make sure that all hardware is secure and tight.

To protect your investment, Do not use any type of polish or wax that may contain abrasives that could damage the finish. **For Stainless Steel,** Aluminum polish may be used to polish small scratches and scuffs on the finish. Mild soap may be used to clean the Sidebar.

Driver/Left side Installation Pictured

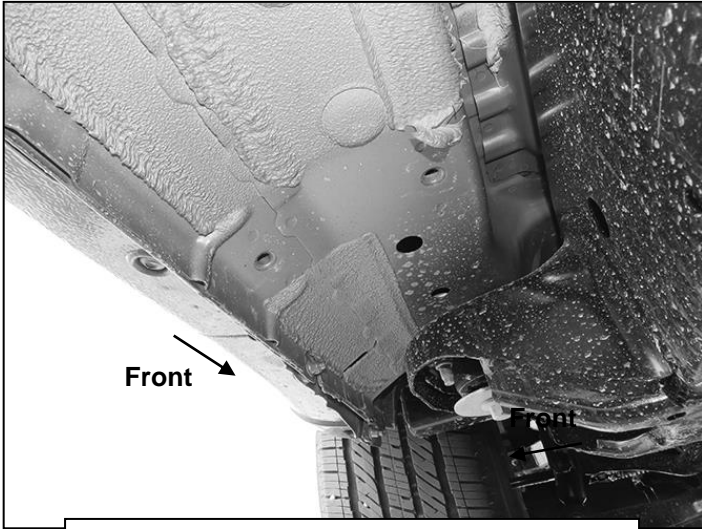

(Fig 1) Driver/Left Front mounting Location

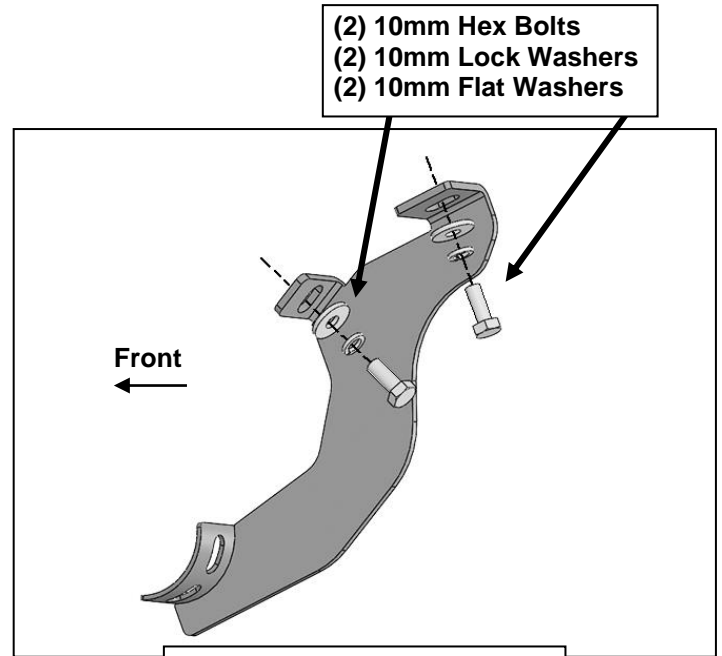

(Fig 2) Driver/Left Front Mounting Bracket installation

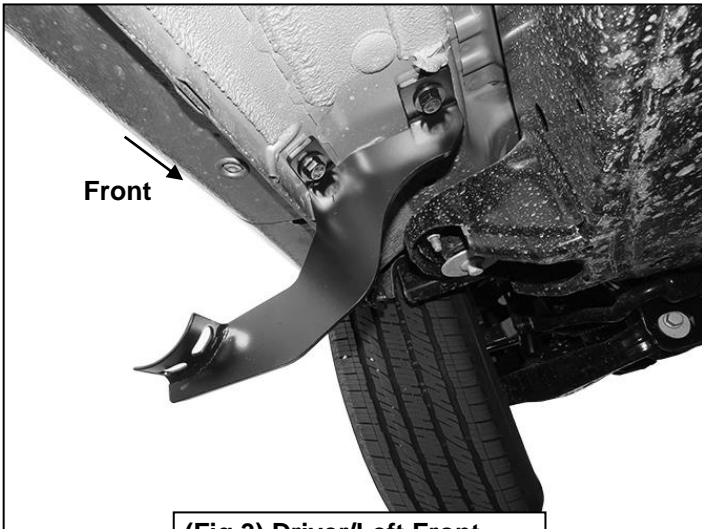

(Fig 3) Driver/Left Front Mounting Bracket attached

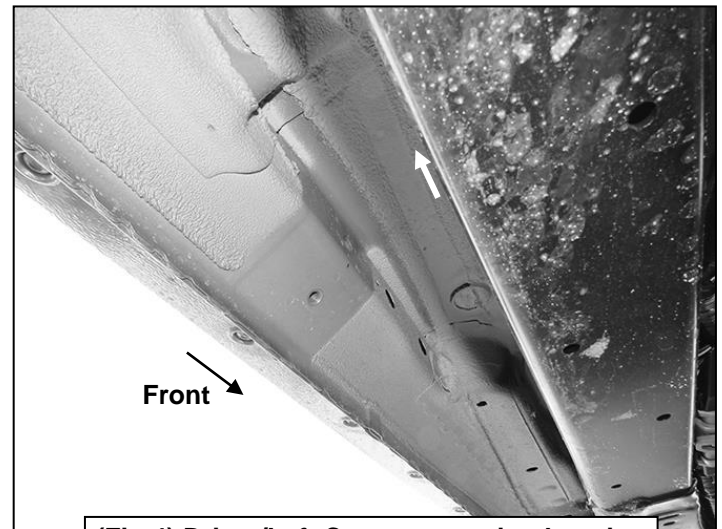

(Fig 4) Driver/Left Center mounting location

Driver/Left side Installation Pictured

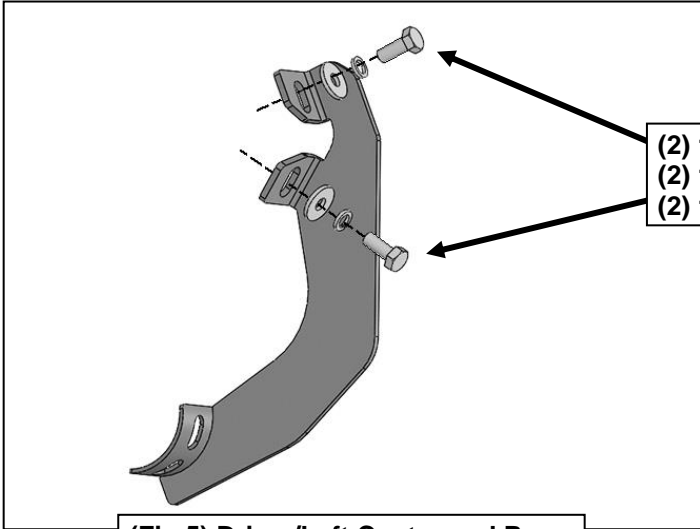

(Fig 5) Driver/Left Center and Rear mounting Bracket installation

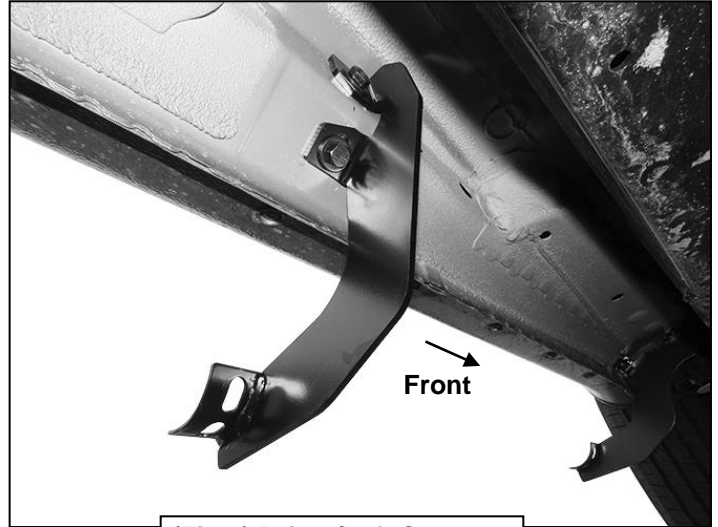

(Fig 6) Driver/Left Center Mounting Bracket installed

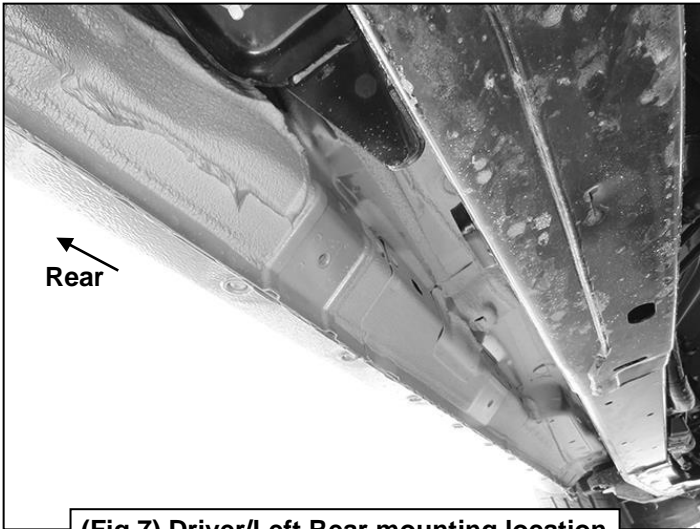

(Fig 7) Driver/Left Rear mounting location

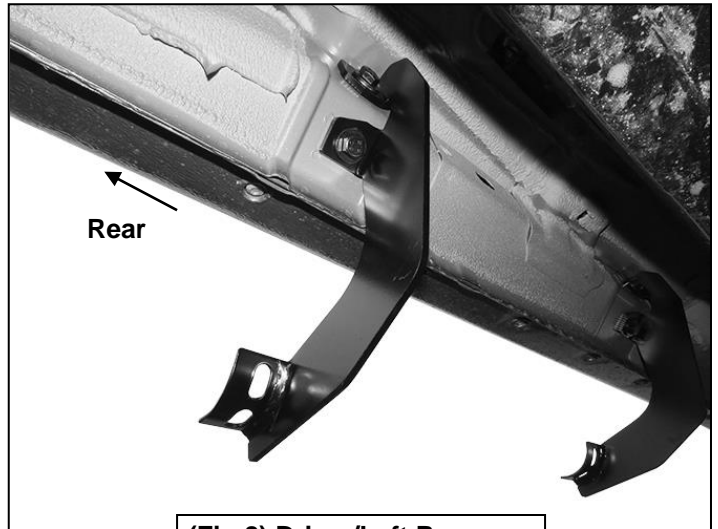

(Fig 8) Driver/Left Rear Mounting Bracket installed

Driver/Left side Installation pictured

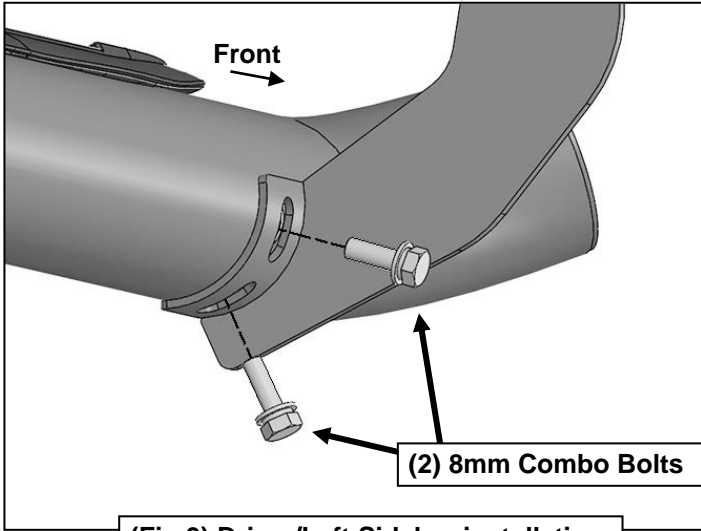

(Fig 9) Driver/Left Sidebar installation

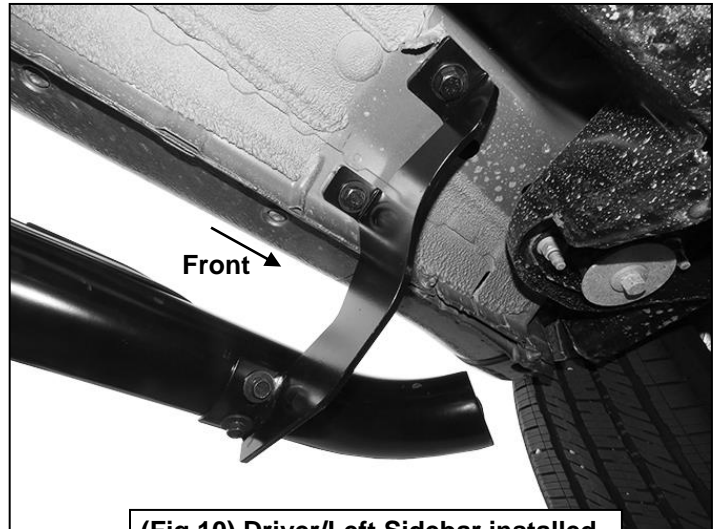

(Fig 10) Driver/Left Sidebar installed on Front Mounting Bracket

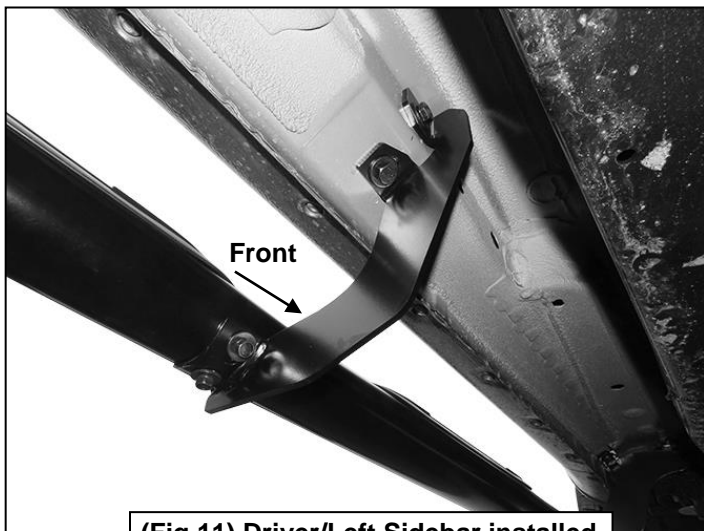

(Fig 11) Driver/Left Sidebar installed on Center Mounting Bracket

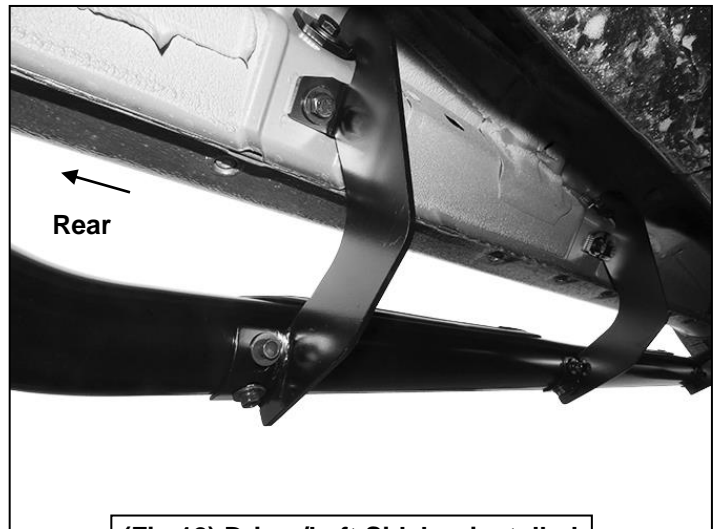

(Fig 12) Driver/Left Sidebar installed on Rear Mounting Bracket