

PARTS LIST:

Qty	Description	Qty	Description
1	Bull Bar	4	10mm x 34mm Large Flat Washers
1	Driver/Left Frame Mounting Bracket	8	10mm x 30mm STD Flat Washers
1	Passenger/Right Frame Mounting Bracket	6	10mm Nylon Lock Nuts
2	Bull Bar Mounting Brackets	4	8-1.25mm x 35mm Hex Bolts
4	Large Spacer Washers	4	8mm x 24mm OD x 2mm Flat Washers
2	10-1.50mm x 120mm x 30mm Hex Bolts	4	8mm Lock Washers
4	10-1.50mm x 30mm Hex Bolts		

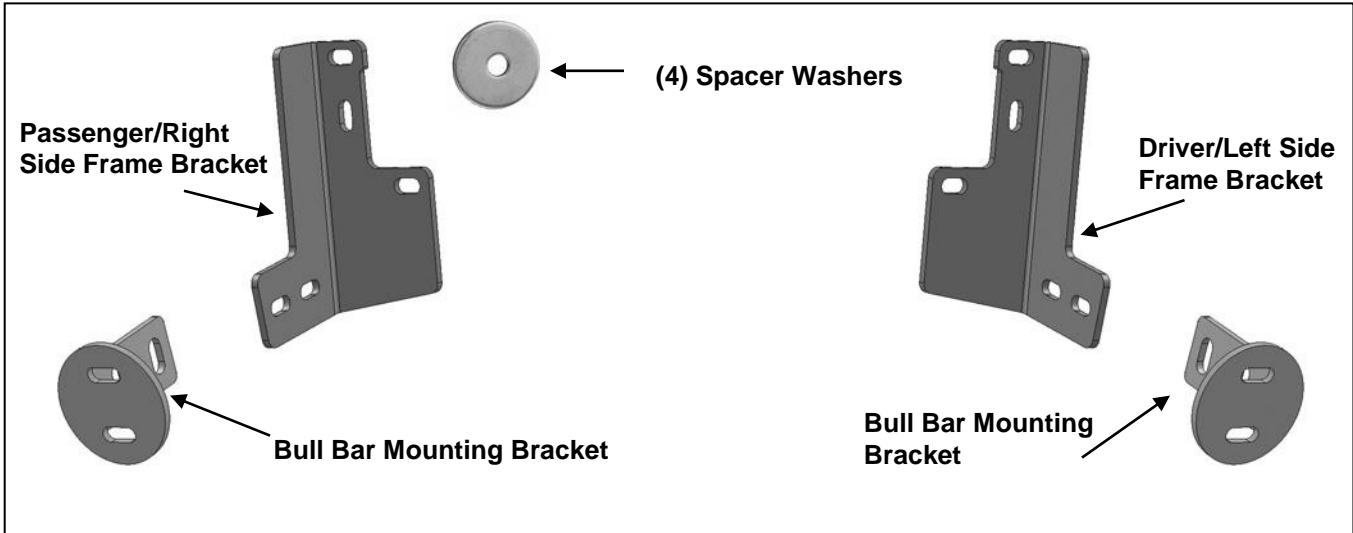

PROCEDURE:

REMOVE CONTENTS FROM BOX. VERIFY ALL PARTS ARE PRESENT. READ INSTRUCTIONS CAREFULLY BEFORE STARTING INSTALLATION. NOT COMPATIBLE WITH OPTIONAL FULL COVERAGE FACTORY ALUMINUM SKID PLATE. OPTIONAL SKID PLATE MUST BE REMOVED AND CANNOT BE REINSTALLED. CUTTING IS REQUIRED.

NOTE: It may be necessary to remove/relocate front license plate and license plate bracket. It is not required, but strongly recommended. If local/state law requires a front license plate, license plate relocation kit is available.

1. From under the front of the vehicle, remove the plastic lower air dam from the front bumper cover, **(Figure 1)**.
2. Start installation at the passenger side, front of the vehicle. Remove the (2) outer factory hex nuts attaching the bumper mount to the end of the frame, **(Figure 2)**. **NOTE:** It may be necessary to temporarily remove the factory tow hook from the passenger side.
3. Select the passenger side frame mounting bracket, **(Figure 3)**. Slide the Bracket over the (2) threaded studs. Secure the Bracket to the studs with the factory hex nuts, **(Figures 4 & 9)**. Leave hardware loose at this time.
4. Slide (1) Large Spacer Washer between the Mounting Bracket and the frame cross member, **(Figures 5 & 6)**. Insert (1) 10mm x 120mm Hex Bolt with (1) 10mm x 34mm OD Large Flat Washer and (1) Large Spacer Washer into and through the hole in the back of the cross member. Make sure the Spacer Washer is against the cross member covering the large hole, **(Figures 7 & 9)**. Push the long bolt through the outer Spacer Washer and Frame Bracket. Secure the Bracket to the Bolt with (1) 10mm x 34mm Large Flat Washer and (1) 10mm Nylon Lock Nut, **(Figures 8 & 9)**. Leave hardware loose at this time. **NOTE:** Trim plastic splashguards attached to the bottom corners of the bumper as necessary to clear brackets.
5. Repeat **Steps 2—4** for driver side Bracket installation.

**3" BULL BAR
2016 TOYOTA TACOMA**

6. Next, hold the plastic air dam up in position against the Mounting Brackets. Trace the location of the two brackets onto the back of the air dam, **(Figure 10)**. Use a sharp knife or hacksaw blade to carefully cut two slots to clear the brackets. **IMPORTANT:** Do not cut through the top or bottom edge of the air dam. Do not cut off the mounting tabs from the top of the air dam. For best results, check all measurements before cutting, start with a small opening and slowly enlarge the slots until Brackets clear the air dam. Reinstall the air dam but leave hardware loose at this time.
7. Next, carefully unwrap the Bull Bar. Select (1) Bull Bar Mounting Bracket, **(Figure 11)**. Attach the Bracket to the end of the Bull Bar with (2) 8mm x 35mm Hex Bolts, (2) 8mm Lock Washers and (2) 8mm Flat Washers. Center the mounting flange on the Bracket with the end of the tube on the Bull Bar. Snug but do not tighten hardware. Repeat this Step to install the driver side Bull Bar Bracket onto the Bull Bar.
8. With assistance, line up the mounting tabs on the Bull Bar with the outside of the (2) previously installed Frame Mounting Brackets. Bolt the Bull Bar to the Frame Mounting Brackets with the included (4) 10mm x 30mm Hex Bolts, (8) 10mm x 30mm STD Flat Washers and (4) 10mm Nylon Lock Nuts, **(Figures 12 & 13)**. Snug but do not tighten hardware at this time.
9. Level and adjust the Bull Bar properly and tighten all hardware including factory hardware attaching the air dam to the vehicle. Reinstall the tow hook if removed.
10. Do periodic inspections to the installation to make sure that all hardware is secure and tight.

To protect your investment, wax this product after installing. Regular waxing is recommended to add a protective layer over the finish. Do not use any type of polish or wax that may contain abrasives that could damage the finish.

For stainless steel: Aluminum polish may be used to polish small scratches and scuffs on the finish. Mild soap may be used also to clean the Bull Bar.

For gloss black finishes: Mild soap may be used to clean the Bull Bar.

Passenger Side Installation Pictured

Remove (2) factory hex nuts on outside of frame

Spacer Washer will cover this opening in the end of the frame



(Fig 1) Remove air dam from bottom of bumper

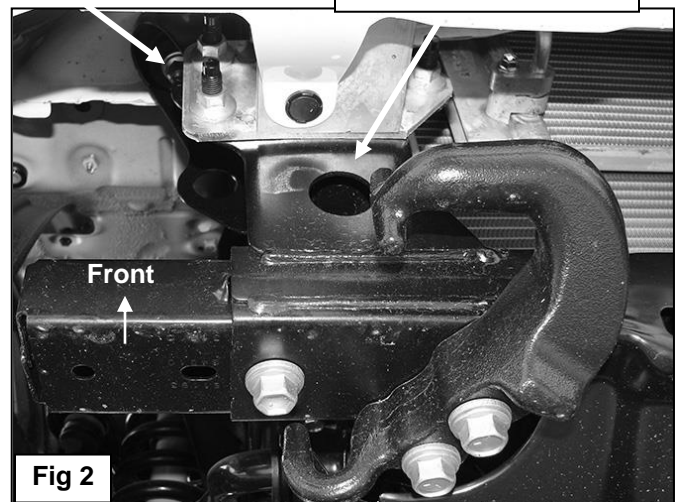

Fig 2

Passenger Side Installation Pictured

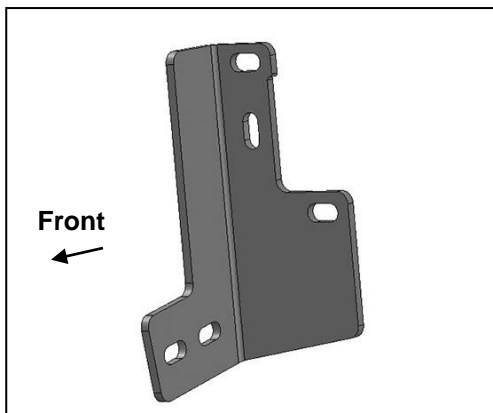

Fig 3 Passenger/right frame Bracket

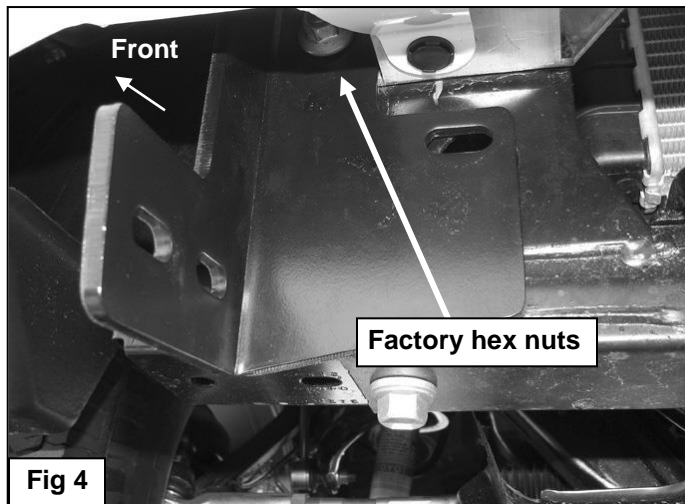
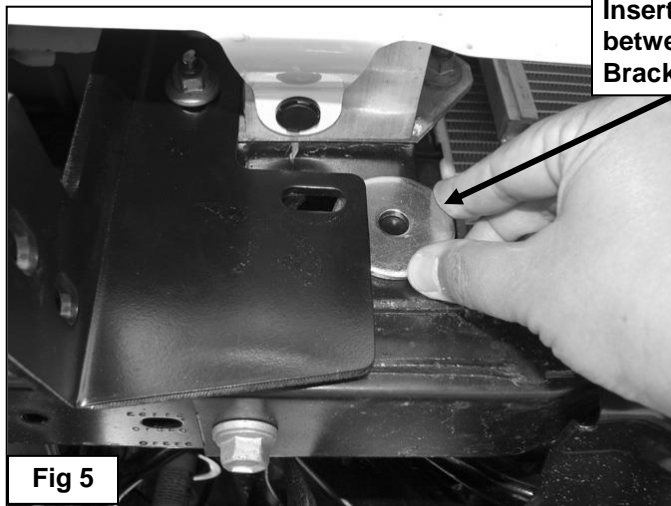

Fig 4



Insert Spacer Washer
between the Mounting
Bracket and the frame

Fig 5

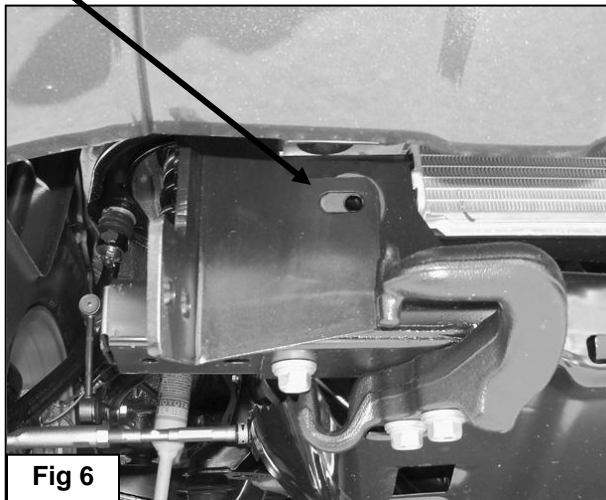
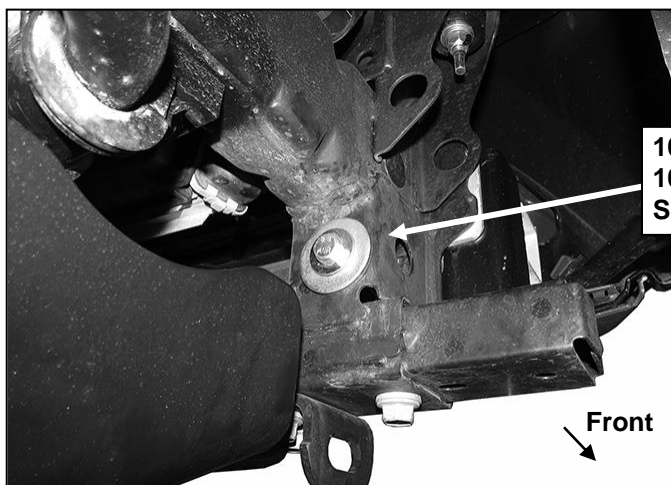

Fig 6



10mm x 120mm Hex Bolt
10mm x 34mm Large Flat Washer
Spacer Washer

(Fig 7) Passenger side pictured from behind bumper

Passenger Side Installation Pictured

10mm x 34mm Large Flat Washer
10mm Nylon Lock Nut
Spacer Washer (between Bracket and frame)

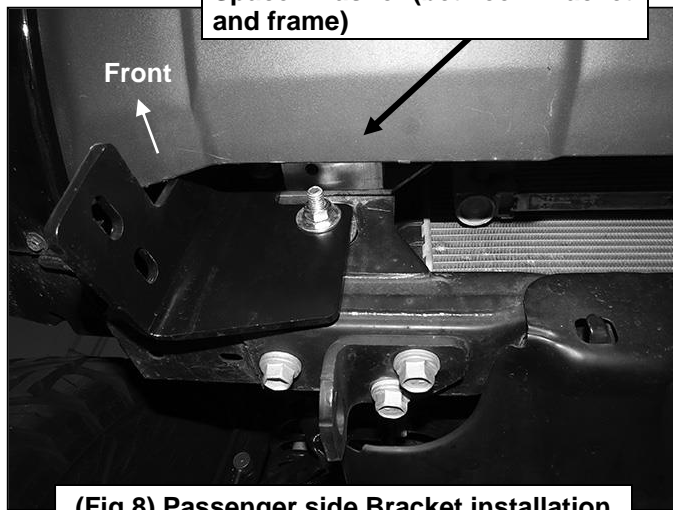

(Fig 8) Passenger side Bracket installation

10mm x 120mm Hex Bolt
10mm x 34mm Large Flat Washer

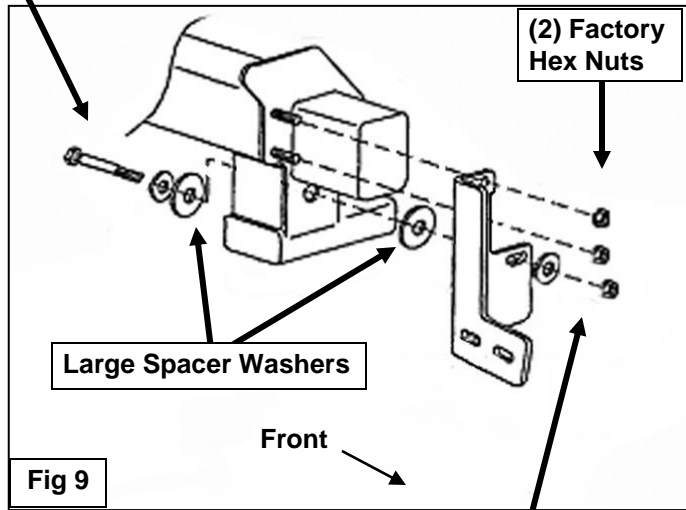

10mm x 34mm Large Flat Washer
10mm Nylon Lock Nut



(Fig 10) Dashed lines represent approximate area to cut from air dam and are illustrated for example only

Passenger side installation pictured

