

**PARTS LIST:**

1	Bull Bar	4	12-1.75mm x 35mm Hex Bolts
1	Driver/Left Frame Mounting Bracket	8	12mm Lock Washers
1	Passenger/Right Frame Mounting Bracket	12	12mm x 32mm OD x 3mm Flat Washers
2	50mm x 90mm x 9mm Spacer Plates	6	12mm Hex Nuts
2	12-1.75 x 35mm Bolt Plates	1	5mm x 25mm Screw
2	12-1.75mm Nut Plate	2	5mm x 10mm OD x 1mm Flat Washers
2	12-1.75mm x 50mm Hex Bolts	1	5mm Nylon Lock Nut

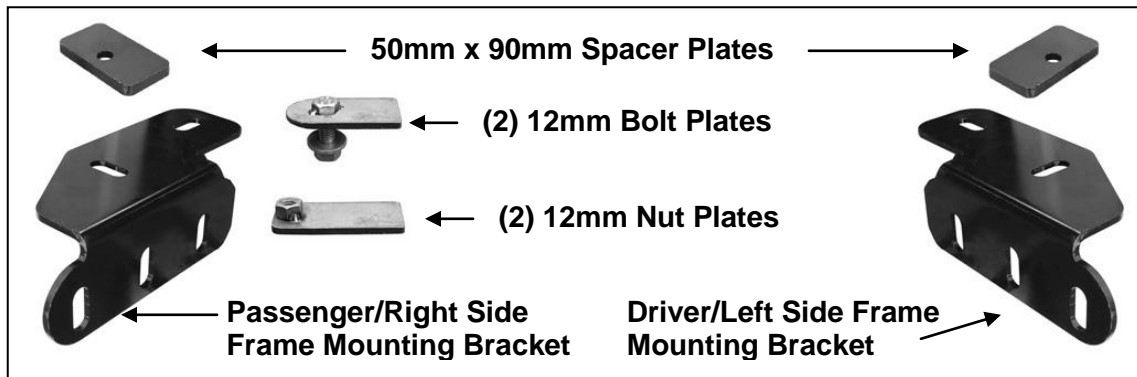

**PROCEDURE:**

1. REMOVE CONTENTS FROM BOX. VERIFY ALL PARTS ARE PRESENT. READ INSTRUCTIONS CAREFULLY BEFORE STARTING INSTALLATION. ASSISTANCE IS RECOMMENDED. CUTTING IS REQUIRED. DRILLING IS OPTIONAL.
2. Start installation under the driver side front of the vehicle, (**Figure 1**). Insert (1) 12mm Nut Plate into the large oval opening in the bottom of the frame channel and slide it forward in the frame with the flat side down against the frame channel and welded nut up, (**Figure 2B**). Line up the threaded hole in the Nut Plate with the factory hole at the front of the frame, (**Figure 2A**). Next, insert (1) 12mm Bolt Plate into the large oval opening and center the threaded bolt in the oval hole, (**Figure 2C**).
3. Select the driver side Frame Mounting Bracket. Hold the Mounting Bracket up in position against the bottom of the frame and over the threaded bolt on the Bolt Plate, (**Figure 3A**). Secure the Bracket to the Bolt Plate with (1) 12mm Flat Washer, (1) 12mm Lock Washer and (1) 12mm Hex Nut. Leave hardware loose at this time. Slide (1) Spacer Plate between the frame channel and the Bracket, (**Figure 3A & 3B**). Insert (1) 12-1.75mm x 35mm Hex Bolt with (1) 12mm Lock Washer and (1) 12mm Flat Washer through the hole in the Bracket, Spacer Plate and into the Nut Plate, (**Figure 4**). Snug but do not tighten hardware at this time.
4. Move to the passenger side of the vehicle. Determine if the vehicle is equipped with the factory installed fresh air inlet in the plastic bumper cover.
  - a. **Vehicles without air inlet:** Repeat **Steps 2 & 3** for passenger side Frame Mounting Bracket installation, (**Figures 5A, 5B & 5C**).
  - b. **Vehicles equipped with air inlet, (Figure 6):** Repeat **Step 2** to install the 12mm Bolt Plate and 12mm Nut Plate. Hold the Frame Bracket in the approximate position over the Bolt and Nut Plates. Mark the outline of the Bracket onto the mounting tab on the plastic air inlet, (scoop), (**Figure 7**). Remove the inlet and place it on a clean, stable work surface. Use a hacksaw to cut the required material from the mounting area on the inlet. Check the fit often and trim material away as necessary. Do not cut off the mounting tab. Carefully pry off the metal clip and move it as indicated in **Figure 7** or drill a 1/4" hole through the top and bottom of the scoop and replace the clip with the included (1) 5mm x 25mm Screw, (2) 5mm Flat Washers and (1) 5mm Nylon Lock Nuts. Do not over-tighten 5mm hardware. **IMPORTANT!** Any cutting tool may break or shatter. Government regulations require safety glasses & equipment at all times when cutting. Install the Frame Bracket as described in **Step 3**. **NOTE:** Complete the Bull Bar installation before reinstalling the plastic air inlet scoop.

**NOTE:** Before proceeding, it may be considerably easier to remove the plastic bumper cover to cut the slots for the Bull Bar. However, on some models, the bumper cover may be held in place on the ends with factory rivets making removal and reinstallation extremely difficult and best done by a professional, **(Figure 6)**. Determine if the bumper is held in place with rivets, (visible from the outside-below the fog lights), before attempting to remove the bumper cover.

5. Measure the width across the Bull Bar, (mounting tab to mounting tab appx. 36-1/4" to 36-1/2"). Use a tape measure to locate the middle of the plastic bumper cover, **(Figure 8)**. Mark the mid point on the back of the bumper. **NOTE:** You can also locate the mold mark on the back of the bumper to determine the mid point. Place a layer of masking tape on the back of the bumper cover in front of the Frame Mounting Brackets. On the driver side, draw a vertical line on the tape 18" out from the middle of the bumper. Draw a second vertical line 19" out from the middle, **(Figure 8)**. Repeat this Step on the passenger side of the bumper cover.
6. Use the location of the previously installed Frame Mounting Bracket to determine where to draw the top and bottom horizontal lines, **(Figure 9)**. Carefully cut this area out of the bumper cover with a sharp knife or hacksaw, **(Figure 10)**. **IMPORTANT:** Do not cut through the top or bottom edge of the bumper cover. Only remove enough material to clear the mounting tabs on the Bull Bar.
7. Reinstall the bumper cover if removed as described in **Step 4**.
8. With assistance, position the Bull Bar onto the inside of the Mounting Brackets. Attach the Bull Bar to the Mounting Brackets with (4) 12mm x 35mm Hex Bolts, (8) 12mm Flat Washers, (4) 12mm Lock Washers and (4) 12mm Hex Nuts, **(Figure 11)**. Do not tighten at this time.
9. Level and adjust the Bull Bar and tighten all of the hardware.
10. Reinstall the air inlet, (scoop), removed in **Step 4b**. Trim scoop to clear Brackets as necessary.
11. Do periodic inspections to the installation to make sure that all hardware is secure and tight.

**To protect your investment,** wax this product after installing. Regular waxing is recommended to add a protective layer over the finish. Do not use any type of polish or wax that may contain abrasives that could damage the finish.

**For stainless steel:** Aluminum polish may be used to polish small scratches and scuffs on the finish. Mild soap may be used also to clean the Bull Bar.

**For gloss black finishes:** Mild soap may be used to clean the Bull Bar.

### Driver Side installation Pictured

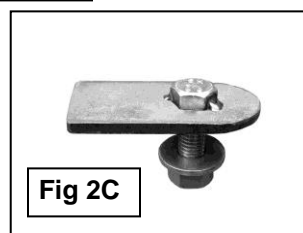
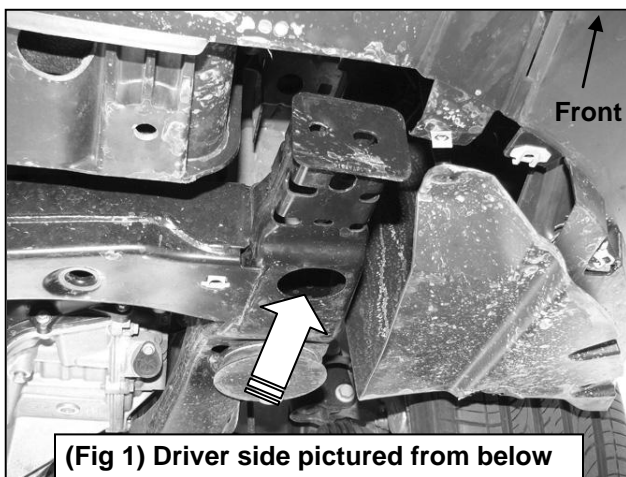

Insert Nut Plate into opening and line up with forward hole in frame

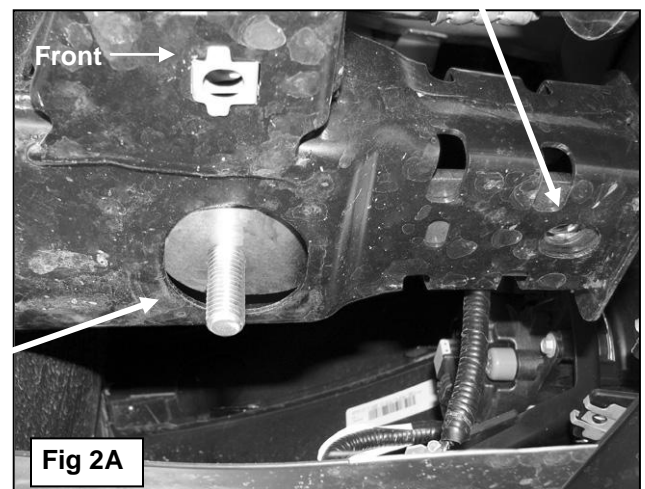
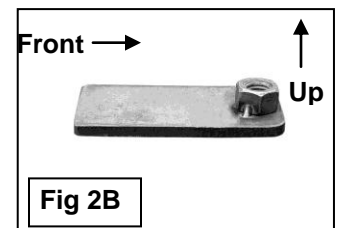

Driver Side Installation Pictured

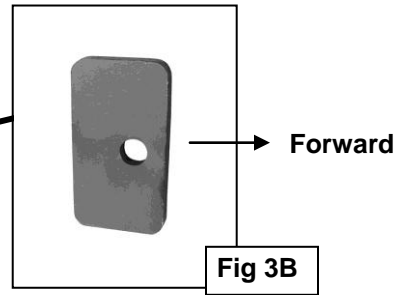
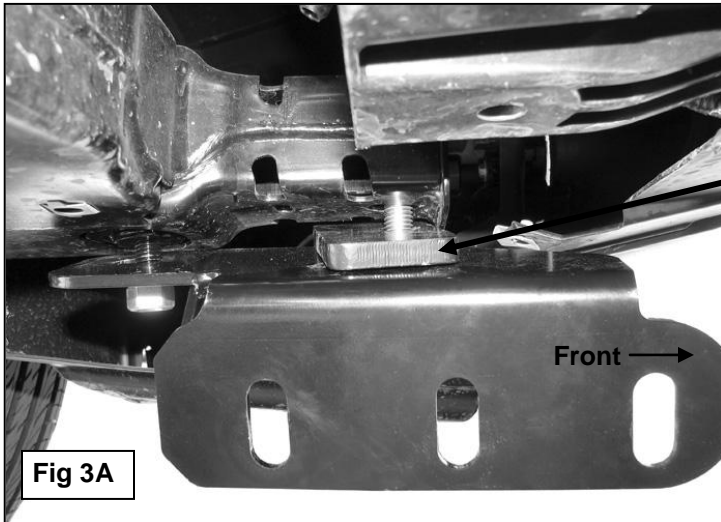

12mm x 50mm Hex Bolt  
12mm Lock Washer  
12mm Flat Washer  
Spacer Plate

12mm Lock Washer  
12mm Flat Washer  
12mm Hex Nut

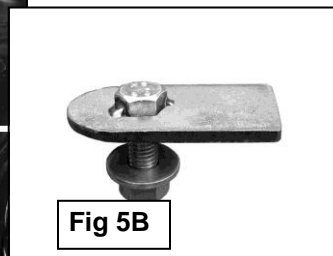
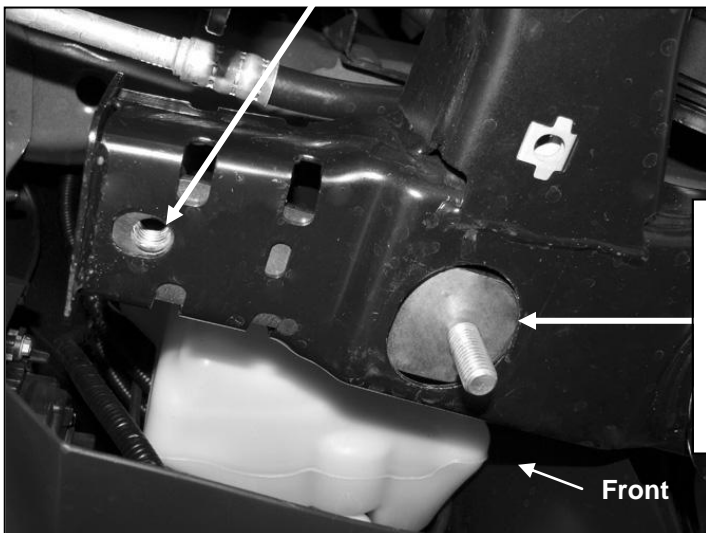
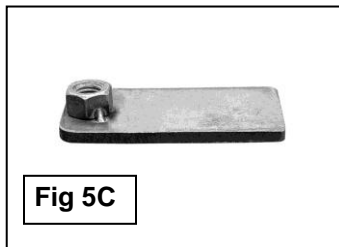
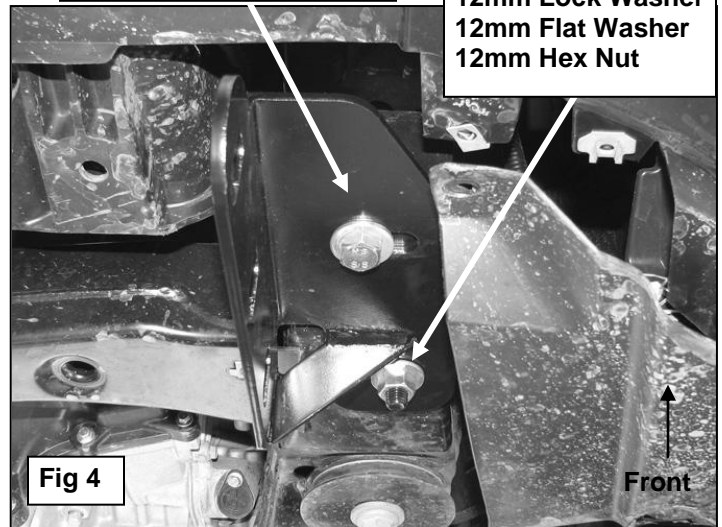

(Fig 5A) Passenger side installation pictured

**Passenger Side Installation Pictured**

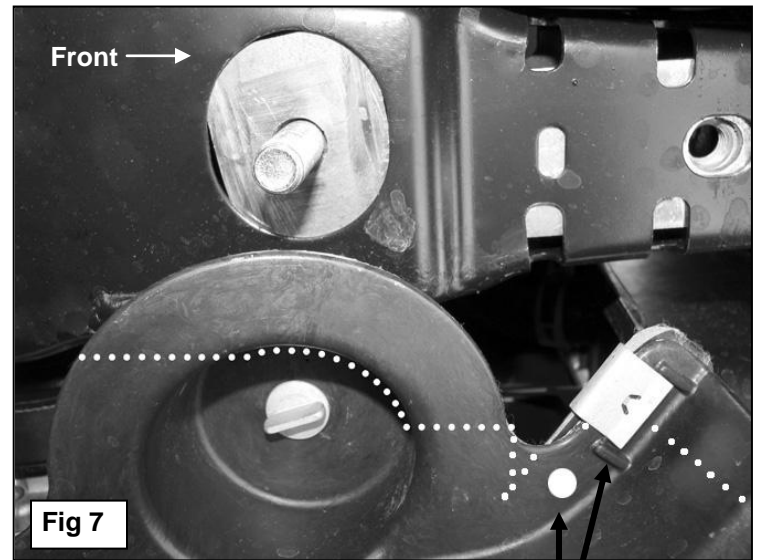
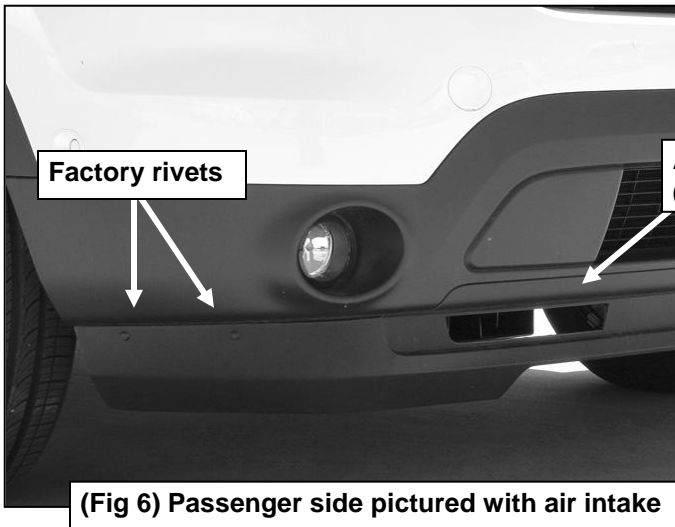

Illustrations, diagrams and measurements provided for example only. It is the installer's responsibility to determine exact cuts/modifications to the vehicle required for proper installation.

Move metal clip to here (See Dot) after cutting OR drill a 1/4" hole and replace the clip with the included:  
(1) 5mm x 25mm Screw  
(2) 5mm Flat Washers  
(1) 5mm Nylon Lock Nut

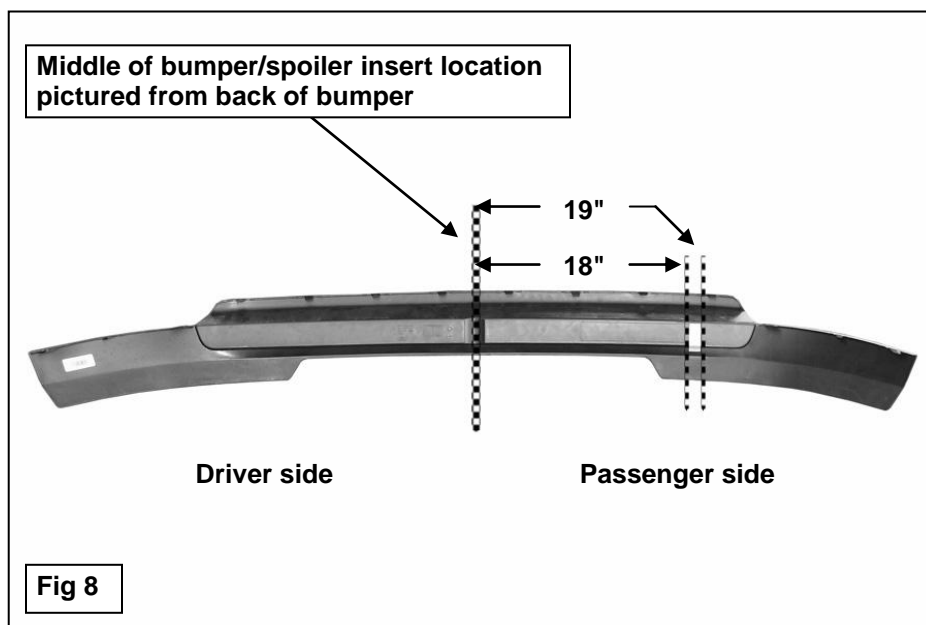

**Passenger Side Installation Pictured**

Illustrations, diagrams and measurements provided for example only. It is the installer's responsibility to determine exact cuts/modifications to the vehicle required for proper installation.

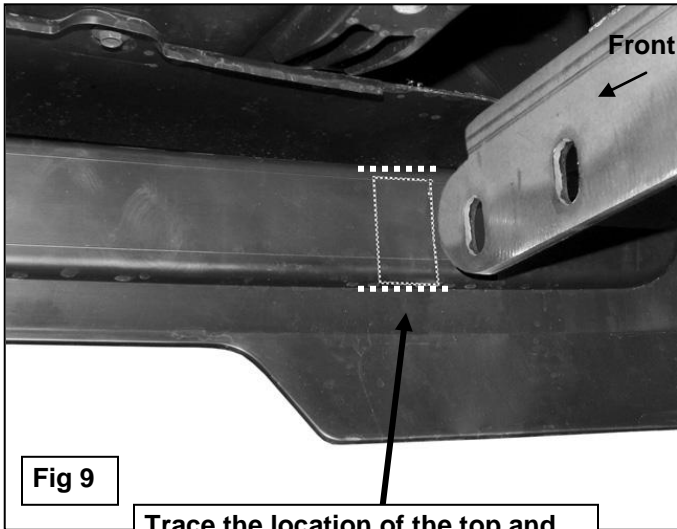

**Fig 9**

Trace the location of the top and bottom of the Frame Bracket onto back of spoiler and cut out to clear mounting tabs on Bull Bar

- (2) 12mm x 35mm Hex Bolts
- (4) 12mm Flat Washers
- (2) 12mm Lock Washers
- (2) 12mm Hex Nuts

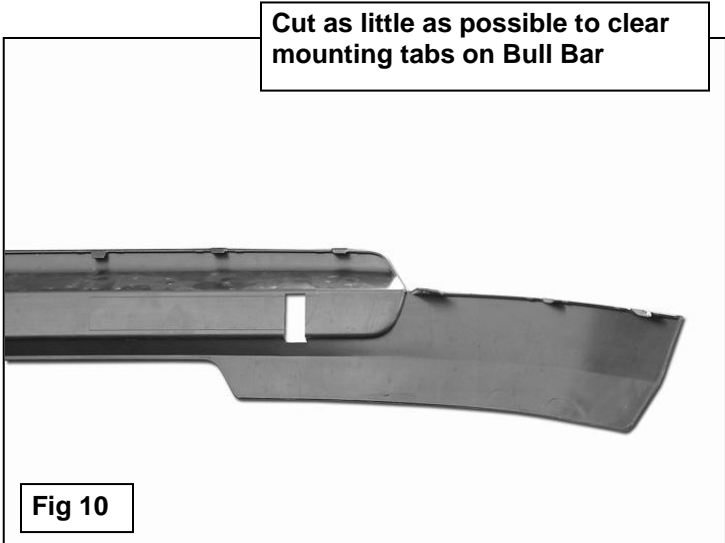

**Fig 10**

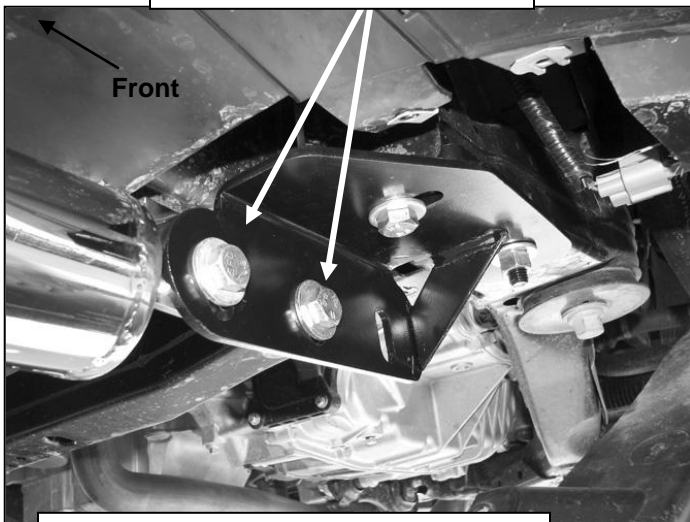

**(Fig 11) Driver side installation pictured with lower bumper removed**



**Complete Installation**