

# INSTALLATION INSTRUCTIONS

## GRILLE GUARD 05-11 NISSAN XTERRA

### PARTS LIST:

1	Grille Guard	6	12-1.75mm x 35mm Hex Head Bolts
1	Driver/Left Mounting Bracket	16	12mm ID x 32mm OD x 3mm Flat Washers
1	Passenger/Right Mounting Bracket	10	12mm Lock Washers
1	Driver/Left Short Top Bracket (fits 05-08)	6	12mm Hex Nuts
1	Passenger/Right Short Top Bracket (fits 05-08)	4	6-1.00mm x 30mm Button Head Bolts
1	Driver/Left Tall Top Bracket (fits 09)	4	6mm ID x 18mm OD x 1.6mm Flat Washers
1	Passenger/Right Tall Top Bracket (fits 09)	4	6mm Lock Washers
4	12-1.25mm x 40mm Hex Head Bolts (fine thread)		

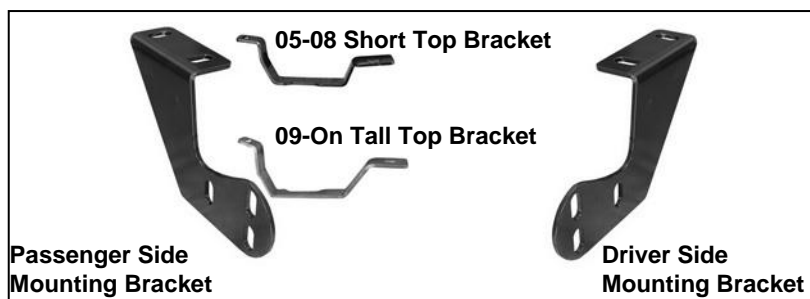

### PROCEDURE:

- 1. REMOVE CONTENTS FROM BOX. VERIFY ALL PARTS ARE PRESENT. READ INSTRUCTIONS CAREFULLY BEFORE STARTING INSTALLATION.**
- From the under the front of the vehicle, remove the factory tow hook located on the passenger side. **NOTE:** You will not be re-installing the tow hook.
- Locate the driver side Mounting Bracket and partially hang it from factory threaded holes in the frame rail using the included (2) 12-1.25 x 40mm Hex Head Bolts (fine thread), (2) 12mm Lock Washers and (2) 12mm Flat Washers (**Figure 1**). Repeat this step for the passenger side installation, (tow hook location). Snug but do not tighten hardware at this time.
- Open the hood and remove the four plastic fasteners across the top of the grille shell, (**Figure 2**). **NOTE:** Use a small flat blade screwdriver to gently pry up the center pin to release the fastener. This will allow you to move the grille shell to insert the Top Bracket through the grille opening, (**Figure 3 & 4**).
- Determine the correct driver side Top Bracket for your application. The Top Brackets are notched to clear the plastic grille. See **Figure 5** for proper identification.
  - 09-On Models:** Use the Tall Top Bracket.
  - 05-08 Models:** Use the Short Top Bracket.
- Gently pull on the grille shell as you insert the Top Bracket through upper corner of the grille, (**Figure 6**). Rotate the Top Bracket into position and line it up with the threaded hole in the radiator support. Attach it to vehicle using the included (1) 6mm x 30mm Button Head Bolt, (1) 6mm Lock Washer and (1) 6mm Flat Washer, (**Figure 7**). Do not tighten at this time.

7. With assistance, position the Grille Guard up to the inside of the Mounting Brackets. Use the included (6) 12mm x 35mm Hex Head Bolts, (6) 12mm Lock Washers, (12) 12mm Flat Washers and (6) 12mm Hex Nuts to attach the Grille Guard to the Mounting Brackets, **(Figure 8)**. Do not tighten at this time.
8. Push the Grille Guard into position and attach it to the Top Brackets using (2) 6mm x 30mm Button Head Bolts, (2) 6mm Lock Washers and (2) 6mm Flat Washers, **(Figure 9)**.
9. Level and adjust the Grille Guard properly and tighten all hardware.
10. Re-install the upper section of the factory grille shell using the fasteners removed in Step 4.
11. Do periodic inspections to the installation to make sure that all hardware is secure and tight.

**To protect your investment**, wax this product after installing. Regular waxing is recommended to add a protective layer over the finish. Do not use any type of polish or wax that may contain abrasives that could damage the finish.

**For stainless steel:** Aluminum polish may be used to polish small scratches and scuffs on the finish. Mild soap may be used also to clean the Grille Guard.

**For gloss black finishes:** Mild soap may be used to clean the Grille Guard.

### Driver Side Installation Pictured

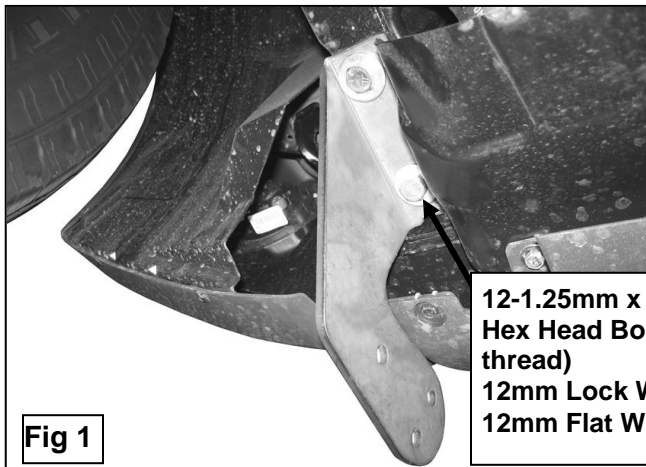

12-1.25mm x 40mm  
Hex Head Bolts (fine  
thread)  
12mm Lock Washers  
12mm Flat Washers

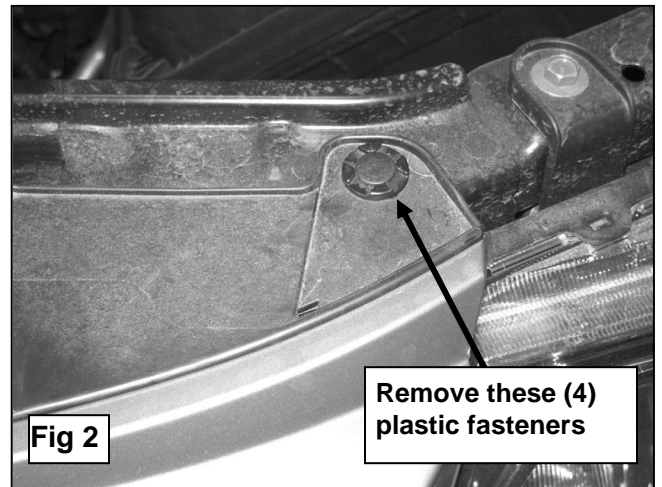

Remove these (4)  
plastic fasteners

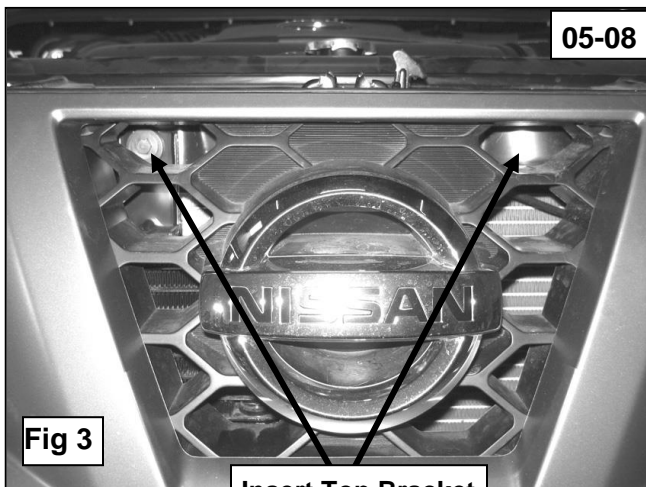

Fig 3

Insert Top Bracket  
through here

05-08 Model Pictured

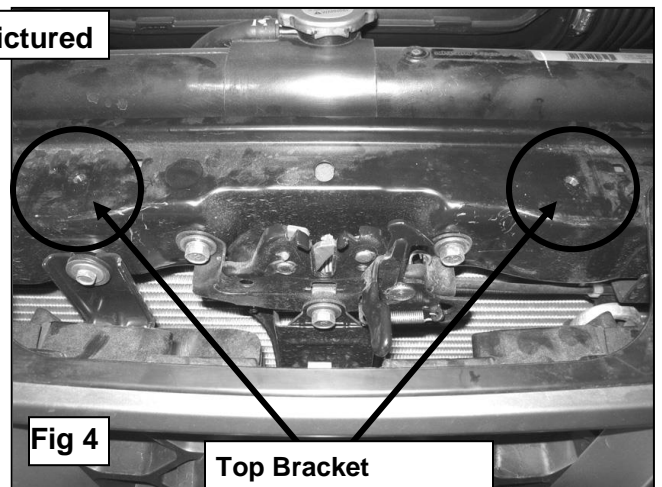
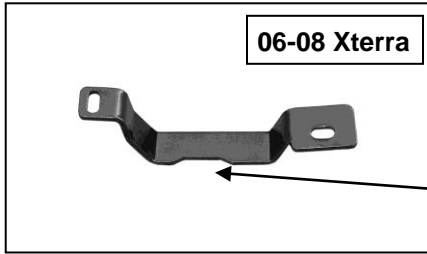

Fig 4

Top Bracket  
Mounting Location

**Driver Side Installation Pictured**



Driver/Left Side Short Top Bracket Pictured  
05-08 Xterra  
Note position of notch for grille clearance



Note: 09 Top Brackets are slightly taller and longer with notch on opposite side from the 05-08 Brackets

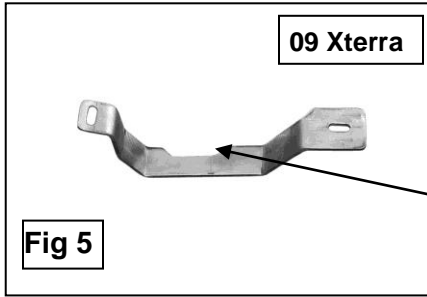

Driver/Left Side Tall Top Bracket Pictured  
09 Xterra  
Note position of notch for grille clearance

