



# INSTALLATION INSTRUCTIONS

## GRILLE GUARD

05-09 NISSAN FRONTIER, 05-07 PATHFINDER

### PARTS LIST:

1	Grille Guard	10	12mm Lock Washers
1	Driver/Left Mounting Bracket	16	12mm ID x 32mm OD x 3mm Flat Washers
1	Passenger/Right Mounting Bracket	6	12-1.75mm Hex Nuts
1	Driver/Left Top Bracket (for 05-08 vehicles)	2	10-1.50mm x 25mm Button Head Allen Bolt
1	Passenger/Right Top Bracket (for 05-08 vehicles)	4	10mm ID x 20mm OD x 2mm Flat Washers
1	Driver/Left Top Bracket (for 09 vehicles)	2	10mm Nylon Lock Nut
1	Passenger/Right Top Bracket (for 09 vehicles)	2	8-.125mm x 25mm Hex Bolts
2	8mm x 25mm Nut Plates	2	8mm Lock Washers
4	12-1.25mm x 40mm Hex Head Bolts (fine thread)	2	8mm x 24mm OD x 2mm Flat Washers
6	12-1.75mm x 35mm Hex Head Bolts		

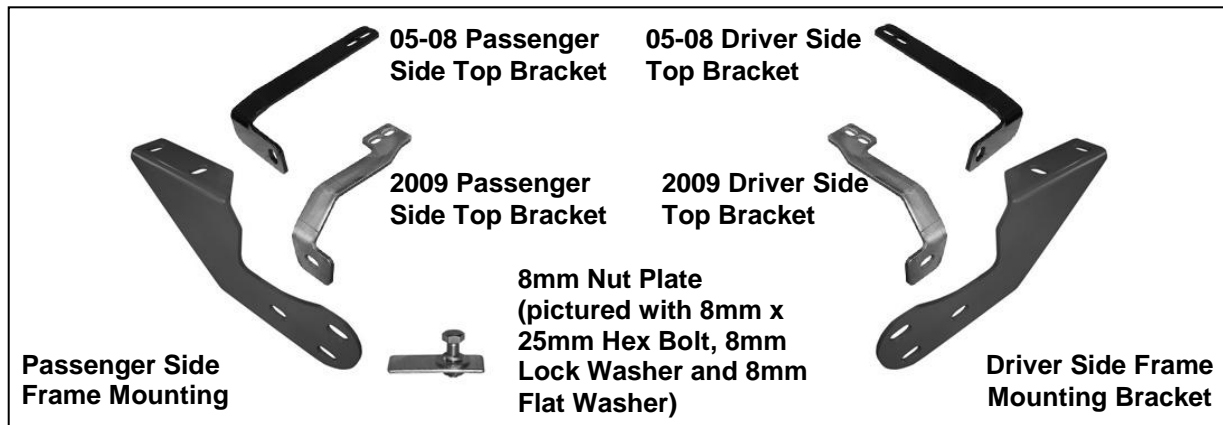

### PROCEDURE:

1. REMOVE CONTENTS FROM BOX. VERIFY ALL PARTS ARE PRESENT. READ INSTRUCTIONS CAREFULLY BEFORE STARTING INSTALLATION. ASSISTANCE IS RECOMMENDED.
2. From under the front of the vehicle, remove the 6 bolts and/or clips securing the center plastic splash guard to the vehicle. Move the splash guard to a clean, stable work surface. Remove the factory tow hook located on the passenger side. **NOTE:** You will not be re-installing tow hook.
3. Locate the driver side Mounting Bracket and partially hang it from factory threaded holes on the frame rail using the included (2) 12-1.25 x 40mm Hex Head Bolts (fine thread), (2) 12mm Lock Washers, and (2) 12mm Flat Washers, (**Figure 1**). Repeat this step for passenger side.
4. Use a hack saw to cut out the driver side tow hook cavity on the splash guard, (**Figure 2**). Once you have cut out the tow hook cavity, place the splash guard up to the vehicle to check for clearance around the Mounting Brackets. If necessary, cut an additional 1/2" x 2" slot in the front side of each tow hook cavity to clear the Mounting Bracket, (**Figure 3**). Once you have cut out the plastic splash guard, reinstall it using the factory hardware.

5. Locate and remove the two plastic clips located in the grille opening. Insert (1) 8mm x 25mm Nut plate into the opening and line up the threaded hole with the hole in the grille opening, **(Figure 4)**.
6. Line up the hole in the Top Bracket, **(see Figure 5 to determine correct Top Bracket)** with the Nut Plate and secure the Top Bracket with (1) 8mm x 25mm Hex Bolt, (1) 8mm Flat Washer and (1) 8mm Lock Washer, **(Figure 6)**. **NOTE:** Two slotted holes are provided to allow for proper fit to the vehicle. Snug but do not tighten hardware at this time. Repeat this step for the passenger side Top Bracket installation.
7. With assistance, position the Grille Guard bolt tabs up to the outside of the Mounting Brackets. Attach the Grille Guard to the Mounting Brackets using the included (6) 12mm x 35mm Hex Head Bolts, (6) 12mm Lock Washers, (12) 12mm Flat Washers and (6) 12mm Hex Nuts, **(Figure 7)**. Do not tighten at this time.
8. Push the Grille Guard back into position and line up the holes in the Top Brackets with the holes in the Grille Guard uprights. **NOTE:** It may be necessary to move the Top Bracket in or outward in the slots to line up properly with the Grille Guard. Attach the Top Brackets to the inside of the Grille Guard uprights using the included (2) 10mm Button Head Allen Bolts, (4) 10mm Flat Washers and (2) 10mm Nylon Lock Nuts, **(Figure 8)**.
9. Align the Grille Guard properly and tighten all hardware. **NOTE: Slowly** open the hood to make sure that the Grille Guard does not interfere with hood opening and closing.
10. Do periodic inspections to the installation to make sure that all hardware is secure and tight.

**To protect your investment**, wax this product after installing. Regular waxing is recommended to add a protective layer over the finish. Do not use any type of polish or wax that may contain abrasives that could damage the finish.

**For stainless steel:** Aluminum polish may be used to polish small scratches and scuffs on the finish. Mild soap may be used also to clean the Grille Guard.

**For gloss black finishes:** Mild soap may be used to clean the product.

### Driver Side Installation Pictured

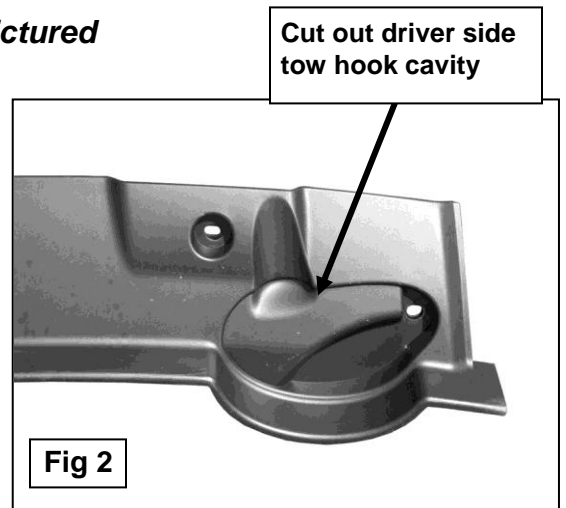
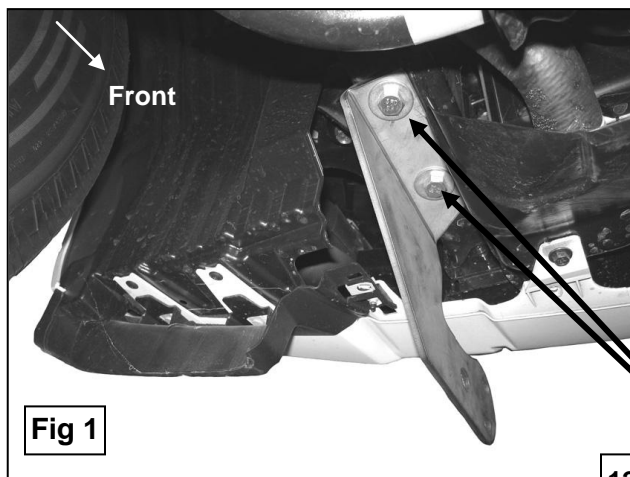

12-1.25mm x 40mm Fine Thread Hex Bolts  
12mm Lock Washers  
12mm Flat Washers

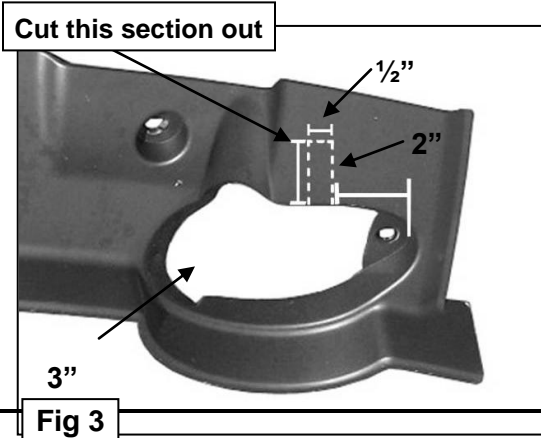

## Driver Side Installation Pictured

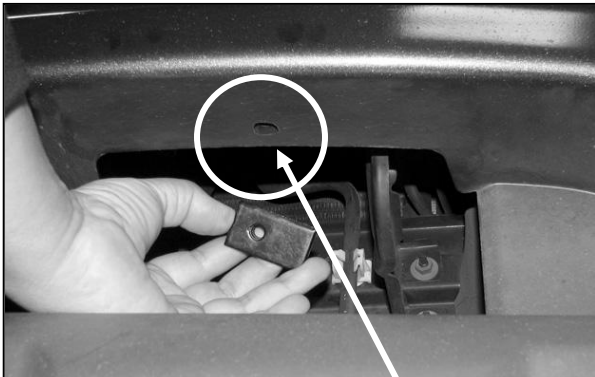

**Fig 4**

Remove plastic factory clips.  
Insert 8mm Nut plate into opening  
in grille and line up with this hole

05-08 driver side Top Bracket



**Fig 5**

09 driver side Top Bracket



8mm x 25mm Hex Bolts  
8mm Lock Washers  
8mm Flat Washers

05-08 driver side Top Bracket  
installation pictured

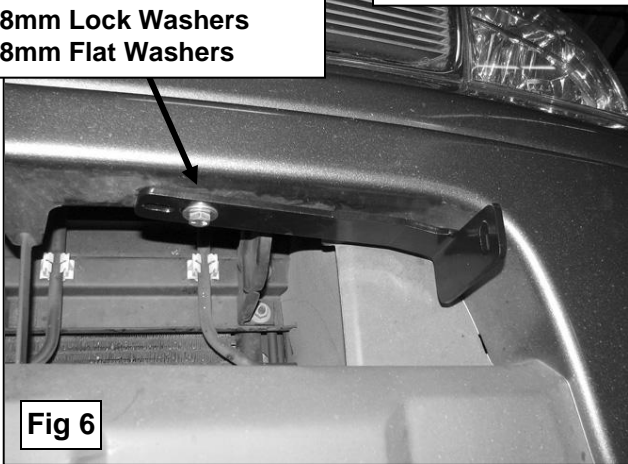

**Fig 6**

12-1.75mm x 35mm Hex Bolts  
12mm Lock Washers  
12mm Hex Nuts  
12mm Flat Washers

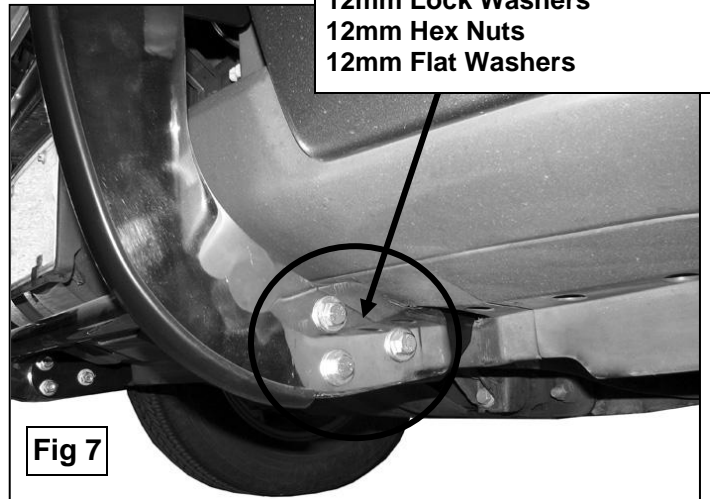

**Fig 7**

(1) 10mm x 25mm Button  
Head Bolt  
(2) 10mm Flat Washers  
(1) 10mm Nylon Lock Nut

05-08 driver side  
Top Bracket  
installation  
pictured

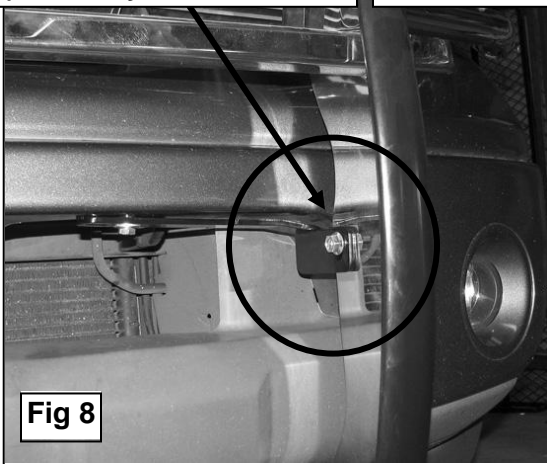

**Fig 8**

Installation Complete

