

PARTS LIST:

1	Grille Guard	4	10-1.5mm x 35mm Bolt Plates
1	Driver/Left Mounting Bracket	6	10-1.5mm x 35mm Hex Bolts
1	Passenger/Right Mounting Bracket	2	10-1.5mm x 30mm Button Head Bolts
1	Driver/Left Top Bracket	20	10mm x 27mm OD x 3mm Flat Washers
1	Passenger/Right Top Bracket	12	10mm Lock Washers
2	10mm Nylon Retainers	12	10mm Hex Nuts

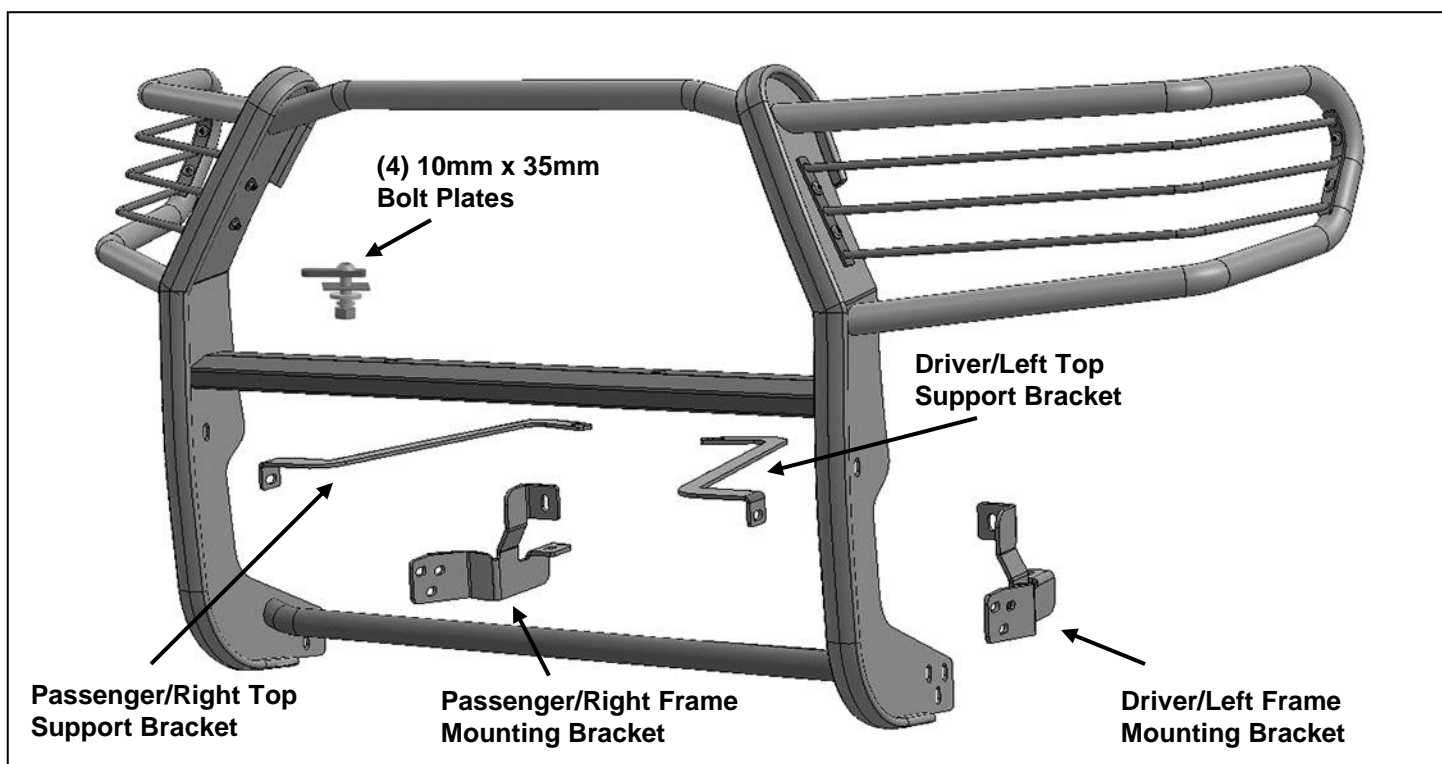

PROCEDURE:

- REMOVE CONTENTS FROM BOX. VERIFY ALL PARTS ARE PRESENT. READ INSTRUCTIONS CAREFULLY BEFORE STARTING INSTALLATION. CUTTING IS REQUIRED. ASSISTANCE IS RECOMMENDED.**
- From under the front of the vehicle, remove the plastic front lower air dam, **(Figure 1)**. Next, remove the passenger side factory hex bolt on the bottom of the frame cross-member, **(Figure 2)**.
- Select (1) 10mm Bolt Plate and Plastic Retainer, **(Figure 3)**. Partially thread the Plastic Retainer onto the Bolt Plate. Insert the Bolt Plate into the large hole in the forward facing end of the frame. Thread the Plastic Retainer down tight against the frame, **(Figure 4)**. **NOTE:** The Plastic Retainer is designed to hold the Bolt Plate in place during Bracket installation.
- Select the passenger side Frame Mounting Bracket. Attach the top tab on the Bracket to the Bolt Plate with (1) 10mm Flat Washer, (1) 10mm Lock Washer and (1) 10mm Hex Nut, **(Figure 5)**. Leave loose at this time. Reuse the factory hex bolt removed in **Step 2** to attach lower mounting tab on the Bracket to the threaded hole in the bottom of the cross-member. Snug but do not fully tighten the hardware.
- Repeat **Steps 2—4** for driver side Frame Mounting Bracket installation, **(Figure 6)**.
- Open the hood on the vehicle and remove the plastic cover between the top of the radiator and the grille. Locate the steel cross-member mid-way up in front of the radiator, **(Figure 7)**. Cross-member can also be viewed and accessed from below the vehicle, **(Figure 8)**. Locate the factory holes in the bottom of the cross-member at each end, **(Figure 8)**. Select (1) 10mm Bolt Plate. Insert the Bolt Plate through the back of the cross-member and down through the hole in the bottom of the cross-member, **(Figures 9 & 10)**.

**GRILLE GUARD
2016 TOYOTA TACOMA**

7. Slide the passenger side Top Bracket through the plastic grille opening. Attach the flat end of the Top Bracket to the Bolt Plate with the included (1) 10mm Flat Washer, 10mm Lock Washer and (1) 10mm Hex Nut, **(Figures 11 & 12)**. Do not tighten hardware.
8. Repeat **Steps 6 & 7** for driver side Top Bracket installation.
9. With assistance, position the Grille Guard onto the outside of the Mounting Brackets. Use the included (6) 10mm x 35mm Hex Bolts, (12) 10mm Flat Washers, (6) 10mm Lock Washers and (6) 10mm Hex Nuts to attach the Grille Guard to the Mounting Brackets, **(Figure 13)**.
10. Line up the bent end of the passenger side Top Bracket with the corresponding hole in the upright on the Grille Guard. Bolt the Top Bracket to the Grille Guard with the included 10mm x 35mm Button Head Bolt, (2) 10mm Flat Washers, 10mm Lock Washer and 10mm Hex Nut, **(Figure 14)**. Do not tighten hardware at this time. Repeat this Step to attach the driver side Top Bracket to the Grille Guard.
11. Align the Grille Guard properly and tighten all Frame Bracket to frame hardware only. Temporarily remove the Grille Guard.
12. Hold the air dam, (removed in **Step 2**), up in approximate location against the previously installed Frame Brackets. Trace the location of the Frame Brackets onto the back of the air dam, **(Figure 15)**. Use a sharp knife or hacksaw blade to carefully cut slots out of the air dam to clear the Frame Brackets and Grille Guard. **IMPORTANT:** For best results, start with a small opening and cut as little as possible to clear the Brackets. Reinstall the air dam over the Brackets. Reinstall the Grille Guard and fully tighten all hardware.
13. Do periodic inspections to the installation to make sure that all hardware is secure and tight.

To protect your investment, wax this product after installing. Regular waxing is recommended to add a protective layer over the finish. Do not use any type of polish or wax that may contain abrasives that could damage the finish.

For stainless steel: Aluminum polish may be used to polish small scratches and scuffs on the finish. Mild soap may be used also to clean the Grille Guard.

For gloss black finishes: Mild soap may be used to clean the Grille Guard.

Passenger Side Installation Pictured



(Fig 1) Remove air dam from bottom of bumper

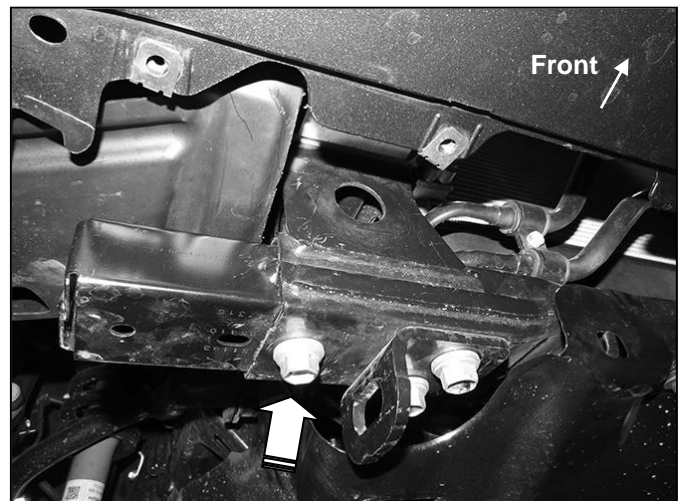

(Fig 2) Remove factory hex bolt (arrow)

10mm Bolt Plate
10mm Plastic Retainer

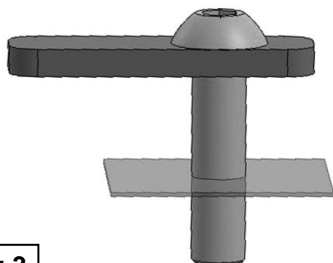
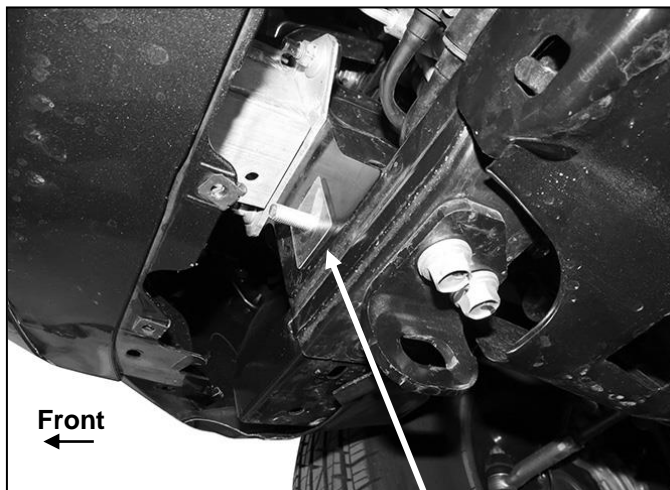
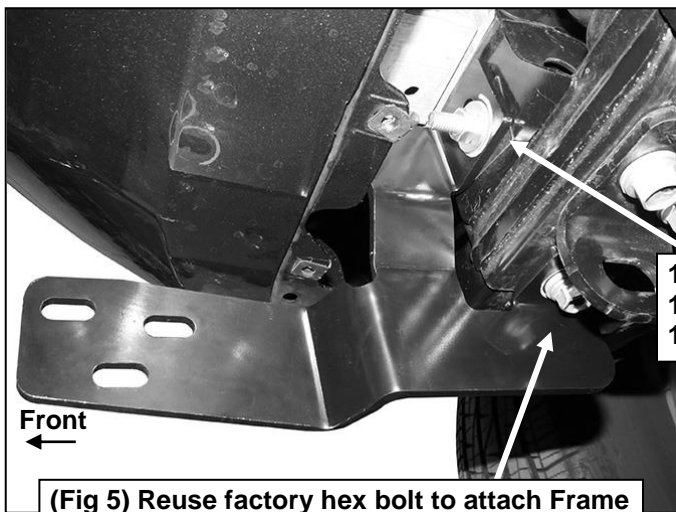

Fig 3



(Fig 4) Insert Bolt plate into factory hole in end of frame. Tighten Retainer to hold Bolt Plate in place



10mm Flat Washer
10mm Lock Washer
10mm Hex Nut

(Fig 5) Reuse factory hex bolt to attach Frame Bracket to bottom of cross-member

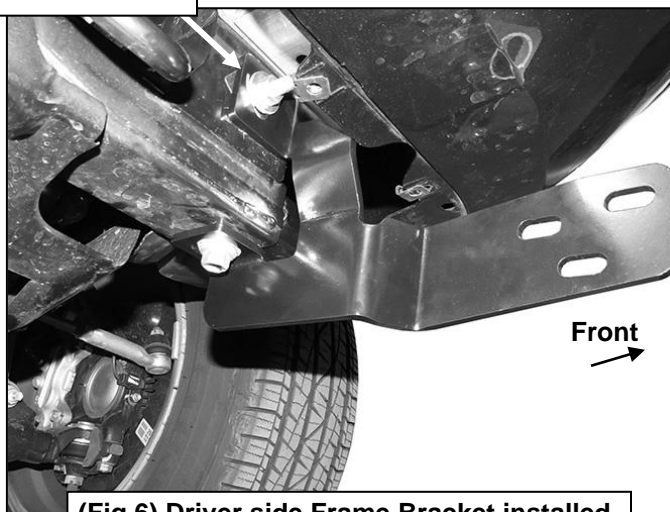

(Fig 6) Driver side Frame Bracket installed

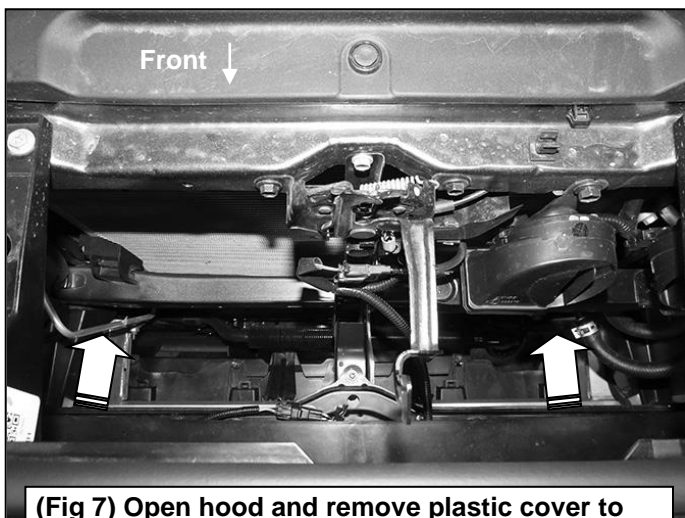

(Fig 7) Open hood and remove plastic cover to locate cross-support in front of radiator (arrows)

**GRILLE GUARD
2016 TOYOTA TACOMA**



Locate the outer holes in the bottom of the radiator cross support (arrow) viewed from below

(Fig 8) Plastic bumper removed for instruction purposes only-do not remove bumper

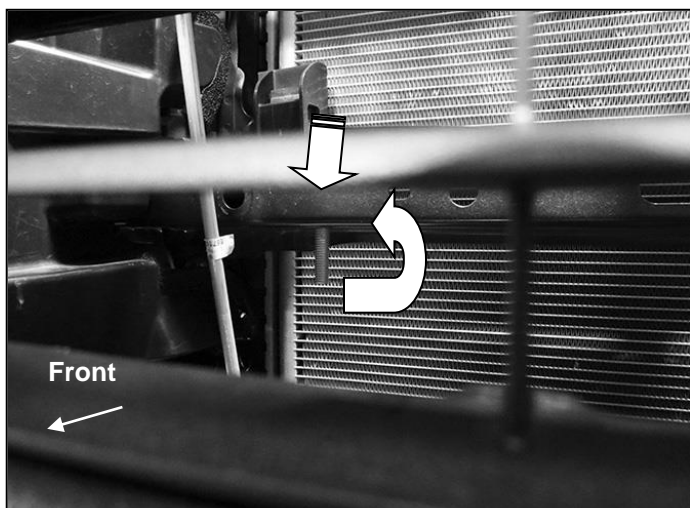

(Fig 9) Insert Bolt plate (arrow) into back of radiator cross support and down through hole in bottom (passenger side pictured through bumper)

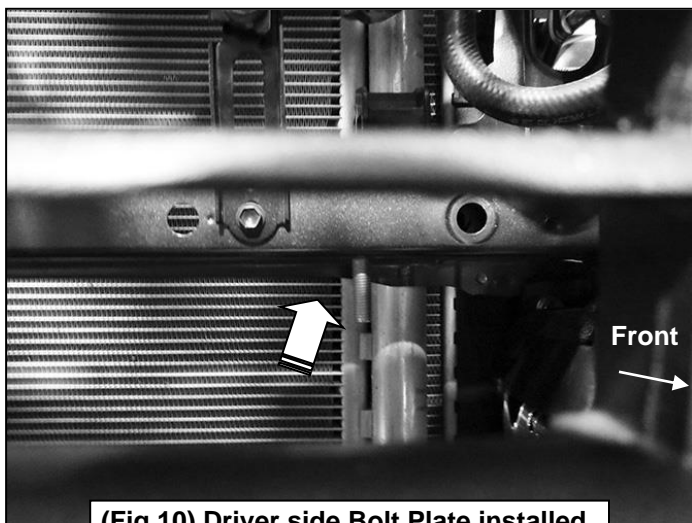

(Fig 10) Driver side Bolt Plate installed

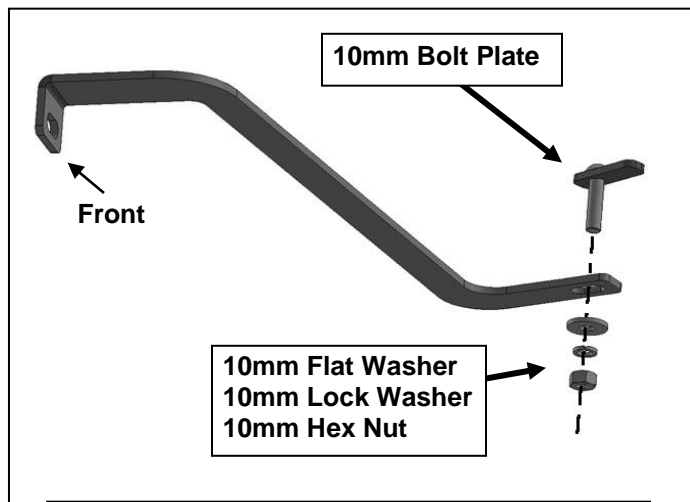

(Fig 11) Passenger side Top Support Bracket

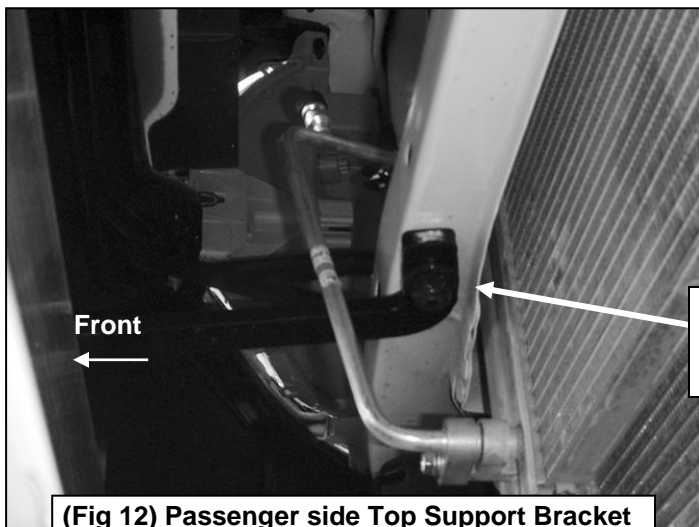

10mm Flat Washer
10mm Lock Washer
10mm Hex Nut

(Fig 12) Passenger side Top Support Bracket installed-pictured from below bumper

Passenger Side Installation Pictured

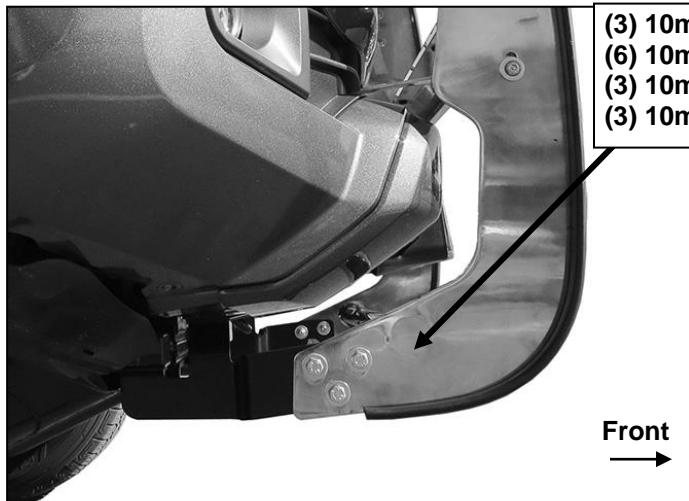

- (3) 10mm x 35mm Hex Bolts
- (6) 10mm Flat Washers
- (3) 10mm Lock Washers
- (3) 10mm Hex Nuts

(Fig 13) Attach Grille Guard to outside of Brackets

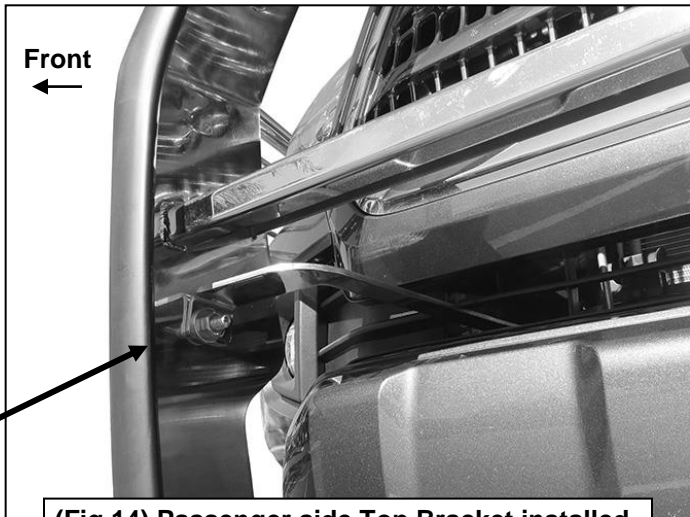

- 10mm x 30mm Button Head Bolt
- (2) 10mm Flat Washers
- 10mm Lock Washer
- 10mm Hex Nut

(Fig 14) Passenger side Top Bracket installed



(Fig 15) Use removable tape (masking tape) or a marker to mark location of Frame Brackets onto back of air dam (arrows). Carefully cut small openings with a sharp knife or hacksaw blade.



**Complete
Installation**