

INSTALLATION INSTRUCTIONS 20, 200, 240, 241, 400B, & 450B SERIES



20ZI & 200Z
SERIES



21ZI & 201Z
SERIES

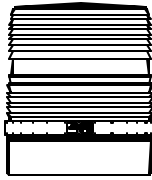

200S
SERIES

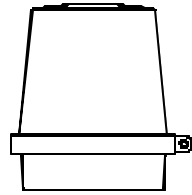

20FI, 20RH, 20RI, 200J,
& 200U SERIES



241S SERIES



240S SERIES

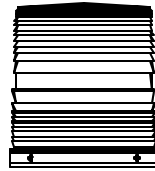

240C and 240A
SERIES

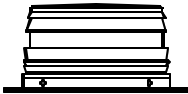

241SF SERIES

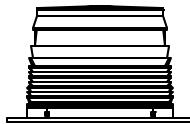

240SF/240ZF SERIES

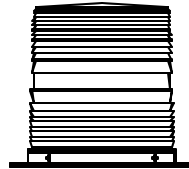

240CF and 240AF
SERIES

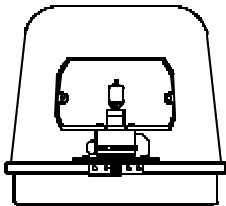

450BH SERIES

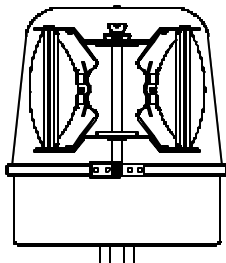

400B SERIES

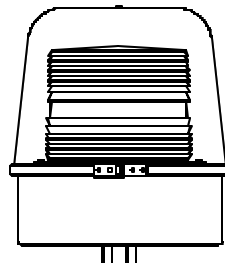

200B SERIES

PERMANENT MOUNT INSTALLATION INSTRUCTIONS

IMPORTANT: Please read all of the following instructions before installing your new light.

1. **CAUTION:** All of our DC powered warning lights are polarity sensitive. These lights are polarity protected *only if the appropriate fuse* is used. All wires connected to the positive terminal of the battery should be fused at the battery for their rated load. **Testing the [light](#) before this fuse is properly installed will void the warranty on the light.**
2. Your new warning light comes complete with a foam mounting gasket, mounting screws, lock washers, and well nuts.
3. For any models utilizing a **flange mount base**, please skip to Step 6.
4. The 20 Series, 200 Series, and the 240 Series Star warning lights come equipped with a combination base, allowing the light to be either mounted on a 1/2" NPT conduit pipe or permanently mounted. For NPT pipe, mount the light using the threaded entrance hole in the base of the light, then skip to Step 11. For the permanent mount, proceed to Step 5.
5. Carefully remove either the clamp ring or the three or four screws near the base of the lens and lift off the lens. Examine the inside of the base and use a punch or drill to remove the knock-outs present.
200B and 400B: If you wish to mount the 200B or 400B through the base, you will need to drill the three 3/8" mounting holes in the base. Use the gasket as a template to mark the locations in the base, then drill the holes.
6. Next, you will need to drill the holes in your mounting surface. Place the gasket in the exact position the light is to be mounted, and mark the holes on the mounting surface. (*NOTE: You might have to stretch the gasket slightly to find the location of the holes in the gasket.*) Take care to ensure that the gasket does not move while you are marking each of the holes. Be sure to mark the center hole if you will be running your wires through the mounting surface.
7. Remove the gasket and drill your holes using an appropriate 3/8" drill bit.
CAUTION: *If you are mounting the light on a vehicle, and plan to wire it through the roof of the vehicle, remove the headliner from the inside of the vehicle. If you do not remove the headliner, take care so that you do not drill through it.*
8. After the holes have been drilled, push the enclosed rubber well nuts through the outer holes until the bottom side of the wider lip rests on the surface of the vehicle.
9. Place the light on the surface of the vehicle, routing the wires through the center hole, if applicable.
10. To secure the light to your mounting surface, align the holes with the well nuts. Install the screws through the base, into the well nuts, and tighten until snug.
11. The black or white wire is the ground lead and should be connected to a good chassis ground
12. Connect the red wire to the positive side of the power through either a single-pole, two-position switch for normal operation, or a two-switch switch-panel for High/Low operation (High/Low option available only on models with three wires). Use a 5 amp fuse for all models except for the 400B, which will use a 10 amp fuse. *Check the label on the warning light for proper voltage.* If your light has only two wires then you are finished and may skip the remaining steps.
13. If your light has three wires (red, black, and purple) you need to decide how you would like the light to operate:
To utilize the High/Low option: Skip to Step 14.
For low power only: Leave the purple wire unconnected and place a wirenut over the end. Skip the remaining step.
For high power only: Connect the purple wire to the good chassis ground. Skip the remaining step.
14. If you intend to make use of the High/Low option through a switch, refer to the wiring diagram on the following page for proper connections using a two-switch switch panel available from Star.

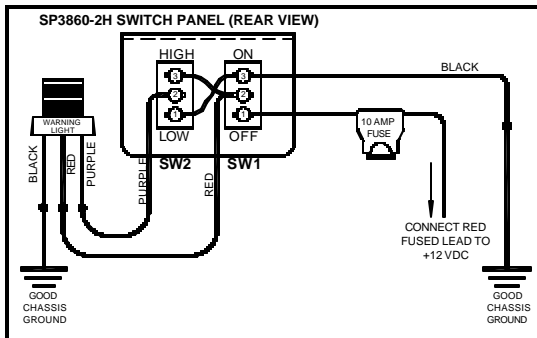

A two-switch switch-panel is required to utilize the High/Low power option. Make your connections as illustrated above.

Pattern Programming

The circuits now found in these lights have a jumper on them allowing the end user to select the desired flash pattern (singleflash, doubleflash, or quadflash). If you wish to change the pattern, activate the light and follow the instructions below.

1. The Pattern Select Jumper is stored on pins 1 & 2.
2. To change the pattern, remove the jumper from pins 1 & 2, momentarily place it over pins 2 & 3, then remove it. The pattern should advance to the next.
3. Continue to touch and release the jumper to pins 2 & 3 to cycle through the patterns:
singleflash → doubleflash → quadflash
4. Once you have selected a pattern, replace the jumper on pins 1 & 2.

Please Note: Some circuits may have only two pins. For those circuits, store the jumper on one of the pins, and use the jumper on the two pins for programming.

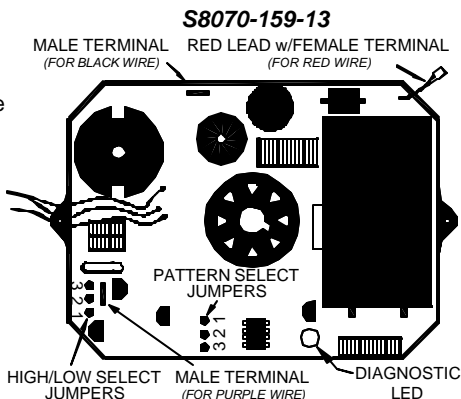

High/Low Jumper

Mag mount models will come with a jumper that automatically defaults the light to High Power. To only run on Low Power, move the High/Low Select Jumper from pins 1 & 2 to pins 2 & 3.

LED Indicator

These lights also have an **LED Diagnostic Indicator**. The LED indicator is designed to flash when the strobe tube should be flashing. If a strobe light is not working, troubleshooting becomes easy with this new LED. Simply examine the circuit when power is applied to it. If the strobe tube is not flashing, but the LED is flashing, you have a bad strobe tube. If the LED is not flashing, the circuit is either not receiving the proper voltage, or the circuit has failed.

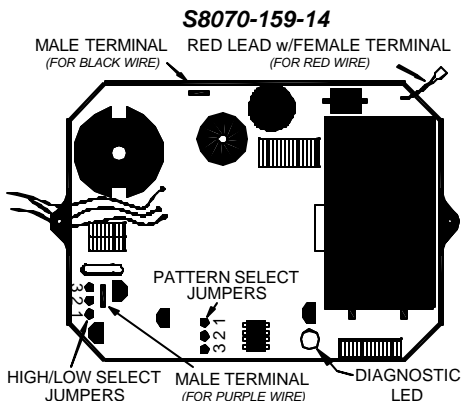

Magnet Mount Lights

WARNING!!!! Care should be taken when positioning any warning light on the roof, dash, or instrument panel of the vehicle, so that the light and/or cord does not interfere with the proper operation of any airbags! Failure to heed this warning may result in serious or fatal injury.

If you are mounting the light on the roof of your vehicle, take extreme care to ensure that the magnet is firmly seated on your roof, and that the pull of the magnet is sufficient to secure the light in place. As the composition of the metal in the roofs of different vehicles may vary, as well as the contour, texture and/or condition, Star cannot guarantee the ability of the light to remain in place upon a moving vehicle. It is the sole responsibility of the owner to ensure the warning light is secure.

- **CAUTION:** Please be sure to check that your cigarette plug outlet is properly fused. ***Testing the light before this fuse is properly installed will void the warranty on the light.***
- Once the light is secured, route your cord such that it does not interfere with the vision of the driver or the operation of any controls, including, but not limited to, the steering wheel, gear shifter, and/or airbag.
- This light has been factory tested and approved. If the light fails to work when the plug is inserted into the cigarette plug socket, twist the plug a few times to remove any ash or other deposits which might be preventing a good contact from being made. If the problem persists, check for a fuse inside of the plug itself. If present, remove the fuse from the circuit, check to see if it has blown, and clean the lighter socket and contact surfaces. Reconnect the fuse and test the light again.