

STANDARD[®]

WIRE & CABLE

ILLUSTRATED PARTS GUIDE

FOR DOMESTIC & IMPORT CARS & TRUCKS

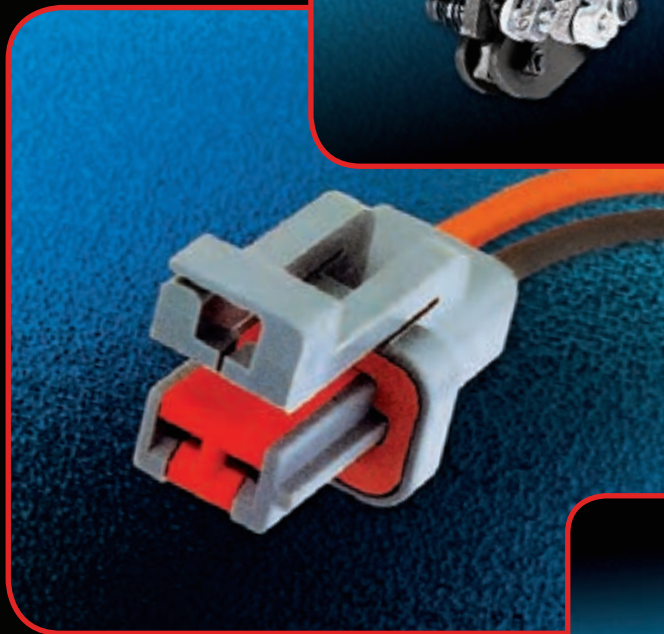

table of contents

SECTION	PAGE #	SECTION	PAGE #
A Ignition Wires	A1-A25	F Sockets, Pigtails & Switches	F1-F30
B Battery Cables	B1-B38	G Safety Accessories	G1-G8
C Primary Wire	C1-C14	H O.E. Interchanges	H1-H10
D Terminals & Connectors	D1-D36	I Index	I1-I18
E Trailer Connectors	E1-E31		

ITEM	PAGE #	ITEM	PAGE #	ITEM	PAGE #
3-way Terminals.....	D9, D16	Electrical Wire.....	C2-C5, C7-C8, E31	Primary Wire.....	C2-C5, C7-C8
4-way Terminals.....	D9	Electronic Brake Control.....	E13	Quick Splice Terminals.....	D13
Alligator Clips.....	B34	Emergency Battery Cable Ends.....	B18	Quick-Connect Battery Terminals.....	B28
Amperage Guide.....	C6	Emergency Battery Terminals.....	B27	Replacement Ends.....	B18
Asphalt Coated Loom.....	C9	Extension Cords.....	G8	Retainers.....	A23
Assortments.....	A14, A24, B23, B38, D29-D33	Fluorescent Droplights.....	G6	Ring Terminals.....	D3-D6, D12, D16, D19-D22
Auxiliary Starting System.....	B33	Fuse Block Taps.....	D14	Safe-Mate® Battery Couplers.....	B32
Battery Bolts and Nuts.....	B20, B27-B30	Fuse Holders.....	D15	Safety Accessories.....	G2-G8
Battery Cable.....	B4-B20, B22	Fuse Taps.....	D14	Shims.....	B30
Battery Cable Assortment.....	B17	Fusible Link Wire.....	C4	Shrink Tubing.....	B36-B38
Battery Cable Lugs.....	B24-B25, B29-30	Fusible Links.....	C4	Silicone Compound.....	A23
Battery Cable Replacement Ends.....	B18	Grommets.....	C11	Single Plug Wires.....	A8, A15
Battery Hold Downs.....	B34-B35	Ground Cables.....	B17	Slide Terminals.....	D7-D9, D12, D15-D16, D20, D22
Battery Isolators.....	B21	Ground Straps.....	B17	Sockets.....	F2-F11
Battery Protector.....	B31	Heat Guns.....	B38	Solder Slugs.....	B23
Battery Terminal Adapters.....	B28	Heat Shields.....	A16	Spade Terminals.....	D6-D7, D12, D16, D19, D21-D22
Battery Terminal Covers.....	B31	Heat Shrink Guns.....	B38	Spark Plug Boots.....	A10-A14
Battery Terminal Guards.....	B31	Heat Shrink Terminals.....	D3-D11, D14, D19-D22	Spark Plug Heat Shields.....	A16
Battery Terminals.....	B24-B28	Heat Shrink Tubing.....	B36-B38	Spark Plug Terminals.....	A16-A17, A23
Battery Tools.....	B34-B35, D35	High Temperature Loom.....	C9	Spark Plug Wire.....	A23
Bonded Parallel Primary Wire.....	C5	Hold Down Bolts.....	B34	Spark Plug Wire Separators.....	A23
Booster Cables.....	G4	Hold Downs.....	B35	Speaker Wire.....	C4
Booster Cable Clamps.....	G5	Hook Terminals.....	D6, D12	Specialty Terminals.....	D19-D22
Booster Cable Systems.....	B32-B33	Ignition Wire Assortments.....	A14-A15	Spiral Wrap.....	C9, C13
Boots.....	A16-A17	Ignition Wire Terminals.....	A23-A24	Splice Connectors.....	B17, B30, D9-D14, D16
Boot Pullers.....	A25	Ignition Wire Tools.....	A25	Split Loom.....	C9, C13
Bulk Battery Cable.....	B22, C8	Individual Plug Wires.....	A8-A15	Starter Cable Lugs.....	B24-B25, B29-B30
Bulk Booster Cable.....	B23	Jumper Cable.....	G4	Step-down Connectors.....	B17, B30, D16
Bulk Ignition Wire.....	A23	Jumper Cable Systems.....	B32-B33	Switches.....	F28-F30
Bulk Marine Battery Cable.....	C8	Lead-free Battery Terminals.....	B26	Terminal Assortments.....	A23, D29-D33
Bulk Spark Plug Wire.....	A23	Light Sockets.....	F2-F11	Terminal Covers.....	B31
Bulk Trailer Cable.....	E31	Loom.....	C9, C13	Test Clips.....	B34
Bulk Wire Dispenser.....	C3, D34	Loom Tee Connectors.....	C10	Testers.....	D35, E29
Bullet Connectors.....	D11-D12, D16, D20	Loom Installation Tool.....	C9	Tie Straps.....	C11-C13
Bundling Accessories.....	C9-C13	Lugs.....	B24-B25, B29-B30	Tools.....	A25, B34-B35, D35
Butt Splice Connectors.....	D10-D12, D16, D20-D22	Marine Battery Cable.....	C8	Torches.....	B38
Cabinets.....	D34	Marine Battery Terminals.....	B27	Trailer Cable.....	E31
Cable Crimping Tools.....	B35	Marine Primary Wire.....	C7-C8	Trailer Connector Applications.....	E18-E28
Cable Lugs.....	B24-B25, B29-B30	Motorcycle Wire Sets.....	A5	Trailer Connector Brackets.....	E17
Catalog Rack.....	D34	Mounting Clips.....	C10	Trailer Connectors.....	E3-E16
Circuit Testers.....	D35	Multi Wire Connectors.....	D9, D16	Trouble Lights.....	G6-G8
Clear Tubing.....	C9	Multi-Colored Loom.....	C13	Truck Wire Sets.....	A5
Coil Boots.....	A16	Multi-Colored Tie Straps.....	C13	Uninsulated Terminals.....	D15-D16
Coil Nipples.....	A16	Multi-Conductor Cable.....	B23	Universal Switches.....	F28-F30
Coil-On-Plug Boots.....	A18-A21	Multi-Conductor Wire.....	C4-C5, C8, E31	Universal Wire Sets.....	A6
Coil-On-Plug Boot Per Car Kits.....	A22	Multiple Battery Harnesses.....	B19-B20	Vacuum Caps.....	C10
Compression Terminals.....	B25	Multiple Battery Isolators.....	B21	Voltage Testers.....	D35
Connector Assortments.....	A24, D29-D33	Nipples.....	A16-A17	Welding Cable.....	B23
Convuluted Tubing.....	C9, C13	O.E.M. Electronic Terminals.....	D23-D29	Wire Clamps.....	C10
Corrosion Protection.....	B31	O.E.M. Tools.....	D35	Wire Display Rack.....	C3
Crimp Tools.....	A25, B35, D35	Parallel Connectors.....	D10	Wire Nuts.....	D13-D14
Crosslink Wire.....	C5	Per Car Engine Kits.....	A22	Wire Separators.....	A23
Custom Ignition Leads.....	A2-A5	Pigtails.....	F12-F27	Wire Ties.....	C11-C13
Custom Lead Assortments.....	A14-A15	Pin Terminals.....	D11	Wiring Tools.....	C9, C11, D35
Di-Electric Compound.....	A23	Plug Wire Assortments.....	A14-A15	Zip Ties.....	C11-C13
Distributor Boots.....	A17	Plug Wire Boots.....	A16-A17		
Drawer.....	D34	Plug Wire Retainers.....	A23		
Droplights.....	G6-G8	Plug Wire Terminals.....	A23-A24		
Electrical Cable.....	C4, G7	Posi-Lock® Terminals.....	D17		



Ignition Wires

Battery Cables

Primary Wire

Terminals & Connectors

Trailer Connectors

Sockets, Pigtails & Switches

Safety Accessories

O.E. Interchanges

Index

PREMIUM IGNITION WIRE SETS



STANDARD

OE Plus
performance

**IGNITION WIRE
QUALITY ENGINEERED
FROM END TO END...**

...KNOW YOUR IGNITION WIRE



PREMIUM QUALITY MATERIALS

- Conductive Silicone Core
- Magnetic Suppression Core
- Metallic Core
- Blended Silicone Insulation
- Fiberglass Braid
- Corrosion Resistant Terminals
- Heavy Duty Silicone Boots
- Silicone Outer Jacket

**ISO/TS
16949**

Warranty Statement

Our wire sets are warranted to be free from defects in material and workmanship. Should the wire set fail at any time during the life of the vehicle on which it was originally installed, it will be replaced at no charge, upon presentation of the defective wire set and proof of purchase to any authorized distributor of our wire & cable products.

This warranty is limited to replacement of the wire set only, and does not include incidental or consequential damages. Our company is not liable for injury or property damage resulting directly or indirectly from an actual or alleged defect in material and/or workmanship. Failure due to incorrect installation or the wrong application is not covered by this warranty.

PREMIUM IGNITION WIRE SETS



WHY PREMIUM WIRE IS CRITICAL...

Hotter running engines, crowded engine compartments and higher voltage output make premium wire sets a key component of any ignition system.

The primary cause of ignition wire failure is prolonged exposure to HEAT. The termination at the spark plug end is most susceptible to these high temperatures. When the extreme heat from the spark plug transfers to the wire, the core is exposed to temperatures that can char, melt away and cause core burnout; the number one cause of ignition wire failure.

Domestic O.E. manufacturers use an extruded silicone core to solve this problem and so does Standard. The latex fiberglass core used by most other aftermarket companies simply won't last.

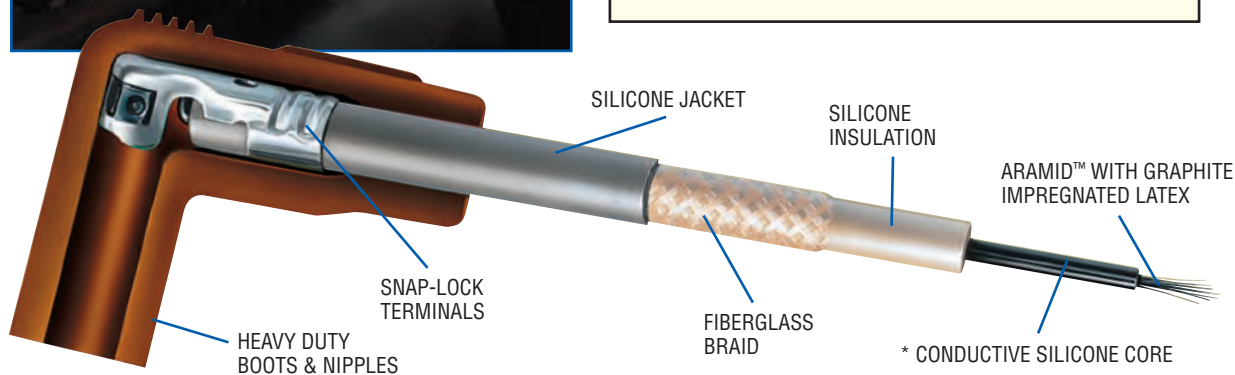

PREMIUM QUALITY MATERIALS

CONDUCTIVE SILICONE CORE — A core of super-strong aramid fiber is impregnated with a graphite/latex mixture calibrated to vary resistance, suppress radio static (RFI) and deliver voltage to the spark plug. Conductive silicone rubber is extruded over this inner core combining unsurpassed toughness and superior heat resistance. This conductive silicone core virtually eliminates core burnout. Every premium wire set in the line has this conductive silicone core rated at 100,000 miles.

MAGNETIC SUPPRESSION CORE — Stainless steel conductive winding with heat resistant latex. OE on certain domestic vehicles from 1995

METALLIC CORE — Metallic conductor OE on many European vehicles.

SILICONE INSULATION — The insulation layer shields the core and protects against voltage leaks and shorts to ground. We use silicone which has superior insulating properties.

FIBERGLASS BRAID — A fiberglass braid around the insulation layer provides added strength, toughness and increased flexibility. It also improves terminal pull off forces.

SILICONE OUTER JACKET — Like the silicone core, the silicone outer jacket protects against harsh under hood conditions - heat, moisture, grease, oil and other contaminants. It combines

superior thermal protection and durability. Each set in our line has a silicone jacket - Foreign and domestic, vintage and late model applications all meet or exceed O.E. quality.

CORROSION RESISTANT TERMINALS — Tight positive connections between the terminal and the spark plug, distributor cap, or coil ensure uninterrupted current flow and consistent driveability. Gold chromate snap-lock terminal clips provide additional anti-corrosion protection. The snap-lock feature provides a positive connection between the spark plug and the wire. Engine vibration won't cause the terminals to back out and lose contact. Terminal pull-off values are consistently over 50lbs. at room temperature and far exceed SAE J2032 specification of 20 lbs. heated at 90°C.

HEAVY DUTY SILICONE BOOTS — Silicone has unmatched resistance to heat. That's why O.E. uses silicone. That's why we use conductive silicone core on all premium wire sets, silicone boots on all applications specified by O.E. and high temperature silicone boots on many high heat car and truck applications.

PREMIUM WIRES — are made up of these various protective layers that enhance overall performance and ensure long life. Lesser grades of wire omit many of these layers. From the conductive silicone core to the heavy duty silicone spark plug boots, Standard Plus wire provides a host of benefits that make them the best ignition wire sets you can buy.

* Magnetic Suppression Core or Metallic Core where specified by OE

PREMIUM IGNITION WIRE SETS

5000 SERIES NORMAL TEMPERATURE*



6000 SERIES HIGH TEMPERATURE*



7000 SERIES* 9000 SERIES* HIGH TEMPERATURE



CERAMIC BOOT SERIES SEVERE TEMPERATURE*



STANDARD WIRE SETS PROVIDE THE PERFECT FIT WITH THE HIGHEST PERFORMANCE DEMANDED BY SERVICE PROFESSIONALS!



CUSTOM FIT – FOR TOP PERFORMANCE

Proper fit is a high priority for premium quality ignition wires. “Proper fit” means the fit of the replacement wire set closely follows the fit of the original wires, in length, as well as terminal and boot configuration (straight, 135° or 90°). The closer the fit matches, the easier it is to follow the routing pattern specified by OE.

This is important because:

- The OE routing pattern minimizes “crossfire” (the tendency of an improperly routed plug wire to induce voltage into an adjacent wire.) Crossfire can cause a second spark plug to fire at the incorrect time, resulting in engine backfire.

In computerized vehicles, an improperly routed plug wire can induce voltage in sensor leads, which are designed to carry less than 1 volt. The induced voltage can generate incorrect sensor signals, or even short out a sensor or damage the computer itself.

- Proper fit ensures that you won’t have to stretch wires or leave too much slack. Excessively long wires can contact hot or moving engine parts such as exhaust manifolds or fan blades. Correct wire length eliminates extra stress on the boot and terminal, and ensures a reliable connection. It also eliminates sharp bends in the wire, which can cause higher resistance and result in premature wire failure.

To be sure your wires always fit, always specify Standard Premium Ignition Wires!

* For a complete listing of all wire set applications, refer to our most current Engine Management Application Guide.

METALLIC CORE

Part No.	Application*	Ceramic Boot Set Wire Lengths								Coil
		1	2	3	4	5	6	7	8	
9947	GM Med. & H.D. Trk.	28	32	32	32	36	36	36	44	12
9952	GM Lt. Trk.	24	26	28	28	32	36	36	40	12
9961	GM Trk.	18.5	20.5	22.5	28.5	28.5	30.5	30.5	34.5	12.5
9965	GM Med. & H.D. Trk.	26	28	28	28	28	32	38	41	
9984	GM Med. & H.D. Trk.	24	28	32	32	36	40	40	52	

TRUCK & MOTORCYCLE WIRE SETS



TRUCK WIRE SETS

- Premium Inner Silicone Boot for Maximum Thermal Protection
- Ceramic Spark Plug Sleeve Resists 1750°F for Durability in Extreme Conditions
- High Temperature Silicone Insulation and Jacket
- Woven Fiberglass Braid for Increased Cable Strength
- Extra Thick Silicone Core for Long Lasting Performance
- 8.5mm Magnetic Suppression Winding for Reduced RFI

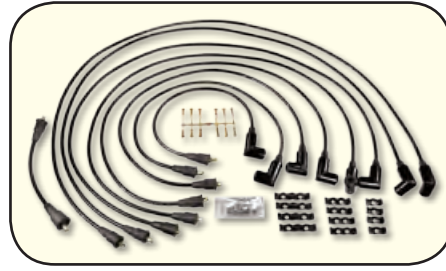

Part No.	Description	Part No.	Description
69401	Ford Light Truck 4.9 Eng 96-76	69419	Ford Light Truck 2.8, 2.9, 3.0 Eng 95-83
69402	Chevrolet and GMC Truck Light Truck 5.0, 5.7 Eng 95-87	69420	Chevrolet and GMC Truck Light Truck, Ford Light Truck, Chrysler, Dodge Light Truck, most engines
69403	Ford Light Truck 5.0, 5.8, 7.5 Eng 97-84	69421	Chevrolet and GMC Truck Light Truck 4.1, 4.6, 4.8, 5.4, 5.7, 6.7 Eng 89-61
69404	Ford Light Truck 5.0, 5.8, 6.6, 7.5 Eng 93-77	69422	Chevrolet Light Truck, Dodge Light Truck 6.0, 6.5, 6.6, 7.4 Eng, 5.9L Eng., 5.0, 5.8, 6.6 Eng. 74-66, 60-55
69405	Chevrolet and GMC Truck Light Truck 6.6, 7.4 Eng 97-77	69423	Ford Light Truck 5.0, 5.8 Eng 97 - 80
69406	Chevrolet and GMC Truck Light Truck 4.3, 7.4 Eng 97-86	69424	Chevrolet and GMC Truck Light Truck, Ford Light Truck 7.4 Eng, 5.0, 5.8 Eng. 76-75
69407	Dodge Light truck, Ford Light Truck 5.2, 5.9 Eng, 5.8, 5.9, 6.4, 7.5 Eng 78-70	69425	Chevrolet and GMC Truck Light Truck, Cadillac, Isuzu 4.3, 5.0, 5.7, 7.4 Eng 07-96
69408	Chevrolet and GMC Truck Light Truck 5.0, 5.7, 6.6 Eng 88-75	69426	Chevrolet and GMC Truck Light Truck, Cadillac, Isuzu 5.0, 5.7 Eng 02-96
69409	Ford Light Truck 2.3, 4.0 Eng 88-75	69427	Dodge Light Truck 6.6, 7.2 Eng 79-71
69410	Chevrolet and GMC Truck Light Truck 5.0, 5.7 Eng 86-81	69428	Dodge Light Truck 5.2, 5.9 Eng 03 - 98
69411	Chevrolet and GMC Truck Light Truck, Ford Light Truck 2.8, 3.1 Eng, 3.0 Eng. 95-82	69429	Dodge Light truck, Plymouth, Chrysler 3.3, 3.8 Eng 00-96
69412	Chevrolet and GMC Truck Light Truck, Ford Light Truck 4.6, 5.0, 5.4, 5.7, 6.7 Eng 74-61	69430	Chevrolet and GMC Truck Light Truck, Cadillac 4.8, 5.3, 6.0, 7.4 Eng 07-98
69414	Chevrolet and GMC Truck Light Truck, Ford Light Truck 5.0, 5.7, 6.6 Eng 96-75	69501	Single Lead Straight Boot Universal
69415	Toyota Trucks 2.4 Eng 92-80	69502	Single Lead 90° Boot Universal
69416	Dodge Light truck 5.2, 5.9 Eng 91-79		
69417	Dodge Light truck 3.9, 5.2, 5.9 Eng 98-92		
69418	Chevrolet and GMC Truck Light Truck, Ford Light Truck 7.4 Eng 89-85		

MOTORCYCLE WIRE SETS



Part No.	Application	OEM No.
MC1105	84-80 FLH, 99-85 Softail, and 98-91 FXD	32093-98
MC1106	96-85 Evolution 1340 FLT, FLHT, FLHR, and 93-82 FLHS	32091-98
MC1107	99-82 FXR	32090-98
MC1108	02-86 XL, except XL1200S	32092-98
MC1109	98-97 FLHT, FLHCT, FLHTCU, FLHR	32094-98
MC1110	02-99 Touring, FLHT, FLT	31932-99
MC1111	99-up Dyna	31930-99
MC1112	98-up 4 plug XL1200S	32054-98
MC1113	00-up Softail	32358-00A
MC1115	06-04 XL	31958-04A
MC1116	07-up XL	31901-08
MC1117	09-up Touring	32325-08

Universal Fit

STANDARD® Universal Kits come complete with easy to install brass locking terminals and easy to follow instructions.

Part No.	Application	OEM No.
MC1104	Universal application except 98-up XL1200S and 99-up Twin Cam.	32095-98
MC1114	Universal 4 plug kit for dual coil or 4 cyl.	



Copper Core

For older points-style applications we offer a 'Copper Core' wire for special improved electrical conductivity and mechanical strength.

These 'Copper Core', non-resistive sets should be used with only point-style ignitions. All of our ready to install top of the line wire sets are made in the USA.

Part No.	Application
MC1101	69-58 XL, XLCH with Magneto
MC1102	78-71 XLH, XLCH
MC1103	78-65 FL, FLH, 78-71 FX, FXE



UNIVERSAL WIRE SETS

3000 SERIES UNIVERSAL WIRE SETS

3000 SERIES Conductive Silicone or Metallic Core

Wires in each 3000-series set have one end fitted with a bendable terminal and a flexible silicone boot that can serve for straight, 90° and 135° applications.

Wires are extra long and are un-terminated at the distributor end. Each wire set includes two full sets of distributor boots: one straight and one for 90° distributor ends. Both ends of the coil wire are un-terminated, with all parts supplied for either straight or 90° termination at either end.

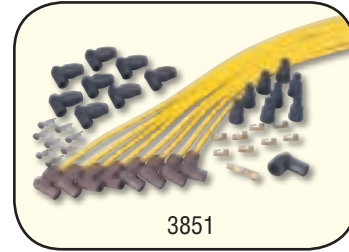

3851

UNIVERSAL WIRES

Metallic Core wires are not static suppressing. These 3000 Series universal wire sets are 7mm and 8mm silicone and designed specifically for off-road and racing use.

Cyl.	Conductive Silicone Core			Metallic Core			Wire Length (Inches)								
	7mm CPE Jacket	7mm Silicone	8mm Silicone	7mm CPE Jacket	High Performance 7mm Silicone	8mm Silicone	1	2	3	4	5	6	7	8	Coil
4	3400	3401		3402	3403		37	37	37	37					35
6	3600	3601		3602	3603		33	33	40	40	46	46			30
8	3800	3801		3802	3803		35	35	40	45	50	55	60	60	18
8			3840†			3850†	35	35	37	39	39	51	55	55	20
8						3851†	35	35	37	39	39	51	55	55	20

† 3840 and 3850 have straight spark plug boots; 3851 has 90° spark plug boots. Straight and 90° distributor boots are furnished.

OTHER UNIVERSAL WIRE SETS

8000 SERIES Silicone Core

Each wire is factory terminated at the plug end only. Distributor terminals and boots are furnished. Special "TWIN TERMER" sets (Part Nos. 8613 and 8840) come with straight plug boots at one end and 90° boots at the other end. Remove unwanted end and trim to size; then assemble distributor terminal and boot to cut end.

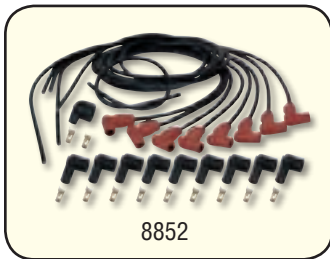

8852

CONDUCTIVE SILICONE CORE

Cyl.	7mm CPE Jacket	Boot Config.	1	2	3	4	5	6	7	8	Coil
6	8613		31	31	36	41	46	46			30
8	8840	Str./90°	33	35	37	41	48	48	56	56	18
	8852		28	30	33	37	45	50	50	56	16

"W" SERIES 7mm Metallic Core

Each wire is factory terminated at the spark plug end; user cuts and terminates the distributor end with parts supplied. Fabricated from metallic core wire having a special rubber compound insulation with a black outer jacket. Features tightly fitted, molded spark plug boots for a waterproof, oil-proof and flash-proof connection.

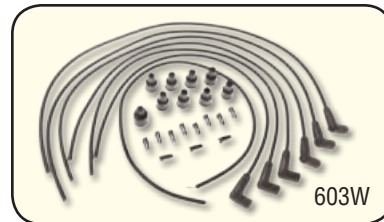

603W

METALLIC CORE

Cyl.	7mm CPE Jacket	Boot Config.	1	2	3	4	5	6	7	8	Coil
4	403W	Str.	25	30	30	33					13
6	603W	90°	23	25	25	28	30	30			28
	605W	Str.	13	16	19	37	40	40			13
	608W	Str.	13	13	16	19	25	28			20
8	801W	90°	30	33	37	37	45	48	48	48	16
	804W	Str.	30	30	33	37	37	37	42	45	18
	806W	Str.	28	28	28	30	30	30	33	33	16
	809W	90°	30	33	40	40	45	54	54	54	16

To assure reliable and quality terminations, use the right tools and materials. (Refer to pages A23 through A25)

Any product in the catalog

— OVERNIGHT!*

**STANDARD'S
"OVERNIGHT"
PROGRAM**

Never be out of stock. If it's in the catalog, it's in your hands the next day. Just phone, fax, or Direct Connect** your order to one of our Distribution Centers by 2 PM their time, and have guaranteed next-day delivery*.

No need to tie up dollars in slow-moving inventory. With our Overnight Delivery program, anything you need is just a phone call away. Call or fax your Distribution Center for immediate service. If you are a jobber, have your warehouse distributor place your order.



STANDARD[®]
Engine Performance Specialists











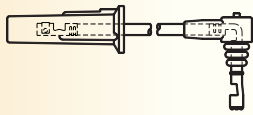

INDIVIDUAL IGNITION WIRES

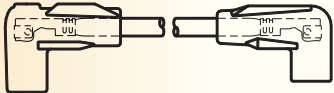

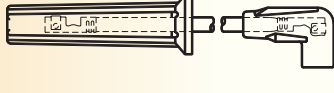
- **PREMIUM QUALITY**
- **COST EFFECTIVE**
- **READY-TO-USE CONVENIENCE**

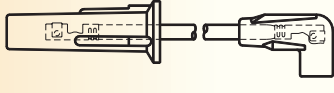
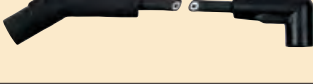
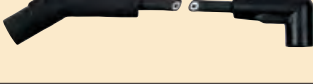
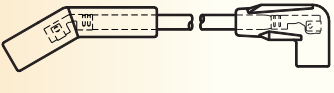
- **Factory-Terminated at Both Ends**
- **Broad Coverage; Minimum Stock Investment**
- **All Wires Have Conductive Silicone With Aramid Center**
- **All Spark Plug Boots Are Silicone**
- **All Leads Are Made With Silicone Jackets**

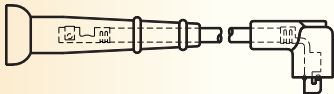
PLUG WIRES – 7MM

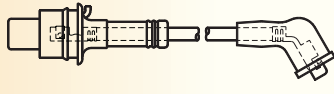
Part No.	Length	Part No.	Length	Plug End	Dist. End	Illustration
712AF	12"	716AF	16"			
712AK	12"	728AK	28"	* 		
716AK	16"	732AK	32"			
724AK	24"	736AK	36"			
712AL	12"	736AL	36"	* 		
716AL	16"	744AL	44"			
720AL	20"	748AL	48"			
724AL	24"	752AL	52"			
728AL	28"	756AL	56"			
732AL	32"					
718BK	18"	728BK	28"	* 		
724BK	24"	732BK	32"			
		736BK	36"			
725BL	25"	740BL	40"			
736BL	36"					
719CH	19"	728CH	28"			
727CK	27"	741CK	41"			

* High Temperature Silicone Spark Plug Boots

INDIVIDUAL IGNITION WIRES











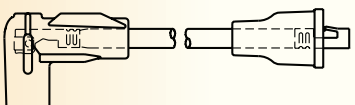

ALL WIRES HAVE CONDUCTIVE SILICONE CORE WITH ARAMID CENTER

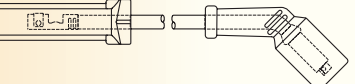

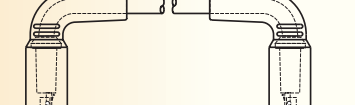

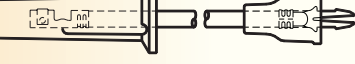
PLUG WIRES – 7MM

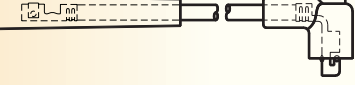
Part No.	Length	Part No.	Length	Plug End	Dist. End	Illustration
717CL	17"	724CL	24"			
710CS 716CS	10" 16"	734CS	34"			
712CT 719CT 726CT	12" 19" 26"	734CT	34"			
727CW	27"	Universal not terminated on either end Straight Resistor Distributor Boot				
737CW	37"	Universal not terminated on spark plug boot end 90° Non Resistor Distributor Boot				
745CW	45"	90° Non Resistor Distributor Boot				
741J	41"					
718JB 722JB 728JB	18" 22" 28"					
712K 716K 722K	12" 16" 22"	726K 731K 735K	26" 31" 35"			
718L 723L	18" 23"	727L 734L	27" 34"			

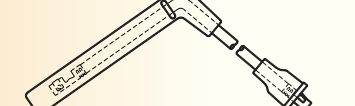
INDIVIDUAL IGNITION WIRES

ALL SPARK PLUG BOOTS ARE SILICONE

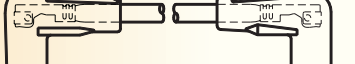
PLUG WIRES – 7MM						
Part No.	Length	Part No.	Length	Plug End	Dist. End	Illustration
722M 726M 732M	22" 26" 32"	741M 749M	41" 49"			
708NS 711NS	8" 11"					
715NT	15"					
713T 717T	13" 17"	725T	25"			
712XA 716XA 722XA	12" 16" 22"	726XA 731XA 735XA	26" 31" 35"			
707XD 716XD	7" 16"	722XD 727XD	22" 27"			

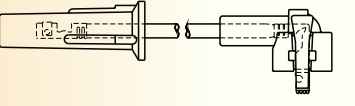
PLUG WIRES – 8MM						
Part No.	Length	Part No.	Length	Plug End	Dist. End	Illustration
818AH 828AH 832AH	18" 28" 32"	836AH 840AH 848AH	36" 40" 48"			
812AK † 818AK 824AK 828AK 832AK	12" 18" 24" 28" 32"	838AK 844AK 848AK 855AK	38" 44" 48" 55"			
† Coil Wire EDPM Boot						
813FT 817FT 825FT 831FT	13" 17" 25" 31"					

* High Temperature silicone spark plug boots

INDIVIDUAL IGNITION WIRES













ALL LEADS ARE MADE WITH SILICONE JACKETS

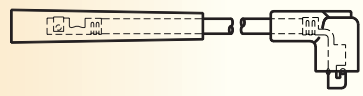

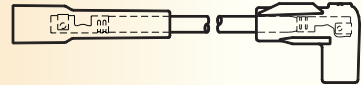

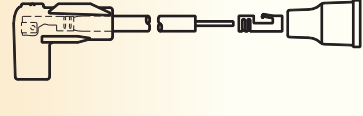

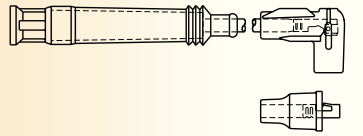

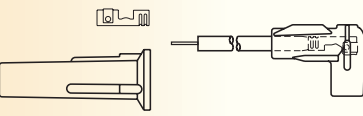

PLUG WIRES – 8MM				Plug End	Dist. End	Illustration
Part No.	Length	Part No.	Length			
814FW 818FW 824FW	14" 18" 24"	830FW 835FW 845FW	30" 35" 45"	*		
820GT 824GT 828GT 834GT	20" 24" 28" 34"	840GT 848GT 856GT	40" 48" 56"			
818N	18"	829N	29"			
814P 818P 822P 826P	14" 18" 22" 26"	832P 836P 840P 845P	32" 36" 40" 45"	*		
818Q 822Q 828Q	18" 22" 28"	832Q 840Q	32" 40"	*		
818R 822R 828R 832R	18" 22" 28" 32"	838R 844R 848R 855R	38" 44" 48" 55"	*		
812X 816X 820X 822X 824X 826X	12" 16" 20" 22" 24" 26"	828X 832X 836X 840X 845X	28" 32" 36" 40" 45"	*		
813XC 818XC 821XC	13" 18" 21"	827XC 834XC	27" 34"			

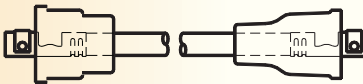
* High Temperature silicone spark plug boots

INDIVIDUAL IGNITION WIRES

FACTORY TERMINATED AT BOTH ENDS

PLUG WIRES – UNIVERSAL						
Part No.	Length	Part No.	Length	Plug End	Dist. End	Illustration
716U 720U 724U 730U	16" 20" 24" 30"	734U 738U 744U 750U	34" 38" 44" 50"	7mm 		
724US 736US*	24" 36"	760US*	60"	7mm * 		
* Includes straight terminal and distributor boot						
716UW 725UW 736UW	16" 25" 36"	743UW* 754UW	43" 54"	7mm * 		
* Bendable terminal with a straight spark plug boot						
760UX	60"			7mm 		
Ceramic Spark Plug Boot Metallic Core						
860UP	60"			8mm 		

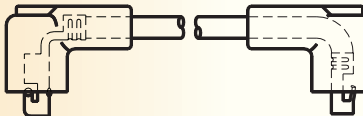
COIL WIRES – 7MM						
Part No.	Length	Part No.	Length	Coil End	Dist. End	Illustration
724CD 729CD	24" 29"	739CD	39"			
716CC	16"	725CC	25"			
711CE 717CE 720CE	11" 17" 20"	726CE 736CE	26" 36"			
713EE 718EE	13" 18"	724EE 727EE	24" 27"			

COIL WIRES



BROAD COVERAGE, MINIMUM STOCK INVESTMENT

COIL WIRES – 7MM

Part No.	Length	Part No.	Length	Coil End	Dist. End	Illustration
712GG 718GG	12" 18"	722GG	22"			
719HA 725HA	19" 25"	742HA	42"			
718UC	18"	Universal				

COIL WIRES – 8MM

Part No.	Length	Part No.	Length	Coil End	Dist. End	Illustration
812CA 814CA	12" 14"	817CA 827CA	17" 27"			
814CB 818CB	14" 18"	825CB	25"			
819DD	19"					
813HH	13"					

WIRE ASSORTMENTS

PREMIUM QUALITY INDIVIDUAL IGNITION WIRES!

Unbeatable Custom Wire Coverage!

For Domestic & Import Cars, Light Trucks and Vans

Great For Self Service Selling!

Included in each assortment:

1. 52 different part numbers.
2. "Do-It-Yourself" Application Guide.
3. Colorful, eye-catching header.
4. Adhesive-tags attached to each wire — for easy part number identification. Wire hangs from the rack by the boot.
5. Free display rack.

Part No.	Description	Std. Pkg.
700SLA-1	Large Domestic Asst.	1
701PLA-1	Small Domestic Asst.	1
705PLA	Import Asst.	1
700PLR-1*	Single Wire Rack	1

* Includes free leads to offset cost of rack



700SLA-1 (LARGE) AND 701PLA-1 (SMALL) DOMESTIC ASSORTMENTS

Part No.	Quantity* Per Assortment		Part No.	Quantity* Per Assortment	
	700 SLA-1	701 PLA-1		700 SLA-1	701 PLA-1
711CE	1	1	818R	5	1
712K	5	2	820X	5	2
713T	5	2	822P	5	2
716K	5	2	822Q	2	1
717CE	2	1	822R	5	2
720CE	2	1	822X	5	2
722K	5	2	824X	5	2
722M	2	1	825CB	1	1
724CD	1	1	826P	5	2
725CC	1	1	826X	3	3
726CE	1	1	827CA	1	1
726K	5	2	828Q	5	2
726M	2	1	828R	5	1
729CD	1	1	828X	5	3
731K	5	3	832P	5	2
732M	5	2	832Q	3	2
735K	5	2	832R	4	2
741J	5	1	832X	5	2
741M	5	1	836P	2	1
749M	5	1	836X	3	2
812CA	2	1	838R	2	2
812X	5	1	840Q	4	2
814CA	2	1	840X	3	2
814CB	2	1	844R	3	2
816X	5	2	845X	3	1
817CA	1	1	848R	1	1

* Total leads: 700SLA-1 = 180; 701PLA-1 = 82

705PLA (IMPORT) ASSORTMENT

Part No.	Quantity**	Part No.	Quantity**
707XD	1	725HA	1
711CE	2	726CE	2
712AF	2	726K	3
712GG	2	726XA	5
712K	4	727CK	2
712XA	5	727EE	1
713EE	2	727L	2
716AF	2	727XD	1
716K	5	728CH	2
716XA	4	731K	3
716XD	2	731XA	4
717CE	2	734L	1
717CL	1	735K	1
718EE	3	735XA	4
718GG	2	736CE	1
718L	2	741CK	2
719CH	2	742HA	1
719HA	1	813HH	1
720CE	2	813XC	2
722GG	2	818N	2
722K	5	818XC	2
722XA	5	819DD	2
722XD	1	821XC	1
723L	1	827XC	2
724CL	1	829N	2
724EE	2	834XC	2

** Total leads = 115

WIRE ASSORTMENTS



PREMIUM QUALITY INDIVIDUAL IGNITION WIRES!

Late Model Coverage

Fits newer Domestic Cars, Light Trucks, and Vans. Complements the large 700SLA-1 and small 701PLA-1 assortments.

Included In Each Assortment!

1. 32 different part numbers.
2. Adhesive-tags attached to each wire — for easy part number identification. Wire hangs from the rack by the boot.
3. Free display rack.

702PLA-SINGLE LEAD ASSORTMENT

Part No.	Qty.	Part No.	Qty.
712CT	1	712AK	1
719CT	1	724BK	1
724AL	1	728AK	1
726CT	1	728BK	1
728AL	1	732AK	1
734CT	1	732BK	1
736AL	1	736AK	1
744AL	1	736BK	1
818FW	1	824AK	1
820GT	1	828AK	1
824FW	1	832AK	1
824GT	1	838AK	1
828GT	1	840GT	1
830FW	1	844AK	1
834GT	1	848GT	1
835FW	1	856GT	1

Total Leads = 32

702PLR Single Lead Rack*

- 2 tiered 32 slot rack (rack only, no product)
- Complements full assortments by providing space for later model coverage.
- Economically provides coverage with minimal investment.
- Excellent for displaying coil wires or specific make/model coverage for fleets, etc.

* Includes 5 free leads to offset cost of rack



702PLA



702PLR
Bare rack only

BOOTS & NIPPLES & RETAINERS

COIL NIPPLES

Part No.	Description	Wire Diam.	Std. Pkg.
TN8E	Straight EPDM rubber	7mm	25
TN10	90° EPDM or Neoprene	7mm	10
TN17	Straight EPDM rubber (Universal application) Straight vinyl	7mm	10
TN19	Straight vinyl	7mm	25
TN20	Straight boots for ABITS coils, requires TN23 insulator, use w/ ST27 terminal	7mm	25
TN21	90° boots for ABITS coils, requires TN23 insulator, use w/ ST27 terminal	7mm	25
TN22	135° boots for ABITS coils, requires TN23 insulator, use w/ ST27 terminal	7mm	25
TN23	Insulator for ABITS coils, use with TN20, TN21, and TN22 boots and ST27 terminal	7mm	50
TN24	Aftermarket style coil boot for 1st generation Ford DIS systems, use with ST28 terminal	8mm	25
TN25	OE style coil boot for 1st generation Ford DIS systems, requires TN26 retainer clip, use with ST28 terminal	8mm	25
TN26	OE style retainer clip for 1st generation DIS systems, use with TN25 boot	8mm	25
TN27	Coil boot for 2nd generation Ford DIS systems, use with ST30 terminal	8mm	25
TN28	Ford DIS coil clip		25

Instructions for Assembling ABITS Terminals and Boots

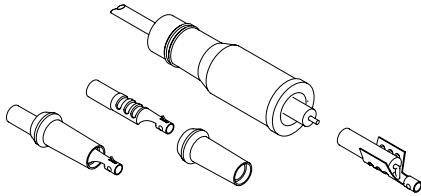

- Slide TN20, TN21, or TN22 boot over wire.
- Strip wire to reveal 1/2" of conductor.
- Fold conductor over and crimp ST27 terminal on wire.
- Slide TN23 insulator over ST27 terminal. Snap into place.
- Slide boot over terminal and insulator.

HEAT SHIELDS

Part No.	Description	Std. Pkg.
SPP33	GM heat shield. Fits SPP22 or SPP32 boots	2
SPP34	GM heat shield. Fits SPP11 or SPP31 boots	2
SPP35	Spark plug boot insulating sleeve Universal size-fits most boots-even 90° Reflects and dissipates heat up to 1200°F Protects plug wire from extremely hot exhaust manifolds & headers Excellent for race cars, motor homes & RVs	2
SPP36	Fits GM 90° spark plug boots	2
SPP37	Fits Ford 135° spark plug boots	2

SPECIAL SPARK PLUG BOOTS

Part No.	Description	Std. Pkg.
SPP7	For Buick 8 Cyl. to 1965, replaces 2965024	25
SPP8	For VW and Corvair	10
SPP20	Spark plug well seal, for VW and Corvair	25



BOOTS & NIPPLES



SPP1

SPP2

SPP3

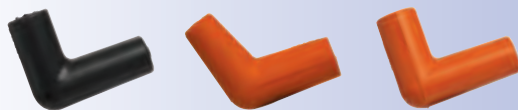

SPP4

SPP5

SPP6

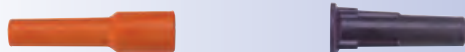

SPP10

SPP11 SPP31



SPP17

SPP15

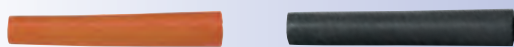

SPP19

SPP23

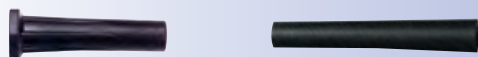

SPP22 SPP23

SPP24



SPP25

SPP29



SPP28

SPP38



SPP26
SPP30

TN7

TN7E



TN9

TN9E

TN11



TN15

TN16

TN18

STRAIGHT SPARK PLUG BOOTS

Part No.	Description	Std. Pkg.
SPP3	8mm silicone	10
SPP10	7mm silicone	50
SPP11	7mm and 8mm silicone	25
SPP15	7mm silicone	25
SPP19	7mm silicone. Chrysler type; can be used with ST119 terminals	25
SPP22	7 & 8 mm silicone for GM applications	10
SPP23	8mm silicone for Ford applications	10
SPP24	7mm Hypalon	25
SPP31	7 & 8mm severe duty brown silicone	25
SPP32	7 & 8mm severe duty brown silicone	10

IMPORT SPARK PLUG BOOTS

Part No.	Description	Std. Pkg.
SPP25	7mm bakelite with internal resistor 1000 OHMS Resistor	4
SPP38	VW boot with metal heat shield 5000 OHMS Resistor	2

ANGLED SPARK PLUG BOOTS

Part No.	Description	Std. Pkg.
SPP1	7mm silicone 90° Orange	10
SPP2	7mm silicone 90° Black	10
SPP4	8mm silicone 90° Black	10
SPP5	7mm silicone 110° Orange	10
SPP6	8mm silicone 90° Orange	10
SPP17	7mm silicone 90° ABITS Ignition	8
SPP26	8mm silicone - 135°	8
SPP28	8mm silicone 135° Ford DIS	8
SPP29	7 & 8mm severe duty brown silicone - 90°	25
SPP30	8mm severe duty gray silicone - 135°	8

DISTRIBUTOR BOOTS

Part No.	Description	Wire Dia.	Std. Pkg.
TN7	Straight vinyl	7mm	50
TN7E	Straight EPDM rubber	7mm	50
TN9	90° vinyl	7mm	10
TN9E	90° EPDM rubber	7mm	10
TN11	90° EPDM rubber	8mm	10
TN15	90° EPDM rubber (distributor coil)	8mm	10
TN16	90° EPDM rubber (AMC, Ford, GM applications)	7mm & 8mm	10
TN18	90° EPDM rubber (GM applications with short towers)	7mm	10

COIL-ON-PLUG BOOTS

COIL-ON-PLUG TECHNOLOGY

Coil-On-Plug (direct fire) technology is an important part of the new ignition systems.

Coil-On-Plug Boot multi-pack quantities are available for limited time. Sell out and re-order "E" suffix per each part numbers. "Per Car" engine kits are available for popular applications. See page A22 for complete listing of part numbers and applications.

SPP27 – sell out

SPP27E – re-order

COIL-ON-PLUG BOOTS

Part No.	Std. Pkg.	Part No.	Std. Pkg.	Description
SPP27	4	SPP27E	1	GM quad 4 spark plug boot 2.4L, 2.3L, 02-88
SPP27HT	4	SPP27HTE	1	Heavy duty all rubber version of SPP27
SPP39	4	SPP39E	1	Ford Crown Victoria, Mustang & Ford Truck, 4.6L, 5.4L, 12-97
		SPP39L	50	Box of 50 SPP39
SPP39HT	4	SPP39HTE	1	High Temperature version of SPP39
SPP40	6	SPP40E	1	Olds Aurora, Intrigue 3.5H 02-99
SPP41	8	SPP41E	1	Olds Aurora, Cadillac 4.0C 03-00
SPP42	2	SPP42E	1	Mazda 1.6L Protégé 03-99
SPP43	4			Heavy duty all rubber version of SPP27
SPP44	2	SPP44E	1	Chrysler, Concorde, Dodge Intrepid 2.7 06-98
SPP45	6	SPP45E	1	JEEP Cherokee, Grand Cherokee 4.0S 06-00
SPP46	4	SPP46E	4	Ford Mustang, Lincoln Continental 4.6V 11-97
SPP47	4	SPP47E	1	Saturn 2.2L 07-00
SPP48	2	SPP48E	1	Mazda 2.0 Protégé 03-95
SPP49	3	SPP49E	1	Lexus GS, SC 300 05-98, IS300 05-01
SPP50	2	SPP50E	1	Nissan 350Z, Infiniti G35, 3.5 06-03
SPP51	2	SPP51E	1	Nissan Pathfinder, Altima, Maxima 07-01, Infiniti 03-00
SPP52	2	SPP52E	1	Mazda Miata 1.8L 05-01
SPP53	2	SPP53E	1	Infiniti J30 3.0L 94-93
SPP54	2	SPP54E	1	Infiniti J30 3.0L 97-94
SPP55	2	SPP55E	1	Mitsubishi Galant, Mirage, Eclipse, Outlander 05-97
SPP56	2	SPP56E	1	Audi A4, S4, A6 Quattro 02-98
SPP57	2	SPP57E	1	Audi 8 cyl. A8 Quattro 98-95
SPP58	2	SPP58E	1	Audi 5 cyl. A6, S6 Quattro 98-95
SPP59	4	SPP59E	1	Dodge Ram Pickup (Hemi) 8 cyl. 5.7L 05-03
SPP60	1	SPP60E	1	Isuzu Axiom, Amigo, Rodeo, Trooper 6 cyl. 3.5X Short Type 04-00, Honda Passport 3.2L 02-00
SPP61	1	SPP61E	1	Isuzu Amigo, Rodeo, Trooper 6 cyl. 3.5X Long Type 03-00, Honda Passport 02-00
SPP62	2	SPP62E	1	Nissan 4 cyl. 2.5 Altima 09-02
SPP63	2	SPP63E	1	Hyundai Sonata 2.4L & Santa Fe 2.4L, 06-99
SPP64	2	SPP64E	1	Ford V6 Sable ME, Taurus E, 3.0L 24V 08-00
SPP65	2	SPP65E	1	GMC 6 cyl. 4.2X S10, S15 Series, Olds 6 cyl. 4.2X Bravada, GM 4 cyl. 2.8-8 ST1, 5 cyl. 3.5-6 ST1 05-02
SPP66	4	SPP66E	1	Ford V8 3.9L DOHC Thunderbird, Lincoln 05-02
SPP67	2	SPP67E	1	BMW V6 2.5L M50; BMW V8 3.0L; BMW V8 4.0L M60 96-90
SPP68	2	SPP68E	1	Lincoln LS 3.0L V6 DOHC 24V 05-00
SPP69	2	SPP69E	1	BMW L6, V8 300 Series, 500 Series, 740i, 840 ci, X5, M3, Z3 04-96
SPP70	2	SPP70E	1	Porsche 911 Turbo, Carrera, GT2, GT#, 3.6L 08-01
SPP71	2	SPP71E	1	Porsche Boxter 2.5L, 2.7L, 3.2L, 911 Carrera 3.4L 04-97
SPP72	3	SPP72E	1	Land Rover Freelander 2.5L DOHC 05-02

See page A22 for Per Car Engine Kits

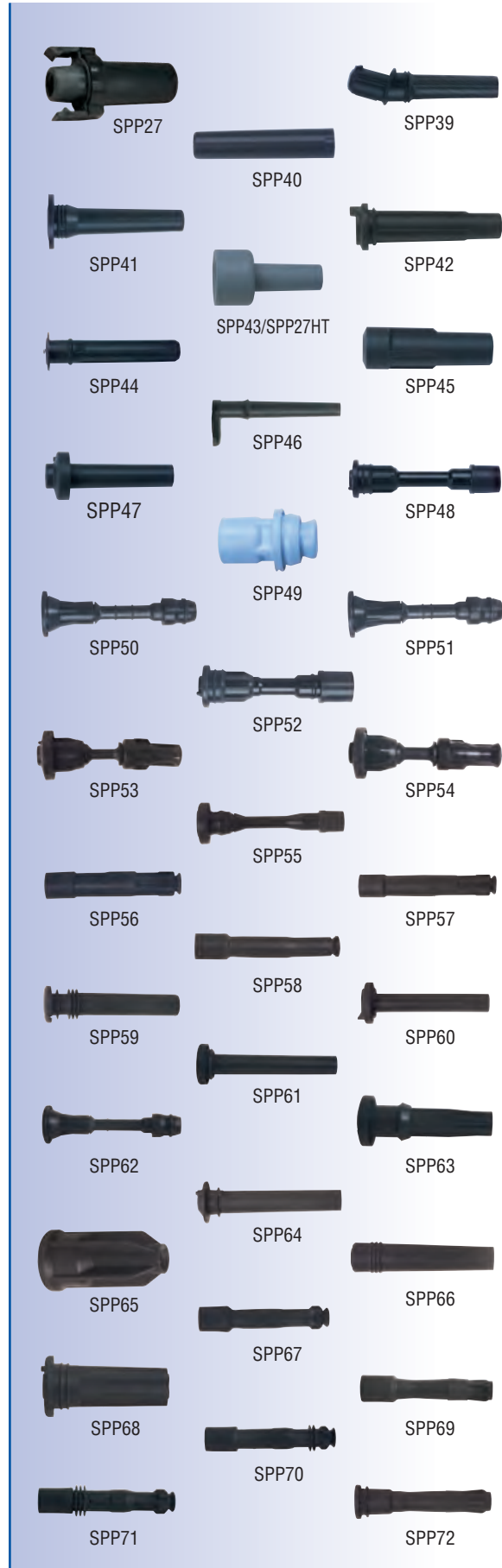

COIL-ON-PLUG BOOTS



COIL-ON-PLUG BOOTS				
Part No.	Std. Pkg.	Part No.	Std. Pkg.	Description
SPP73	2	SPP73E	1	Mitsubishi Lancer Evolution 2.0L, Turbo 06-03
SPP74	1	SPP74E	1	Mercedes Benz C230 L4 2.3L 97, L6 C36 3.6L 97-95, L6C280 2.8L 97-04, L6 E300 2.8L 93, L6E 320 3.2L 97-94, L6 S320 3.2L 99-94, L6 SL320 3.2L 97-94
SPP75	3	SPP75E	1	Toyota Avalon, Camry, Sienna, Solara 3.0L; Lexus ES300 1MZFE 01-96
SPP76	1	SPP76E	1	Infiniti I35, Nissan Maxima 6 cyl. - right bank cyl. 02-95
SPP77	1	SPP77E	1	Infiniti I30, Nissan Maxima 6 cyl. - left bank cyl. 99-94
SPP78	1	SPP78E	1	Infiniti I30, Nissan Maxima 6 cyl. - left bank cyl. 01-99
SPP79	3	SPP79E	1	Toyota 5VZFE 3.4L eng. 4-Runner, T100, Tacoma, Tundra 02-95
SPP80	2	SPP80E	1	Toyota 5EFE eng. 1.5L Paseo, Tercel 99-95
SPP81	2	SPP81E	1	Mercedes Benz SLK230 04-01
SPP82	2	SPP82E	1	Mercedes Benz S420 4.2L 8 cyl. 99-97
SPP83	2	SPP83E	1	Toyota Avalon 97-95, Camry 97-94 3.0L 1MZFE
SPP84	1	SPP84E	1	Nissan VQ35DE Eng. Pathfinder 01 cyl. 2-6
SPP85	1	SPP85E	1	Nissan VQ35DE Eng. Pathfinder 01 cyl. 1
SPP86	3	SPP86E	1	Hyundai XG350 3.5L 05-02, Kia Sedona 3.5L 05-02
SPP87	4	SPP87E	1	Ford Mustang, F series Pick Up V10 6.8L & V8 5.4L 08-05
SPP88	2	SPP88E	1	Ford Escape 2.3L 08-05, Escape Hybrid 2.3L 08-05, Mazda Tribute 2.3L 08-05, Mazda 3 2.3L, 2.0L 05-04
SPP89	2	SPP89E	1	Kia Sephia, Spectra 1.8L 04-00
SPP90	4	SPP90E	1	Ford Distributorless Coil Boot 4.6L, 5.4L eng. 02-97 - High Temperature
SPP91	2	SPP91E	1	Chevrolet Tracker, Suzuki Vitara 2.0L, 2.3L, 2.5L 06-00
SPP92	2	SPP92E	1	Suzuki L4 Esteem 1.6L, 00, cyl. 1 & 4 only
SPP93	2	SPP93E	1	Suzuki L6 Verona 2.5L 06-04
SPP94	2	SPP94E	1	Mercedes - Benz 4 cyl. C230 1.8L 05-03
SPP95	2	SPP95E	1	Kia sportage 2.0L 3FE 02-95
SPP96	2	SPP96E	1	Nissan Sentra QG18DE 1.8L 06-02
SPP97	2	SPP97E	1	Mercedes Benz C, CLK, SLK, E Series 3.0L, 3.5L, Dodge Sprinter 3.5L 07-06
SPP98	3	SPP98E	1	Nissan Maxima 3.0L VE30DE left bank 94-92
SPP99	2	SPP99E	1	Nissan Pulsa NX 1.8L, 1.6L CA18D & CA16D 89-87
SPP100	3	SPP100E	1	Nissan Maxima 3.0L VE30DE right bank 94-92
SPP101	1	SPP101E	1	Volvo V70 2.3L, 2.4L Turbo, S60, S70 2.3L, 2.4L, 2.5L 5 cyl., S80 6 cyl. 09-99
SPP102	1	SPP102E	1	Volvo 2.3L. 2.4L. 2.5L 09-04
SPP103	8	SPP103E	1	Chrysler Aspen 5.7L V8 Vin 2 Hemi 08-06
SPP104	1	SPP104E	1	Mitsubishi Lancer, Evolution Turbo 2.0L, 8/05-11/06
SPP105	1	SPP105E	1	Mitsubishi Endeavor, Galant 3.8L 07-04
SPP106	1	SPP106E	1	Ford Fusion 2.3L, Mazda 3, 6, Miata, CX-7, 08-07
SPP107	1	SPP107E	1	Ford Fusion 3.0L, Ford Escape 3.0L, Lincoln Zephyr 3.0L 07-06
SPP108	1	SPP108E	1	Jaguar XJ6 4.0L 97-95, XJS 4.0L 96-94
SPP109	1	SPP109E	1	Jaguar XJ8, Vanden Plas 4.0L 03-00, XJR 100 4.0L 02, XK8, XKR 02-00
SPP110	1	SPP110E	1	Mitsubishi Montero 3.8L 06-03

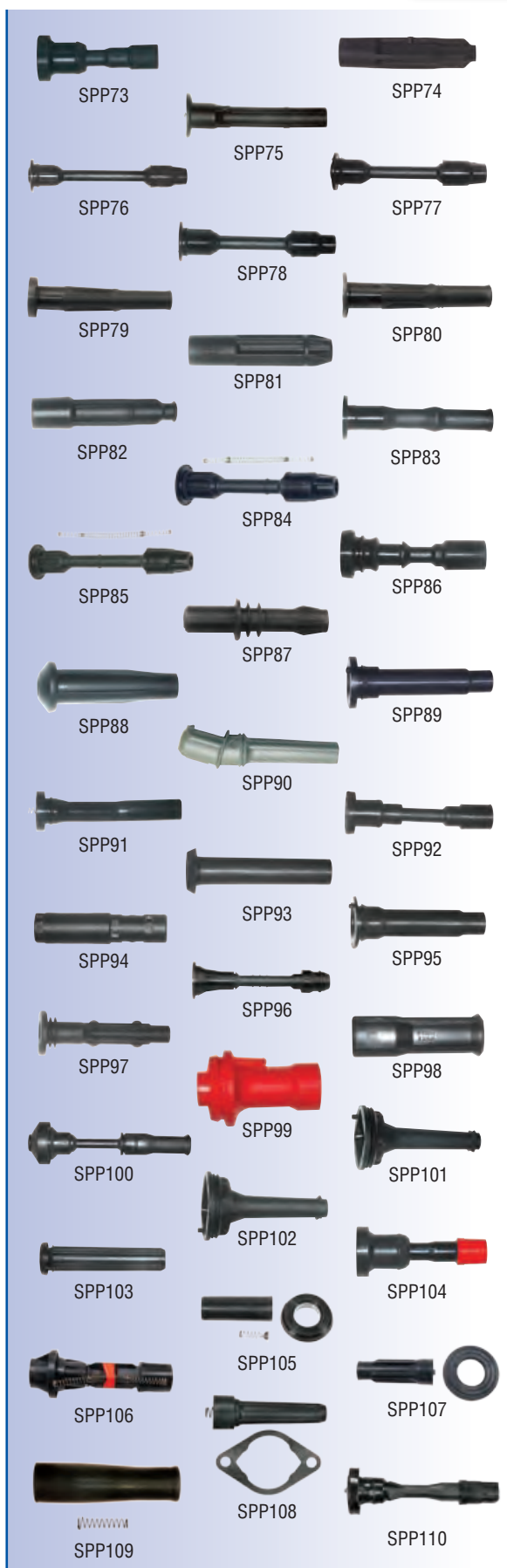

IGNITION WIRES

COIL-ON-PLUG BOOTS

COIL-ON-PLUG BOOTS

Part No.	Std. Pkg.	Description
SPP111E	1	Honda FIT L4 1.5 08-07
SPP112E	1	Porsche Cayenne 4.5L 06-03
SPP113E	1	Ford Explorer, Mustang 4.6L, F150 Truck 4.6L, 6.8L, Mercury Mountaineer 4.6L, Lincoln Navigator 5.4L 10-08
SPP114E	1	Ford Escape 3.0L V6 24V 06-05, Mazda MPV & Mazda 6 08-02
SPP115E	1	Lexus 1MZFE ES300 01-95, Toyota V6 3.0L, Avalon 99-96, Camry 01-96, Sienna 00-98
SPP116E	1	Chevrolet Cobalt, Saturn Ion L4 2.0L 07-04
SPP117E	1	Chevrolet Colorado 2.9L, 3.7L 10-07, Chevrolet Trailblazer, GMC Envoy 4.2L 09-06
SPP118E	1	Subaru Tribeca 3.6L 09-08, Outback 3.0L 09-01, Legacy 3.0L 09-08
SPP119E	1	Cadillac CTS 3.2L 04-03, Catera 01-99, Saturn L, LS, Vue 3.0L 05-00
SPP120E	1	Chevrolet Cobalt, HHR, Pontiac G5, G6, Solstice, Saturn Aura, Vue, Sky 2.0L, 2.2L, 2.4L 09-06
SPP121E	1	Subaru Legacy 2.5L H4 10-05
SPP122E	1	Mazda 5 2.3L 07-06
SPP123E	1	Lexus GS400, LS400, SC400 4.0L 00-98
SPP124E	1	Dodge Magnum, Charger, Avenger, Chrysler Sebring, 300 2.7L, 3.5L, 10-06; Chrysler Town & Country, Pacifica, Dodge Grand Caravan 4.0L 10-08; Volkswagen Routan 4.0L 10-09
SPP125E	1	Suzuki Grand Vitara V6 2.7L 08-06, SX-4 L4 2.0L 09-07
SPP127E	1	Suzuki Grand Vitara 2.4L 11-09, SX4 2.0L 11-10
SPP128E	1	Mazda 5 2.3L 10-08
SPP129E	1	Mercedes Benz SL600, CL600, S600 V12 02-96
SPP130E	1	Nissan Sentra 2.0L DOHC MR20DE 10-07
SPP131E	1	Subaru Impreza 2.0L 05-03
SPP132E	1	Nissan Versa 1.6L (HR16DE) 11-09; Nissan Cube, Versa 1.8L (MR18DE) 11-07; Nissan Sentra 2.0L (MR20DE) 11-09, Nissan Altima, Rogue, Sentra 2.5L (QR25DE) 11-07; Infiniti FX50 5.0L, M56 5.6L 12-09
SPP133E	1	Nissan Platina L4 1.6L, Renault Clio L4 1.6L, 2.0L 11-98
SPP134E	1	Infiniti Q45 4.5L 93-90 (to 2/93)
SPP135E	1	Hyundai Santa Fe, Kia Optima 2.7L 09-07
SPP136E	1	Chrysler Aspen, Dodge Dakota, Dodge Ramcharger Pickup, Jeep Commander, Cherokee 4.7L 10-07
SPP137E	1	Lexus ES350, IS350, RX350 08-07, Toyota Avalon, Camry, Highlander, RAV4, Sienna 3.5L 08-05
SPP138E	1	Dodge Dakota, Durango, Nitro, Ram 1500, Raider, Jeep Grand Cherokee, Commander Liberty 3.7L V6 11-09
SPP139E	1	Ford F250, 350 Super Duty Pickups 6.2-6 V8 12-11, F150 11-10
SPP140E	1	Lexus GS350, GS450H, IS350 3.5L, IS250 2.5L, LS460 4.6L, LS600H 5.0L, LX570 5.7L, 09; Toyota Land Cruiser, Sequoia, Tundra 5.7L 09-07
SPP141E	1	Ford Edge, Flex, Taurus; Lincoln MKS, MKX, MKZ; Mercury Sable V6 3.5L, 3.7L 10-07
SPP142E	1	Buick LaCrosse, Cadillac CTS, Chevrolet Camaro, Malibu, Equinox, Traverse, GMC Acadia, Pontiac G6, G8, Torrent; V6 3.6L, 3.0L, 2.8L 11-07
SPP143E	1	Toyota Echo 1.5L 05-00, Prius 1.5L 09-01, Yaris 1.5L 09-07, Scion XA, XB 1.5L 06-03

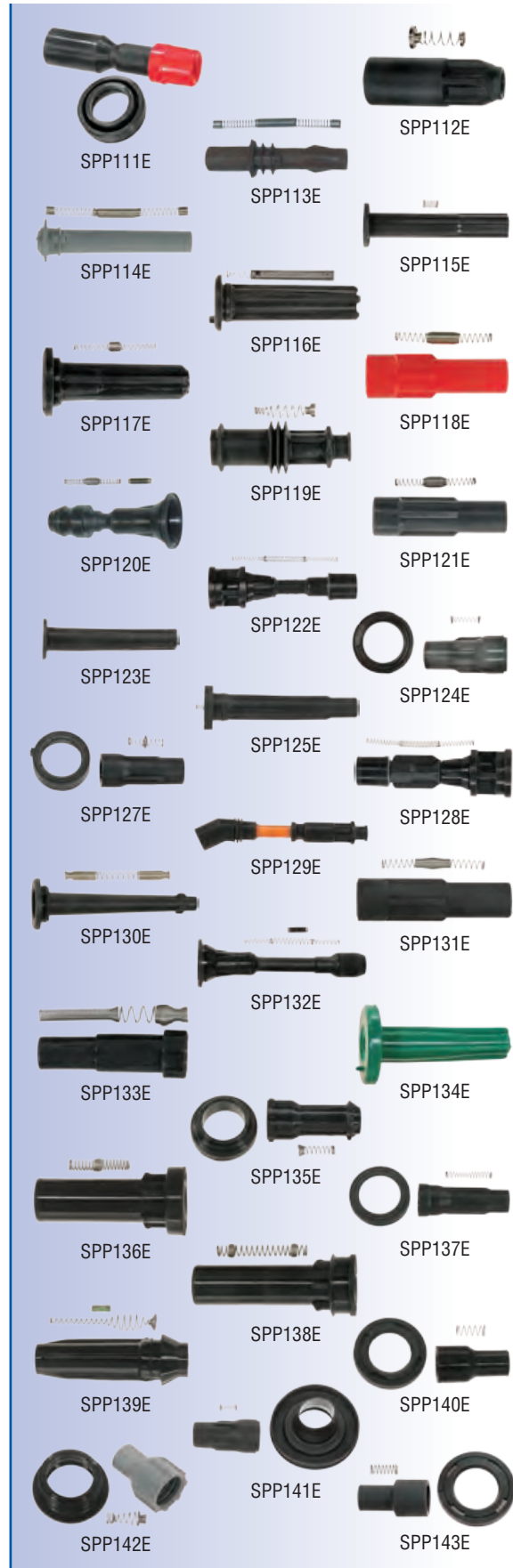

COIL-ON-PLUG BOOTS & PER CAR ENGINE KITS



COIL-ON-PLUG BOOTS

Part No.	Std. Pkg.	Description
SPP144E	1	Toyota Camry, Highlander, RAV4, Corolla, Matrix, Solara 2.4L 09-01; Toyota RAV4 2.0L 08-01; Scion TC 2.4L 09-05 (2AZFE) w/ 3/8" coil stem
SPP145E	1	Toyota Corolla, Matrix, Celica, MR2 Spyder, L4 1.8L 08-00; Pontiac Vibe 09-03, Chevrolet Prizm 02-00
SPP146E	1	Toyota Avalon, Camry, Highlander, Sienna, V6 3.0L 06-01, Lexus RX, ES300 3.0L 03-99
SPP148E	1	Toyota 4 Runner, Land Cruiser, Sequoia, Tundra V8 4.3L, 4.7L 09-04; Lexus SC, GS, LS430 4.3L, 4.7L 09-04
SPP149E	1	Toyota 4 Runner, Land Cruiser, Sequoia, Tundra V8 4.3L, 4.7L 05-98; Lexus LX470, LS, SC, GS430 4.3L, 4.7L 05-98
SPP150E	1	Toyota Tacoma L4, 2.4L, 2.7L 04-00
SPP151E	1	Toyota 4 Runner, FJ Cruiser, Tacoma, Tundra 4.0L V6 (1GRFE) 11-03; Toyota Camry, Corolla, Matrix, Solara 2.4L 10-06; Toyota Tacoma 2.7L 11-05; Lexus IS F 5.0L V8 (2URGSE) 09-08; Scion XB 2.4L (2AZFE) 09-04 w/ 4/4" coil stem
NEW! SPP152E	1	Chevrolet Aveo, Aveo 5 1.6L 11-09; Saturn Astra 1.8L 09-08
NEW! SPP153E	1	Toyota Camry, Sienna, Solara 3.3L V6 08-03
NEW! SPP154E	1	Honda Accord V6 07-03, Civic 2.0L 09-02, 1.7L 11-02, CRV 2.4L 11-03, Pilot 3.5L 08-06, Element 2.4L 05-03; Acura CSX 2.0L 11-06, EL 1.7L 06-01
NEW! SPP155E	1	Acura CL 3.2L 08-05, RL 3.5L 11-09, TL 3.2L, 3.5L, 3.7L 12-07; Honda Accord 3.0L, 3.5L 12-10; Honda Odyssey 3.5L 11-99
NEW! SPP156E	1	Chrysler 200, 300, Town & Country; Dodge Avenger, Challenger, Charger, Durango, Grand Caravan, Journey; Jeep Grand Cherokee; Jeep Wrangler (all with Chrysler Pentastar engine 3.6L) 2013-11
NEW! SPP157E	1	Chrysler Sebring, Dodge Avenger, Caliber, Jeep Compass, Patriot 2.4K 10-07
NEW! SPP158E	1	Ford F150, Mustang 5.0L 12-11
NEW! SPP159E	1	Buick Enclave 3.6D 09, Rendezvous 3.6-7 06-04; Cadillac CTS, SRX 3.6L 07-04, CTS 2.8T 07-05, STS 3.6V 09-08; Chevrolet Traverse, GMC Acadia, Saturn Outlook 3.6D 09; SAAB 9-3 09-07
NEW! SPP160E	1	Hyundai Santa Fe 2.7L 09-06; Kia Optima 2.7L 10-06; Kia Rondo 2.7L 11-07
NEW! SPP161E	1	Kia Rio 1.6L 2011-06; Hyundai Accent 1.6L 11-06
NEW! SPP162E	1	Nissan Juke 1.6L (MR16DDT) 13-11
NEW! SPP163E	1	Nissan GT-R 3.8L V6 13-09
NEW! SPP164E	1	Infiniti EX35, GX35, G37, Nissan 350Z, Altima, Maxima, Murano 3.5L, 3.7L 11-08
NEW! SPP165E	1	Ford Fusion, Escape 2.5L; Mazda Tribute 13-09
NEW! SPP166E	1	Toyota Corolla, Matrix 1.8L 13-09, Prius 1.8L 13-12; Scion 1.8L 13-09; Pontiac Vibe 1.8L 13-08
NEW! SPP167E	1	Lexus 3.5L ES350, RX350, Toyota 3.5L Avalon, Camry, Highlander, RAV4, Sienna, Venza 09-07
NEW! SPP168E	1	Toyota Corolla, Matrix XRS 1.8L 06-03, Celica GTS 1.8L 05-00
NEW! SPP169E	1	Fiat 1.4L 500 13-12 Round Coil
NEW! SPP170E	1	Fiat 1.4L 500, Dodge Dart w/Turbo 13-12 Square Coil
NEW! SPP171E	1	Ford 2.0L Escape, Focus, Edge, Fusion 14-12, Ford 2.0L Explorer, Taurus, Lincoln MKZ 14-12
NEW! SPP173E	1	Dodge Dart 2.0L DOHC, 2.4L SOHC 13
NEW! SPP175E	1	Dodge Dart 2.4L 14 L4, Jeep Cherokee 2.4L 14-13



IGNITION WIRES

PREMIUM IGNITION WIRES

PER CAR ENGINE KITS

- Application specific by engine
- Sold as standard package of 1

- Full set of boots for complete tune-up

Std. Part No.	Pkg.	Description	No. of Boots Included
CPBK100	1	GM Quad 4 Spark Plug Boot 2.4L, 2.3L 02-88	4
CPBK105	1	Quad 4 Boot heavy duty version of SPP27	4
CPBK110	1	Chevrolet Tracker, Suzuki Vitara 1.6L, 2.0L, 2.3L, 2.5L 06-99	4
CPBK120	1	Chevy Colorado 4 cyl. 2.8l, 5 cyl. 3.5L 06-04, Chevy Trailblazer, GMC Canyon, Envoy, Olds Bravada 6 cyl. 4.2X 06-02	6
CPBK130	1	Saturn 2.2L 07-00, Chevrolet Cavalier, Malibu, Cobalt, HHR 2.2L 06-00, Olds. Alero, Pontiac Sunfire, Grand Am, Pursuit 2.2L 06-02	4
CPBK140	1	Olds Aurora 4.0C, Cadillac 4.6 03-00	8
CPBK200	1	Ford Distributorless Coil Boot 4.6L,5.4L, 6.8L 08-97	8
CPBK205	1	Ford Distributorless Coil Boot 4.6L,5.4L Engines 07-97 - High Temperature	8
CPBK210	1	Ford Escape 2.3L 05, Escape Hybrid 2.3L 06-05, Mazda Tribute 2.3L 06-05, Mazda 3 2.3L, 2.0L 05-04	4
CPBK220	1	Ford Escape, Mazda Tribute 3.0-1 08-01, Ford 500, Freestyle 3.0L 07-05, Ford Taurus E, Sable ME, V6 3.0S 24V DOHC 04, 00	6
CPBK230	1	Ford GT, Mustang, Lincoln Continental, Mark VIII 4.6V DOHC 07-97	8
CPBK240	1	Ford Mustang, F series Pick Up V10 6.8L and V8 5.4L 06-05 SOHC	8
CPBK250	1	Ford V8 3.9L DOHC Thunderbird, Lincoln LS 07-02	8
CPBK260	1	JEEP Cherokee, Grand Cherokee 4.0S 06-00	6
CPBK300	1	Chrysler Concorde, Dodge Intrepid 2.7R 08-98	6
CPBK400 **	1	Infiniti I30 VQ30DE 01-00, Nissan Maxima 01-99 6 cyl. Right bank and Left bank cylinders (3 ea.)	6
CPBK405 **	1	Infiniti I30 VQ30DE 01-96, Nissan Maxima 99-95 6 cyl. Right bank and Left bank cylinders (3 ea.)	6
CPBK410 **	1	Infiniti QX4, Nissan VQ35DE Eng. Pathfinder 02-01 cyl 1 and 2-6 (1 and 5)	6
CPBK420	1	Nissan 4 cyl. 2.5 Altima, Sentra 06-02	4
CPBK430	1	Nissan 350Z 06-03, Infiniti G35, 3.5 06-03	6
CPBK440 **	1	Nissan Maxima 3.0L 94-92 VE30DE - Left bank and Right bank (3 ea.)	6
CPBK450	1	Nissan Pathfinder, Altima, Maxima 06-01, Infiniti I30, QX4, I35, M45, Q45 06-00, Nissan Armada 5.6L, Infiniti Q45, M45 4.5L 07-05	6
CPBK460	1	Nissan Sentra QG18DE 1.8L 06-02	4
CPBK500 **	1	Honda Passport 3.2L 02-00, Isuzu Axiom, Amigo, Rodeo, Trooper cyl. 6, 3.5X Short Type (1) and Long Type (5) 04-98	6
CPBK600	1	Toyota Avalon 95, Camry 97-94 3.0L 1MZFE	6
CPBK700	1	Audi A4, S4, A6 Quattro 02-98 – Volkswagen Passat	4
CPBK710	1	BMW L6, V8 300 series, 500 series, 740i, 840ci, X5, M3, Z3 02-96	6
CPBK720	1	Volvo 5 cyl. C70 05-99, S60 05-01, S70 05-99, V70 05-99; 6 cyl. S80 05-99	5

** Varying boot combinations for certain applications

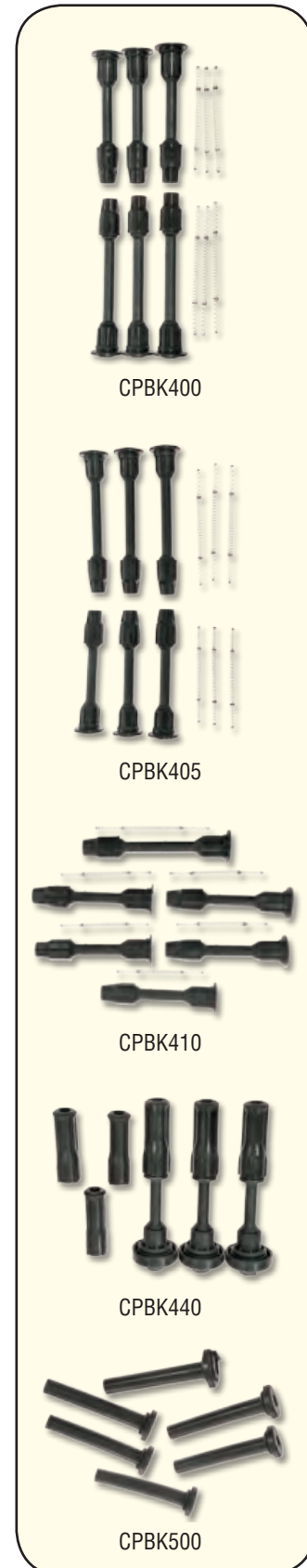

UNIVERSAL IGNITION WIRES



IGNITION WIRE RETAINER RINGS

Part No.	Description	Std. Pkg.
6600R*	Retainer ring for 4 cylinder, in-line 6 cylinder GM engines	1
6800R	Retainer ring for V6 and 8 cylinder GM engines with HEI ignition systems	1

* Available until supply lasts

WIRE SEPARATORS

Part No.	Description	Std. Pkg.
ET61	Spark plug wire separator for 8mm	4
ET66	Ignition wire clips - snap to hold up to 4 wires neatly in specific routing pattern, 7 & 8mm	2
ST522	Spark plug wire separator for 8 & 9mm wire	1 Set
ST523	Spark plug wire separator for 7mm wire	1 Set

BULK IGNITION WIRE

100 Ft. Spool	25 Ft. Spool	Jacket	Core Type	Color
CC7L	CD7L	7mm Silicone/Silicone Hi Perf.	Tinned Copper	Yellow
CC7M		7mm Silicone/Silicone	Mag Suppression	Grey
CC7S	CD7S	7mm Silicone/Silicone	Suppression	Black
CC7D		7mm EPS / EPDM	Suppression	Black
CC7N		7mm EPDM / EPDM	Tinned Copper	Black
CC8M		8mm Silicone/Silicone	Mag Suppression	Grey
CC8S		8mm Silicone/Silicone	Suppression	Grey
CC8LC	CC8LL†	8mm Silicone/Silicone Hi Perf.	Tinned Copper	Yellow
CC75C		7.5mm EPDM Hi Perf.	Mag Suppression	Red
CC85C		8.5mm EPDM Hi Perf.	Mag Suppression	Red

† 50 ft. spool

SECONDARY TERMINALS

Part No.	Description	Wire Diam	Qty. per Pkg.
ST106	Straight	7mm	100
ST107	90°	7mm	100
ST113	Straight	7+8mm	50
ET113			8
ST114	90°	7+8mm	50
ET114	(Also used as distributor terminal on 8mm wire)		8
ST119	Bendable (to 90°)	7+8mm	50
ST122	Straight, Long for 3 piece boots	8mm	25
ST131	135° Snap-lock	7+8mm	50

* ET Display Pkg.

Silicone Dielectric Compound for module heat dissipation, lubrication of spark plug boots, and corrosion protection for electrical connection. Vital in preventing spark plug boots from sticking to spark plugs. A thin coating of compound to the inner lip of spark plug boot protects against spark plug adhesion and prolongs the wire set life.

SL3 — 1 gram per packet. Std. pkg 10 packets

SL4 — 1.25 oz per tube. Std. pkg 10 tubes

Contains: Dimethylpolysiloxane

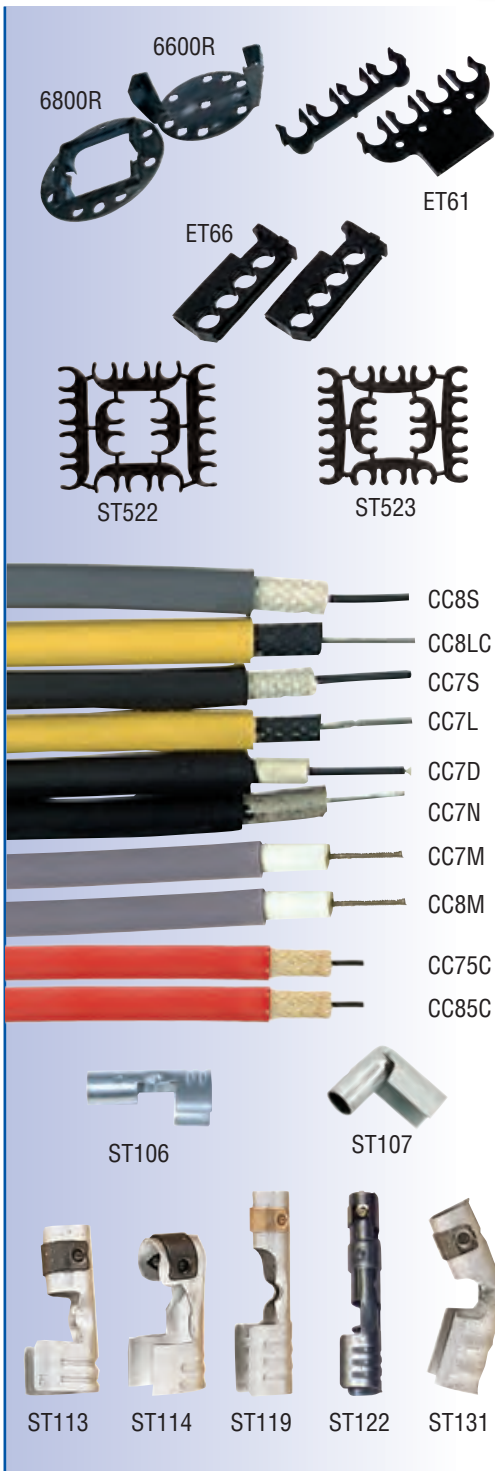

IGNITION WIRES

RETAINERS, IGNITION WIRE & TERMINALS

DISTRIBUTOR TERMINALS

Part No.	Description	Wire Diam.	Qty per Pkg.
ST22	For "strip and fold" wire	7mm	100
ST25	Terminal with 3/8" spike, for non-strippable wire		100
ST26 ET26	Straight	7mm	100 10
ST27	Stainless steel bendable terminal for ABITS coils, use w/ TN20, TN21, and TN22 boots, requires TN23 insulator	7mm	50
ST28	Stainless steel bendable terminal for 1st generation Ford DIS coils, use w/ TN24 and TN25 boots	8mm	50
ST30	Brass bendable terminal for 2nd generation Ford DIS coils, use w/ TN27 boot	8mm	25
ST115	Staple for non-strippable resistance-type wire. Provides continuity between terminal and core		100
ST116 ET116	90°, install with WTT4 tool	7mm	100 8
ST120	Stainless Steel forked terminal - Chrysler (4 cyl.) applications	7mm	10
ST121	90° Coil Terminal	8mm	25

* ET Display Pkg

STA10 WIRE TERMINAL ASSORTMENT

Assortment of popular ignition wire terminals plus WTT4 Crimpmaster tool. CONTENTS — 126 pieces

Part No.	Qty.	Part No.	Qty.
ST22	25	ST114	15
ST25	10	ST116	5
ST26	10	ST119	10
ST106	25	TN7E	5
ST107	10	WTT4	1
ST113	10		

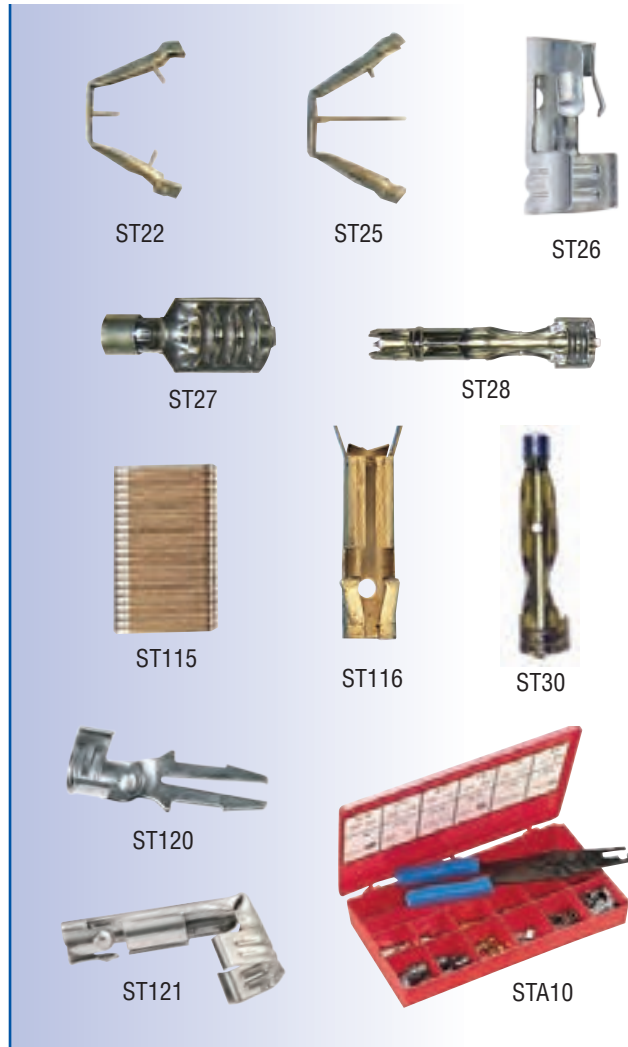

IGNITION WIRE MAKE-UP TECHNIQUES

1. Measure and cut a length of wire that is 1/4" longer than the original wire. Slide the desired boot onto the wire, using oil or soapy water as a lubricant if necessary. Check for proper orientation.
2. Using the 14 gauge "notch" on stripping tool, strip each end of the wire. Be careful not to damage the core during stripping.
3. The bare core should be 1/8" longer than the crimping area on the terminal used.
4. Starting with the spark plug end, fold the core back over the outer jacket tightly and hold the tuck while the plug terminal is positioned so the barrel of the terminal traps the folded core against the jacket.
5. Using the notch marked "7 & 8mm", squeeze the tabs on the terminal so they encircle the wire completely. Make final crimps at several locations along the barrel of the terminal. Make sure the terminal is securely crimped and that no excess core ("tail") is exposed.
6. Slide boot over terminal.

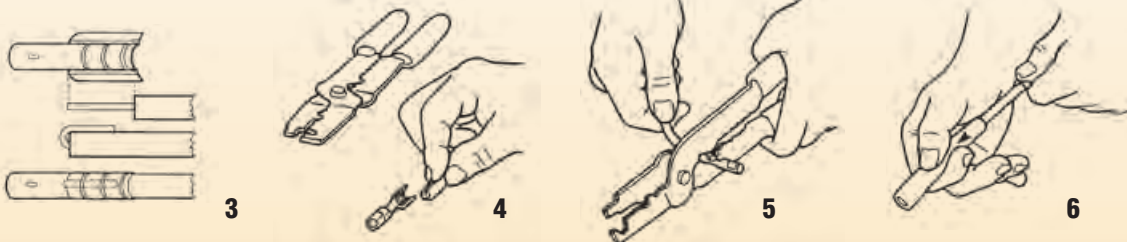

IGNITION WIRE & TERMINALS



WIRING TOOLS

WTT4 Crimpmaster

- 10" long; display packed
- For professional crimps on ignition wire terminals and 90° terminals, insulated and uninsulated solderless terminals (including "W" crimps)
- Stripping notches for 22 to 10 ga. primary wire
- Std. Pkg. 1

WTT5 Crimp 'N Cut

- 8" long; boxed
- Strips wire, crimps terminals, cuts screws
- Color-coded crimping notches for insulated solderless terminals
- Wire cutter plus stripping notches for 22 to 10 gauge primary wire
- Special crimping nest for 7mm ignition wire terminals
- Std. Pkg. 1
- **ET10** display version of WTT5

WTT6 Wire Stripper

- The original "Miller Stripper"
- Cuts and strips wire from 24 to 10 gauge, with adjusting cam
- Individually bagged
- Std. Pkg. 5

ET100 Economy Crimping Tool

- 8" long, display packed
- Cuts and strips primary wire 26 to 10 gauge
- Crimps insulated and non-insulated terminals
- Std. Pkg. 1

WTT17 Premium Crimping Tool

- 8" long, display packed
- Cuts and strips primary wire 26 to 10 gauge
- Crimps insulated and non-insulated terminals
- Cushion grip handles
- Precision ground
- Made in the U.S.A.
- Std. Pkg. 1

WTT18 Premium Crimping Tool

- 8-5/8" long
- Professional crimps on primary wire
- Crimps connectors 22-10 gauge
- Adjustable tension
- Molded hand grips
- Added leverage eases hand fatigue
- Std. Pkg. 1

WTT27 Easy Stripper

- 8½" long; boxed
- Self adjusting stripper
- Cuts and strips 26-10 gauge wire
- Crimps insulated and non-insulated terminals
- Cushion grip handles.
- Std. Pkg. 1

WTT38 Premium Spark Plug Boot Puller

- 5 Position Adjustable Jaws
- Made in the U.S.A.
- Std. Pkg. 1

WTT39 Spark Plug Boot Puller

- Made in the U.S.A.
- Std. Pkg. 1

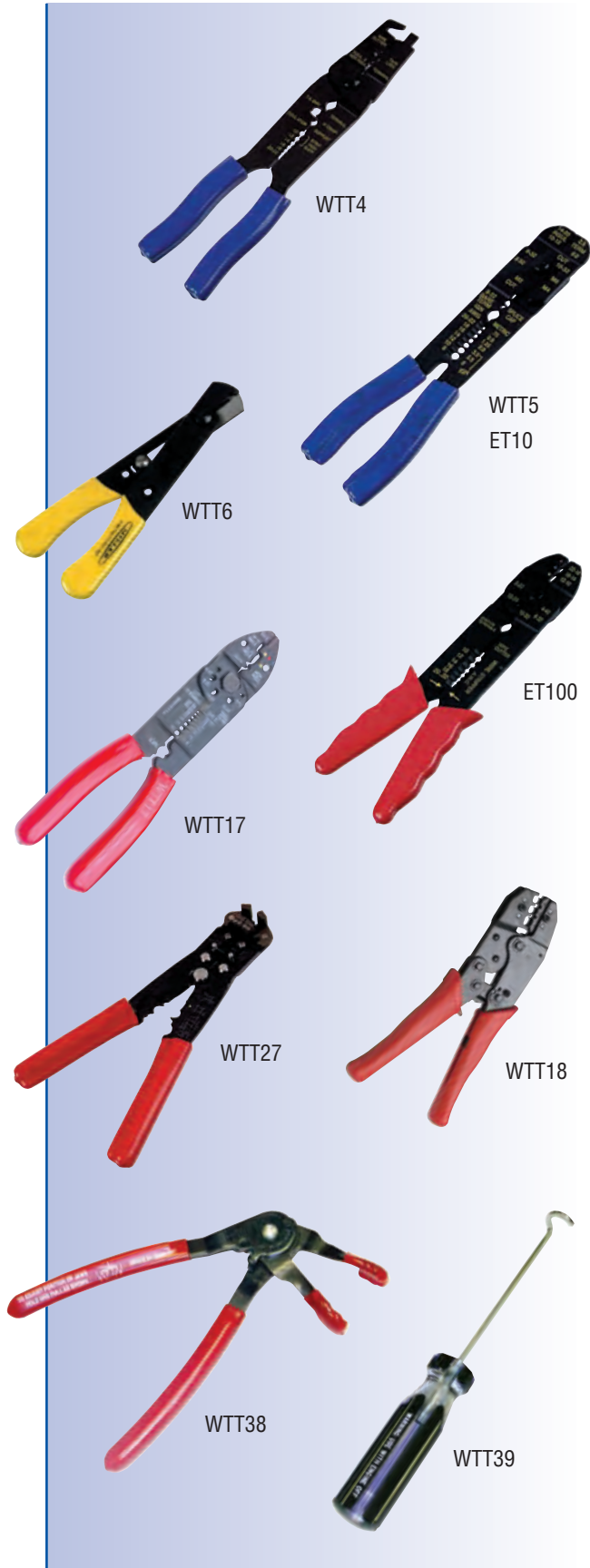



Ignition Wires

Battery Cables

Primary Wire

Terminals & Connectors

Trailer Connectors

Sockets, Pigtails & Switches

Safety Accessories

O.E. Interchanges

Index

BATTERY CABLES

BATTERY CABLES QUALITY ENGINEERED FROM END TO END...

1. Terminals

Precision diecast electrolytic grade lead alloy.

2. Casting

Overlaps cable insulation to protect cable from corrosion (the prime cause of cable failure).

3. Steel skeleton

Embedded in casting for extra strength and more reliable electrical connection.

4. Lug

Formed by high-pressure crimping a plated copper thimble onto a section of stripped cable. The resulting lug is an integral solid mass that makes an extremely reliable connection.

5. Cable

Composed of multiple strands of 99% pure copper for maximum flexibility and conductivity. High conductivity cable helps assure easier cold weather starts.

6. Hi-Temperature Outer Jacket

Tough, durable crosslinked synthetic rubber (not PVC or vinyl). Won't burn, soften or melt on contact with hot engine parts. Also resists corrosive action of gasoline and battery acid. Meets SAE J1127, Rated at 105°C/221°F.

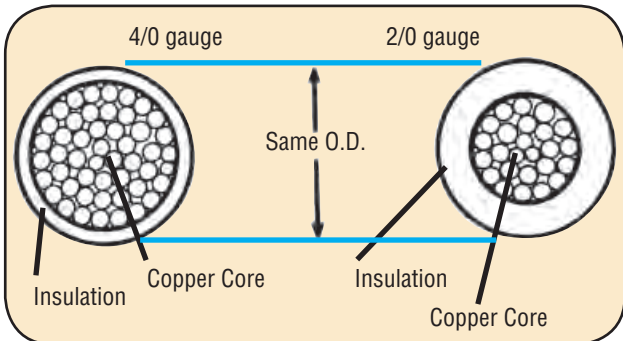
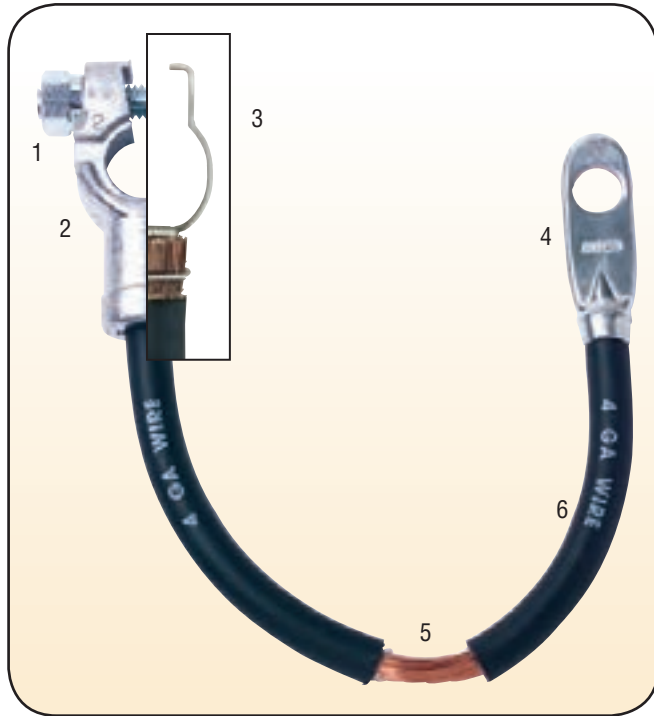

WARNING:

These products contain chemicals known to the State of California to cause cancer, and birth defects or other reproductive harm.

...KNOW YOUR BATTERY CABLES

- The outside diameter of a cable may have nothing to do with its "gauge". The gauge is determined by the cross-sectional area of the copper core. (See illustration above.)
- Doubling the length of a cable will double its electrical resistance (ohms).
- A longer cable must have a larger copper core (smaller gauge number) than a shorter cable, in order to carry the same current without excessive voltage drop.



BATTERY CABLES & GROUND STRAPS



CABLE IDENTIFICATION SYSTEM

The following chart explains what you can learn about a cable from the part number.

- PREFIX** - All cables have a prefix letter: **A** or **B**.
Prefix A - indicates an insulated cable.
Prefix B - indicates an uninsulated cable (metal braid).
- NUMERALS** - The numerals before the dash indicate the length of the cable in inches (center-to-center). See figure 1.
- The numeral(s) after the dash indicate the wire gauge.
- SUFFIX** - The suffix letter(s) indicate the cable type. Cable types are explained below.

Suffix	Type	Suffix	Type
No Suffix	Lead top-post terminal with lug	LF	Switch-to-starter, one 1/4" lug, one 3/8" lug
ACN	Lug to lug	LH	Switch-to-starter, two 1/2" lugs
ACP	Lug to lug	LM	Switch-to-starter, two 1/4" lugs
AEN	GM type top terminal, NEG w/o aux post	LT	Switch-to-starter w/ auxiliary lead
AEP	GM type top terminal, POS w/o aux post	LTF	Switch-to-starter w/ auxiliary lead, w/ fusible link
APN	GM type top terminal, NEG w/ aux post	PN	Lug to lug
APP	GM type top terminal, POS w/ aux post	PP	Lug to lug
C	Chrysler type, lead top-post two auxiliary leads	RDF	Ford type top terminal, w/ fusible link
CLT	Lead-free top-post terminal with center lug(s)	RDN	Ford type top terminal, NEG w/o aux post
D	GM type side terminal, one auxiliary lead	RDP	Ford type top terminal, POS w/o aux post
DA	GM type side terminal, one 8 Ga. auxiliary lead w/ butt splice connector or ring terminal	RPP	Ford type top terminal, POS w/ aux post
DB	GM type side terminal, multiple battery diesel w/ auxiliary leads on both ends	T	Lead-free top-post terminal, no auxiliary leads
DBB	GM type side terminal, multiple battery diesel w/ auxiliary lead on one end	TA	Lead-free top-post terminal, one auxiliary lead 6 Ga. or larger May also include detached starter lead
DBN	GM type side terminal, multiple battery diesel w/ no auxiliary leads	TAF	Lead-free top-post terminal, fusible link in main cable, one or two auxiliary leads
DC	GM side terminal, w/ one auxiliary lead 6 Ga. or larger	TB	Lead-free top-post terminal, one auxiliary wire 6 Ga. or larger
DD	GM type side terminal, w/ two auxiliary leads	TC	Lead-free top-post terminal, w/ primary wire auxiliary leads
DE	GM type side terminal, two auxiliary leads 6 Ga. or larger	TCC	Lead-free top-post terminal, w/ primary wire auxiliary leads one from lug end or center
DF	GM type side terminal, w/ custom auxiliary lead w/ fusible link	TD	Lead-free top-post terminal, w/ one auxiliary lead from lug end 6 Ga. or larger
DFB	GM type side terminal, multiple battery diesel w/ fusible link auxiliary lead	TL	Lead-free top-post terminal, terminal bolts to lug to lug cable w/ 90° lug
DG	GM side terminal, w/ one auxiliary lead 6 Ga. or larger, and one smaller auxiliary lead	TLA	Lead-free top-post terminal, w/ auxiliary lead 6 Ga. or larger
DN	GM type side terminal, no auxiliary leads	TLCL	Lead-free top-post terminal, terminal bolts to lug to lug cable w/ 90° lug, w/ center lug
DS	GM type side terminal, w/ auxiliary lead from lug end	U	Lead top-post terminal, w/ one auxiliary lead
E	Ground strap, non insulated, lead top-post terminal w/ multiple lugs	UA	Lead top-post terminal, w/ one 8 Ga. auxiliary lead. May also include detached starter lead
F	Lead cable w/ fusible link auxiliary wire	UAB	Lead top-post terminal, w/ auxiliary lead w/ OE type auxiliary lead from lug end
FLN	Lug to lug	UAC	Lead-free top-post terminal w/ auxiliary lead w/ OE type auxiliary lead from lug end
FLP	Lug to lug	UC	Lead-free top-post terminal three auxiliary leads, one from terminal and two from center splice
G	Ground strap, non insulated, lug to lug	UD	Lead-free top-post terminal w/ auxiliary lead from both ends
GEN	Lug to lug	UDC	Lead-free top-post terminal w/ auxiliary lead from both ends with ring terminals
GEP	Lug to lug	UH	Lead top-post terminal, w/ one auxiliary lead, w/ 1/2" lug
H	Dual battery jumper, two lead top-post terminals	UHC	Lead-free top-post terminal, w/ one auxiliary lead w/ ring terminal, 1/2" lug
HBD	GM type side terminal, dual battery diesel, w/ one auxiliary lead 6 Ga. or larger	UHCL	Lead top-post terminal, w/ one auxiliary lead from lug end, 1/2" lug
HD	GM type side terminal, w/ one auxiliary lead 6 Ga. or larger	UT	Lead-free top-post terminal, w/ one auxiliary lead w/ butt splice connector
HDA	GM type side terminal, w/ auxiliary leads on both ends	UTC	Lead-free top-post terminal, w/ one auxiliary lead w/ ring terminal
HDCL	GM type side terminal, w/ one auxiliary lead, w/ center lug		
HDD	GM type side terminal, w/ one auxiliary lead 6 Ga. or larger		
HP	Multiple battery lead top-post, w/ auxiliary lead		
K	Stackable for stud top (group 31) batteries		
KN	Lug to lug		
KP	Lug to lug		
L	Switch-to-starter, lug to lug		

Example

A	40	—	2	D
Prefix "A" (insulated)	40" long		Wire Gauge	Suffix "D" (Side Term.)

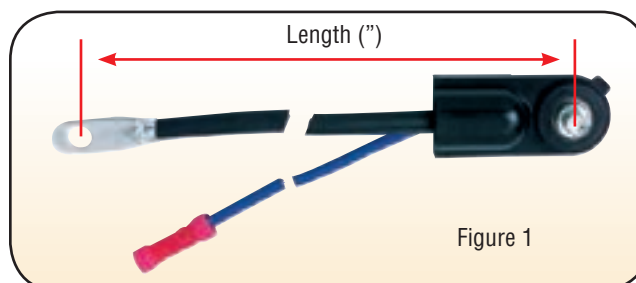

Figure 1

BATTERY CABLES

INSULATED BATTERY CABLES (PREFIX "A")

No Suffix Conventional Cables

6 Gauge	4 Gauge	2 Gauge	1 Gauge	2/0 Gauge*
A12-6	A10-4	A12-2	A12-1	A12-00
A17-6	A14-4	A36-2	A16-1	A18-00
A24-6	A16-4	A42-2	A19-1	A24-00
A29-6	A19-4		A23-1	A30-00
A36-6	A22-4		A27-1	A36-00
	A26-4		A30-1	A42-00
	A30-4		A35-1	A48-00
	A36-4		A42-1	A54-00
	A42-4		A53-1	A60-00
	A45-4		A58-1	A66-00
	A48-4		A65-1	NEW! A71-00
	A56-4		A73-1	A72-00
	A62-4		A78-1	
	A84-4			

* For heavy duty and fleet applications – lug for 1/2" bolt

Lead Terminal

Lug for 3/8" Bolt



2/0 cable – Lug for 1/2" Bolt

Suffix "ACN" Lug To Lug

	Gauge	Length
A27-8ACN	8	27"
A40-6ACN	6	40"

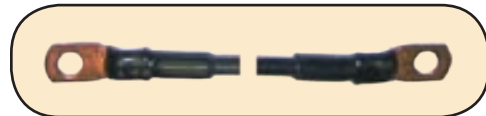

Suffix "ACP" Lug To Lug

	Gauge	Length
A18-6ACP	6	18"



Suffix "AEN" GM Type Top Terminal, NEG Without Aux Post

	Gauge	Aux. Lead
NEW! A24-4AEN	4	8 Ga. x 13"
NEW! A33-4AEN	4	4 Ga. x 16"
A35-4AEN	4	8 Ga. x 14"
A49-4AEN	4	6 Ga. x 10"
A14-2AEN	2	
A57-2AEN	2	4 Ga. x 10"
A58-2AEN	2	6 Ga. x 13"
A61-2AEN	2	4 Ga. x 20"

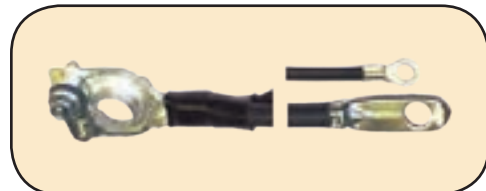

Suffix "AEP" GM Type Top Terminal, POS Without Aux Post

	Gauge	Aux. Lead
NEW! A36-4AEP	4	6 Ga. x 20"
A39-4AEP	4	6 Ga. x 17"
A49-2AEP	2	4 Ga. x 27"
A52-2AEP	2	4 Ga. x 18"
A78-2AEP	2	4 Ga. x 23"
A224-2AEP	2	8 Ga. x 10"

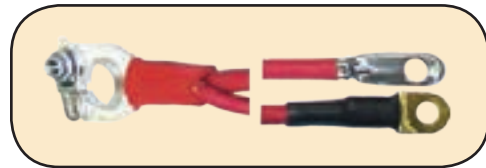

Suffix "APN" GM Type Top Terminal, NEG With Aux Post

	Gauge	Aux. Lead 1	Aux. Lead 2
NEW! A28-2APN	2	4 Ga. x 13"	n/a
A49-2APN	2	4 Ga. x 22"	12 Ga. x 18"



Suffix "APP" GM Type Top Terminal, POS With Aux Post

	Gauge	Aux. Lead
A54-4APP	4	n/a
A55-4APP	4	4 Ga. x 24"
NEW! A61-2APP	2	n/a
A199-2APP	2	8 Ga. x 9"

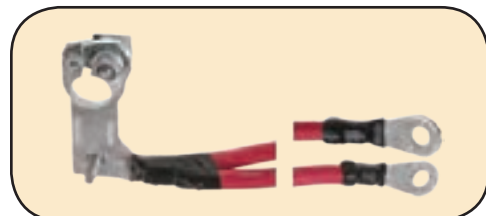

BATTERY CABLES



INSULATED BATTERY CABLES (PREFIX "A")

Suffix "C" Chrysler Type, Lead Top-Post Two Auxiliary Leads

	Gauge	Aux. Lead #1	Aux. Lead #2
A26-6C	6	6 Ga. x 10"	12 Ga. x 9"
A41-6C	6		
A50-6C	6		
A60-6C	6		
A66-6C	6		
A72-6C	6		
A73-6C*	6		
NEW! A33-0C	1/0	8 Ga. x 36"	10 Ga. x 19"
A34-0C	1/0	10 Ga. x 29"	8 Ga. x 17"

* Includes solenoid pigtail

Suffix "CLT", "CLTA", "CLTB", "CLTC", "CLTD" Lead-Free Top-Post Terminal With Center Lug(s)

	Gauge	Length	Bat. To Center Lug	Bat. To Center Lug 2
A17-6CLT	6	17"	9"	
A24-6CLT	6	24"	15"	
A25-6CLT	6	25"	14"	
A28-6CLT	6	28"	12"	
A29-6CLT	6	29"	20"	
A30-6CLT	6	30"	15"	
A32-6CLT	6	33"	18"	
A34-6CLT	6	34"	17"	
A35-6CLT	6	35"	12"	25"
A37-6CLT	6	37"	9"	
A38-6CLT	6	39"	13"	
A39-6CLT	6	39"	10"	
A46-6CLT	6	46"	17"	
A47-6CLT	6	48"	12"	
A59-6CLT	6	59"	9"	
A25-4CLT	4	26"	14"	
A30-4CLT	4	30"	6"	
A30-4CLTA	4	31"	17"	
A31-4CLT	4	31"	15"	
A32-4CLT	4	32"	10"	
A32-4CLTA	4	32"	15"	
A34-4CLT	4	34"	13"	
A35-4CLT	4	36"	13"	
A35-4CLTA	4	35"	17"	
A36-4CLT	4	36"	21"	
A37-4CLT	4	37"	16"	
A38-4CLT	4	39"	28"	
A39-4CLT	4	40"	21"	
A40-4CLT	4	40"	27"	
A40-4CLTA	4	40"	14"	
A40-4CLTB	4	40"	8"	
A40-4CLTD	4	40"	28"	
A42-4CLT	4	43"	12"	30"
A42-4CLTA	4	42"	15"	
A44-4CLT	4	44"	32"	
A46-4CLT	4	47"	20"	
A48-4CLT	4	48"	7"	36"
A49-4CLT	4	50"	30"	
A52-4CLTC	4	52"	15"	
A57-4CLT	4	58"	20"	
A58-4CLT	4	58"	28"	
A65-4CLT	4	65"	32"	
A23-2CLT	2	23"	16"	
A23-2CLTB	2	23"	15"	
A27-2CLT	2	27"	16"	
NEW! A28-2CLT	2	28"	13"	
A30-2CLT	2	30"	15"	
A31-2CLT	2	31"	14"	
A31-2CLTB	2	31"	11"	
A33-2CLT	2	33"	16"	
A35-2CLT	2	35"	15"	
A35-2CLTB	2	35"	13"	
A36-2CLT	2	36"	11"	
NEW! A39-2CLT	2	39"	21"	
A41-2CLT	2	41"	20"	

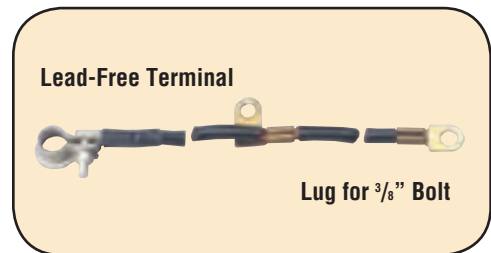
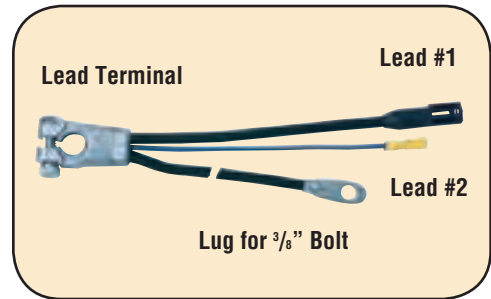

BATTERY CABLES

BATTERY CABLES

INSULATED BATTERY CABLES (PREFIX "A")

Suffix "D" GM Type Side Terminal With One Auxiliary Lead

4 Gauge			2 Gauge			1/0
A10-4D	A35-4D	A55-4D	A14-2D	A40-2D	A65-2D	A13-0D ¹
A20-4D	A40-4D	A60-4D	A20-2D	A45-2D	A70-2D	A56-0D ¹
A25-4D	A45-4D	A65-4D	A25-2D	A50-2D	A76-2D	A95-0D ²
A30-4D	A50-4D		A30-2D	A55-2D	A90-2D	
			A35-2D	A60-2D		
Fusible Link Lead 14 Ga. x 9"			Aux. Lead 10 Ga. x 9"			Aux. Lead
¹ 10 Ga. x 9"		² 8 Ga. x 12"				

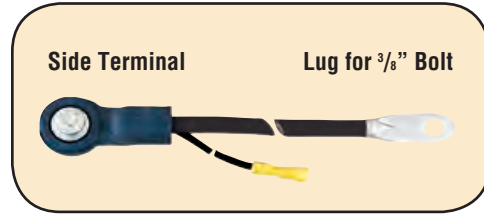

Suffix "DA" GM Type Side Terminal, One 8 Ga. Aux Lead With Butt Splice Connector Or Ring terminal

4 Gauge	Aux. Lead	2 Gauge	Aux. Lead
A20-4DA	8 Ga. x 8"	A35-2DA	8 Ga. x 15"
A25-4DA	8 Ga. x 8"	A40-2DA	8 Ga. x 15"
A27-4DA	14 Ga. x 10"	A60-2DA	8 Ga. x 58"
A30-4DA	8 Ga. x 8"	A85-2DA	8 Ga. x 15"
A35-4DA	8 Ga. x 8"	A90-2DA	8 Ga. x 15"
A40-4DA	8 Ga. x 8"	A95-2DA	8 Ga. x 15"
A45-4DA	8 Ga. x 8"		
A50-4DA	8 Ga. x 8"		
A55-4DA	8 Ga. x 8"		
A60-4DA	8 Ga. x 8"		

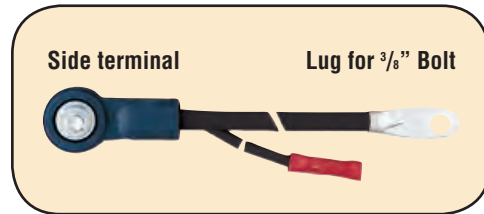

Suffix "DAC" Side Terminal Cable With Auxiliary Lead

	Gauge	Aux. Lead
A23-4DAC	4	8 Ga. x 12"
A23-2DAC	2	8 Ga. x 14"
A28-2DAC	2	8 Ga. x 10"
A32-2DAC	2	8 Ga. x 10"
A33-2DAC	2	8 Ga. x 36"
A53-2DAC	2	8 Ga. x 33"
A30-0DAC	1/0	8 Ga. x 12"
A32-0DAC	1/0	8 Ga. x 12"
A46-0DAC	1/0	8 Ga. x 27"
A63-0DAC	1/0	8 Ga. x 9"

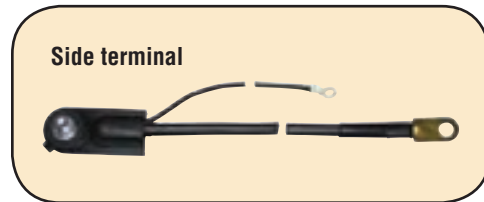

Suffix "DB", "DBB", "DFB", "DBN", "HBD" Dual Side Terminal / Dual Battery

	Aux. Lead 1	Aux. Lead 2
A8-2DBN	-	-
A30-2DBN	-	-
A63-2HBD	4 Ga. x 37"	4 Ga. x 20"
A65-2DB	8 Ga. x 8"	8 Ga. x 8"
A65-2HBD	6 Ga. x 35"	
A70-2DB	8 Ga. x 8"	8 Ga. x 8"
A72-2DBB	8 Ga. x 15"	
A87-2DB	8 Ga. x 8"	8 Ga. x 8"
A87-2DBB	6 Ga. x 48"	
A87-2DFB	8 Ga. x 18"*	
A88-2DFB	6 Ga. x 34"	8 Ga. x 18"*

* With fusible link

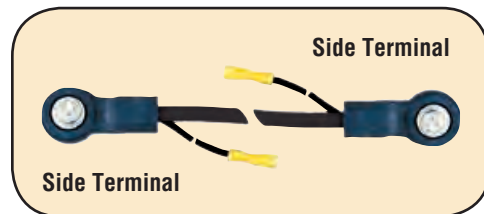

Suffix "DC" GM Type Side Terminal With One Auxiliary Lead 6 Ga. Or Larger

2 Gauge	Aux. Lead
A47-2DC	6 Ga. x 34"
A48-2DC	6 Ga. x 33"

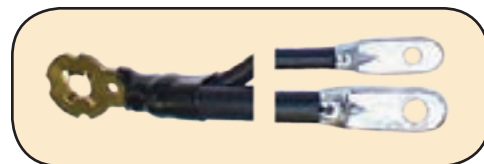

Suffix "DD" GM Type Side Terminal, With Two Auxiliary Leads

4 Gauge	Aux. Lead 1	Aux. Lead 2	2 Gauge	Aux. Lead 1	Aux. Lead 2
A28-4DD	10 Ga. x 11"	10 Ga. x 11"	A31-2DD	10 Ga. x 11"	10 Ga. x 11"
A35-4DD	8 Ga. x 15"	12 Ga. x 12"	A56-2DD	8 Ga. x 15"	12 Ga. x 12"
A40-4DD	12 Ga. x 8"	12 Ga. x 7"*			

* With fusible link

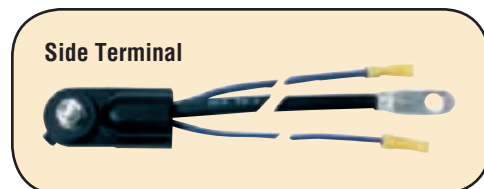

BATTERY CABLES



BATTERY CABLES

INSULATED BATTERY CABLES (PREFIX "A")

Suffix "DDC" Side Terminal With 2 Auxiliary Leads

	Aux. Lead 1	Aux. Lead 2
A33-2DDC	8 Ga. x 36"	10 Ga. x 13"
A36-2DDC	8 Ga. x 36"	10 Ga. x 13"
A44-2DDC	8 Ga. x 23"	10 Ga. x 27"
A53-2DDC	8 Ga. x 12"	10 Ga. x 13"

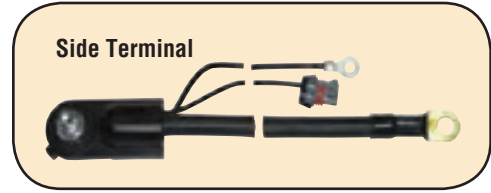

Suffix "DDF" Side Terminal With 2 Auxiliary Leads

	Gauge	Aux. Lead 1	Aux. Lead 2
A40-4DDF	4	10 Ga. x 8"	8 Ga. x 32" w/ fusible link
A41-4DDF	4	10 Ga. x 13"	8 Ga. x 33" w/ fusible link
A45-4DDF	4	10 Ga. x 13"	8 Ga. x 18" w/ fusible link
A16-2DDF	2	10 Ga. x 20"	6 Ga. x 99" w/ fusible link
A18-2DDF	2	10 Ga. x 50" w/ fusible link	6 Ga. x 18" w/ fusible link
A42-2DDF	2	8 Ga. x 81" w/ fusible link	8 Ga. x 46" w/ fusible link
A46-2DDF	2	4 Ga. x 66" w/ fusible link	6 Ga. x 27" w/ fusible link
A47-2DDF	2	6 Ga. x 17"	6 Ga. x 27" w/ fusible link
A70-2DDF	2	10 Ga. x 8"	8 Ga. x 18" w/ fusible link
A45-0DDF	1/0	10 Ga. x 8"	6 Ga. x 27" w/ fusible link
A47-0DDF	1/0	4 Ga. x 66" w/ fusible link	6 Ga. x 27" w/ fusible link

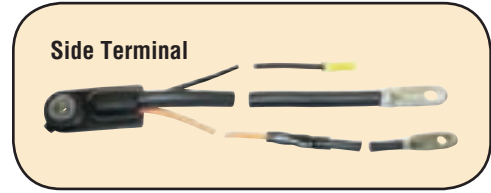

Suffix "DE" and "DEE" GM Type Side Terminal, 2 Aux Leads 6 Ga. Or Larger

	Gauge	Aux. Lead 1	Aux. Lead 2
A38-4DE	4	6 Ga. x 83"	6 Ga. x 66"
A40-4DE	4	4 Ga. x 28"	6 Ga. x 37"
A41-4DE	4	6 Ga. x 82"	6 Ga. x 34"
A42-4DE	4	6 Ga. x 25"	6 Ga. x 46"
A42-4DEE	4	6 Ga. x 78"	6 Ga. x 29"
A43-4DE	4	6 Ga. x 29"	6 Ga. x 14"
A44-4DE	4	6 Ga. x 26"	6 Ga. x 37"
A48-4DE	4	6 Ga. x 25"	6 Ga. x 46"
A54-4DE	4	4 Ga. x 37"	6 Ga. x 49"
A68-4DE	4	6 Ga. x 41"	6 Ga. x 46"
A64-2DE	2	4 Ga. x 51"	6 Ga. x 36"
A68-2DE	2	6 Ga. x 13"	6 Ga. x 27"

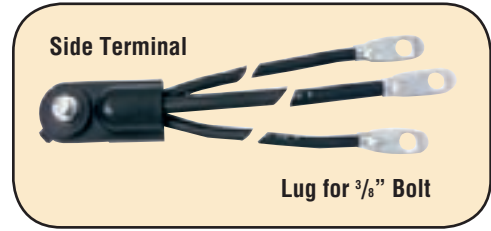

Suffix "DEF" Side Terminal With 2 Auxiliary Leads

	Aux. Lead 1	Aux. Lead 2
A41-4DEF	4 Ga. x 9"	4 Ga. x 24" w/ fusible link
A42-4DEF	6 Ga. x 77"	4 Ga. x 32" w/ fusible link
A41-2DEF	4 Ga. x 24"	4 Ga. x 44" w/ fusible link
A49-2DEF	4 Ga. x 21" w/ fusible link	4 Ga. x 35" w/ fusible link
A58-2DEF	6 Ga. x 34"	6 Ga. x 61" w/ fusible link

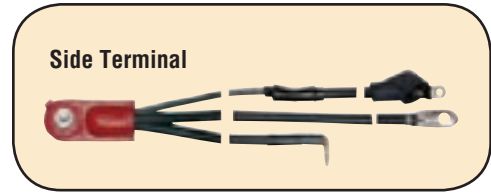

Suffix "DF" GM Type Side Terminal With Custom Auxiliary Lead With Fusible Link

	Gauge	Aux. Lead
A40-4DF	4	10 Ga. x 19" w/ fusible link
A46-4DF	4	12 Ga. x 25" w/ fusible link
A38-2DF	2	8 Ga. x 79" w/ fusible link
A41-2DF	2	8 Ga. x 18" w/ fusible link
A43-2DF	2	6 Ga. x 31" w/ fusible link
A70-2DF	2	8 Ga. x 18" w/ fusible link
A50-0DF	1/0	6 Ga. x 31" w/ fusible link

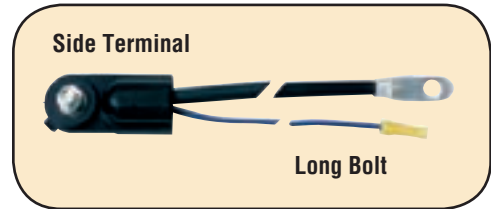

Suffix "DG" GM Side Terminal, With 1 Aux Lead 6 Ga. Or Larger, And 1 Smaller Aux Lead

	Gauge	Aux. Lead 1	Aux. Lead 2
A35-4DG	4	6 Ga. x 25"	10 Ga. x 15"
A43-4DG	4	6 Ga. x 27"	12 Ga. x 12"
A45-4DG	4	6 Ga. x 17"	8 Ga. x 23"
A46-4DG	4	6 Ga. x 19"	8 Ga. x 8"
A26-2DG	2	4 Ga. x 25"	18 Ga. x 15"
A28-2DG	2	4 Ga. x 30"	18 Ga. x 15"
A40-2DG	2	6 Ga. x 23"	14 Ga. x 8"
A67-2DG	2	6 Ga. x 19"	8 Ga. x 8"

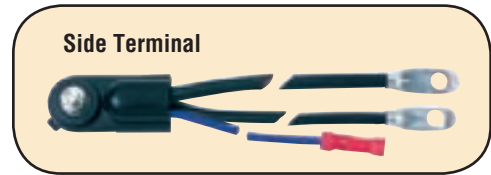

Suffix "DG2" Side Terminal Cable With 2 Auxiliary Leads

	Gauge	Aux. Lead 1	Aux. Lead 2
A27-4DG2	4	4 Ga. x 25"	16 Ga. x 10"
A28-2DG2	2	4 Ga. x 17"	18 Ga. x 15"

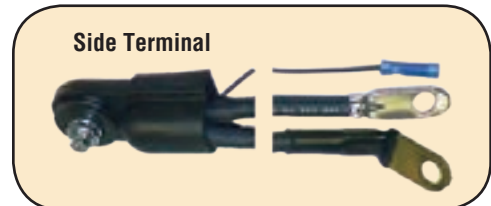

BATTERY CABLES

INSULATED BATTERY CABLES (PREFIX "A")

Suffix "DN" GM Type Side Terminal Without Auxiliary Lead

6 Gauge	4 Gauge	2 Gauge	1/0 Gauge
A8-6DN A18-6DN A46-6DN	A21-4DN A25-4DN A35-4DN A65-4DN A66-4DN	A10-2DN A14-2DN A80-2DN	A28-0DN A35-0DN A70-0DN

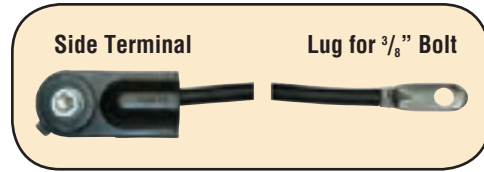

Suffix "DNCL" Side Terminal With Center Lug

	Length	Length to Center Lug
A19-4DNCL	19"	7"
A22-4DNCL	22"	7"
A25-4DNCL	25"	7"

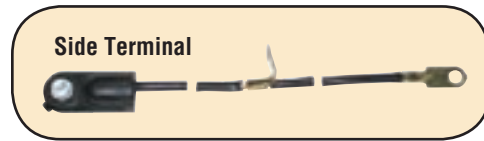

Suffix "DS" GM Type Side Terminal, With Auxiliary Lead From Lug End

6 Gauge	Fusible Link
A95-6DS	12 Ga. x 8"

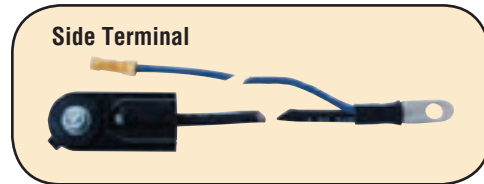

Suffix "FLP"

	Gauge	Aux. Lead
A100-2FLP	2	10 Ga. x 31"
A59-0FLP	1/0	n/a



Suffix "GEN"

	Gauge	Length
A43-6GEN	6	43"
A24-4GEN	4	24"
A17-1GEN	1	17"
A24-1GEN	1	24"
A31-1GEN	1	31"
A42-1GEN	1	42"



Suffix "GEP"

4 Gauge	Length
A21-4GEP	21"



Suffix "H" Dual Battery Jumper, Two Lead Top-Post Terminals

2 Gauge	1 Gauge	2/0 Gauge	
A8-2H A12-2H A15-2H	A8-1H A12-1H A15-1H A18-1H	A8-00H A12-00H A19-00H	A24-00H A36-00H A48-00H



Suffix "HD" GM Type Side Terminal, With One Auxiliary Lead 6 Ga. Or Larger

6 Gauge	Aux. Lead
A45-6HD	6 Ga. x 12"
A60-6HD	6 Ga. x 52"
A84-6HD	6 Ga. x 33"

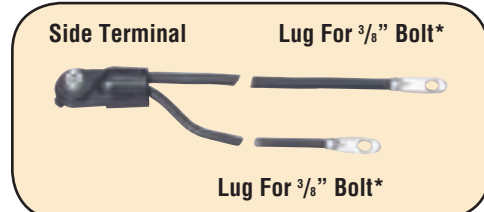

BATTERY CABLES



BATTERY CABLES

INSULATED BATTERY CABLES (PREFIX "A")

Suffix "HD" GM Type Side Terminal, With One Auxiliary Lead 6 Ga. Or Larger

4 Gauge	Aux. Lead	4 Gauge	Aux. Lead
A11-4HD	6 Ga. x 18"	A35-4HD2	4 Ga. x 12"
A16-4HD	6 Ga. x 13"	A36-4HD	4 Ga. x 20"
A20-4HD	6 Ga. x 95"	A37-4HD	6 Ga. x 27"
A21-4HD	6 Ga. x 14"	A39-4HD	4 Ga. x 40"
A22-4HD	4 Ga. x 16"	A40-4HD	6 Ga. x 14"
A23-4HD	4 Ga. x 16"	A41-4HD	6 Ga. x 23"
A25-4HD	6 Ga. x 26"	A42-4HD	6 Ga. x 10"
A26-4HD	6 Ga. x 14"	A43-4HD	4 Ga. x 25"
A29-4HD	6 Ga. x 26"	NEW! A43-4HD2	6 Ga. x 20"
A30-4HD	6 Ga. x 29"	NEW! A44-4HD	6 Ga. x 11"
A31-4HD	6 Ga. x 32"	A48-4HD	6 Ga. x 16"
A32-4HD	6 Ga. x 32"	A49-4HD	6 Ga. x 12"
A32-4HD2	6 Ga. x 11"	NEW! A51-4HD	6 Ga. x 8"
A33-4HD	6 Ga. x 48"	A52-4HD	6 Ga. x 13"
A34-4HD	6 Ga. x 25"	A55-4HD	6 Ga. x 8"
A35-4HD	4 Ga. x 14"		

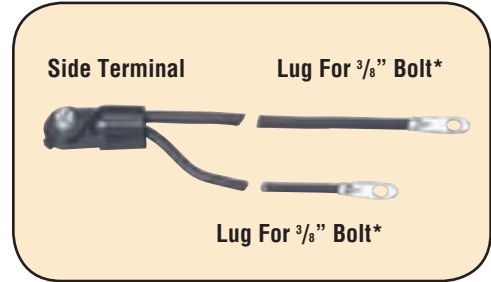

Suffix "HD" GM Type Side Terminal, With One Auxiliary Lead 6 Ga. Or Larger

2 Gauge	Aux. Lead	2 Gauge	Aux. Lead
A10-2HD	6 Ga. x 14"	A46-2HD	6 Ga. x 36"
A21-2HD	6 Ga. x 14"	A55-2HD	6 Ga. x 14"
A30-2HD	4 Ga. x 13"	A66-2HD	6 Ga. x 9"
A34-2HD	6 Ga. x 13"	A68-2HD	6 Ga. x 38"
A35-2HD	4 Ga. x 12"	A70-2HD	6 Ga. x 82"
A36-2HD	6 Ga. x 27"	A73-2HD	6 Ga. x 82"
A37-2HD	4 Ga. x 13"	A136-2HD	6 Ga. x 18"
A38-2HD	4 Ga. x 14"	NEW! A144-2HD	6 Ga. x 16"
A40-2HD	6 Ga. x 23"	A152-2HD	6 Ga. x 17"
A42-2HD	4 Ga. x 41"		
A43-2HD	6 Ga. x 30"		
A44-2HD	6 Ga. x 24"		
A45-2HD	6 Ga. x 41"		

Suffix "HD" GM Type Side Terminal, With One Auxiliary Lead 6 Ga. Or Larger

1 Gauge	Aux. Lead	1/0 Gauge	Aux. Lead	Aux. Lead	2/0 Gauge
A55-1HD	6 Ga. x 18"	A37-0HD	6 Ga. x 14"	10 Ga. x 20"	NEW! A68-00HD
		A46-0HD	4 Ga. x 16"		
		A70-0HD	6 Ga. x 20"		
		A73-0HD	6 Ga. x 19"		
		A87-0HD	4 Ga. x 16"		
		A92-0HD	6 Ga. x 21"		
		A94-0HD	4 Ga. x 16"		
		A245-0HD	6 Ga. x 17"		
		A272-0HD	6 Ga. x 17"		

Suffix "HDA" GM Type Side Terminal, With Auxiliary Leads On Both Ends

	Gauge	Aux. Lead From Terminal	Aux. Lead From Lug End
A83-6HDA	6	6 Ga. x 33"	8 Ga. x 15"
A32-4HDA	4	16 Ga. x 14" w/ fusible link	12 Ga. x 18" w/ fusible link
A33-4HDA	4	8 Ga. x 14"	8 Ga. x 18" w/ fusible link*
A37-4HDA	4	6 Ga. x 11"	6 Ga. x 24" w/ fusible link*
A41-4HDA	4	4 Ga. x 19"	6 Ga. x 31" w/ fusible link*
A42-4HDA	4	8 Ga. x 23"	14 Ga. x 15" w/ fusible link
A16-2HDA	2	14 Ga. x 8"	8 Ga. x 31"
A70-2HDA	2	4 Ga. x 20"	10 Ga. x 42" w/ fusible link*
A16-0HDA	1/0	12 Ga. x 12"	6 Ga. x 35"
A36-0HDA	1/0	4 Ga. x 16"	10 Ga. x 20" *
A137-0HDA	1/0	6 Ga. x 23"	8 Ga. x 15"

*From auxiliary lead

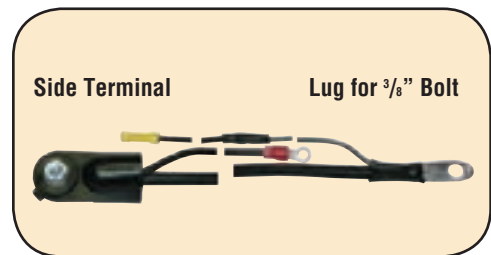

BATTERY CABLES

INSULATED BATTERY CABLES (PREFIX "A")

Suffix "HDCL" GM Type Side Terminal, With One Aux Lead, With Center Lug

	Battery To Center Lug	Aux. Lead
A35-4HDCL	17"	6 Ga. x 15"
A35-4HDCL2	22"	6 Ga. x 15"
A76-2HDCL	26"	6 Ga. x 18"
A75-2HDCL	23"	4 Ga. x 16"
A78-2HDCL	31"	4 Ga. x 16", 6 Ga. x 33"
A79-2HDCL	31"	4 Ga. x 16"

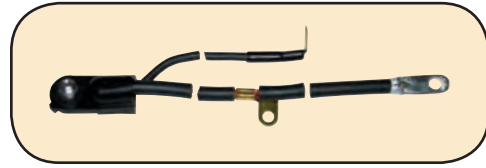

Suffix "HDD" GM Type Side Terminal With One Auxiliary Lead 6 Ga. Or Larger

2 Gauge	Aux. Lead
A35-2HDD	6 Ga. x 30"
A44-2HDD	6 Ga. x 44"
NEW A48-2HDD	4 Ga. x 20", 4 Ga. x 20", 10 Ga. x 20"

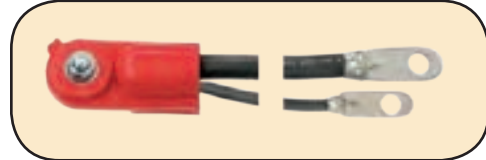

Suffix "HP" Multiple Battery Lead Top-Post With Auxiliary Lead

2/0 Gauge	Aux. Lead	Battery To Battery
A116-00HP Ford Diesel Cable Center with Die Cast Terminal Aux. Lead	10 Ga. x 22"	62"
A123-00HP	6 Ga. x 37"	66"

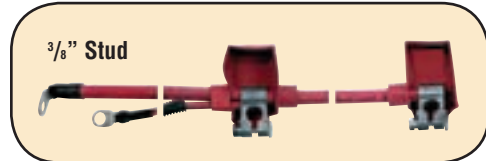

Suffix "KN" Lug To Lug

	Gauge	Aux. Lead 1	Aux. Lead 2
NEW A21-8KN	8	16 Ga. x 4"	
A26-6KN	6	16 Ga. x 10"	16 Ga. x 10"



Suffix "KP" Lug To Lug

	Gauge	Aux. Lead
NEW A6-6KP	6	14 Ga. x 6 1/2"
A45-6KP	6	14 Ga. x 10"
A47-6KP	6	14 Ga. x 10" (2)
A44-2KP (Top-Post)	2	14 Ga. x 10"



Suffix "L" Switch-To-Starter, Lug To Lug

10 Gauge	8 Gauge	6 Gauge	4 Gauge	2 Gauge	1 Gauge
A5-10L	A8-8L	NEW A4-6L	A10-4L	A13-2L	A12-1L
	NEW A10-8L	A6-6L	A14-4L	NEW A21-2L	A15-1L
	A11-8L	NEW A7-6L	A15-4L	A22-2L	A19-1L
	NEW A17-8L	A13-6L	A16-4L	A23-2L	A32-1L
		A14-6L	A18-4L	A25-2L	A49-1L
		A18-6L	A19-4L	A26-2L	A60-1L
		A19-6L	A20-4L	A27-2L	A68-1L
		A24-6L	A24-4L	A30-2L	
		A27-6L	A30-4L	A33-2L	
		NEW A30-6L	A38-4L	A40-2L	
		A34-6L	A40-4L	A41-2L	
		A40-6L	A43-4L	A43-2L	
		A44-6L	A51-4L	A46-2L	
		A53-6L	A60-4L	A83-2L	
			A69-4L		
			NEW A125-4L*		
			NEW A143-4L*		

* Dual battery cable

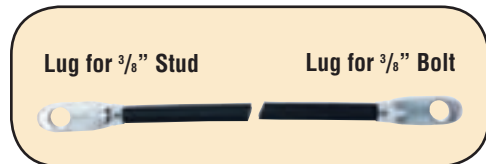

Suffix "LF" and "LFF" Switch-To-Starter, One 1/4" Lug, One 3/8" Lug

4 Gauge	2 Gauge
A12-4LF	A12-2LF
A16-4LF	
A20-4LF	
A30-4LF	
A36-4LF	
A40-4LF	
A40-4LFF	
A43-4LF	
A52-4LF	
A54-4LF	
A58-4LF	
A60-4LF	
A65-4LF	
A67-4LF	

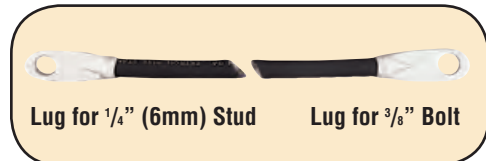

BATTERY CABLES



BATTERY CABLES

INSULATED BATTERY CABLES (PREFIX "A")

Suffix "LH" Switch-To-Starter, Two 1/2" Lugs

4 Gauge				
A20-4LH	A24-4LH	A28-4LH	A33-4LH	A40-4LH

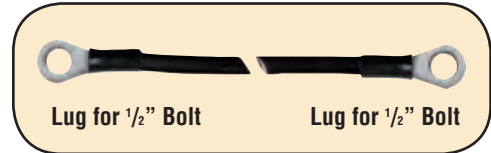

Suffix "LM" Switch-To-Starter, Two 1/4" Lugs

6 Gauge			
A8-6LM	A16-6LM	A24-6LM	A30-6L

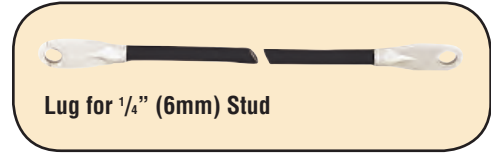

Suffix "LT" Switch-To-Starter With Auxiliary Lead

6 Gauge	Aux. Lead	4 Gauge	Aux. Lead	2 Gauge	Aux. Lead
A7-6LT	12 Ga. x 12"	A16-4LT	6 Ga. x 24"	A52-2LT	4 Ga. x 16"
		A33-4LT	6 Ga. x 39"	A53-2LT	6 Ga. x 54"
		A48-4LT	6 Ga. x 55"	A55-2LT	6 Ga. x 55"
				A57-2LT	6 Ga. x 54"

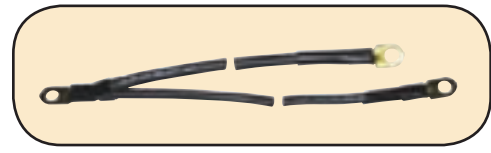

Suffix "LTF" Switch-To-Starter With Auxiliary Lead, With Fusible Link

4 Gauge	Aux. Lead	2 Gauge	Aux. Lead
A36-4LTF	4 Ga. x 16" w/ fusible link	A52-2LTF	4 Ga. x 46" w/ fusible link
A49-4LTF	4 Ga. x 46" w/ fusible link		
A53-4LTF	4 Ga. x 43" w/ fusible link		
A58-4LTF	4 Ga. x 55" w/ fusible link		
A65-4LTF	4 Ga. x 38" w/ fusible link		



Suffix "PN" Lug-To-Lug

6 Gauge	Length	Aux. Lead
A11-6YP	11"	
A12-6PN	12"	
A15-6PN	15"	
A22-6HN	22"	
A23-6PN	23"	6 Ga. x 16"
A45-6YN	45"	
A78-6PN	78"	6 Ga. x 14"
A84-6PN	84"	6 Ga. x 18"
A100-6PN	100"	



Suffix "PP" Lug-To-Lug

6 Gauge	Length
A9-6PP	9"
A22-6PP	22"

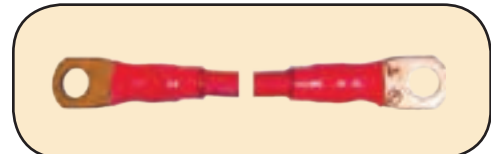

Suffix "RD" Ford Type Top Terminal

	Gauge	Aux. Lead 1
A30-4RD	4	6 Ga. x 15"
A28-0RD	1/0	n/a

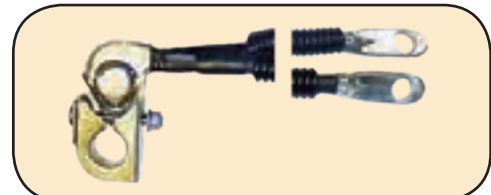

Suffix "RDF" Ford Type Top Terminal, With Fusible Link

4 Gauge	Aux. Lead 1	Aux. Lead 2
A55-4RDF	4 Ga. x 37"	4 Ga. x 32" w/ fusible link
A60-4RDF	4 Ga. x 30"	
A76-4RDF	4 Ga. x 28"	

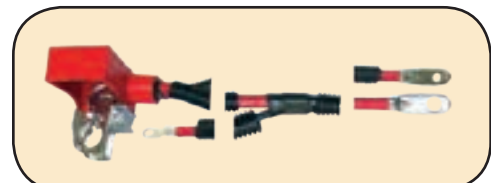

BATTERY CABLES

INSULATED BATTERY CABLES (PREFIX "A")

Suffix "RDN" Ford Type Top Terminal, NEG Without Aux Post

	Gauge	Aux. Lead 1	Aux. Lead 2
NEW! A16-4RDN	4	n/a	
NEW! A22-4RDN	4	6 Ga. x 16"	
NEW! A23-4RDN	4	6 Ga. x 16"	
A24-4RDN	4	6 Ga. x 15"	
A29-4RDN	4	4 Ga. x 13"	
A32-4RDN	4	6 Ga. x 11"	
A33-4RDN	4	4 Ga. x 9"	
A49-4RDN	4	6 Ga. x 16"	
A66-4RDN	4	8 Ga. x 14"	8 Ga. x 43"
A69-4RDN	4	8 Ga. x 15"	8 Ga. x 9"
A70-4RDN	4	8 Ga. x 12"	
A19-2RDN	2	n/a	
A24-2RDN	2	n/a	
A37-0RDN	1/0	2 Ga. x 11"	8 Ga. x 12"

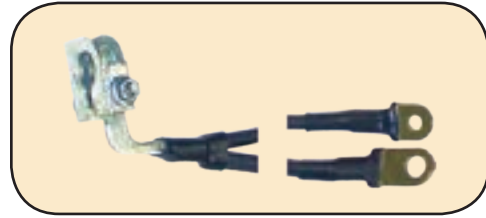

Suffix "RDP", "RPP" Ford Type Top Terminal, POS

4 Gauge	Aux. Lead 1	2 Gauge	Aux. Lead 1
NEW! A28-4RDP	4 Ga. x 25"	NEW! A25-2RPP	6 Ga. x 22"
A55-4RDP	4 & 6 Ga. x 62"	NEW! A26-2RDP	4 Ga. x 72"
A62-4RPP	n/a	NEW! A27-2RPP	4 Ga. x 26"
A63-4RPP	4 Ga. x 37"	NEW! A41-2RPP	4 Ga. x 22"
		NEW! A64-2RPP	n/a

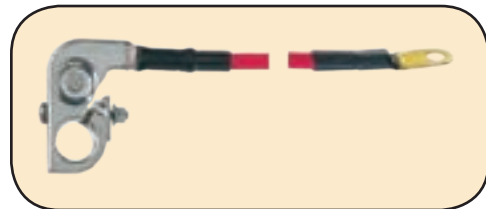

Note: Product may be different from photograph

Suffix "T" Lead-Free Top-Post Terminal, No Auxiliary Leads

6 Gauge	4 Gauge		2 Gauge
A6-6T	A10-4T	A39-4T	NEW! A6-2T
A10-6T	A11-4T	A42-4T	A10-2T
A12-6T	A12-4T	A43-4T	A15-2T
A18-6T	A16-4T	A48-4T	A18-2T
A24-6T	A22-4T	A56-4T	A40-2T
A30-6T	A30-4T		A43-2T
A36-6T	A33-4T		
A40-6T	A36-4T		

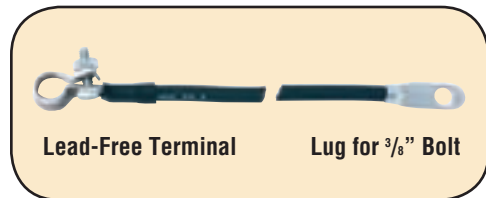

Lead-Free Terminal

Lug for 3/8" Bolt

Note: Product may be different from photograph

Suffix "TA" Lead-Free Top-Post Terminal, One Auxiliary Lead 6 Ga. Or Larger

	Gauge	Aux. Lead 1	Aux. Lead 2
NEW! A21-6TA	6	6 Ga. x 13"	
A24-6TA	6	4 Ga. x 16"	
A30-6TA	6	4 Ga. x 63"	12 Ga. x 72"
A31-6TA	6	6 Ga. x 10"	
A34-6TA	6	6 Ga. x 14"	12 Ga. x 7"
NEW! A35-6TA	6	6 Ga. x 26"	
A36-6TA	6	6 Ga. x 24"	4 Ga. x 8"*
NEW! A40-6TA	6	6 Ga. x 26"	
A46-6TA	6	6 Ga. x 12"	
A48-6TA	6	6 Ga. x 39"	
NEW! A50-6TA	6	6 Ga. x 23"	
A55-6TA	6	6 Ga. x 10"	
A57-6TA	6	8 Ga. x 12"	
A58-6TA	6	6 Ga. x 19"	
A70-6TA	6	10 Ga. x 10"	12 Ga. x 69"*
A30-4TA	4	4 Ga. x 13"	
A36-4TA	4	4 Ga. x 8"	
A42-4TA	4	4 Ga. x 22"	12 Ga. x 7"
A45-4TA	4	6 Ga. x 24"	12 Ga. x 10"*
A47-4TA	4	6 Ga. x 28"	12 Ga. x 10"*
A49-4TA	4	6 Ga. x 28"	12 Ga. x 10"
A50-4TA	4	6 Ga. x 21"	12 Ga. x 10"
A51-4TA	4	6 Ga. x 15"	
A52-4TA	4	6 Ga. x 13"	
A56-4TA	4	6 Ga. x 18" w/ fusible link	12 Ga. x 69"
A57-4TA	4	6 Ga. x 45"	12 Ga. x 67"*
A58-4TA	4	6 Ga. x 36"	
A63-4TA	4	6 Ga. x 18" w/ fusible link	12 Ga. x 74"
A67-4TA	4	6 Ga. x 14"	
NEW! A29-2TA	2	4 Ga. x 9"	
NEW! A41-2TA	2	6 Ga. x 19"	
A48-1TA	1	6 Ga. x 28"	

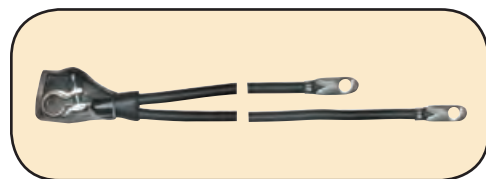

* Not attached to main cable

BATTERY CABLES



BATTERY CABLES

INSULATED BATTERY CABLES (PREFIX "A")

Suffix "TAF" Lead-Free Top-Post Terminal, Fusible Link In Main Cable, One Or Two Aux Leads

	Gauge	Aux. Lead 1	Aux. Lead 2
A36-6TAF	6	12 Ga. x 55"	4 Ga. x 49"
A37-6TAF	6	12 Ga. x 51"	4 Ga. x 45"
A13-4TAF	4	12 Ga. x 67"	6 Ga. x 55"
A64-4TAF	4	6 Ga. x 66"	4 Ga. x 11"

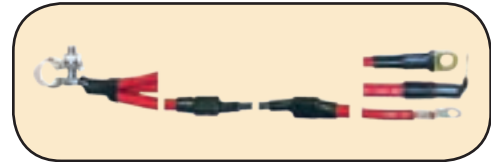

Suffix "TB" and "TBB" Lead-Free Top-Post Terminal, One Auxiliary Wire 6 Ga. Or Larger

6 Gauge	Aux. Lead	6 Gauge	Aux. Lead
A25-6TB	4 Ga. x 44"	A38-6TB	6 Ga. x 12"
NEW A26-6TB	6 Ga. x 11"	A40-6TB	4 Ga. x 20"
A27-6TB	6 Ga. x 46"	A41-6TB	6 Ga. x 32" w/ fusible link
A28-6TB	6 Ga. x 11"	A41-6TBB	6 Ga. x 15"
A28-6TB2	6 Ga. x 19"	A49-6TB	6 Ga. x 35"
A32-6TB	6 Ga. x 10"	A55-6TB	6 Ga. x 20" w/ fusible link
A34-6TB	6 Ga. x 27"	A59-6TB	4 Ga. x 32"
NEW A34-6TBB	6 Ga. x 11"	A60-6TB	6 Ga. x 13"
A37-6TB	4 Ga. x 39"	A66-6TB	4 Ga. x 32" w/ fusible link

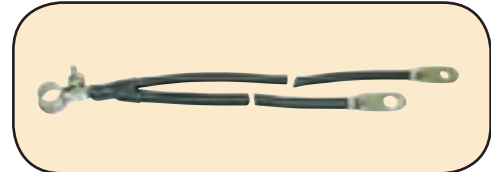

Suffix "TB" and "TBB" Lead-Free Top-Post Terminal, One Auxiliary Wire 6 Ga. Or Larger

4 Gauge	Aux. Lead	4 Gauge	Aux. Lead
A13-4TB	6 Ga. x 59"	A42-4TB	6 Ga. x 18"
A19-4TB	6 Ga. x 22" w/ fusible link	A42-4TBB	6 Ga. x 37"
A19-4TB2	6 Ga. x 12" w/ fusible link	A43-4TB	6 Ga. x 33"
A22-4TB	4 Ga. x 13"	A45-4TB	6 Ga. x 26"
A24-4TB	4 Ga. x 16"	A48-4TB	4 Ga. x 51"
A25-4TB	6 Ga. x 17"	A51-4TB	4 Ga. x 16"
A26-4TB	6 Ga. x 15"	A54-4TB	6 Ga. x 26"
A32-4TB	6 Ga. x 15"	A55-4TB	4 Ga. x 10"
A35-4TB	6 Ga. x 22"	A58-4TB	6 Ga. x 38"
A36-4TB	4 Ga. x 41"	A60-4TB	6 Ga. x 17"
A37-4TB	6 Ga. x 10"	A62-4TB	6 Ga. x 14"
A40-4TB	6 Ga. x 26"	A67-4TB	10 Ga. x 10"
A40-4TBB	6 Ga. x 27"	A78-4TB	6 Ga. x 27"

Suffix "TB" and "TBB" Lead-Free Top-Post Terminal, One Auxiliary Wire 6 Ga. Or Larger

2 Gauge	Aux. Lead	2 Gauge	Aux. Lead
A24-2TB	6 Ga. x 10"	NEW A38-2TB	4 Ga. x 9"
A29-2TB	6 Ga. x 59"	A41-2TB	6 Ga. x 7"
A30-2TB	12 Ga. x 115"	A45-2TB	4 Ga. x 16"
A30-2TBB	4 Ga. x 89"	A52-2TB	6 Ga. x 10"
NEW A31-2TB	4 Ga. x 81"	1 Gauge	
A32-2TB	6 Ga. x 32"	A20-1TB	6 Ga. x 12"
A33-2TB	6 Ga. x 16"	1/0 Gauge	
A34-2TB	4 Ga. x 10"	NEW A32-0TB	6 Ga. x 26"
NEW A35-2TBB	4 Ga. x 89"		
A36-2TB	6 Ga. x 35"		

Suffix "TBC" and "TBCL" Lead-Free Cable

	Gauge	Aux. Lead 1	Aux. Lead 2
A31-6TBC	6	6 Ga. x 28"	6 Ga. x 10" *
A32-6TBC	6	6 Ga. x 19"	14 Ga. x 10"
A74-6TBC	6	6 Ga. x 9"	6 Ga. x 52" w/ fusible link
A32-4TBC	4	6 Ga. x 18"	14 Ga. x 10"
A42-4TBC	4	6 Ga. x 24"	12 Ga. x 10"
A43-4TBC	4	6 Ga. x 36"	12 Ga. x 10"
A50-4TBC	4	8 Ga. x 27"	14 Ga. x 63" *
A63-4TBCL	4	4 Ga. x 15"	
NEW A29-2TBC	2	4 Ga. x 68"	6 Ga. x 61"
NEW A33-2TBC	2	4 Ga. x 68"	6 Ga. x 61"
NEW A34-2TBC	2	4 Ga. x 28"	12 Ga. x 10"

* Not attached to main cable

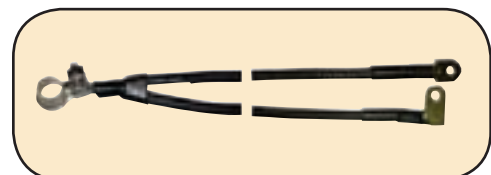

Suffix "TC" Lead-Free Top-Post Terminal, With Primary Wire Auxiliary Leads

	Gauge	Aux. Lead1	Aux. Lead 2	Aux. Lead 3
A26-6TC	6	8 Ga. x 31"	10 Ga. x 11"	
A38-6TC*	6	8 Ga. x 25"	10 Ga. x 19"	4 Ga. x 47"
A38-6TC2*	6	8 Ga. x 35"	10 Ga. x 19"	6 Ga. x 4"
A30-4TC	4	10 Ga. x 11"	12 Ga. x 8"	12 Ga. x 8"
A33-4TC	4	8 Ga. x 12"	10 Ga. x 12"	
A62-4TC	4	10 Ga. x 11"	10 Ga. x 11"	
A66-4TC	4	6 Ga. x 14"		
A72-4TC	4	14 Ga. x 20"	14 Ga. x 20"	
A73-4TC	4	10 Ga. x 11"	10 Ga. x 11"	
A74-4TC	4	10 Ga. x 11"	10 Ga. x 11"	

* Not attached to main cable

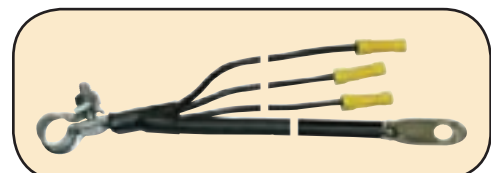

BATTERY CABLES

INSULATED BATTERY CABLES (PREFIX "A")

Suffix "TCC" Lead-Free Top-Post Terminal, With Primary Wire Aux Leads, 1 From Lug End Or Center

	Aux. Lead 1	Aux. Lead 2	Aux. Lead 3	Aux. Lead 4
A26-6TCC	8 Ga. x 13"	12 Ga. x 8"	12 Ga. x 13" **	12 Ga. x 13" **
A35-4TCC	10 Ga. x 15"	12 Ga. x 15"	10 Ga. x 15"	
A46-4TCC	10 Ga. x 17"	14 Ga. x 20"	8 Ga. x 12" ***	18 Ga. x 15" *
A49-4TCC	10 Ga. x 15"	12 Ga. x 15"	10 Ga. x 15" *	
A73-4TCC	12 Ga. x 27"			

* From lug end ** From aux. lead 1 *** From center lug

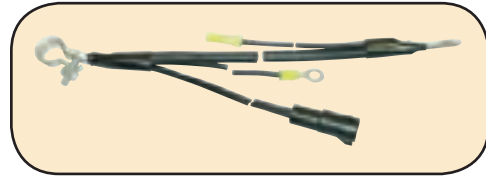

Suffix "TD" Lead-Free Top-Post Terminal, With One Aux Lead From Lug End 6 Ga. Or Larger

6 Gauge	Aux. Lead
A24-6TD	6 Ga. x 24"
A40-6TD	6 Ga. x 41"

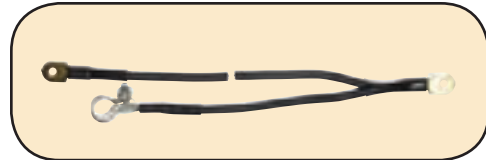

Suffix "TL" Lead-Free Top-Post Terminal, Terminal Bolts To Lug To Lug Cable With 90° Lug

	Gauge
A26-6TL	6
A11-4TL	4
A20-4TL	4
A25-4TL	4
A34-4TL	4
A39-4TL	4
NEW! A41-4TL	4
NEW! A32-2TL	2



Suffix "TLA" Lead-Free Top-Post Terminal, With Aux Lead 6 Ga. Or Larger

	Gauge	Aux. Lead
A11-6TLA	6	8 Ga. x 28"
A22-6TLA	6	8 Ga. x 12"
A25-6TLA	6	8 Ga. x 15"
NEW! A26-6TLA	6	6 Ga. x 11"
NEW! A31-6TLA	6	8 Ga. x 10"
A32-6TLA	6	6 Ga. x 10"
NEW! A33-6TLA	6	6 Ga. x 25"
A39-6TLA	6	6 Ga. x 30"
A24-4TLA	4	6 Ga. x 34"
A28-4TLA	4	4 Ga. x 12"
A33-4TLA	4	4 Ga. x 12"
A37-4TLA	4	6 Ga. x 14"
A38-4TLA	4	6 Ga. x 15"
A48-4TLA	4	6 Ga. x 11"
A54-4TLA	4	4 Ga. x 27"

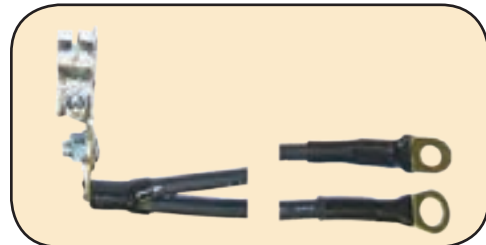

Suffix "TLCL" Lead-Free Top-Post Terminal, Terminal Bolts To Lug To Lug Cable With 90° Lug, With Center Lug

4 Gauge	Battery To Center Lug	Aux. Lead
A42-4TLCL	16"	n/a
A44-4TLCL	19"	n/a
A47-4TLCL	19"	n/a
NEW! A51-4TLCL	21"	n/a
A91-4TLCL	54"	6 Ga. x 15"

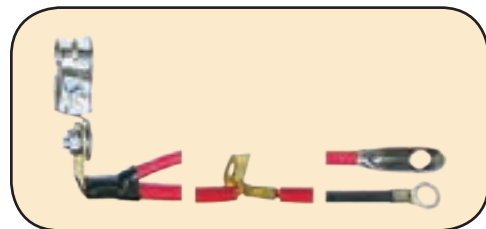

Suffix "U" Lead Top-Post Terminal, With One Auxiliary Lead

6 Gauge	4 Gauge	4 Gauge	2 Gauge	1/0 Gauge
A22-6U	A15-4U	A41-4U	A30-2U	NEW! A33-0U
A28-6U	A19-4U	A45-4U	A47-2U	A34-0U
A36-6U	A22-4U	A48-4U	A61-2U	A45-0U
A42-6U	A25-4U	A53-4U	A65-2U	
A50-6U	A30-4U	A63-4U		
A56-6U	A36-4U	A78-4U		
A67-6U	A38-4U			

Aux. lead 8 Ga. x 9" Aux. lead 12 Ga. x 9" Aux. lead 10 Ga. x 11 1/2" Aux. lead 10 Ga. x 19 1/2"

Lead Terminal

Lug for 3/8" Bolt



Suffix "UA" Lead Top-Post Terminal, With One 8 Ga. Aux Lead. May Also Include Detached starter lead

4 Gauge	Aux. Lead
A42-4UA	8 Ga. x 9"
A50-4UA	8 Ga. x 20"
A58-4UA	8 Ga. x 9"
A72-4UA*	14 Ga. x 93" **
A82-4UA*	6 Ga. x 45", 12 Ga. x 115" **

* Lead-free terminal

** Not attached to main cable

Lead Terminal



BATTERY CABLES



INSULATED BATTERY CABLES (PREFIX "A")

Suffix **"UAB"** Lead Top-Post Terminal, With Aux Lead With OE Type Aux Lead From Lug End

	Aux. Lead 1	Aux. Lead 2
A42-4UAB	8 Ga. x 9"	14 Ga. x 10" *

* From auxiliary lead 1

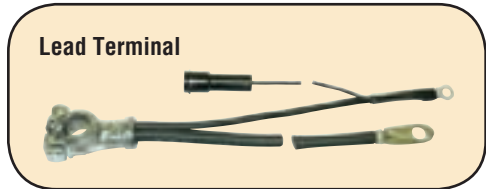

Suffix **"UAC"** Lead-Free Top-Post Terminal With Aux Lead With OE Type Aux Lead From Lug End

	Gauge	Aux. Lead 1	Aux. Lead 2 *
A27-6UAC	6	8 Ga. x 15"	12 Ga. x 13"
A30-6UAC	6	14 Ga. x 10"	14 Ga. x 20"
A42-6UAC	6	14 Ga. x 25"	14 Ga. x 20"
A43-4UAC	4	14 Ga. x 10"	14 Ga. x 20"
A50-4UAC	4	8 Ga. x 24"	12 Ga. x 7"
A28-2UAC	2	8 Ga. x 15"	12 Ga. x 13"
A54-2UAC	2	8 Ga. x 18"	10 Ga. x 10"

* From auxiliary lead 1

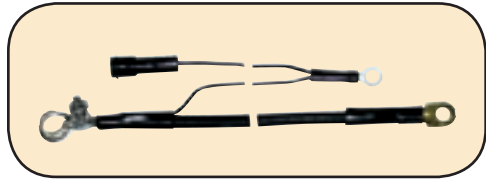

Suffix **"UC"** Lead-Free Top-Post Terminal 3 Aux Leads, 1 From Terminal And 2 From Center Splice

	Aux. Lead 1	Aux. Lead 2	Aux. Lead 3
A45-4UC	12 Ga. x 14"	8 Ga. x 25"	8 Ga. x 16"
A54-4UC	10 Ga. x 6"	8 Ga. x 12"	

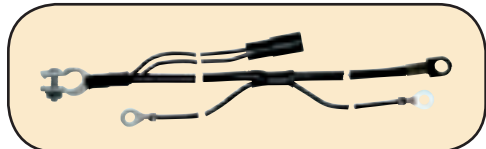

Suffix **"UD"** Lead-Free Top-Post Terminal With Aux Lead From Both Ends

	Aux. Lead	Lug End Aux. Lead
A26-6UD	8 Ga. x 12"	10 Ga. x 15"
A27-6UD	8 Ga. x 14"	10 Ga. x 10"
A31-6UD	8 Ga. x 14"	10 Ga. x 10"
A32-6UD	8 Ga. x 12"	8 Ga. x 12"
A52-4UD	8 Ga. x 13"	
NEW A36-2UD	8 Ga. x 8"	8 Ga. x 67"

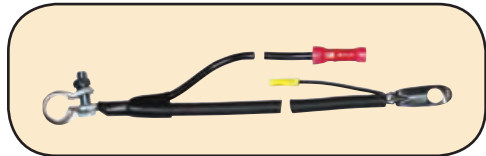

Suffix **"UDC"** Lead-Free Top-Post Terminal With Aux Lead From Both Ends With Ring Terminals

4 Gauge	Aux. Lead 1	Aux. Lead 2
A49-4UDC	8 Ga. x 16"	8 Ga. x 17"
A53-4UDC	8 Ga. x 16"	8 Ga. x 22"
A66-4UDC	8 Ga. x 14"	8 Ga. x 36"
A69-4UDC	8 Ga. x 14"	8 Ga. x 36"



Suffix **"UH"** Lead Top-Post Terminal, With One Aux Lead, With 1/2" Lug

6 Gauge	Aux. Lead	6 Gauge	Aux. Lead
A24-6UH	10 Ga. x 5"	A38-6UH	10 Ga. x 5"
A32-6UH	10 Ga. x 5"	A56-6UH	10 Ga. x 5"

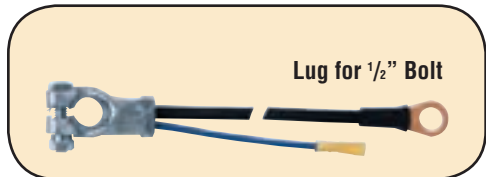

Suffix **"UHC"** Lead-Free Top-Post Terminal, With One Aux Lead, With Ring Terminal, 1/2" Lug

	Gauge	Aux. Lead
A46-2UHC	2	8 Ga. x 21"

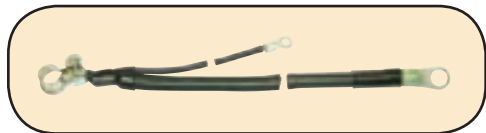

Suffix **"UHLC"** Lead Top-Post Terminal, With One Aux Lead From Lug End, 1/2" Lug

	Gauge	Aux. Lead
A38-2UHLC	2	8 Ga. x 15"



BATTERY CABLES

INSULATED BATTERY CABLES (PREFIX "A")

Suffix "UT" Lead-Free Top-Post Terminal, With One Aux Lead With Butt Splice Connector

6 Gauge	Aux. Lead	4 Gauge	Aux. Lead
A14-6UT	10 Ga. x 8"	A22-4UT	8 Ga. x 8"
A16-6UT	8 Ga. x 8"	A32-4UT	8 Ga. x 8"
A22-6UT	8 Ga. x 8"	A36-4UT	8 Ga. x 8"
A25-6UT	8 Ga. x 8"	A38-4UT	10 Ga. x 8"
NEW A25-6UT2	10 Ga. x 8"	A42-4UT	8 Ga. x 8"
A27-6UT	8 Ga. x 8"	A48-4UT	8 Ga. x 8"
A28-6UT	10 Ga. x 8"	A52-4UT	8 Ga. x 8"
A30-6UT	8 Ga. x 8"	A57-4UT	8 Ga. x 8"
A36-6UT	8 Ga. x 8"	A72-4UT	8 Ga. x 8"
A37-6UT	10 Ga. x 8"	A73-4UT	10 Ga. x 8"
A42-6UT	8 Ga. x 8"	A78-4UT	8 Ga. x 8"
A48-6UT	8 Ga. x 8"		
A54-6UT	8 Ga. x 8"		
A56-6UT	10 Ga. x 8"		

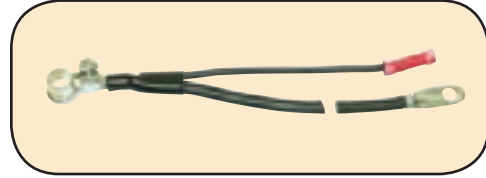

Suffix "UT" Lead-Free Top-Post Terminal, With One Aux Lead With Butt Splice Connector

2 Gauge	Aux. Lead	1 Gauge	Aux. Lead
A33-2UT	6 Ga. x 35" *	A22-1UT	6 Ga. x 29"
A44-2UT	8 Ga. x 8"		
A55-2UT	8 Ga. x 8"		
A60-2UT	8 Ga. x 8"		
A68-2UT	8 Ga. x 8"		

* With 10 Ga. x 12" aux. lead from lug end



Suffix "UTC" Lead-Free Top-Post Terminal, With One Aux Lead, With Ring Terminal

6 Gauge	Aux. Lead	Aux. Lead	4 Gauge	Aux. Lead	Aux. Lead
A38-6UTC	8 Ga. x 14"		A42-4UTC	8 Ga. x 30"	12 Ga. x 10" *
A54-6UTC	8 Ga. x 11"		A46-4UTC	8 Ga. x 10"	
A56-6UTC	8 Ga. x 10"		A50-4UTC	8 Ga. x 12"	
			A53-4UTC	8 Ga. x 30"	12 Ga. x 10" *
4 Gauge	Aux. Lead	Aux. Lead	A62-4UTC	8 Ga. x 12"	
A17-4UTC	10 Ga. x 20"		A67-4UTC	8 Ga. x 17"	
A37-4UTC	8 Ga. x 12"				
A40-4UTC	8 Ga. x 30"	12 Ga. x 10" *	2 Gauge	Aux. Lead	Aux. Lead
			NEW A32-2UTC	8 Ga. x 63"	

* Not attached to main cable

Cable Make-Up Tips

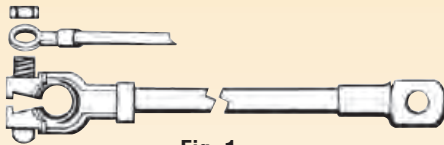

Fig. 1

- A.** To attach auxiliary wires when none are provided on the cable itself, proceed as follows:
1. Terminate the auxiliary wire desired, using a $\frac{3}{8}$ " I.D. ring terminal.
 2. Attach terminal to the battery terminal bolt as shown (Fig. 1).

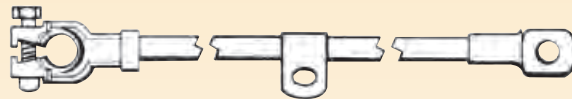
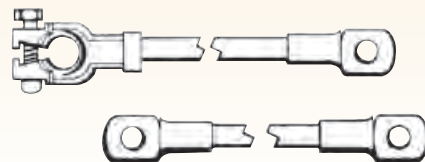

Fig. 2

- B.** To create a center lug cable when one is unavailable use two normal cables proceed as follows:
1. Set up two cables as shown in Fig. 3.
 2. Install.

Fig. 3



BATTERY CABLES & GROUND STRAPS



BATTERY CABLE SELF-SERVICE CENTER

Part No.	Description	Std. Pkg.	
BCA-1 SD647	Battery Cable Assortment 14-Hook Display Header	1 4	
Included in the assortment: <ul style="list-style-type: none"> • 14 top-selling cables (1 each) • 2 switch-to-starter cables • 3 conventional cables • 5 cables with auxiliary wire leads • 4 GM-style side terminals • Free 14 hook display header 			
Part No.	Cable Type	Length	Gauge
A10-4	Conventional	10"	4
A16-4	Conventional	16"	4
A12-6	Conventional	12"	6
A19-4U	with auxiliary wire	19"	4
A22-4U	with auxiliary wire	22"	4
A30-4U	with auxiliary wire	30"	4
A36-4U	with auxiliary wire	36"	4
A48-4U	with auxiliary wire	48"	4
A24-4L	Switch-to-starter	24"	4
A40-4L	Switch-to-starter	40"	4
A25-4D	GM-style	25"	4
A30-4D	GM-style	30"	4
A35-4D	GM-style	35"	4
A45-4D	GM-style	45"	4

GROUND STRAPS

Flat copper braid, tinned without insulation			
Part No.	Gauge	Length	Description
B8G	10	8"	Bonding strap to connect engine block to firewall. Reduces radio noise.
B16G	10	16"	
B20G	10	20"	
B10G	10	9 1/2"	Cable with 2 square lugs. * 5/16" lug holes
B9G	4	9"	
B12G	4	12"	
B14G	4	14"	
B14G-5 *	4	14"	
B18G	4	18"	
B20G-5 *	4	20"	
B26G	4	26"	
B17G2	2	17"	
B9	2	9"	Cable with lead terminal and square lug.
B14	2	14"	
B17	2	17"	
B25E	2	25"	Cable with lead terminal and multiple square lugs.
B29E	2	29"	

BULK GROUND STRAP

Part No.	Gauge	Std. Pkg.
B2GV	2	25 ft. roll
B4GV	4	25 ft. roll
B10GV	10	25 ft. roll

STEP-DOWN BUTT CONNECTORS

Part No.	Gauge	Std. Pkg.
SST89	10-12 to 8 Gauge	10
SST90	14-16 to 12-10 Gauge	10

VINYL INSULATED GROUND LEAD

Part No.	Description	Qty. Per Pkg.
ET2012	12 Gauge Vinyl insulated universal grounding lead. 20" long 5/16" eyelet	1 Display Clam
ET912	12 Gauge Vinyl insulated universal grounding lead. 9" long 3/8" eyelet	1 Display Clam

ET Display Package

BCA-1

B8G

B9G

B9

B29E

B2GV

B4GV

B10GV

3/8" Stud

7/16" Stud

3/8" Stud

3/8" Stud

SST89

SST90

ET2012

ET912

BATTERY CABLES

BATTERY CABLE REPLACEMENT ENDS

- Ideal for emergency repairs.
- Insulating sleeve protects splice from corrosion and shorts.
- Convenient lengths.
- Carded items are convenient for up-front display.
- Easy-to-install, because the work is always near the battery, no matter how long the cable is.
- No special tools required.
- Universal terminal fits positive and negative battery posts.
- Length 6 1/2".

LEAD COUPLERS

Part No.	Description	Std. Pkg.
Top Mount		
QC10	Single replacement end; top post battery terminal for 8, 6 & 4 Ga. cable. Includes plastic insulator.	1 card 6 per card
QC16	Double "quick-connect" replacement end; top mount for 6 Ga. cable. Chrysler and import vehicles. Includes plastic insulator	1 per box
Side Mount		
QC14	Side mount battery terminals; for 8, 6 & 4 Ga. cable. Includes plastic insulator (6 black)	1 card 6 per card

LEAD-FREE COUPLERS

Part No.	Description	Std. Pkg.
QC18	Single replacement end; top post cable with 2 auxiliary leads, 4 Ga.	1 per box
QC19	Double replacement end; 1 auxiliary lead, 4 Ga.	1 per box
QC20	Side mount battery with 2 auxiliary leads.	1 per box
QC21	Repairs 4 & 6 Ga.	1 per box
QC22	Repairs 2 & 1 Ga.	1 per box
QC23	Repairs 2 & 1 Ga.	1 per box

COMPRESSION ENDS WITH BRASS COUPLERS

Part No.	Description	Std. Pkg.
QC11	Brass coupler for top post battery terminal for 2 & 1 Ga. Includes telescoping insulator	1 card 6 per card
QC12	Brass coupler for top post battery terminal for 2/0 Ga. Includes telescoping insulator	1 card 6 per card (3 red; 3 black)
QC15	Lead terminal conversion end. For adapting conventional (top) post terminal batteries for use with side terminal battery cables. Extra length adapter minimizes strain on posts	1 card 6 per card (3 red; 3 black)
QC17	Brass coupler for 3/8" stud or side mount battery, 2 & 1 Ga. Includes telescoping insulator	1 per box

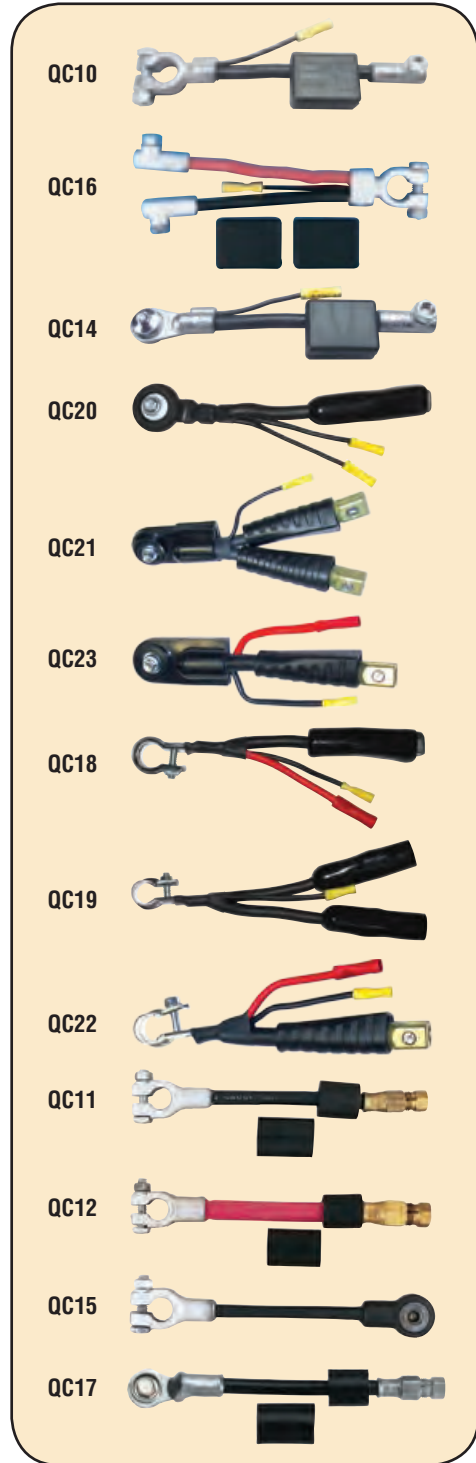

SPLICING SYSTEMS AND SIDE TERMINAL CONVERSION

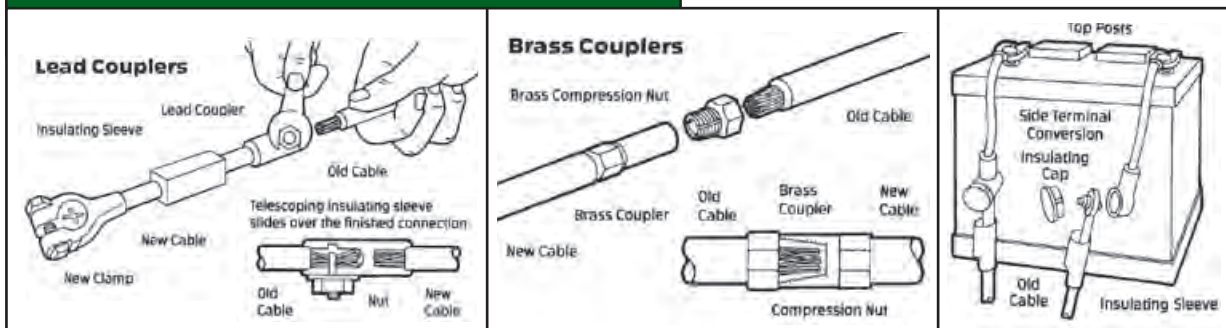

MULTIPLE BATTERY CABLE HARNESSSES



TWO AND THREE BATTERY CABLE HARNESS

Two Battery Harnesses

Top post to power take-off post

Part No.	Length	Gauge	Polarity
A7-00MN	7"	2/0	Neg.
A7-00MP	7"	2/0	Pos.
A8-00MN	7 1/2"	2/0	Neg.
A8-00MP	7 1/2"	2/0	Pos.

Two Battery Harnesses

Stud to power take-off post

Part No.	Length	Gauge	Polarity
A7-00SN	7"	2/0	Neg.
A7-00SP	7"	2/0	Pos.
A8-00SN	7 1/2"	2/0	Neg.
A8-00SP	7 1/2"	2/0	Pos.

Each stud type harness includes (2) 3/8" flange nuts

Three Battery Harnesses

Top post to power take-off post

Part No.	Length	Gauge	Polarity
A14-00MN	14"	2/0	Neg.
A14-00MP	14"	2/0	Pos.
A15-00MN	15"	2/0	Neg.
A15-00MP	15"	2/0	Pos.

Three Battery Harnesses

Stud to power take-off post

Part No.	Length	Gauge	Polarity
A14-00SN	14"	2/0	Neg.
A14-00SP	14"	2/0	Pos.
A15-00SN	15"	2/0	Neg.
A15-00SP	15"	2/0	Pos.

Each stud type harness includes (3) 3/8" flange nuts

Post type

A7-00MN



Post type

A7-00MP



Stud type

A8-00SN



Stud type

A8-00SP



Post type

A14-00MN



Post type

A14-00MP



Stud type

A14-00SN



Stud type

A14-00SP



Power Take-Off Post makes connection simple and fast.

2/0 Gauge wire, PVC insulated.

Steel reinforcing ring cast inside clamps for extra strength.

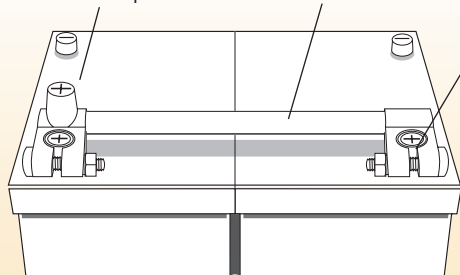

MULTIPLE BATTERY HARNESSSES

Pre-assembled cables quickly and easily join 2 and 3 batteries together to deliver maximum starting power.

- Factory sealed between cable and clamp reduces effects of corrosive elements.
- Heavy duty 2/0 copper cable is PVC insulated.
- Designed for use on group 31 and other battery sizes where maximum power is needed for truck engines.

MULTIPLE BATTERY HOOKUPS

MULTIPLE BATTERY HOOKUPS... TRUCK, FARM & INDUSTRIAL APPLICATIONS

- **Universal application.** Each cable can be used as a “top” or a “bottom”
Cuts inventory in half . . . without sacrificing coverage
- **Precision-molded insulated end . . . provides a tight, maintenance-free seal**
- **Protective cap protects against electrical shorting, corrosion and contamination**
- **Four-way cable permits 4-battery cluster setups using only one part number: A22-00K**

Four Part Numbers Cover Every Application

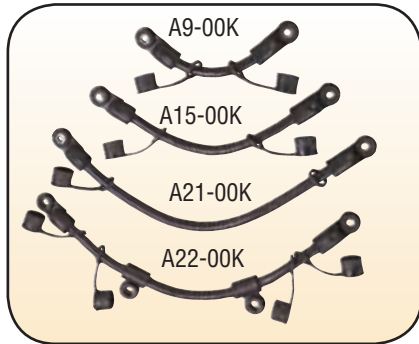

Part No.	Length	Gauge
A9-00K	9"	2/0
A15-00K	15"	2/0
A21-00K	21"	2/0
A22-00K	22" (4 Term.)	2/0



Part No.	Description	Std. Pkg.
BP41B	Black (neg.) protective cap for stackable battery cable	5
BP41R	Red (pos.) protective cap for stackable battery cable	5
BP99	Stainless steel hold down nuts	5
BP101	Black (neg.) nylon stud nuts	5
BP102	Red (pos.) nylon stud nuts	5

TYPICAL ASSEMBLY AND INSTALLATION TIPS



Cables are factory-assembled for use as “bottoms.” To convert cable for “top” use, pry out insert with a screwdriver.



Use **SST305**, 2/0 gauge butt splice connector to splice into O.E. cable and **HST240B** heat shrink tubing for extra protection.

CABLE HOOKUPS FOR MULTIPLE BATTERY CLUSTERS

Legend: OEM = OEM Starter Cable; BC = Butt Connector; A9 = A9-00K; A15 = A15-00K; A21 = A21-00K; A22 = A22-00K

SPLIT PAIRS.

Mounted separately in a 4-battery hook-up.

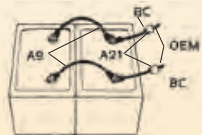
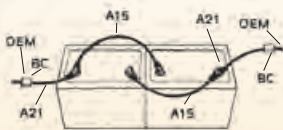

3-BATTERY CLUSTERS.

Mounted together.

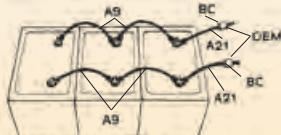

4-BATTERY CLUSTERS

Mounted together

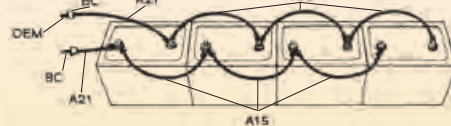
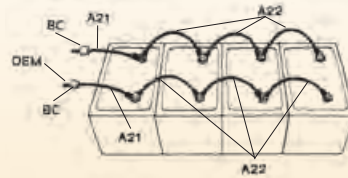
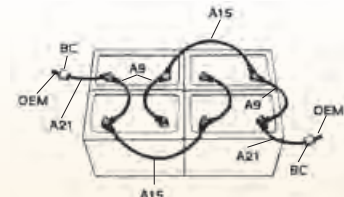

MULTI-BATTERY ISOLATORS



MULTIPLE BATTERY ISOLATORS

- Electronically isolates auxiliary battery from main start battery
- One way directional design prevents auxiliary battery from robbing main/start battery
- No matter how drained an accessory battery becomes, the main battery will always have the power to start the engine
- Suitable for all multi-battery systems, including RV and inboard marine
- Multi-battery isolators are designed for alternator systems with negative ground, and batteries of the same nominal voltage. Batteries of differing voltages cannot be used.
- For optimum systems performance batteries labeled “Deep Cycle” should be used in the auxiliary position

BP42 - 95 AMP Multi-Battery Isolator – For one main battery, one auxiliary battery, alternator up to 95 Amp output, including GM “CS” series alternator.

BP43 - 120 AMP Multi-Battery Isolator – For one main battery, one auxiliary battery, alternator up to 120 Amp output, including GM “CS” series alternator.

BP44 - Battery Isolator Installation Kit – Kit includes: 15 feet of 8 gauge primary wire; 50 Amp circuit breaker; Terminal and connector hardware pack; 8 Ga., ring terminals, (2 1/4” stud, 4 5/16” stud, 1 3/8” stud), 1-12-10 Ga. splice, 2 each 1/4” nuts and washers, 2 circuit breaker mounting screws.

BP45 - Connector Assembly Kit – For GM & Jeep vehicles with Delcotron “CS” series alternators. Group 2 applications - 1985 and newer. Kit includes: Various 16-14 Ga. terminals, sense wire for “S” position on certain GM “CS” alternator connectors, primary wire.

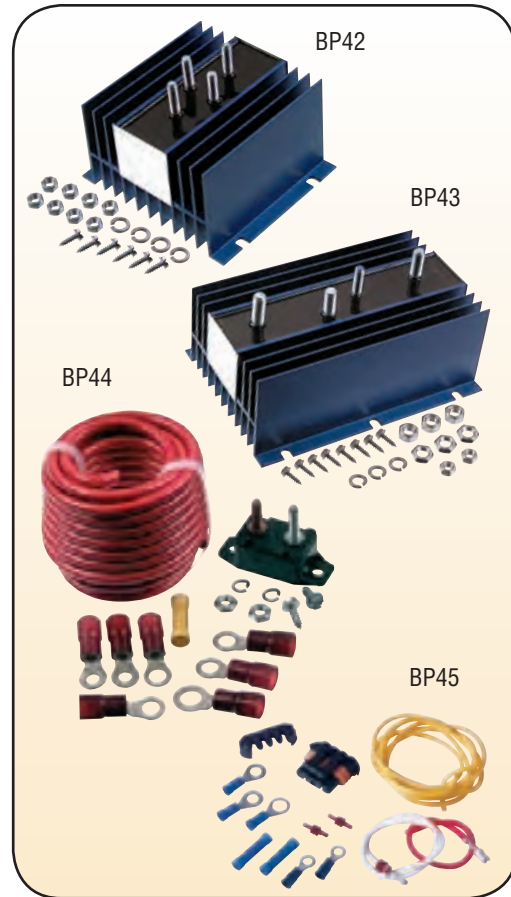

BATTERY CABLES

BATTERY ISOLATOR APPLICATIONS

Alternator Type	Max Alt. Output	2 Batteries 1 Main, 1 Auxiliary	Recommended Primary Wire Gauge Circuit Breaker or Installation Kit			
			Wire Length			
			15 ft.	20 ft.	25 ft.	30 ft.
Group #1 Delco (GM) , except Delcotron CS series alternators (1984 and earlier) Ford All models through 1997 Chrysler All models, all years, including externally regulated Nippondenso alternators Motorola Load Handler series 8EM remote sense series Japanese Imports with external voltage regulators or external sensing	Up to 95 Amps	BP42*	8 Ga. 50 Amp (1)	6 Ga. 50 Amp	4 Ga. 50 Amp	4 Ga. 50 Amp
Group #2 Delco (GM) , with Delcotron CS series alternators (most 1985 and newer)** or CS130D (1993 and newer) Ford - All models 1998 and later Jeep - equipped with Delcotron CS series alternators (1985 and 1990)** Toyota and Honda Nippondenso Alt. with internal regulator	Up to 95 Amps	BP43*	6 Ga. 80 Amp	4 Ga. 80 Amp	2 Ga. 80 Amp	1 Ga. 80 Amp

*BP45 connector kit is required for Group 2 applications with Delcotron “CS” alternators. Included is a sense wire required for the CS130D alternator. **CS series alternator is identified by the number of holes in the plug-in connector. The CS series has 3 smaller square holes and 1 larger square hole. CS130D alternator has 4 square holes all the same size. Standard series has 2 slotted holes.

(1) — 8 Ga. wire, 50 Amp circuit breaker or BP44 connector kit (includes: 15 ft. 8 Ga. wire, 50 Amp CB, terminals and connectors).

Refer to detailed assembly instructions included with each Multi-Battery Isolator.

BULK BATTERY CABLE

CUSTOMIZE YOUR OWN BATTERY CABLES... AND WELDING CABLES...



Bulk battery and welding cable can help you repair or adapt to a wide range of cable make-ups. Our bulk cable comes in a wide range of gauges and coil lengths. Also available is a complete selection of individual terminals, adapters and other accessories to accommodate any situation: from an emergency hookup to a custom application.

Our **heavy duty cable** exceeds SAE Spec J1127 for Type SGR cable, and exhibits higher levels of heat resistance and resistance to corrosive elements (oil and moisture). That's why our cable works better and lasts longer.

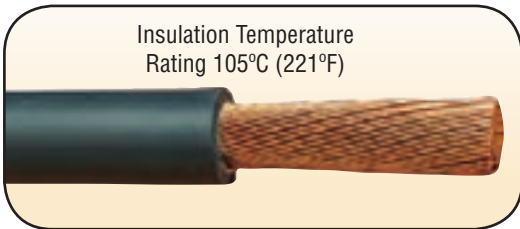

Insulation Temperature Rating 105°C (221°F)

HEAVY DUTY – TYPE SGR/SAEJ1127

Part No.			Cable		
25 ft. Coil	50 ft. Coil	100 ft. Coil	Gauge	Stranding	O.D.
CS6V	—	C6E	6	133 x 27	.305"
CS4V	CS4L	CS4C	4	61 x 22	.365"
CS2V	CS2L	CS2C	2	133 x 23	.490"
CS1V	CS1L	CS1C	1	399 x 27	.490"
CS0V	CS0L	CS0C	1/0	133 x 21	.535"
CS00V	CS00L	CS00C	2/0	133 x 20	.575"
CS000V	CS000L	CS000C	3/0	361 x 23	.670"
CS0000V	—	—	4/0	323 x 22	.788"

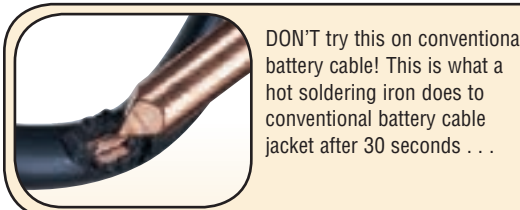

DON'T try this on conventional battery cable! This is what a hot soldering iron does to conventional battery cable jacket after 30 seconds . . .



Our heavy duty battery cable takes the heat. No trace of melting or burning after contact with same hot soldering iron. In some applications, battery cables can make contact with hot engine parts which often reach temperatures as high as a hot soldering iron.

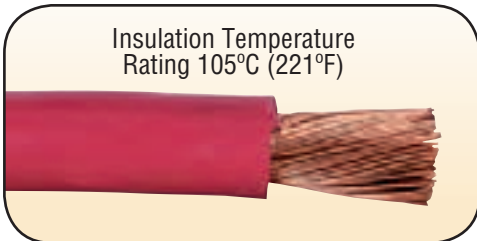

Insulation Temperature Rating 105°C (221°F)

HEAVY DUTY RED CABLE – TYPE SGR/SAEJ1127

Part No.			Cable		
25 ft. Coil	50 ft. Coil	100 ft. Coil	Gauge	Stranding	O.D.
CS6RV	—	CS6RC	6	133 x 27	.305"
CS4RV	—	CS4RC	4	61 x 22	.365"
CS2RV	—	CS2RC	2	133 x 23	.490"
CS1RV	—	CS1RC	1	399 x 27	.490"
CS0RV	CS0RL	CS0RC	1/0	133 x 21	.535"
CS00RV	CS00RL	CS00RC	2/0	133 x 20	.575"
CS000RV	CS000RL	CS000RC	3/0	361 x 23	.671"
CS0000RV	—	—	4/0	361 x 22	.788"

Go to page numbers **C7-C8**, Section C “Primary Wire” for Marine Battery Cable

ORDERING INFORMATION

Suffixes in charts indicate length of coil. (**V** = 25 ft. coil, **L** = 50 ft. coil; **C** = 100 ft. coil.) Cable is sold by the foot, not by the coil. To order, specify total number of feet required, followed by part number and desired coil size (suffix).

Examples: To order four-25 ft. coils of 1 gauge battery cable, order 100' **CS1V**. To order one-50 ft. coil of 2 gauge battery cable, order 50' **CS2L**. To order three-25 ft. coils of 2 gauge welding cable, order 75' **WC2V**.

WELDING CABLE & SOLDER SLUGS



WELDING CABLE – 600 VOLT RATING

- Protects against abrasion, grease and oil
- Maintains flexibility to -50°C (-60°F)
- Temperature rating 105°C (221°F)

Part No.						Cable	Stranding	O.D.
25 ft. Coil		50 ft. Coil		250 ft. Coil				
Black	Red	Black	Red	Black	Red	Ga.		
WC4V	WC4RV	WC4L	WC4RL	WCB4	WCB4R	4	427 x 30	.375
WC2V	WC2RV	WC2L	WC2RL	WCB2	WCB2R	2	651 x 30	.445
WC1V	WC1RV	WC1L	WC1RL	WCB1	WCB1R	1	826 x 30	.506
WC0V	WC0RV	WC0L	WC0RL	WCB0	WCB0R	1/0	1044 x 30	.572
WC00V	WC00RV	WC00L	WC00RL	WCB00	WCB00R	2/0	1308 x 30	.606



Black Welding Cable - WC00V



Red Welding Cable - WC00RV

BULK BOOSTER CABLE

- Parallel bonded cable provides tangle free service.
- Maintains flexibility in sub zero temperatures.

Part No.	Qty	Gauge
BC2DL	50'	2 Ga.
BC4DL	50'	4 Ga.
BC6DL	50'	6 Ga.



Bulk Booster Cable

BATTERY TERMINAL SOLDER SLUGS

Pre-measured solder slugs available in 7 sizes provide the correct amount of solder for the perfect termination. Fast and convenient, this system only needs a propane torch and vise combined with normal safety precautions when using flammable materials.

Part No.	Gauge	Color	Std. Pkg.
BP185	4 Ga.	Gray	10
BP186	2 Ga.	Green	10
BP187	1 Ga.	Pink	10
BP188	1/0 Ga.	Black	10
BP189	2/0 Ga.	Orange	10
BP190	3/0 Ga.	Purple	10
BP191	4/0 Ga.	Yellow	10
BP192	2 oz.	Flux	1

STA15 SOLDER SLUGS ASSORTMENT

Contains battery terminal solder slugs, flux and heat shrink tubing. (12 pieces of heat shrink tubing in assorted sizes) Std. Pkg. 1 Contents:

Part No.	Qty.	Part No.	Qty.	Part No.	Qty.
STT263	2	BP185	5	BP189	5
STT263R	2	BP186	5	BP190	5
STT264	2	BP187	5	BP191	5
STT264R	2	BP188	5	BP192	1
STT265	2				
STT265R	2				



Instructions For Cable Assembly



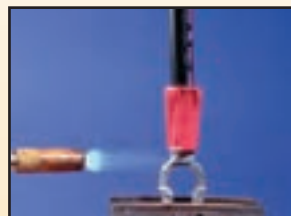



- 1 Strip the insulation from the cable allowing the exposed copper to reach the bottom of the terminal.
- 2 Place the proper size slug into the terminal. Secure the terminal in vise. Slide heat shrink tubing over the cable. Apply several drops of flux (BP192) to the exposed cable. Insert the cable into the terminal.
- 3 Heat the base of the battery terminal with the ignited torch gently pressing downward on the cable. Allow the cable to slide into the terminal until the insulation is snug against the top of the terminal. Remove the heat.
- 4 Slide the heat shrink tubing over the connection; apply heat to the tubing using a heat gun (WTT20). For additional heat shrink instructions see pages B36-B38.

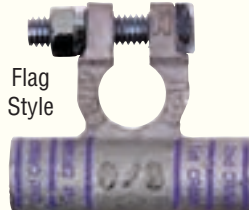

BATTERY TERMINALS

HEAVY DUTY SUPER-CRIMP TERMINALS

Super-Crimp terminals are made of pure copper and are lead plated. This combination assures maximum conductivity and corrosion resistance. For best results, use appropriate crimping tool (shown below). These “Heavy Duty” terminals can also be soldered using battery terminal solder slugs (page B23). For added durability, finish every crimping job with double-wall heat shrink tubing. (See pages B36-B38 for complete selection of heat shrink tubing).

	Part No.(+)	Part No.(-)	Gauge	Std. Pkg.		
STRAIGHT	BP90	BP90	4	5	 <p>Straight</p>	 <p>Left Elbow</p>
	BP91	BP92	2 & 1	5		
	BP93	BP94	1/0	5		
	BP95	BP96	2/0	5		
	BP107	BP108	3/0	5		
	BP109	BP110	4/0	5		
LEFT ELBOW	BP123	BP124	1/0	5	 <p>Right Elbow</p>	 <p>Flag Style</p>
	BP125	BP126	2/0	5		
	BP127	BP128	3/0	5		
FLAG STYLE	BP170	BP171	2	5	 <p>In-Line Stud</p>	 <p>Stud Top</p>
	BP172	BP173	1	5		
	BP174	BP175	1/0	5		
	BP135	BP136	2/0	5		
	BP137	BP138	3/0	5		
	BP176	BP177	4/0	5		
IN-LINE STUD	BP169	BP169	1/0	1	 <p>Stud Type*</p>	 <p>¹³/₃₂ Side Mount</p>
	BP164	BP163	2/0	1		
	BP165	BP162	3/0	1		
	BP167	BP168	4/0	1		
STUD TOP	BP140	BP144	1/0	1		
	BP142	BP143	4/0	1		
STUD TYPE*	BP145	BP146	2/0	1		
	BP147	BP148	3/0	1		
SIDE MOUNT	BP160		4	5		
	BP161		2	5		
	BP166		1/0	5		
• Tin plated copper						

*Straight, crimpable battery terminals, featuring anti-rotational tongue. Heat shrink tubing furnished.

How to match crimpable terminals to the proper cable gauge	Gauge	Color Code	Letter Code
Crimping dies are coded by color or by letters (depending on the tool manufacturer) to designate the cable gauge and terminal for which they are designed. Here's how to select the proper crimping die: 1. Match the gauge of the terminal with the cable gauge. 2. Check the chart for the “color” or “letter” key corresponding to the wire gauge. 3. Select the crimping die with the “color” or “letter” code indicated on the chart.	4	Gray	JH
	1 & 2	Pink/Green	HH
	1/0	Black	EA
	2/0	Orange	AC
	3/0	Purple	AB
	4/0	Yellow	AA

How to get a “super” crimping job...

- Use quality Super-Crimp terminals and quality heavy-duty crimping tools!
- Finish the job with quality heat-shrink tubing ... for the ultimate in protection against moisture, oxidation and wear!



BATTERY TERMINALS



COMPRESSION TERMINALS

- Tin plated copper terminals and lugs, for trouble-free terminations
- Quick, dependable assembly with a few simple tools

LUG				
Part No.	Gauge	Color	Std. Pkg.	Lug Hole
BP220	4	Gray	5	3/8"
BP221	2 & 1	Green & Pink	5	3/8"
BP223	1/0	Black	5	3/8"
BP225	2/0	Orange	5	3/8"
BP227	3/0	Purple	5	3/8"
BP229	4/0	Yellow	5	1/2"



STRAIGHT			
Part No.	Gauge	Color	Std. Pkg.
BP200	4	Gray	5
BP201	2 & 1	Green & Pink	5
BP203	1/0	Black	5
BP205	2/0	Orange	5
BP207	3/0	Purple	5
BP209	4/0	Yellow	5



90° ELBOW			
Part No.	Gauge	Color	Std. Pkg.
BP211	2 & 1	Green	5
BP213	1/0	Black	5
BP215	2/0	Orange	5
BP217	3/0	Purple	5
BP219	4/0	Yellow	5



COMPRESSION NUTS			
Part No.	Gauge	Color	Std. Pkg.
BP234*	4	Gray	1
BP236**	4	Gray	1
BP235	2 & 1	Green	1
BP230	1/0	Black	1
BP231	2/0	Orange	1
BP232	3/0	Purple	1
BP233	4/0	Yellow	1

* 9/16" Nut for flags & elbows only
 ** For straights and lugs only



FLAG			
Part No.	Gauge	Color	Std. Pkg.
BP237	4	Gray	5
BP238	2 & 1	Green	5
BP239	1/0	Black	5
BP240	2/0	Orange	5
BP241	3/0	Purple	5



Easy Installation Instructions

1 Strip 3/4" of insulation from end of cable.



2 Using the proper size compression nut to match the cable size, insert the bare wire into the compression nut until it seats. The copper wire should be flush with, or extend slightly beyond the threaded portion of the compression nut.

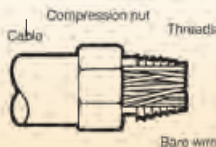

3 Thread the terminal onto the compression nut by hand a few turns to make sure the terminal and the nut are threading properly.



4 Finish tightening the terminal onto the compression nut by gripping the compression nut with a pair of pliers (or wrench), and rotating the terminal with a screwdriver until the nut seats.



BATTERY TERMINALS & EMERGENCY BATTERY TERMINALS

LEAD-FREE TERMINALS

Part No.	Gauge	Std. Pkg.
BP224	6 & 4	5
BP226	6 & 4	5

Use heavy duty dual wall heat shrink tubing for professional finish. See page B36.

Lead-Free Terminal



BP224

Lead-Free Terminal Universal with Stud for Bolt on Cable



BP226

- Lead coated brass for extra strength and conductivity

SOLDERABLE TERMINALS & ADAPTERS

Part No.	Description	Gauge	Std. Pkg.
BP11U	Open neck for bare cable	4-2/0	5
BP21U	Bell type neck for insulated cable	6	5
BP2	Bell type neck for insulated cable	6-4	5
BP25U	Bell type neck for insulated cable, universal	2	5
BP26U	Bell type neck for insulated cable, positive	2-1	5
BP20U	Bell type neck for insulated cable	1/0-2/0	5
BP20N	Bell type neck for insulated cable, negative	1/0-2/0	5
BP20P	Bell type neck for insulated cable, positive	1/0-2/0	5
BP83N	Bell type neck for insulated cable, negative	2/0-3/0	1
BP83P	Bell type neck for insulated cable, positive	2/0-3/0	1

TOP-MOUNT - 90°

Part No.	Description	Gauge	Std. Pkg.
BP3U	Universal 90° elbow	4-2	5
BP1U	Universal 90° elbow	1/0-2/0	5
BP4U	Universal Split Barrel	4-6	5
BP2U	Universal Split Barrel	1-2	5
BP8P	Split Barrel Positive	1-2	5
BP8N	Split Barrel Negative	1-2	5
BP5U	Universal Split Barrel	1-2/0	5
BP6P	Split-barrel positive	1/0-2/0	5
BP6N	Split-barrel negative	1/0-2/0	5
BP7U	Universal Split Barrel	2/0-3/0	5
BP9P	Split Barrel Positive	3/0-4/0	5
BP9N	Split Barrel Negative	3/0-4/0	5
BP10N	Top post to stud converter, negative 3/8" x 3/4" w/ nut	n/a	5
BP10P	Top post to stud converter, positive 3/8" x 3/4" w/ nut	n/a	5

* Go to page numbers B35-B38 for crimping tools & heat shrink tubing.

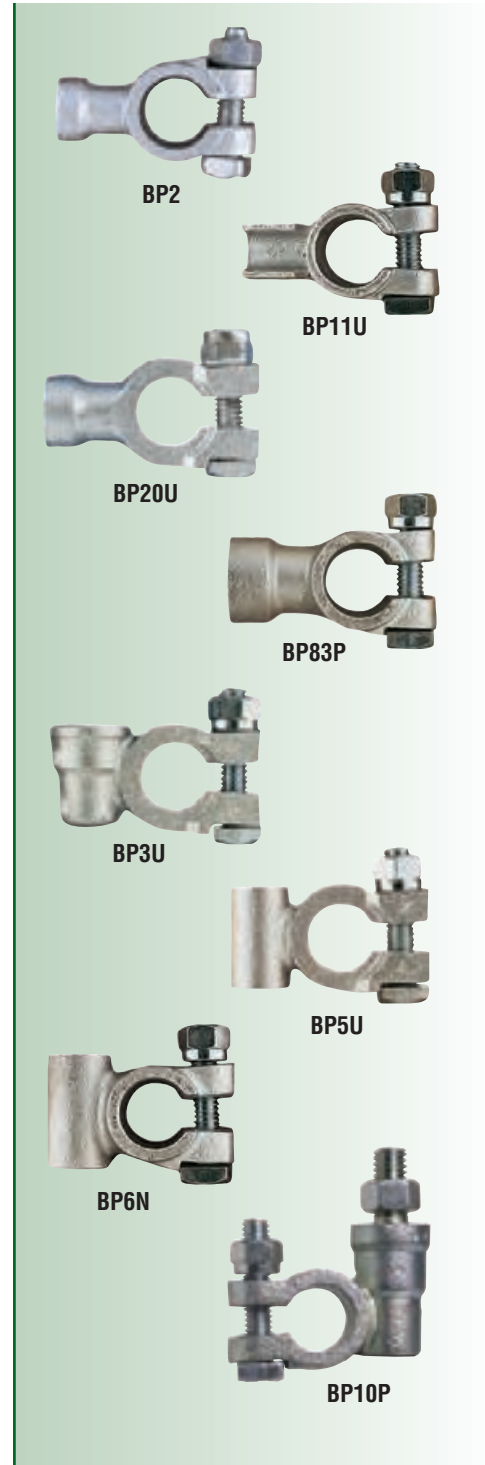

BATTERY TERMINALS & EMERGENCY BATTERY TERMINALS



- Lead and brass terminals for extra strength and conductivity
- Nickel-plated for extra corrosion resistance

EMERGENCY SOLDERLESS TERMINALS

Part No.	Description	Gauge	Std. Pkg.
BP17U	Epoxy-coated lead terminals Display packed	6 - 2/0	1 pr./clam (red/black)
BP19U	Universal, nickel-plated brass terminal	6 - 1	5
BP19C	Card of ten BP19U		2 cards
BP67U	Universal, lead terminal	6 - 2/0	5
BP67C	Universal, lead terminal card of 10	8 - 4	2 cards
BP67UC	Card of 10 BP67C	8 - 4	10 cards
BP23U	Universal, solid lead terminal	4	5
BP23C	Card of ten BP23U	4	2 cards
BP23UC	Card of ten BP23U	4	10 cards
BP97U	Universal, heavy-duty solid lead terminal	1/0 - 3/0	1
BP97	Display pkg of BP97U	1/0 - 3/0	2/clam
BP97C	Card of ten BP97U	1/0 - 3/0	2 cards
BP28	Top mount 3-way terminal	2-1/0	1 pr./clam (1 pos., 1 neg)
BP81	Universal side mount	6 - 1	2/clam
BP81C	Card of 10 BP81	6 - 1	2 cards

MARINE BATTERY TERMINALS

Part No.	Description	Std. Pkg.
BP22U	Universal, solid lead marine terminal with zinc plated steel $\frac{5}{16}$ " wing nut	5/box
BP22	Display pack of BP22U	2/clam
BP22C	Card of 10 BP22U	2 cards
BP58N	Cast brass negative marine terminal with $\frac{5}{16}$ " wing nut	5/box
BP58P	Cast brass positive marine terminal with $\frac{3}{8}$ " wing nut	5/box
BP58U	Cast brass universal marine terminal with $\frac{5}{16}$ " wing nut	5/box
BP22N	Negative lead marine terminal with zinc-plated steel $\frac{5}{16}$ " wing nut	5/box
BP22P	Positive lead marine terminal with zinc-plated steel with $\frac{3}{8}$ " wing nut	5/box
BP22W	Wing nut for BP22U, BP22N, and BP58N - $\frac{5}{16}$ " thread	10/box
BP22PW	Wing nut for BP22P and BP58P - $\frac{3}{8}$ " thread	10/box

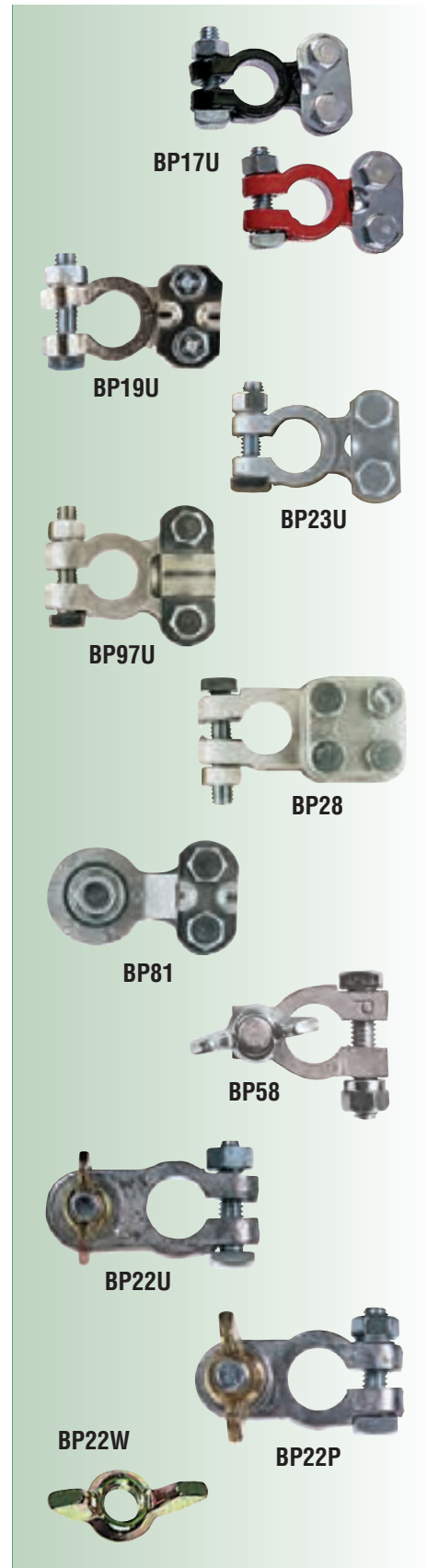

BATTERY CABLES

BATTERY TERMINAL ADAPTERS

TERMINAL ADAPTERS

Part No.	Description	Std. Pkg.
BP37	Quick connection with locking twist cap. Ideal for easy removal	1/clam
BP89*	Side Terminal Quick-disconnect battery bolts	1 pr.
BP111	Top Post Quick-disconnect battery bolts	1 pr.
BP112	HD Top Post Quick-disconnect battery bolts	1 pr.
BP77N	For adapting top post battery cable to side terminal battery. $\frac{3}{8}$ " threaded stud screws into negative battery terminal	5
BP77P	Same as BP77N—but for positive terminal	5
BP78	$\frac{3}{8}$ " x $\frac{1}{2}$ " side terminal battery bolt	5
BP78L	$\frac{3}{8}$ " x 1" extra long side terminal battery bolt. Auxiliary screw in end provides accessory hookup. Display pack (2/clam)	5 clams
BP79	For adapting side terminal battery cable to top post batteries. Universal solid lead (Display packed)	1 pos., 1 neg.
BP139	Side terminal battery cable bolt	5
BP141	Stud-to-post conversion. $\frac{3}{8}$ " stud. Display pack (1pos., 1neg./clam)	1 clam
BP182	Charging post, side mount. Display pack (2/clamshell) — install with side terminal cable	1 clam
BP183	Diesel side terminal battery cable bolt. For connecting 2 battery cables. Use with BP184 spacer	5
BP184	Spacer required to connect diesel battery cable. Use with BP183 bolt	5
BP193	Side mount terminal extension bolt. Heavy duty brass construction	5
BP194	Adaptor nut replaces regular $\frac{5}{16}$ " shoulder nut on top post clamps. Has $\frac{5}{16}$ " x $\frac{3}{4}$ " stud for accessory wires	5

MILITARY BATTERY POST ADAPTERS

Part No.	Description	Std. Pkg.
BP24	Universal, Military type; for tapping auxiliary leads	5
BP36N	Battery post adapter. Meets military specification MS75004-1 (neg.)	5
BP36P	Battery post adapter. Meets military specification MS75004-2 (pos.)	5

GARDEN TRACTOR BATTERY ADAPTERS

Part No.	Description	Std. Pkg.
BP38	Flag to post terminal adapters. Designed to convert most group U-1 flag terminal batteries to post terminal applications (Display packed)	2/clam
BP39	Carriage nuts and bolts. For utility and garden tractor battery cables. 2 bolts ($\frac{1}{4}$ " x $\frac{3}{4}$ ") and 2 nuts (Display packed)	2/clam

* Available while supplies last

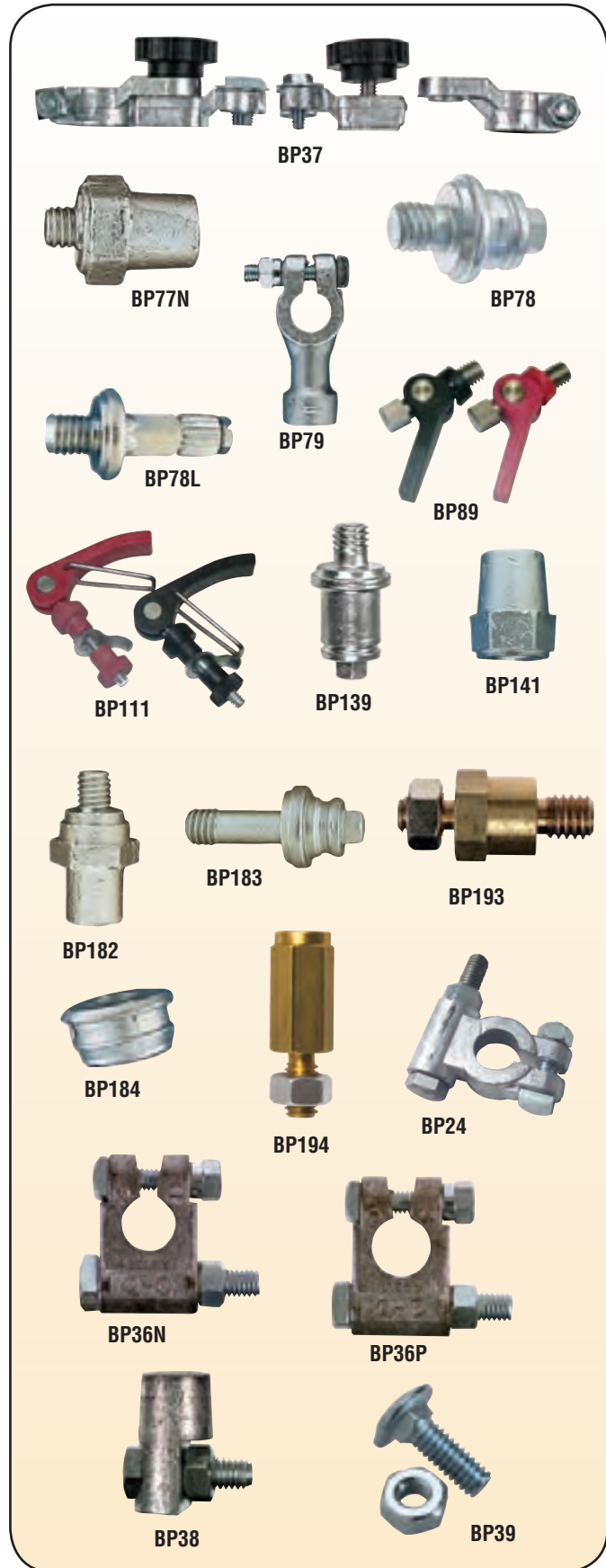

BATTERY & STARTER CABLE LUGS



BATTERY CABLES

BATTERY CABLE LUGS

- Solid copper for maximum conductivity
- One-piece seamless construction
- Can be used with battery cable solder slugs (Go to page B23)

Part No.	Gauge	Stud Size	Std. Pkg.	Part No.	Gauge	Stud Size	Std. Pkg.
BP300	8	#10	25	BP330	1	3/8"	10
BP301	8	1/4"	10	BP317*	1	1/2"	10
BP304	8	3/8"	10	BP314	1	1/2"	10
BP305	6	#10	25	BP316	1/0	3/8"	25
BP331	6	1/4"	10	BP327	1/0	1/2"	10
BP302	6	5/16"	10	BP318	2/0	5/16"	10
BP303	6	3/8"	25	BP319	2/0	3/8"	25
BP342	4	1/4"	10	BP320	2/0	1/2"	10
BP332	4	5/16"	10	BP341	2/0	5/8"	10
BP307	4	3/8"	25	BP322	3/0	3/8"	10
BP308	4	1/2"	10	BP323	3/0	1/2"	10
BP329	2	3/8"	10	BP328	4/0	3/8"	2
BP311	2	1/2"	10	BP326	4/0	1/2"	10
BP313	1	5/16"	10				

NOTE: The lugs shown are unplated copper. Lugs that are gray in color are tin-plated copper. Both types provide equal conductivity.

* Extra wide pad

Actual Size



BP307



BP320

SUPER HEAVY STARTER LUGS

- Heavier wall thickness and wide pads for greater heat sink
- Longer barrels for more crimping area. Can be soldered
- Electro Tin plated for reducing corrosion
- Color coded to identify correct die

Part No.	Gauge	Stud Size	Color	Std. Pkg.
BP347	4	1/4"	Gray	5
BP348	4	5/16"	Gray	5
BP350	4	3/8"	Gray	5
BP349	1-2	5/16"	Pink	5
BP351	1-2	3/8"	Pink	5
BP333	1/0	3/8"	Black	5
BP334	1/0	1/2"	Black	5
BP335	2/0	3/8"	Orange	5
BP336	2/0	1/2"	Orange	5
BP337	3/0	3/8"	Purple	5
BP338	3/0	1/2"	Purple	5
BP339	4/0	3/8"	Yellow	5
BP340	4/0	1/2"	Yellow	5



BP334



BP335



BP352



BP355

LOCKING LUGS

- Locking Magna Lugs are designed for stud terminal batteries – Tin Plated Copper

Part No.	Gauge	Style	Color	Std. Pkg.	Lug Hole
BP352	1/0	Lug End	Black	5	3/8"
BP353	2/0	Lug End	Orange	5	3/8"
BP354	3/0	Lug End	Purple	5	3/8"
BP355	1/0	Dual Wire	Black	5	3/8"
BP356	2/0	Dual Wire	Orange	5	3/8"
BP357	3/0	Dual Wire	Purple	5	3/8"

SPLICE CONNECTORS, BOLTS & SHIMS

FOR PROFESSIONAL WIRE & CABLE INSTALLATIONS

HEAVY DUTY THICK WALL COPPER LUGS

Copper alloy for best conductivity, die cast and tin plated

Part No.	Gauge	Stud Size	Color	Std. Pkg.
BP358	6	3/8"	Gray	5
BP359	4	1/2"	Gray	5
BP360	4	3/8"	Gray	5
BP361	2	1/2"	Green	5
BP362	2	3/8"	Green	5
BP363	1	1/2"	Pink	5
BP364	1	3/8"	Pink	5
BP365	1/0	3/8"	Black	5
BP366	1/0	1/2"	Black	5
BP367	2/0	3/8"	Orange	5
BP368	2/0	1/2"	Orange	5
BP369	3/0	3/8"	Purple	5
BP370	3/0	1/2"	Purple	5
BP371	4/0	3/8"	Yellow	5
BP372	4/0	1/2"	Yellow	5

BUTT SPLICE CONNECTORS

- Made of tinned copper for extra corrosion resistance
- Flared ends permit easy cable insertion

Part No.	Gauge	Std. Pkg.
SST299	8	10
SST300	6	10
SST301	4	10
SST302	2	10
SST303	1	10
SST304	1/0	10
SST305	2/0	10
SST306	3/0	10
SST307	4/0	10

SUPER HEAVY DUTY BUTT SPLICE CONNECTORS

Part No.	Gauge	Color	Std. Pkg.
BP343	1/0	Black	5
BP344	2/0	Orange	5
BP345	3/0	Purple	5
BP346	4/0	Yellow	5

STEP-DOWN BUTT CONNECTORS

Part No.	Gauge	Std. Pkg.
SST89	10-12 to 8 Ga.	10
SST90	14-16 to 12-10 Ga.	10

BATTERY CABLE BOLTS & SHIMS

Part No.	Description	Length	Std. Pkg.
BP40	Blue Di-Chromate Battery bolt	1 7/16"	25
BP40C	5/16" raised shoulder nut		
BP40C	Display packaged version of BP40	1 7/16"	4
BP40N	5/16" nut only		25
BP46	Plated nut & bolt	1 3/8"	25
BP56	1/4" raised shoulder nut		25
BP56	Battery post shim		25
BP56C	Pre-formed soft lead		2
BP56C	Display packaged version of BP56		2
BP57	Plated Flange 5/16" nut		10
BP59	T-shaped bolt for GM & VW vehicles. Includes nut & washer		5
BP59C	Display version of BP59		1
BP119	Tapered seat nut for GM vehicles		10



BATTERY CORROSION PROTECTION

PREVENT POWER LOSS BY PREVENTING CORROSIVE BUILD-UP

BATTERY TERMINAL PROTECTORS

Chemically-impregnated felt gaskets. Installed between the battery and terminal to stop corrosion. Prevents corrosive build-up that interferes with electrical connection and causes engine starting failure.

Part No.	Description	Std. Pkg.
BPP71	Polyester pad protector for post-type battery	1 clam (2 pads)
BPP73	Polyester pad protector for side-mount battery	1 clam (2 pads)
BPP74	Can of 100 BPP71 terminal protectors	1 can (100 pads)



BATTERY CORROSION PROTECTION

SW4 - Self-Fusing Sealing Wrap

This self-fusing sealing wrap is designed for primary wire and battery cable terminals. Heat sealable wrap seals terminal area against corrosion, moisture, abrasion and weather.

Part No.	Description	Size	Std. Pkg.
SW4	Heat sealable sealing wrap (2 1/2" width)	10 ft.	1 box

SW4 Sealing Wrap Instructions



Fig. 1 Cut to length. Place connector in center of wrap.



Fig. 2 Fold over joint and squeeze. Heat to seal.

BATTERY TERMINAL PROTECTORS

- Protects your battery against possible explosion by reducing the chance of sparks
- Color codes battery cables to easily identify polarity
- Reduces battery terminal corrosion

Part No.	Cable Size	Color	Style	Qty.	Std. Pkg.
BP32	4 & 6	1 Red, 1 Black	Straight Clamp Snap-on	2 per bag	5 bags
BP155	1 & 2	1 Red, 1 Black	Straight Clamp Snap-on	2 per bag	5 bags
BP48B	6	Black	Straight Clamp	1	1
BP48R	6	Red	Straight Clamp	1	1
BP49B	4	Black	Straight Clamp	1	1
BP49R	4	Red	Straight Clamp	1	1
BP50B	1 & 2	Black	Straight Clamp	1	1
BP50R	1 & 2	Red	Straight Clamp	1	1
BP51B	1/0 & 2/0	Black	Straight Clamp	1	1
BP51R	1/0 & 2/0	Red	Straight Clamp	1	1
BP159R	3/0 - 4/0	Red	Straight Clamp	1	1
BP159B	3/0 - 4/0	Black	Straight Clamp	1	1
BP55B	1 & 2	Black	Flag Clamp	1	1
BP55R	1 & 2	Red	Flag Clamp	1	1
BP52B	1/0 - 3/0	Black	Flag Clamp	1	1
BP52R	1/0 - 3/0	Red	Flag Clamp	1	1
BP53B	1 & 2	Black	Left Elbow Clamp	1	1
BP53R	1 & 2	Red	Left Elbow Clamp	1	1
BP54B	1/0 - 3/0	Black	Left Elbow Clamp	1	1
BP54R	1/0 - 3/0	Red	Left Elbow Clamp	1	1
BP149B	1 & 2	Black	Right Elbow Clamp	1	1
BP149R	1 & 2	Red	Right Elbow Clamp	1	1
BP150B	1/0 - 3/0	Black	Right Elbow Clamp	1	1
BP150R	1/0 - 3/0	Red	Right Elbow Clamp	1	1
BP151B	1 & 2	Black	Marine Wing Nut Clamp	1	1
BP151R	1 & 2	Red	Marine Wing Nut Clamp	1	1
BP152B	1/0 & 2/0	Black	Marine Wing Nut Clamp	1	1
BP152R	1/0 & 2/0	Red	Marine Wing Nut Clamp	1	1
BP153B	1 & 2	Black	Stud Terminal 3/8"	1	1
BP153R	1 & 2	Red	Stud Terminal 3/8"	1	1
BP154B	1/0	Black	Stud Terminal 3/8"	1	1
BP154R	1/0	Red	Stud Terminal 3/8"	1	1
BP156B	-	Black	Side Terminal	1	1
BP156R	-	Red	Side Terminal	1	1
BP157B	6 & 4	Black	Lug End	5	5
BP158B	10 & 8	Black	Lug End	5	5



BATTERY CABLES

QUICK-CONNECT BATTERY COUPLERS

SAFE-MATE® QUICK-CONNECT BATTERY COUPLERS

- Used for:
- Electric fork-lifts
 - Booster cables on tow trucks
 - Battery connectors on race cars

Safe-Mate® quick-connect couplers plug together instantly, handle high current loads with minimum voltage drop. Popular on electric fork lift trucks: battery cables can quickly be disconnected from system and hooked up to battery charger.

The durable, high impact Lexan™ housing eliminates breakage and withstands rough usage. Heavy contacts are silver-plated copper for high current capacity. Terminals can be crimped (with heavy duty crimping tool) or soldered. Sold in five color-coded sizes, for 12 gauge to 2/0 gauge cables.

Part No.	Description	Color	Gauge	Std. Pkg.
SST309	2 conductor, 50 Amp.	Yellow	12-10	1
SST309T	Contacts only for SST309			2
SST308	2 conductor, 50 Amp.	Blue	6	1
SST308T	Contacts only for SST308			2
SST312	2 conductor, 175 Amp.	Pink	4	1
SST313	2 conductor, Blue Housing, 175 Amp.			1
SST312T	Contacts only for SST312, SST313	Pink	1/0	2
SST310	2 conductor, 175 Amp.			1
SST310T	Contacts only for SST310			2
SST311	2 conductor, 350 Amp.	Orange	2/0	1
SST311T	Contacts only for SST311			2



Standard package: 1 housing, 2 contacts, to make up one side of a quick-connect coupler. Use 2 standard packages for a complete connection.

Assembly Instructions

1. Match the contact size to the cable size. Strip cable 1/8" longer than barrel length.

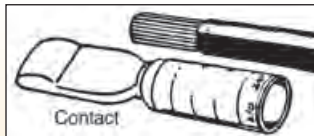

2. Insert stripped cable into contact barrel. Crimp with heavy-duty crimping tool, or solder. Apply heat-shrink tubing to protect the connection.

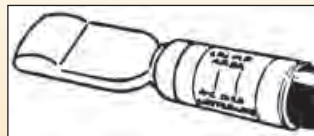

3. Insert crimped contact into housing ("top" up) and push until it locks into place. Repeat with second contact. Be sure to observe cable polarity.

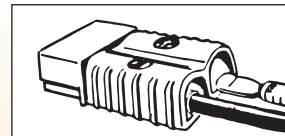

4. Assembly can be mated with another housing of the same gauge and part number.

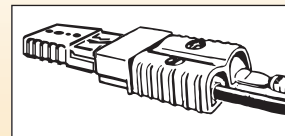

QUICK-CONNECT BATTERY COUPLER ACCESSORIES

- Protective caps fit over connector mating points for all weather protection
- Durable PVC material rated at 105°C

Part No.	Description	Std. Pkg.
BP47	Handle for Safe-Mate® 50 Amp.	1
BP48	Handle for Safe-Mate® 175 Amp. & 350 Amp.	1
BP33	Cover for SST308/SST309 50 Amp. connector	1
BP34	Cover for SST310/SST312/SST313 175 Amp. connector	1
BP35	Cover for SST311 350 Amp. connector	1

PLUG-IN 4 GA. INDUSTRIAL BOOSTER CABLES

BC105	25 ft. overall length. 5 ft. section attaches directly to vehicle. 20 ft. section has heavy duty 800 Amp. clamps and snaps easily into permanently mounted cable. Perfect for tow trucks or fork lifts
BC106	5 foot section. Ideal where multiple tow trucks or fork lifts are used. Protective cap included

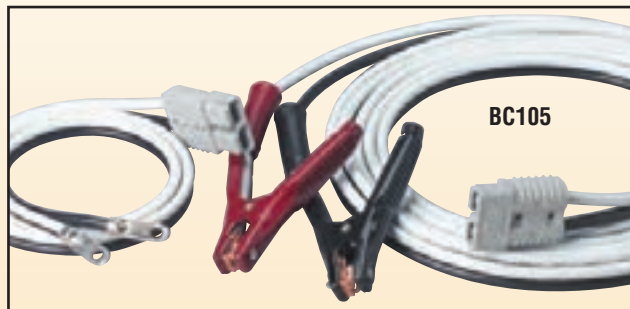
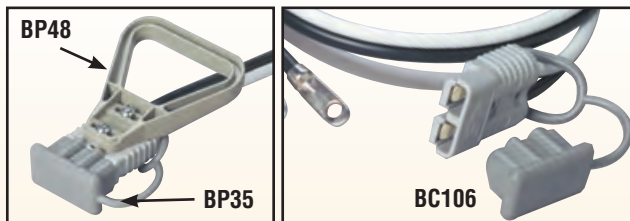

AUXILIARY STARTING SYSTEM



AUXILIARY STARTING SYSTEM

Engineered especially for Fleets and Professional Service!

The fast and effective Auxiliary Starting System provides quick jump starting capability. No manual hook-up to battery. Correct polarity is assured. 2/0 gauge.

Instructions:

1. Permanently wire BCS5 Receptacle to vehicle(s) which may require jump starting.
2. Attach BCS4 Protective Dust Cover to BCS5 Receptacle.
3. Permanently wire BCS6 Mating Plug to mobile power source.
4. Use BCS1 Auxiliary Jumper Cables to connect Mobile Power Source to vehicle(s) equipped with BCS5 Receptacle when jump starting is required.



Part No.	Description	Std. Pkg
BCS1*	16' Auxiliary Jumper Cable – Connects vehicle to power source	1
BCS2*	Optional 32' Auxiliary Jumper Cable	1
BCS3*	16' Auxiliary Jumper Cable with 800 Amp. booster clamps	1
BCS4	Protective Dust Cover for Female Receptacle BCS5	1
BCS5	Female Receptacle (Includes BCS4 Dust Cover) – mounts to vehicle	1
BCS6	Male Mating Plug – mounts to power source	1

* Available while supplies last

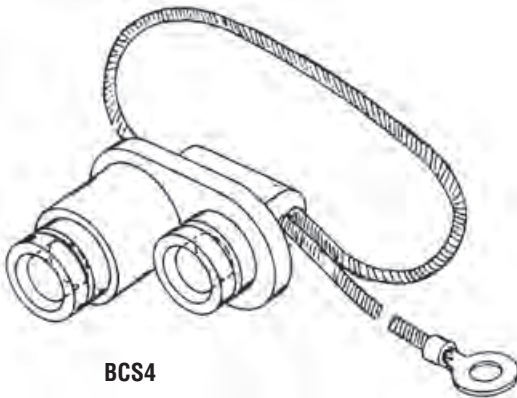

BCS4

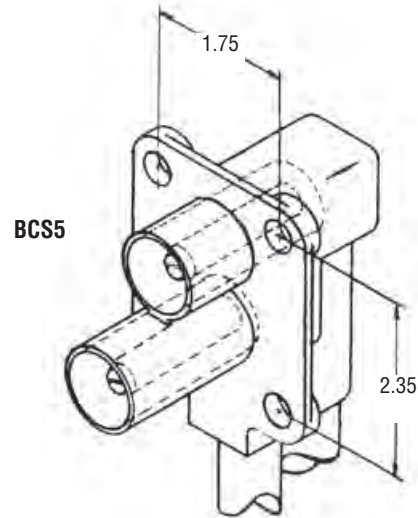

BCS5

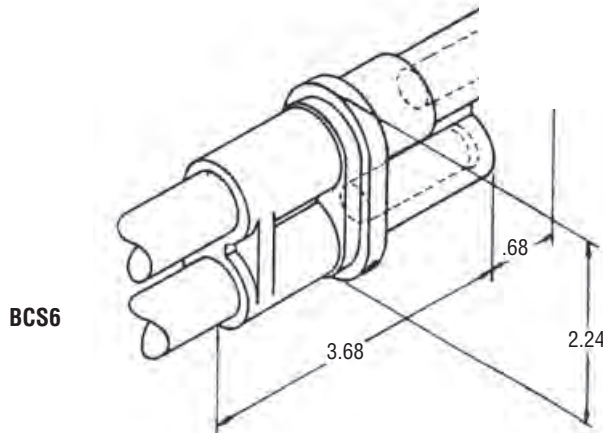

BCS6

BATTERY TOOLS, ACCESSORIES & BATTERY HOLD-DOWNS

BATTERY TEST CLIPS

Part No.	Description	Std. Pkg.
BP60	5 Amp. Nickel plated alligator clip- 1 1/2". Opens to 3/16"	10
ET60	Display clam BP60	6
BP80	Vinyl boots for use with BP60 and ET60	5 red, 5 blk
ET57	Display clam BP80	2 red, 2 blk
BP61	10 Amp. clip with serrated jaws - 2". Opens to 3/16"	10
ET59	Display clam BP61	4
BP61A	Vinyl boots for BP61 and ET59	5 red, 5 blk
BP62	25 Amp. clip with serrated jaws- 2 7/8". Opens to 3/4"	10
ET58	Display clam BP62	2 per clam
BP62A	BP62A Vinyl boots for BP62 and ET58 battery clip	5 red, 5 blk
BP63	50 Amp. battery clip- 4". Opens to 1 3/16"	10
BP63A	Vinyl boots for BP63 battery clip	1 pr.
BP69	50 Amp. Copper-plated steel test clip- 3". Opens to 3/4"	3 red, 3 blk
ET67	Display Clam BP69	1 pr.
BP65	75 Amp. copper- 3". Opens to 3/4"	3 red, 3 blk
BP65C	Display clam BP65	1 pr.
BP73	100 Amp battery clip- opens to 1 1/4"	5
BP64	200 Amp. copper clip- 6". Opens to 1 5/8"	1 stamped/1 plain
BP64A	Vinyl boots for BP64 & BP73 battery clip	1 pr.
ET70	36" test lead. Un-insulated alligator clips. For test emergency trouble lead.	1 per clam
ET71	Pair of 30" insulated leads.	1 per clam

ET Display Package

BATTERY SERVICE TOOLS

Part No.	Description	Std. Pkg.
BP31	Cup-type charging connector with 14" wire	10
BP70S	Carrying strap for top post batteries (14" center-to-center)	10
BP70L	Same as above — for long batteries (21" center-to-center)	10

BATTERY CLEANERS

Part No.	Description	Std. Pkg.
TC1	Trailer Connector Assembly Cleaner	1
BP72C	Battery post & terminal cleaning brush kit	1 per clam
BP72A	Plastic Battery post & terminal cleaning brush kit	1 per clam

BATTERY BOLTS

Part No.	Description	Style	Std. Pkg.
HD59C	9 3/4" x 5/16" - 3" Thread	J	1 per clam
HD60C	12" x 5/16" - 5" Thread	J	1 per clam
HD61C	8 7/8" x 1/4" - 3" Thread	L	1 per clam
HD62C	8" x 1/4" - 4" Thread	L	1 per clam
HD63C	10" x 1/4" - 3 3/4" Thread	L	1 per clam
HD64C	6" x 5/16" - 1 1/2" Thread	J	1 per clam

Bolts include washers and nuts

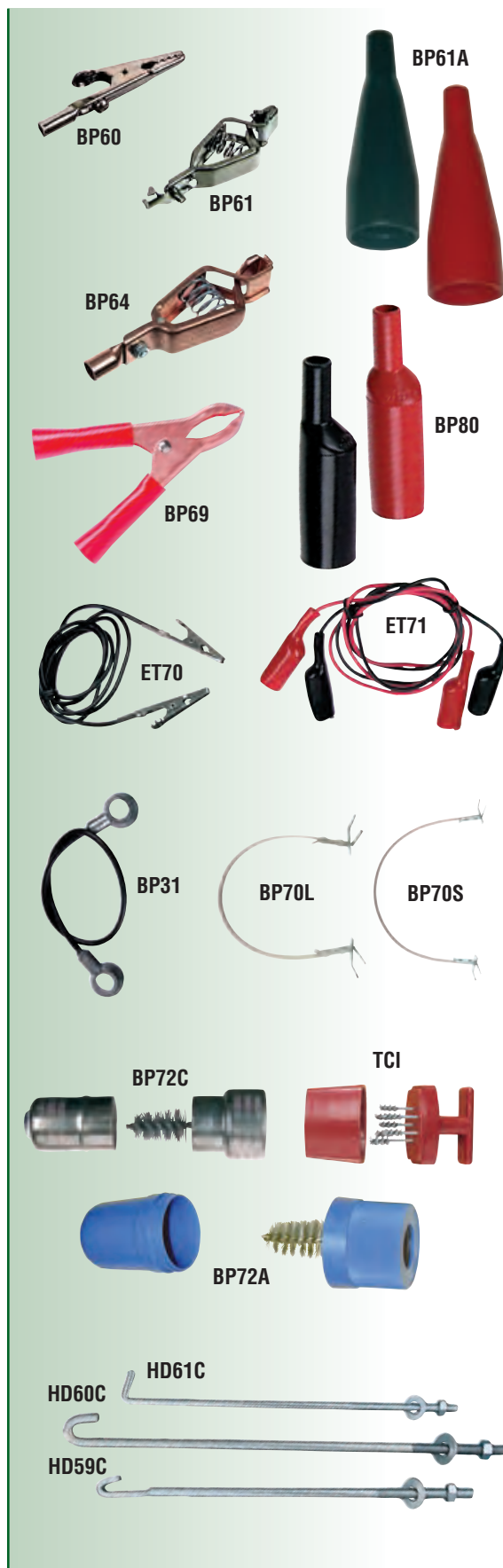

BATTERY HOLD-DOWNS & TOOLS



BATTERY HOLD DOWNS

Part No.	Applications	Std. Pkg.
HD56	Rubber hold down. Fits across 6 1/4" battery. Includes 2 J-bolts & 2 washers	1/box
HD57*	AABM Groups 22F, 24, 27G, 27H, 60 Permits installation of heavy duty or next larger size battery. No height limitation	1 card

* Includes 2 mounting brackets

TOP MOUNT

Part No.	Size L x W	Applications	Std. Pkg.
HD62	Adjustable 8 1/8" min. length, 13 3/8" max. length	For square or rectangular batteries with flush vent covers	1
HD63	Adjustable 5 3/4" min. length, 8 1/2" max. length	For square or rectangular batteries with flush vent covers	1
HD64	Adjustable 4 1/4" min. length, 6 5/8" max. length	For square or rectangular batteries with raised vent covers	1

HD62, HD63, & HD64 - made of polypropylene, corrosion proof and non-conducting, works on cars, trucks, boats, farm commercial and recreational vehicles

BATTERY HOLD DOWN KITS

Part No.	Applications	Std. Pkg.
HD65	12" L x 6 7/8" W	1
HD66	10 7/8" L x 6 7/8" W	1

BASE MOUNT

Part No.	Applications	Std. Pkg.
HD58**	For GM; AABM Groups 22C, 22FC, 24, 24C	1

** Includes steel and fiber washer (1 each) & bolt

BATTERY TOOLS

WTT7 Crimps solderless terminals to battery cable, welding cable and primary wire . . . from 16 to 4/0 gauge. Use with a hammer or vise. Produces reliable crimps with excellent mechanical strength and electrical integrity. Depth gauge indicates when proper crimp is achieved. V-shaped nest design prevents overcrimping. Std. Pkg. 1.

WTT8 7 3/4" long. Ideal for one-hand operation. Designed for fast, easy cutting of multi-conductor cable, battery and welding cable up to 2/0 gauge. Std. Pkg. 1. Display packed.

WTT10 Professional crimping tool is 26" long. Double lever construction provides extra crimping power for heavy-duty jobs. Ideal for crimping copper terminals, lugs and butt connectors from 6 to 4/0 gauge. Rotatable, multi-die sets eliminate the need to stock extra dies. Diamond-shaped dies compress all strands uniformly to achieve high-integrity crimps. Std. Pkg. 1.

WTT33 Jr. crimper crimps cables from 8 Ga. to 1 Ga. Designed for medium to heavy duty crimps. Ideal for use where space is limited. Length 16", Std. Pkg. 1.

WTT11 Large, heavy-duty cutter is 16 1/2" long. Easily cuts through 4/0 gauge battery/welding cable. Blades are tough moly-steel; keep a sharp edge longer. Curved blade makes a clean cut with minimum strand distortion. Std. Pkg. 1.

WTT16 Battery cable stripper – gauges up to 4/0

WTT30 Bench mount crimp tool. Same construction and features as WTT10. Inverted crimp head allows direct visual inspection of crimp during operation for more reliable connection.



Adjustable Top Mount Hold Down

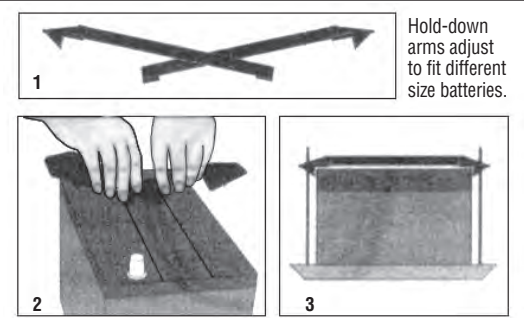

Hold-down arms adjust to fit different size batteries.

They lock in 1/8" increments and can be used in end-to-end and side-to-side applications.

Once installed use conventional J-bolts (not included) to secure the battery.

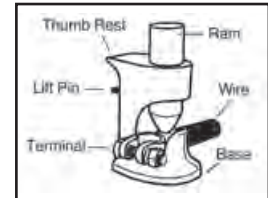

HEAT SHRINK TUBING

DUAL WALL, POLYOLEFIN, WITH SEALANT 3-1 SHRINK RATIO

Part No.	Color	Wire Gauge	ID"	Shrinks To"	Length	Shrink Ratio	Std. Pkg.
HST85	Black	30-18	0.125	0.040	1.125"	3-1	20
HST88	Black	20-14	0.187	0.060	6"	3-1	10
HST86	Black	18-10	0.250	0.080	1.25"	3-1	20
HST84	Black	18-10	0.250	0.080	1.5"	3-1	50
HST89	Black	18-10	0.250	0.080	6"	3-1	10
HST87	Black	12-6	0.375	0.125	1.25"	3-1	20
HST91	Black	12-6	0.375	0.125	6"	3-1	10
HST83	Black	8-4	0.500	0.160	1"	3-1	20
HST83R	Red	8-4	0.500	0.160	1"	3-1	20
HST82	Black	8-4	0.500	0.160	6"	3-1	20
HST210	Black	4-2/0	0.750	0.250	1.125"	3-1	20
HST210R	Red	4-2/0	0.750	0.250	1.125"	3-1	20
HST92	Black	4-2/0	0.750	0.250	6"	3-1	10
HST230	Black	2-4/0	1.000	0.320	1.125"	3-1	20
HST230R	Red	2-4/0	1.000	0.320	1.125"	3-1	20
HST93	Black	2-4/0	1.000	0.320	6"	3-1	10

DUAL WALL, CLEAR POLYOLEFIN, WITH SEALANT 3-1 SHRINK RATIO

Clear dual wall tubing with contamination proof, watertight sealant. Provides strain relief and vibration resistance. Temp. range -55°C to 110°C / -67°F to 230°F.

Part No.	Color	Wire Gauge	ID"	Shrinks To"	Length	Shrink Ratio	Std. Pkg.
HST30	Clear	20-14	0.187	0.060	6"	3-1	10
HST28	Clear	14-8	0.312	0.060	6"	3-1	10
HST21	Clear	8-1	0.500	0.167	6"	3-1	10
ET27	Display Package of 3 HST21						
ET28	Display Package of 3 HST28						
ET29	Display Package of 4 HST30						
ET38	Display Package of Contains: 1 HST21, 1 HST28, 2 HST30						

HEAVY WALL, POLYOLEFIN WITH SEALANT 3-1 SHRINK RATIO

Flame retardant with contamination proof, watertight sealant. Mil spec, 23053/15 requirements for flame retardancy. UL 468 B & D listed. Temp. range -55°C to 125°C.

Part No.	Color	Wire Gauge	ID"	Shrinks To"	Length	Shrink Ratio	Std. Pkg.
HST146B	Black	14-6	0.400	0.150	6"	3-1	5
HST146R	Red	14-6	0.400	0.150	6"	3-1	5
HST81SB	Black	8-1	0.750	0.220	1.5"	3-1	20
HST81SR	Red	8-1	0.750	0.220	1.5"	3-1	20
HST81B	Black	8-1	0.750	0.220	6"	3-1	5
HST81R	Red	8-1	0.750	0.220	6"	3-1	5
HST240SB	Black	2-4/0	1.100	0.125	1.5"	3-1	20
HST240SR	Red	2-4/0	1.100	0.375	1.5"	3-1	20
HST240B	Black	2-4/0	1.100	0.375	6"	3-1	5
HST240R	Red	2-4/0	1.100	0.375	6"	3-1	5
ET21	Contains 1 each HST81B and HST81R						

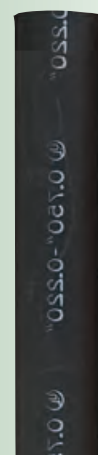

HST81B

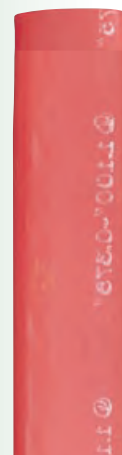

HST240R

HEAT SHRINK TUBING



SPLICING PATCHES

Adhesive Vinyl splicing patches. 2 1/2" x 2 1/2" provide moisture proof connections. Easier to use than tape. Adds strain relief to splices and protects against abrasion.

Part No.	Std. Pkg.
HST90	25

HIGH RATIO, HEAVY WALL, WITH SEALANT, 6-1 SHRINK RATIO

Thermoplastic adhesive sealant for a gas-tight, water-tight seal. 6 to 1 shrink ratio - ideal for heavy duty battery cable applications or a variety of connector configurations. Covers wide range of wire and cable gauge sizes. Post-shrink insulation thickness provides for very high tensile strength of 2100 psi. Temperature range -55°C to 110°C / -67°F to 230°F

Part No.	Color	Wire Gauge	ID"	Shrinks To"	Length	Shrink Ratio	Std. Pkg.
HST401	Black	8-4/0	1.300	.200	12"	6-1	2

THIN WALL, POLYOLEFIN, 2-1 SHRINK RATIO

Provides electrical insulation over splices and terminations. Excellent for bundling and cable identification. Temperature range -55°C to 135°C. Color coded, no sealant.

Part No.	Color	Wire Gauge	ID"	Shrinks To"	Length	Shrink Ratio	Std. Pkg.
HST18	Red	20-18	0.187	0.093	6"	2-1	10
HST18B	Black	20-18	0.187	0.093	6"	2-1	10
HST18H	Red	20-18	0.187	0.093	8'	2-1	1
HST18L	Red	20-18	0.187	0.093	50'	2-1	1
HST14	Blue	16-14	0.250	0.125	6"	2-1	10
HST14H	Blue	16-14	0.250	0.125	8'	2-1	1
HST14L	Blue	16-14	0.250	0.125	50'	2-1	1
HST10	Yellow	12-10	0.312	0.156	6"	2-1	10
HST10H	Yellow	12-10	0.312	0.156	8'	2-1	1
HST10L	Yellow	12-10	0.312	0.156	50'	2-1	1
HST6	Black	8-2	0.500	0.250	6"	2-1	5
HST6H	Black	8-2	0.500	0.250	8'	2-1	1
HST6L	Black	8-2	0.500	0.250	50'	2-1	1
HST3	Black	2-3/0	1.000	0.500	6"	2-1	10

ET18 Display Package of 6 HST18
 ET14 Display Package of 5 HST14
 ET12 Display Package of 4 HST10
 ET2 Display Package of 3 HST6
 ET20 Display Package Contains: 2 HST18, 2 HST14, 1 HST10

SINGLE WALL, PVC 2-1 SHRINK RATIO

Part No.	Color	Wire Gauge	ID"	Shrinks To"	Length	Shrink Ratio	Std. Pkg.
STT260	Black	20-18	0.187	0.093	1.5"	2-1	25
STT261	Black	16-14	0.250	0.125	1.5"	2-1	25
STT262	Black	12-10	0.375	0.188	1.5"	2-1	25
STT263	Black	8-2	0.500	0.250	1.5"	2-1	10
STT263R	Red	8-2	0.500	0.250	1.5"	2-1	10
STT264	Black	1-2/0	0.750	0.375	1.5"	2-1	25
STT264R	Red	1-2/0	0.750	0.375	1.5"	2-1	25
STT265	Black	2/0-4/0	1.000	0.500	1.5"	2-1	10
STT265R	Red	2/0-4/0	1.000	0.500	1.5"	2-1	10

ET263 Display Package of 12 STT261
 ET260 Assortment Contains: 4 STT260, 4 STT261, 4 STT262



HST90



HST401

Pre-Shrink Dia. 1.3"
Shrink Diameter .222"



HST10H

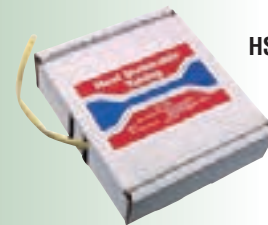

HST10L



HST18



HST14



HST10

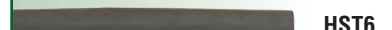

HST6



HST3



STT260



STT263



STT264R



STT265

HEAT SHRINK GUNS & ASSORTMENTS

MULTI-PURPOSE HEAT GUN

WTT20 Multi-purpose hot air gun. Can be hand-held or mounted vertically. 3-position switch: HIGH (1100°F); OFF; LOW (750°F.) 1200 Watts (max) 120 Volts AC. 6-ft. grounded line cord. Recommendation for heat shrink tubing: LOW setting with nozzle-to-work distance about 3". Std. Pkg. 1.

WTT21 Heat gun deflector for heat shrink tubing. Use with WTT20. Also included with purchase of heat gun WTT20. Std. Pkg. 1.

MINI BUTANE TORCH

WTT28* Butane torch includes heat deflector and handy carrying case. Piezo ignition system controls for flame intensity and air mixture. Butane not included. Std. Pkg. 1.

CAUTION: Do not operate in engine compartment. Recommended for shop use in well ventilated areas.

* While supplies last

BUTANE MICRO TORCH

WTT29 Micro Torch turns readily available disposable butane lighter of similar design or included fuel cell into handy powerful micro torch. Piezo electronic ignition system with safety lock. Flame temperature up to 2400°F (1300°C). Wind proof flame and waterproof ignition. Compact size fits most tools kits. Std. Pkg. 1.

WTT22 Self Igniting Butane. Micro Torch. Butane not included. Std. Pkg. 1.

CAUTION: Read instructions before use. Refer to package for complete warnings and cautions. Do not ignite or operate near open flame, heater, furnace, near combustible materials or in engine compartment. Recommended for shop use in well ventilated areas.

FLAMELESS HEAT TORCH

WTT31 Flameless Heat Torch. Fuel cell included. Std. Pkg. 1.

CAUTION: Read instructions before use. Refer to package for complete warnings and cautions. Do not ignite or operate near open flame, heater, furnace, near combustible materials or in engine compartment. Recommended for shop use in well ventilated areas.

HEAT SHRINK TUBING ASSORTMENT

HST1A – 6" long. Std. Pkg. 1
Contents:

Part No.	Qty.	Part No.	Qty.
HST6	5	HST81B	2
HST10	10	HST81R	2
HST14	10	HST240B	2
HST18	10	HST240R	2

CLEAR HEAT SHRINK TUBING ASSORTMENT

HST2A – 6" long. Std. Pkg. 1
Contents:
Dual Wall with water-tight sealant.
Temperature range:
-55°C to 110°C / -67°F to 230°F

Part No.	Qty.	
HST30	10	
HST28	10	
HST21	10	
WTT31	1	Flameless Heat Torch



HOW TO USE HEAT SHRINK TUBING

CAUTION: Disconnect battery cables before applying heat shrink tubing!

- 1 Select tubing to assure a tight fit after shrinkage. Consider the outside dimension of the terminal when determining tubing diameter. Shrink ratios: 3:1 for double wall tubing; 2:1 for single wall.
- 2 Cover at least 1/2" of the terminal barrel and 1" of the cable.
- 3 Apply heat evenly to all areas of the tubing. When tubing starts to shrink, focus heat at center of tubing and move heat toward ends to eliminate any trapped air.



Ignition Wires

Battery Cables

Primary Wire

Terminals & Connectors

Trailer Connectors

Sockets, Pigtails & Switches

Safety Accessories

O.E. Interchanges

Index

PRIMARY WIRE & ACCESSORIES

STANDARD® THE NUMBER ONE CHOICE! FOR AUTOMOTIVE & MARINE...



OE manufacturers have been using TWP (thin wall PVC) wire since the early 1990s in order to save weight without sacrificing functionality. Wire gauge is determined by the total cross sectional area of the copper conductor strands (see listings below). Don't be misled by the thickness of the jacket when selecting wire size.

- Our TWP primary wire is manufactured with the highest stranded copper wire with tough durable vinyl insulation.
- The insulation resists abrasion, grease, oil and battery acid; and won't support combustion.
- Our wire is available in a broad range of sizes, types, and colors for any electrical repair, replacement or customizing job.

THERMOPLASTIC PRIMARY WIRE

SAEJ1128 Requirement – Type TWP Temperature Max 80°C/176°F									
Wire Ga.	Strands & Gauge	O.D.	Color	Part No.					
				Ft.	Display Pack	Ft.	Display Pack	100 Ft. Spool	1000 Ft. Spool
22	7 x 30	.062	Black Blue Red White	50'	CW22B CW22E CW22R CW22W			C22EB C22E C22ER C22EW	
20	7 x 28	.070	Black Blue Green Red White Yellow	50'	CW20B CW20E CW20G CW20R CW20W CW20Y	40'	PW20B PW20E PW20G PW20R PW20W PW20Y	C20EB C20E C20EG C20ER C20EW C20EY	C20E-10 C20ER-10
18	19 x 31	.078	Black Blue Brown Green Red White Yellow	50'	CW18B CW18E CW18BR CW18G CW18R CW18W CW18Y	35'	PW18B PW18E PW18BR PW18G PW18R PW18W PW18Y	C18EB C18E C18EBR C18EG C18ER C18EW C18EY	C18EB-10 C18E-10 C18EBR-10 C18EG-10 C18ER-10 C18EW-10 C18EY-10
16	19 x 29	.089	Black Blue Brown Green Orange Pink Purple Red White Yellow	35'	CW16B CW16E CW16BR CW16G CW16T CW16PK CW16P CW16R CW16W CW16Y	30'	PW16B PW16E PW16BR PW16G PW16T PW16PK PW16P PW16R PW16W PW16Y	C16EB C16E C16EBR C16EG C16ET C16EPK C16EP C16ER C16EW C16EY	C16EB-10 C16E-10 C16EBR-10 C16EG-10 C16ET-10 C16EPK-10 C16EP-10 C16ER-10 C16EW-10 C16EY-10



STANDARD PRIMARY WIRE... THE NUMBER ONE CHOICE!

BULK WIRE DISPENSER

Designed to help you sell bulk wire from spools by the foot.
Height – 18", Width – 14", Depth – 12", 3 tiers.

Part No.	Description	Std. Pkg.
SWR1	Primary wire dispenser and header	1

USE ON...

**COUNTER TOP!
END CAP!
SHELF!
PEGBOARD!**



SWR1

THERMOPLASTIC PRIMARY WIRE

SAEJ1128 Requirement – Type TWP Temperature Max 80°C/176°F

Wire Ga.	Strands & Gauge	O.D.	Color	Part No.						
				Ft.	Display Pack	Ft.	Display Pack	100 Ft. Spool	500 Ft. Spool	1000 Ft. Spool
14	19 x 27	.103	Black Blue Brown Black with Red Stripe Green Orange Pink Purple Red White Yellow	25'	CW14B CW14E CW14BR CW14BS CW14G CW14T CW14PK CW14P CW14R CW14W CW14Y	20'	PW14B PW14E PW14BR PW14BS PW14G PW14T PW14PK PW14P PW14R PW14W PW14Y	C14EB C14E C14EBR C14BS C14EG C14ET C14EPK C14EP C14ER C14EW C14EY		C14EB-10 C14E-10 C14EBR-10 C14BS-10 C14EG-10 C14ET-10 C14EPK-10 C14EP-10 C14ER-10 C14EW-10 C14EY-10
12	19 x 25	.142	Black Blue Brown Green Red White Yellow	15'	CW12B CW12E CW12BR CW12G CW12R CW12W CW12Y	12'	PW12B PW12E PW12BR PW12G PW12R PW12W PW12Y	C12EB C12E C12EBR C12EG C12ER C12EW C12EY	C12EB-5 C12E-5 C12EBR-5 C12EG-5 C12ER-5 C12EW-5 C12EY-5	C12EB-10 C12E-10 C12EBR-10 C12EG-10 C12ER-10 C12EW-10 C12EY-10
10	19 x 23	.175	Black Blue Brown Green Red White Yellow	10'	CW10B CW10E CW10BR CW10G CW10R CW10W CW10Y	8'	PW10B PW10E PW10BR PW10G PW10R PW10W PW10Y	C10EB C10E C10EBR C10EG C10ER C10EW C10EY	C10EB-5 C10E-5 C10EBR-5 C10EG-5 C10ER-5 C10EW-5 C10EY-5	C10EB-10 C10E-10 C10EBR-10 C10EG-10 C10ER-10 C10EW-10 C10EY-10
8	19 x 21	.226	Black Blue Red	—	— — —			C8EB C8E C8ER		
6	—	—	Black Red	—	— —			C6E* C6ER*		
4	—	—	Red	—	—			C4ER*		

*SGR cable rated 105°C/221°F

PRIMARY WIRE



SPEAKER WIRE

Wire Gauge	Color	Display Pack	Ft.	Part No.	
				100 Ft. Spool	1000 Ft. Spool
20	Clear	CW20-2	20	CF20-2P	CF20-2P-10
18	Black	CW18-2	20	CF18-2HD†	CF18-2P-10
18	Clear			CF18-2P	
16	Black	CW16-2	15	CF16-2HD†	CF16-2P
16	Clear			CF16-2P	

† Heavy Duty Speaker Wire

FUSIBLE LINK WIRE

Wire Gauge	Sq. mm	Strands	O.D.	Display Color	Part No.		
					Spool	Ft.	Display Pack
20	0.5	19 x 32	.087"	Grey	CW20F	25	
18	0.8	16 x 30	.110"	Black	CW18F	25	ET31
18				Blue			ET30
18				Red			
16	1.0	19 x 29	.150"	Black	CW16F	20	ET34
16				Black			ET35
16				Orange			ET36
14	2.0	19 x 27	.165"	Black	CW14F	15	ET33
14				Grey			ET37
14				Green			ET32
12	3.0	19 x 25	.200"	Blue	CW12F	10	
10	5.0	19 x 23	.213"	Orange	CW10F	8	

Part No.	Desc.	Gauge	Length	Part No.	Desc.	Gauge	Length
ET30	Ford	18	10½"	ET34	Chrysler	16	8"
ET31	Chrysler	18	8"	ET35	GM	16	9¼"
ET32	Ford	14	10½"	ET36	Ford	16	9½"
ET33	GM	14	9½"	ET37	Chrysler	14	8"

NOTE: Fusible link wire is made to be an exact replacement for the fusible links used by OE on battery cable and other circuits for protection from current overloads. Always replace fusible link with same size and gauge used on original circuit. In general, fusible link is four gauges smaller than the circuit wire. (EXAMPLE: Circuit wire = 10 ga.; fusible link = 14 ga.)

ET Display Package

ELECTRICAL CABLE – 125/250 VOLT – U.L. LISTED

• For use in rewiring drop lights, extension cords, portable tools and equipment						
Part No.	Gauge & Cond.	UL Type	Stranding	Jacket	O.D.	
C14-3SRB	14 - 3	SO	41 x 30	Synthetic Rubber/Black	.558	
C16-2SRB	16 - 2	SO	65 x 34	Synthetic Rubber/Black	.380	
C16-3SRB	16 - 3	SO	65 x 34	Synthetic Rubber/Black	.400	
C16-3VB	16 - 3	SJT	36 x 30	Vinyl, Black	.353	
C18-2SRB	18 - 2	SJO	41 x 34	Synthetic Rubber/Black	.298	
C18-3VY	18 - 3	SJT	16 x 30	Vinyl, Yellow	.328	

PRIMARY WIRE



HEAVY DUTY CROSS LINKED POLYETHYLENE PRIMARY WIRE

SAE J-1128 TYPE SXL 125°C/257°F

Cross-linked polyethylene insulation provides outstanding resistance to heat. It withstands severe conditions which can degrade regular plastic primary wire such as oil, gasoline, and abrasion as well as heat. An overloaded wire will not melt and fuse with other wires in a harness. The damaged wire can be slid from the harness and replaced individually. Recommended for all heavy duty applications including trucks, buses, and fleets.

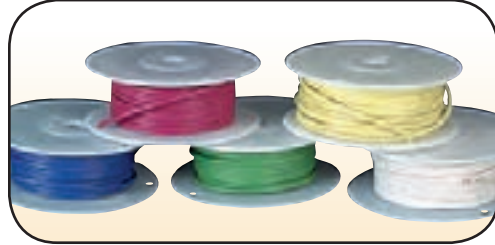

Wire Gauge	Stranding	O.D.	Color	100 Ft. Spool
18	16 x 30	.092	Black	C118EB
			Blue	C118E
			Brown	C118EBR
			Green	C118EG
			Red	C118ER
			White	C118EW
16	19 x 29	.116	Yellow	C118EY
			Black	C116EB
			Blue	C116E
			Brown	C116EBR
			Green	C116EG
			Red	C116ER
14	19 x 27	.138	White	C116EW
			Yellow	C116EY
			Black	C114EB
			Blue	C114E
			Brown	C114EBR
			Green	C114EG
			Red	C114ER
			White	C114EW
			Yellow	C114EY

Wire Gauge	Stranding	O.D.	Color	100 Ft. Spool
12	19 x 25	.160	Black	C112EB
			Blue	C112E
			Brown	C112EBR
			Green	C112EG
			Red	C112ER
			White	C112EW
10	19 x 23	.190	Yellow	C112EY
			Black	C110EB
			Blue	C110E
			Brown	C110EBR
			Green	C110EG
			Red	C110ER
			White	C110EW
			Yellow	C110EY

FLAT MULTI-CONDUCTOR AUTOMOTIVE CABLE

SAE J1128 Type GPT Temperature Rating for individual conductors 60°C/140°F

Parallel Insulated

Part No.	Gauge	Cond.	Colors	Stranding	Qty. Per Pkg.
C16-4E	16	4	Red, Green	19 x 29	100
C16-4V	16	4	White, Black	19 x 29	25
C14-4J	14	4		19 x 27	100
C16-3E	16	3	White, Green	19 x 29	100
C14-3J	14	3	Black	19 x 27	100
C12-3J	12	3		19 x 25	100
C16-2E	16	2		19 x 29	100
C14-2E	14	2	Black, Red	19 x 27	100
C12-2E	12	2		19 x 25	100
C10-2E	10	2		19 x 23	100

Parallel Bonded

C16-4B	16	4		19 x 29	100
ET457	16	4	Brown, Green	19 x 29	25
C14-4E	14	4	Yellow, White	19 x 27	100
C12-4E	12	4		19 x 25	100
C16-3B	16	3		19 x 29	100
C16-3V	16	3	Brown, Green	19 x 29	25
ET458	16	3	Yellow	19 x 29	25
C14-3E	14	3		19 x 27	100

PARALLEL INSULATED

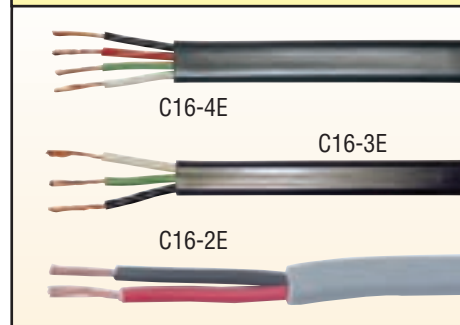

PARALLEL BONDED

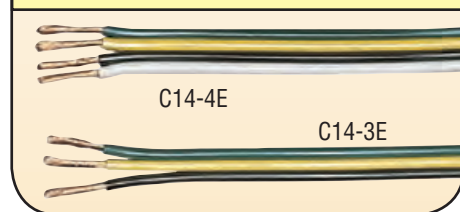

ET Display Package

PRIMARY WIRE

AMPERAGE GUIDE

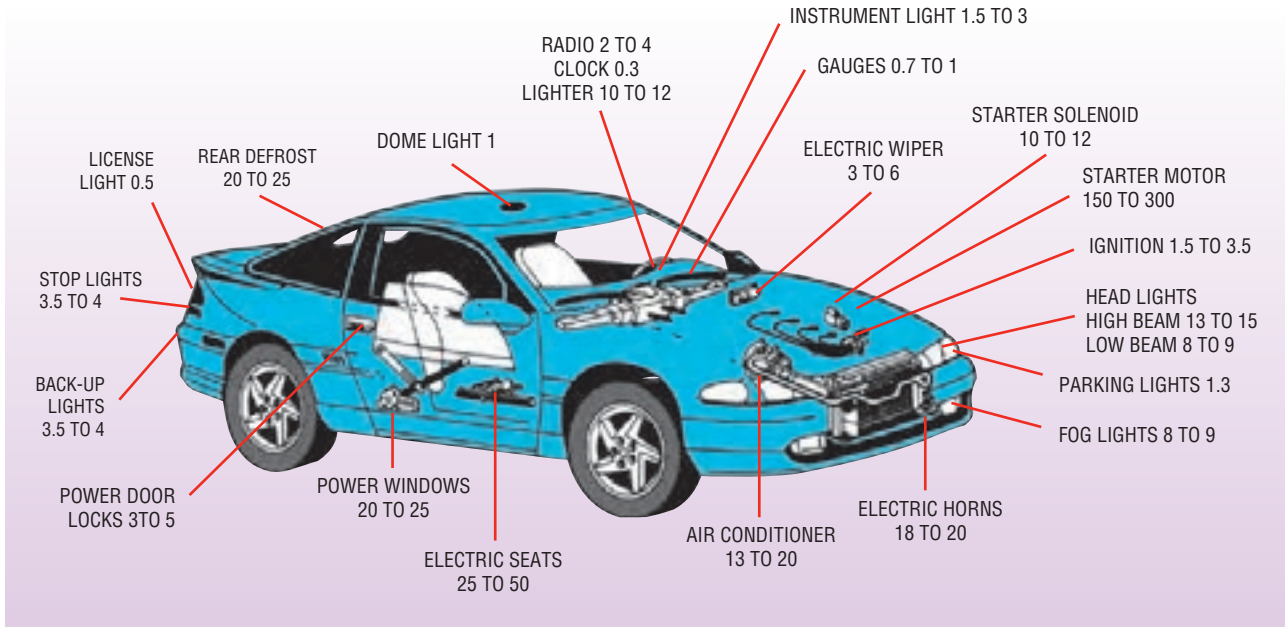

PRIMARY WIRE LENGTH AND SIZE

Selecting the correct gauge of primary wire for specific applications is very important. Refer to the following chart to help resolve questions about 12 volt systems.

12 Volt System	Total Length of Wire Using Ground Return										
	Amps. Approx.	10'	20'	30'	40'	50'	60'	70'	80'	90'	100'
1	20	20	20	20	20	20	20	20	18	18	18
1.5	20	20	20	20	20	20	20	18	18	18	18
2	20	20	20	20	18	18	18	16	16	16	16
3	20	20	20	18	18	18	16	16	16	14	14
4	20	20	18	16	16	16	14	14	14	14	12
5	20	18	18	16	14	14	14	12	12	12	12
6	20	18	16	16	14	14	14	12	12	12	12
7	18	18	16	14	14	12	12	12	10	10	10
8	18	16	16	14	12	12	12	10	10	10	10
10	18	16	14	12	12	12	10	10	10	10	10
11	18	16	14	12	12	10	10	10	10	8	8
12	18	16	14	12	12	10	10	10	8	8	8
15	18	14	12	12	10	10	10	8	8	8	8
18	16	14	12	10	10	8	8	8	8	8	8
20	16	12	12	10	10	8	8	8	8	6	6
22	16	12	10	10	8	8	8	8	6	6	6
24	16	12	10	10	8	8	8	6	6	6	6
30	14	10	10	8	8	6	6	6	4	4	4
36	14	10	8	8	6	6	4	4	4	4	4
50	12	8	8	6	4	4	4	2	2	2	2
100	8	6	4	4	2	2	1	0	0	2/2	2/2
150	6	4	2	2	1	0	0	2/0	2/0	3/0	3/0
200	6	2	2	1	0	0	2/0	3/0	4/0	4/0	4/0

Note that as the conductor length increases, so does resistance. For 6 volt systems, use half of the allowable 12 volt lengths, and for 24 volt systems use twice the allowable 12 volt lengths.

MARINE WIRE & CABLE



HIGHEST QUALITY... DESIGNED SPECIFICALLY FOR MARINE APPLICATIONS



Marine Primary Wire – SAE Specification J378/J1128 Type GPT Temperature rating 105°C.

- Tough thermoplastic insulation is heat, oil and abrasion resistant
- Wide range of gauges and colors in convenient 100 ft. spools
- Tinned copper conductor

Protect your boat using products specified by wire industry experts. Use only highest quality products designed specifically for Marine applications. All Standard Wire and Cable Marine products meet Marine industry standards. The requirements as set by the following:

ABYC (American Boat and Yacht Council)
NMMA (National Marine Manufacturers Association)
SAE J378/J1128

600 Volts requirement.
Temperature Rating 105°C/221°F

100' spool Part No.	Wire Gauge	Stranding	O.D.	Color			
C218E	18	16 x 30	.105	Blue			
C218EB				Black			
C218EBR				Brown			
C218EG				Green			
C218ER				Red			
C218EY				Yellow			
C216E	16	26 x 30	.125	Blue			
C216EB				Black			
C216EBR				Brown			
C216EG				Green			
C216EGY				Gray			
C216EP				Purple			
C216EPK				Pink			
C216ER				Red			
C216ES				Tan			
C216ET				Orange			
C216EW				White			
C216EY				Yellow			
C214E				14	41 x 30	.140	Blue
C214EB							Black
C214EBR	Brown						
C214EG	Green						
C214EGY	Gray						
C214EP	Purple						
C214EPK	Pink						
C214ER	Red						
C214ES	Tan						
C214ET	Orange						
C214EW	White						
C214EY	Yellow						

100' spool Part No.	Wire Gauge	Stranding	O.D.	Color			
C212E	12	65 x 30	.158	Blue			
C212EB				Black			
C212EBR				Brown			
C212EG				Green			
C212EGY				Gray			
C212EP				Purple			
C212EPK				Pink			
C212ER				Red			
C212ES				Tan			
C212ET				Orange			
C212EW				White			
C212EY				Yellow			
C210E				10	105 x 30	.182	Blue
C210EB							Black
C210EBR	Brown						
C210EG	Green						
C210EP	Purple						
C210ER	Red						
C210ET	Orange						
C210EW	White						
C210EY	Yellow						
C208EB	8	168 x 30	.272				Black
C208EG				Green			
C208ER				Red			
C208EW				White			

PRIMARY WIRE

MARINE WIRE & CABLE

HIGHEST QUALITY... DESIGNED SPECIFICALLY FOR MARINE APPLICATIONS



MARINE MULTI CONDUCTOR CABLE — SAE SPECIFICATION J1128, TYPE GPT TEMPERATURE RATING 105°C

Flexible Tinned Copper Conductors have a tough PVC Jacket, are run parallel and covered with a Thermoplastic Insulation.

Part No.	AWG	Conductor's Colors	Stranding	Qty. Per Pkg.
C216-3E	16	3 (Black, Green, White)	19 x 29	100 Ft. spool
C214-3E	14		19 x 27	100 Ft. spool
C212-3E	12		19 x 25	100 Ft. spool
C210-3E	10		19 x 23	100 Ft. coil
C208-3E	8		19 x 21	100 Ft. coil
C206-3E	6		37 x 21	100 Ft. coil
C216-2E	16	2 (Red, Yellow)	19 x 29	100 Ft. spool
C214-2E	14		19 x 27	100 Ft. spool
C212-2E	12		19 x 25	100 Ft. spool
C210-2E	10		19 x 23	100 Ft. coil
C208-2E	8		19 x 21	100 Ft. coil
C206-2E	6		37 x 21	100 Ft. coil

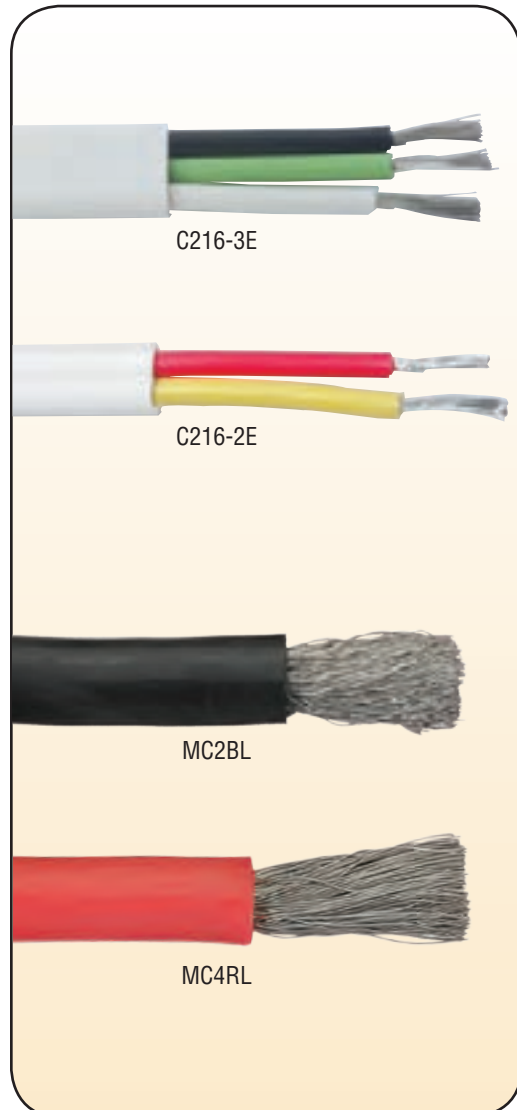

MARINE BATTERY CABLE — SAE SPECIFICATION J1127, TYPE SGT TEMPERATURE RATING 105°C

- Wide variety of gauges available from 6 to 4/0
- Tinned Copper Conductor
- Tough Thermoplastic Insulation is available in black or red

Part No.	Color	Cable Gauge	Stranding	O.D.	Qty. Per Pkg.
MC6BL	Black	6	266/30	0.340"	50 Ft.
MC6RL	Red	6	266/30	0.340"	50 Ft.
MC4BL	Black	4	420/30	0.395"	50 Ft.
MC4RL	Red	4	420/30	0.395"	50 Ft.
MC2BL	Black	2	665/30	0.465"	50 Ft.
MC2RL	Red	2	665/30	0.465"	50 Ft.
MC1BL	Black	1	833/30	0.521"	50 Ft.
MC1RL	Red	1	833/30	0.521"	50 Ft.
MC0BL	Black	1/0	1064/30	0.561"	50 Ft.
MC0RL	Red	1/0	1064/30	0.561"	50 Ft.
MC00BL	Black	2/0	1330/30	0.616"	50 Ft.
MC00RL	Red	2/0	1330/30	0.616"	50 Ft.
MC000BL	Black	3/0	1672/30	0.666"	50 Ft.
MC000RL	Red	3/0	1672/30	0.666"	50 Ft.
MC0000BL	Black	4/0	2107/30	0.726"	50 Ft.
MC0000RL	Red	4/0	2107/30	0.726"	50 Ft.

For Automotive Battery Cable go to page numbers B22-B23, Section B "Battery Cable"

AUTOMOTIVE PRIMARY WIRE



PROTECT & ORGANIZE AUTOMOTIVE & MARINE WIRING WITH WIRE LOOM

SPIRAL WRAP

Protects cables while permitting wires to lead out from anywhere along the length. Natural white polyethylene. Temperature range: -50°F to +160°F

Part No.	Color	Std. Pkg.	Display Pack	Qty. Per Pkg.	O.D.
CL8	Natural	50'	ET8	5'	1/4"
CL7	Natural	50'	ET7	5'	1/2"
—	Yellow	—	ET7Y	5'	1/2"
—	Blue	—	ET7E	5'	1/2"
—	Black	—	ET7B	5'	1/2"
—	Red	—	ET7R	5'	1/2"
CL9	Natural	50'	ET9	5'	3/4"

CLEAR VINYL

Recommended for truck and trailer applications exposed to weather. Protects against acid, salt and oil. Temperature range: -4°F to 220°F

Part No.	I.D.	Std. Pkg.
CL30	1/4"	50 Ft. Coil
CL32	3/8"	50 Ft. Coil
CL33	1/2"	50 Ft. Coil

BLACK NEOPRENE LOOM

Part No.	I.D.	Std. Pkg.
CL5N	5/16"	50 Ft. Coil

PVC SPLIT LOOM

Protect your wiring. Split seam allows easy insertion and removal without disconnecting wire or cable. Temperature range: -15°F to +195°F

Part No.	Color	Std. Pkg.	Bulk Pkg.	Std. Pkg.	Display Pack	Qty. Per Pkg.	I.D.
CL4S	Black	50'	CLB4	250'	ET3	12'	1/4"
CL5S	Black	50'	CLB5	250'	ET5	12'	3/8"
CL6S	Black	50'	—	—	ET6	12'	7/16"
CL16	Black	50'	CLB16	250'	—	—	1/2"
CL10S	Black	50'	—	—	—	—	5/8"
CL11S	Black	50'	CLB11	250'	ET4	6'	3/4"
CL12S	Black	50'	CLB12	150'	—	—	1"
CL13S	Black	50'	CLB13	150'	—	—	1 1/2"
CL5SE	Blue	50'	—	—	ET5E	12'	3/8"
CL5SY	Yellow	50'	—	—	ET5Y	12'	3/8"
CL5SR	Red	50'	—	—	ET5R	12'	3/8"
CL5SW	White	50'	—	—	ET5W	12'	3/8"

HIGH TEMPERATURE NYLON SPLIT LOOM

Protection for wire routed near exhaust manifolds or other hot engine parts. Combines abrasion and superior thermal protection. Marked with white stripe. Temperature rating: -20°F to 300°F

Part No.	I.D.	Std. Pkg.	Part No.	I.D.	Std. Pkg.
CL38	1/4"	50 Ft. Coil	CL44	5/8"	50 Ft. Coil
CL39	3/8"	50 Ft. Coil	CL41	3/4"	50 Ft. Coil
CL14S	7/16"	50 Ft. Coil	CL42	1"	50 Ft. Coil
CL40	1/2"	50 Ft. Coil	CL43	1 1/2"	50 Ft. Coil

HIGH TEMPERATURE REFLECTIVE LOOM

High Temperature Reflective Loom protects up to 450°F/232°C. Protects cables, harnesses, hoses, etc.

Part No.	I.D.	Length	Std. Pkg.
CL17S	3/4"	15"	1

ASPHALT-COATED FABRIC LOOM

Seamless, moisture-proof loom for heavy duty service. For temperatures up to 250°F. Meets or exceeds SAE J562A specifications.

Part No.	I.D. (min.)	Std. Pkg.	Bulk Pkg.	Std. Pkg.
CL19	3/16"	50'	—	—
CL20	1/4"	50'	CLB20	250'
CL21	5/16"	50'	—	—
CL22	3/8"	50'	CLB22	250'
CL23	7/16"	50'	—	—
CL24	1/2"	50'	CLB24	250'
CL26	5/8"	50'	—	—
CL28	3/4"	50'	—	—
CL29	1"	50'	—	—

ET Display Package

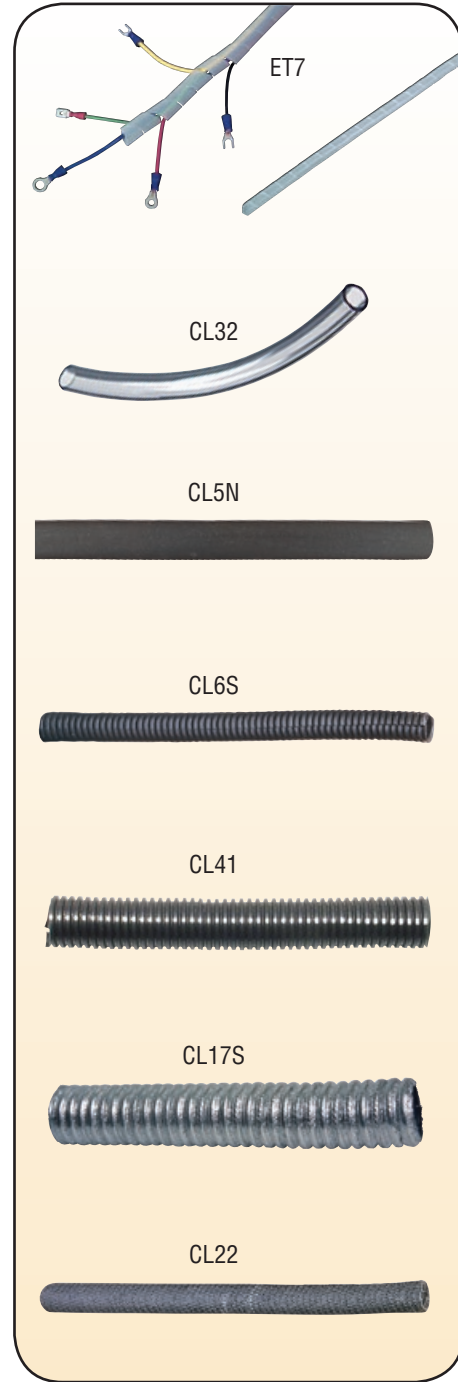

LOOM INSTALLATION TOOL



CL15

CL15 - Make installing wire loom quick and easy with this handy loom installation tool. Just slip over wire and start loom, tool spreads loom while it feeds over wire. Use with 3/8" to 5/8" ID split loom. **Standard Package 1.**

WIRING ACCESSORIES

LOOM TEE CONNECTORS

Connects branch runs to main loom wiring.					
Part No.	Loom	Left I.D.	Center I.D.	Right I.D.	Std. Pkg.
CL34	Use with CL6S & CL16	1/2"	1/2"	1/2"	1
CL35	Use with CL5S	13/32"	23/64"	23/64"	1
CL36	Use with CL5S CL6S, CL11S	3/4"	23/64"	3/4"	1
CL37*	Loom outlet Use with CL5S & CL6S	13/32"	—	13/32"	1

* Loom outlet — Holds loom tight at breakouts

ELECTRICAL TAPE

Part No.	Description	Qty. Per Pkg.
ET261	Electrical Tape 33 - foot roll	1 roll

WIRING CLIPS

Part No.	Qty.	Description	Display Pack	Qty. Per Pkg.
ST60	50	Push-on metal wiring clip for flat surfaces	ET290	4
ST61	50	Bolt on wiring clip 5/16" mounting hole		
ST62	50	Adhesive-backed wiring clip 1 1/4" L. x 3/16" I.D.	ET62	4
ST63	50	1 1/2" L. x 1/4" I.D.		
ST64	50	2" L. x 3/8" I.D.		
ST65†	50	2 1/4" L. x 1/2" I.D.		
ST291	50	1/4" I.D.	ET291	6
ST292	50	3/8" I.D.	ET292	4
ST294	50	1/2" I.D.	ET294	4
ST295	50	3/4" I.D.	ET295	3
ST293	50	1 1/2" sq. nylon base	ET293	4
ST69	25	Molded nylon harness bracket 1/4" I.D.		
ST66	25	1/2" I.D.		
ST67	25	3/4" I.D.		
		Asst. of 4 ea. ST66, ST67, ST69	ET270	12
ST70	25	Rubber cushioned steel clamp 1/4" I.D.	ET273	7
ST73	25	3/8" I.D.	ET296	6
ST71	25	1/2" I.D.	ET274	6
ST74	25	3/8" I.D.	ET297	5
ST72	25	3/4" I.D.	ET275	5
ST75	25	1" I.D.	ET298	4
		Asst. of 2 ea. ST70, ST71, ST72	ET272	6
ST296	10	Push-mount wiring clip 1/4" I.D.		
ST297	10	1/2" I.D.		

COATED METAL CLAMPS

Part No.	I.D.	Hole Diameter	Width	Std. Pkg.
ST80	1/4"	1/4"	3/4"	25
ST81	3/8"	13/32"	3/4"	25
ST85	1/2"	13/32"	3/4"	25
ST82	5/8"	13/32"	3/4"	25
ST83	3/4"	13/32"	3/4"	25
ST84	1"	13/32"	3/4"	25

VACUUM CAPS

Part No.	Description	Qty. Per Pkg.
ET505	Rubber Vacuum Caps, Display Pkg., 8-pcs. with holder	8 per clam
ET506	Vinyl Vacuum Caps, Display Pkg., 35-pcs.	35 per clam

ET Display Package † Available while supplies last



CL34

CL37



3-way
wire loom
hook up



ET261

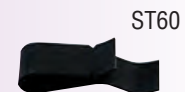

ST60



ST61

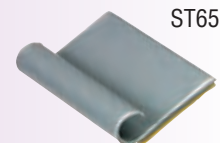

ST65



ST292



ST293



ST66



ST72



ST296



ST80



ET505



ET506

WIRING ACCESSORIES



PROTECT YOUR WIRING... KEEP YOUR WIRES NEATLY BUNDLED AND ORGANIZED

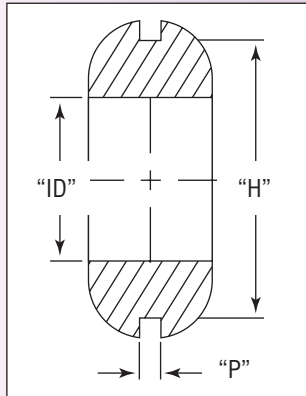

ET40



STA50



ET11

Tie Strap Gun. Included in **STA50** Tie Strap Kit.

VINYL WIRE GROMMETS

Flexible, oil resistant, high dielectric grommets resist harsh engine compartment conditions.

Part No.	ID	Hole	Panel	Std. Pkg.
ET44	1/8"	1/4"	1/16"	33
ET40	1/4"	3/8"	1/16"	20
ET45	3/8"	1/2"	1/16"	26
ET46	5/8"	7/8"	1/16"	12
ET41+	1/4", 3/16", 1/8"	3/8", 5/16", 1/4"	1/16"	21
ET42+	3/8", 5/8", 3/4"	5/8", 7/8", 1"	1/8", 1/16"	8
ET43+	5/8", 3/8", 1/2"	1", 3/4", 5/8", 7/16"	1/8", 1/16"	15
	1/4", 3/16", 1/8"	3/8", 5/16", 1/4"		
GR1	1/8"	1/4"	1/16"	25
GR2	1/4"	3/8"	1/16"	25
GR3	3/8"	1/2"	1/16"	25
GR4	1/2"	13/16"	1/16"	25
GR5	5/8"	7/8"	1/16"	25
GR6	3/4"	1 1/16"	1/16"	25
GR7	7/8"	1 1/4"	1/16"	25
GR8	1"	1 3/8"	1/8"	25

ET Display Package
+ Assorted Sizes

WIRE TIE STRAP KIT & ACCESSORIES

Wire tie kit has everything needed to keep wiring neatly bundled and out of the way. The tensioning tool comes as part of the assortment or separate part number.

Part No.	Description	Qty. Per Pkg.
STA50	Tensioning Tool Kit	1 kit
ET11	Tie Strap Gun	1

STA50 Contents:

- 1 Tensioning Tool
- 50 - 6" white universal tie straps - Re-Order STT273
- 50 - 8" black universal tie straps - Re-Order STT275
- 5 - mounting clips - Re-Order ET293, ST293
- Instruction sheet

TENSIONING INSTRUCTIONS



1. Loop cable tie around bundle. Thread tail through head of cable tie and hand tighten.

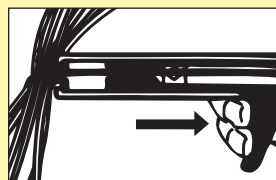

2. Position cable tie in tool and pull trigger to tighten keeping tension on trigger.

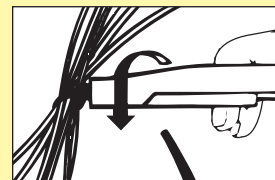

3. A quick twist of the gun in a counter-clockwise direction cuts the excess tail, leaving no sharp edge.

ET Display Package

WIRING TIE STRAPS

Protect Your Wiring... Keep Your Wires Neatly Bundled And Organized

NYLON WIRE TIE STRAPS

	Part No.	Length	Tensil Strength	Width	Bundle Dia.	Qty.
Standard - Non Releasable - Natural	ET280L	Asst.; 5 ea. STT253, STT256, STT271 and 2 ea. ST293				
	STT256	4"	18lbs.	.10"	.75"	100
	STT256M					1000
	ET256					15
	STT273	6"	30lbs.	.14"	1.25"	25
	STT273C					100
	STT273M					1000
	STT271	8"	50lbs.	.18"	1.75"	25
	STT271C					100
	STT271M					1000
	ET271L	8.5"	40lbs.	.15"	2.00"	20
	STT252	11.75"	50lbs.	.18"	3.00"	25
	STT252C					100
	STT252M					1000
	ET252L	11.5"	40lbs.	.15"	3.00"	15
	STT253	15.5"	50lbs.	.18"	4.00"	10
	STT253C					100
	STT253M					1000
ET253L	14.5"	40lbs.	.15"	4.00"	12	
STT272	15.25"	120lbs.	.30"	4.00"	10	
STT272C					100	
STT272D					500	
Standard - Non Releasable - Black UV Resistant	STT281C	4"	18lbs.	.10"	.75"	100
	STT281M					1000
	STT282	6"	30lbs.	.14"	1.25"	25
	STT282C					100
	STT275	8"	50lbs.	.18"	1.75"	25
	STT275C					100
	STT275M					1000
	ET279L					20
	STT276	11.75"	50lbs.	.18"	3.00"	25
	STT276C					100
	STT276M					1000
	ET276L					15
STT277	15.5"	50lbs.	.18"	4.00"	10	
STT277C					100	
STT277M					1000	
STT278	15.25"	120lbs.	.30"	4.00"	10	
STT278C					100	
STT278D					500	
Mounting - Non Releasable Natural	STT259	6.5" Stud Size #8	30lbs.	.14"	1.38"	25
	STT250	8.5"	50lbs.	.18"	1.75"	25
	STT250C					100
	STT250M					1000
	ET250	Stud Size #10				8
	ET250L					20
Mounting - Non Releasable Natural	STT251	16" Stud Size #10	50lbs.	.18"	4.00"	25
	STT251C					100
	STT251D					500
	ET251L					8
STT274	16.25" Stud Size .25"	120lbs.	.30"	4.00"	25	
STT274C					100	
Releasable - Black U.V. Resistant	STT254	5.5"	50lbs.	.34"	1.375"	25
	ET254					6
	ET254L					20
	STT255	10"	50lbs.	.34"	2.75"	10
	ET255L					10

ET Display Package

Specialty Tie Straps					
Part No.	Length	Tensil Strength	Width	Bundle Dia.	Qty.
STT270	12"	50lbs.	.18"	1.5"	25
		40lbs.		1.5" Each Loop	
STT279	15.25" Stud Size .25"	120lbs.	.18"	4"	50

Standard - Non Releasable	
	STT252
Standard - Non Releasable U.V. Resistant	
	STT275
Mounting - Non Releasable	
	STT250
Standard - Releasable - U.V. Resistant	
	STT254
Non Releasable - Neutral	
	STT259
Double Headed - Non Releasable	
	STT270
Heavy Duty Stud Mount - Non Releasable	
	STT279

For Multi-Colored Tie Straps go to page number C13

SPECIALTY ACCESSORIES



PROTECT YOUR WIRING... KEEP YOUR WIRES NEATLY BUNDLED AND ORGANIZED

MULTI-COLORED NYLON WIRE TIE STRAPS

	Standard - Non Releasable						
	Part No.	Color	Length	Tensil Strength	Width	Bundle Dia.	Qty.
Standard - Non Releasable	STT256E	Blue	4"	18lbs.	.10"	.75"	100
	ET256E						15
	STT256R	Red	4"	18lbs.	.10"	.75"	100
	ET256R						15
	STT256W	White	4"	18lbs.	.10"	.75"	100
	ET256W						15
	STT256Y	Yellow	4"	18lbs.	.10"	.75"	100
	ET256Y						15
	STT271E	Blue	8"	50lbs.	.18"	1.75"	25
	ET271EL						20
	STT271R	Red	8"	50lbs.	.18"	1.75"	25
	ET271RL						20
	STT271W	White	8"	50lbs.	.18"	1.75"	25
	ET271WL						20
	STT271Y	Yellow	8"	50lbs.	.18"	1.75"	25
	ET271YL						20

ET Display Pack



MULTI-COLORED SPIRAL WRAP

Part No.	Color	Std. Pkg.	O.D.
ET7E	Blue	5'	1/2"
ET7R	Red	5'	1/2"
ET7Y	Yellow	5'	1/2"

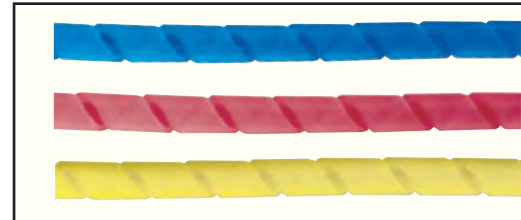

MULTI-COLORED PVC SPLIT LOOM

Part No.	Color	Std. Pkg.	Display Pack	Qty. Per Pkg.	I.D.
CL5SE	Blue	50'	ET5E	12'	3/8"
CL5SR	Red	50'	ET5R	12'	3/8"
CL5SW	White	50'	ET5W	12'	3/8"
CL5SY	Yellow	50'	ET5Y	12'	3/8"

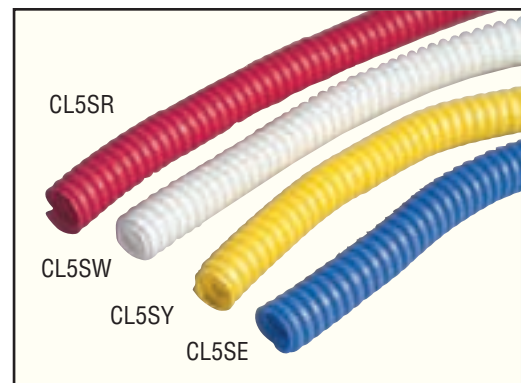

PRIMARY WIRE

STANDARD[®]

Primary Wire, Terminals & Accessories

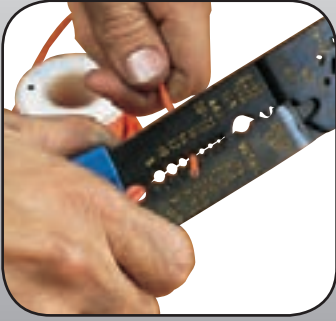

Proper Tools To Do
The Job Right

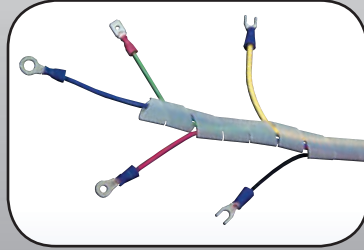

Spiral Wrap & Loom To Neatly
Bundle Any Wiring Job

A Comprehensive Source For All Your Wiring Needs



Time Saving Accessories
To Get The Job Done Fast



Wide Range Of Parts To Fit
Almost Every Need



Store Your Wiring Products Neatly Into Wire Cabinet AB99W. Organizes Your Wire And Cable Parts So They Are Always At Your Finger Tips.



Ignition Wires

Battery Cables

Primary Wire

Terminals & Connectors

Trailer Connectors

Sockets, Pigtails & Switches

Safety Accessories

O.E. Interchanges

Index

INSULATED SOLDERLESS TERMINALS

- The terminals and connectors product group include both PVC and nylon insulated terminals to satisfy the varying needs of automotive wiring experts.
- Nylon insulated terminals offer both high performance design and rugged construction.

Unlike the PVC equivalent, the nylon terminals have an extended tin plated brass support sleeve that:

- (1) Strengthens the barrel and secures the wire to protect against stress and high vibration.
- (2) Nylon insulating sleeve withstands continuous operating temperatures of -10°C to +105°C.
- (3) Both PVC and nylon terminals have funnel entry to prevent wire strand “hang up” for more secure, reliable crimps. In most instances nylon insulated terminals are visually identified as having lighter colored insulation than the equivalent PVC.

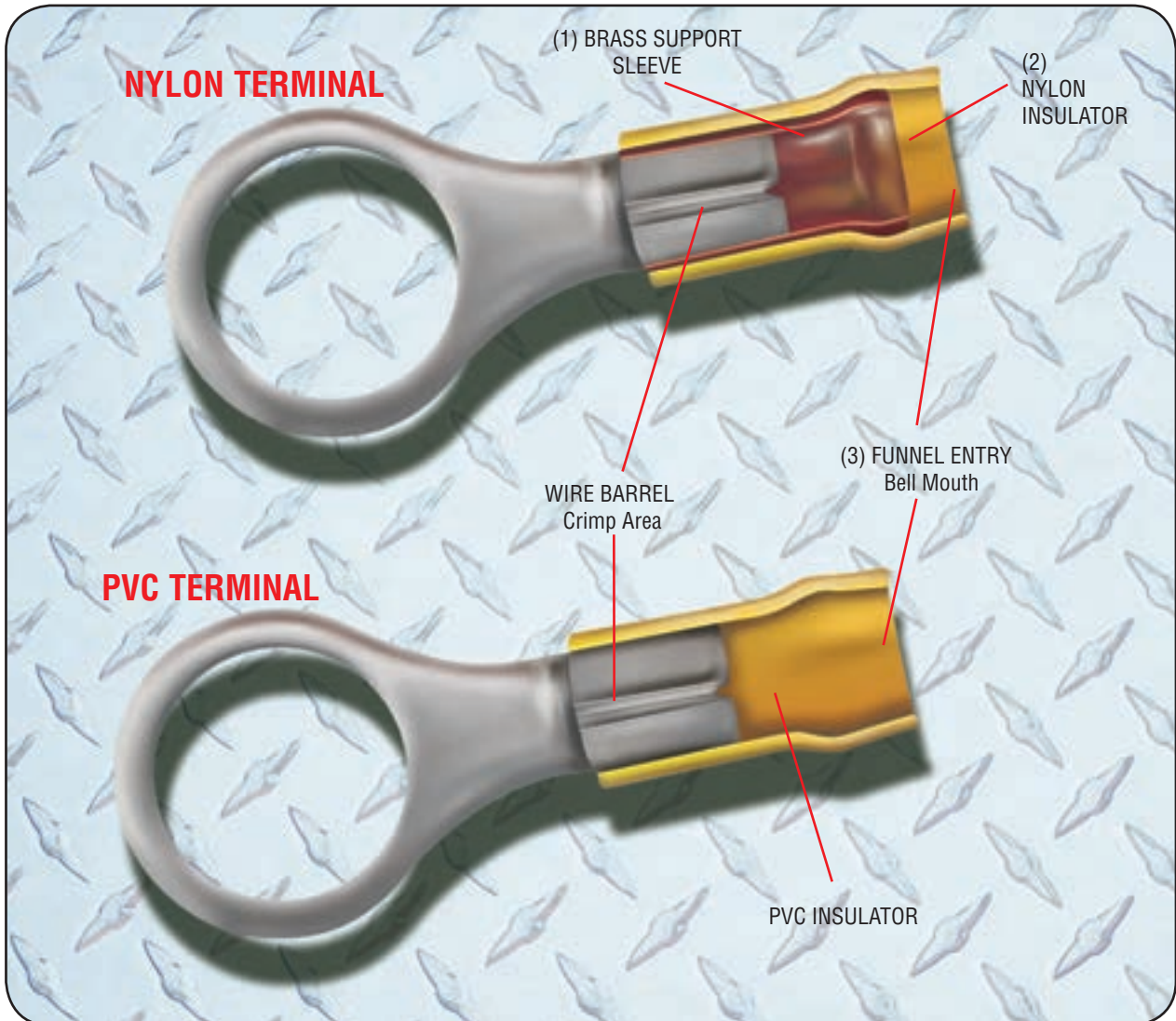







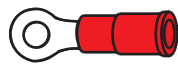

INSULATED RING TERMINALS



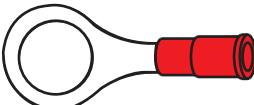

TERMINALS & CONNECTORS

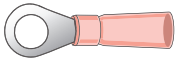
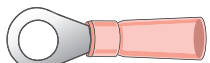
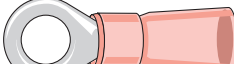
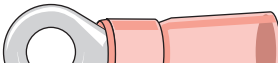
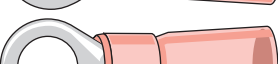

22-18 GAUGE

PVC	Part No.	Stud Size	Qty Per Pkg.
	STP151 ET151	#6	100 7
	STP497 ET497	#8	100 7
	STP120 ET120XL ET120L ET120	#10	100 80 20 7
	STP121 ET121	1/4"	100 7
	STP606	5/16"	100
	STP122 ET122	3/8"	100 6
Star PVC	Part No.	Stud Size	Qty Per Pkg.
	STP93 ET93L ET93	#6	50 12 3
	STP92 ET92L ET92	#8	50 12 3
	STP91 ET91L ET91	#10	50 12 3





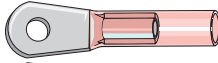
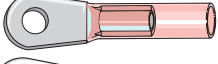
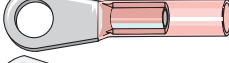
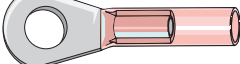
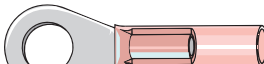

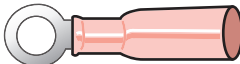

20-18 GAUGE

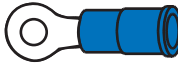
Crimp Type With Heat Shrink	Part No.	Stud Size	Qty Per Pkg.
	STP151H ET151H	#6	10 3
	STP497H ET497H	#8	10 3
	STP120HL STP120H ET120H	#10	50 10 3
	STP121H ET121H	1/4"	10 3
	STP606H	5/16"	10
	STP122H ET122H	3/8"	10 3

20-18 GAUGE

Self Solder Heat Shrink	Part No.	Stud Size	Qty Per Pkg.
	STP354	#6	25
	STP355 ET355	#8	25 3
	STP356 ET356	#10	25 3
	STP357 ET357	1/4"	25 3
	STP475 ET475	5/16"	25 3
	STP476 ET476	3/8"	25 3
Crimp, Solder & Heat Shrink	Part No.	Stud Size	Qty Per Pkg.
	STP556 ET556	#10	5 3





16-14 GAUGE

PVC	Part No.	Stud Size	Qty Per Pkg.
	STP498D STP498 ET498	#6	500 100 6
	STP123 ET123L ET123	#8	100 20 6
	STP124D STP124 ET124XL ET124L ET124	#10	500 100 85 20 6
	STP125D STP125 ET125XL ET125L ET125	1/4"	500 100 75 15 5
	STP157C STP157 ET157	5/16"	100 25 4
	STP126 STP302 ET126L ET126	3/8"	100 25 15 5
Star PVC	Part No.	Stud Size	Qty Per Pkg.
	STP96 ET96L ET96	#6	50 12 3
	STP95 ET95L ET95	#8	50 12 3
	STP94 ET94L ET94	#10	50 12 3

Images shown actual size unless indicated otherwise.
ET Display Package



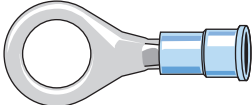
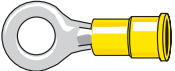
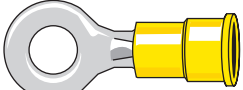
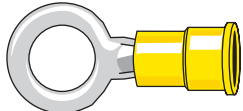
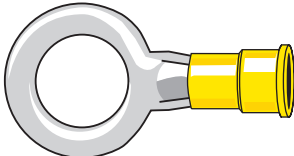
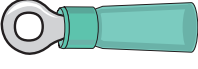
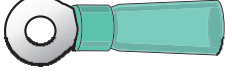
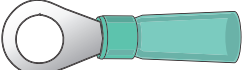

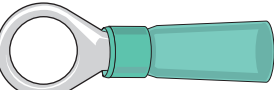
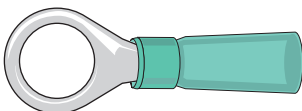
INSULATED RING TERMINALS

16-14 GAUGE

Nylon Extended Barrel	Part No.	Stud Size	Qty Per Pkg.
	STP438	#10	50
	STP439	1/4"	50
	STP440	3/8"	50
Heavy Duty Nylon Extended Barrel *STP602 also suitable for 12 Ga.	Part No.	Stud Size	Qty Per Pkg.
	STP602	#10	50
	STP494 ET494L	1/4"	50 8
	STP495 ET495L	3/8"	50 8
	STP496	1/2"	50
Crimp Type With Heat Shrink	Part No.	Stud Size	Qty Per Pkg.
	STP498H	#6	10
	STP123H	#8	10
	STP124HL STP124H ET124H	#10	50 10 3
	STP125H ET125H	1/4"	10 3
	STP157H ET157H	5/16"	10 3
	STP126H ET126H	3/8"	10 3

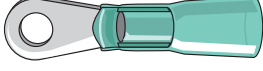
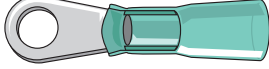
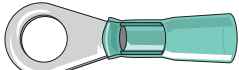
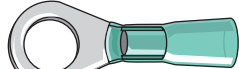
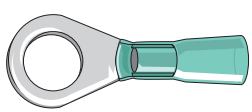
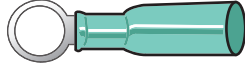
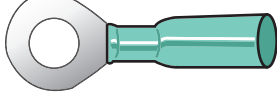
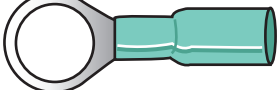
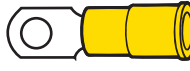
Images shown actual size unless indicated otherwise.

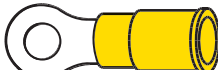
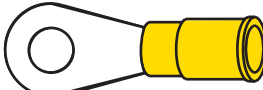
16-14 GAUGE

Self Solder Heat Shrink	Part No.	Stud Size	Qty Per Pkg.
	STP477	#6	25
	STP358	#8	25
	STP359C STP359 ET359	#10	100 25 3
	STP360 ET360	1/4"	25 3
	STP478 ET478	5/16"	25 3
	STP361 ET361	3/8"	25 3
Crimp, Solder, Heat Shrink	Part No.	Stud Size	Qty Per Pkg.
	STP559 ET559	#10	5 3
	STP560 ET560	1/4"	5 3
	STP561 ET561	3/8"	5 3
12-10 GAUGE			
PVC	Part No.	Stud Size	Qty Per Pkg.
	STP493 ET493	#6	50 4
	STP524D STP524 ET524	#8	500 50 4
	STP127 ET127XL ET127L ET127	#10	50 60 14 4
	STP128D STP128 ET128XL ET128L ET128	1/4"	500 50 60 14 3
	STP168 ET168L	5/16"	50 9

ET Display Package

INSULATED RING TERMINALS



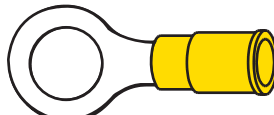
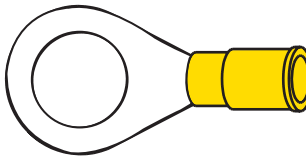
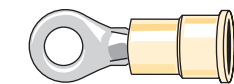
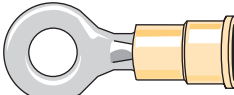
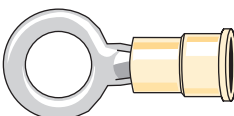
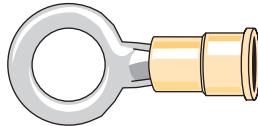
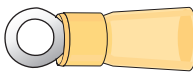
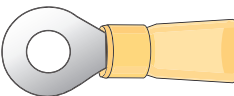
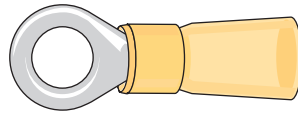
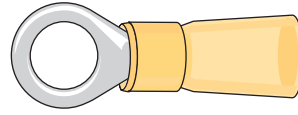
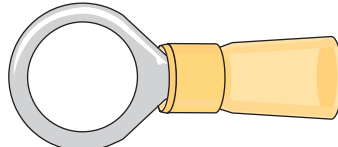

12-10 GAUGE

PVC	Part No.	Stud Size	Qty Per Pkg.
	STP129	3/8"	50
	ET129XL		60
	ET129L		14
ET129	3		
	STP159	1/2"	25
	ET159L		10
Nylon Extended Barrel	Part No.	Stud Size	Qty Per Pkg.
   	STP441	#10	50
	STP442	1/4"	50
	STP443	5/16"	50
	STP444	3/8"	50
Crimp Type With Heat Shrink	Part No.	Stud Size	Qty Per Pkg.
    	STP127H	#10	10
	ET127H		3
	STP128H	1/4"	10
	STP168H	5/16"	10
	STP129H	3/8"	10
STP159H	1/2"	10	

Images shown actual size unless indicated otherwise.
ET Display Package

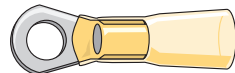
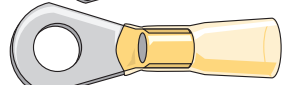
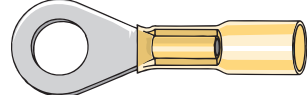
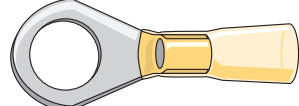
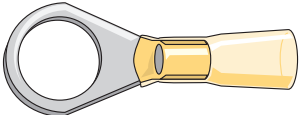
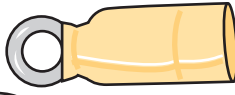
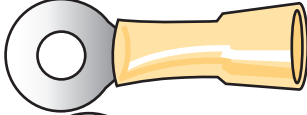
12-10 GAUGE

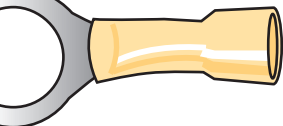
Self Solder Heat Shrink	Part No.	Stud Size	Qty Per Pkg.
    	STP362	#10	25
	STP363	1/4"	25
	ET363		3
	STP479	5/16"	25
	ET479		3
STP364	3/8"	25	
ET364		3	
STP365	1/2"	25	
ET365		3	
Crimp, Solder, Heat Shrink	Part No.	Stud Size	Qty Per Pkg.
   	STP562	#10	5
	ET562		3
	STP563	1/4"	5
	STP564	3/8"	5
	ET564		3
STP565	1/2"	5	

8 GAUGE

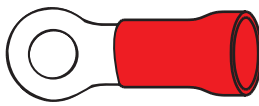
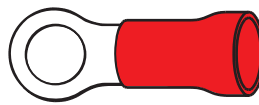
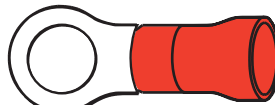
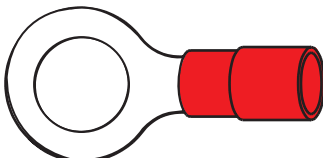
PVC	Part No.	Stud Size	Qty Per Pkg.
   	STP188	1/4"	25
	STP192	5/16"	25
	STP177		3/8"
	STP175	1/2"	25

TERMINALS & CONNECTORS

INSULATED RING TERMINALS / TERMINALS & CONNECTORS

8 GAUGE

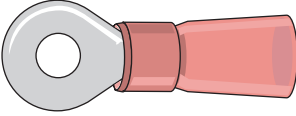
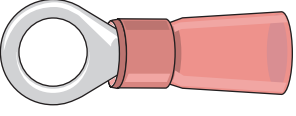
Crimp Type With Heat Shrink	Part No.	Stud Size	Qty Per Pkg.
	STP188H	1/4"	10
	STP177H	3/8"	10

6 GAUGE

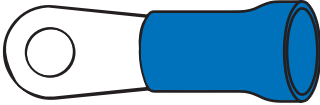
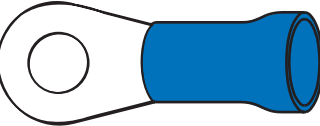
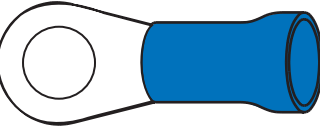
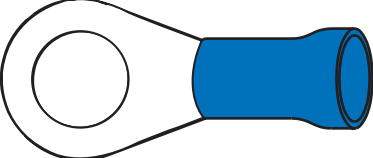

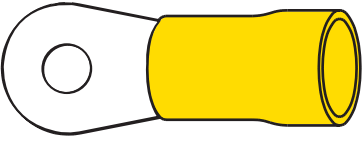
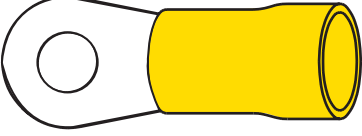
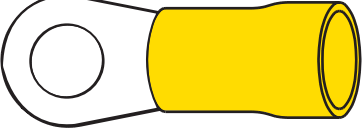
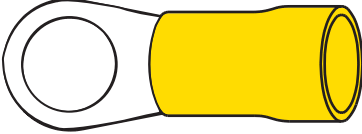

PVC	Part No.	Stud Size	Qty Per Pkg.
	STP187	1/4"	25
	STP194	5/16"	25
	STP301	3/8"	25
	STP174	1/2"	25

4 GAUGE

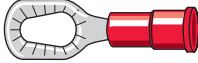

PVC	Part No.	Stud Size	Qty Per Pkg.
	STP193	1/4"	10
	STP191	5/16"	10
	STP190	3/8"	10
	STP189	1/2"	10

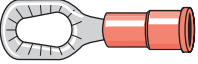

Images shown actual size unless indicated otherwise.

MULTI-STUD RING TERMINALS



PVC (Stud Size #6-8-10)	Part No.	Gauge	Qty Per Pkg.
	STP388 ET388L	22-18	25 9
	STP389 ET389L	16-14	25 9
	STP390 ET390L	12-10	25 8
Nylon Extended Barrel (Stud Size #6-8-10)	Part No.	Gauge	Qty Per Pkg.
	STP391	22-18	25
	STP392	16-14	25
	STP393	12-10	25

HOOK TERMINALS

PVC (Stud Size #6)	Part No.	Gauge	Qty Per Pkg.
	STP445	22-18	50
	STP300	16-14	100

PVC (Stud Size #10)	Part No.	Gauge	Qty Per Pkg.
	STP165 ET165	22-18	100 4
	STP155C STP155 ET155	16-14	100 50 3
	STP154 ET154	12-10	25 3

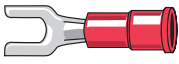
SPADE TERMINALS

PVC (22-18 Gauge)	Part No.	Stud Size	Qty Per Pkg.
	STP136 ET136XL ET136	#6	100 75 7
	STP486 ET486	#8	100 7
	STP150 ET150	#10	100 7

ET Display Package

TERMINALS & CONNECTORS



SPADE TERMINALS

Crimp Type With Heat Shrink Tubing (20-18 Gauge)	Part No.	Stud Size	Qty Per Pkg.
	STP136H	#6	10
	STP499H	#8	10
	STP150H	#10	10
Self Solder Heat Shrink (22-18 Gauge)	Part No.	Stud Size	Qty Per Pkg.
	STP366	#10	25
Crimp Solder Heat Shrink (22-18 Gauge)	Part No.	Stud Size	Qty Per Pkg.
	STP578	#10	5
PVC (16-14 Gauge)	Part No.	Stud Size	Qty Per Pkg.
	STP133D	#6	500
	STP133		100
	ET133		6
	STP134	#8	100
	ET134XL ET134		85 6
	STP135D	#10	500
	STP135		100
	ET135XL ET135		65 6
Crimp Type With Heat Shrink Tubing (16-14 Gauge)	Part No.	Stud Size	Qty Per Pkg.
	STP133H	#6	10
	STP134H	#8	10
	STP135H ET135H	#10	10 3
Heavy Duty Nylon (16-14 Gauge)	Part No.	Stud Size	Qty Per Pkg.
	STP446* ET446L*	#6	50 7
		STP394* ET394L*	#8
		STP447* ET447L*	#10
	Self Solder Heat Shrink (16-14 Gauge)	Part No.	Stud Size
	STP367 ET367	#10	25 3
Crimp Solder Heat Shrink (16-14 Gauge)	Part No.	Stud Size	Qty Per Pkg.
	STP577	#10	5

Images shown actual size unless indicated otherwise.

ET Display Package

* Available while supplies last

SPADE TERMINALS







PVC (12-10 Gauge)	Part No.	Stud Size	Qty Per Pkg.
	STP491 ET491	#6	50 4
	STP492 ET492	#8	50 4
	STP208 ET208XL ET208	#10	50 65 4
Crimp Type With Heat Shrink (12-10 Gauge)	Part No.	Stud Size	Qty Per Pkg.
	STP208H	#10	10
	STP500H	1/4"	10
Self Solder Heat Shrink (12-10 Gauge)	Part No.	Stud Size	Qty Per Pkg.
	STP368	#10	25
Crimp Solder Heat Shrink (12-10 Gauge)	Part No.	Stud Size	Qty Per Pkg.
	STP576	#10	5

SLIDE-ON TERMINALS

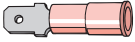
PVC (22-18 Gauge)	Part No.	Width	Qty Per Pkg.	Male/Female		
	STP148 ET148XL ET148L ET148	1/4"	100 80 20 5	M		
		STP149 ET149XL ET149L ET149	1/4"	100 80 20 5	F	
			STP480 ET480L	3/16"	50 15	M
				STP481 ET481L	3/16"	50 15
		STP484 ET484L		7/64"	50 12	F
	Nylon Fully Insulated (22-18 Gauge)	Part No.	Width	Qty Per Pkg.	Male/Female	
	STP142 ET142	1/4"	100 3	M		
		STP143 ET143	1/4"	100 3	F	
ET528 — Combo Pack includes 2 of each: STP142 and STP143						
	STP600 ET600L	3/16"	50 9	M		
		STP601 ET601L	3/16"	50 9	F	

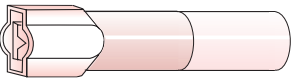
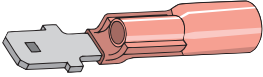
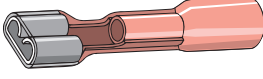
TERMINALS & CONNECTORS

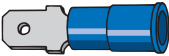



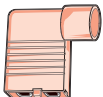
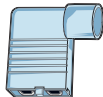

SLIDE-ON TERMINALS

Nylon Extended Barrel (22-18 Gauge)	Part No.	Width	Qty Per Pkg.	Male/Female
	STP487	3/16"	50	M
	STP488	3/16"	50	F
Nylon Fully Insulated With Heat Shrink (20-18 Gauge)	Part No.	Width	Qty Per Pkg.	Male/Female
	STP142HL STP142H	1/4"	50 10	M
	STP143HL STP143H	1/4"	50 10	F
Self Solder Heat Shrink Fully Insulated (20-18 Gauge)	Part No.	Width	Qty Per Pkg.	Male/Female
	STP469C STP469 ET469	1/4"	100 25 2	M
	STP468C STP468 ET468	1/4"	100 25 2	F
PVC (16-14 Gauge)	Part No.	Width	Qty Per Pkg.	Male/Female
	STP140D STP140 ET140XL ET140L ET140	1/4"	500 100 85 20 5	M
	STP141D STP141 ET141XL ET141L ET141	1/4"	500 100 85 20 5	F
	STP482 ET482L	3/16"	50 17	M
	STP483 ET483L	3/16"	50 17	F
	STP485 ET485L	7/64"	50 11	F

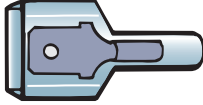
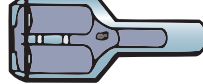
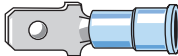
FLAG TERMINALS

Fully Insulated Nylon (22-18 Gauge)	Part No.	Width	Qty Per Pkg.	Fully Insulated Nylon (16-14 Gauge)	Part No.	Width	Qty Per Pkg.
	STP97 ET97L	1/4"	25 5		STP98 ET98L	1/4"	25 5
	STP430	3/16"	25		STP432	3/16"	25

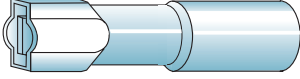
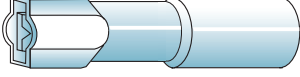
SLIDE-ON TERMINALS

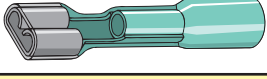
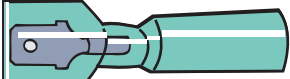
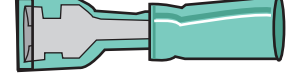
Nylon Fully Insulated (16-14 Gauge)	Part No.	Width	Qty Per Pkg.	Male/Female
	STP144D STP144 ET144XL ET144L ET144	1/4"	500 100 50 12 3	M
	STP431 STP145D STP145 ET145XL ET145L ET145	3/16" 1/4"	50 500 100 50 12 3	M F
	STP433	3/16"	50	F
ET500 - Includes 2 of each: STP144 and STP145				
Nylon Extended Barrel (16-14 Gauge)	Part No.	Width	Qty Per Pkg.	Male/Female
	STP395 ET395L	1/4"	50 12	M
	STP396 ET396L	1/4"	50 12	F
	STP489	3/16"	50	M
	STP490	3/16"	50	F
Nylon Fully Insulated With Heat Shrink (16-14 Gauge)	Part No.	Width	Qty Per Pkg.	Male/Female
	STP144HL STP144H ET144H	1/4"	50 10 3	M
	STP145HL STP145H ET145H	1/4"	50 10 3	F
Self Solder Heat Shrink Fully Insulated (16-14 Gauge)	Part No.	Width	Qty Per Pkg.	Male/Female
	STP471C STP471 ET471	1/4"	100 25 3	M
	STP470C STP470 ET470	1/4"	100 25 3	F
Crimp, Solder, Heat Shrink Fully Insulated (16-14 Gauge)	Part No.	Width	Qty Per Pkg.	Male/Female
	STP571 ET571	1/4"	5 3	M
	STP570 ET570	1/4"	5 3	F







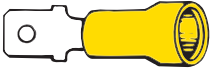

Images shown actual size unless indicated otherwise.

ET Display Package

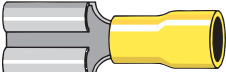
TERMINALS & CONNECTORS

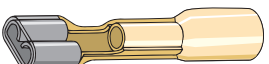
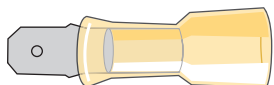
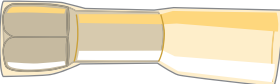

SLIDE-ON TERMINALS

PVC (12-10 Gauge)	Part No.	Width	Qty Per Pkg.	Male/Female
	STP207 ET207XL ET207	1/4"	25 75 4	M
	STP161 ET161XL ET161L ET161	1/4"	25 60 14 4	F
	STP474 ET474	3/8"	25 7	F
Nylon (12-10 Gauge)	Part No.	Width	Qty Per Pkg.	Male/Female
	STP179 ET179	1/4"	50 4	M
	STP178 ET178	1/4"	50 4	F
Nylon Heat Shrink (12-10 Gauge)	Part No.	Width	Qty Per Pkg.	Male/Female
	STP179H	1/4"	10	M
	STP178H	1/4"	10	F
Fully Insulated Self Solder With Heat Shrink (12-10 Gauge)	Part No.	Width	Qty Per Pkg.	Male/Female
	STP473 ET473	1/4"	25 3	M
	STP472 ET472	1/4"	25 3	F
Crimp, Solder Heat Shrink (12-10 Gauge)	Part No.	Width	Qty Per Pkg.	Male/Female
	STP573	1/4"	5	M
	STP572	1/4"	5	F

DOUBLE MALE INSULATED - 1/4" BLADE

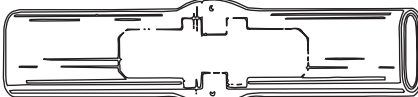



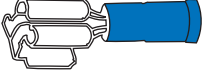
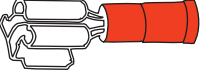
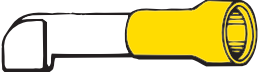

Mates with STP141 and STP161	Part No.	Qty. Per Pkg.
	SST97 ET512	10 4

Images shown actual size unless indicated otherwise.

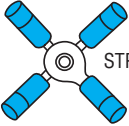
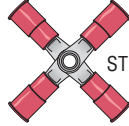
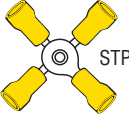
MALE & FEMALE DISCONNECTS

PVC (16-14 Gauge)	Part No.	Qty Per Pkg.
	STP182 ET182	25 3
PVC (22-18 Gauge)	Part No.	Qty Per Pkg.
	STP183 ET183	25 4
Knife Disconnect (12-10 Gauge)	Part No.	Qty Per Pkg.
	STP153	10

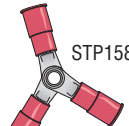
SPLICE CONNECTOR

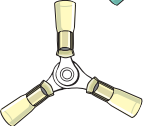









PVC	Part No.	Gauge	Qty Per Pkg.
Not actual size	STP167 4-way	22-18	10
	STP195 4-way ET195	16-14	25 2
	STP167		
	STP156 4-way ET156	12-10	10 2
	STP158 3-way ET158	22-18	25 3
	STP199 3-way ET199	16-14	10 2
	STP166 3-way ET166		
	STP158 3-way	12-10	25
	STP137 3-way ET137	(2)12-10 (1)16-14	25 2
3-Way Crimp With Heat Shrink	Part No.	Gauge	Qty Per Pkg.
Not actual size	STP166H	16-14	10
			
	STP137H	12-10	10

ET Display Package

TERMINALS & CONNECTORS

TERMINALS & CONNECTORS

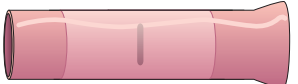
BUTT SPLICE CONNECTORS









PVC	Part No.	Gauge	Qty Per Pkg.	
	STP130D	22-18	500	
	STP130		50	
	ET130XL		85	
	ET130L		20	
	ET130		6	
		STP131D	16-14	500
		STP131C		100
		STP131		50
		ET131XL		85
		ET131L		20
ET131	6			
	STP132D	12-10	500	
	STP132		50	
	ET132XL		70	
	ET132L		15	
ET132	5			
	STP186	8	10	
		STP185	6	10
		STP184	4	10
	Part No.	Gauge	Qty Per Pkg.	
	STP196D	22-18	500	
	STP196		50	
	ET196L		12	
	ET196		4	
		STP197D	16-14	500
		STP197		50
		ET197L		12
		ET197		4
		STP198D	12-10	500
STP198C		100		
STP198		50		
ET198L		12		
ET198		2		
	STP206	8	10	
		STP205	6	10
		STP204	4	10

Images shown actual size unless indicated otherwise.

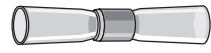

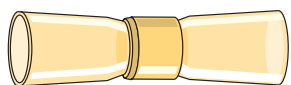
ET Display Package

* Display Jar

BUTT SPLICE CONNECTORS

Crimp With Heat Shrink	Part No.	Gauge	Qty Per Pkg.
	STP350H	24-22	10
	STP130HC	20-18	100
	STP130H		10
	ET130H		3
	ET130HJ*		100
	STP131HC	16-14	100
	STP131H		10
	ET131H		3
	ET131HJ*		100
	STP132HC	12-10	100
	STP132H		10
	ET132H		3
	ET132HJ*		60
	STP186H		8
Self Solder With Heat Shrink	Part No.	Gauge	Qty Per Pkg.
	STP350	24-22	25
	STP351C	22-18	100
	STP351		25
	ET351		3
ET351J*	100		
	STP352C	16-14	100
	STP352		25
	ET352		3
	ET352J*		100
	STP353C	12-10	100
	STP353		25
	ET353		3
	ET353J*		60
Crimp, Solder, Heat Shrink	Part No.	Gauge	Qty Per Pkg.
	STP550	24-22	5
	ET550		3
	STP551C	20-18	100
	STP551		10
	ET551		3
	ET551J*		100
	STP552D	16-14	500
	STP552C		100
	STP552		10
	ET552		3
ET552J*	100		
	STP553D	12-10	500
	STP553C		100
	STP553		10
	ET553		3
ET553J*	60		

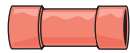
PARALLEL SPLICE - PVC

PVC	Part No.	Gauge	Qty Per Pkg.
	STP435	22-18	50
	STP436	16-14	50
	STP437	12-10	50
	ET437L		6
	ET529L Combo Pack Includes:		
	STP435	3 pcs.	
	STP436	4 pcs.	
	STP437	2 pcs.	





Stripped wires lie side by side in the splice and are secured by a single crimp in the middle.



TERMINALS & CONNECTORS



STEP DOWN BUTT CONNECTORS

PVC	Part No.	Gauge	Qty Per Pkg.
	STP384	16-14 to 22-18	10
	STP385	12-10 to 16-14	10
	STP386	8 to 12-10	10
	STP387	6 to 8	10





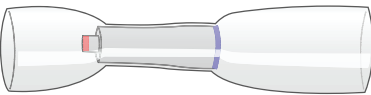
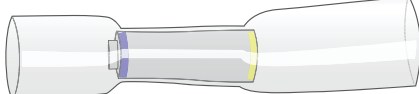
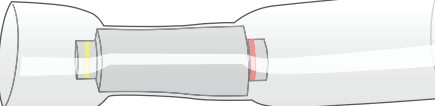

Step down end is color coded with smaller gauge colored stripe.

SEALED IN-LINE BUTT CONNECTORS

Joins 2 Wires To 1 Crimp With Heat Shrink	Part No.	Gauge	Pkg. Qty.
	STP400	20-18 Ga.	10
	STP401	16-14 Ga.	10
	STP402	12-10 Ga.	10











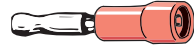
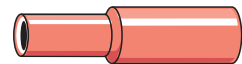

For use when two wires need to be inserted in one end of splice and a single wire in the other end.

WIRE PIN TERMINALS **

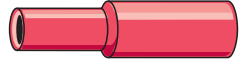
PVC	Part No.	Gauge	Pkg. Qty.
	STP375	22-18 Ga.	25
	STP376	16-14 Ga.	25
	STP377	12-10 Ga.	25
Nylon	Part No.	Gauge	Pkg. Qty.
	STP378	22-18 Ga.	25
	STP379	16-14 Ga.	25
	STP380	12-10 Ga.	25

** For use where set screws or clamps make contact with wire. Simplifies insertion of standard wire into European style terminal blocks by preventing wire strand foldback. Fits all popular pin-type (European) terminal blocks.

BULLET CONNECTORS .176" FORD APPLICATIONS .156" UNIVERSAL





PVC (22-18 Gauge)	Part No.	Size	Qty Per Pkg.
	STP170 ET170 (Male)	.156"	25 4
	STP171 ET171 (Fem.)	.156"	25 4
	STP172 ET172 (Male)	.176"	25 4
	STP173 ET173 (Fem.)	.176"	25 4
Nylon (22-18 Gauge)	Part No.	Size	Qty Per Pkg.
	STP373 (Male)	.156"	25
	STP371 (Fem.)	.156"	25
	STP374 (Male)	.176"	25
	STP372 (Fem.)	.176"	25
Crimp Type With Heat Shrink (20-18 Gauge)	Part No.	Size	Qty Per Pkg.
	STP171H (Fem.)	.156"	10
	STP170H (Male)	.156"	10
PVC (16-14 Gauge)	Part No.	Size	Qty Per Pkg.
	STP163C STP163 ET163L ET163 (Male)	.156"	100 25 15 4
	STP162C STP162 ET162L ET162 (Fem.)	.156"	100 25 15 4
	STP147 ET147 (Male)	.176"	100 4
	STP164C STP164 ET164 (Fem.)	.176"	100 25 4
ET527L - Combo Pack Includes: STP163 - 7 pcs. STP162 - 7 pcs.			

TERMINALS & CONNECTORS

Images shown actual size unless indicated otherwise.
ET Display Package

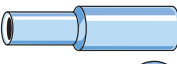
TERMINALS & CONNECTORS

BULLET CONNECTORS .176" FORD APPLICATIONS .156" UNIVERSAL

Nylon - 16-14 Gauge	Part No.	Size	Qty Per Pkg.
	STP462 (Male)	.156"	25
	STP369 (Fem.)	.156"	25
	STP463 (Male)	.176"	25
	STP370 (Fem.)	.176"	25
Crimp Type With Heat Shrink - 16-14 Gauge	Part No.	Size	Qty Per Pkg.
	STP163H (Male)	.156"	10
	STP162H (Fem.)	.156"	10



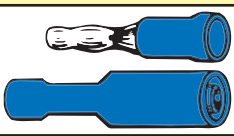

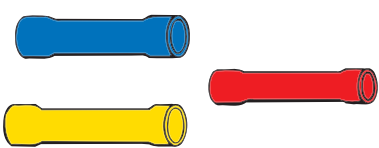

BULLET CONNECTOR COMBO PACK .156" UNIVERSAL

PVC (16-14 Gauge)	Part No.	Contains
	ET527L	7 pcs. STP163 (Male) 7 pcs STP162 (Female)

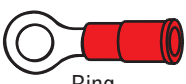
BUTT SPLICE CONNECTOR COMBO PACK

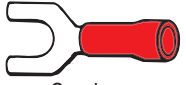
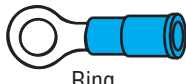
PVC	Part No.	Contains
	ET503	STP130 - 6 pcs. 22-18 Ga. STP131 - 5 pcs. 16-14 Ga. STP132 - 4 pcs. 12-10 Ga.



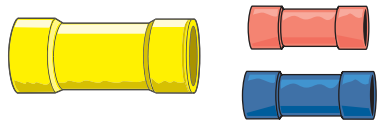

PVC TERMINAL COMBO PACK

22-18 Gauge Terminals	Part No.	Contains
 Ring  Hook  Splice  Spade	ET513	Contains 4 each: STP120 - #10 ring STP130 - splice STP150 - #10 spade STP165 - #10 hook
16-14 Gauge Terminals	Part No.	Contains
 Ring  Hook  Splice  Spade	ET514	Contains 4 each: STP124 - #10 ring STP131 - splice STP135 - #10 spade STP155 - #10 hook

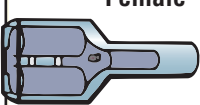

PARALLEL SPLICE - PVC

PVC Combo Pack	Part No.	Contains
	ET529L	STP435 - 3 pcs. STP436 - 4 pcs. STP437 - 2 pcs.

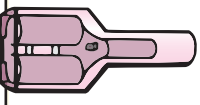
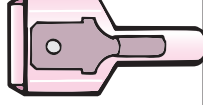
SLIDE-ON TERMINAL COMBO PACK

16-14 Ga. Terminals 1/4" Fully Insulated Nylon	Part No.	Contains
 Female  Male	ET500	STP144 - 2 pcs. STP145 - 2 pcs.
22-18 Ga., 16-14 Ga. & 12-10 Ga. 1/4" Male/Female Slides	Part No.	Contains
 Female  Male	ET504	STP140 - M 3 pcs. STP141 - F 3 pcs. STP148 - M 2 pcs. STP149 - F 2 pcs. STP207 - M 1 pc. STP161 - F 1 pc.
22-18 Ga., 16-14 Ga. & 12-10 Ga. All Female 1/4" PVC	Part No.	Contains
 Female	ET526	STP141 - F 4 pcs. STP149 - F 4 pcs. STP161 - F 4 pcs.
22-18 Ga. 1/4" Fully Insulated Nylon	Part No.	Contains
 Female  Male	ET528	STP142 - M 2 pcs. STP143 - F 2 pcs.

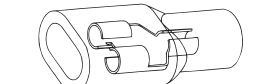
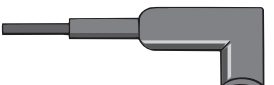
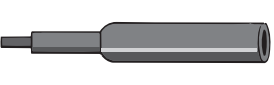
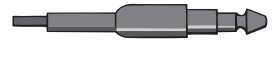
SPECIAL CONNECTORS

	Part No.	Description	Qty Per Pkg.
	SST95	.156" and .176" Dual Female	50
	ET511		5
	SST96	.156" 3-Wire Female mates with STP163	50
	STL-1	156" Vinyl Female - 90° mates with STP163	1
	STL-2	176" Vinyl Female - Str. mates with STP147	1
	STL-3	176" Vinyl Male - Str. 12' 16 gauge leads	1

Images shown actual size unless indicated otherwise.

TERMINALS, SPECIALTY TERMINALS & CONNECTORS



QUICK SPlice CONNECTORS

Parallel Quick Splice	Part No.	Gauge	Qty. Per Pkg.
	STP381 ET381XL ET381	22-18 Ga.	25 30 2
	STP434†	18-14 Ga.	25
	STP139D STP139 ET139XL ET139L ET139	18-14 Ga.	500 25 30 5 2
	STP176 ET176XL ET176	12-10 Ga.	25 12 1
"T" Tap Female	Part No.	Gauge	Qty. Per Pkg.
	STP212 (Red) STP211 (Yellow) STP210 (Blue)	22-18 Ga.	25 2
	STP210D STP210 ET210	18-14 Ga.	500 25 2
	STP211 ET211	12-10 Ga.	25 2
"T" Splice Quick Tap	Part No.	Gauge	Qty. Per Pkg.
See Figure 1 Includes STP210 & STP144	STP138 ET502	18-14 Ga.	25 pairs 4 pairs
Bullet Quick Splice	Part No.	Gauge	Qty. Per Pkg.
See Figure 2	STP146 ET146*	18-14 Ga.	25 pcs. 1 pair

*Contains STP163 & STP146

†STP434 is double run – both wires extend through connector

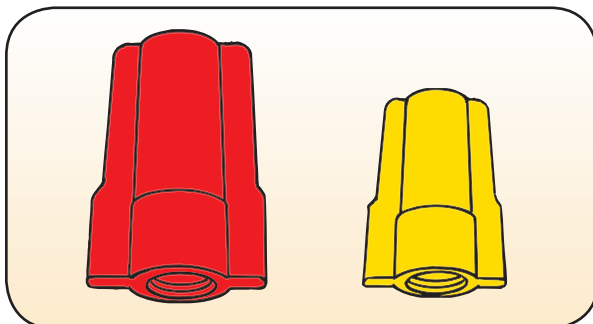
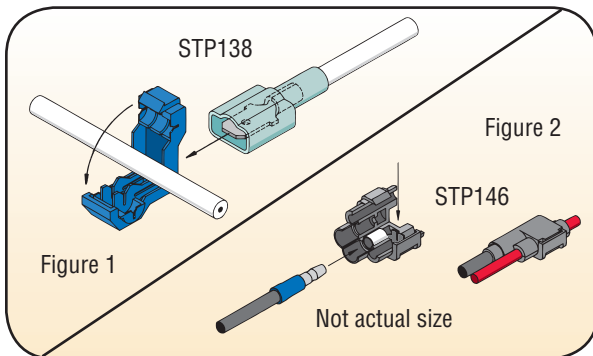

SELF STRIPPING SPlice CONNECTORS

22-14 Gauge Range	Part No.	Qty. Per Pkg.
	STP525	10
		2-Wire
		3-Wire

Self stripping connector makes a 2 or 3 wire splice with a wire range of 22-14 Ga.
Maximum voltage: 600V Operating temp: 105°
Insert 2 or 3 unstripped wires into the connector. Self stripping action makes the connection as the blue cap is driven into the connector body using a crimping tool or pliers held perpendicular to the wires. Silicone sealant in the connector body makes for a moisture resistant, flame retardant termination.

TWIST LOCK CONNECTORS

Part No.	Gauge	Wire Ranges		Qty. Per Pkg.
		Min.	Max.	
STP201 ET201	22-14 Ga.	3 #22	3 #16	25 6
STP203 ET203	22-14 Ga.	3 #20	4 #16 w/1 #20	25 5
STP200 ET200	18-10 Ga.	1 #14 w/1 #18	4 #14	25 4
STP202 ET202	18-10 Ga.	2 #14	2 #10 w/2 #12	25 3
ET204*		Various Sizes		12

*Contains 3-STP200, 4-STP201, 1-STP202, 4-STP203

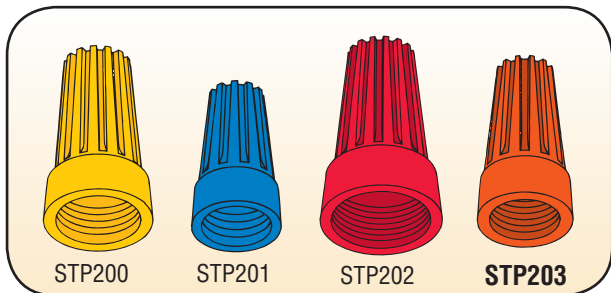

TWIST LOCK CONNECTORS

Part No.	Gauge	Wire Ranges		Qty. Per Pkg.
		Min.	Max.	
STP180 ET180	18-10 Ga.	2 #14	5 #12	25 3
STP181 ET181	18-10 Ga.	2 #18	3 #12	25 3

Images shown actual size unless indicated otherwise.
ET Display Package

MULTI-WIRE CONNECTORS & FUSE BLOCK TAPS

WATERPROOF TWIST CONNECTORS

Part No.	Gauge	Wire Ranges		Qty Per Pkg.
		Min.	Max.	
STP464	22-14 Ga.	3 #20	3 #16	10
STP466	18-12 Ga.	4 #18	2 #12	8
STP467	18-10 Ga.	2 #14	4 #12	8

Silicone filled safety Twist-on Connector should be used where water proofing is a must. Pre-filled sealant provides watertight enclosure.

Maximum Voltage: 600V
Sealant Temperature: -45°F to 400°F
Temperature Rating: 167°F (75°C)

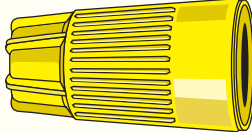

STP466

Silicone sealant protects against sparks, water and corrosion.

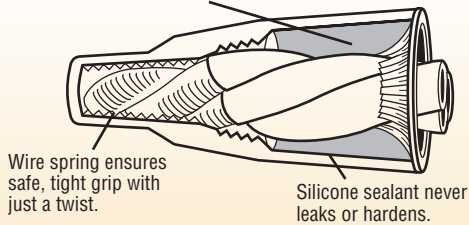

IMPORTANT: Once installed, connectors should not be reused. Silicone sealant is ineffective after first use.

CLOSED END SPLICE

Part No.	Gauge	Possible Wire Combinations	Qty. Per Pkg.
STP382	22-14 1 #18 w/ 2 #20	1 #16 w/ 1 #18	25
STP383 ET383	22-12 2 #22 w/ 2 #12	1 #12 w/ 1 #22	25 4
STP160	18-8 1 #12 w/ 4 #16	1 #8 w/ 1 #16	10
STP152 ET152	16-10 2 #16 w/ 2 #18	1 #12 w/ 1 #16	25 4

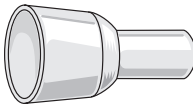

STP160

CLOSED END SPLICE WITH HEAT SHRINK

Part No.	Description	Gauge	Std. Pkg.
STP397	Joins 2 to 4 wires	22-14	10
STP398	Joins 2 to 4 wires	18-10	10

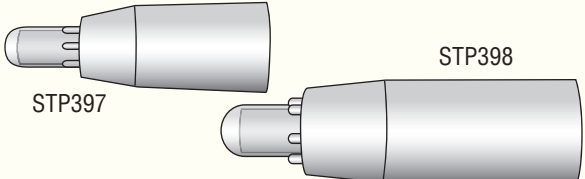

STP398

STP397

FUSE BLOCKS

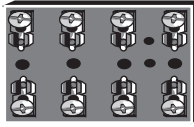
Glass Type	Part No.	Description	Qty Per Pkg.
 ET220	ET220	4 - Gang	1
	ET221	5 - Gang	1
	ET222	6 - Gang	1

FUSE BLOCK TAP

Part No.	Description	Std. Pkg.
ET460	Piggyback for ET461	1
ET461	GM Fuseblock Tap	1

Installation Instructions:

1. Splice accessory connection to fuseblock tap lead.
2. Plug fuseblock tap connector into fuseblock cavity marked "BAT."
3. When using piggyback, unplug fuseblock tap. Insert piggyback into fuse tap cavity and reinsert tap into fuseblock.

To tap current from the battery – always on clocks, burglar alarms and radios, etc.

For GM fuseblocks when "Bat" cavity is already in use or constant service is required. Extra cavity built into fuseblock tap to piggyback additional accessory connections.

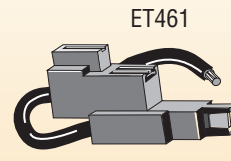
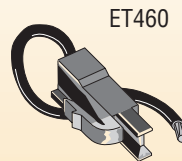

FUSE TAPS

Part No.	Description	Qty Per Pkg.
ST230 ET230	GM Type Fuse Tap 1/4" Blade	25 8
ST231 ET231	GM Type Mini Fuse Tap 3/16" Blade	25 7

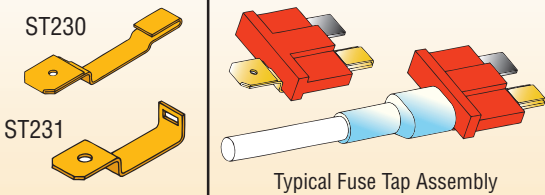

ET Display Package

FUSE CLIP ADAPTER

Description: 1/4" Male Tab, Taps Into Fuseblock

Part No.	Std. Pkg.	
SST206	25	

FUSE HOLDERS & FUSE TAPS

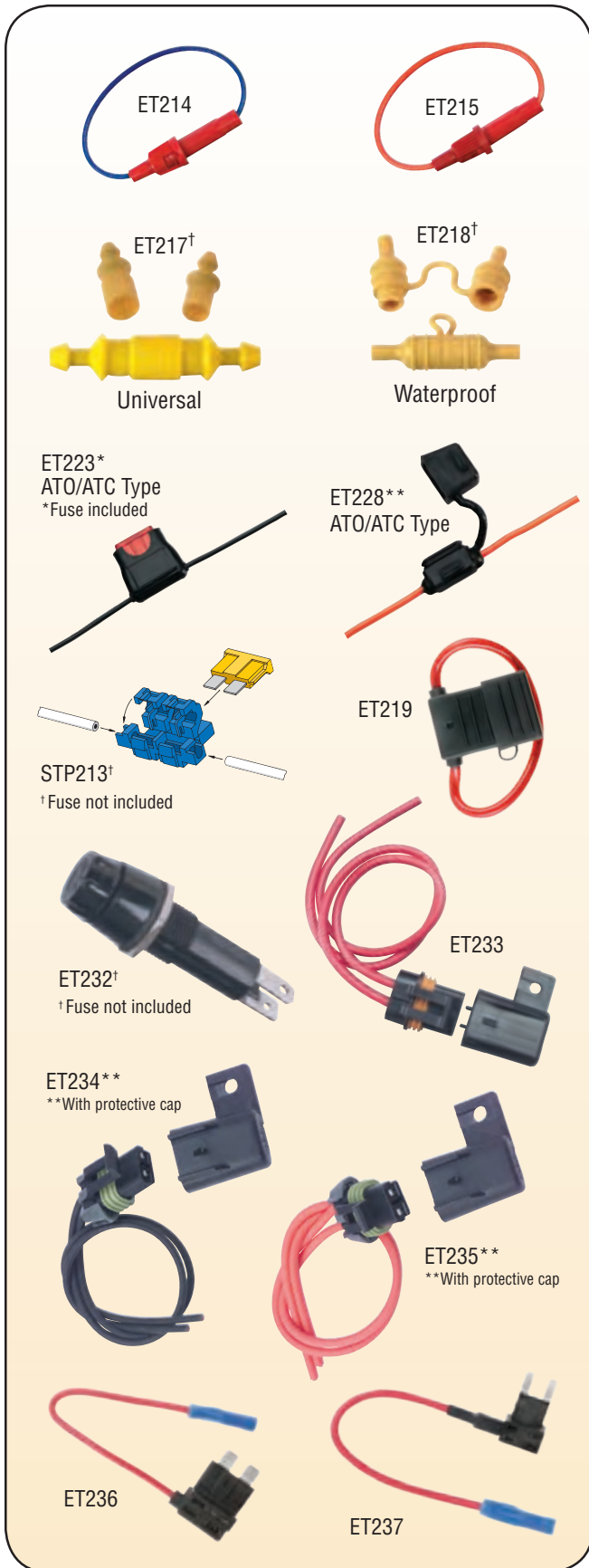

IN-LINE FUSE HOLDERS

Description: Glass Type			
Part No.	Size	Gauge	Per Pkg.
ET214	20 amp.	14 Ga.	2
ET215	30 amp.	12 Ga.	2
ET217†	30 amp.	18 - 12 Ga.	1
ET218†	30 amp.	18 - 12 Ga.	1
ET232†	Panel Mount Fuse Holder		1
Description: ATO/ATC Type			
STP213†	20 amp.	18 - 14 Ga.	10
ET216			2
ET223*	10 amp.	14 Ga.	1
ET224*	20 amp.	14 Ga.	1
ET225*	30 amp.	12 Ga.	1
ET226**	20 amp.	16 Ga.	1
ET227**	25 amp.	12 Ga.	1
ET228**	30 amp.	12 Ga.	1
ET229**	20 amp.	14 Ga.H.D.	1
ET219**	40 amp.	8 Ga.H.D. Maxi Fuse Holder	1
ET233**	40 amp.	10 Ga. Sealed Fuse Holder	1
ET234**	15 amp.	16 Ga. Sealed Mini Fuse Holder	1
ET235**	30 amp.	12 Ga. Sealed Mini Fuse Holder	1
ET236	10 amp.	16 Ga. Add a Circuit ATC/ATO Fuse Holder	1
ET237	10 amp.	16 Ga. Add a Circuit Mini Fuse Holder	1

† Fuse not included

* Fuse included

** With protective cap (ET227 & ET229 are Mini® Fuse Holders)

ET Display Package

1/4" SLIDE-ON CONNECTORS

20-14 Gauge		Part No.	Std. Pkg.
SST86		SST86 (M)	50
		SST98 (M)	25
SST99		SST99 (F)	50
		SST100	25
SST102‡		ET510	10
		SST102‡	25
ST68 COIL ADAPTER		ST68	10
		ST110	50
ST110		ST110	50
		ET509	9

‡ Available while supplies last

UNINSULATED TERMINALS

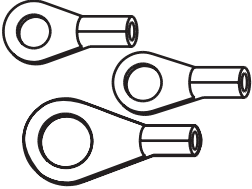
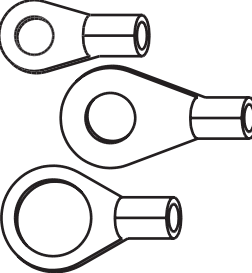
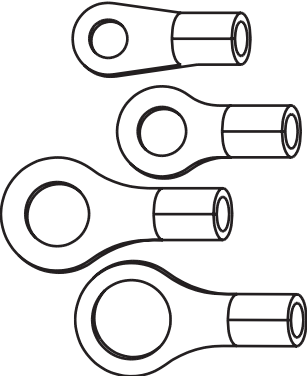
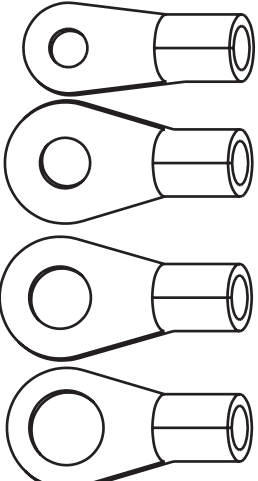

RING TERMINALS

16-14 Gauge	Part No.	Stud Size	Qty Per Pkg.
	SST73	#6-8	100
	SST71	#10	100
	SST72	1/4"	100
12-10 Gauge	Part No.	Stud Size	Qty Per Pkg.
	SST76	#8-10	100
	SST82	1/4"	50
	SST75	3/8"	50
8 Gauge	Part No.	Stud Size	Qty Per Pkg.
	SST83	#8-10	50
	SST200	1/4"	10
	SST203	5/16"	10
	SST201	3/8"	10
6 Gauge	Part No.	Stud Size	Qty Per Pkg.
	SST84	#8-10	50
	SST205	1/4"	10
	SST202	5/16"	10
	SST88	3/8"	25

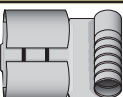
FLAG TERMINAL

16-14 Gauge	Part No.	Width	Qty Per Pkg.
	SST101	1/4"	25

SPADE TERMINALS

16-14 Gauge	Part No.	Stud Size	Qty Per Pkg.
	SST74	10	100
12-10 Gauge	Part No.	Stud Size	Qty Per Pkg.
	SST87	#8-10	50

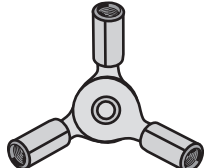

3 WAY CONNECTOR

16-14 Gauge	Part No.	Qty Per Pkg.
	SST103	25



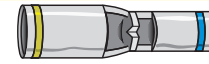

KNIFE CONNECTOR

16-14 Gauge	Part No.	Std. Pkg.
	SST77	50



STEP-DOWN BUTT CONNECTORS

	Part No.	Gauge	Std. Pkg.
	SST90	14-16 to 12-10 Gauge	10
	SST89	10-12 to 8 Gauge	10

BUTT SPLICE CONNECTORS

20-14 Gauge	Part No.	Std. Pkg.
	SST91	100
 SST92 - Sleeve 1 7/8" x 7/32" OD	SST92 SST92A	100 100 ft.
12-10 Gauge	Part No.	Std. Pkg.
	SST80	50
 SST93 - Sleeve 1 7/8" x 1/4" OD	SST93	50
8 Gauge	Part No.	Std. Pkg.
	SST81	50

STOPLIGHT SWITCH CONNECTOR

16-14 Gauge	Part No.	Size	Std. Pkg.
	ST55 (F)	.156"	100
	SST104 (M)	.156"	100

POSI-LOCK™ CONNECTORS



POSI-LOCK™ CONNECTORS

Part No.	Gauge	Qty. Per Pkg.
STP534*†	24-18	25
STP523C† STP523† ET523†	24-18	100 25 2
STP501C† STP501† ET501†	16-14	100 25 2
STP530C† STP530† ET530†	12-10	100 25 2
STP527†	8-6	25



***Ultra high temperature**

PATENT No. 5,228,875, 5,695,369 and others pending

EASY AS 1 2 3

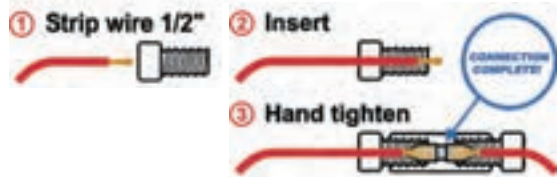

POSI-TAP™ CONNECTORS

Part No.	Gauge	Qty. Per Pkg.
STP536† ET536†	18-12	25 2

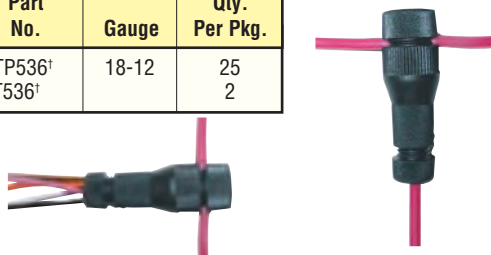

POSI-TAP LINE TAP CONNECTOR

- Place hot wire in slotted male end.
- Hand tighten body to slotted male.
- Strip run wire(s) approx. 3/8", insert into other male end and hand tighten.

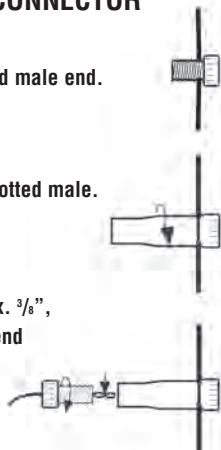

POSI-SEAL™ CONNECTOR

Part No.	Gauge	Std. Pkg.
STP516†	18	10
STP517†	16-14	10
STP518†	12	10
STP519†	10	10
STP520	8	10



POSI-PLUG™ QUICK DISCONNECT

Part No.	Gauge	Qty. Per Pkg.
ET535	18	1

EASY AS 1 2 3

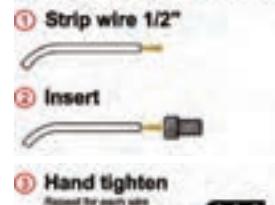

POSI-FUSE™ CONNECTORS

Part No.	Gauge	Qty. Per Pkg.
ET537		
ET537†	18-12	2 pr.
ET538†	18-12	1 pc.

Fuses: 3/4" to 1 1/4"
Up to 30 AMP max

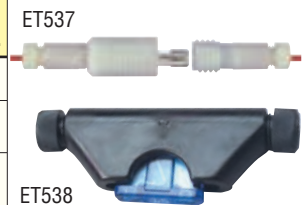

POSI-TWIST™ CONNECTORS

Part No.	Gauge	Qty. Per Pkg.	STP533	STP531	STP532
STP533† ET533†	24-14	25 5			
STP531	22-10	25			
STP532	22-10	25			

ET Display Package

† Available while supplies last

HEAT SHRINK TERMINALS

HEAT SHRINK TERMINALS FOR ALL WEATHER PROTECTION...

Ideal for marine, automotive, and industrial applications. Tough multiple wall tubing protects splice from moisture and corrosion. Adhesive tubing melts to form waterproof bond. Color-coded for easy identification. Temperature Rating -65°F to 275°F.

1. Crimp type heat shrink terminal application is fast and foolproof.

Crimp type heat shrink terminals are ideal for applications where protection from moisture and corrosion is a must. Simply crimp connection as you would any regular terminal. Then heat tubing with a heat gun until shrink tube bonds to primary wire to form a waterproof bond.

2. Self solder heat shrink terminals solder and seal each connection in one step.*

No crimping tools required which risk damage to wire insulation or provide unreliable connection. Solder ring melts when heated with a heat gun and provides superior current flow and tensile strength. Translucent tubing allows visual inspection of connection after termination.

3. Crimp, solder and heat shrink terminals offer the ultimate electrical connection.*

Crimped for reliability, soldered for strength and conductivity, and sealed for moisture protection and durability. Crimp the connection as you would any regular terminal, heat solder ring until melted with a heat gun and then heat the shrink tube until bonded to primary wire.

* WARNING

Battery posts, terminals and related accessories contain lead, lead compounds and *CADMIUM* chemicals known to the State of California to cause cancer and reproductive harm. WASH HANDS AFTER HANDLING!

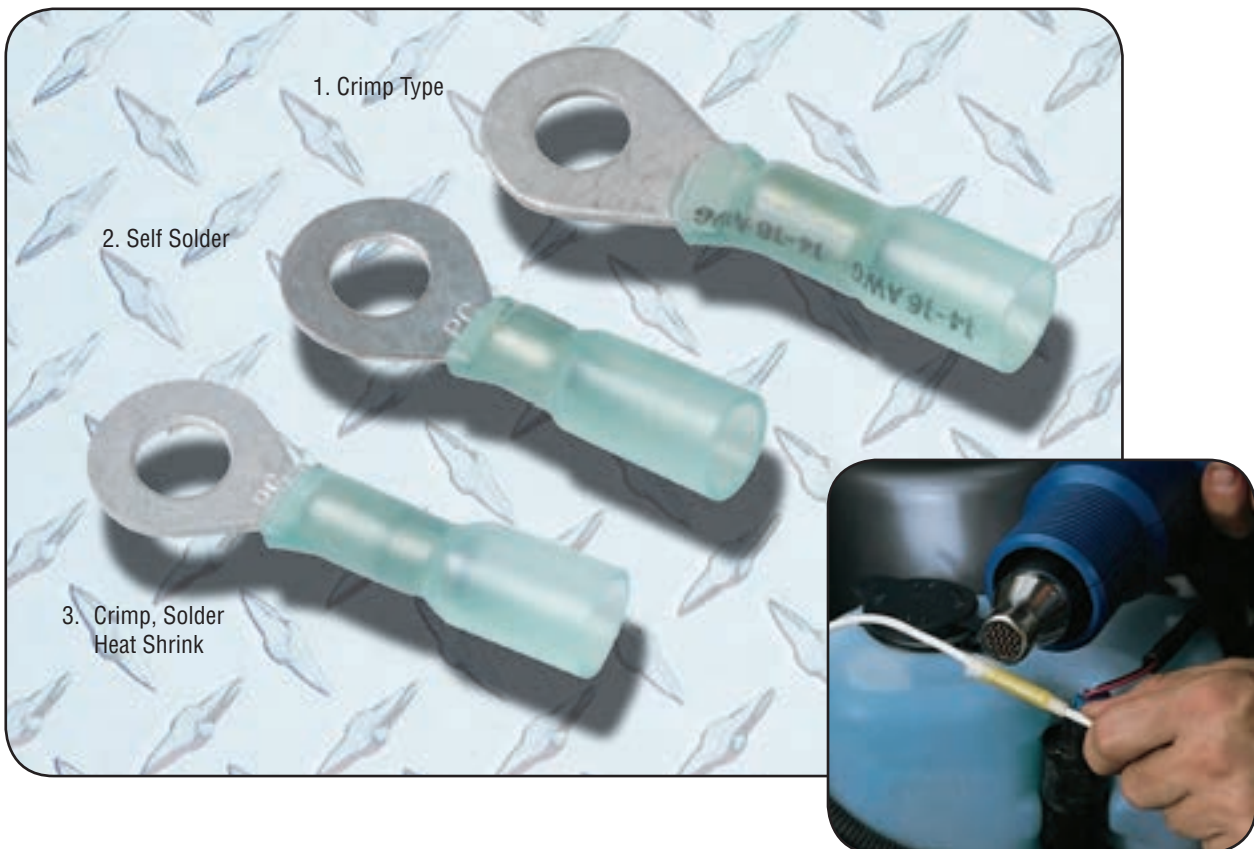

SPECIALTY TERMINALS & CONNECTORS



CRIMP TYPE WITH HEAT SHRINK

How to Use Crimp Type Heat Shrink Terminals...

1. Insert stripped wire.



Butt Splice Connector

2. Crimp connector



3. Apply heat evenly across sleeve until shrinkage is complete.



WTT20 Heat Gun

RING TERMINALS

20-18 Gauge

	Part No.	Stud Size	Qty Per Pkg.
	STP151H ET151H	#6	10 3
	STP497H ET497H	#8	10 3
	STP120H ET120H	#10	10 3
	STP121H ET121H	1/4"	10 3
	STP606H	5/16"	10
	STP122H ET122H	3/8"	10 3

16-14 Gauge

	Part No.	Stud Size	Qty Per Pkg.
	STP498H	#6	10
	STP123H ET123H	#8	10 3
	STP124H ET124H	#10	10 3
	STP125H ET125H	1/4"	10 3
	STP157H ET157H	5/16"	10 3
	STP126H ET126H	3/8"	10 3

ET Display Package

RING TERMINALS

12-10 Gauge

	Part No.	Stud Size	Qty Per Pkg.
	STP127H ET127H	#10	10 3
	STP128H	1/4"	10
	STP168H	5/16"	10
	STP129H	3/8"	10
	STP159H	1/2"	10

8 Gauge

	Part No.	Stud Size	Qty Per Pkg.
	STP188H	1/4"	10
	STP177H	3/8"	10

SPADE TERMINALS

20-18 Gauge

	Part No.	Stud Size	Qty Per Pkg.
	STP136H	#6	10
	STP499H	#8	10
	STP150H	#10	10

16-14 Gauge

	Part No.	Stud Size	Qty Per Pkg.
	STP133H	#6	10
	STP134H	#8	10
	STP135H ET135H	#10	10 3



12-10 Gauge

	Part No.	Stud Size	Qty Per Pkg.
	STP208H	#10	10
	STP500H	1/4"	10



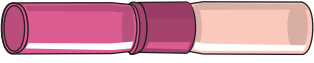

SPECIALTY TERMINALS & CONNECTORS

CRIMP TYPE WITH HEAT SHRINK

BULLET CONNECTORS

20-18 Gauge	Part No.	Size	Qty Per Pkg.
	STP170H (male)	.156	10
	STP171H (fem.)	.156	10
16-14 Gauge	Part No.	Size	Qty Per Pkg.
	STP163H (male)	.156	10
	STP162H (fem.)	.156	10

BUTT SPLICE CONNECTORS

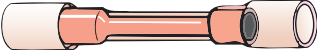
	Part No.	Gauge	Qty Per Pkg.
	STP350H	24-22	10
	STP130HC	20-18	100
	STP130H		10
	ET130HJ†		100
	ET130H		3
	STP131HC	16-14	100
	STP131H		10
	ET131HJ†		100
	ET131H		3
	STP132HC	12-10	100
	STP132H		10
	ET132HJ†		60
	ET132H		3
	STP186H	8	10

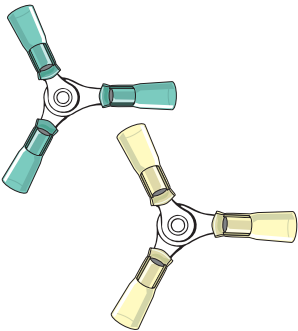

SPLICE CONNECTORS 3 WAY

	Part No.	Gauge	Qty Per Pkg.
	STP166H*	16-14	10
	STP137H*	12-10	10

*Not shown in actual size
ET Display Package



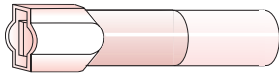
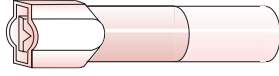

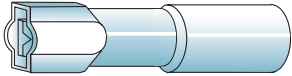
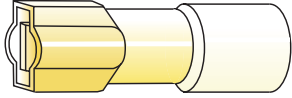
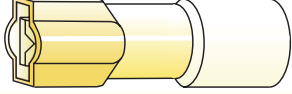

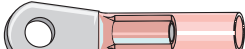
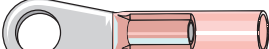

† Display Jar

1/4" FULLY INSULATED NYLON COUPLERS

	Part No.	Gauge	Qty Per Pkg.
	STP142HL	20-18	50
	STP142H (male)		10
	STP143HL	20-18	50
	STP143H (fem.)		10
	STP144HL	16-14	50
	STP144H		10
	ET144H (male)		3
	STP145HL	16-14	50
	STP145H		10
	ET145H (fem.)		3
	STP179H (male)	12-10	10
	STP178H (fem.)	12-10	10

SELF SOLDER HEAT SHRINK TERMINALS

RING TERMINALS

20-18 Gauge	Part No.	Stud Size	Qty Per Pkg.
	STP354	#6	25
	STP355	#8	25
	ET355		3
	STP356	#10	25
	ET356		3
	STP357	1/4"	25
	ET357		3
	STP475	5/16"	25
	ET475		3
	STP476	3/8"	25
	ET476		3
16-14 Gauge	Part No.	Stud Size	Qty Per Pkg.
	STP477	#6	25
	STP358	#8	25
	STP359C	#10	100
	STP359		25
	ET359		3
	STP360	1/4"	25
	ET360		3

SPECIALTY TERMINALS & CONNECTORS



SELF SOLDER HEAT SHRINK TERMINALS

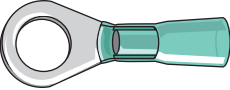
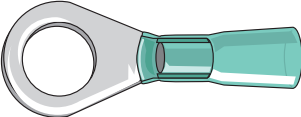
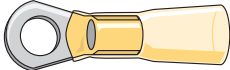
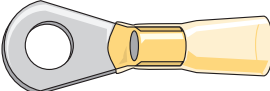
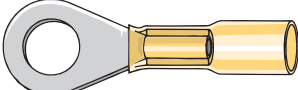
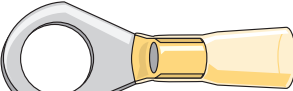
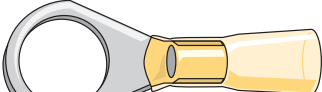

RING TERMINALS

16-14 Gauge	Part No.	Stud Size	Qty Per Pkg.
	STP478 ET478	5/16"	25 3
	STP361 ET361	3/8"	25 3
12-10 Gauge	Part No.	Stud Size	Qty Per Pkg.
	STP362	#10	25
	STP363 ET363	1/4"	25 3
	STP479 ET479	5/16"	25 3
	STP364 ET364	3/8"	25 3
	STP365 ET365	1/2"	25 3

ET Display Package

† Display Jar

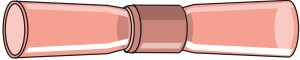
BUTT CONNECTORS

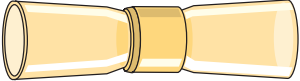
	Part No.	Gauge	Qty Per Pkg.
	STP350	24-22	25
	STP351C STP351 ET351J† ET351	20-18	100 25 100 3
	STP352C STP352 ET352J† ET352	16-14	100 25 100 3
	STP353C STP353 ET353J ET353	12-10	100 25 60 3

SPADE TERMINALS

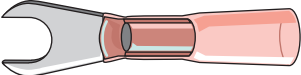
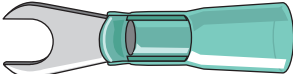
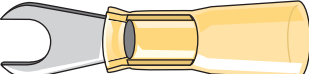
	Part No.	Stud Size	Gauge	Qty Per Pkg.
	STP366	#10	20-18	25
	STP367 ET367	#10	16-14	25 3
	STP368	#10	12-10	25

Instructions:



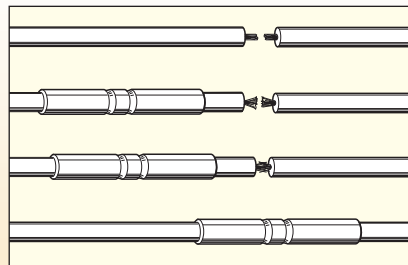

- Strip wires 3/8".
- Slide splice over one end of wire.
- Separate wire strands; push both ends together to mesh wire.
- Slide splice over joined wires; heat tubing from center out to terminal ends; then focus heat on solder until it flows.
- Remove from heat and let cool for a perfect connection.

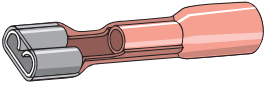
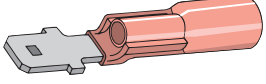
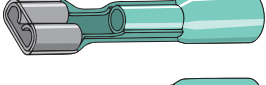
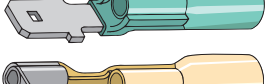
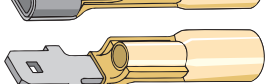
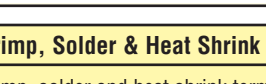
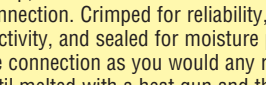
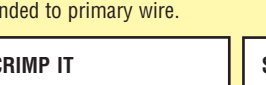

SPECIALTY TERMINALS & CONNECTORS

SELF SOLDER HEAT SHRINK TERMINALS

1/4" SLIDE-ON TERMINALS

	Part No.	Gauge	Qty Per Pkg.
	STP468C	20-18	100
	STP468		25
	ET468 (Fem.)		2
	STP469C	20-18	100
	STP469		25
	ET469 (Male)		2
	STP470C	16-14	100
	STP470		25
	ET470 (Fem.)		3
	STP471C	16-14	100
	STP471		25
	ET471 (Male)		3
	STP472	12-10	25
	ET472 (Fem.)		3
	STP473	12-10	25
	ET473 (Male)		3

Crimp, Solder & Heat Shrink

Crimp, solder and heat shrink terminals offer the ultimate electrical connection. Crimped for reliability, soldered for strength and conductivity, and sealed for moisture protection and durability. Crimp the connection as you would any regular terminal, heat solder ring until melted with a heat gun and then heat the shrink tube until bonded to primary wire.

CRIMP IT











SOLDER IT



SEAL IT...SEALED FOR SUPERIOR DURABILITY

CRIMP, SOLDER & HEAT SHRINK









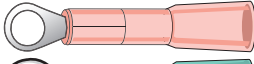

BUTT CONNECTORS

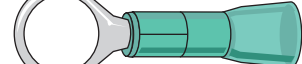
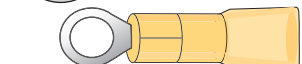
	Part No.	Gauge	Qty Per Pkg.
	STP550	24-22	5
	ET550		3
	STP551C	20-18	100
	STP551		10
	ET551J†		100
	ET551		3
	STP552D	16-14	500
	STP552C		100
	STP552		10
	ET552J†		100
	ET552		3
	STP553D	12-10	500
	STP553C		100
	STP553		10
	ET553J†		60
	ET553		3



† Display Jar

CRIMP, SOLDER & HEAT SHRINK

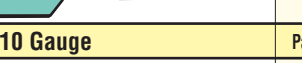
RING TERMINALS

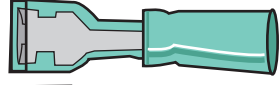

	Part No.	Stud Size	Gauge	Qty Per Pkg.
	STP556	#10	20-18	5
	ET556			3
	STP559	#10	16-14	5
	ET559			3
	STP560	1/4"	16-14	5
	ET560			3
	STP561	3/8"	16-14	5
	ET561			3
	STP562	#10	12-10	5
	ET562			3
	STP563	1/4"	12-10	5
	STP564	3/8"	12-10	5
	ET564			3
	STP565	1/2"	12-10	5

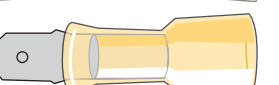
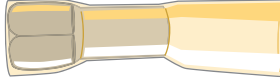
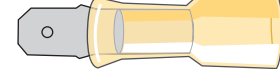
SLIDE ON TERMINAL

16-14 Gauge	Part No.	Width	Female/Male	Qty Per Pkg.
	STP570	1/4"	F	5
	ET570			3
	STP571	1/4"	M	5
	ET571			3
12-10 Gauge	Part No.	Width	Female/Male	Qty Per Pkg.
	STP572	1/4"	F	5
	STP573	1/4"	M	5

ET Display Package

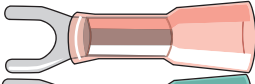
SPADE TERMINALS

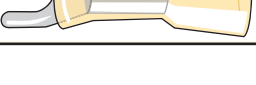
	Part No.	Stud Size	Gauge	Qty Per Pkg.
	STP578	#10	22-18	5
	STP577	#10	16-14	5
	STP576	#10	12-10	5

O.E.M. ELECTRONIC TERMINALS



The most popular OE-style terminals for repairing computer wire harness connections. Replacing damaged terminals saves time and money, eliminates the need to change the entire wiring harness.







Product Type	Illustration	Part No.	O.E. No.	Gauge	Description	Qty. Per Pkg.
GM Pack-Con		CG1* ET701	6294512 12020346	20-18	Female Mates with CG2, ET702	10 5
		CG2* ET702	6294511	20-18	Male-Tin Plated Mates with CG1, ET701	10 5
		CG5* ET703	8900524 12020320	16-14	Male-Tin Plated Mates with CG6, ET704	10 5
		CG6* ET704	12020347	16-14	Female Mates with CG5, ET703	10 5
		CG19 ET706	8905087	16-14	Female-Tin Plated Heavy Duty Series	10 5
		CG18 ET705	12033817	12-10	Male-Tin Plated Heavy Duty Series	10 5
GM 56 Series		CG7* ET708	2962447	16-14	Female-Unplated Brass Mates with CG8, ET709 Insulated with shell CG45, ET710	10 5
		CG80	2962574	12	Female - Brass	10
		CG8* ET709	2962987	16-14	Male-Unplated Brass Mates with CG7, ET708 Insulated with CG47, ET712	10 5
		CG45 ET710	2962448	—	Terminal Insulator Mates with CG47, ET712 Insulates CG7, ET708	10 3
		CG46 ET711	6294493	—	Alternator Connector Housing Insulates with CG7, ET703 GM 1973-up	10 2
		CG47 ET712	2962984	—	Terminal Insulator Mates with CG45, ET710 Insulates CG8, ET709	10 3
		ET507	—	—	Combo Pack, Includes CG7, CG45	4 ea.
		ET508	—	—	Combo Pack, Includes CG8, CG47	4 ea.
GM Metri-Pack		CG3* ET713	12015857	18-14	280 Series Female Mates with CG4, ET714	10 4

*Available in CGA1 terminal assortment.

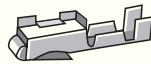
ET Display Package

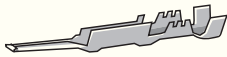
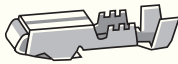
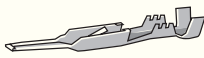
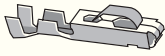
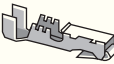
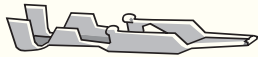
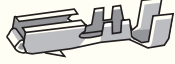
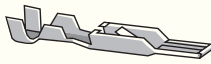
TERMINALS & CONNECTORS

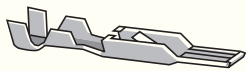
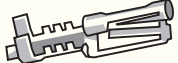
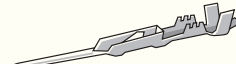
O.E.M. ELECTRONIC TERMINALS



Product Type	Illustration	Part No.	O.E. No.	Gauge	Description	Qty. Per Pkg.
GM Metri-Pack (Cont'd.)		CG61	12052466	24	150 Series Tin Plated	10
		CG21 ET715	12047680	20-18	150 Series Female Tin Plated—Mates with CG22, ET716	10 5
		CG22 ET716	12047581	20-18	150 Series Male Tin Plated—Mates with CG21, ET715	10 5
		CG24 ET718	12034046	20-18	Tin Plated, Mates with CG25, ET719	10 5
		CG25 ET719	12034047	20-18	280 Series Male, Tin Plated, Mates with CG24, ET718	10 5
		CG63	12052922 12089340	20-18	150 Series	10
		CG23 ET717	12047767 4368618	20-16	150 Series Female Tin Plated	10 5
		CG4* ET714	12020116	18-14	280 Series Male Tin Plated—Mates with CG3, ET713	10 4
		CG26 ET720	12015861	16-14	480 Series Female Tin Plated, Mates with CG27, ET721	10 5
		CG27 ET721	12020120	16-14	480 Series Male Tin Plated, $\frac{3}{16}$ " blade width, Mates with CG26, ET720	10 5
		CG28 ET722	12015870	16-14	630 Series Female Tin Plated Mates with CG62	10 5
		CG62	12020126	16-14	630 Series Male Tin Plated, $\frac{1}{4}$ " blade width, Mates with CG28, ET722	10
	GM Micro Pack Series		CG12* ET723	12020757	20-18	Female Tin Plated
		CG14 ET724	12040902	22	Tin Plated	10 5
		CG15 ET725	12020758	16-14	Tin Plated	10 4
Weather-Pack Series		CG9*	12015323		Silicone Seal for Weather-Pack Terminals Use with CG10, CG11 CG16 and CG17, ET735	10
		ET734				5

*Available in CGA1 terminal assortment.

ET Display Package

O.E.M. ELECTRONIC TERMINALS

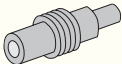
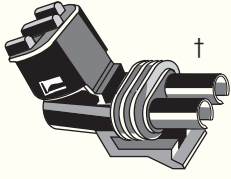

Product Type	Illustration	Part No.	O.E. No.	Gauge	Description	Qty. Per Pkg.
GM Weather-Pack Series		CG10* ET735	12033674 12089040	20-18	Male Terminal Tin Plated Brass Mates with CG11, ET736	10 5
		CG11* ET736	12034051 12089188	20-18	Female Terminal Tin Plated Brass Mates with CG10, ET735	10 5
		CG64 ET737		20-18	Male Repair Lead 10"-18 ga. Wire with CG9, ET734 Seal and CG10, ET735 Terminal	5 1
		CG65 ET738		20-18	Female Repair Lead 10"-18 ga. Wire with CG9, ET734 Seal and CG11, ET736 Terminal	5 1
		CG13* ET742	12034053 12004610	20-18	GM Electronic Control Module Tin Plated	10 4
		CG16 ET739	12010182 12124580	16-14	Female-Tin Plated Mates with CG17, ET740	10 5
		CG17 ET740	12089305 12010085	16-14	Male-Tin Plated Mates with CG16, ET739	10 5
		CG29 ET741	12010300	—	Silicone Cavity Plug for GM. Weather-Pack & Metri-Pack 280 Series	10 5
		CG38 ET743	12010996	—	Nylon Single Cavity for Male Terminals CG64, ET737 Mates with CG39, ET744	10 1
		CG39 ET744	12015791	—	Nylon Single Cavity for Female Terminals, CG65, ET738 Mates with CG38, ET743	10 1
		CG40 ET745	12010973	—	Nylon Double Cavity for Male Terminals Mates with CG41, ET746	10 1
		CG41 ET746	12015792	—	Nylon Double Cavity for Female Terminals Mates with CG40, ET745	10 1
		CG42 ET747	12010717	—	Nylon Triple Cavity for Male Terminals Mates with CG43, ET748	10 1

† Not Actual Size. * Available in CGA1 terminal assortment. ET Display Package

TERMINALS & CONNECTORS

O.E.M. ELECTRONIC TERMINALS

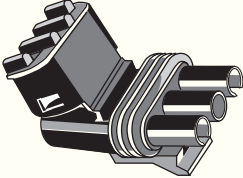
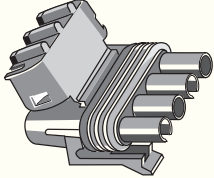
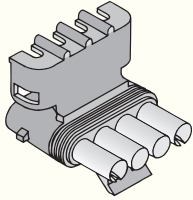
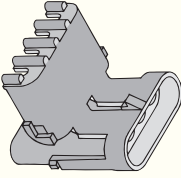
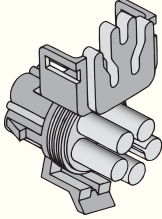
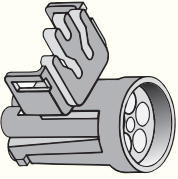
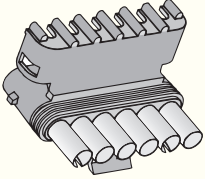
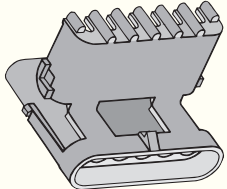
Product Type	Illustration	Part No.	O.E. No.	Gauge	Description	Qty. Per Pkg.
GM Weather-Pack Series (Cont.)		CG43	12015793	—	Nylon Triple Cavity for Female Terminals Mates with CG42, ET747	10
		ET748				1
		CG44	12015387	—	Nylon Four Cavity for Male Connects Wiring Harness to Idle Control Solenoid. GM 1985-up Offset Locking Arm	5
		ET749				1
		CG70	12015797	—	Nylon 4-cavity Flat Male Tower Mates with CG71 Uses CG11 Terminal	5
		CG71	12010974	—		Nylon 4-cavity Flat Female Shroud Mates with CG70 Uses CG10 Terminal
		CG72	12034342	—	Nylon 5-cavity Round Male Tower Mates with CG73	1
		CG73	12065158	—		Nylon 5-cavity Round Female Shroud Mates with CG72
	CG74	12015799	—	Nylon 6-cavity Flat Male Tower Mates with CG75	1	
	CG75	12010975	—		Nylon 6-cavity Flat Female Shroud Mates with CG74	1

Not Actual Size. ET Display Package

O.E.M. ELECTRONIC TERMINALS



Product Type	Illustration	Part No.	O.E. No.	Gauge	Description	Qty. Per Pkg.
GM Power Window & Door Lock Terminal		CG68	2965880	16-14	Tin Plated	10
Ford Terminals		CG30† ET726	D1AB-14488-CA	20-18	Wedgelock Pin Type, Female Terminal, Mates with CG31, ET727	10 4
		CG31† ET727	D1AB-14461-AA	20-18	Wedgelock Pin Type, Male Terminal, Mates with CG30, ET726	10 5
		CG32† ET728	D8BB-14474-BA D3AB-14474-DA	20-18	Box Type Female Terminal	10 4
		CG33† ET729	D20B-14421-BB	20-18	Male Terminal $\frac{3}{16}$ " Blade Width	10 4
		CG55†	E7EB-14421-EA	20-18	Male Mini Block $\frac{1}{8}$ " Width Mates with CG57	10
		CG57†	E7EB-14474-CA	20-18	Female Mini Block $\frac{1}{8}$ " Width Mates with CG55	10
		CG54†	E8EB-14474-AMA	16-14	Female Micro Terminal $\frac{1}{8}$ " Width	10
		CG56†	E8EB-14421-LA	16-14	Male Mini Block $\frac{1}{8}$ " Blade Mates with CG58	10
		CG58†	E8EB-14474-AJA	16-14	Female Mini Block $\frac{1}{8}$ " Blade Mates with CG56	10
		CG81*	E8EB-14474-AKA	12-10	Mini Terminal Block fits $\frac{1}{8}$ " Blade	10
		CG59†	D20B-14421-CB	16-14	Male Standard Block $\frac{3}{16}$ " Blade Mates with CG60	10
		CG60†	E8EB-14474-VA	16-14	Female Standard Block $\frac{3}{16}$ " Blade Mates with CG59	10

† Available in CGA2 Terminal Assortment.

ET Display Package

*Available while supplies last

O.E.M. ELECTRONIC TERMINALS

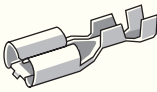
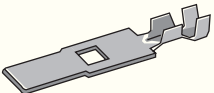
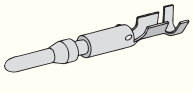
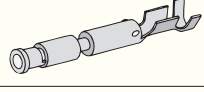
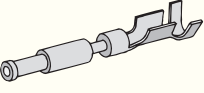
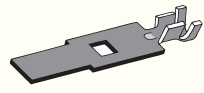
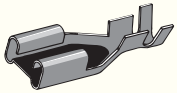
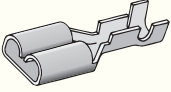
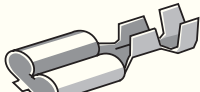
Product Type	Illustration	Part No.	O.E. No.	Gauge	Description	Qty. Per Pkg.
Chrysler Terminals		CG53†	4304729	24-18	Used with P.C. Board Connections and General Purpose	10
		CG36†	3843601	20-18	Center Tab for 1/4" Blade Slide	10
		CG37†	3843386	20-18	Male, Long Tab 1/4" Blade Width	10
		CG50†	7368261	20-18	Male, 3/32" Dia. Pin	10
		CG51†	4368163	20-18	Female, 3/32" Dia. Pin	10
		CG52†	4368960	20-18	Female, 1/16" Dia. Pin	10
		CG48	3843386	16-14	Male, 1/4" Blade	10
		CG49	3843601	16-14	Female, 1/4" Blade	10
Universal Terminals		CG69	GM:2965470 Ford:C5AB-14474-B Chrys:2096466	20-18	1/4" Slide Terminal	10
		CG35† ET733	GM:2965580 Ford:C1SF-14474-A Chrys:2096467	14-12	1/4" Female Slide Terminal	10 5

† Available in CGA2 Terminal Assortment

ET Display Package

TERMINAL & CONNECTOR ASSORTMENTS



TERMINALS & CONNECTORS

CGA1-GM COMPUTER TERMINAL ASSORTMENT



CGA1

134-piece assortment contains complete terminal starter kit plus WTT12 crimping tool, WTT13 extractor tool and WTT14 & WTT15 extractor picks.

CONTENTS:

Part No.	Qty.	Part No.	Qty.
CG1	10	CG9	10
CG2	10	CG10	10
CG3	10	CG11	10
CG4	10	CG12	10
CG5	10	CG13	10
CG6	10	WTT12	1
CG7	10	WTT13	1
CG8	10	WTT14	1
		WTT15	1

CGA2-FORD AND CHRYSLER COMPUTER TERMINAL ASSORTMENT



CGA2

130-piece assortment contains complete terminal starter kit.

CONTENTS:

Part No.	Qty.	Part No.	Qty.
CG30	10	CG52	5
CG31	10	CG53	5
CG32	10	CG54	5
CG33	10	CG55	5
CG35	10	CG56	5
CG36	5	CG57	5
CG37	5	CG58	5
CG50	10	CG59	5
CG51	10	CG60	10

O.E.M. COMPUTER TERMINAL MAKE UP TECHNIQUES

Terminal Extraction

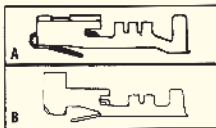

1. (A) Push-To-Seat Terminals
Grasp the lead and push the terminal to the forward most position. Hold lead in this stop position.



(B) Pull-To-Seat Terminals
Grasp the lead and pull the terminal to the forward most position. Hold lead in this stop position.

2. Locate terminal lock tang in connector canal.

3. Insert pick straight into the connector canal at the mating end of the connector.

4. Depress lock tang to unseat terminal. Never use force to remove terminal from connector.

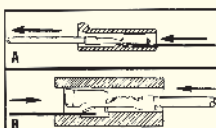

5. (A) Push-To-Seat Terminals
Gently pull the cable to remove the terminal through the back (wire end) of the connector.



(B) Pull-To-Seat Terminals
Gently push the cable to remove the terminal through the front (mating end) of the connector.

6. Look for terminal and connector damage. Replace if necessary.

Note: When reseating existing terminal, assure lock tang(s) are to reseat properly.

Standard Replacement

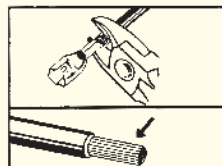

1. Cut off damaged terminal end between core and insulation crimp.

2. Remove insulation. (Make sure you do not cut strands.)

3. Position stripped wire in terminal.

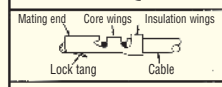

4. Hand crimp core wings first, then insulation wings using crimping tool.

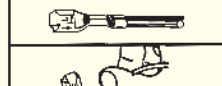

5. Apply solder at all hand crimped locations.



6. Electrically check repaired terminal for continuity using DVOM tool.

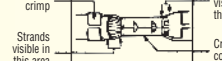

Sealed Weather Pack and Metri-Pack Replacement



1. Cut off damaged terminal end between core and insulation crimp.



5. Hand crimp core wings first, then insulation wings using crimping tool.



2. Apply correct seal per gauge size of wire and slide back along cable to enable insulation removal. (Make sure you do not cut strands.)



6. Solder all hand crimped terminals.

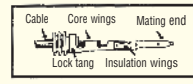

3. Align seal with cable insulation.

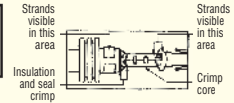

7. Electrically check repaired terminal for continuity using DVOM tool.



4. Position stripped wire and seal in terminal.

TERMINAL & CONNECTOR ASSORTMENTS



STA51



STA10



STA12



STA11

STA51-INSTALLER TERMINAL KIT

Durable metal cabinet has 28 compartments. Comes with a balanced assortment of insulated terminals, connectors and splices. Also included is handy heat shrink tubing in convenient 1 1/2" pre-cut lengths. Drawer measures 3 1/16" H x 18 3/8" W x 12 7/16" D. Will fit in an AB200 metal cabinet.

CONTENTS: 650 pcs.

Part No.	Qty.	Part No.	Qty.	Part No.	Qty.
STP120	10	STP133	10	STP151	10
STP121	10	STP134	25	STP161	10
STP123	25	STP135	25	STP162	10
STP124	50	STP136	10	STP163	10
STP125	25	STP139	25	STP170	10
STP126	25	STP140	50	STP171	10
STP127	10	STP141	50	STP207	10
STP128	10	STP144	25	STP208	10
STP129	25	STP145	25	STT260	5
STP130	10	STP148	10	STT261	10
STP131	50	STP149	10	STT262	5
STP132	25	STP150	10		

STA10-IGNITION WIRE TERMINAL KIT

Contains ignition wire terminals plus WTT4 Crimpmaster tool.

CONTENTS: 126 pcs.

Part No.	Qty.	Part No.	Qty.
ST22	25	ST114	15
ST25	10	ST116	5
ST26	10	ST119	10
ST106	25	TN7	5
ST107	10	WTT4	1
ST113	10		

STA12-IGNITION/PRIMARY WIRE TERMINAL KIT

CONTENTS: 225 pcs.

Part No.	Qty.	Part No.	Qty.
CG49	5	STP124	30
SST71	5	STP125	10
SST86	5	STP130	20
SST91	5	STP131	35
ST22	10	STP132	25
ST25	10	STP139	10
ST106	10	STP140	10
ST107	5	STP141	20
STP123	10		

STA11-PRIMARY WIRE TERMINAL KIT

Contains insulated terminals plus WTT5 Crimp 'n Cut tool.

CONTENTS: 121 pcs.

Part No.	Qty.	Part No.	Qty.
STP123	5	STP134	5
STP124	20	STP135	5
STP125	5	STP139	10
STP127	5	STP140	5
STP130	10	STP141	10
STP131	30	WTT5	1
STP132	10		

TERMINAL & CONNECTOR ASSORTMENTS

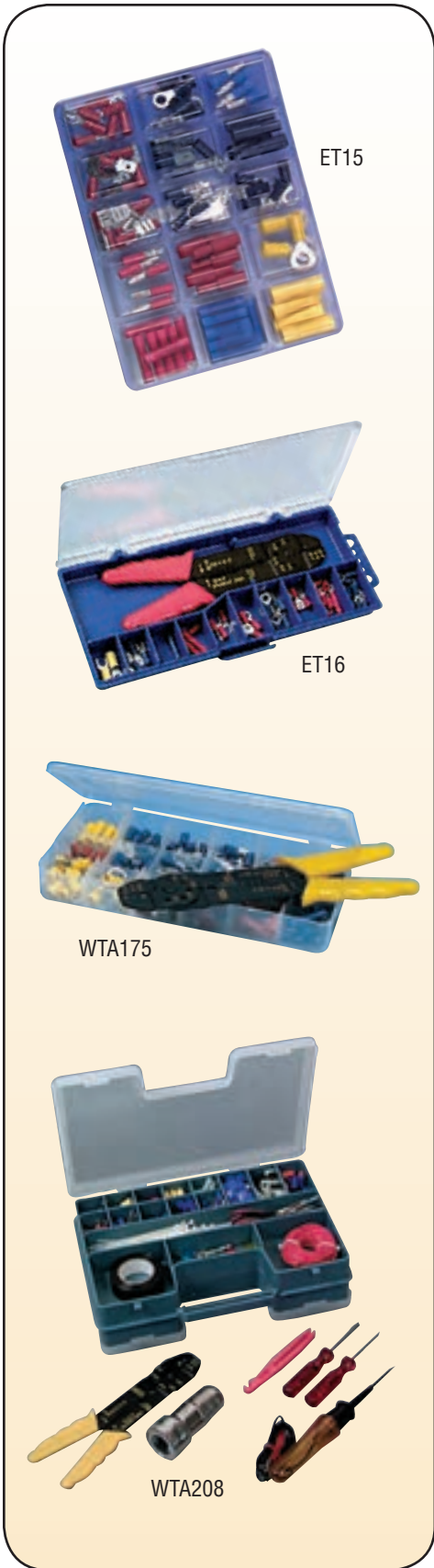

ET15

ET16

WTA175

WTA208

* Kit contents may vary

ET15-TERMINAL STARTER KIT

CONTENTS: 80 pcs.

Part No.	Qty.	Part No.	Qty.
STP120	4	STP149	7
STP124	6	STP154	1
STP128	2	STP155	5
STP130	7	STP162	4
STP131	6	STP163	4
STP132	4	STP165	3
STP140	5	STP170	5
STP141	5	STP171	5
STP148	7		

ET16-TERMINAL STARTER KIT*

Gauge	Stud Size	Description	Qty.
22-18	#10	Spade Terminal	3
22-18	#10	Ring Terminal	3
22-18	#8	Ring Terminal	7
22-18	#6	Ring Terminal	7
22-18	-	Butt Splice Connector	4
22-18	-	Male 1/4" Slide-on-Terminal	2
22-18	-	Female 1/4" Slide-on-Terminal	2
16-14	#10	Ring Terminal	7
16-14	#8	Spade Terminal	3
16-14	#6	Ring Terminal	7
16-14	#4	Ring Terminal	3
12-10	#10	Ring Terminal	1
12-10	#10	Spade Terminal	1
-	-	Economy Crimping Tool	1

WTA175-ECONOMY TERMINAL KIT*

Contains primary wire terminals plus an economy crimping tool for the occasional user.

Gauge	Description	Qty.
22-18 Ga.	#6 stud, Ring Terminal	10
22-18 Ga.	#6 stud, Spade Terminal	10
22-18 Ga.	#8-10 stud, Ring Terminal	10
22-18 Ga.	Male, 1/4" Slide-On Connector	10
22-18 Ga.	Female, 1/4" Slide-On Connector	10
22-18 Ga.	Butt Splice Connector	10
16-14 Ga.	#8 stud, Spade Terminal	10
16-14 Ga.	#10 stud, Spade Terminal	10
16-14 Ga.	#10 stud, Ring Terminal	10
16-14 Ga.	5/16" stud, Ring Terminal	10
16-14 Ga.	1/4" stud, Ring Terminal	10
16-14 Ga.	Male, 1/4" Slide-On Connector	10
16-14 Ga.	Female, 1/4" Slide-On Connector	10
16-14 Ga.	Butt Splice Connector	10
12-10 Ga.	Butt Splice Connector	10
12-10 Ga.	#8-10 stud, Ring Terminal	10
12-10 Ga.	3/8" stud, Ring Terminal	5

WTA208-ELECTRICAL REPAIR KIT*

Contains everything you need in an emergency automotive repair kit, plus a set of handy tools – all in a rugged plastic carrying case.

- Blade and glass fuses
- 10 wiring nuts
- 50 tie straps (4", 6", 8")
- 10 pieces heat shrink tubing
- 10 rubber grommets
- 94 insulated terminals and connectors
- 13 nylon clamps
- 1 30-ft. roll of electrical tape
- 1 20-ft. roll of 18 ga. primary wire
- Fuse puller
- Battery brush
- 2 test leads
- Crimping tool
- Voltage tester
- 2 screwdrivers (blade and Phillips head)

KITS & ASSORTMENTS



STA14



STA17



STA23

STA14-SELF SOLDER TERMINAL KIT

135-piece assortment includes various sizes of butt connectors, ring terminals, spade terminals and slip-on connectors.

CONTENTS:

Part No.	Qty.	Part No.	Qty.
STP350	5	STP363	5
STP351	10	STP364	5
STP352	10	STP365	5
STP353	5	STP366	5
STP354	5	STP367	5
STP355	5	STP368	5
STP356	5	STP468	5
STP357	5	STP469	5
STP358	5	STP470	5
STP359	5	STP471	5
STP360	5	STP472	5
STP361	5	STP473	5
STP362	5		

STA17-CRIMP-TYPE HEAT SHRINK TERMINAL ASSORTMENT

115-piece terminal assortment includes various gauge sizes of ring terminals, spade terminals, butt connectors, fully insulated nylon couplers. All terminals include adhesive lined polyolefin heat shrink tubing for contaminant resistant seal.

CONTENTS:

Part No.	Qty.	Part No.	Qty.
STP120H	5	STP131H	10
STP122H	5	STP132H	10
STP123H	5	STP135H	5
STP124H	5	STP142H	5
STP125H	5	STP143H	5
STP126H	5	STP144H	5
STP127H	5	STP145H	5
STP128H	5	STP150H	5
STP129H	5	STP151H	5
STP130H	10	STP208H	5

STA23-CRIMP, SOLDER AND HEAT SHRINK TERMINAL ASSORTMENT

110-piece assortment includes various sizes of butt connectors, ring terminals, spade terminals and slip-on connectors. All terminals include adhesive lined polyolefin heat shrink tubing for contaminant resistant seal.

CONTENTS:

Part No.	Description	Qty.
STP550	24-22 ga. Butt connector	5
STP551	20-18 ga. Butt connector	20
STP552	16-14 ga. Butt connector	20
STP553	12-10 ga. Butt connector	15
STP556	20-18 ga. #10 ring	5
STP559	16-14 ga. #10 ring	5
STP560	16-14 ga. 1/4" ring	5
STP561	16-14 ga. 3/8" ring	5
STP562	12-10 ga. #10 ring	5
STP564	12-10 ga. 3/8" ring	5
STP570	16-14 ga. 1/4" female slide-on	10
STP571	16-14 ga. 1/4" male slide-on	10



STA15



HST1A



HST2A



STA26



STA27



STA28

STA15-BATTERY TERMINAL SOLDER SLUG KIT

48-piece assortment contains complete range of pre-measured solder and heat shrink tubing for battery cable make-up or repair. **CONTENTS:** 48 pcs.

Part No.	Gauge	Color	Qty.
BP185	4 ga.	gray	5
BP186	2 ga.	green	5
BP187	1 ga.	pink	5
BP188	1/0 ga.	black	5
BP189	2/0 ga.	orange	5
BP190	3/0 ga.	purple	5
BP191	4/0 ga.	yellow	5
BP192	2 oz.	FLUX	1
Heat Shrink Tubing – 8–2 gauge			4
Heat Shrink Tubing – 1–2/0 gauge			4
Heat Shrink Tubing – 2/0–4/0 gauge			4

HST1A-HEAT SHRINK TUBING ASSORTMENT

6" Lengths **CONTENTS:** 43 pcs.

Part No.	Qty.	Part No.	Qty.
HST6	5	HST81B	2
HST10	10	HST81R	2
HST14	10	HST240B	2
HST18	10	HST240R	2

HST2A-CLEAR HEAT SHRINK TUBING ASSORTMENT

CONTENTS: 31 pcs.

Part No.	I.D. Shrinks			Qty.
	From	To	Gauge	
HST21	.500"	.195"	8-1	10
HST28	.312"	.104"	14-08	10
HST30	.187"	.060"	20-14	10
WTT31	Flameless heat torch			1

STA26-CRIMP, SOLDER & SEAL BUTT CONNECTOR KIT

20-piece assortment contains 3 sizes of butt connectors. All connectors are insulated with a color-coded, adhesive-lined polyolefin heat shrink tubing to provide maximum durability against corrosion and vibration.

Part No.	Gauge	Qty.
STP551	20-18 ga.	5
STP552	16-14 ga.	10
STP553	12-10 ga.	5

STA27-CRIMP & SEAL BUTT CONNECTOR KIT

30-piece assortment contains 3 sizes of butt connectors. All connectors are insulated with a color-coded, adhesive-lined polyolefin heat shrink tubing to provide maximum durability against corrosion and vibration.

Part No.	Gauge	Qty.
STP130H	20-18 ga.	10
STP131H	16-14 ga.	15
STP132H	12-10 ga.	5

STA28-SEALED MULTIPLE WIRE CONNECTOR KIT

21-piece assortment contains 3 sizes of in-line butt connectors and 2-sizes of closed end connectors. All connectors are insulated with an active, adhesive-lined polyolefin heat shrink tubing to provide maximum durability against corrosion and vibration.

Part No.	Gauge	Color	Qty.
STP400	20-18 ga.	Red Dashes	5
STP401	16-14 ga.	Blue Dashes	5
STP402	12-10 ga.	Yellow Dashes	5
STP397	22-14 ga.	Blue Dashes	3
STP398	20-18 ga.	Yellow Dashes	3

WIRING CENTER CABINET



AB99W — Wiring Center Cabinet

Manufactured for extreme durability with reinforced locking steel doors and a heavy 22 gauge welded steel body. A bonus pack includes exterior cabinet decals, a ruler decal, storage drawer plan-o-grams, helpful product instruction decals, a wire and cable illustrated parts guide, and merchandise certificate. Dimensions are: 39 3/16" H x 32" L x 13 13/16" W. 7 cubic feet storage compartment includes the following:

CONTENTS:

- 4 Metal drawers to store bulk quantities of terminals and accessories
- 3 Small metal rods used for 100' spools of primary wire
- 1 Large metal rod for bulk battery cable
- Adjustable shelf for wire and cable stock.

AB10C — Catalog Rack

Mounts onto AB99W cabinet. Rugged steel construction has slots for 9, 2" catalog holders. 3 two inch catalog holders are included in the rack. Merchandise certificate included. Mounting hardware included. Dimensions: 17 1/2" H x 32" L x 12 3/16" W

AB11C — Catalog Rack Holders

2" Catalog rack holders for use with AB10C catalog rack. Std. Pkg. 3.

Cabinet & Storage Drawers

Part No.	Std. Description	Pkg.
AB200	Metal Cabinet, 8 5/16" H x 20 1/2" W x 12 3/4" D	1
AB201	Metal Cabinet Drawer, 29 Compartments 3 1/8" H x 18 3/8" W x 12 7/16" D	1
AB202	Plastic Box, 18 Compartments 1 3/4" H x 11" W x 6 1/2" D	1
AB203	Plastic Cabinet Drawer, 12 Adjustable Dividers 3 1/8" H x 18 1/2" W x 12 3/4" D	1
ET904X	4" Peg Hook	100



WIRING TOOLS		
Part No.	Description	Std. Pkg.
ET100	Economy Crimping Tool — Strips or cuts primary wire and crimps terminals from 22 to 10 ga. 7.5" long.	1
WTT4	Crimpmaster — 10" long; boxed; plastic handle grips. For professional crimps on ignition wire terminals (including ST114 and ST116 90° terminals), insulated and uninsulated solderless terminals (including "W" crimps). Stripping notches for 22 to 10 ga. primary wire.	1
WTT5	Crimp 'N Cut — 8" long; boxed; plastic handle grips. Strips wire, crimps terminals, cuts screws. Color-coded crimping notches for insulated solderless terminals. Wire cutter plus stripping notches for 22 to 10 gauge primary wire. Special crimping nest for 7mm ignition wire terminals. Same as carded version ET10.	1
WTT6	Wire Stripper — The original "Miller Stripper." Cuts, strips wire from 24 to 8 gauge, with adjusting set screw. Individually bagged.	5
WTT12	Crimping tool for open barrel Weather-Pack Terminals.	1
WTT13	Extractor tool for Weather-Pack Terminals.	1
WTT14	Terminal extractor pick. Narrow blade, .050".	1
WTT15	Terminal extractor pick. Wide blade, .090".	1
WTT17	Premium crimping tool. 8" long display packaged cuts and strips primary wire 26 to 10 gauge. Crimps insulated and non-insulated terminals. Precision ground. Made in USA.	1
WTT18	Racheting terminal crimper — 8 1/2" long. Forms professional crimps on primary wire insulated terminals. Crimps connectors 22-10 gauge. Adjustable tension. Molded hand grips. Added leverage eases hand fatigue.	1
WTT27	Easy Stripper — Multi-function, self adjusting stripper with cutting and crimping actions. Cuts and strips 26-10 gauge wire. Crimps insulated and non-insulated terminals. Cushion grip handles for comfort.	1
WTT32	Crimping tool for open barrel OE Style Terminals.	1
WTT110	Pro Continuity Tester — tests circuits with power off, use to locate broken wires, bad connections, open circuits, requires 1 AA battery, not included.	1
WTT111	Pro Circuit Tester — finds open circuits, blown fuses, and bad connections. Handle illuminates when circuit is working.	1
WTT112	Continuity Tester — tests circuits with power off, use to locate broken wires, bad connections, open circuits, requires 2 AAA batteries, not included.	1
WTT113	Circuit Tester — finds open circuits, blown fuses, and bad connections. Handle illuminates when circuit is working.	1
WTT114	LED Voltage Tester — LED indicators show normal, low, or flat charge level. Magnetic base for hands-free use. Two leads, one with alligator clip, one with probe.	1
WTT115	Circuit Tester w/ Probe Hook — probe pierces insulation to contact circuit, finds open circuits, blown fuses, and bad connections. Handle illuminates when circuit is working.	1



WHY USE HEAT SHRINK TERMINALS?



CORROSION

When using a standard crimp terminal, the wire is exposed to moisture and other contaminants. Over time, the wire starts to corrode which reduces the current carrying capacity of the electrical system.



PULL-OUT

In most cases, electrical connectors must operate in adverse conditions: heat, cold, vibration, strain, etc. These conditions can cause the wire or wires to pull-out of the connector.



TECHNOLOGY

Advanced technology and computerization have resulted in OEMs designing sealed and molded components in all types of equipment. The integrity of the electrical system can be compromised when repairs are made with unsealed electrical connections.



DOWNTIME

Lighting and electrical problems are the most frequent causes of downtime when maintaining a fleet. Often these problems stem from faulty electrical connections. Equipment downtime can result in thousands of dollars in lost opportunities and repair costs.

SOLUTIONS

Adhesive-lined tubing prevents corrosion on wire.

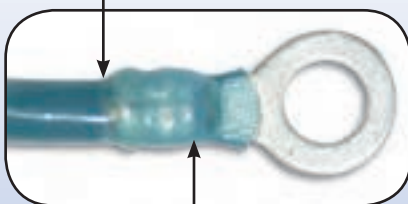

Translucent tubing allows visual inspection of installation.

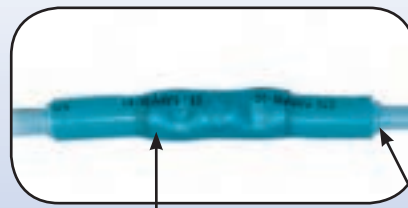

Adhesive-lined heat shrink tubing and solder combine to increase tensile strength.



Ignition Wires

Battery Cables

Primary Wire

Terminals & Connectors

Trailer Connectors

Sockets, Pigtails & Switches

Safety Accessories

O.E. Interchanges

Index

TRAILER CONNECTORS & ACCESSORIES

Standard® ... Parts For The Road...To Keep You Driving!



THE NUMBER ONE CHOICE!

STANDARD® VEHICLE TO TRAILER WIRING SYSTEM...

Wiring from vehicle to trailer was a big job, it could take hours of cutting, splicing, soldering and stripping. Not to mention getting to the original equipment wire you need to attach to. Now, the “professional installer” or a “do-it-yourself” individual can do a complete vehicle to trailer installation the easy plug in way. This modular wiring adapter is ready made to plug right into the original equipment system.

The adapters plug into a molded connector joining the car and truck body or bed wiring harness to the chassis harness to provide tail, brake and turn signal light wiring to the trailer connector.

HOOK ME UP!

On some applications you have a choice of a complete one-piece molded unit or two separate connectors. The **1-piece connector** consists of a built-in 4-pole flat extension. The advantage of the **2-piece connector** is the 4-pole extender may be replaced if damaged and the end may be interchangeable for a 6-way or 7-way connector.

If a vehicle connector is not available, use a universal converter. There are three types of converters: 4-wire flat, general purpose and power converter/isolator.

A **4-wire flat** is the most common trailer plug. A **4-wire flat** converter is used with a common bulb standard tail light system. Brake light and turn signal functions work through the same bulbs. The lens at the back of the vehicle will be completely red.

A **converter** changes the tow vehicle’s independent turn signals to the standard wiring found on trailers. Brake/tail lights and turn signal functions work through separate, independent light bulbs. A general purpose converter is designed for small trailers with 2 stop/tail lights and 4 running lights.

If the trailer has a large amount of bulbs, or to prevent damage to the converter or tow vehicle, a **power converter** or an **isolator** is recommended for guaranteed protection. A **power converter** is used to adapt the independent turn signal system found on tow vehicles to the trailer standard or common bulb system. The **power isolator** isolates the trailer lighting functions from all electronics on the vehicle including light circuits, on-board computers, anti-lock brake systems, information centers and lamp outage modules.

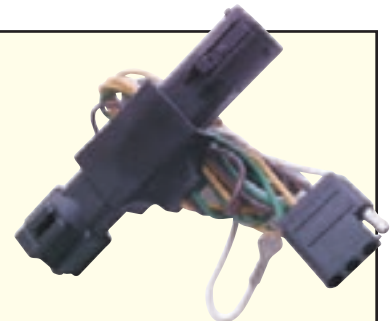

VEHICLE CONNECTORS



TRAILER CONNECTORS

Part No.	Type	Description	Illustration	Part No.	Type	Description	Illustration
TC411	Ford	Bronco1979-1973 F100 - 3501979-1973 Use with 4-wire flat extension TC427.		TC421 TC421A	Ford	Bronco1986-1980 Ranger1985 Pickup1986-1980 Use with 4-wire flat extension TC427. TC421A one piece molded unit. 36 inches long. Used for TC421 and TC427.	
TC412 TC412A	Chevrolet GMC Cadillac Full Size Pickup (old body style)	Blazer2000-1988 Escalade1999 Denali2001-1999 Jimmy1994-1992 Yukon1999-1995 Tahoe1999-1995 Suburban1999-1992 Use with 4-wire flat extension TC427. TC412A one piece molded unit. 36 inches long. Used for TC412 and TC427.		TC422 TC422A	Ford Mazda	Explorer1994-1991 Navajo1994-1991 Use with 4-wire flat extension TC427. TC422A one piece molded unit. 56 inches long. Use for TC422 and TC427.	
TC413 TC413A	Chevrolet GMC	S-10 Blazer (2 door)1991-1984 S-15 Jimmy (2 door) ...1991-1984 Use with 4-wire flat extension TC427. TC413A one piece molded unit. 74 inches long. Used for TC413 and TC427.		TC431 TC431A	Ford	Ranger1992-1986 Use with 4-wire flat extension TC427. TC431A one piece molded unit. 38 inches long. Use for TC431 and TC427.	
TC414 TC414A	Dodge	Pickup (full size)1994-1987 Cab & Chassies only2002-1995 Dakota1994-1988 Ram Charger1993-1988 Trailduster1993-1988 Use with 4-wire flat extension TC427. TC414A one piece molded unit. 44 inches long. Used for TC414 and TC427.		TC436 TC436A	Ford Mazda	Ranger1999-1993 Mazda Pickup1999-1994 Use with 4-wire flat extension TC427. TC436A one piece molded unit. 60 inches long. Use for TC436 and TC427. Includes Tail Light Converter.	
TC416 TC416A	Ford	F150/250 Light Duty1996-1987 F250/350 Heavy Duty...1997 Use with 4-wire flat extension TC427. TC416A one piece molded unit. 36 inches long. Used for TC416 and TC427.		TC437	Jeep	Cherokee1996-1991 Use with 4-wire flat extension TC427. Includes Tail Light Converter.	
TC418 TC418A	Ford	Bronco1988-1987 Use with 4-wire flat extension TC427. TC418A one piece molded unit. 38 inches long. Use for TC418 and TC427.		TC438	Toyota	Tacoma2004-1995 Pickup (except T-100) ...1994-1984 Use with 4-wire flat extension TC427. Includes Tail Light Converter.	
TC419 TC419A	Ford	Bronco1991-1989 Use with 4-wire flat extension TC427. TC419A one piece molded unit. 44 inches long. Use for TC419 and TC427.		TC439	Dodge Chrysler Plymouth Mitsubishi	Dakota2007-2004 Minivan1995-1991 Caravan/Grand Caravan ..1995-1991 Voyager/Grand Voyager. 1995-1991 Town & Country1995-1991 Pickup2007 Raider2007-2006	
TC420 TC420A	Ford	Bronco II1991-1987 Use with 4-wire flat extension TC427. TC420A one piece molded unit. 54 inches long. Use for TC420 and TC427.		TC441 TC441A	Chevrolet GMC	Blazer1984-1973 Jimmy1984-1973 Pickup1984-1968 Suburban1984-1973 Use with 4-wire flat extension TC427. TC441A one piece molded unit. 36 inches long. Use for TC441 and TC427.	

VEHICLE CONNECTORS

Part No.	Type	Description	Illustration	Part No.	Type	Description	Illustration
TC451 TC451A	Chevrolet GMC Isuzu	Blazer1991-1985 Cyclone1992-1991 Jimmy1991-1985 Pickup (full size).....1987-1985 Suburban1991-1985 S10-S15 Pickup1997-1985 Sonoma1997-1985 Hombre/Pickup1997-1996 Use with 4-wire flat extension TC427. TC412A one piece molded unit. 36 inches long. Used for TC412 and TC427.		TC470	Ford	Taurus (sedan only).....1995-1992 Use with 4-wire flat extension TC430. Includes Power Tail Light Converter for electronic protection.	
TC460	Ford Mazda	Explorer1994-1991 Navajo1994-1991 For vehicles equipped with a factory tow package.		TC472	Chevrolet GMC Oldsmobile	Astro2005-1995 Blazer2002-1995 Jimmy2001-1995 Envoy2001-1999 Safari2005-1995 Bravada.....2001-1996	
TC461	Jeep	Cherokee1982-1976 Use with 4-wire flat extension TC427.		TC473	Chrysler Dodge	Caravan.....2000-1996 Durango2003-1998 Town and Country.....2000-1996 Voyager.....2000-1996 Includes Tail Light Converter.	
TC462 TC462A	Dodge	Pickup (full size).....2003-1995 Dakota2003-1995 Use with 4-wire flat extension TC427. TC462A one piece molded unit. 52 inches long. Used for TC462 and TC427.		TC474	Jeep	Grand Cherokee1993 (mfg. 8/92-2/94) Use with 4-wire flat extension TC430. Includes Power Tail Light Converter for protection on vehicles with Lamp Outage Modules.	
TC463	Ford Mazda Mercury	Explorer2000-1995 Escape2003-2001 (without tow package) Mountaineer2000-1995 (without tow package) Tribute2003-2001 (without tow package) Use with 4-wire flat extension TC430. Includes Power Tail Light Converter for protection on vehicles with lamp outage modules.		TC475	Jeep	Grand Cherokee1994 (without tow package)1998-1995 (mfg. 3/94-1998) Use with 4-wire flat extension TC430.	
TC464	Ford	Windstar.....1998-1995 Includes Tail Light Converter. Use with 4-wire flat extension TC430.		TC476	Jeep	Grand Cherokee1998-1995 (with tow package)1998-1995 Includes Power Tail Light Converter for protection on vehicles with Lamp Outage Modules. Use with 4-wire flat extension TC430.	
TC469 TC469A	Ford	Bronco (full size)1996-1992 Use with 4-wire flat extension TC430. TC469A one piece molded unit. 54 inches long. Used for TC469 and TC430.		TC477	Acura Honda Isuzu	Accord2002-1994 (except station wagon) Element.....2004-2003 Odyssey2004-1995 Oasis.....1998-1996 Integra2001-1994 Pilot2007-2003 CRV2006-1997 CL/RL Series.....2003-1995 MDX.....2006-2001 TL.....2004-1996 Includes Tail Light Converter.	

VEHICLE CONNECTORS



TRAILER CONNECTORS

Part No.	Type	Description	Illustration	Part No.	Type	Description	Illustration
TC478	Honda Isuzu	Passport1997-1994 Rodeo1997-1992		TC490	Jeep	Wrangler1997-1981	
TC479	Acura Isuzu	SLX1999-1996 Trooper2002-1992 Includes Tail Light Converter.		TC492	Buick Chevrolet	Roadmaster Sedan1996-1990 Caprice1996-1991 Impala1996-1991	
TC482	Ford Mercury	Mustang (except Cobra)2002-1994 Crown Victoria/LTD1997-1992 Grand Marquis1997-1992 Use with 4-wire flat extension TC430. Includes Power Tail Light Converter for electronic protection.		TC494	Ford Lincoln	F1501997 (mfg. 1/96-10/96) F250 Light Duty1997 (mfg. 1/96-10/96) Expedition1999-1997 Navigator1999-1997	
TC483	Ford Mercury	Taurus1999-1996 Sable1999-1996 (sedan only) Use with 4-wire flat extension TC430. Includes Power Tail Light Converter for electronic protection.		TC495	Isuzu	Pickup1995-1989 Use with 4-wire flat extension TC427. Includes Tail Light Converter.	
TC485	Nissan	Pickup1997-1991 Use with 4-wire flat extension TC430. Includes Tail Light Converter.		TC496	Mazda	Pickup1993-1985 Use with 4-wire flat extension TC427. Includes Tail Light Converter.	
TC486	Toyota	T-100 Pickup1998-1994 Includes Tail Light Converter.		TC498	Ford Mercury	Explorer2000-1995 Ranger1999-1998 Mountaineer2001-1996 (All with tow pkg.) For vehicles equipped with a factory tow package.	
TC487	Chevrolet Buick	Caprice Wagon1996-1991 Roadmaster Wagon1996-1991		TC499 TC499A	Ford Mercury	Explorer1997-1996 Mountaineer1997-1996 Use with 4-wire flat extension TC430. TC499A one piece molded unit. 79 inches long. Used for TC499 and TC430.	
TC488	Chevrolet Pontiac Oldsmobile	Lumina APV1997-1992 Silhouette1997-1992 Transport1997-1992		TC500	Nissan Infiniti	Altima2001-1997 Pathfinder2004-1996 QX42003-1996 Includes Tail Light Converter.	
TC489	Mitsubishi	Montero1997-1991		TC501	Subaru	Forrester2007-1998 Outback2007-1996 Use with 4-wire flat extension TC430. Includes Power Tail Light Converter for electronic protection.	

VEHICLE CONNECTORS

Part No.	Type	Description	Illustration	Part No.	Type	Description	Illustration
TC502	Jeep	Cherokee2001-1997 Use with 4-wire flat extension TC430. Includes Power Tail Light Converter for vehicles electronic protection.		TC515	Jeep	Renegade2003-1998 Wrangler2004-1998 Use with 4-wire flat extension TC430.	
TC503	Toyota	4-Runner2002-1996 Includes Tail Light Converter.		TC516	Chevrolet GMC	Van (full size)1996-1987	
TC504	Chevrolet GMC Isuzu	S10/S15 Pickup2004-1998 Hombre/Pickup2000-1998 Sonoma2004-1998 Use with 4-wire flat extension TC430.		TC517	Chevrolet GMC	Express Van (full size)1999-1996 Savannah (new body)1999-1996 Use with 4-wire flat extension TC430. Includes Tail Light Converter.	
TC505	Toyota Lexus	Land Cruiser1998-1991 LX4501998-1996 Includes Tail Light Converter.		TC518	Dodge	Ram Van (full size)2000-1999	
TC506	Ford	E1502003-1995 E2502003-1995 Escort2001-1997 ZX22003-1998 (full size vans) Use with 4-wire flat extension TC430.		TC519	Chevrolet GMC Oldsmobile Cadillac	Sierra (1/2 ton) with tow package2001-2000 Silverado (1/2 ton) with tow package2004-2000 Sierra (3/4 ton)2004-2000 Silverado (3/4 ton)2004-2000 Suburban2004-2000 Tahoe2004-2000 Yukon2004-2000 Avalanche2004-2002 Trail Blazer2004-2002 Bravada2003-2002 Envoy2004-2002 Denali2004-2001 Escalade2004-2001	
TC510	Chevrolet Oldsmobile Pontiac	Venture2005-1997 Transport2000-1997 Silhouette2004-1997 Montana2005-1999 Includes Tail Light Converter.		TC520	Ford	F-1502002-1997 F-2502001-1997 (mfg. 11/96-Present)	
TC511	Toyota	RAV42000-1996		TC521	Jeep	Grand Cherokee2004-1999 Includes Power Tail Light Converter for protection on vehicles with Lamp Outage Modules. Use with 4-wire flat extension TC430.	
TC512	Toyota	Tundra2000 Includes Tail Light Converter.		TC522	Ford	F-2502001-1999 F-3502001-1999	
TC513	Nissan	Frontier Pickup2004-1998 Includes Tail Light Converter.		TC523	Ford	Windstar2003-1999 Includes Negative Input Converter. Use with 4-wire flat extension TC430.	







VEHICLE CONNECTORS



TRAILER CONNECTORS



Part No.	Type	Description	Illustration	Part No.	Type	Description	Illustration
TC524	Chevrolet GMC	Express Van (full size) ..2002-2000 Savannah (full size).....2002-2000 Includes Tail Light Converter. Use with 4-wire flat extension TC430.		TC546	Ford Lincoln Mercury	Explorer (w/tow pkg.) ..2005-2002 Mountaineer2005-2002 Aviator2005-2003	
TC525	Honda Isuzu	Passport2003-1998 Amigo2003-1998 Rodeo2003-1998 Axiom2002 Includes Tail Light Converter.		TC547	Ford	F-2502004-2002 F-3502004-2002	
TC536	Ford Mazda	Escape2004-2001 (without tow package) Tribute2004-2001 (without tow package)		TC548	Ford Mercury	Taurus Sedan2003-2000 Sable Sedan2003-2000	
TC537	Nissan	Xterra2004-2000		TC549	Toyota	Highlander2007-2001 Includes Tail Light Converter for protection on vehicles with Lamp Outage Modules.	
TC538	Toyota	RAV42005-2001 Includes Tail Light Converter.		TC551	Jeep	Liberty2005-2002 Includes Tail Light Converter for protection on vehicles with Lamp Outage Modules.	
TC539	Ford Lincoln	Expedition2002-2000 Navigator2002-2000 For vehicles equipped with a factory tow package.		TC554	Buick Cadillac Chevrolet Chrysler Dodge Ford GMC Hummer Infiniti Isuzu Lincoln Mercury Nissan Oldsmobile Saab	Provides 7RV blade and 4-wire flat towing. 9-7X2006-2005 2500/3500 (new body style) .. 2007-1999 Ascender 2006-2004 Armada 2007-2004 Aspen (w/ factory 7-way) ..2007 Avalanche 2007-2002 Aviator (w/ factory 7-way) 2006-2003 Bravada 2004-2002 Denali 2005-2001 Durango (w/ factory 7-way) 2008-2007 Envoy 2007-2002 Escalade 2007-2000 Escalade EXT 2007-2002 Excursion 2005-2000 Expedition 2007-2000 Explorer (w/ factory 7-way) .. 2007-2002 F-150 (w/ factory 7-way) . 2007-1999 F-250 (w/ factory 7-way) . 2007-1999 F-350 (w/ factory 7-way) . 2007-1999 H2 2007-2003 H2 SUT 2007-2005 H3 2007-2006 QX56 2007-2004 Mark LT 2007-2006 Mountaineer (w/ factory 7-way) 2007-2002 Navigator 2007-2000 Pickup 2500/3500 2007-1999 Rainier 2007-2004 Sierra 2008-2003 Silverado 2008-2003 Suburban 2008-2000 Tahoe 2008-2000 Titan 2007-2004 Trailblazer 2008-2002 Yukon/Yukon XL 2007-2000	
TC540	Dodge Chrysler	Caravan2003-2001 Grand Caravan2003-2001 Town & Country2003-2001 Voyager2003-2001 Grand Voyager2003-2001 Includes Tail Light Converter.					
TC542	Toyota	Sequoia2002-2001					
TC543	Toyota	Sienna2003-1998 Includes Tail Light Converter.					
TC544	Toyota	Tundra2002-2001 Includes Power Tail Light Converter for protection on vehicles with Lamp Outage Modules.					
TC545	Dodge	Ram 1500 Pickup2006-2002 Ram 2500 Pickup2006-2003 Ram 3500 Pickup2006-2003 Includes Tail Light Converter.					

VEHICLE CONNECTORS & POLE CONNECTORS

Part No.	Type	Description	Illustration	Part No.	Type	Description	Illustration
TC555	Buick	Provides 6RV blade and 4-wire flat towing.		TC556	Dodge Jeep Lincoln	7-way RV to 7-way blade.	
	Cadillac	2500/3500 (new body style).....2004-2002				Dakota2008-1998	
	Chevrolet	Armada2007-2004				RAM2008-1998	
	Ford	Ascender2006-2004				Quad Cab/Club Cab2001-1998	
	GMC	Avalanche2007-2002				Durango1999-1998	
	Hummer	Aviator (w/ factory 7-way).....2004-2003				Commando2008-2006	
	Infiniti	Bravada2004-2002				Mini Vans2003-2001	
	Isuzi	Denali2005-2001				Liberty2007-2002	
	Lincoln	Envoy2007-2002				MMC Pickup2007-2006	
	Mercury	Escalade2007-2000				Magnum/3002008-2005	
	Nissan	Escalade EXT2007-2002					
	Oldsmobile	Excursion2005-2000					
		Expedition2007-2000					
		Explorer (w/ factory 7-way)2007-2002					
		F-150 (w/ factory 7-way)2007-1999					
		F-250 HD (w/ factory 7-way)2007-1999					
		F-350 (w/ factory 7-way)2007-1999					
		H22007-2003					
		H2 SUT2007-2005					
		H32007-2006					
	Navigator2007-2000						
	Mark LT2007-2006						
	Mountaineer (w/ factory 7-way)2007-2003						
	Pickup 2500/35002007-1999						
	QX562007-2004						
	Rainier2008-2004						
	Sierra2007-2003						
	Silverado2007-2003						
	Suburban2007-2000						
	Tahoe2007-2000						
	Trailblazer2007-2002						
	Titan2007-2004						
	Yukon/Yukon XL2007-2000						
				TC558	Chevrolet GMC	Express Van (new body style)2007-2003 Savannah (new body)2007-2003	
				TC559	Buick Pontiac	Aztec2005-2001 Rendezvous2005-2002	
				TC560	Chevrolet Suzuki	Tracker2004-1998 Vitara2005-1999 Grand Vitara2005-1999	
				TC561	Hyundai	Santa Fe2006-2001	

1 POLE CONNECTORS

One pole connectors are used for farm equipment lift gates, plows and similar high current applications.

Part No.	Description	Illustration	Part No.	Description	Illustration
TC10 (Set)	<ul style="list-style-type: none"> • Universal Single Pole Trailer Connector • Accepts up to 0 gauge cable • Also sold separately, order TCP10F receptacle or TCP10MS plug with cable guard 		TC11 (Set)	<ul style="list-style-type: none"> • Universal Heavy Duty Single Pole Trailer Connector Set • Has continuous capacity of 300 amp. • Accepts up to 00 ga. wire and 2 ga. or 4 ga. ground lug adapter • Also sold separately, order TCP11F receptacle or TCP11M plug 	

POLE CONNECTORS



4 POLE CONNECTORS

Four pole round connectors are used in many of the same applications that the four-way flat is used. The pin location of each function varies so be sure to wire by function only.

Part No.	Description	Illustration	Part No.	Description	Illustration
TC41 (Set)	4-Pole Trailer Connector Set <ul style="list-style-type: none"> • Self-locking with coded sockets • Receptacle has concealed terminals • Plug has handle for ease of removing plug • Split clamp for securing cable • Accepts up to 12 ga. wire • Also sold separately, order TCP41F receptacle or TCP41M plug 		TC44	4-Pole Trailer Connector Set <ul style="list-style-type: none"> • Polarized connector for marine and trailer use • Molded interiors • Spring loaded cover holds plug in position • Die-cast plug and socket casing • Heavy brass contacts • Accepts up to 12 ga. wire • Also sold separately, order TCP44F receptacle or TCP44M plug 	
TC41S (Set)	4-Pole Trailer Connector Set <ul style="list-style-type: none"> • Self-locking with coded sockets • Receptacle has concealed terminals • Plug has handle for ease of removing plug • Plug has cable protector • Split clamp for securing Cable • Accepts up to 12 ga. wire • Also sold separately, order TCP41F receptacle or TCP41MS plug 		TC44K (Kit)	4-Pole Round Connector Kit <ul style="list-style-type: none"> • Contains plug and socket, mounting bracket, wire, splice connectors and mounting hardware 	

5 POLE CONNECTORS

Five pole round connectors are commonly found on large camping trailers, RV trailers, industrial trailers, horse trailers, and other large trailers. Additional functions provided by the five wire are electric brakes, auxiliary, back-up, etc.

Part No.	Description	Illustration	Part No.	Description	Illustration
TC51 (Set)	Universal 5-Pole Trailer Connector <ul style="list-style-type: none"> • Used with recreational vehicles • Polarized chrome plated housing • Rating: 12-24 volts, 15 amps • Also sold separately, order TCP51F receptacle or TCP51M plug 		TC51K (Kit)	5-Pole Round Connector Kit <ul style="list-style-type: none"> • Contains plug and socket, mounting bracket, wire, splice connectors and mounting hardware 	

6 POLE CONNECTORS



Six pole round connectors are used on smaller campers, horse trailers, and car trailers. Added functions provided by a six pole round are electric brakes and an auxiliary power lead.

Part No.	Description	Illustration	Part No.	Description	Illustration
TC61 (Set)	6-Pole Trailer Connector Set <ul style="list-style-type: none"> • Self-locking with coded sockets • Receptacle has concealed terminals • Plug has handle for ease of removing plug • Split clamp for securing cable • Accepts five 12 ga. wires and one 10 ga. wire • Also sold separately, order TCP61F receptacle, or TCP61M plug 		TCP62F	Universal 6-Pole Self-Locking Trailer Connector Socket <ul style="list-style-type: none"> • Used with recreational vehicles • Receptacle has concealed terminals • Split clamp for securing cable • Plastic construction 	
TC61S (Set)	6-Pole Trailer Connector Set <ul style="list-style-type: none"> • Plug has cable protector • Self-locking with coded sockets • Receptacle has concealed terminals • Split clamp for securing cable • Accepts five 12 ga. wires and one 10 ga. wire • Also sold separately, order TCP61F receptacle or TCP61MS plug 		TC62K (Kit)	6-Pole Round Connector Kit <ul style="list-style-type: none"> • Contains plug and socket, mounting bracket, wire, splice connectors and mounting hardware 	

POLE CONNECTORS

7 POLE CONNECTORS

Seven pole connectors are found mostly on the largest trailers, RV campers and industrial. Seven pole connector function provides electric brakes, auxiliary power lead and backup lights.

Part No.	Description	Illustration	Part No.	Description	Illustration
TCP77PM	Universal Heavy Duty 7-Pole Trailer Connector Plug <ul style="list-style-type: none"> Made of high impact glass-filled molded plastic for weather protection Floating pins for ease of alignment and maximum contact Will accept widest range of wire gauges from #16 to #8 ground wire Rating: 6 to 28 volts, 40 amp. 		TCP77PG	Universal 7-Pole Trailer Connector Plug <ul style="list-style-type: none"> Heavy duty, with cable guard Made of high impact glass-filled molded plastic for weather protection Will accept widest range of wire gauges from #16 to #8 ground wire Rating: 6 to 28 volts, 40 amp. Also sold separately, order TCP77M, plug or TCP77G cable guard 	
TCP77F	Universal 7-Pole Trailer Connector Set <ul style="list-style-type: none"> Conforms to federal anti-skid (FMV SS-121) requirements Used with TCP77M 		TCP78F TCP78M	Universal 7-Pole Trailer Connector Receptacle and Plug <ul style="list-style-type: none"> Corrosion resistant plated steel Used with TCP78C bracket Rating: 12-24 volts, 30 amp Sold separately 	
TCP77F-15 TCP77F-20 TCP77F-30	Trailer Connector Socket <ul style="list-style-type: none"> 7-pole with built-in replaceable 15, 20, 30 amp. circuit breakers Zinc die-cast body and cover Used with TCP77M 		TCP701F TCP701M	Universal 7-Pole Trailer Connector Receptacle and Plug <ul style="list-style-type: none"> Heavy duty weatherproof designs eliminates corrosion, poor appearance, and difficulty of removal Unique interior design incorporates vinyl inserts to seal out moisture and dirt Safety latch prevents accidental pull-away Color coded to RVI standards Detail instructions permit Used for both 6 and 7-way applications. 	
TCP77M	Universal 7-Pole Trailer Connector Plug <ul style="list-style-type: none"> Conforms to federal anti-skid (FMV SS-121) requirements Accepts six: 12 ga. wires and one 10 ga. wire Used with TCP77F; TCP77F-15, -20, -30 TCP77PF 		TC701K (Kit)	7-Pole Round Connector Kit <ul style="list-style-type: none"> Contains plug and socket, mounting bracket, wire, splice connectors and mounting hardware 	
TCP77PF	Universal 7-Pole Trailer Connector Socket <ul style="list-style-type: none"> Thermoplastic housing Will accept widest range of wire gauges from #16 to #8 ground wire Rating: 6 to 28 volts, 40 amp. 				

9 POLE CONNECTORS

Part No.	Description	Illustration
TC91 (Set)	Universal 9-Pole Heavy Duty Trailer Connector Set <ul style="list-style-type: none"> 6-24 volts Used with recreational vehicles Also sold separately. Order TCP91F receptacle or TCP91M plug 	

POLE CONNECTORS & ADAPTERS



13 POLE CONNECTORS

Part No.	Description	Illustration	Part No.	Description	Illustration
TCP713M (Plug)	Universal 13-Pole Heavy Duty Trailer Connector Receptacle <ul style="list-style-type: none"> The six small diameter contacts carry up to 25 amps and maintain multiple contact points between the plug and socket The seven standard diameter contacts are "spring grip" design with self adjusting spring band for uniform contact with J560b socket pins Contacts "float" for proper engagement with all mating sockets Surpasses SAE J560b performance standards Conforms to SAE J560b for interchangeability with seven pole sockets and plugs 		TCP713F (socket)	Universal 13-Pole Heavy Duty Trailer Connector Plug <ul style="list-style-type: none"> Rain hood extends beyond socket to protect socket interior Drain channel inside socket with five degree downward angle reduces water retention Gasket sealed door Solid brass contact pins Six crimp on connectors will mate six additional pins Wiring codes embossed on insulator 	

ADAPTERS

Adapters allow you to tow several other trailers without having to re-wire your tow vehicle.

TC44A <ul style="list-style-type: none"> 4-pole round pin type male and female pre-wired adapter kit 	TC51A <ul style="list-style-type: none"> 5-pole round pin type male and female pre-wired adapter kit 	TC61A <ul style="list-style-type: none"> 6-pole round pin type male and female pre-wired adapter kit 	TC63 <ul style="list-style-type: none"> 6-pole round pin type to 4-way flat Flexible wire design
TC72 <ul style="list-style-type: none"> 7-way RV blade type to 4-way flat adapter Flexible wire design 	TC73 <ul style="list-style-type: none"> 7-way round pin heavy duty adapter Optional harness for TC7T test kit 	TC423 <ul style="list-style-type: none"> 6-pole 4-wire flat Pre-wire adapter (Plastic) 	TC424 <ul style="list-style-type: none"> 7-pole 4-wire flat RV blade Pre-wired adapter (Plastic)
TC433 <ul style="list-style-type: none"> 4-way round pin type to 4-way flat adapter Flexible wire design 	TC456 <ul style="list-style-type: none"> 6-way round pin type to 4-way flat adapter 	TC457 <ul style="list-style-type: none"> 7-way RV blade type to 4-way flat adapter 	TC458 <ul style="list-style-type: none"> 7-way round pin type to 4-way flat adapter

ADAPTERS & POWER ADAPTERS

ADAPTERS

Adapters allow you to tow several other trailers without having to re-wire your tow vehicle.



TC459
• 7-way blade round to 6-pin round adapter



TC497
• 4-wire flat knockout adapter
(For use w/ 1.25" hole diameter)



TC534
• 6-pole round to 4-way flat
• Pre-wired adapter (Metal)



TC535
• 7-pole RV blade to 4-wire flat
• Pre-wired adapter (Metal)



TC541
• 4-wire flat to 4-wire and 7 RV round



TC556
• 7-way RV blade to 8-way blade plug



TC562
• 6-way round to 4-wire flat
(Includes function testing leds)



TC563
• 7-way RV blade to 4-wire flat
(Includes function testing leds)



TC564
• 7-way RV blade to both 6-round and 4-wire flat
• Center pin electric brake
(Center pin can be switched to auxiliary)



TC565
• 7-RV to 6-round
• Center pin - Auxiliary
(Center pin can be switched to electric brake)



TC568
• 7-RV blade to 5-flat



TC569
• 7-pole RV blade to 7-pole pin type

POWER ADAPTERS

Plug-in 12 volt power adapter supplies 12 volt power from your trailer receptacle. Adapts the trailer connector at the rear of the vehicle to a cigarette lighter plug receptacle. Use for spot lights, car vacuums, electric coolers, air compressors, tailgate parties and more.



TC65
• 6-pole round



TC75
• 7-pole round RV adapter



TC76
• 7-pole pin round

ELECTRONIC BRAKE CONTROL



Electronic trailer brake control for 2 and 4 brake systems. Fits RV'S, Horse, Utility and any trailer with electric brakes. This device controls inertia-activated braking for safe stops. Separate slide controls adjust braking action for different loads. Flexible mounting options and easy to use features. Easy installation includes all mounting hardware. Green lights indicate trailer brakes are connected. The green light changes to red as power to trailer brakes increases.



- TC507**
Brake Control Adapter
Ford/Mercury with tow package
- Excursion.....2008-2003
 - Expedition.....2008-1997
 - Explorer.....2008-2002
 - F-150.....2008-1994
 - F-250/F-350.....2004-1994
 - Mountaineer.....2004
 - Van (full size).....1998-1994
 - Windstar.....2003-1995



- TC508**
Brake Control Adapter
Ford with tow package
- F-Series Pickup.....1993-1992



- TC526**
Brake Control Adapter
Dodge with tow package only
- Ram Full Size Pickup.....2008-1997
 - Durango.....2008-1998



- TC527**
Brake Control Connector
CHEVY/GMC/CADILLAC with tow package
- Denali.....2002-2000
 - Escalade.....2002-2000
 - Sierra.....2002-2000
 - Silverado.....2002-1999
 - Suburban.....2002-2000
 - Tahoe.....2002-2000
 - Yukon.....2002-2000



- TC553**
Electronic Brake Control Brake Control Adapter
CHEVY/GMC
- Avalanche.....2006-2002
 - Denali.....2006-2000
 - Escalade.....2006-2000
 - Hummer H2.....2006-2003
 - Sierra.....2006-1999
 - Silverado.....2006-1999
 - Suburban.....2006-2000
 - Tahoe.....2006-2000
 - Yukon.....2006-2000













- TC600**
Electronic Brake Control
 • Bracket and hardware included

TRAILER CONNECTORS

TRAILER CONNECTOR CONVERTERS

Converters

Universal Converters are designed for vehicles that are not equipped with factory tail light plugs. Power tail light converters completely isolate the tow vehicle from any trailer malfunctions. Power is taken directly from the battery for isolation and brighter tail lights. Each unit can power up to two sets of stop/turn signals on the trailer.

Part No.	Description	Illustration	Part No.	Description	Illustration
TC52	<ul style="list-style-type: none"> • 12 volt negative ground • For all domestic and import cars with separate stop and turn lamps • Converts trailer lights on vehicles with amber turn signals • Complete kit 		TC453	<ul style="list-style-type: none"> • Protects electrical system from self destruction caused by dead shorts from water or wire wear • SMART switch included • CAUTION: You may need TC432 for guaranteed protection. This is for vehicles not designed to handle the additional load created by a trailer-in-tow 	
TC428	<ul style="list-style-type: none"> • Can be used with all cars/trucks/vans with AMBER rear turn signals or with separate bulbs for turn signals and brake lights • Use with 4-wire flat extension TC427 		TC454	<ul style="list-style-type: none"> • Protects sensitive vehicle electrical systems from failure caused by trailer lighting malfunctions 	
TC432	<ul style="list-style-type: none"> • Includes power converter with circuit guardian • Circuit guardian provides protection for vehicles with highly sensitive on-board computers 		TC466	<ul style="list-style-type: none"> • General purpose converter • Tail light converter with (60") input wires • Molded Terminals • For use on cars, vans and trucks with rear AMBER turn signals or with separate bulb for turn signals and lights 	
TC434	<ul style="list-style-type: none"> • T-connector (single plug) • Can be used with all cars/trucks/vans with RED rear turn signal or with "common" bulbs for turn signals and brake lights 		TC528	<ul style="list-style-type: none"> • For Vehicle-To-Vehicle towing. Used on vehicles with common or separate bulbs for the brake lights and turn signals 	
TC452	<ul style="list-style-type: none"> • General purpose converter • CAUTION: You may need TC432 for guaranteed protection. This is for vehicles not designed to handle the additional load created by a trailer-in-tow 		TC550	<ul style="list-style-type: none"> • Short-Proof Power Tail Light Converter • Short Circuit protected • Can power up to 8.0 amps per output • Protects tow vehicle electronics and itself from wiring shorts • Self-resetting 	

2-WIRE CONNECTORS



TC23

2-Prong Molded Trailer Connector

- 18 gauge pigtails for boats, trailers, etc.
- Requires a single circuit connection
- Plug and receptacle are not sold separately



TC23P

2-Pole Universal Holder Plug & Receptacle Connector

- Weather resistant protective sleeve
- 18 gauge pigtails
- Plug and receptacle are not sold separately

TRAILER CONNECTORS



3-WIRE CONNECTORS

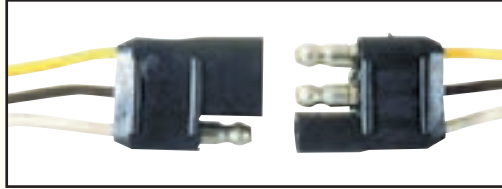

TC30
3-Pole Molded Trailer Connector
 • 18 gauge pigtails for boats, trailers, etc.
 • Plug and receptacle are not sold separately

4-WIRE CONNECTORS

Four wire flat connectors are the most popular trailer plugs available. These plugs are used on small boats, utility, jet ski, snowmobile and/or small campers trailers where right turn/brake, left turn/brake, tail/marker lights and ground are needed.



TC45
12" Tow Vehicle End and 12" Trailer End Set
 (Includes 6 quick splice connectors)



TC45H
29 ft. 4-Wire Flat Connector Extension
 (Includes 6 splice connectors)



TC46
Universal 4-Pole Square Type Connector
 • 12" leads

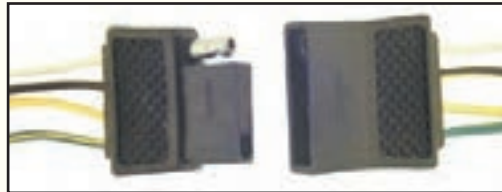

TC48
48" Tow Vehicle End and 12" Trailer End Set



TC427
3 ft. Long 4-Wire Trailer Extension
 • Uses vehicle frame ground
 • Includes serrated edge ring terminal



TC430
4 ft. Long 4-Wire Trailer Extension
 • Passes through vehicle-ground
 • Color center bonded wire



TC481
48" Trailer End

TRAILER CONNECTORS

4-WIRE CONNECTORS (continued)



TC529
12" Tow Vehicle End
(include 3 splice connectors)



TC530
48" Tow Vehicle End



TC531
4-Wire Flat Tow Vehicle
• End knockout connector
(For use w/1.25" hole diameter)



TC532
12" Trailer End



TC533
10 ft. 4-Wire Flat Extension
• Ideal for 5th wheel trailers



TC552
48" Tow Vehicle End and 20 ft. Trailer End Y-Harness
• Wishbone design includes 3 splice connectors

5-WIRE CONNECTORS



TC50
Universal 5-Pole Trailer Connector
• Used for vehicles using separate stop light and Directional lamps
• Plug and receptacle are not sold separately

6-WIRE CONNECTORS



TC62
Universal 6-Pole Trailer Connector
• Used for trailer requiring a six-circuit connection such as electric brakes

IN-LINE CONNECTORS



TC20 (Set)
2-Pole Trailer Connector
• Hard rubber body, soft rubber end caps
• All brass, metal components, polarized
• Accepts up to 12 ga. wire



TC42 (Set)
4-Pole Trailer Connector
• Hard rubber body, soft rubber end caps
• All brass, metal components, polarized
• Accepts up to 12 ga. wire

TRAILER CONNECTOR BRACKETS



TRAILER CONNECTOR BRACKETS

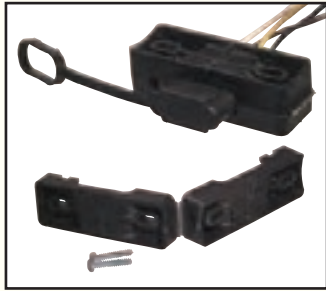

TCP45C
Vehicle Mounting Bracket
 • Used to mount 4-wire trailers



TCP62C
Universal Trailer Connector Bracket
 • 4, 5, 6-Pole mounting bracket
 • Heavy gauge cadmium plated steel trailer connector bracket



TCP78C
Universal Trailer Connector Bracket
 • 7, 9-Pole mounting bracket
 • Corrosion-resistant plated steel

MISCELLANEOUS



TCP77B
Universal Trailer Connector Socket Boot
 • Weatherproof housing
 • Used with TCP77F

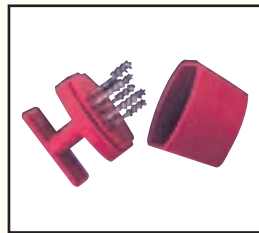

TC1
Trailer Cable Connector Cleaner - 7-Pin
 • Push/pull into plug holes, to clean electrical contact areas
 • Easy grip handle
 • Self cover for storage
 • Sturdy construction



TC7T
Economy Circuit Tester
 • Economy tester finds open circuits, blown fuses, connections quickly and easily. Test lead with alligator clip included



TC8T
Tow Doctor Vehicle Wire Harness Test Kit
 • Tests all tow vehicle functions
 • Adapts to 4-way flat, 6-way round, 7-way RV blade and 7-way heavy duty pin
 • Heavy Duty, 20' extension cord
 • Attractive durable storage case



TC455
Trailer Connector Sto-Box
 • Stores and protects 4-way flat trailer connectors from weather and corrosion
 • Connects directly onto bumper
 • Installation looks neat and professional



TC468
T-Connector
 • LED 4-pole trailer connector tester



TC509
Trailer Wiring Circuit Breaker
 • Protect vehicle from costly circuit or overload damage
 • Indicator lights pinpoint location of short

APPLICATION GUIDE

Vehicle Make/Model	Year	Vehicle Connector	4-Wire Flat	Vehicle Connection Assembly	Universal Converters	Code	Vehicle Make/Model	Year	Vehicle Connector	4-Wire Flat	Vehicle Connection Assembly	Universal Converters	Code
Acura							Regal	04-74	N/A	TC427	N/A	TC434	A
CL	03-97	TC477	NR	N/A	TC432/TC453	B	Rendezvous	07-02	TC559	NR	N/A	TC434	A
Integra	01-94	TC477	NR	N/A	TC428/TC466	B	Riviera	98-86	N/A	TC430	N/A	TC432/TC453	C
Integra	93-86	N/A	TC427	N/A	TC428/TC466	B	Riviera	85-74	N/A	TC427	N/A	TC428/TC466	B
Legend	95-86	N/A	TC430	N/A	TC432/TC453	C	Roadmaster (sedan)	96-91	TC492	NR	N/A	TC434	A
NSX	00-91	N/A	TC430	N/A	TC432/TC453	C	Roadmaster (wagon)	96-91	TC487	TC427	N/A	TC434	A
MDX	06-01	TC477	NR	N/A	TC428/TC466	B	Skyhawk	89-75	N/A	TC427	N/A	TC434	A
RL	03-96	TC477	NR	N/A	TC428/TC466	B	Skylark/Somerset	97-75	N/A	TC427	N/A	TC434	A
SLX	99-96	TC479	NR	N/A	TC428/TC466	B	Terraza	07-05	N/A	TC427	N/A	TC434	A
TL	04-96	TC477	NR	N/A	TC428/TC466	B	Cadillac						
TL	95	N/A	TC430	N/A	TC428/TC466	B	Allante	93-87	N/A	TC430	N/A	TC432/TC453	C
Vigor	94-92	N/A	TC430	N/A	TC432/TC453	C	Calais	84-75	N/A	TC430	N/A	TC432/TC453	C
American Motors							Catera	01-97	N/A	TC430	N/A	TC432/TC453	C
Alliance	87-83	N/A	TC427	N/A	TC428/TC466	B	Cimarron	88-82	N/A	TC427	N/A	TC428/TC466	B
AMX	82-77	N/A	TC427	N/A	TC428/TC466	B	CTS	04-03	N/A	TC427	N/A	TC432/TC453	C
Concord	87-83	N/A	TC427	N/A	TC428/TC466	B	DeVille	00-75	N/A	TC430	N/A	TC432/TC453	C
Eagle	88-80	N/A	TC427	N/A	TC428/TC466	B	Eldorado	00-79	N/A	TC430	N/A	TC432/TC453	C
Matador	78-75	N/A	TC427	N/A	TC434	A	Escalade (provides 6-way or 7RV blade and 4-way towing)	08-01	TC554 or TC555	NR	N/A	TC434	A
Pacer	80-78	N/A	TC427	N/A	TC434	A	Escalade	04-01	TC519	TC427	N/A	TC434	A
Spirit	83-79	N/A	TC427	N/A	TC434	A	Escalade EXT	04-02	TC519	TC427	N/A	TC434	A
Audi							Escalade	00	TC424 <217>	TC427	N/A	TC457 <218>
All models	07-85	N/A	TC430	N/A	TC432/TC453	C	Escalade	99	TC412	TC427	TC412A	TC434	A
BMW							Fleetwood	96-75	N/A	TC430	N/A	TC432/TC453	C
All models	07-85	N/A	TC430	N/A	TC432/TC453	C	Seville	05-98	N/A	TC427	N/A	TC428/TC466	B
Buick							Seville	97-75	N/A	TC430	N/A	TC432/TC453	C
Apollo	75	N/A	TC427	N/A	TC434	A	Chevrolet (includes GEO)						
Century	05-82	N/A	TC427	N/A	TC434	A	Astro	05-95	TC472	TC427	N/A	TC434	A
Century	81-78	N/A	TC427	N/A	TC428/TC466	B	Astro	94-85	N/A	TC427	N/A	TC434	A
Century	77-75	N/A	TC427	N/A	TC434	A	Avalanche (provides 6-way or 7RV blade and 4-way towing)	07-02	TC554 or TC555	NR	N/A	TC434	A
Electra (including Park Avenue)	04-85	N/A	TC430	N/A	TC432/TC453	C	Avalanche	04-02	TC519	TC427	N/A	TC434	A
Enclave	08	TC554 or TC555	NR	N/A	TC434	Beretta	96-88	N/A	TC427	N/A	TC434	A
Electra (including Park Avenue)	84-71	N/A	TC427	N/A	TC434	A	Blazer (ST Series)	02-95	TC472	TC427	N/A	TC434	A
Estate Wagon	96-71	N/A	TC427	N/A	TC434	A	Blazer (full size)	94-92	TC412	TC427	TC412A	TC434	A
Le Sabre	04-90	N/A	TC427	N/A	TC434	A	Blazer (ST Series) (2-door)	94-92	N/A	TC427	N/A	TC434	A
Le Sabre	89-86	N/A	TC430	N/A	TC432/TC453	C	Blazer (ST Series) (4-door)	94-91	N/A	TC427	N/A	TC434	A
Le Sabre	85-75	N/A	TC427	N/A	TC434	A							
Opel	79-76	N/A	TC430	N/A	TC432/TC453	C							
Rainer	07-04	TC554 or TC555	NR	N/A	TC434							

CHART CODES

- A. 4-Wire Flat
- B. General Purpose Converters
- C. Power Converters

- 217. Vehicle Connector (TC457 also required to service this application)
- 218. Plug Converter (TC424 also required to service this application)
- Note: See Buyers guide for full description and addition link options

APPLICATION GUIDE



Vehicle Make/Model	Year	Vehicle Connector	4-Wire Flat	Vehicle Connection Assembly	Universal Converters	Code	Vehicle Make/Model	Year	Vehicle Connector	4-Wire Flat	Vehicle Connection Assembly	Universal Converters	Code
Blazer (full size)	91-85	TC451	TC427	TC451A	TC434	A	Old Body Style 3/4 ton	00-99	TC412	TC427	TC412A	TC434	A
Blazer (ST Series, 2dr)	91-84	TC413	TC427	TC413A	TC434	A							
Blazer (full size)	84-73	TC441	TC427	TC441A	TC434	A	New Body Style 3/4 ton	04-00	TC519	TC427	N/A	TC434	A
Camaro	02-78	N/A	TC427	N/A	TC428/TC466	B	Pickup (full size)	98-88	TC412	TC427	TC412A	TC434	A
Camaro	77-75	N/A	TC427	N/A	TC434	A	Pickup (full size)	87-85	TC451	TC427	TC451A	TC434	A
Caprice (sedan)	96-91	TC492	NR	N/A	TC434	A	Pickup - including Dual Wheel (full size)	84-75	TC441	TC427	TC441A	TC434	A
Caprice (wagon)	96-91	TC487	NR	N/A	NR							
Caprice/Bel Air	90-75	N/A	TC427	N/A	TC434	A							
Cavalier	03-88	N/A	TC427	N/A	TC434	A	S-10 Pickup	03-98	TC504	TC430	N/A	TC434	A
Cavalier	87-82	N/A	TC427	N/A	TC428/TC466	B	Silverado (New Body Style) - 3/4 ton	01-99	TC519	TC427	N/A	TC434	A
Celebrity	90-85	N/A	TC427	N/A	TC434	A							
Celebrity	84-82	N/A	TC427	N/A	TC428/TC466	B	Silverado (1500/2500 with tow package)	04-00	TC519	TC427	N/A	TC434	A
Chevelle/Malibu	83-75	N/A	TC427	N/A	TC434	A							
Cobalt	08-05	N/A	TC427	N/A	TC434	A	Silverado (1500 w/o tow package)	04-03	TC519	TC427	N/A	TC434	A
Corsica	96-87	N/A	TC427	N/A	TC434	A							
Corvette	01-75	N/A	TC430	N/A	TC432/TC453	C	Silverado (2500 w/o tow package)	04-00	TC519	TC427	N/A	TC434	A
Corvette	04-03	N/A	TC427	N/A	TC434	A	Silverado	08-03	TC554 or TC555	NR	N/A	TC434
El Camino	87-75	N/A	TC427	N/A	TC434	A	Spectrum	96-87	N/A	TC430	N/A	TC432/TC453	C
Express Van	07-03	TC558	NR	N/A	TC428/TC466	B	Storm	96-90	N/A	TC430	N/A	TC432/TC453	C
Express Van (full size)	02-00	TC524	TC427	N/A	TC434	A	Suburban	07-00	TC554 or TC555	NR	N/A	TC434	A
Express Van (full size)	99-96	TC517	TC427	N/A	TC428/TC466	B	(provides 6-way or 7RV blade and 4-way towing)						
Impala	03-99	N/A	TC427	N/A	TC434	A	Suburban	04-00	TC519	TC427	N/A	TC434	A
Impala	96-94	TC492	NR	N/A	NR							
Impala	83-75	N/A	TC427	N/A	TC434	A	Suburban	99-92	TC412	TC427	TC412A	TC434	A
Lumina (sedan)	99-90	N/A	TC427	N/A	TC434	A	Suburban	91-85	TC451	TC427	TC451A	TC434	A
Lumina APV	96-93	TC488	NR	N/A	NR	Suburban	84-73	TC441	TC427	TC441A	TC434	A
Lumina APV	92-90	N/A	TC427	N/A	TC434	A	Syclone (ST Series)	92-91	TC451	TC427	TC451A	TC434	A
Malibu	08-97	N/A	TC427	N/A	TC428/TC466	B	Tahoe (provides 6-way or 7RV blade and 4-way towing)	08-00	TC554 or TC555	NR	N/A	TC434	A
Malibu	83-75	N/A	TC427	N/A	TC434	A							
Metro	00-89	N/A	TC430	N/A	TC432/TC453	C	Tahoe	07-00	TC519	TC427	N/A	TC434	A
Monte Carlo	06-00	N/A	TC427	N/A	TC428/TC466	B	Tahoe	99-95	TC412	TC427	TC412A	TC434	A
Monte Carlo	99-95	N/A	TC427	N/A	TC434	A	Tracker	04-99	TC560	NR	N/A	TC428/TC466	B
Monte Carlo	88-75	N/A	TC427	N/A	TC434	A	Tracker	98-89	N/A	TC427	N/A	TC428/TC466	B
Monza	80-75	N/A	TC427	N/A	TC434	A	Trailblazer ST Series (provides 6-way or 7RV blade and 4-way towing)	07-02	TC554 or TC555	NR	N/A	TC434	A
Nova	88-85	N/A	TC430	N/A	TC432/TC453	C							
Nova	79-75	N/A	TC427	N/A	TC434	A	Trailblazer	04-02	TC519	TC427	N/A	TC434	A
Prizm	99-90	N/A	TC427	N/A	TC428/TC466	B							
Pickup (full size) New Body Style, 1/2 ton	00-99	TC424<217>	TC427	N/A	TC457<218>							

CHART CODES

A. 4-Wire Flat

B. General Purpose Converters

C. Power Converters

217. Vehicle Connector (TC457 also required to service this application)

218. Plug Converter (TC424 also required to service this application)

Note: See Buyers guide for full description and additional link options

APPLICATION GUIDE

Vehicle Make/Model	Year	Vehicle Connector	4-Wire Flat	Vehicle Connection Assembly	Universal Converters	Code	Vehicle Make/Model	Year	Vehicle Connector	4-Wire Flat	Vehicle Connection Assembly	Universal Converters	Code
Van (full size except Express)	96-87	TC516	TC427	N/A		A	Caravan	95-91	TC439	TC427	N/A	TC434	A
Van (full size)	86-78	N/A	TC427	N/A		A	Caravan	90-84	N/A	TC427	N/A	TC434	A
Van	77-75	N/A	TC427	N/A	TC434	A	Challenger	83-81	N/A	TC427	N/A	TC428/TC466	B
Venture	05-97	TC510	TC427	N/A	TC428/TC466	B	Challenger	81-76	N/A	TC427	N/A	TC434	A
Chrysler							Charger	87-75	N/A	TC427	N/A	TC434	A
300C	07-05	N/A	TC430	N/A	TC432/TC453	C	Colt	95-75	N/A	TC427	N/A	TC428/TC466	B
300M	00-99	N/A	TC430	N/A	TC432/TC453	C	Diplomat	89-77	N/A	TC427	N/A	TC434	A
Cirrus	00-95	N/A	TC430	N/A	TC432/TC453	C	Durango	03-98	TC473	NR	N/A	TC428/TC466	B
Concorde	04-93	N/A	TC430	N/A	TC432/TC453	C	Dynasty	93-88	N/A	TC427	N/A	TC434	A
Cordoba	83-80	N/A	TC427	N/A	TC434	A	Grand Caravan	03-01	TC540	NR	N/A	TC428/TC466	B
Crossfire	06-04	N/A	TC430	N/A	TC432/TC453	C	Grand Caravan	00-96	TC473	NR	N/A	TC428/TC466	B
E-Class	84-83	N/A	TC427	N/A	TC434	A	Grand Caravan	95-91	TC439	TC427	N/A	TC434	A
Fifth Avenue (rear wheel drive)	89-82	N/A	TC427	N/A	TC434	A	Grand Caravan	90-84	N/A	TC427	N/A	TC434	A
Imperial	93-84	N/A	TC430	N/A	TC432/TC453	C	Intrepid	04-93	N/A	TC430	N/A	TC432/TC453	C
Imperial	83-75	N/A	TC427	N/A	TC434	A	Lancer	89-85	N/A	TC427	N/A	TC434	A
Laser	86-84	N/A	TC430	N/A	TC432/TC453	C	Mirada	83-80	N/A	TC427	N/A	TC434	A
LeBaron	95-90	N/A	TC430	N/A	TC432/TC453	C	Neon	03-95	N/A	TC427	N/A	TC434	A
LeBaron	89-77	N/A	TC427	N/A	TC434	A	Omni	90-78	N/A	TC427	N/A	TC434	A
LHS	00-94	N/A	TC430	N/A	TC432/TC453	C	Raider	89-87	N/A	TC427	N/A	TC428/TC466	B
New Yorker	96-88	N/A	TC430	N/A	TC432/TC453	C	Rampage	84-82	N/A	TC427	N/A	TC434	A
New Yorker	87-75	N/A	TC427	N/A	TC434	A	Scamp	83	N/A	TC427	N/A	TC434	A
Pacifica	08-03	N/A	TC430	N/A	TC432/TC453	C	Shadow	94-87	N/A	TC427	N/A	TC434	A
Sebring	08-02	N/A	TC427	N/A	TC428/TC466	B	Spirit	95-89	N/A	TC430	N/A	TC432/TC453	C
Town & Country	03-01	TC540	NR	N/A	TC428/TC466	B	Stealth	96-91	N/A	TC430	N/A	TC432/TC453	C
Town & Country	00-96	TC473	TC427	N/A	TC428/TC466	B	Stratus	99-98	N/A	TC430	N/A	TC432/TC453	C
Town & Country	95-91	TC439	TC427	N/A	TC434	A	Stratus	07-95	N/A	TC430	N/A	TC432/TC453	C
Town & Country	90-84	N/A	TC427	N/A	TC434	A	Viper	00-93	N/A	TC430	N/A	TC432/TC453	C
Daihatsu							Vista	91-84	N/A	TC427	N/A	TC428/TC466	B
Charade	93-89	N/A	TC427	N/A	TC428/TC466		Dodge Trucks						
Rocky	94-90	N/A	TC427	N/A	TC428/TC466		Arrow Pickup	83-79	N/A	TC427	N/A	TC428/TC466	B
Dodge							B Series (full size van)	00-99	TC518	TC427	N/A	TC434	A
400	83-82	N/A	TC427	N/A	TC434	A	B Series (full size van)	98-93	TC465	TC427	N/A	TC434	A
600	88-83	N/A	TC427	N/A	TC434	A	B Series (full size van)	92-75	N/A	TC427	N/A	TC434	A
Aries	89-81	N/A	TC427	N/A	TC434	A	Caravan	03-01	TC540	NR	N/A	TC428/TC466	B
Aspen	80-76	N/A	TC427	N/A	TC434	A	Caravan	00-96	TC473	TC427	N/A	TC428/TC466	B
Avenger	00-95	N/A	TC430	N/A	TC432/TC453	C	Caravan	95-91	TC439	TC427	N/A	TC434	A
Caravan	03-01	TC540	NR	N/A	TC428/TC466	B							
Caravan	00-96	TC473	NR	N/A	TC428/TC466	B							

CHART CODES

- A. 4-Wire Flat
- B. General Purpose Converters
- C. Power Converters

- 217. Vehicle Connector (TC457 also required to service this application)
 - 218. Plug Converter (TC424 also required to service this application)
- Note: See Buyers guide for full description and addition link options*

APPLICATION GUIDE



Vehicle Make/Model	Year	Vehicle Connector	4-Wire Flat	Vehicle Connection Assembly	Universal Converters	Code	Vehicle Make/Model	Year	Vehicle Connector	4-Wire Flat	Vehicle Connection Assembly	Universal Converters	Code
Caravan	90-84	N/A	TC427	N/A	TC434	A	Crown Victoria/LTD	03-98	N/A	TC427	N/A	TC428/TC466	B
D Series/W Series (Pickup full size)	93-87	TC414	TC427	TC414A	TC434	A	Crown Victoria/LTD	97-94	TC482	TC430	N/A	TC432/TC453	C
D Series/W Series (Ram Pickup)	86-76	N/A	TC427	N/A	TC434	A	Crown Victoria/LTD	93-83	N/A	TC430	N/A	TC432/TC453	C
Dakota	01-95	TC462	TC427	TC462A	TC434	A	Crown Victoria/LTD	82-75	N/A	TC427	N/A	TC434	A
Dakota	94-88	TC414	TC427	TC414A	TC434	A	Escort (sedan)	03-97	TC506	TC430	N/A	TC434	A
Dakota	87	N/A	TC427	N/A	TC434	A	Escort (wagon)	99-97	N/A	TC427	N/A	TC428/TC466	B
Grand Caravan	03-01	TC540	NR	N/A	TC428/TC466	B	Escort	96-81	N/A	TC430	N/A	TC432/TC453	C
Durango	07	TC554	EXP	88-82	N/A	TC430	N/A	TC432/TC453	C
Durango	03-98	TC473	TC427	N/A	TC428/TC466	B	Fairmont/Futura	83-78	N/A	TC427	N/A	TC434	A
Grand Caravan	00-96	TC473	TC427	N/A	TC428/TC466	B	Festiva	93-88	N/A	TC427	N/A	TC428/TC466	B
Grand Caravan	95-91	TC439	TC427	N/A	TC434	A	Focus	00	N/A	TC430	N/A	TC432/TC453	C
Grand Caravan	90-84	N/A	TC427	N/A	TC434	A	Granada	82-75	N/A	TC427	N/A	TC428/TC466	B
Ram Pickup 1500	06-02	TC545	NR	N/A	TC428/TC466	B	LTD II	79-77	N/A	TC427	N/A	TC434	A
Ram Pickup 2500	06-03	TC545	NR	N/A	TC428/TC466	B	Mustang (Cobra only)	00-99	N/A	TC427	N/A	TC428/TC466	B
Ram Pickup 3500 (except Chassis Cab)	06-03	TC545	NR	N/A	TC428/TC466	B	Mustang (except Cobra)	04-94	TC482	TC430	N/A	TC432/TC453	C
Ram Pickup (Cab & Chassis only)	02-87	TC414	TC427	TC414A	TC434	A	Mustang	93-87	N/A	TC430	N/A	TC432/TC453	C
Ram Pickup 2500	02-94	TC462	TC427	TC462A	TC434	A	Mustang	86-75	N/A	TC427	N/A	TC434	A
Ram Pickup 3500 (except Chassis Cab)	02-94	TC462	TC427	TC462A	TC434	A	Pinto	80-75	N/A	TC427	N/A	TC434	A
Ramcharger	93-88	TC414	TC427	TC414A	TC434	A	Probe	97-89	N/A	TC430	N/A	TC432/TC453	C
Ramcharger	87-75	N/A	TC427	N/A	TC434	A	Taurus (sedan)	03-00	TC548	NR	N/A	TC428/TC466	B
Rampage	84-82	N/A	TC427	N/A	TC434	A	Taurus (wagon)	01-96	N/A	TC430	N/A	TC432/TC453	C
Ram 50	93	N/A	TC427	N/A	TC466/TC428	A	Taurus (sedan)	99-96	TC483	TC430	N/A	TC432/TC453	C
Ram 50	92-79	N/A	TC427	N/A	TC428/TC466	B	Taurus (sedan)	95-92	TC470	TC430	N/A	TC432/TC453	C
Trailduster	93-88	TC414	TC427	TC414A	TC434	A	Taurus (wagon)	95-86	N/A	TC427	N/A	TC434	A
Trailduster	87-75	N/A	TC427	N/A	TC434	A	Taurus (sedan)	91-87	N/A	TC430	N/A	TC432/TC453	C
Voyager	03-01	TC540	NR	N/A	TC428/TC466	B	Tempo	94-84	N/A	TC430	N/A	TC432/TC453	C
Voyager	00-96	TC473	TC427	N/A	TC428/TC466	B	E Series - E150, E250	03-95	TC506	NR	N/A	TC434	A
Voyager	95-91	TC439	TC427	N/A	TC434	A	Thunderbird	97-83	N/A	TC430	N/A	TC432/TC453	C
Voyager	90-84	N/A	TC427	N/A	TC434	A	Thunderbird	82-74	N/A	TC427	N/A	TC434	A
Eagle							Torino	76-75	N/A	TC427	N/A	TC434	A
Summit	96-89	N/A	TC427	N/A	TC428/TC466	B	Windstar	00-99	TC523	N/A	N/A	N/A	
Talon	96-92	N/A	TC430	N/A	TC432/TC453	C	Windstar	98-95	TC464	TC427	N/A	TC428/TC466	B
Talon	91-90	N/A	TC427	N/A	TC434	A	ZX2 -Sedan	03-98	TC506	TC430	N/A	TC434	A
Vision	96-93	N/A	TC430	N/A	TC432/TC453	C	Ford Trucks						
Ford							Aerostar	97	TC506	NR	N/A	TC434	A
Aspire	97-94	N/A	TC430	N/A	TC432/TC453	C	Aerostar	96-86	N/A	TC427	N/A	TC428/TC466	B
Contour	00-95	N/A	TC430	N/A	TC432/TC453	C	Bronco	96-92	TC469	TC430	TC469A	TC434	A

CHART CODES

A. 4-Wire Flat

B. General Purpose Converters

C. Power Converters

217. Vehicle Connector (TC457 also required to service this application)

218. Plug Converter (TC424 also required to service this application)

Note: See Buyers guide for full description and addition link options

APPLICATION GUIDE

Vehicle Make/Model	Year	Vehicle Connector	4-Wire Flat	Vehicle Connection Assembly	Universal Converters	Code	Vehicle Make/Model	Year	Vehicle Connector	4-Wire Flat	Vehicle Connection Assembly	Universal Converters	Code
Bronco	91-89	TC419	TC427	TC419A	TC434	A	F Series - F250 Light Duty	03-98	TC520	NR	N/A	TC434	A
Bronco	88-87	TC418	TC427	TC418A	TC434	A							
Bronco	86-81	TC421	TC427	TC421A	TC434	A	F Series - F150 mfg. 10/96 - present	03-97	TC520	NR	N/A	TC434	A
Bronco	80	N/A	TC427	N/A	TC434	A							
Bronco	79-73	TC411	TC427	N/A	TC434	A	F Series - F250, F350 Heavy Duty	97	TC416	TC427	TC416A	TC434	A
Bronco II	90-87	TC420	TC427	TC420A	TC434	A							
Bronco II	86-84	N/A	TC427	N/A	TC434	A	F150 - tow pkg. 1/96-10/96 replacement adaptor - mfg.	97	TC494	NR	N/A	TC434	A
Escape (w/o tow package)	03-01	TC463	TC430	N/A	TC432/TC453	C							
Escape (w/ tow package)	04-01	TC536	NR	N/A	TC434	A	F250 - tow pkg. replacement adaptor - light duty	97	TC494	NR	N/A	TC434	A
E Series - E150, E250	03-95	TC506	NR	N/A	TC434	A							
E Series - E150/350	94-92	N/A	TC427	N/A	TC428/TC466	B	F Series - F150/F350	96-87	TC416	TC427	TC416A	TC434	A
E Series - E150/350	91-75	N/A	TC427	N/A	TC434	A	F Series - F150/F350	86-80	TC421	TC427	TC421A	TC434	A
Excursion (provides 6-way or 7RV blade and 4-way towing)	05-00	TC554 or TC555	NR	N/A	TC434	A	F Series	79-75	TC411	TC427	N/A	TC434	A
							Focus (except sedan)	03	N/A	TC427	N/A	TC434	A
							Focus (sedan)	03-00	N/A	TC427	N/A	TC428/TC466	B
							Ranger	03-00	N/A	TC427	N/A	TC434	A
Expedition (with factory 7-way)	07-00	TC554 or TC555	NR	N/A	TC434	A	Ranger	99-98	TC498	TC427	N/A	TC434	A
Expedition	02-00	TC539	NR	N/A	TC434	A	Ranger (with tow pkg.)						
Expedition - tow pkg. replacement adaptor	99-97	TC494	NR	N/A	TC434	A	Ranger	99-93	TC436	TC427	TC436A	TC428/TC466	B
Explorer	07-02	TC546	NR	N/A	TC434	A	Ranger	92-86	TC431	TC427	TC431A	TC434	A
Explorer (with factory 7-way)	04-02	TC554 or TC555	NR	N/A	TC434	A	Ranger	85	TC421	TC427	TC421A	TC434	A
Explorer (w/o tow pkg.)	00-95	TC463	TC430	N/A	TC432/TC453	C	Windstar	03-99	TC523	NR	N/A	N/A
Explorer (w/o tow pkg.)	00-95	TC498	TC427	N/A	TC434	A	Windstar	98-95	TC464	NR	N/A	TC428/TC466	B
Explorer (vehicle equipped with tow prep only)	97-96	TC499	TC430	TC499A	TC432/TC453	C	GMC						
Explorer (with tow pkg.)	94-91	TC422	TC427	TC422A	TC434	A	Astro	03-95	TC472	NR	N/A	TC434	A
Explorer Sport Trac	04-01	N/A	TC427	N/A	TC434	A	Astro	94-85	N/A	TC427	N/A	TC434	A
F250, F350 Heavy Duty	04-02	TC547	NR	N/A	TC434	A	Blazer (ST Series)	03-95	TC472	NR	N/A	TC434	A
F Series Pickup (with factory 7-way)	07-99	TC554 or TC555	NR	N/A	TC434	A	Blazer (full size)	94-92	TC412	TC427	TC412A	TC434	A
F Series - F250, F350 Heavy Duty	01-99	TC522	NR	N/A	TC434	A	Blazer - 4-door (ST Series)	94-91	N/A	TC427	N/A	TC434	A
							Blazer (full size)	91-85	TC451	TC427	TC451A	TC434	A
							Bravada (provides 6-way or 7RV blade and 4-way towing)	04-02	TC554 or TC555	NR	N/A	TC434	A
							Blazer - 2-door (ST Series)	91-84	TC413	TC427	TC413A	TC434	A
							Blazer (full size)	84-75	TC441	TC427	TC441A	TC434	A
							Bravada (ST Series)	01-95	TC472	NR	N/A	TC434	A

CHART CODES

- A. 4-Wire Flat
- B. General Purpose Converters
- C. Power Converters

- 217. Vehicle Connector (TC457 also required to service this application)
- 218. Plug Converter (TC424 also required to service this application)
- Note: See Buyers guide for full description and addition link options

APPLICATION GUIDE



Vehicle Make/Model	Year	Vehicle Connector	4-Wire Flat	Vehicle Connection Assembly	Universal Converters	Code	Vehicle Make/Model	Year	Vehicle Connector	4-Wire Flat	Vehicle Connection Assembly	Universal Converters	Code
Bravada - 4-door (ST Series)	94-91	N/A	TC427	N/A	TC434	A	Sierra (1500) (w/o tow package)	04-03	TC519	TC427	N/A	TC434	A
Caballero / El Camino	87-78	N/A	TC427	N/A	TC434	A	Sierra (2500) (w/o tow package)	04-00	TC519	TC427	N/A	TC434	A
Denali (CK Series)	00-99	TC412	TC427	TC412A	TC434	A	Sierra (1500/2500 with tow package)	04-00	TC519	TC427	N/A	TC434	A
Denali (CK Series)	04-01	TC519	TC427	N/A	TC434	A	Sonoma (ST Series)	01-98	TC504	TC430	N/A	TC434	A
Envoy (ST Series) - New Body Style (provides 6-way or 7RV blade and 4-way towing)	07-02	TC554 or TC555	NR	N/A	TC434	A	Sonoma (ST Series)	96-85	TC451	TC427	TC451A	TC434	A
Envoy (ST Series)	04-02	TC519	TC427	N/A	TC434	A	ST Series - Pickup	03-98	TC504	TC430	N/A	TC434	A
Envoy (ST Series)	01-99	TC472	NR	N/A	TC434	A	ST Series - Pickup	97-85	TC451	TC427	TC451A	TC434	A
Express Van - New Body Style (G Series)	00	TC524	TC530	N/A	TC434	A	Suburban (provides 6-way or 7RV blade and 4-way towing)	07-00	TC554 or TC555	NR	N/A	TC434	A
Express Van - New Body Style (G Series)	99-96	TC517	TC430	N/A	TC434	A	Suburban (CK Series)	99-92	TC412	TC427	TC412A	TC434	A
Jimmy (ST Series)	01-95	TC472	NR	N/A	TC434	A	Suburban (CK/RV Series)	91-85	TC451	TC427	TC451A	TC434	A
Jimmy - 4-door (full size)	94-92	TC412	TC427	TC412A	TC434	A	Suburban (CK Series)	84-75	TC441	TC427	TC441A	TC434	A
2-door (full size)		N/A	TC427	N/A	TC434	A	Tahoe (provides 6-way or 7RV blade and 4-way towing)	07-00	TC554 or TC555	NR	N/A	TC434	A
Jimmy (full size)	91-85	TC451	TC427	TC451A	TC434	A	Tahoe (CK Series)	04-00	TC519	TC427	N/A	TC434	A
Jimmy - 2-door (ST Series)	91-84	TC413	TC427	TC413A	TC434	A	Tahoe (CK Series)	99-95	TC412	TC427	TC412A	TC434	A
Jimmy (full size)	84-75	TC441	TC427	TC441A	TC434	A	Tracker	00-98	N/A	TC427	N/A	TC428/TC466	B
Pickup (full size) New Body Style 1/2 ton	00-99	TC424<217>	TC427	N/A	TC457<218>	Tracker	97-89	N/A	TC427	N/A	TC428/TC466	B
Old Body Style 3/4 ton	00-99	TC412	TC427	TC412A	TC434	A	Van - full size (G Series)	96-87	TC516	TC427	N/A	TC434	A
New Body Style 3/4 ton	04-00	TC519	TC427	N/A	TC434	A	Vandura - full size (G Series)	86-71	N/A	TC427	N/A	TC434	A
Pickup (full size)	98-88	TC412	TC427	TC412A	TC434	A	Venture	03-97	TC510	TC427	N/A	TC428/TC466	B
Pickup (full size)	87-85	TC451	TC427	TC451A	TC434	A	Yukon (provides 6-way or 7RV blade and 4-way towing)	07-00	TC554 or TC555	NR	N/A	TC434	A
Pickup - including dual wheel (full size)	84-75	TC441	TC427	TC441A	TC434	A	Yukon (CK Series)	04-00	TC519	TC427	N/A	TC434	A
Safari	03-95	TC472	NR	N/A	TC434	A	Yukon (CK Series)	99-95	TC412	TC427	TC412A	TC434	A
Safari	94-85	N/A	NR	N/A	TC434	A	Honda						
Savana - New Body Style (G Series)	01-00	TC524	TC430	N/A	TC434	A	Accord (sedan)	02-94	TC477	NR	N/A	TC428/TC466	B
Savana	07-03	TC558	NR	N/A	TC428/TC466	B	Accord (wagon)	96-94	TC477	TC427	N/A	TC428/TC466	B
Savana - New Body Style (G Series)	99-96	TC517	TC430	N/A	TC434	A							

CHART CODES

A. 4-Wire Flat
 B. General Purpose Converters
 C. Power Converters

217. Vehicle Connector (TC457 also required to service this application)
 218. Plug Converter (TC424 also required to service this application)
 Note: See Buyers guide for full description and additional link options

APPLICATION GUIDE

Vehicle Make/Model	Year	Vehicle Connector	4-Wire Flat	Vehicle Connection Assembly	Universal Converters	Code	Vehicle Make/Model	Year	Vehicle Connector	4-Wire Flat	Vehicle Connection Assembly	Universal Converters	Code
Accord	93-76	N/A	TC427	N/A	TC428/TC466	B	Pickup	01-98	TC504	TC430	N/A	TC434	A
Civic	02-82	N/A	TC430	N/A	TC432/TC453	C	Pickup	97-96	TC451	TC427	TC451A	TC434	A
Civic - Del Sol	96-93	N/A	TC430	N/A	TC432/TC453	C	Pickup	95-81	TC495	TC427	N/A	TC428/TC466	B
CRV	04-97	TC477	NR	N/A	TC428/TC466	B	Rodeo	02-98	TC525	TC430	N/A	TC428/TC466	B
Element	04-03	TC477	NR	N/A	TC428/TC466	B	Rodeo	97-92	TC478	NR	N/A	TC428/TC466	B
Odyssey	04-95	TC477	NR	N/A	TC428/TC466	B	Stylus	93-91	N/A	TC427	N/A	TC428/TC466	B
Passport	02-98	TC525	TC430	N/A	TC432/TC453	C	Trooper	01-92	TC479	NR	N/A	TC428/TC466	B
Passport	97-94	TC478	NR	N/A	TC428/TC466	B	Trooper	91-88	N/A	TC427	N/A	TC428/TC466	B
Pilot	04-03	TC477	NR	N/A	TC428/TC466	B	Vehicross	01-99	N/A	TC427	N/A	TC428/TC466	B
Prelude	01-83	N/A	TC430	N/A	TC432/TC453	C							
Hummer (provides 6-way or 7RV blade and 4-way towing)	07-03	TC554 or TC555	NR	N/A	TC434	A	Jaguar All models	00-86	N/A	TC430	N/A	TC432/TC453	C
Hyundai							Jeep						
Accent	03-95	N/A	TC427	N/A	TC428/TC466	B	Cherokee	01-97	TC502	TC430	N/A	TC428/TC466	B
Elantra	03-92	N/A	TC427	N/A	TC428/TC466	B	Cherokee	96-91	TC437	TC427	N/A	TC428/TC466	B
Excel	96-86	N/A	TC427	N/A	TC428/TC466	B	Cherokee	90-84	N/A	TC427	N/A	TC428/TC466	B
Santa Fe	06-01	TC561	NR	N/A	TC428/TC466	B	Cherokee	83-76	TC461	TC427	N/A	TC434	A
Scoupe	96-91	N/A	TC427	N/A	TC428/TC466	B	CJ-5	86-77	N/A	TC427	N/A	TC434	A
Sonata	00-89	N/A	TC427	N/A	TC428/TC466	B	CJ-7	86-77	N/A	TC427	N/A	TC434	A
Tiburon	00-97	N/A	TC427	N/A	TC428/TC466	B	Comanche	92-86	N/A	TC427	N/A	TC434	A
Infiniti							Grand Cherokee	04-99	TC521	TC430	N/A	TC432/TC453	C
FX35	08-05	N/A	TC430	N/A	TC432/TC453	C	Grand Cherokee (with tow pkg.)	98-95	TC476	TC430	N/A	TC432/TC453	C
G20	01-99	N/A	TC430	N/A	TC432/TC453	C	Grand Cherokee (w/o tow pkg.)	98-94	TC475	TC430	N/A	TC432/TC453	C
G20	96-91	N/A	TC430	N/A	TC432/TC453	C	Grand Cherokee	93	TC474	NR	N/A	TC432/TC453	C
I30	01-95	N/A	TC430	N/A	TC432/TC453	C	Grand Wagoneer	91-84	N/A	TC427	N/A	TC428/TC466	B
J30	98-93	N/A	TC430	N/A	TC432/TC453	C	J-10 Truck	88-75	N/A	TC427	N/A	TC434	A
Q45	01-90	N/A	TC430	N/A	TC432/TC453	C	J-20 Truck	88-75	N/A	TC427	N/A	TC434	A
Q56	07-04	TC554 or TC555	NR	N/A	TC434	A	Liberty	07-02	TC551	TC430	N/A	TC432/TC453	C
QX4	03-96	TC500	TC430	N/A	TC428/TC466	B	Scrambler	86-77	N/A	TC427	N/A	TC434	A
Isuzu							Wagoneer (compact)	90-84	N/A	TC430	N/A	TC432/TC453	C
Amigo	01-98	TC525	TC430	N/A	TC428/TC466	B	Wagoneer (full size)	83-75	N/A	TC427	N/A	TC434	A
Amigo	94-89	N/A	TC427	N/A	TC428/TC466	B	Wrangler (including YJ and Renegade)	03-98	TC515	TC430	N/A	TC434	A
Ascender	06-04	TC554 or TC555	NR	N/A	TC434	A	Wrangler (including YJ and Renegade)	97-91	TC490	TC427	N/A	TC434	A
Axion	02	TC525	TC430	N/A	TC428/TC466	B	Wrangler	90-87	N/A	TC427	N/A	TC434	A
Hombre	00-98	TC504	TC430	N/A	TC434	A	Kia						
Hombre	97-96	TC451	TC427	TC451A	TC434	A	Rio	03-01	N/A	TC427	N/A	TC428/TC466	B
I-Mark	89-81	N/A	TC427	N/A	TC428/TC466	B	Sedona	03-02	N/A	TC427	N/A	TC428/TC466	B
Impulse	93-83	N/A	TC430	N/A	TC432/TC453	C	Sephia	02-94	N/A	TC427	N/A	TC428/TC466	B
Oasis	98-96	TC477	NR	N/A	TC428/TC466	B							

CHART CODES

A. 4-Wire Flat

B. General Purpose Converters

C. Power Converters

217. Vehicle Connector (TC457 also required to service this application)

218. Plug Converter (TC424 also required to service this application)

Note: See Buyers guide for full description and addition link options

APPLICATION GUIDE



Vehicle Make/Model	Year	Vehicle Connector	4-Wire Flat	Vehicle Connection Assembly	Universal Converters	Code	Vehicle Make/Model	Year	Vehicle Connector	4-Wire Flat	Vehicle Connection Assembly	Universal Converters	Code	
Sorento	03	N/A	TC427	N/A	TC428/TC466	B	Millenia	02-95	N/A	TC430	N/A	TC432/TC453	C	
Spectra	03-01	N/A	TC427	N/A	TC428/TC466	B	MX-3	96-92	N/A	TC430	N/A	TC432/TC453	C	
Sportage	02-94	N/A	TC427	N/A	TC428/TC466	B	MX-5	97-88	N/A	TC430	N/A	TC432/TC453	C	
Lexus							MX-6	97-88	N/A	TC430	N/A	TC432/TC453	C	
ES300	01-91	N/A	TC430	N/A	TC432/TC453	C	Navajo (with tow package)	94-91	TC422 TC460	TC427 NR	TC422A N/A	TC434 TC434	A A	
GS 300	01-91	N/A	TC430	N/A	TC432/TC453	C	Pickup	03	N/A	TC427	N/A	TC434	A	
GS400	01-91	N/A	TC430	N/A	TC432/TC453	C	Pickup (with tow package)	99-98	TC498	NR	N/A	TC434	A	
LS400	01-91	N/A	TC430	N/A	TC432/TC453	C	Pickup (w/o tow package)	99-94	TC436	TC427	TC436A	TC428/TC466	B	
LX450	97-96	TC505	TC430	N/A	TC432/TC453	C	Pickup	93-85	TC496	TC427	N/A	TC428/TC466	B	
LX470	01-91	N/A	TC430	N/A	TC432/TC453	C	Pickup	02-00	N/A	TC427	N/A	TC434	A	
RX300	01-91	N/A	TC430	N/A	TC432/TC453	C	Pickup	99-91	N/A	TC430	N/A	TC432/TC453	C	
SC300	00-91	N/A	TC430	N/A	TC432/TC453	C	Protege	96-79	N/A	TC430	N/A	TC432/TC453	C	
SC400	00-91	N/A	TC430	N/A	TC432/TC453	C	RX-7	03-01	TC463	TC430	N/A	TC432/TC453	C	
Lincoln							Tribute (w/o tow package)	04-01	TC536	NR	N/A	TC434	A	
Aviator	04	TC546	NR	N/A	TC434	A	Tribute (with tow package)	00-89	N/A	TC430	N/A	TC432/TC453	C	
Aviator (w/ factory 7-way)	04-03	TC554 or TC555	NR	N/A	TC434	A	Van	Mercedes Benz						
Continental	01-88	N/A	TC430	N/A	TC432/TC453	C		All models	01-86	N/A	TC430	N/A	TC432/TC453	C
Continental	87-75	N/A	TC427	N/A	TC434	A		Mercury						
Mark IV	76-75	N/A	TC427	N/A	TC434	A		Capri	86-79	N/A	TC427	N/A	TC428/TC466	B
Mark V	79-77	N/A	TC430	N/A	TC432/TC453	C		Cougar	02-99	N/A	TC430	N/A	TC432/TC453	C
Mark VI	83-80	N/A	TC430	N/A	TC432/TC453	C		Cougar	97-89	N/A	TC430	N/A	TC432/TC453	C
Mark VII	92-84	N/A	TC430	N/A	TC432/TC453	C		Cougar	88-75	N/A	TC430	N/A	TC434	A
Mark VIII	98-93	N/A	TC430	N/A	TC432/TC453	C		Cougar XR7	80	N/A	TC430	N/A	TC432/TC453	C
Navigator (provides 6-way or 7RV blade and 4-way towing)	04-00	TC554 or TC555	NR	N/A	TC434	A		Grand Marquis	03-98	N/A	TC430	N/A	TC432/TC453	C
Navigator	02-00	TC539	NR	N/A	TC434	A		Grand Marquis	97-92	TC482	TC430	N/A	TC432/TC453	C
Navigator	00	N/A	TC427	N/A	TC434	A		Grand Marquis	91-83	N/A	TC430	N/A	TC432/TC453	C
Navigator	99-97	TC494	TC430	N/A	TC434	A		LN7	83-82	N/A	TC427	N/A	TC434	A
Town Car	03-80	N/A	TC430	N/A	TC432/TC453	C		Lynx	87-81	N/A	TC430	N/A	TC432/TC453	C
Versailles	80-77	N/A	TC427	N/A	TC434	A		Marauder	03	N/A	TC430	N/A	TC432/TC453	C
Mazda								Marquis	86-75	N/A	TC427	N/A	TC434	A
323	96-87	N/A	TC430	N/A	TC432/TC453	C		Monarch	80-75	N/A	TC427	N/A	TC434	A
626	02-88	N/A	TC430	N/A	TC432/TC453	C		Montego	76-75	N/A	TC427	N/A	TC434	A
626	87-79	N/A	TC427	N/A	TC428/TC466	B		Mountaineer	03-02	TC546	NR	N/A	TC434	A
929	96-88	N/A	TC430	N/A	TC432/TC453	C		Mountaineer (w/ factory 7-way)	03-02	TC554 or TC555	NR	N/A	TC434	A
GLC	86-77	N/A	TC427	N/A	TC428/TC466	B								
Miata	02-93	N/A	TC430	N/A	TC432/TC453	C								

CHART CODES

A. 4-Wire Flat

B. General Purpose Converters

C. Power Converters

217. Vehicle Connector (TC457 also required to service this application)

218. Plug Converter (TC424 also required to service this application)

Note: See Buyers guide for full description and addition link options

APPLICATION GUIDE

Vehicle Make/Model	Year	Vehicle Connector	4-Wire Flat	Vehicle Connection Assembly	Universal Converters	Code	Vehicle Make/Model	Year	Vehicle Connector	4-Wire Flat	Vehicle Connection Assembly	Universal Converters	Code
Mountaineer (with tow pkg.)	01-96	TC498	TC427	N/A	TC434	A	Altima	03-02	N/A	TC427	N/A	TC428/TC466	B
Mountaineer (w/o tow pkg.)	00-95	TC463	TC427	N/A	TC428/TC466	B	Altima	01-97	TC500	TC430	N/A	TC428/TC466	B
Mountaineer (with tow prep pkg.)	97-96	TC499	TC430	TC499A	TC432/TC453	C	Altima	96-93	N/A	TC430	N/A	TC432/TC453	C
Mystique	00-95	N/A	TC427	N/A	TC434	A	Axxess	95-90	N/A	TC427	N/A	TC428/TC466	B
Sable (sedan)	03-00	TC548	NR	N/A	TC428/TC466	B	Frontier	03-98	TC513	TC427	N/A	TC428/TC466	B
Sable (wagon)	01-96	N/A	TC430	N/A	TC432/TC453	C	Maxima	03-81	N/A	TC430	N/A	TC432/TC453	C
Sable (sedan)	99-96	TC483	TC430	N/A	TC432/TC453	C	Multi-Van	89-87	N/A	TC430	N/A	TC428/TC466	B
Sable (sedan)	95-86	N/A	TC430	N/A	TC432/TC453	C	NX 1600	93-91	N/A	TC427	N/A	TC428/TC466	B
Sable (wagon)	95-86	N/A	TC427	N/A	TC434	A	NX 2000	93-91	N/A	TC427	N/A	TC428/TC466	B
Topaz	95-88	N/A	TC430	N/A	TC432/TC453	C	Pathfinder	03-96	TC500	NR	N/A	TC428/TC466	B
Topaz	87-84	N/A	TC427	N/A	TC434	A	Pathfinder	95-91	N/A	TC430	N/A	TC432/TC453	C
Tracer	99-88	N/A	TC430	N/A	TC432/TC453	C	Pathfinder	90	N/A	TC427	N/A	TC432/TC453	C
Villager	02-93	N/A	TC427	N/A	TC428/TC466	B	Pathfinder	89-87	N/A	TC430	N/A	TC432/TC453	C
Zephyr	83-78	N/A	TC427	N/A	TC434	A	Pickup	97-91	TC485	TC430	N/A	TC432/TC453	C
Mitsubishi							Pickup	90-86	N/A	TC427	N/A	TC428/TC466	B
3000 GT	99-91	N/A	TC430	N/A	TC432/TC453	C	Pulsar	90-83	N/A	TC427	N/A	TC428/TC466	B
Diamante	02-92	N/A	TC430	N/A	TC432/TC453	C	Quest	00-93	N/A	TC427	N/A	TC428/TC466	B
Eclipse	03-90	N/A	TC430	N/A	TC432/TC453	C	Sentra	03-82	N/A	TC427	N/A	TC428/TC466	B
Expo LRV	94-92	N/A	TC427	N/A	TC428/TC466	B	Stanza	97-90	N/A	TC430	N/A	TC432/TC453	C
Galant	03-85	N/A	TC430	N/A	TC432/TC453	C	Stanza	89-82	N/A	TC427	N/A	TC428/TC466	B
Lancer	03-02	N/A	TC430	N/A	TC432/TC453	C	X-Terra	03-00	TC537	NR	N/A	TC428/TC466	B
Mirage	03-85	N/A	TC430	N/A	TC432/TC453	C	Oldsmobile						
Montero	03-92	TC489	NR	N/A	TC428/TC466	B	88 Series	99-90	N/A	TC430	N/A	TC432/TC453	C
Montero	91	TC489	TC427	N/A	TC434	A	88 Series	89-80	N/A	TC427	N/A	TC428/TC466	B
Montero	90-83	N/A	TC427	N/A	TC434	A	88 Series	79-75	N/A	TC427	N/A	TC434	A
Outlander	03	N/A	TC427	N/A	TC428/TC466	B	98 Series	96-84	N/A	TC430	N/A	TC432/TC453	C
Precis	92-87	N/A	TC430	N/A	TC432/TC453	C	98 Series	83-75	N/A	TC427	N/A	TC434	A
Pickup	96-83	N/A	TC427	N/A	TC428/TC466	B	Achieva	97-92	N/A	TC427	N/A	TC434	A
Nissan							Alero	03-99	N/A	TC430	N/A	TC432/TC453	C
200SX	98-95	N/A	TC427	N/A	TC428/TC466	B	Aurora	02-95	N/A	TC430	N/A	TC432/TC453	C
200SX	83-77	N/A	TC427	N/A	TC428/TC466	B	Bravada (provides 6-way or 7RV blade and 4-way towing)	03-02	TC554 or TC555	NR	N/A	TC434	A
210	82-76	N/A	TC427	N/A	TC428/TC466	B	Bravada	03-02	TC519	TC427	N/A	TC434	A
240SX	98-89	N/A	TC427	N/A	TC428/TC466	B	Bravada	01-96	TC472	TC430	N/A	TC434	A
280Z	83-75	N/A	TC427	N/A	TC428/TC466	B	Bravada	94-92	N/A	TC427	N/A	TC434	A
300ZX	96-84	N/A	TC430	N/A	TC432/TC453	C	Calais	91-89	N/A	TC427	N/A	TC434	A
310	82-79	N/A	TC427	N/A	TC428/TC466	B	Calais	88-86	N/A	TC430	N/A	TC432/TC453	C

CHART CODES

- A. 4-Wire Flat
- B. General Purpose Converters
- C. Power Converters

- 217. Vehicle Connector (TC457 also required to service this application)
 - 218. Plug Converter (TC424 also required to service this application)
- Note: See Buyers guide for full description and addition link options

APPLICATION GUIDE



Vehicle Make/Model	Year	Vehicle Connector	4-Wire Flat	Vehicle Connection Assembly	Universal Converters	Code	Vehicle Make/Model	Year	Vehicle Connector	4-Wire Flat	Vehicle Connection Assembly	Universal Converters	Code
Calais	85-78	N/A	TC427	N/A	TC434	A	Astre	77-75	N/A	TC427	N/A	TC434	A
Custom Cruiser (full size)	92-75	N/A	TC427	N/A	TC434	A	Aztec	05-01	TC559	NR	N/A	TC434	A
Cutlass	97-75	N/A	TC427	N/A	TC434	A	Bonneville	03-87	N/A	TC430	N/A	TC432/TC453	C
Cutlass Ciera	96-82	N/A	TC427	N/A	TC434	A	Bonneville	86-75	N/A	TC427	N/A	TC434	A
Firenza	88-82	N/A	TC427	N/A	TC434	A	Catalina	81-75	N/A	TC427	N/A	TC434	A
Intrigue	02-98	N/A	TC430	N/A	TC428/TC466	B	Firebird	02-89	N/A	TC430	N/A	TC432/TC453	C
Omega	84-75	N/A	TC427	N/A	TC434	A	Firebird	88-75	N/A	TC427	N/A	TC434	A
Silhouette	04-97	TC510	NR	N/A	TC434	A	Grand Am	00-75	N/A	TC427	N/A	TC434	A
Silhouette	96-92	TC488	NR	N/A	TC434	A	Grand LeMans	81-75	N/A	TC427	N/A	TC434	A
Silhouette	91	N/A	TC427	N/A	TC434	A	Grand Prix	08-88	N/A	TC430	N/A	TC432/TC453	C
Starfire	80-75	N/A	TC427	N/A	TC434	A	Grand Prix	87-74	N/A	TC427	N/A	TC434	A
Toronado	92-86	N/A	TC430	N/A	TC432/TC453	C	Grandville	81-75	N/A	TC427	N/A	TC434	A
Toronado	85-79	N/A	TC427	N/A	TC434	A	J2000	84-82	N/A	TC427	N/A	TC434	A
Plymouth							LeMans	93-88	N/A	TC427	N/A	TC434	A
Acclaim	95-89	N/A	TC427	N/A	TC432/TC453	C	LeMans	81-78	N/A	TC427	N/A	TC428/TC466	B
Arrow	80-76	N/A	TC427	N/A	TC428/TC466	B	LeMans	77-75	N/A	TC427	N/A	TC434	A
Breeze	00-96	N/A	TC430	N/A	TC432/TC453	C	Phoenix	84-80	N/A	TC427	N/A	TC434	A
Caravelle	88-85	N/A	TC427	N/A	TC434	A	Safari Wagon	89-83	N/A	TC427	N/A	TC434	A
Colt	94-83	N/A	TC427	N/A	TC428/TC466	B	Sunbird	94-88	N/A	TC427	N/A	TC428/TC466	B
Colt Vista	94-84	N/A	TC427	N/A	TC428/TC466	B	Sunbird	87-85	N/A	TC427	N/A	TC434	A
Duster	94-85	N/A	TC427	N/A	TC428/TC466	B	Sunbird	80-76	N/A	TC427	N/A	TC428/TC466	B
Gran Fury	89-75	N/A	TC427	N/A	TC434	A	Sunfire	05-95	N/A	TC427	N/A	TC434	A
Gr. Voyager	00-96	TC473	NR	N/A	TC428/TC466	B	Trans Sport	03-97	TC510	NR	N/A	TC428/TC466	B
Gr. Voyager	95-84	N/A	TC427	N/A	TC434	A	Trans Sport	96-93	TC488	NR	N/A	TC434	A
Horizon	90-78	N/A	TC427	N/A	TC428/TC466	B	Trans Sport	92-90	N/A	TC427	N/A	TC434	A
Laser	94-90	N/A	TC427	N/A	TC434	A	Ventura	77-75	N/A	TC427	N/A	TC434	A
Neon	01-95	N/A	TC427	N/A	TC434	A	Vibe	08-03	N/A	NR	N/A	TC428/TC466	B
Prowler	00-97	N/A	TC430	N/A	TC432/TC453	C	Porsche						
Reliant	89-81	N/A	TC427	N/A	TC434	A	All models	07-01	See Dealer	See Dealer	See Dealer	See Dealer
Sundance	94-87	N/A	TC427	N/A	TC434	A	Range Rover						
Turismo	87-82	N/A	TC427	N/A	TC434	A	Defender	98-93	N/A	TC430	N/A	TC432/TC453	C
Van (full size)	83-75	N/A	TC427	N/A	TC428/TC466	B	Discovery	00-94	N/A	TC430	N/A	TC432/TC453	C
Volare	80-76	N/A	TC427	N/A	TC434	A	Range Rover	00-87	N/A	TC430	N/A	TC432/TC453	C
Voyager	00-96	TC473	NR	N/A	TC428/TC466	B	Renault						
Voyager	95-91	TC439	TC427	N/A	TC434	A	18i	86-80	N/A	TC427	N/A	TC428/TC466	B
Voyager	90-84	N/A	TC427	N/A	TC434	A	Alliance	87-83	N/A	TC427	N/A	TC428/TC466	B
Pontiac							Fuego	85-82	N/A	TC427	N/A	TC428/TC466	B
6000	91-82	N/A	TC430	N/A	TC432/TC453	C	Medallion	89-88	N/A	TC430	N/A	TC432/TC453	C
							Sportwagon	85-84	N/A	TC427	N/A	TC428/TC466	B

CHART CODES

A. 4-Wire Flat

B. General Purpose Converters

C. Power Converters

217. Vehicle Connector (TC457 also required to service this application)

218. Plug Converter (TC424 also required to service this application)

Note: See Buyers guide for full description and addition link options

APPLICATION GUIDE

Vehicle Make/Model	Year	Vehicle Connector	4-Wire Flat	Vehicle Connection Assembly	Universal Converters	Code	Vehicle Make/Model	Year	Vehicle Connector	4-Wire Flat	Vehicle Connection Assembly	Universal Converters	Code
Saab							Land Cruiser	98-91	TC505	NR	N/A	TC432/TC453	C
All models	00-86	N/A	TC430	N/A	TC432/TC453	C	Land Cruiser	90-81	N/A	TC430	N/A	TC432/TC453	C
Saturn							MR2	95-85	N/A	TC427	N/A	TC428/TC466	B
L Series	03-00	N/A	TC427	N/A	TC428/TC466	B	Paseo	98-92	N/A	TC427	N/A	TC428/TC466	B
SC Series	02-91	N/A	TC427	N/A	TC428/TC466	B	Pickup - except T-100	94-84	TC438	TC427	N/A	TC428/TC466	B
SL Series	00-91	N/A	TC427	N/A	TC428/TC466	B	Pickup - except T-100	83-75	N/A	TC427	N/A	TC428/TC466	B
SW Series	00-91	N/A	TC427	N/A	TC428/TC466	B	Previa	97-91	N/A	TC427	N/A	TC428/TC466	B
Subaru							RAV 4	08-06	N/A	TC427	N/A	TC428/TC466
Brat	87-78	N/A	TC427	N/A	TC428/TC466	B	RAV 4	05-01	TC538	TC430	N/A	TC428/TC466	B
Forester	03-98	TC501	TC430	N/A	TC432/TC453	C	RAV 4	00-96	TC511	TC430	N/A	TC428/TC466	B
GL	92-87	N/A	TC430	N/A	TC432/TC453	C	Sequoia	03-01	N/A	TC427	N/A	TC428/TC466	B
GL	86-80	N/A	TC427	N/A	TC428/TC466	B	Sequoia	02-01	TC542	NR	N/A	TC428/TC466	B
Impreza	03-93	N/A	TC430	N/A	TC432/TC453	C	Sienna	03-98	N/A	TC543	N/A	TC428/TC466	B
Justy	93-89	N/A	TC430	N/A	TC432/TC453	C	Solara	03-99	N/A	TC427	N/A	TC428/TC466	B
Legacy	03-90	N/A	TC430	N/A	TC432/TC453	C	Starlet	84-81	N/A	TC427	N/A	TC428/TC466	B
Loyale	93-90	N/A	TC430	N/A	TC432/TC453	C	Supra	98-82	N/A	TC430	N/A	TC432/TC453	C
Outback	03-96	TC501	TC430	N/A	TC432/TC453	C	T100	98-93	TC486	TC427	N/A	TC428/TC466	B
SVX	96-92	N/A	TC430	N/A	TC432/TC453	C	Tacoma	03-95	TC438	TC427	N/A	TC428/TC466	B
Suzuki							Tercel	98-80	N/A	TC427	N/A	TC428/TC466	B
Esteem	01-95	N/A	TC427	N/A	TC428/TC466	B	Tundra	03	N/A	TC427	N/A	TC428/TC466	B
Vitara/Grand Vitara	05-99	TC560	NR	N/A	TC428/TC466	B	Tundra	02-01	TC544	NR	N/A	TC428/TC466	B
Grand Vitara	00-99	N/A	TC427	N/A	TC428/TC466	B	Tundra	00	TC512	TC427	N/A	TC428/TC466	B
Samurai	94-86	N/A	TC427	N/A	TC428/TC466	B	Van Wagon	90-84	N/A	TC427	N/A	TC428/TC466	B
Sidekick	98-89	N/A	TC427	N/A	TC428/TC466	B	Volkswagen						
Swift	01-89	N/A	TC427	N/A	TC428/TC466	B	Beetle	01-98	N/A	TC430	N/A	TC432/TC453	C
X-90	98-96	N/A	TC427	N/A	TC428/TC466	B	Beetle	79-75	N/A	TC427	N/A	TC428/TC466	B
Toyota							Cabriolet	01-85	N/A	TC427	N/A	TC428/TC466	B
4 Runner	08-03	N/A	TC427	N/A	TC428/TC466	B	Corrado	94-89	N/A	TC427	N/A	TC428/TC466	B
4 Runner	02-96	TC503	NR	N/A	TC428/TC466	B	EuroVan	00-83	N/A	TC427	N/A	TC428/TC466	B
4 Runner	95-87	N/A	TC430	N/A	TC432/TC453	C	Fox	93-87	N/A	TC427	N/A	TC428/TC466	B
Avalon	03-95	N/A	TC430	N/A	TC432/TC453	C	Golf	01-85	N/A	TC427	N/A	TC428/TC466	B
Camry	03-87	N/A	TC430	N/A	TC432/TC453	C	GTI	01-85	N/A	TC427	N/A	TC428/TC466	B
Camry	86-83	N/A	TC427	N/A	TC428/TC466	B	Jetta	01-80	N/A	TC427	N/A	TC428/TC466	B
Celica	03-75	N/A	TC427	N/A	TC428/TC466	B	Passat	01-90	N/A	TC427	N/A	TC428/TC466	B
Corolla	03-76	N/A	TC427	N/A	TC428/TC466	B	Quantum	88-82	N/A	TC427	N/A	TC428/TC466	B
Corona	82-75	N/A	TC427	N/A	TC428/TC466	B	Rabbit	84-75	N/A	TC427	N/A	TC428/TC466	B
Cressida	93-81	N/A	TC430	N/A	TC432/TC453	C	Scirocco	88-75	N/A	TC427	N/A	TC428/TC466	B
Echo	03-00	N/A	TC427	N/A	TC428/TC466	B	Vanagon	92-80	N/A	TC427	N/A	TC428/TC466	B
Highlander	04-01	TC549	NR	N/A	TC428/TC466	B	Volvo						
Land Cruiser	06-99	N/A	TC427	N/A	TC428/TC466	B	All models	00-75	N/A	TC430	N/A	TC432/TC453	C

CHART CODES

A. 4-Wire Flat

B. General Purpose Converters

C. Power Converters

217. Vehicle Connector (TC457 also required to service this application)

218. Plug Converter (TC424 also required to service this application)

Note: See Buyers guide for full description and addition link options

TRAILER CABLES



TRAILER WIRE ACCESSORIES

Economy Circuit Tester

Part No.	Description
TC7T	Economy tester finds open circuits, blown fuses, bad connections quickly and easily. Test lead with alligator clip included.
TC1	Trailer assembly connector cleaner. Self storing cap. 7-Pin.

MOLDED CONNECTORS

Universal 4-Pole Square Type Trailer Connector

Part No.	Description
ET450	<ul style="list-style-type: none"> • 12" leads, 18 gauge • Plug and receptacle are not sold separately • Includes 6 quick splice connectors

4-Pole Molded Trailer Connector

Part No.	Description
ET456	<ul style="list-style-type: none"> • 18 gauge pigtails • Ideal for utility, boat, camper trailer • Will accommodate stop lights, directional lights, tail lights, and ground. Plug and receptacle not sold separately • Includes 6 quick splice connectors

Universal 5-Pole Trailer Connector

Part No.	Description
ET451	<ul style="list-style-type: none"> • Used for vehicles with separate stop light and directional lamps • Plug and receptacle are not sold separately • Includes 6 quick splice connectors

6-Pole Molded Trailer Connector

Part No.	Description
ET452	<ul style="list-style-type: none"> • Used for trailers requiring a six-circuit connection such as electric brakes • Plug and receptacle are not sold separately • Includes 6 quick splice connectors

POSI-PLUG™ QUICK DISCONNECT

Part No.	Gauge	Qty. Per Pkg.
ET535	18	1

EASY AS ① ② ③

① Strip wire 1/2"



② Insert



③ Hand tighten

Repeat for each wire

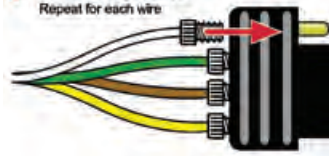

ET Display Package

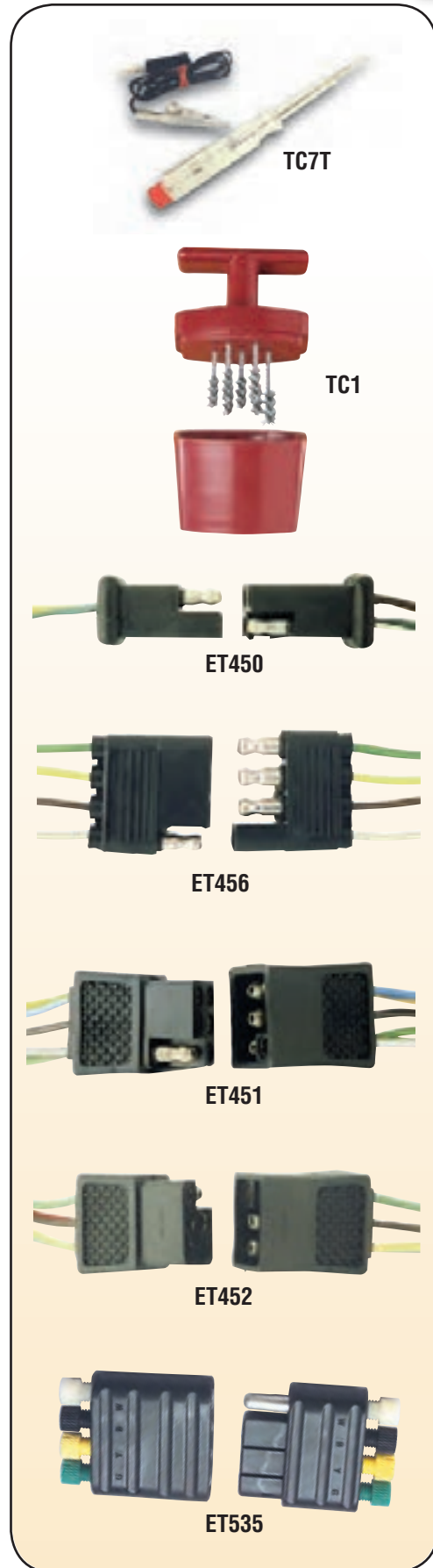

TRAILER CONNECTORS

TRAILER CABLES / TRACTOR TRAILER WIRING RECOMMENDATIONS

TRAILER CABLE ASSEMBLIES COLOR CODED TO ATA STANDARDS AND SAE J2394 SPECIFICATIONS

- Philaprene® Jacket
- Lighter and Tougher than Neoprene, PVC or TPR
- Resists wear and abrasion
- Exhibits superior coil retention
- Plugs rated for temperatures -70°F to 400°F
- Cable rated for temperatures -70°F to 185°F
- 7 Conductors
- Xenoy plugs are corrosion proof

Part No.	Description	Working Length	Conductor Plugs	Gauges	Color	Std. Pkg.
TC5*	PHILAPRENE® Jacket	12'	Xenoy	1-10 Ga. 6-12 Ga.	Black	1
TC6*	PHILAPRENE® Jacket	15'	Xenoy	1-10 Ga. 6-12 Ga.	Black	1
TC7*	PHILAPRENE® Jacket, w/ 2 40" leads	15'	Xenoy	1-10 Ga. 6-12 Ga.	Black	1
TC8*	PHILAPRENE® Jacket	20'	Xenoy	1-10 Ga. 6-12 Ga.	Black	1
TC9	PHILAPRENE® Jacket for trailers w/ ABS	15'	Xenoy	1-8 Ga. 2-10 Ga. 4-12 Ga.	Green	1
TC12	PHILAPRENE® Jacket for trailers w/ ABS, w/ 2 40" leads	15'	Xenoy	1-8 Ga. 2-10 Ga. 4-12 Ga.	Green	1

NOTE: *Not recommended for vehicles with anti-skid control circuits...Or on tandem trailers where excessive voltage drops are likely to occur.

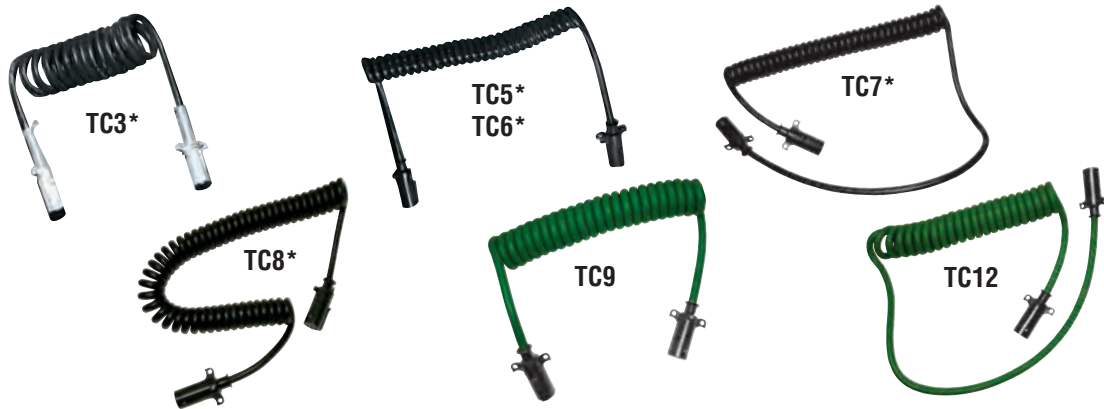

TRACTOR TRAILER WIRING RECOMMENDATIONS (RCCC & A.T.A.)

- WHITE** — Ground return to towing vehicle (8 AWG)
- BLACK*** — ICC-required marker identification and clearance lamps (12 AWG)
- YELLOW** — Left-hand directional and hazard signal (12-AWG)
- RED** — Stop lamp and anti-wheel lock devices (10 AWG)
- GREEN** — Right-hand directional and hazard signal (12-AWG)
- BROWN** — Tail, license and clearance lamps (12 AWG)
- BLUE** — ABS Continuous Power (10 AWG)

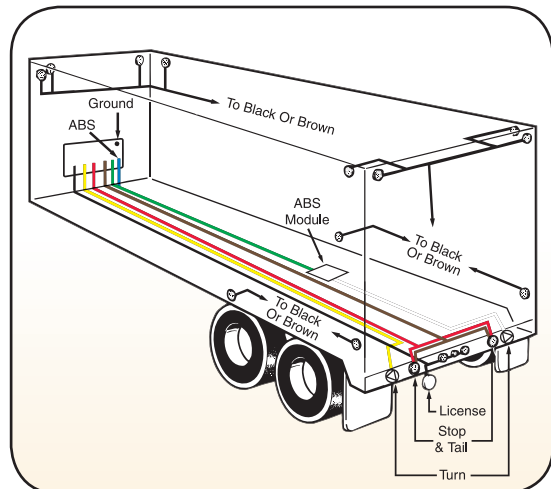

TRAILER CONNECTORS



TRAILER CONNECTORS

BULK TRAILER CABLE					
Rated at -40°F to +176°F					
Part No.		Conductors	Gauge	Stranding	O.D.
50' Coil	100' Coil				
CJ12-4PL	CJ12-4PC	4 (red / brown / green / yellow)	12	19 x 25	.406"
	CJ14-2C	2 (red / black)	14	41 x 30	.440"
CJ14-4L	CJ14-4C	4 (red / brown / black / white)	14	19 x 27	.410"
CJ14-4BL	CJ14-4BC	4 (white / brown / yellow / green)	14	41 x 30	.450"
CJ16-4L	CJ16-4C	4 (red / brown / black / white)	16	26 x 30	.455"
CL16-4BL	CL16-4BC	4 (white / brown / yellow / green)	16	26 x 30	.390"
CJ16-5L	CJ16-5C	5 (red / white / green / yellow / brown)	16	26 x 30	.400"
CJ12-6PL	CJ12-6PC	6 (black / white / red / green / yellow / brown)	12	19 x 25	.500"
CJ14-6L	CJ14-6C	6 (black / white / red / green / yellow / brown)	14	19 x 27	.500"
CJ16-6L	CJ16-6C	6 (black / white / red / green / yellow / brown)	16	19 x 29	.435"

SEVEN - CONDUCTOR TRAILER CABLE THERMOPLASTIC PVC INSULATION						
Rated at -40°F to +176°F						
Meets SAE Specification J1128						
Part No.			Conductors	Gauges	Stranding	O.D.
50' Coil	100' Coil	250' Coil				
CJ12-7AL *	CJ12-7AC		7 (white/red/brown/black/yellow/blue/green)	1-8 Ga. 1-10 Ga. 5-12 Ga.	19 x 21 19 x 23 19 x 25	.695"
CJ12-7BL (ABS)	CJ12-7BC	CJ12-7BE	7 (white/red/brown/black/yellow/blue/green)	4-12 Ga. 2-10 Ga. 1-8 Ga.	65 x 30 105 x 30 168 x 30	.690"
CJ12-7DL	CJ12-7DC	CJ12-7DE	7 (white/red/brown/black/yellow/blue/green)	1-12 Ga. 6-14 Ga.	65 x 30 41 x 30	.610"
CJ12-7L	CJ12-7C		7 (white/red/brown/black/yellow/blue/green)	1-10 Ga. 6-12 Ga.	19 x 23 19 x 25	.695"

*For vehicles equipped with electronic anti-skid control devices.

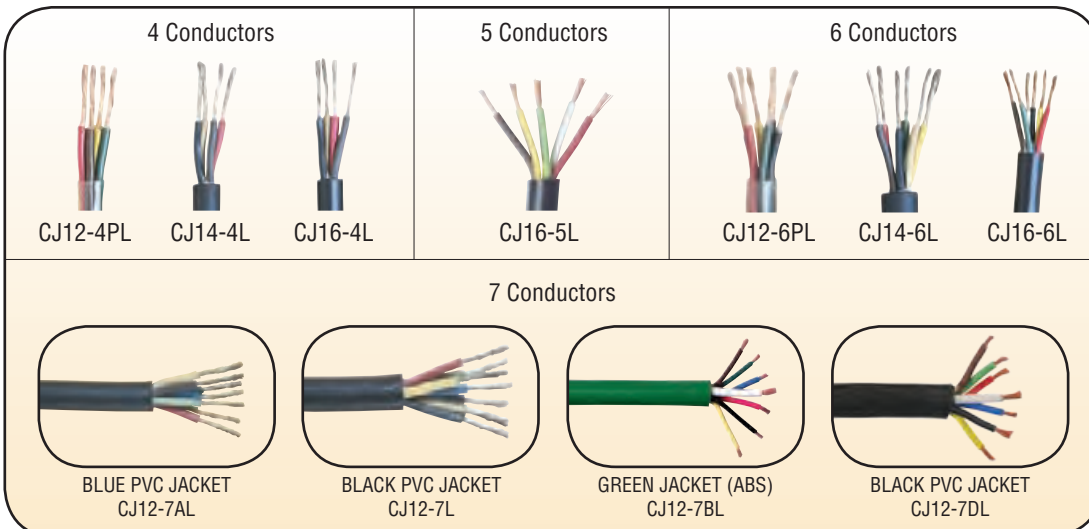

Meets SAE Specification J1128

CUSTOM REPLACEMENT ENDS

Alternative to High Priced Complicated Custom Cables

- ❖ Great for OE Harness Repair
- ❖ Saves Customer Time and Money
- ❖ Universal Terminal Fits Positive and Negative Battery Posts

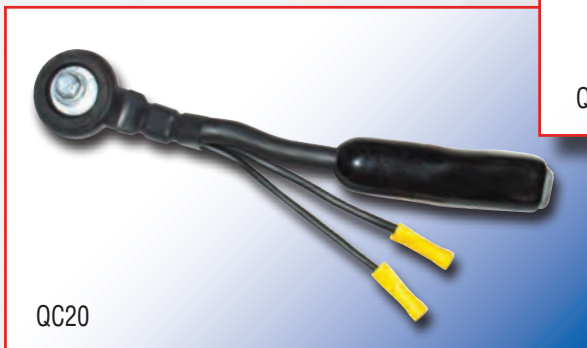
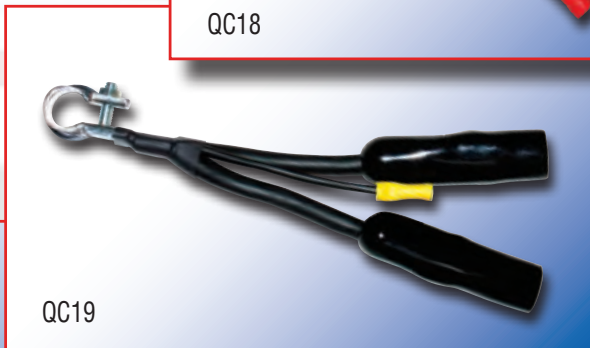
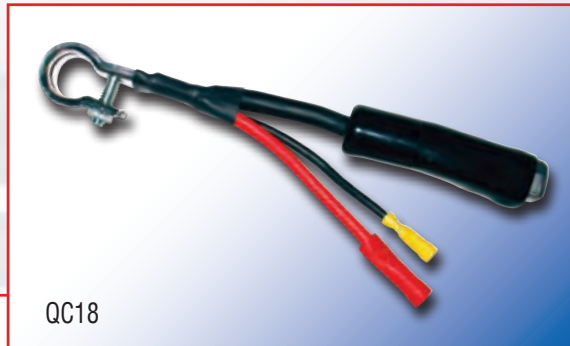

For a complete listing of part numbers and additional information see page B18

Easy-to-install, because the work is always near the battery, no special tools required



STANDARD[®]

ST10080



Ignition Wires

Battery Cables

Primary Wire

Terminals & Connectors

Trailer Connectors

Sockets, Pigtails & Switches

Safety Accessories

O.E. Interchanges

Index

SOCKET ASSEMBLIES

This catalog section contains the sockets, pigtails and universal switches available in the engine controls line. The Socket Assemblies and the Pigtail Assemblies are listed by number of lead wires. The universal switches are listed by type. The Pkg. Qty. column indicates quantity per each package.

SOCKET ASSEMBLIES WITH SINGLE WIRE LEAD

Part No.	Pkg. Qty.	Description	Illustration	Part No.	Pkg. Qty.	Description	Illustration
S-20	1	Single Contact Miniature Socket and bracket. For dome, map and other applications. Fits lamps No. 51, 53, 55, 57, 1895.		S-43N	1	Single Contact Neoprene Covered Socket Assembly For signal, park, stop and taillight. Fits lamps No. 67, 89, 93, 97, 1003, 1073, 1141, 1156. Universal	
S-21	1	Single Contact Socket For dome, map and other applications. Fits lamps No. 67, 89, 93, 97, 1003, 1073, 1141, 1156. Universal.		S-45N	1	Single Contact Socket Repair Assembly AMC: 4486949, 4489412 Chry.: 3513162, 3780745 Ford: D00Z-15536A GM: 2978302 Fits 1/8" hole. Fits lamps No. 67, 89, 93, 97, 1003, 1073, 1141, 1156. American Motors 80-70 Chrysler Corp. 85-71 Dodge Trucks 86-71 Ford, Mercury 77-73	
S-22	1	For Replaceable Single Contact Miniature base socket. Pigtail wire assembly complete with terminal attached. Fits lamps No. 53, 55, 57, 1895. Universal.		S-56	1	Socket Bracket Assembly Snap-in-type for instrument panel. Miniature base (5/8" dia.) single contact w/16 gauge wire for instrument panel lights. Fits lamps No. 53, 55, 57, 1985. Universal applications.	
S-23	1	For Replaceable Base Sockets Pigtail wire assembly complete with terminal attached. Fits lamps No. 67, 89, 93, 97, 1003, 1073, 1141, 1156. Universal.		S-57	1	Socket Repair Assembly Single contact w/12" of 16 gauge wire and ceramic disc. Used on most cars, trucks, trailers & boats for courtesy lamps, marker lights, dome lights, taillight, etc. Fits lamps No. 67, 89, 93, 97, 1003, 1073, 1141, 1156.	
S-30N	1	Single Contact Socket Spring clips for snap fit in 7/8" to 1 1/8" openings. Parking and taillight assemblies. Fits lamps No. 67, 89, 93, 97, 1003, 1073, 1141, 1156. Universal.		S-60	1	Socket Repair Assembly Single contact back-up and license lights. Fits lamps No. 67, 89, 93, 97, 1003, 1073, 1141, 1156. Pontiac 78-75	
S-35	1	Single Contact Snap-In Socket Assembly For license plate and instrument light on most cars. Fits lamps No. 67, 89, 93, 97, 1003, 1073, 1141, 1156. Universal.		S-61	1	Socket Repair Assembly Pigtail with ceramic washer. Single contact w/12" of 16 gauge wire. Used on most cars, trucks, trailers, boats for dome light, instrument panel, courtesy lamp, under hood or trunk. Fits lamps No. 53, 55, 57, 1985.	
S-38N	1	Single Contact Socket Assembly Regular base. For signal, park, stop and taillight. Fits lamps No. 67, 89, 93, 97, 1003, 1073, 1141, 1156. Universal.		S-62	1	Socket Repair Assembly With adapter plate and Neoprene boot, for universal single contact applications. Fits lamps No. 67, 89, 93, 97, 1003, 1073, 1141, 1156.	
S-40	1	Single Contact Socket and Pigtail Assembly For shielded license plate and utility lights. Universal applications.					

SOCKET ASSEMBLIES



SOCKET ASSEMBLIES WITH SINGLE WIRE LEAD

Part No.	Pkg. Qty.	Description	Illustration	Part No.	Pkg. Qty.	Description	Illustration
S-87	1	Socket Repair Assembly Single contact snap in socket. For 3/4" hole. Fits license lamps No. 67, 89, 93, 97, 1003, 1073, 1141, 1156. Universal.		S-703	1	Socket Repair Assembly GM: 10042638. Instrument panel socket w/digital, 1/2" hole. Oldsmobile..... 86-87 Pontiac 87	
S-500A	2	Socket Repair Assembly Chry.: 3744750, 4124104 Ford: C80Z-13711A, B Fits instrument cluster with printed circuit board. 1/2" mounting hole. Fits lamp No. 194. Chrysler Corp.90-74 Ford96-80 Ford Trucks92-80 Lincoln89-73 Mercury.....90-78		S-771	1	Socket Assembly Socket, board, tail lamps. Chrysler00-96 Dodge03-96 Jeep04-99 Plymouth.....00-96	
S-513	1	Socket Repair Assembly Standard base, 1/16" dia., single contact. Fits lamps No. 67, 89, 93, 97, 1003, 1073, 1141, 1156.		S-865	1	Socket Assembly Single contact, snap-in type, fits 3/4" hole. For stop, tail, turn signal, back-up, license plate, or parking light socket. Buick64-55 Cadillac.....61-56 Chevrolet63-58 Chrysler69-55 Dodge69-55 Ford67-59 Mercury.....61-56 Oldsmobile.....61-56 Plymouth.....67-50	
S-515	1	Socket Repair Assembly For dome, map and other applications. Fits lamps No. 67, 89, 93, 97, 1003, 1073, 1141, 1156. Standard socket base, 1/16" dia. with flange and two holes on 1 1/8" centers, single contact.					

SOCKET ASSEMBLIES WITH 2 WIRE LEAD

Part No.	Pkg. Qty.	Description	Illustration	Part No.	Pkg. Qty.	Description	Illustration
S-24	1	For Replaceable Double Contact Base Sockets Pigtail wire assembly with terminals attached. Fits lamps No. 1034, 1154, 1157, 1158, 1176, 1178.		S-29	1	Flush Mounting Snap-In Double Contact Fits 1 1/8" hole for most double contact applications. Parking, directional, taillight & stoplights. Fits lamps No. 1034, 1154, 1157.	
S-25N	1	Double Contact Base with Socket Fits lamps No. 68, 90, 94, 96, 1004, 1158, 1176, 1178.		S-31N	1	Double Contact Socket Spring clips for snap fit in 7/8" to 1 1/8" openings. For many popular cars and trucks. Parking and taillight assemblies. Fits lamps No. 68, 90, 94, 96, 1004, 1158, 1176, 1178.	
S-26N	1	Double Contact Base with Socket Fits lamps No. 1034, 1154, 1157.		S-32	1	Double Contact Socket Repair Assembly For parking and taillight assemblies. For most cars. Fits lamps No. 1034, 1154, 1157.	
S-27	1	Double Contact Socket Socket clips for snap fit in 7/8" to 1 1/8" openings. For many popular cars and trucks. Parking and taillight assemblies. Fits lamps No. 1034, 1154, 1157.					

SOCKETS, PIGTAILS & SWITCHES

SOCKET ASSEMBLIES

SOCKET ASSEMBLIES WITH 2 WIRE LEAD

Part No.	Pkg. Qty.	Description	Illustration	Part No.	Pkg. Qty.	Description	Illustration
S-36N	1	Double Contact Weather-Proof Neoprene Covered Socket Assembly Stop, tail & rear turn signal. Ford 72-65. Fits license lamps for Mercury Marquis 76-73. Fits stoplight of American Motors and many universal car and truck applications 80-59. Fits lamps No. 198, 1016, 1034, 1154, 1157		S-51	1	Socket Repair Assembly Ceramic disc for double contact standard base sockets. Moisture resistant. Pigtail wire assembly with terminals attached. Fits lamps No. 1034, 1154, 1157, 1158, 1176, 1178.	
S-37N	1	Double Contact Socket Spring clips for snap-in fit. For parking and taillight on most vehicles. Fits lamps No. 1034, 1154, 1157.		S-58	1	Socket Repair Assembly Pigtail w/solid brass contacts, with weatherproof boots for double contact standard base sockets. Fits lamps No. 1004, 1034, 1154, 1157, 1158, 1176, 1178. Similar to S24.	
S-39	1	Double Contact Assembly Regular base. For signal, park, stop taillight. Fits lamps No. 67, 89, 93, 97, 1003, 1073, 1141, 1156.		S-63	1	Socket Repair Assembly (5963268, 8904437, 8909518) Back-up light. Fits lamp No. 1154. Buick 90-72 Cadillac 92-70 Chevrolet 88-69 GM Light Trucks 91-86 Oldsmobile 85-73 Pontiac..... 88-76 Saturn 92-91	
S-44	1	Double Contact Socket Assembly AMC: 448649, 4488908 Chry: 3764747 ; GM: 8909910 Stop, tail and rear signal lights. Fits 1 1/8" hole. Fits lamps No. 1034, 1154, 1157. American Motors 80-72 Buick, Oldsmobile 81-64 Dodge 75		S-67	1	Socket Repair Assembly IHC: 571721C91 Park, stop, tail and turn signal. Fits lamp No. 1156. IHC Trucks..... 80-73	
S-46N	1	Double Contact Socket Assembly With socket adapter plate and neoprene boot, 30" wire leads. For signal, park, stop and taillight for most cars and trucks. Fits 3/4" hole. Fits lamps No. 1034, 1154, 1157.		S-71	1	Socket Repair Assembly AMC: 3691072 Chrysler: 3764126, 159 Ford: D3AZ-13410A, D80Z-15434A Fits lamp No. 1156. American Motors 77-76 Chrysler 78-74 Ford 80-73 Mercury 80-73 Plymouth 74	
S-47N	1	Weatherproof Double Contact Socket Assembly For signal, park, stop and taillight. Fits 1 1/8". Fits lamps No. 1034, 1154, 1157.		S-74	1	Socket Repair Assembly AMC: 4489395 Ford: E1FZ-13410A; D5VY-15A442A. GM: 6298892 IHC: 418977C91 License, side maker, cornering. Fits lamps No. 131, 168, 194, 194A. AMC 88-70 Ford Cars 87-73 Ford Trucks 90-88 GM Cars 96-70 GM Light Trucks 92-82 IHC Trucks 80-57 Renault 87-72 Older Cars & Trucks	
S-49	1	Double Contact Assembly AMC: 448869478 GM: 8912698 With positive-grip heavy duty plastic housing and sealed-in blade contacts. An exact replacement for the original socket. For park, turn, stop and taillight applications on most cars with 1 1/8" hole. American Motors 79-69 Cadillac 73-70 Oldsmobile 73-70					

SOCKET ASSEMBLIES





SOCKET ASSEMBLIES WITH 2 WIRE LEAD

Part No.	Pkg. Qty.	Description	Illustration	Part No.	Pkg. Qty.	Description	Illustration
S-75	1	Socket Repair Assembly (D0AZ, D1AZ, D20Z-13410B) Park, stop, tail, turn signal. Fits lamps No. 1034, 1154, 1157. Lincoln80-70 Mercury79-75		S-98	1	Socket Repair Assembly (12003878) Back-up, cornering and turn signal. Fits lamps No. 1156. Buick.....90-77 Cadillac.....89-82, 78-76 Chevrolet90-77 Oldsmobile.....90-82, 78-77 Pontiac.....89-81, 79-77	
S-80	1	Socket Repair Assembly (8918646) Back-up light. Fits lamp No. 1156. Buick77 Mercury77-74		S-99	1	Socket Repair Assembly (3513686, 4055028) Fits front and rear side marker. Fits lamps No. 158, 194, 194A. Chrysler Corp. Cars....87-72 Dodge Trucks91-72	
S-89	1	Socket Repair Assembly GM: 8918525, 12003877 Single contact with ground wire. Fits 1 1/8" hole. For Back-up light. Fits lamps No. 67, 89, 93, 97, 1003, 1073, 1141, 1156. Pontiac.....78-75		S-100	1	Socket Repair Assembly Chry.: 3588314, 3588650 Ford: E25Y-13410B. Fits front and rear side marker. Fits lamps No. 158, 194, 194A. Chrysler98-79 Dodge, Plymouth.....98-72 Dodge Trucks98-86, 88-85 Ford, Mercury98-83 Ford Trucks98-92 Lincoln98-82	
S-95	1	Socket Repair Assembly Ford: E0SZ-15A442B GM: 12001470. Tail, stop, turn signal. Fits lamps No. 161, 168, 194, 194A. Cornering, license, park, side marker. Buick99-76 Cadillac.....97-76 Chevrolet02-76 Ford89-88 GM Light Trucks99-78 Lincoln89-81 Mercury80 Oldsmobile.....99-76 Pontiac.....02-76		S-501	1	Socket Repair Assembly (3764865, 3764561, 3764863) Fits front and rear cornering or side marker lamps. Chrysler92-79, 75-74 Dodge90-79 Plymouth.....90-79	
S-96	1	Socket Repair Assembly Shielded universal underhood & trunk light. Universal Applications.		S-503A	2	Socket & Pigtail Assembly Fits instrument cluster with printed circuit board 5/8" mounting hole. AMC: 8122474, 8126900 Chrysler: 2496279 Ford: E6FZ-13B764A GM: 12004311, 2973932, 5655006 AMC.....77-76 Buick.....77-76 Cadillac.....89-76 Chevrolet84-70 GM Trucks91-73 Oldsmobile.....84-76 Pontiac.....87-76	
S-97	1	Socket Repair Assembly Chry.: 4274100, GM: 8912750 License, side marker, cornering. Fits lamps No. 161, 168, 194, 94A. Buick.....92-73 Cadillac.....85-76, 73 Chevrolet92-74 Chrysler Corp. Cars....86-82 GM Light Trucks92-86 Oldsmobile.....92-76 Pontiac.....92-74, 70		S-506	1	Socket Repair Assembly (12003757) Back-up light. Buick.....96-81 Cadillac.....02-86 Chevrolet96-80 Chrysler90-89 Dodge89 GM Light Trucks03-82 Oldsmobile.....96-81 Pontiac.....95-81 Renault87-83	

SOCKETS, PIGTAILS & SWITCHES

SOCKET ASSEMBLIES

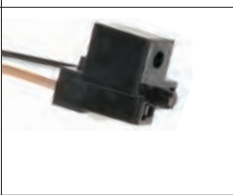
SOCKET ASSEMBLIES WITH 2 WIRE LEAD

Part No.	Pkg. Qty.	Description	Illustration	Part No.	Pkg. Qty.	Description	Illustration
S-508	1	Socket Repair Assembly (D3AZ-13410E, D8BZ-13412A) Fits front, park, and turn signal. Ford 77-75 Mercury..... 78-75		S-529	1	2-Wire Socket Assembly Fits domestic and import vehicles with 2-prong headlights. Acura..... 95-86 Audi 85-71 Austin 80-70 Chrysler Vehicles..... 91-65 De Lorean 82-81 Ford Vehicles 89-65 GM Vehicles 97-63 IHC Light Trucks 85-57	
S-509	1	Socket Repair Assembly (D3AZ-13410G) Fits coming lamps. Ford 80-73 Lincoln 78-75 Mercury..... 78-75		S-535	1	Socket Repair Assembly Universal dash lamp & socket assembly. Will mount through 1/2" hole in panel up to 3/4" thick. 12 volt non-replacement bulb, 8" coil leads.	
S-514	1	Socket Repair Assembly Universal, weatherproof, double-contact socket assembly. Fits 3/4" base bulb. Fits lamps No. 1034, 1154.		S-540	1	Socket Assembly For 4701 minisealed high beam headlamps for GM vehicles.	
S-517	1	Socket Repair Assembly Universal 2-wire socket to fit all vehicles with 2-prong sealed beam or flasher. Buick..... 95-85 Cadillac..... 00-99, 95-93, 90-85 Chevrolet 01, 95-85 GM Light Trucks 03-90		S-541	1	Socket Assembly For 4703 minisealed low beam headlamps for GM vehicles.	
S-518	1	Socket Repair Assembly Universal, standard base, 11/16" diameter, double contact socket. Comes with two flange mounting holes on 1 1/16" center.		S-557	1	Socket Repair Assembly (4414184) For license lamps. Chrysler 92-89 Dodge, Plymouth..... 92-89	
S-523	1	Socket Repair Assembly GM: 12101897 (low beam) socket assembly for Halogen bulb headlamp assembly with 2-prong and 9006 bulb. With gray housing, weather-pack seal, two 9 1/2" No. 18 Ga. leads. Buick..... 03-90 Cadillac..... 03-90 Chevrolet 03-90 GM Light Trucks 03-92 Oldsmobile..... 99-90 Pontiac..... 03-88		S-570	1	Single Contact Socket with External Ground (EOMY, EIDZ-15536A) ID No. EIBB-15A536-BA Ford 89-81 Mercury 89-80	
S-524	1	Socket Repair Assembly GM: 12101898 (high beam) socket assembly for halogen bulb headlamp assembly with 2 prongs and a 9005 bulb. With black housing, weather-pack type seal, two 9 1/2" No. 18 Ga. leads. Buick..... 03-90 Cadillac..... 04-90 Chevrolet 03-90 GM Light Trucks 03-92 Oldsmobile..... 99-90 Pontiac..... 03-88		S-571	1	Socket Repair Assembly Rear lamps. (E8PZ-13411D, E9AZ, E9DZ-15A434A) ID No. 20.85 Ford..... 90-86 Lincoln..... 90-87 Mercury 87-86	

SOCKET ASSEMBLIES













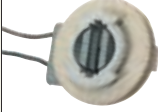

SOCKET ASSEMBLIES WITH 2 WIRE LEAD

Part No.	Pkg. Qty.	Description	Illustration	Part No.	Pkg. Qty.	Description	Illustration
S-572	1	Socket Repair Assembly Side marker. (E1DZ-15A43B; E4DZ, E6AZ, E6DZ-15A43A) ID# E6AB-15A200-AA; E6DB-15A200-AA, AC Ford, Mercury89-81 Lincoln90-81		S-766	1	Socket Assembly A/T indicator lamp, compartment lamp, courtesy lamp I/P, console front floor, daytime running lamp, ambient light, sensor, malfunction indicator lamp, water and fuel indicator lamps. Buick02-90 Cadillac96-93 Chevrolet01-90 GM Light Trucks03, 95-90 GM Med. Duty Trucks 98-93 Oldsmobile02-92 Pontiac02-90	
S-586	1	Socket Repair Assembly Back-up Lamps. GM: 12085330 Buick03-91 Cadillac03-94 Chevrolet02-90 GM Light Trucks03-95 Oldsmobile03-90 Pontiac03-96		S-767	1	Socket Assembly Back-up lamp, rear fog lamp, rear turn signal lamp. Buick03-97 Cadillac96-92 Chevrolet02-93 GM Light Trucks03-94 Oldsmobile95-93	
S-589	1	Universal "OFFSET" Mounting Plate Type double contact socket. For signal, park, stop and tail lamps. Fits lamps No. 198, 16, 1034, 1154.		S-768	1	Socket Assembly Back-up lamp, cornering lamp. Buick96-83 Cadillac02-82 Chevrolet96-82 GM Light Trucks94-82 Oldsmobile96-82 Pontiac98-82	
S-591	1	Universal Socket Repair Assembly Double contact standard base, ceramic disc. Contacts at right angle to key. Fits lamps No. 64, 68, 82, 88, 90, 94, 210, 1004, 1074, 1130, 1158, 1176.		S-769	1	Socket Assembly Ford: F32Z-13K371A Hi-Mtd. stop lamp. Ford97-93	
S-592	1	Socket Repair Assembly For cornering and marker lamps. (12083007) Chevrolet03-84 Oldsmobile98-88 Pontiac96-87 Saturn92-91		S-770	1	Socket Assembly Chrysler: 4636358 Back-up lamp, cornering lamp, turn lamp. Chrysler97-91 Dodge97-91 Plymouth97-91	
S-669	1	Socket Repair Assembly GM: 12037105, 12083460 Front, side and rear marker. Cadillac85 Chevrolet01-87, 82 GM Light Trucks03-82		S-772	1	Socket Assembly Chrysler: 4400899 Hi-Mtd. stop, license plate, side marker, tail lamps. Chrysler96-89 Dodge96-89 Eagle93-93 Plymouth96-89	
S-708	1	Foglamp Harness Fits bulbs No. 880, 881, 884, 885, 886, 889, 890, 892, 893, 894, 896, 899. Buick97-89 Cadillac91-90, 86 Eagle94 Ford97-90 Ford Light Trucks97-93 Oldsmobile97-92 Pontiac97-92 Saturn97-95		S-773	1	Socket Assembly Chrysler: 4864259 Tail stop and turn signal lamps. Chrysler89-82 Dodge89-82 Dodge Trucks89-82 Plymouth89-88	





SOCKETS, PIGTAILS & SWITCHES

SOCKET ASSEMBLIES

SOCKET ASSEMBLIES WITH 2 WIRE LEAD

Part No.	Pkg. Qty.	Description	Illustration	Part No.	Pkg. Qty.	Description	Illustration
S-778	1	Socket Assembly Chrysler: 4636363 Back-up lamp. Chrysler 91 Dodge 91 Plymouth 91		S-830	1	Socket Assembly Back-up lamp Buick 96-91	
S-789	1	Socket Assembly License plate, park, side marker, tail lamps. Buick 03-92 Cadillac 04-92 Chevrolet 03-93 GM Light Trucks 04-94 Oldsmobile 03-95 Pontiac 03-93		S-835	1	Socket Assembly Back-up lamp Dodge 88-82	
S-806	1	Socket Repair Assembly OEM: F1TZ-13411B Back-up, cornering, parking, turn & stop lamps. Ford Vehicles 04-90		S-841	1	Socket Assembly Back-up lamp. Ford Truck 03-92 Ford Van 97-96 Lincoln 02-96 Mercury 07-95	
S-807	1	Socket Repair Assembly OEM: F1TZ-13411G Back-up, parking & stop lamps. Ford Vehicles 04-90		S-842	1	Socket Assembly Back-up lamp. Ford 99-96 Mercury 00-99	
S-810	1	Socket Repair Assembly OEM: F1TZ-13411A Back-up lamp, turn signal. Ford Vehicles 03-96		S-856	1	Socket Assembly Back-up lamp. Ford 87	
S-815	1	Socket Repair Assembly OEM: F85Z-13411AA Running board lights. Ford Vehicles 04-98		S-858	1	Socket Assembly Back-up lamp. Acura 95-88 Nissan 92-80	
				S-863	1	Socket Assembly Stop, turn & taillight lamps. Chevrolet 61-60	
				S-877	1	Socket Assembly Park, turn signal & taillight Lamps Ford Truck 06-03	

















SOCKET ASSEMBLIES WITH 3 WIRE LEAD

Part No.	Pkg. Qty.	Description	Illustration	Part No.	Pkg. Qty.	Description	Illustration
S-54	1	Socket Repair Assembly (8093203, 9814823) Park, tail, stop, turn signal. Fits lamps No. 1034, 1154, 1157. Buick 90-77 Cadillac 99-77 Chevrolet 90-69 Oldsmobile 90-76 Pontiac 86-76		S-59	1	Socket Repair Assembly. (8902458, 8902487, 8909908, 8907701) Park, tail, stop, turn signal. Fits lamps No. 1034, 1154, 1157. Buick 72-68 Cadillac 73 Oldsmobile 73-70	
S-55	1	Socket Repair Assembly GM: 8903202, 8914822 IHC: 571722C91 Park, tail, stop, turn signal. Fits lamps No. 1034, 1154, 1157. Buick 83-76 Cadillac 86-76 Chevrolet 86-69 GM Light Truck 91-73 Oldsmobile 89-76 Pontiac 83-76		S-65	1	Socket Repair Assembly (8909517) Park, stop, tail, turn signal. Fits lamps No. 1154, 1157. Buick 79-76 Cadillac 93-87, 79-77 Chevrolet 78-77 Oldsmobile 88-71 Pontiac 79-70	

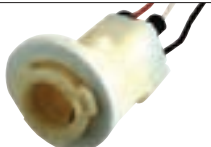
SOCKET ASSEMBLIES



SOCKET ASSEMBLIES WITH 3 WIRE LEAD

Part No.	Pkg. Qty.	Description	Illustration	Part No.	Pkg. Qty.	Description	Illustration
S-68	1	Socket Repair Assembly (D3AZ-13410D, D4OZ-13234A, D4OZ-13410A) Park, stop, tail, turn signal. Fits lamp No. 1157. Ford79-73 Lincoln79-77		S-505	1	Socket Repair Assembly (3513558, 3764561, 3764863) Stop, tail & turn signal. Chrysler83-80, 75-80 Dodge90-78, 74 Dodge Trucks91-82 Plymouth90-71	
S-69	1	Socket Repair Assembly AMC: 3690736, 8124663 Chry.: 13588833, 3764123 Ford: D2FZ-13410A, D3AZ-13410B, D5DZ, D5VY-13410A. Park, stop, tail, turn signal. Fits lamp No. 1157. American Motors80-77 Ford Motor Co. Cars...80-73 Plymouth-Barracuda...74-73		S-507	1	Socket Repair Assembly (12003757) Stop, tail & rear turn signal lamps. Buick96-81 Cadillac02-86 Chevrolet96-80 GM Light Trucks02-82 Oldsmobile96-82 Pontiac95-81	
S-76	1	Socket Repair Assembly Pair of socket assemblies. (8913503) Park, turn signal and cornering. Bulb No. 1156, 1157. Buick-Rivera74-73		S-510	1	Socket Repair Assembly (D3AZ-13410G) Fits stop, tail, & turn signal. Ford80-73 Lincoln80-77 Mercury80-74	
S-77	1	Socket Repair Assembly (8919916, 12013813) Park & turn signal. Fits lamps No. 1034, 1154, 1157. Buick96-79 Cadillac99-82 Chevrolet96-76 GM Light Trucks94-79 Oldsmobile99-79 Pontiac95-92		S-511	1	Socket Repair Assembly (D3MY-13410A, D4DZ-13234A, D54Y-13234A) Fits park and turn signal. Ford76-74 Mercury77-73	
S-86	1	Socket Repair Assembly Double contact with ground lead. Fits 1/8" hole. Park, turn, stop, tail & corner lights. Fits lamps No. 1034, 1154, 1157. Universal applications.		S-512	1	Socket Repair Bracket Assembly (D4LY-13410A) Fits stop, tail & turn signal. Lincoln79-73 Mercury78-75	
S-91	1	Socket Repair Assembly Double contact with ground wire and mounting plate 1 1/2" by 1 1/4" Stop, tail & turn lights. Fits lamps No. 1034, 1154, 1157. Universal applications.		S-519	1	Socket Repair Assembly For park and turn signal lamps. Ford: D1FZ-13234A, D7FZ-13234C. Used with lamp No. 1157. Ford78-73 Ford Trucks92-75 Mercury78-75	
S-502	1	Socket Repair Assembly Chry.: 4331051, GM: 12003759. Fits back-up, tail, stop and turn signal lamps. Buick96-77 Cadillac02-77 Chevrolet96-77 Chrysler, Dodge89-85 GM Light Trucks02-78 Oldsmobile96-77 Pontiac96-77		S-520	1	Socket Repair Assembly Socket assembly for front turn signal or parking lamps. Ford: D4OZ-13234A, D7FZ-13234A, D7FZ-13234B, D. Used with lamp No. 1157. Ford80-74 Lincoln80 Mercury80-77	
S-504	1	Socket Repair Assembly (3843245, 3843432, 4163003) Park & front turn signal, side marker, tail, stop or rear turn signal. Chrysler Corp. Cars....92-75 Dodge Trucks91-78		S-521	1	Socket Repair Assembly Socket assembly for front turn signal lamps. Ford: D4ZZ-13234A. Used with lamp No. 1157. Ford77-74 Ford HD Trucks92-89 Mercury80	
				S-522	1	Socket Repair Assembly For tail, stoplight or rear turn signal lamps. Ford: D70Z-13410A, E1FZ-13234A, E2VY-13410A, E25Y-13410A. Used with lamp No. 1157. Ford90-70	

SOCKET ASSEMBLIES

SOCKET ASSEMBLIES WITH 3 WIRE LEAD

Part No.	Pkg. Qty.	Description	Illustration	Part No.	Pkg. Qty.	Description	Illustration
S-525	1	Socket Repair Assembly For halogen bulb headlamp assembly with 3 prongs and 9004/9007 bulb with blue housing, weather-pack seal, three No. 9 1/2" 18 ga. leads. Chry: 4400395; 4414332; 4430976; 4439076.		S-584	1	Socket assembly Park & turn signal, side marker, stop & turn lamps. Buick.....99-91 Cadillac.....03-98, 92-90 Chevrolet.....03-97, 94-90 GM Light Trucks.....03-94 Oldsmobile.....03-93, 91-90 Pontiac.....03-90	
S-526	1	Socket Repair Assembly Fits domestic and import vehicles with 3-prong headlights.		S-585	1	Socket Repair Assembly For back-up, stop, tail and rear turn signal lamps. (12083680) Buick.....96-91 Cadillac.....93-89 Oldsmobile.....94-90	
S-531	1	Socket Repair Assembly For parking lamps. Ford: E1FZ-132234A. Ford.....90-79 Lincoln.....92-82 Mercury.....90-79		S-590	1	Socket Repair Assembly Socket assembly for back-up, stop, tail or rear turn signal lamps. (12076946) Cadillac.....99-94 Chevrolet.....03-00, 96-90 GM Light Trucks.....03-89 Oldsmobile.....96-90 Pontiac.....96-88	
S-532	1	Socket Repair Assembly Chry: 4368264, 4400740 Chrysler Corp. Cars.....89-86		S-600A	1	Socket Assembly For stop, tail, or rear turn signal lamps. (4399576) Chrysler.....89, 84-80 Dodge.....89, 84-81 Dodge Truck.....90-86 Plymouth.....94-81	
S-533	1	Socket Repair Assembly Tail, stop, turn, side marker - rear. Ford: E2SZ-13410A Ford.....91-80 Mercury.....97-70		S-626	1	Socket Repair Assembly Park and turn lamp socket. (3) 18 Gauge, 8" Leads. Ford, Ford Trucks.....94-74 Mercury.....94-74	
S-547	1	Socket Repair Assembly Ford: ESPZ-13411B Ford.....95-83 Lincoln.....90-87 Mercury.....96-86		S-673	1	Socket Repair Assembly GM: 12030055 Repair harness, stop & tail lamps, park & turn lamps. Buick.....96-91 Cadillac.....96-90 Chevrolet.....96-87 GM Light Trucks.....84-82 Oldsmobile.....98-82 Pontiac.....95-92, 88-84	
S-548	1	Socket Repair Assembly Socket assembly. (12083005, 12092377) back-up, front grille, park or turn signal lamps. Buick.....96-88 Chevrolet.....96-95 Oldsmobile.....99-88 Pontiac.....96-88		S-686	1	Repair Harness Seal Beam Lamp No. H4666 and H6545 3-16 Ga. 8" leads GXL. GM, Firebird, Blazer.....97-93 Ford Probe.....97-93 Chrysler, Daytona, Lazer.....91-89	
S-559	1	Socket Repair Assembly (12083006) For stop, tail and rear signal lamps. Buick.....03-93 Chevrolet.....96-90 Oldsmobile.....96-88 Pontiac.....96-90		S-775	1	Socket Assembly Chrysler: 4857327AA Headlamp, turn signal lamp. Chrysler.....04-01 Dodge.....04-01 Plymouth.....04-01	

SOCKET ASSEMBLIES



SOCKET ASSEMBLIES WITH 3 WIRE LEAD

Part No.	Pkg. Qty.	Description	Illustration	Part No.	Pkg. Qty.	Description	Illustration
S-776	1	Socket Assembly Park, turn & side lamps, tail, stop, turn signal lamps. Chrysler04-90 Dodge04-90 Plymouth.....04-90 Wrangler03-97		S-844	1	Socket Assembly Headlight and flasher. American Motors54-40 Chevrolet Truck69-40 Chrysler63-40 GMC Truck63-54 Jeep74-58 Lincoln69-58	
S-779	1	Socket Assembly Chrysler: 5288917AA Park & turn signal lamps. Dodge03-00 Plymouth.....03-00		S-845	1	Socket Assembly Headlight and flasher. Same as S-844 but with mounting bracket.	
S-783	1	Socket Assembly Ford: F1TZ-13411C Turn signal lamp. Ford04-00		S-847	1	Socket Assembly Park & turn signal lamps. Acura94-88 Mercury.....96 Nissan92-80 Subaru93-90 Toyota.....93-80	
S-786	1	Socket Assembly Front park/turn, rear park/stop/turn, headlamps. Ford04-96 Ford Trucks04-96 Mercury.....04-96		S-862	1	Socket Assembly Park & turn signal lamps. Chrysler95-90 Dodge92-89 Dodge Truck92-91	
S-787	1	Socket Assembly Ford: F1TZ-13411A Front turn/park, rear stop/park/turn Ford04-96 Ford Trucks01-96		S-866	1	Socket Assembly Headlight and flasher. 3-wire head light socket for most vehicles using headlamp No. 4002, 4003, 4005, 5040, 5042, 5400, 5402, 5421, 6006, and 6012. Also fits two and three prong flashers.	
S-791	1	Socket Assembly Chrysler: 4636362 Tail, stop, turn signal socket. Chrysler94-91 Dodge94-91 Plymouth.....94-91		S-868	1	Socket Assembly Stop, turn & taillight lamps. Cadillac99-94 Chevrolet04-97 Chevrolet Truck06-98 GMC Truck00-95 Pontiac97-93	
S-797	1	Socket Assembly Ford: E1AZ-13410A Front turn/park, rear, stop, tail, turn lamps. Ford94-81		S-872	1	Socket Assembly Park & turn signal lamps. Chrysler92-90 Dodge05-01	
S-808	1	Socket Assembly Ford: F3LY-13411 Park & turn lamps. Ford Vehicles.....03-93		S-874	1	Socket Assembly Park & turn signal lamps. Ford08-05 Ford Truck08-03	
S-809	1	Socket Assembly Ford: F47Z-13411 Side marker, stop, tail & turn lamps. Ford Vehicles.....03-96		S-878	1	Socket Assembly Park & turn signal lamps. Ford04-03	
S-829	1	Socket Assembly Stop, turn & taillight lamps. Cadillac97-92 Chevrolet02-93 Chevrolet Truck01-96 GMC Truck02-95 Oldsmobile.....97-94 Pontiac.....97-93		S-879	1	Socket Assembly Park & turn signal lamps. Ford08 Ford Truck08-03 Mercury.....08-04	
				S-890	1	Socket Assembly Stop, turn & taillight lamps. Ford04-00	
				S-891	1	Socket Assembly Stop, turn & taillight lamps. Ford Truck03-97	

SOCKETS, PIGTAILS & SWITCHES

PIGTAIL ASSEMBLIES

PIGTAIL ASSEMBLIES WITH SINGLE WIRE LEAD							
Part No.	Pkg. Qty.	Description	Illustration	Part No.	Pkg. Qty.	Description	Illustration
S-81	1	Voltage Regulator Pigtail Chrysler Corp. Vehicles..... 69-65		S-655	1	Coolant Temp/Oxygen Sensor Repair Harness. Buick.....96-87 Cadillac.....96-87 Chevrolet.....96-87 GM Light Trucks.....96-87 Oldsmobile.....96-87 Pontiac.....96-87 Mates with S554	
S-550	1	Pigtail Assembly GM 12051234: 12102621 For GM radiator fan temperature switch. Special multiple lock, multi-seal connector with 10" 18 Ga. crosslink polyethylene lead. Buick.....95-90, 88-82 Cadillac.....95-93, 85-82 Chevrolet.....01-82 GM Light Trucks.....02-88 Oldsmobile.....92-82 Pontiac.....01-82		S-733	1	Pigtail Assembly Auxiliary engine cooling fan harness, auxiliary fan control switch. Chevrolet.....96-91 GM Light Trucks.....95-91	
S-554	1	Pigtail Assembly Repair For exhaust oxygen sensor with one 18 Ga. lead 8" long. Buick.....98-91 Chevrolet.....98-92 GM Trucks.....98-82 Oldsmobile.....98-91 Pontiac.....98-91 Mates with S655		S-790	1	Pigtail Assembly Plug, cigar lighter (accessory). Chrysler.....98-97 Dodge.....00-95 Dodge Light Trucks.....99-97 Plymouth.....00-95	
S-582	1	Pigtail Repair Assembly For carburetor choke heater. Gray with 7" lead, 18 Ga. Buick.....96-93, 91-82 Cadillac.....88-84 Chevrolet.....96-82 Oldsmobile.....95, 91-82 Pontiac.....90-82		S833	1	Pigtail Repair Assembly Stereo power connector. Chevrolet Truck.....86-73 GMC Truck.....87-73	
S-635	1	Switch and Sensor Connector Fits No. 8 and M4 terminals. Buick.....93-92, 90-82 Chevrolet.....95-94 GM Light Trucks.....95-94 Oldsmobile, Pontiac.....94-82		S839	1	Pigtail Repair Assembly Brake fluid level sensor connector. GMC Truck.....02-90	
S-639	1	Oil Pressure Switch Pigtail For 1-pin switches. GM vehicles. GM: 12085500 Buick.....02, 97, 88-87 Cadillac.....99 Chevrolet.....02, 90, 88-87 GM HD Trucks.....02-92 GM Light Trucks.....02-98 Oldsmobile.....02, 97, 88-87 Pontiac.....02, 97, 88-86		S840	1	Pigtail Repair Assembly Trunk release switch connector. Buick.....96-84 Cadillac.....88-84 Chevrolet.....95-84 Oldsmobile.....95-89	
S-643	1	Repair Harness GM 12117353 Fuel pump instrument panel. Buick.....95-90 Chevrolet.....02-90 GM Light Trucks.....03-89 GM Medium Duty.....02-01 Oldsmobile.....94-90 Pontiac.....02-90		S843	1	Pigtail Repair Assembly Starter relay connector. Ford.....98-89 Lincoln.....97-89 Mercury.....00-90	
				S853	1	Pigtail Repair Assembly A/C compressor clutch relay connector. Dodge.....89-85 Dodge Truck.....87-85 Plymouth.....87-85	

PIGTAIL ASSEMBLIES





















PIGTAIL ASSEMBLIES WITH 2 WIRE LEAD

Part No.	Pkg. Qty.	Description	Illustration	Part No.	Pkg. Qty.	Description	Illustration
S-78	1	Alternator Pigtail Fits Delco alternators with integral regulator Buick.....88-70 Cadillac.....85-70 Chevrolet.....85-74 GM Trucks.....86-70 IHC Trucks.....82-70 Oldsmobile.....85-70		S-556	1	Pigtail Repair Assembly For manifold air temperature. (MAT) GM Vehicles.....03-84	
				S-560	1	Pigtail Repair Assembly Radiator fan temperature control switch. 14 Ga. leads 7" long, and gray connector. Fits Ford or Mercury cars with 2.3L Eng. 91-81.	
S-79	1	Alternator Pigtail Repair Harness Chrysler Vehicles.....88-85		S-562	1	Pigtail Repair Assembly GM ignition coils. Comes with grey plug. Buick.....95-91, 88-85 Cadillac.....95-90, 86-85 Chevrolet.....95-85 GM Light Trucks.....95-85 GM HD Trucks.....98-88 GEO.....93-90 Isuzu.....94-87 Jeep.....86-85 Oldsmobile.....95-90, 88-85 Pontiac.....95-85	
S-84	1	Alternator Pigtail With color coded wires. Delco equipped with external regulator. GM Cars.....73-70 GM Trucks.....86-70 IHC Trucks.....82-70 Older Cars & Trucks		S-563	1	Pigtail Repair Assembly GM ignition coils. Comes with black plug. Buick.....95-91, 88-85 Cadillac.....95-90, 86-85 Chevrolet.....95-85 GM Light Trucks.....95-85 GM HD Trucks.....98-88 GEO.....93-90 Isuzu.....94-87 Jeep.....86-85 Oldsmobile.....95-90, 88-85 Pontiac.....95-85	
S-85	1	Blower and Compressor Relay Pigtail Older Cars & Trucks		S-566	1	Pigtail Repair Assembly Ford engine fan switches. Ford, Mercury.....86-84	
S-536	1	Pigtail Assembly A.C. compressor low pressure switch, A.C. cycling switch, A.C. refrigerant pressure switch. GM vehicles w/V-5 compressor. GM Vehicles.....01-85		S-567	1	Pigtail Repair Assembly Ford air charge temp. sensor. Ford.....95-81 Ford Light Trucks.....01-81 Lincoln.....94-81 Mercury.....95-81	
S-537	1	Pigtail Assembly A.C. clutch field. Ford Vehicles.....89-81		S-568	1	Pigtail Repair Assembly GM cooling fan motors. GM: 22048271, 22074968, 22074969. Replaces GM: 12101906, 917. Buick.....03-90 Cadillac.....02-89 Chevrolet.....03-90 GM Light Trucks.....00-92 Medium Duty.....02-00, 98-90 Oldsmobile.....02-87 Pontiac.....04-86	
S-538	1	Pigtail Assembly A.C. Compressor High Pressure Switch. GM: 12085521 GM vehicles w/V-5 compressor. Buick.....96-86 Cadillac.....93-92, 88-87 Chevrolet.....95-86 GM Trucks.....97-90 Oldsmobile.....95-86 Pontiac.....95-86		S-553	1	Pigtail Repair Assembly Repairs GM 12043215, 12085498 For cornering and fog lamps with halogen bulbs. With two 18 Ga. leads 7" long. Buick.....96-87 Cadillac.....02-87 Chevrolet.....02-87 GM Light Trucks.....03-88 Medium Duty.....02-92 Oldsmobile.....03-87 Pontiac.....03-84	
S-553	1	Pigtail Repair Assembly Repairs GM 12043215, 12085498 For cornering and fog lamps with halogen bulbs. With two 18 Ga. leads 7" long. Buick.....96-87 Cadillac.....02-87 Chevrolet.....02-87 GM Light Trucks.....03-88 Medium Duty.....02-92 Oldsmobile.....03-87 Pontiac.....03-84		S-573	1	Pigtail Repair Assembly For electric voltage regulator. (2983727) Chrysler Vehicles.....95-72	

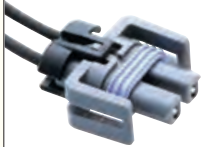
SOCKETS, PIGTAILS & SWITCHES

PIGTAIL ASSEMBLIES

PIGTAIL ASSEMBLIES WITH 2 WIRE LEAD

Part No.	Pkg. Qty.	Description	Illustration	Part No.	Pkg. Qty.	Description	Illustration
S-575	1	Pigtail Repair Assembly GM: 12102747. For windshield washer pump or low coolant sensor. Buick.....03-87 Cadillac.....04-92 Chevrolet.....03-90 GM Light Trucks.....03-87 Medium Duty.....04-90 Oldsmobile.....03-87 Pontiac.....04-87		S-610	1	Air Conditioning Cycling Switch Harness Ford.....95-83 Ford Trucks.....95-83 Lincoln.....95-83 Mercury.....95-83	
S-576	1	Pigtail Repair Assembly For mixture control solenoid connector. For 2 or 4 barrel Rochester Varajet Carburetors. GM Vehicles.....90-80		S-612	1	Coolant Temperature Sensor Harness Ford.....01-83, 81-80 Ford Light Trucks.....01-79 Lincoln.....01-98, 96-80 Mazda.....94-91 Mercury.....01-83, 81-80 Nissan.....99-96	
S-578	1	Pigtail Repair Assembly For sealed type horn connector. Fits GM 1999161, 10456327, 10456328. Buick.....96-88 Cadillac.....96-91 Chevrolet.....96-88 Oldsmobile.....96-88 Pontiac.....96-88		S-614	1	Power Window Motor Harness GM: 12101914 Buick.....93-90 Cadillac.....93-90 Chevrolet.....95-93 GM Light Trucks.....03-94 Oldsmobile.....96-90 Pontiac.....95-90	
S-581	1	Pigtail Repair Assembly Pigtail and assembly repair with 12" leads. Radiator cooling fan motor 4 cylinder engine and heater blower motors. Ford.....89-79 Ford Trucks.....86-82		S-633	1	A/C Clutch Switch Connector GM Vehicles.....96-82	
S-583	1	Pigtail Repair Assembly For Ford ignition coil. Ford, Mercury.....87-77 Lincoln.....84-75		S634	1	Air Switch Valve Pigtail GM Vehicles.....95-87	
S-587	1	Pigtail Repair Assembly. For throttle body injection. GM cars with direct injection. GM: 12085496 Buick.....96, 93-92, 90-87 Chevrolet.....99, 97-87 GM Light Trucks.....02-87 Medium Duty.....99-90 Oldsmobile.....99, 96, 93-87 Pontiac.....97-96, 93-87		S-636	1	Air Diverter Valve Pigtail GM Vehicles.....96-87	
S-588	1	Pigtail Repair Assembly AC clutch. GM: 12101937 Buick.....03-89 Cadillac.....04-89 Chevrolet.....03-89 GM Light Trucks.....03-87 Medium Duty.....03, 93-90 Oldsmobile.....03-89 Pontiac.....04-89		S-641	1	Oil Pressure Switch Pigtail For 2 pin switches. GM Vehicles.....99-85	
S-596	1	Windshield Washer Pump Repair Harness fits pump No. E3AZ-17664A, E0AZ-17664A. Ford.....94-68 Lincoln.....94-68 Mercury.....94-68		S-647	1	Repair Harness Washer fluid sensor connector, back-up lamp switch connector, A/C compressor switch connector. GM: 12101903 Buick.....93-90, 87-85 Cadillac.....87-85 Chevrolet.....02-91 GM Light Trucks.....95-90 Medium Duty.....02-98 Oldsmobile.....92-85 Pontiac.....02-95, 91-86	
				S-648	1	Repair Harness Diode and leads air conditioner compressor. Buick.....87-85 Cadillac.....89-83 Chevrolet.....87-86 Oldsmobile.....87-86 Pontiac.....87-86	
				S-649	1	Repair Harness Coolant sensor connector. Buick.....95-83 Cadillac.....90-85 Chevrolet.....96-85 Oldsmobile.....94-85 Pontiac.....95-85	

PIGTAIL ASSEMBLIES



PIGTAIL ASSEMBLIES WITH 2 WIRE LEAD

Part No.	Pkg. Qty.	Description	Illustration	Part No.	Pkg. Qty.	Description	Illustration
S-650	1	Repair Harness GM: 12085524 Multi-purpose connector. Park lamp, inline-to turn signal lamp, fog lamp, inline-to aux. turn signal, fuel sensor, inline-to rear license plate, inline-to rear body harness, inline-to park and turn signal, inline-to fwd. lamp harness, inline-to front position lamp, side marker lamp. Mate with S751. Buick96-88 Cadillac.....03, 01, 99-86 Chevrolet.....03-90 GM Light Trucks03-90 Medium Duty.....04-90 Oldsmobile.....03-99, 96-87 Pontiac.....03-99, 97-85		S-683	1	Pigtail Repair Assembly Repair harness windshield washer sensor. Ford Light Trucks90-86	
				S-685	1	Pigtail Repair Assembly Repair harness fuel injector. Ford96-85 Lincoln96-85 Mercury.....96-85	
				S-689	1	Repair Harness Replaces 12101855 Direct ignition, door lock actuator, actuator No. 22144362, 22144363 2-18 Ga. GXL 8" leads. Buick03-92 Cadillac03-87 Chevrolet03-88 GM Light Trucks03-87 Medium Duty03-90 Oldsmobile.....03-92 Pontiac.....03-90	
S-651	1	Pigtail Repair Assembly GM: 12085489. Cooling fan temp. sensor. Buick87-85 Chevrolet85 GM Light Trucks89-87 Medium Duty03-94 Oldsmobile.....87-85 Pontiac.....91, 86-85		S-691	1	Pigtail Repair Assembly Repair harness, air bag 2-22 Ga. 8" leads. Ford97-85	
S-653	1	Pigtail Repair Assembly GM: 12101933. Distributorless ignition module repair harness. (Ignition coil harness) Chevrolet02-90 GM Light Trucks00-95 Pontiac.....02-95, 90-87		S-695	1	Repair Harness Straight lamp socket base for wedge bulb. Green hardshell. 2-18 Ga. TXL 8" leads. Ford Windstar99-95	
S-663	1	Pigtail Repair Assembly Repair harness idle air by-pass valve. Ford, Lincoln.....98-84 Mercury.....98-86		S-696	1	Repair Harness Fuel injector 2-18 Ga. 8" leads w/off set index Lucas & Bosch injectors. Domestic & Import Vehicles.	
S-667	1	Pigtail Repair Assembly GM: 12101820 Repair harness body markerlamp switch ground block, cargo lamp switch, wiper motor, power seat-front vertical motor, lumbar pump. Buick03-86 Cadillac03-86 Chevrolet03-93 GM Light Truck94-92 Oldsmobile.....03-86 Pontiac.....03-93		S-697	1	Repair Harness Fuel injector 2-18 Ga. 8" leads w/external spring clip retainer. Lucas & Bosch injectors. Domestic & Import Vehicles.	
				S-699	1	Repair Harness Vehicle speed sensor A.B.S. wheel speed sensor 2-18 Ga. GXL 8" leads. Ford97-93	
				S-705 ET-411	1	Alternator Pigtail Extender Internal regulator harness. GMC95-69 Buick95-69 Cadillac95-69 Ford HD Trucks92 Freight Liner Trucks....92-89, 87-73 Jeep92-75 Oldsmobile88-70 Pontiac87-70	
S-670	1	Pigtail Repair Assembly Ford: F3XY-12A112A Repair harness pick-up or crankshaft sensor. Ford Light Trucks.....95-83 Nissan.....94-82		S-709	1	Speaker Harness GM: 12085520 Buick96-88 Cadillac88 Chevrolet96-88 Oldsmobile.....92-88 Pontiac.....88	
S-681	1	Pigtail Repair Assembly Repair harness lamp socket base 90° Ford Light Trucks.....96-91					

PIGTAIL ASSEMBLIES











PIGTAIL ASSEMBLIES WITH 2 WIRE LEAD

Part No.	Pkg. Qty.	Description	Illustration	Part No.	Pkg. Qty.	Description	Illustration
S-712	1	Pigtail Repair Assembly A/C solenoid, air diverter valve, ambient temperature sensor, back-up alarm, back-up lamp, exhaust oxygen sensor, fog lamp, electronic brake control module, idle air control valve, windshield washer pump motor, speed sensor. GM: 12085485		S-751	1	Pigtail Assembly Inline female 2-way connector used on cars, trucks, stationary engines, farm and industrial equipment. Features: current capacity of 20 Amp., silicone seals, machine crimped terminals, temperature rating of -40°F to 275°F fuel/coolant/brake fluid resistant. Mate with S650.	
S-715	1	Repair Harness Garage door opener. Door opener No. 12344978 GM Vehicles 80		S-757	1	Pigtail Assembly Radiator cooling motor for fan motor No. 4546538, 4546540..... Chrysler 95-91 Dodge 95-91 Plymouth 95-91	
S-717	1	Pigtail Assembly GM: 12085535 Ashtray lamp, fog lamp, floor console, interior lighting, rear view mirror, side marker lamp, van mirror, radio speaker, lumbar switch, door lock switch, parking brake switch, windshield wiper & wiring. Buick 03-86 Cadillac 04-86 Chevrolet 03-87 GM Light Trucks 03-89 Medium Duty 04-92 Oldsmobile 03-87 Pontiac 04-88		S-792	1	Pigtail Assembly GM: 12102921 GM alternator adapter harness converts the new style (CS Series) GM alternators to be used in older GM vehicles (SI Series). Use on vehicles without alternator warning light or if vehicle has gauge. GM Vehicles 95-88	
S-722	1	Repair Harness GM: 25117765 Fuel pump adapts fuel pumps wiring and fuel pump with pin terminals. Cadillac 92-90 Chevrolet 92-88 GM Light Trucks 95-87 Pontiac 93-88		S-799	1	Pigtail Assembly Brake lamp switch. Ford Vehicles 03-98	
S-727	1	Repair Harness Oil pressure switch, vehicle speed sensor switch No. 4707015, 5233397. Sensor No. 4439096, 5227897. Chrysler Vehicles 92-85		S-811	1	Pigtail Assembly GM: 12127120 Inline brakes, engine, lamp, wheel speed sensor. GM Vehicles 04-95	
S-735	1	Pigtail Assembly Parking brake switch, cruise control release switch, cruise control switch. GM Light Trucks 95-92, Medium Duty 94-93		S-812	1	Pigtail Assembly Cam shaft and crank shaft sensors. Ford Vehicles 04-91	
S-737	1	Pigtail Assembly Ford 90 Amp. alternators. Ford 94-74		S-816	1	Pigtail Assembly Running board lights, evaporator solenoids. Ford Vehicles 04-99	
S-740	1	Pigtail Assembly Windshield washer pump. GM Cars & Trucks 91-82		S-818	1	Pigtail Assembly GM: 12126499 ABS wheel, speed sensor. Ford Vehicles 04-92	
S-743	1	Pigtail Assembly Back-up lamp switch. Ford 97-89 Ford Light Trucks 04-80 Ford Med. Trucks 98-94 Mercury 97-89		S-819	1	Pigtail Assembly Ignition Coil. Ford Vehicles 04-99	
				S-820	1	Pigtail Assembly Windshield washer pump. Ford Vehicles 04-97	
				S-823	1	Pigtail Assembly Ford: 1F1Z-14A411BA Brake lamp switch. Ford Vehicles 04-00	



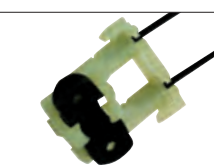

PIGTAIL ASSEMBLIES

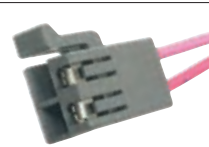

PIGTAIL ASSEMBLIES WITH 2 WIRE LEAD

Part No.	Pkg. Qty.	Description	Illustration	Part No.	Pkg. Qty.	Description	Illustration
S-824	1	Pigtail Assembly Fuel injectors (with oval injector connectors). Ford Vehicles.....04-99		S-893	1	Pigtail Repair Assembly Backup light connector. Ford Truck05 Lincoln02-00 Mercury.....06-04	
S-826	1	Pigtail Assembly GM: 12101888 Window lift motors. GM Vehicles04-90		S-904	1	Pigtail Repair Assembly Fuel pump connector. Ford93-87	
S-827	1	Pigtail Assembly Radiator cooling (motor & resistor) Ford Vehicles.....03-95		SK25	1	Fuel Injector Solenoid Connector Pigtail. Multi-purpose. Replaces GM No. 12085491 Buick.....03-86 Cadillac.....02-92 Chevrolet03-87 GM Light Trucks03-96 Oldsmobile.....02-86 Pontiac.....03-86	
S-831	1	Pigtail Repair Assembly Stoplight switch connector. Ford94-80 Ford Truck94-80		SK29	1	Fuel Injection Pump Delivery Valve Wiring. Injector-fuel, In-line-to-fuel injector Solenoid-brake pressure molule valve. GM Vehicles99-86	
S-838	1	Alternator Adapter Harness Used to convert older vehicles with SI Series alternator and with warning light to newer CS series alternator. GM Vehicles95-88		TX3A	1	Multi-Purpose Repair Harness AMC: 8983502327 GM: 12046623 Buick03-86 Cadillac.....02-92 Chevrolet03-87 GM Light Trucks03-96 Oldsmobile.....02-86 Pontiac.....03-86	
S-848	1	Pigtail Repair Assembly Cigar lighter connector. Buick95-80					
S-849	1	Pigtail Repair Assembly Stereo speaker connector. Ford.....89-88					



PIGTAIL ASSEMBLIES WITH 3 WIRE LEAD

Part No.	Pkg. Qty.	Description	Illustration	Part No.	Pkg. Qty.	Description	Illustration
S-64	1	Pigtail Repair Assembly Fits dimmer switches with 3 12" wire leads. American Motors81-67 Chrysler Vehicles.....80-65 Ford Vehicles.....81-65		S-82	1	Pigtail For Manual A.C. Relay Not supplied by O.E.M. American Motors80-67 Buick.....88-70 Cadillac.....84-70 Chevrolet86-70 Chrysler Vehicles.....91-70 GM Trucks86-70 IHC Trucks.....86-70 Oldsmobile.....88-70 Pontiac.....87-70 Older Cars & Trucks	
S-72	1	Pigtail Repair Assembly For floor mounted dimmer switches. Buick83-63 Cadillac82-63 Chevrolet84-63 GM Trucks86-63 IHC Trucks.....80-57 Oldsmobile.....81-70 Pontiac.....84-65		S-83	1	Power Servo Pigtail Not supplied by O.E.M. GM Vehicles73-63 Older Cars & Trucks	

SOCKETS, PIGTAILS & SWITCHES

PIGTAIL ASSEMBLIES

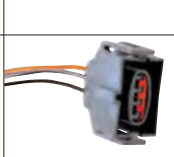



PIGTAIL ASSEMBLIES WITH 3 WIRE LEAD

Part No.	Pkg. Qty.	Description	Illustration	Part No.	Pkg. Qty.	Description	Illustration
S-92	1	Alternator Pigtail Repair Harness With color-coded wires. Ford Vehicles..... 81-65		S-579	1	Pigtail Assembly Repair For 3-terminal heavy duty, thermal or electronic flashers. For cars, trucks, tractors, trailer and industrial applications.	
S-539	1	Pigtail Repair Assembly Ford ignition coil, EEC-IV. Ford Vehicles..... 91-81		S-594	1	A/C Pressure Switch Repair Harness GM: 12085507 Cadillac..... 97-86 Oldsmobile 88-84 Pontiac 88-84	
S-542	1	Pigtail Repair Assembly Alternator pigtail repair. Ford Vehicles..... 89-81		S-595	1	MAP Sensor Repair Harness GM: 12085502 Buick..... 03-82 Chevrolet..... 03-82 GM Light Trucks..... 99-90 Medium Trucks..... 98-90 Oldsmobile 03-82 Pontiac 03-82	
S-545	1	Voltage Regulator Pigtail Ford Vehicles..... 94-81		S-602	1	Ignition Switch Repair Harness AMC 91-69 GM Vehicles 91-69	
S-552	1	Pigtail Assembly Repair GM: 12101895 for voltage regulators of Delco CS type alternators with internal regulators. With two 18 Ga. leads and one 12 Ga. (SXL) wire. Chevrolet 89-87 Oldsmobile..... 89-87 Pontiac..... 89-87		S-613	1	MAP Sensor Repair Harness Ford 91-69 Ford Trucks 91-69 Lincoln 91-69 Mercury 91-69	
S-564	1	Pigtail Repair Harness GM: 12116257 Repair harness for GM throttle position sensors. For GM vehicles with fuel injection. Chevrolet 96-89 GM Light Trucks 98-95 Medium Duty 03, 96-90 Pontiac..... 95-92		S-619	1	Throttle Position Sensor Harness GM: 12102748 Various sensors and switches. Buick..... 03-90 Cadillac..... 04-90 Chevrolet..... 03-90 GM Light Trucks..... 03-90 Medium Duty 03-90 Oldsmobile 03-90 Pontiac 04-89	
S-565	1	Pigtail Repair Harness For Ford EGR sensor. No. E6AZ-9J460A Ford/Mercury 91-88		S-637	1	Oil Pressure Switch Pigtail For 3-pin switches. GM Vehicles..... 99-87	
S-569	1	Pigtail Repair Harness For mass air flow sensor. For GM engines with tuned port injection. GM Cars 88-85		S-640	1	Blower Motor Pigtail (Heavy Duty Applications) Chrysler Trucks 94-85 Ford Trucks 95-86 GM Cars & Trucks 95-86	
S-574	1	Pigtail Repair Harness GM: 12085483 Pigtail repair harness for crankshaft coolant sensor. Also used as a power steering pressure switch connector. Buick..... 96-86 Cadillac..... 94-93, 90-87 Chevrolet 97-90 Oldsmobile..... 95-86 Pontiac..... 96-87		S-656	1	Repair Harness For GM mass airflow sensors. For GM vehicles with fuel injection. Buick..... 96-90 Chevrolet 96-90 Chevrolet Trucks 96-90 Oldsmobile 96-91 Pontiac 95-92	
S-577	1	Pigtail Assembly Repair For camshaft sensor connector. (12085538) Buick..... 90-86 Oldsmobile..... 90-86 Pontiac..... 90-87		S-657	1	Repair Harness Door jamb switch/master cylinder. Ford 96-87 Lincoln 96-87 Mercury 96-87	
				S-674	1	Repair Harness Throttle position sensor connector. Ford 96-90 Ford Light Trucks 96-91 Mercury 96-90	

PIGTAIL ASSEMBLIES







PIGTAIL ASSEMBLIES WITH 3 WIRE LEAD





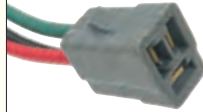

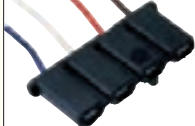

Part No.	Pkg. Qty.	Description	Illustration	Part No.	Pkg. Qty.	Description	Illustration
S-677	1	Repair Harness Exhaust oxygen sensor. Fits 3-wire O2 sensors. Ford90-86 Ford Light Trucks.....90-86 Lincoln.....96-87 Mercury.....96-87		S-725	1	Pigtail Repair Assembly Repair harness, radiator cooling fan motor, fan & shroud assembly No. F4DZ-8C07B, F5CZ-8C607A. Ford Vehicles.....96-90	
S-682	1	Repair Harness Lamp socket base 90°. Ford Light Trucks.....96-91		S-732	1	Pigtail Assembly GM: 12126058 Blower motor resistor connector. Chevrolet92 GM Light Trucks96-90 GM Med. Trucks.....96-90 Pontiac.....92	
S-688	1	Socket and Pigtail Assembly Replaces 12126444 repair harness electric ride control sensor No. 22076335. 3-22 Ga. GPT 8" lead. Buick.....96, 94-93 Cadillac.....95, 93 Chevrolet97-90 Oldsmobile.....99-92 Pontiac.....99-94		S-734	1	Pigtail Assembly GM: 12101851 Cigarette lighter ashtray lamp, inline-to instrument panel. Buick.....91-87 Cadillac.....04 Chevrolet95, 91-89 Oldsmobile.....91 Pontiac.....91	
S-690	1	Repair Harness Inertia fuel shut off switch. Switch No. E8AZ-9341-A, F02Z-A, FZA-A. 2-18 GA. SXL 8" leads. Ford97-90		S-738	1	Pigtail Assembly Chrysler: 4897087AA Camshaft, crankshaft sensors. Chrysler98-97 Dodge00-95 Dodge Light Trucks99-97 Plymouth.....00-95	
S-694	1	Repair Harness Repair harness straight lamp socket base for wedge bulb. Brown hardshell 3-18 Ga. TXL 8" leads. Ford Windstar97-95		S-745	1	Pigtail Assembly Lamp socket base, power steering pressure, brake master cylinder. Ford02-95 Mercury.....02-95	
S-711	1	Pigtail Repair Assembly GM: 12117354 Stop lamp switch, stop lamp, torque converter switch, torque converter clutch switch. Buick.....96-92 Cadillac.....96-93 Chevrolet02-91 GM Light Trucks99-92 Oldsmobile.....96-91 Pontiac.....02-91		S-747	1	Pigtail Assembly Chrysler: 2926502 Neutral safety switch No. 2932820, 3747361, 4057750 AMC.....88-72 Chrysler01-69 Dodge01-69 Dodge Light Trucks01-69 IHC.....80-62 Jeep01-80 Plymouth.....01-69	
S-724	1	Pigtail Repair Assembly GM: 12117025 Repair harness, crank position sensor, electric brake module, cooling fan motor, coolant level switch & various sensors. Buick.....03-91 Cadillac.....03-91 Chevrolet03-90 GM Light Trucks03-91 Oldsmobile.....03-91 Pontiac.....04-91		S-750	1	Pigtail Assembly Universal. Inline male 3-way connector used on cars, trucks, stationary engines, farm and industrial equipment. Features: current capacity of 20 Amp., silicone seals, machine crimped terminals, temperature rating of -40°F to 257°F, fuel/coolant/ brake fluid resistant. Mates with S758.	

PIGTAIL ASSEMBLIES

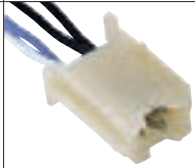
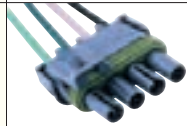
PIGTAIL ASSEMBLIES WITH 3 WIRE LEAD

Part No.	Pkg. Qty.	Description	Illustration	Part No.	Pkg. Qty.	Description	Illustration
S-758	1	Pigtail Assembly Inline female 3-way connector used on cars, trucks, stationary engines, farm and industrial equipment. Features: current capacity of 20 Amp., silicone seals, machine crimped terminals, temperature rating of -40°F to 257°F, fuel/coolant/brake fluid resistant. Mates with S750.		S-821	1	Pigtail Assembly Ford: 1U2Z-14S411TA Alternator, brake fluid level sensor. Ford Vehicles 04-96	
S-760	1	Socket Assembly Headlight switch. Ford 94-80 Lincoln 94-90 Mercury 94-80		S-855	1	Pigtail Repair Assembly Tailgate window connector. Buick 72-64 Chevrolet 72-64 Oldsmobile 72-64 Pontiac 72-64	
S-785	1	Pigtail Assembly EGR position sensor. Ford 95-85 Ford Light Trucks 96-85 Lincoln 92-86 Mercury 93-85 Medium Duty 03-90		S-867	1	Pigtail Repair Assembly Throttle position sensor connector. Ford 05-94 Ford Truck 05-96	

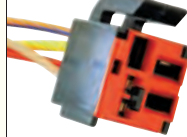
PIGTAIL ASSEMBLIES WITH 4 WIRE LEAD

Part No.	Pkg. Qty.	Description	Illustration	Part No.	Pkg. Qty.	Description	Illustration
S-93	1	Voltage Regulator Pigtail Repair Harness Delco: 7700 With color coded wires. GM Vehicles 73-61 IHC Trucks 80-63		S-555	1	Pigtail Repair Assembly GM: 12085506 For idle air control valve, with four 18 Ga. leads with seal 10" long. Fits GM Vehicles with fuel injection 95-82.	
S-527	1	Pigtail Repair Assembly GM: 12085483 For rear radio speakers. Buick 91-86 Chevrolet 92 Oldsmobile 91-86 Pontiac 91-87		S-558	1	Pigtail Socket Assembly Repair For idle speed control. Fits GM V6, V8 models with carburetor 81-87.	
S-528	1	Pigtail Repair Assembly For rear radio speakers. GM Vehicles 87-78		S-561	1	Connector Kit For fuel pump sending unit of Ford vehicles and also general purpose applications. Comes with 4 wire connector and a set of female 18/20 Ga. terminals and 14/16 Ga. terminals. Ford 90-85	
S-530	1	Pigtail Repair Assembly For GM or Delco radio connectors. GM Cars 82-78		S-598	1	Fuel Pump Relay Repair Harness Ford 96-92 Ford Trucks 96-92 Lincoln 96-82 Mercury 96-82	
S-551	1	Pigtail Assembly Repair Harness (Multi-Purpose) GM Cars 96-85					

PIGTAIL ASSEMBLIES



PIGTAIL ASSEMBLIES WITH 4 WIRE LEAD

Part No.	Pkg. Qty.	Description	Illustration	Part No.	Pkg. Qty.	Description	Illustration
S-601	1	Heater Resistor Repair Harness GM Vehicles92-70		S-658	1	Repair Harness Mass Airflow Sensor Ford92-89 Lincoln92-89 Mercury.....92-89	
S-604	1	Voltage Regulator Module Harness GM Vehicles95-86		S-660	1	Repair Harness Turn Signal Switch 4 leads. Ford93-86	
S-617	1	Fan Speed Switch Harness Buick, Chevrolet94-77 GM Trucks95-86 Oldsmobile, Pontiac....94-77		S-668	1	Repair Harness GM: 12085530 Repair harness windshield washer motor. Buick87-84 Cadillac.....88-85 Chevrolet89-84 Oldsmobile.....86-84 Pontiac.....87-84	
S-620	1	Tail Lamp Repair Harness GMC Trucks96-88		S-687	1	Pigtail Repair Assembly Replaces 12102677. Repair harness, blower motor switch. For rear compartment switch. No. 14040842. Buick98-95, 93-91 Chevrolet03-90 GM Light Trucks.....03-98, 95-92 Medium Trucks94-90 Oldsmobile.....03-01, 98-90 Pontiac.....03-90 Suburban96-84	
S-624	1	Fan Speed Switch Harness For applications: Ford93-86 Mercury.....93-86 Ford Trucks92		S-698	1	Repair Harness Electronic ignition module. 4-16 Ga. SXL leads. Ford97-95	
S-627	1	Oxygen Sensor Pigtail 4 Leads - (3) 18 Gauge, (1) 16 Gauge. Ford94-89 Ford Trucks94-89 Lincoln94-89 Mercury.....94-89		S-700	1	Repair Harness Replaces 12085533 transmission converter clutch. 3-18 Ga. (GPT) 8" leads. Buick.....93-91, 86-84 Cadillac.....90-85 Chevrolet93-74 GM Light Trucks96-85 Oldsmobile.....92-91, 88-84 Pontiac.....93-85	
S-628	1	Ignition Switch Repair Harness Ford94-86 Mercury.....94-86		S-706	1	Relay Harness Audi96-93 Chrysler96-87	
S-629	1	Ignition Module Repair Harness (Main Wiring Harness) Ford85-75 Ford Trucks91-75 Mercury.....85-75		S-714	1	Pigtail Repair Assembly GM: 12085487. Heater & A/C control, end gate ajar warning lamp, front side door wiring, seat adjuster motor, power window wiring, power window control wiring, rear compartment lid wiring, rear window defogger switch, windshield wiper switch, windshield wiper motor. Buick96-85 Cadillac.....93-85 Chevrolet02-85 GM Light Trucks03-90 Medium Duty03-00 Oldsmobile.....96-85 Pontiac.....02-85	
S-630	1	Blower Motor Resistor Harness (4) 14 Gauge 8" Leads. Ford Trucks94-86					
S-631	1	Oxygen Sensor Pigtail (4) Leads - (3) 18 Gauge, (1) 16 Gauge. Ford Trucks94-89					
S-638	1	Oil Pressure Switch Pigtail Fits 4-pin switches. Buick92-86 Oldsmobile.....89-86 Pontiac.....88-87					

SOCKETS, PIGTAILS & SWITCHES

PIGTAIL ASSEMBLIES









PIGTAIL ASSEMBLIES WITH 4 WIRE LEAD

Part No.	Pkg. Qty.	Description	Illustration	Part No.	Pkg. Qty.	Description	Illustration
S-719	1	Repair Harness Blower Motor Switch. Switch No. F5RZ-18578A Ford Contour 98-95 Ford Mystique		S-759	1	Pigtail Assembly GM: 12101871 Glow plug controller No. 12088520. Buick.....93-90, 88-84 Cadillac.....90-88 Chevrolet.....99-84 GMC.....99-85 Oldsmobile96-90, 88-84 Pontiac96-84	
S-721	1	Pigtail Repair Assembly GM: 12101885, 939, 12126460. A/C compressor clutch wiring, auto. temp. control blower, hazard lamp flasher, blower motor, turn signal flasher, door lock actuator motor, door lock relay, auxiliary fan control relay, brake pressure module valve, various other relays. Buick 93-90 Cadillac 02-88 Chevrolet 03-86 GM Light Trucks 00-90 Medium Duty 96-90 Oldsmobile..... 93-91 Pontiac..... 03-96, 94-91		S-761	1	Pigtail Assembly GM: 15305942 Crankshaft position sensor. Buick.....03-96 Chevrolet.....03-96, 94, 93 GM Light Trucks.....03-98 Oldsmobile99-96 Pontiac04-96, 94	
S-728	1	Repair Harness Starter relay. Relay No. 5227300. Chrysler Vehicles..... 92-90		S-763	1	Pigtail Assembly Universal. Inline male 4-way connector used on cars, trucks, stationary engines, farm and industrial equipment. Features: current capacity of 20 Amp., silicone seals, machine crimped terminals, temperature rating of -40°F to 257°F, fuel/coolant/brake fluid resistant. Mates with S765.	
S-729	1	Repair Harness GM: 12102757. Repair harness, body marker lamp, dimmer switch, headlamp high beam lamp, headlamp switch lamp, dome lamp switch, end gate lock switch, instrument panel switch, stop lamp, torque converter clutch switch. Buick.....96-90 Chevrolet 96-90 Cadillac 96-93 GMC Trucks 96-90 Oldsmobile..... 02-90 Pontiac..... 96-90		S-765	1	Pigtail Assembly Inline female 4-way connector used on cars, trucks, stationary engines, farm and industrial equipment. Features: current capacity of 20 Amp., silicone seals, machine crimped terminals, temperature rating of -40°F to 257°F, fuel/coolant/brake fluid resistant. Mates with S763.	
S-730	1	Repair Harness Inline To Lighting Ford Vehicles.....97-94		S-784	1	Pigtail Assembly A/C blower switch. Ford..... 94-90	
S-754	1	Pigtail Assembly GM:12085537 Neutral & part switch, alternators, wheel/vehicle speed sensors, rear windshield wiper switch. Buick..... 98-86 Cadillac..... 96-87 Chevrolet 98-90 GM Light Trucks 02-90 Oldsmobile..... 96-86 Pontiac..... 98-87		S-795	1	Pigtail Assembly GM: 88987185, 15305925 Park neutral position switch, back-up lamp, inline-to aux. heater rear harness, inline-to back-up lamp & stop lamp, inline-to battery positive cable, inline-to park neutral position switch. Buick.....02-96 Cadillac.....99-96 Chevrolet.....03-95 GM Light Trucks.....03-95 Medium Trucks03-00 Oldsmobile03-95 Pontiac03-95	



PIGTAIL ASSEMBLIES



PIGTAIL ASSEMBLIES WITH 4 WIRE LEAD

Part No.	Pkg. Qty.	Description	Illustration	Part No.	Pkg. Qty.	Description	Illustration
S-805	1	Pigtail Assembly Ford: F81Z-19D887AA A/C clutch cycling pressure switch. Ford Vehicles.....02-94		S-850	1	Pigtail Repair Assembly Blower switch connector. Chrysler86-84 Dodge90-83 Dodge Truck.....95-81	
S-814	1	Pigtail Assembly ABS, air ride compressor, anti-skid relays. Ford Vehicles.....02-94		S-857	1	Pigtail Repair Assembly Relay connector. Buick.....90-80	
S-817	1	Pigtail Assembly GM: 15305801 Oxygen sensor. GM Vehicles04-95		S-860	1	Pigtail Repair Assembly Multi-purpose connector Buick.....93-91 Cadillac.....91 Oldsmobile.....93-91 Pontiac.....91	
S-825	1	Pigtail Assembly Rear lamp assembly without pickup box. Ford Trucks04-90		S-861	1	Pigtail Repair Assembly Blower switch connector. Buick.....90-80	
S-834	1	Pigtail Repair Assembly Ignition control module connector. Chrysler95-88 Dodge95-88 Dodge Truck.....95-87 Plymouth.....95-89					



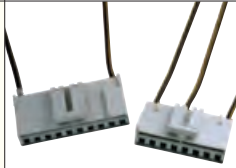
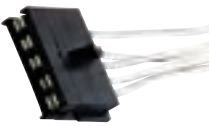



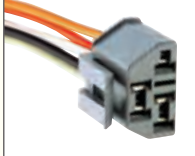

PIGTAIL ASSEMBLIES WITH 5 WIRE LEAD

Part No.	Pkg. Qty.	Description	Illustration	Part No.	Pkg. Qty.	Description	Illustration
S-516	1	Socket Assembly (3588421) Fits Chrysler ignition control unit. Chrysler Vehicles.....83-72		S-605	1	Mass Airflow Sensor Harness GM: 12085497 Buick.....88 Cadillac.....87 Chevrolet89-85 GM Light Trucks88-85 Oldsmobile.....88-85 Pontiac.....96, 89-85	
S-549	1	Pigtail Assembly Repair (E4FZ-8C290). Engine cooling fan module harness repair kit. Kit contains one 8-position connector, one 10-position connector, and five 4" 12 Ga. terminated solderless leads. Ford, Mercury w/AC.....89-81		S-615	1	Cooling Fan Relay Harness GM Vehicles88-85	

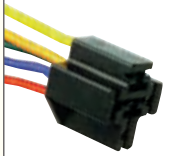
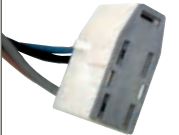
SOCKETS, PIGTAILS & SWITCHES

PIGTAIL ASSEMBLIES

PIGTAIL ASSEMBLIES WITH 5 WIRE LEAD

Part No.	Pkg. Qty.	Description	Illustration	Part No.	Pkg. Qty.	Description	Illustration
S-621	1	Turn Signal Switch Harness Ford, Mercury 94-81 Ford Trucks 95-85 Lincoln 94-80		S-742	1	Pigtail Assembly GM: 12085501 Relays, fuel pump, blower motor & daytime running lamps. Buick.....92, 90-88 Chevrolet.....92-87 Gm Light Trucks.....99-98, 96-87 Medium Trucks.....96-90 Oldsmobile92-90	
S-625	1	Heater and A/C Blower Harness (5) 12 Gauge, 5" Leads. Ford, Lincoln, Mercury 94-73		S-752	1	Pigtail Assembly Blower motor switch No. E83Z-19986A. Ford.....94-90 Mercury94-90	
S-652	1	Repair Harness Distributorless ignition modules/data connector. GM: 12101880 Buick.....93, 91-87 Cadillac.....88-87 Chevrolet96-87 GM Light Trucks94 Oldsmobile.....96-87 Pontiac.....93, 91-87		S-753	1	Pigtail Assembly GM: 12117277 Brake pressure modulator valve solenoid, electronic brake control module, front axle 4WD actuator No. 26060073, stop & tail turn signal. Buick.....90 Cadillac.....04, 90 GM Light Trucks.....00-97 Pontiac90	
S-654	1	Universal Applications Fits all 4 & 5 terminal relays. Various Cars & Trucks 95-82		S-762	1	Pigtail Assembly A/C blower motor resistor No. 4462978. Chrysler.....95-90	
S-659	1	Repair Harness EEC Relay Ford96-83 Mercury.....96-83		S-780	1	Pigtail Assembly Aux. blower switch. Ford.....96-95	
S-718	1	Kit, Repair Harness, Horn & Blower Relays Relay No. FOA8-14B193. Ford Cars & Trucks 97-90		S-781	1	Pigtail Assembly Blower motor switch Ford HD Trucks.....89-80	
S-726	1	Repair Harness Instrument panel flood lamp, panel and dome lamp switch, fuel sensor, headlamp switch, ignition start switch. GM Light Trucks 96-90 Oldsmobile.....96-95 Pontiac.....91-90		S-803	1	Pigtail Assembly GM: 15306045 Various relays, fuel pump, headlamp, blower, ABS, horn. GM Vehicles.....04-93	
S-736	1	Pigtail Assembly GM: 12102565 Inline-to rear lamp. Chevrolet 96-92		S-897	1	Pigtail Repair Assembly Diesel glow plug relay connector. Ford Truck.....97-94	

PIGTAIL ASSEMBLIES



PIGTAIL ASSEMBLIES WITH 6 WIRE LEAD







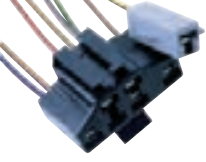

Part No.	Pkg. Qty.	Description	Illustration	Part No.	Pkg. Qty.	Description	Illustration
S-94	1	Voltage Regulator Pigtail Repair Harness. With color-coded wires. Ford Vehicles.....81-65		S-713	1	Repair Harness Ford: F2AZ-14489W. Kit repair harness, ignition switches Ford01-90 Ford Light Trucks.....01-92 Lincoln01-90 Mercury.....01-98, 95-90	
S-544	1	Ignition Module Pigtail (Grey) Ford Vehicles.....91-81		S-716	1	Repair Harness Ignition switch, switch No. DOTZ-11572A, SW944. Ford Trucks93-70	
S-546	1	Ignition Module Pigtail (Black) Ford Light Trucks.....91-88		S-749	1	Pigtail Assembly GM: 12102763 Stop lamp switch. GM Light Trucks03-94 Medium Duty03	
S-606	1	Headlamp Switch Repair Harness GM Vehicles95-88		S-764	1	Pigtail Assembly Universal. Inline female 6-way connector used on cars, trucks, stationary engines, farm and industrial equipment. Features: Current capacity of 20 Amp., silicone seals, machine crimped terminals, temperature rating of -40°F to 257°F, fuel/coolant/brake fluid resistant. Mates with S788.	
S-611	1	Ignition Switch Repair Harness Ford95-86 Ford Truck95-86 Lincoln95-86 Mercury95-86		S-788	1	Pigtail Assembly Universal. Inline male 6-way connector used on cars, trucks, stationary engines, farm and industrial equipment. Features: Current capacity of 20 Amp., silicone seals, machine crimped terminals, temperature rating of -40°F to 257°F, fuel/coolant/brake fluid resistant. Mates with S764.	
S-679	1	Repair Harness Wiper motor. Ford96-87 Ford Light Trucks.....96-87 Lincoln96-87 Mercury.....96-87		S-802	1	Pigtail Assembly Blower relays GM Vehicles90-70	

PIGTAIL ASSEMBLIES WITH 7 WIRE LEAD

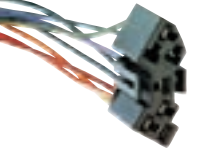

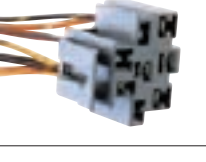

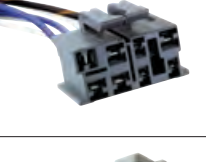
Part No.	Pkg. Qty.	Description	Illustration	Part No.	Pkg. Qty.	Description	Illustration
S-665	1	Repair Harness Turn signal switch. Ford Light Trucks.....95-90 Mercury.....98-97		S-796	1	Pigtail Assembly GM: 15305887 Park neutral position switch & back-up lamp. Buick.....02-96 Cadillac.....99-96 Chevrolet03-95 GM Light Trucks03-95 Medium Duty03-00 Oldsmobile.....03-95 Pontiac.....03-95	
S-678	1	Repair Harness Wiper motor. Ford96-87 Ford Light Trucks.....96-87 Lincoln96-87 Mercury.....96-87					

PIGTAIL ASSEMBLIES

PIGTAIL ASSEMBLIES WITH 8 WIRE LEAD

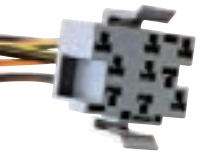
Part No.	Pkg. Qty.	Description	Illustration	Part No.	Pkg. Qty.	Description	Illustration
S-609	1	Test Harness EEC-IV test plug harness. Ford 94-83 Ford Trucks 94-83 Lincoln 94-83 Mercury 94-83		S-692	1	Repair Harness Neutral safety switch, back-up, transmission, lever position switches, daytime running lights 8-16 Ga. GPT wire leads. Replaces F2PZ-14A46C F4UB-A Ford 97-90 Ford Light Trucks 97-90	
S-622	1	Turn Signal Switch Harness Ford 94-81 Ford Trucks 95-85 Lincoln 94-80 Mercury 94-81		S-723	1	Repair Harness Manual lever position sensor, used in place of connector. Supplied w/switch for early models and O.E. switch for late models. Switch No. F5TZ-7A247A. Ford Vehicles 97-84	
S-623	1	Headlamp Switch Harness Ford 95-86 Mercury 95-90		S-798	1	Pigtail Assembly Ford: F2PZ-14A464C Daytime running lamp, control module, neutral safety/back-up/lever position switches. Ford Vehicles 94-90	
S-632	1	Headlamp Switch Harness Mercury 89-86		S-846	1	Pigtail Repair Assembly Distributor connector. Chevrolet Trucks 91-85 GMC Trucks 91-85	
S-675	1	Headlamp Switch Harness Headlamp switch. Ford 93-87					



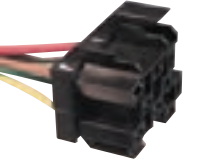

PIGTAIL ASSEMBLIES WITH 9 WIRE LEAD

Part No.	Pkg. Qty.	Description	Illustration	Part No.	Pkg. Qty.	Description	Illustration
S-607	1	Headlamp Switch Repair Harness Ford Cars 00-79 Ford Trucks 99-87		S-801	1	Pigtail Assembly Ford: F2PZ-14A464B Transmission solenoid assy (shift & throttle pressure control). Ford Vehicles 94-90	
S-661	1	Repair Harness Turn Signal Switch Ford 93-86		S-896	1	Pigtail Repair Assembly Diesel glow plug relay connector. Ford Trucks 97-94	
S-720	1	Repair Harness Headlamp switch. Switch No. 56007043. Chrysler Vehicles 97-90 Dodge Light Trucks 98-94					

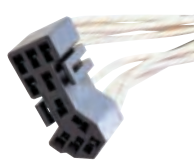

PIGTAIL ASSEMBLIES

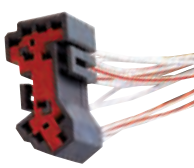
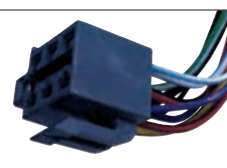

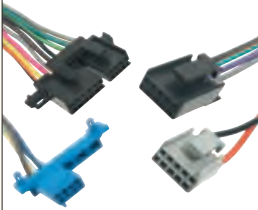

PIGTAIL ASSEMBLIES WITH 10 WIRE LEAD

Part No.	Pkg. Qty.	Description	Illustration	Part No.	Pkg. Qty.	Description	Illustration
S-662	1	Repair Harness Turn signal switch. Ford92-86		S-672	1	Repair Harness Ignition switch. GM Light Trucks90-67 GM HD Trucks85-67	
S-664	1	Repair Harness EEC Relay Turn signal switch. Ford95-90		S-782	1	Pigtail Assembly Blower switch. Ford Light Trucks94-90	
S-666	1	Socket and Pigtail Assembly Repair harness HVAC control switch. Ford95-88		S-836	1	Pigtail Repair Assembly Stereo power connector. Buick95-85 Cadillac95-86 Chevrolet95-85 Oldsmobile95-86 Pontiac95-86	

PIGTAIL ASSEMBLIES WITH 11 WIRE LEAD

Part No.	Pkg. Qty.	Description	Illustration	Part No.	Pkg. Qty.	Description	Illustration
S-804	1	Pigtail Assembly GM: 12101833 Various switches, blower motor, door lock, power window etc., various modules and Inline connector. GM Vehicles04-88		S-822	1	Pigtail Assembly Ford: 1U2Z-14S411BXA Headlamp switch. Ford Explorer, Ranger ...04-95	

PIGTAIL ASSEMBLIES WITH 12 WIRE LEAD

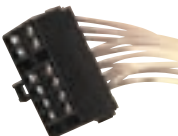
Part No.	Pkg. Qty.	Description	Illustration	Part No.	Pkg. Qty.	Description	Illustration
S-744	1	Pigtail Assembly Ignition control module. Ford Vehicles02-92		S-813	1	Pigtail Assembly Transmission lever position sensor. Ford Ranger04-95 Ford Explorer04-95	
S-800	1	Pigtail Assembly GM: 12167155 Headlamp switch. GM Vehicles02-95					

PIGTAIL ASSEMBLIES WITH 15 WIRE LEAD

Part No.	Pkg. Qty.	Description	Illustration
S-756	1	Pigtail Assembly Ford: F6HZ-14A464FUA Ignition switch No. D7AZ-11572A. Ford78-77 Ford Light Trucks85-80 Mercury78-77	

SOCKETS, PIGTAILS & SWITCHES

UNIVERSAL SWITCHES

TOGGLE SWITCHES 2 POSITIONS



DS-116

Toggle Switch

Universal 2-position, single pole, single throw. UL approved toggle switch. Furnished with 2 screw terminals. Mounting stem dia. $\frac{19}{32}$ ", length $\frac{3}{8}$ ". Rating: 125 Volt 10 Amp., 250 Volt 5 Amp.

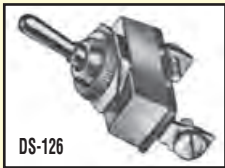

DS-126

Toggle Switch

Universal heavy duty, 2-position, single pole, single throw, toggle switch. Furnished with "OFF-ON" face plate and 2 screw terminals. Mounting stem dia. $\frac{15}{32}$ ", length $\frac{3}{8}$ ". Rating: 6 Volt 35 Amp., 12 Volt 20 Amp.



DS-167

Toggle Switch

Universal heavy duty, zinc diecast. 2-position, single pole, single throw, toggle switch. Furnished with "ON-OFF" face plate and 2 screw terminals. Mounting stem dia. $\frac{19}{32}$ ", length $\frac{3}{8}$ ". Rating: 12-24 Volt, 50 Amp.



DS-184

Toggle Switch

Universal 2-position, single pole, single throw, toggle switch. Furnished with 6" lead wires. Mounting stem dia. $\frac{19}{32}$ ", length $\frac{5}{8}$ ". Rating: 125 Volt 6 Amp., 250 Volt 3 Amp.

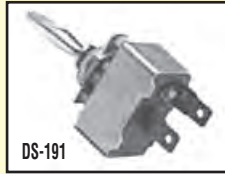

DS-191

Toggle Switch

Universal 2-position, zinc diecast, single pole, single throw furnished with "OFF-ON" face plate. 2 heavy slide terminals and chrome plated handle.



DS-226

Toggle Switch

2-position, Double Pole, Single Throw, "ON-OFF" toggle switch with 4 screw terminals. Mounting stem dia. $\frac{5}{16}$ ", length $\frac{15}{16}$ ". Rating: 12 Volt DC 35 Amp., 125 Volt 15 Amp., 250 Volt 10 Amp.



DS-310

Toggle Switch

2-position plastic toggle switch with 2 slide terminals. Rating: 12 Volt 10 Amp.

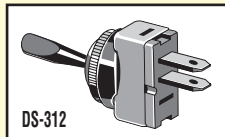

DS-312

Toggle Switch

Non-illuminated momentary "ON". 12 Volt DC 10 Amp.



DS-322

Toggle Switch

Universal 2-position, double pole, single throw, toggle switch. Furnished with 6" lead wires. Mounting stem dia. $\frac{15}{32}$ ", length $\frac{5}{8}$ ". "ON-ON". Rating: 125 Volt 6 Amp., 250 Volt 3 Amp.

TOGGLE SWITCHES 2 POSITIONS - ILLUMINATED

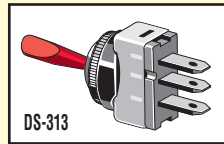

DS-313

Toggle Switch

"ON-OFF", 12 Volt 20 Amp.
DS-313 - Red DS-314 - Amber
DS-315 - Blue DS-316 - Green

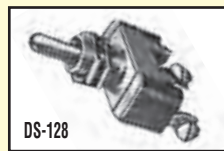

DS-128

Toggle Switch

Universal 3-position, single pole, double throw, "ON-OFF-ON". Underwriters approved toggle switch. With 3 screw terminals. Mounting stem dia. $\frac{15}{32}$ ", length $\frac{1}{2}$ ". Rating: 125 Volt 15 Amp., 250 Volt 10 Amp., 3/4 H.P. 120-240 Volt, AC.



DS-193

Toggle Switch

Universal 3-position, zinc diecast, single pole, double throw, "ON-OFF-ON" furnished with 3 heavy copper screw terminals and chrome plated handle. Mounting stem dia. $\frac{15}{32}$ ", length $\frac{15}{32}$ ". Rating: 12-24 Volt 50 Amp.



DS-194

Toggle Switch

Universal 3-position, zinc diecast, single pole, double throw. Momentary "ON", normally "OFF", momentary "ON". Furnished with 3 heavy copper screw terminals and chrome plated handle. Mounting stem dia. $\frac{3}{32}$ ", length $\frac{15}{32}$ ". Rating: 12-24 Volt 50 Amp.



DS-208

Toggle Switch

Double pole, double throw, 3-position "ON-OFF-ON", 6 heavy duty screw terminals. Mounting stem dia. $\frac{3}{32}$ ". Rating: 125 Volt 15 Amp., 250 Volt 10 Amp.

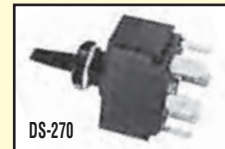

DS-270

Toggle Switch

Double pole, double throw, 3-position "Momentary ON-OFF-Momentary ON", 6 heavy duty screw terminals. Mounting stem dia. $\frac{1}{32}$ ". Rating: 125 Volt 15 Amp., 250 Volt 10 Amp.



DS-271

Toggle Switch

Universal 3-position, "ON-OFF-ON" double pole, double throw toggle switch with 6 terminals. Mounting stem $\frac{15}{32}$ " diameter, $\frac{3}{8}$ " long handle. Thermoplastic housing with Neoprene seal. Used for marine and recreational vehicles. Rating: 12 Volt 10 Amp.

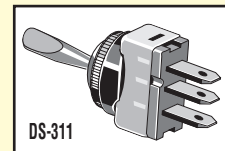

DS-311

Toggle Switch

3-position non-illuminated toggle switch. 12 Volt DC 10 Amp.

DUCK BILL TOGGLE SWITCHES



DS-1339

Toggle Switch

"ON-OFF" black duck bill toggle switch. 20 Amp. "ON-OFF" toggle switch. 20 Amp.

UNIVERSAL SWITCHES



SOCKETS, PIGTAILS & SWITCHES

DUCK BILL TOGGLE SWITCHES



DS-1340
Toggle Switch
"ON-OFF" chrome duck bill toggle switch. 20 Amp.



DS-1341
Toggle Switch
"ON-OFF-ON" duck bill toggle switch. 20 Amp. 12 Volt.
DS-1341 - Black



DS-1342
Toggle Switch
Illuminated, "ON-OFF", 20 Amp. 12 Volt.
DS-1342 - Amber Illuminated
DS-1343 - Blue Illuminated
DS-1344 - Green Illuminated
DS-1345 - Red Illuminated

ROCKER SWITCHES



DS-277
Rocker Switch
For trucks, school buses & recreational vehicles, silver contacts, "OFF-ON" SPST. 2 spade terminals UL Listed, 15 Amp. 125 VAC, 10 Amp. 250 VAC, 35 Amp. 12V DC.



DS-280
Rocker Switch
Universal rocker switch for trucks, buses & recreational vehicles, 35A, 12V silver contact, red illuminated rocker, 2-position "OFF-ON", SPST, 2 spade terminals for circuit. 1 spade terminal for built-in 12V bulb. Black body, white rocker. Kenworth: K-301-1572 OMC: 977743



DS-293
Rocker Switch
Fuel tank selector switch. GM: 14028811; 15591149 GM Trucks..... 88-81



DS-317
Rocker Switch
Illuminated, 2-position, "ON-OFF", blade terminals. Rating: 12 Volt 20 Amp.
DS-317 - Red
DS-318 - Amber
DS-319 - Blue
DS-320 - Green



DS-1332
Rocker Switch
"ON-OFF" twin circuit rocker switch, 20 Amp. Black.



DS-1333
Rocker Switch
Illuminated "ON-OFF" rocker switch, with interchangeable lens and icons. 20 Amp. 12 Volt.



DS-1334
Rocker Switch.
Oval LED illuminated round hole rocker switch, 16 Amp. 12 Volt.
DS-1334 - Amber
DS-1335 - Green
DS-1336 - Red
DS-1337 - Red Spot Illuminated



DS-1338
Rocker Switch
Universal rocker switch for trucks, buses & recreational vehicles. Electric window, antenna switch. 5 blade terminals.

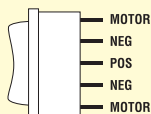

MINI ROCKER SWITCHES



DS-1312
Mini Rocker Switch
"ON-OFF" black mini rocker switch, 10 Amp. 12 Volt.



DS-1313
Mini Rocker Switch
"ON-OFF" LED illuminated mini rocker switch, 10 Amp. 12 Volt.
DS-1313 - Amber
DS-1314 - Green
DS-1315 - Red



DS-1316
Mini Rocker Switch
"Momentary ON-OFF-Momentary ON", black mini rocker, 10 Amp. 12 Volt.



DS-1317
Mini Rocker Switch
"ON-OFF" double pole black mini 10 Amp. 12 Volt.



DS-1318
Mini Rocker Switch
"ON-OFF" illuminated mini rocker switch. 10 Amp. 12 Volt.
DS-1318 - Amber
DS-1319 - Red



DS-1320
Mini Rocker Switch
"ON-OFF" black round rocker. 10 Amp. 12 Volt.



DS-1321
Mini Rocker Switch
"ON-OFF" LED illuminated round spot mini rocker switch, 10 Amp., 12 Volt.
DS-1321 - Amber
DS-1322 - Green
DS-1323 - Red

JUMBO ROCKER SWITCHES

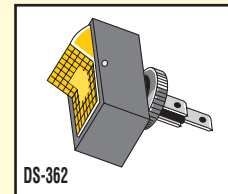

DS-362
Rocker Switch
Universal, heavy duty, illuminated rocker switch. Mounting 1/2" round hole, illuminated in "ON" position. Rating: 20 Amp. 12 Volt.
DS-362 - Amber Illuminated
DS-364 - Red Illuminated
DS-365 - Non-Illuminated
DS-1821 - Green Illuminated

PUSH PULL SWITCHES



DS-123
Push Pull Switch
Universal 2-position, single pole, single throw. Pull "ON", push "OFF" switch. Furnished with large plastic knob, and 2 screw terminals. Mounting stem dia. 15/32", length 1/2". Rating: 6 Volt 20 Amp., 12 Volt, 10 Amp.

UNIVERSAL SWITCHES

PUSH PULL SWITCHES (cont.)

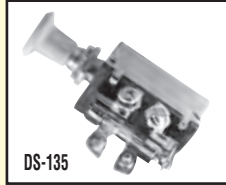

DS-135

Push-Pull Switch
12 Volt, Universal Switch. Push-pull, 3 positions, 5 terminals. Equipped with 15 Amp. fuse. Mounting stem dia. $\frac{7}{16}$ ".



DS-175

Push-Pull Switch
Heavy duty push-pull switch, 6-28 Volt DC, 75 Amp., single pole, single throw, "OFF-ON". Die-cast body, chrome plated metal knob, copper terminals with brass terminal screws. Mounting stem dia. $\frac{5}{16}$ ", length $\frac{5}{8}$ ". Overall dimensions: $3\frac{1}{8}$ " x $1\frac{1}{8}$ " x $\frac{9}{16}$ ".

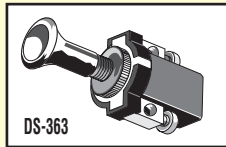

DS-363

Push-Pull Switch
Universal push-pull switch. European styling, black body. Rating: 16 Amp. 12 Volt.



DS-1327

Push-Pull Switch
Long push-pull switch. 16 Amp.



DS-1328

Push-Pull Switch
Illuminated push-pull switch. 16 Amp. 12 Volt.
DS-1328 - Amber
DS-1329 - Blue
DS-1330 - Green
DS-1331 - Red

PUSH BUTTON SWITCHES



DS-246

Push Button Switches
Universal momentary push button switch. "OFF-Momentary ON". Single pole, single throw, with 2 screw terminals. Rating: 125 Volt 6 Amp., 250 Volt 3 Amp.



DS-1307

Push Button Switches
Push ON / Push OFF switch. 16 Amp. 12 Volt LED.
DS-1307 - Non-Illuminated Black
DS-1308 - Illuminated Amber
DS-1309 - Illuminated Green
DS-1310 - Illuminated Red
DS-1791 - Illuminated Blue

MISCELLANEOUS SWITCHES



HB-6B

Horn Button
Horn button with mountable bracket.



HB-7

Horn Button
Universal horn button. Furnished with large ivory colored plastic button mounting bracket. Bronze contact spring and rustproof parts. Insulated-cannot short or ground.



HS-98

Heater Switch
Universal heavy duty, 4-position "ON-HI-MED-LOW", illuminated heater switch. Furnished with maroon face, tan knob, bulb, heavy ceramic base, bracket and 2 screw terminals. 12 Volt. Current rating: Lo 2 Amp., Mid 2.5 Amp., Hi 10 Amp.



SSB-2

Push Button Switch
2 screw terminals, "OFF-Momentary ON", $\frac{5}{16}$ " mounting stem, 12 volt 15 Amp.

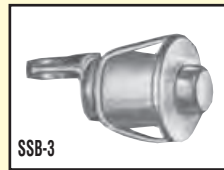

SSB-3

Push Button Switch
Push button, normally open to ground. Rating: 6 Volt 15 Amp., 12 Volt 10 Amp., 24 Volt 6 Amp. Older cars and trucks.



SSB-5

Push Button
Heavy duty, 2 screw terminals, "OFF-Momentary ON", 12 Volt 60 Amp., 24 Volt 40 Amp.



DS-1346

Battery Cut-Off Switch
100 Amp., continuous. For marine, RV, specialty vehicles, farm equipment. Prevent battery drain.

WARNING LIGHTS



DS-1324

Indicator Lamp
Universal, warning indicator lamp with illuminated lens and long life non-replaceable bulb. Includes wire leads for easy installation. Mounting $\frac{1}{2}$ " round hole, 12 Volt applications.

DS-366 - Red
DS-367 - Amber
DS-1324 - Blue
DS-1325 - Green

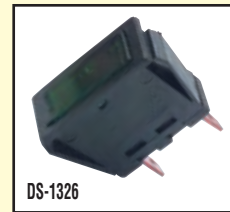

DS-1326

Rectangular Warning Light
12 Volt, Green.

SWITCH PANELS

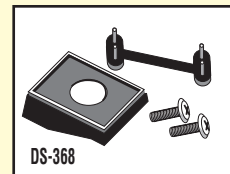

DS-368

Mounting Panel
Switch mounting panel. For $\frac{1}{2}$ " round hole mounting switches.

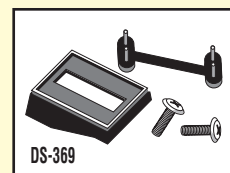

DS-369

Mounting Panel
Switch mounting panel. For $1\frac{1}{8}$ " x $\frac{15}{32}$ " rectangular hole.



DS-1311

Mounting Panel
Switch mounting panel. 2 slots. For $1\frac{1}{8}$ " x $\frac{15}{32}$ " rectangular hole.



Ignition Wires

Battery Cables

Primary Wire

Terminals & Connectors

Trailer Connectors

Sockets, Pigtails & Switches

Safety Accessories

O.E. Interchanges

Index

SAFETY ACCESSORIES

SAFETY ACCESSORIES			
Part No.	Description	Part No.	Description
ET515	Headlight on Reminder Prevents drained batteries - buzzer sounds when ignition is turned off and lights are on. Includes fuse taps and adhesive mounting pad.	ET517	Back-up Alarm Pulse alarm sounds when you shift into reverse. Alarm warns anyone behind your car, van or pickup. Simple two wire connection to back-up lights.
ET516	Trunk or Under Hood Light Provides light under hood or in trunk. Includes mount screw, bulb, cadmium plated holder and 6' wire lead.	ET518	9-Volt Adapter Converts Electronic Hazard Light from accessory plug-in to portable 9 volt battery power.
		ET519	Electronic Strobe Hazard Light Emergency flasher plugs into cigarette lighter or portable adapter. Magnetic base mount. High visibility electronic strobe.



SAFETY ACCESSORIES



SAFETY ACCESSORIES

Part No.	Description	Part No.	Description
ET400	Temporary Lamp Wiring Connector	ET521	Daytime Running Lights Increase daytime visibility of vehicle. Automatically turns on low beam lights. Shuts off with ignition. Includes daytime running light module, wire leads, splices, fuse taps and mounting screw. Installs by connecting module lead wires to 2 or 3 wire headlight system. Detailed instructions are included—read carefully! Not for vehicles with concealed headlights.
ET448	Cigarette Lighter Plug	ET522	Power Reducer Provides 30% low beam light power reduction. Connects to red wire of daytime running light. Mount away from excessive heat. Includes power reducer, splices and mounting screws.
ET520	Wipers on / Headlights on Reminder Reminds driver to turn lights on when weather conditions require wipers. Increases vehicle visibility in inclement daytime weather. Installs by splicing 2 blue leads to the wiper motor and black leads to the instrument lamps fuse and any other lighting fuse. Includes electronic module, splice connector, fuse taps and adhesive mounting strip. Detailed instructions are included—read carefully!		

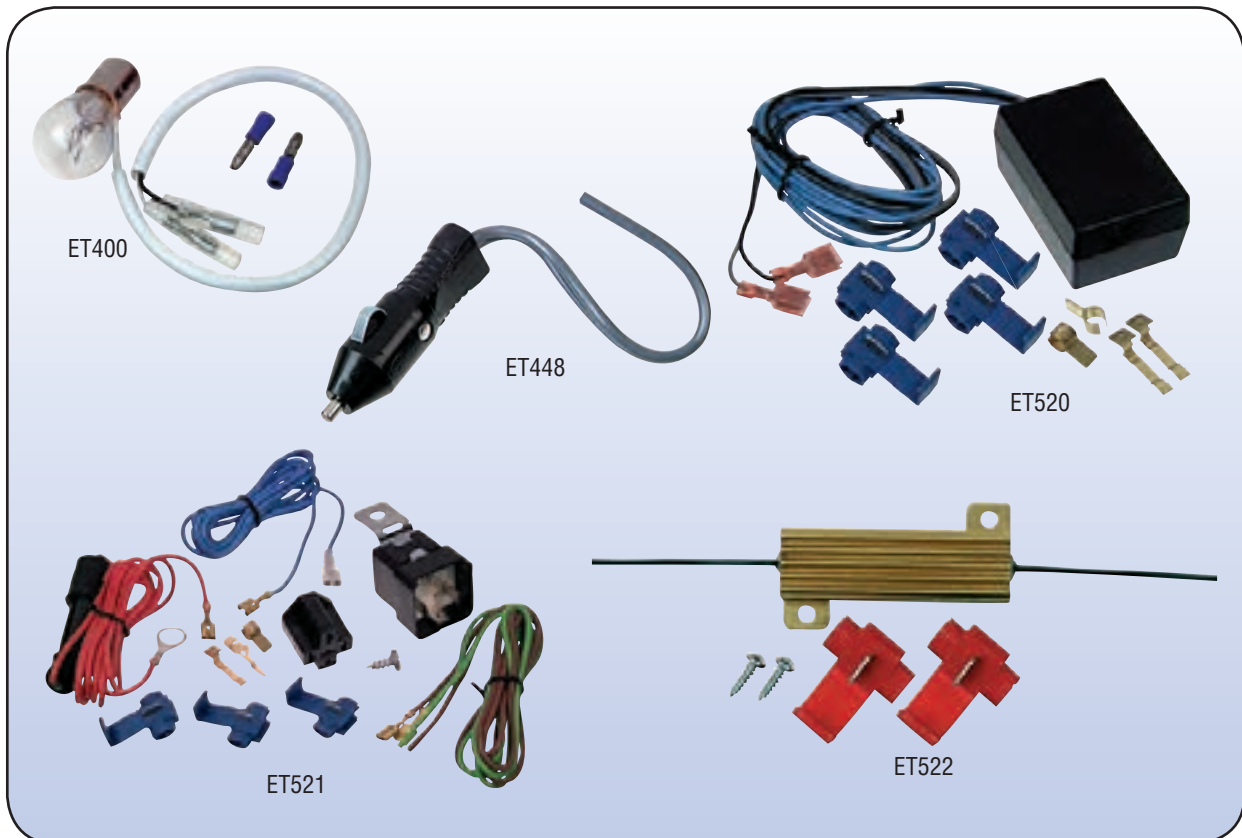

SAFETY ACCESSORIES

BOOSTER CABLES

BOOSTER CABLES TO FIT THE NEEDS OF ALL YOUR CUSTOMERS

- 100% copper conductor
- Soft PVC blend maintains flexibility at extreme temperatures
- Available in 200, 400 or 500 Amp. clamps
- Economy – For occasional or emergency use
- Standard Duty – For frequent use on cars and light trucks
- Heavy Duty – For professional service dealers

ECONOMY

Part No.	Description	Clamp Type	Outer Jacket/ Thermal Rating
BC120	10 gauge 12 ft. 200 Amp.	Utility	Blended PVC
BC128	8 gauge 12 ft. 400 Amp.	Alligator	PVC/ -40° to +140° F

STANDARD DUTY

Part No.	Description	Clamp Type	Outer Jacket/ Thermal Rating
BC126	6 gauge 12 ft. 400 Amp.	Alligator	PVC/ -40° to +140° F
BC166	6 gauge 16 ft. 400 Amp.	Alligator	PVC/ -40° to +140° F
BC124	4 gauge 12 ft. 400 Amp.	Alligator	PVC/ -40° to +140° F
BC164	4 gauge 16 ft. 400 Amp.	Alligator	PVC/ -40° to +140° F
BC204	4 gauge 20 ft. 400 Amp.	Alligator	PVC/ -40° to +140° F

HEAVY DUTY

Part No.	Description	Clamp Type	Outer Jacket/ Thermal Rating
BC165	4 gauge 16 ft. 500 Amp.	Parrot	PVC/ -40° to +140° F
BC254	4 gauge 25 ft. 500 Amp.	Parrot	PVC/ -40° to +140° F
BC202	2 gauge 20 ft. 500 Amp.	Parrot	PVC/ -40° to +140° F

BOOSTER CABLE BAG

Part No.	Description	Qty Per Pkg.
BC100	Booster cable bag	1

Note: Booster cables not available in Canada.

Standard package of 1



BOOSTER CABLES



BOOSTER CABLE CLAMPS

Part No.	Description	Qty Per Pkg.
BP66	Solid copper clamps with color coded plastic handles. 400 Amp. (1 red, 1 black)	2
BP68	Light-duty clamps with copper-plated steel jaws and color-coded vinyl handles. 200 Amp.	2 (1 red, 1 black)
BP87	Metal clamps with copper-plated steel jaws won't crack or break in sub-zero temperatures. 400 Amp. 6' wire lead.	1 pair
BP98R	Heavy-duty "Marquette" type clamp with serrated steel jaws. 400 Amp. 1 per card.	10 cards
BP98B	Same as BP98R—but with black handles. 400 Amp. 1 per card.	10 cards
BP104	800 Amp. professional booster cable clamps.	1 pair
BP104J	Replacement jaw for BP104.	1 pair

Note: Booster cable clamps not available in Canada.

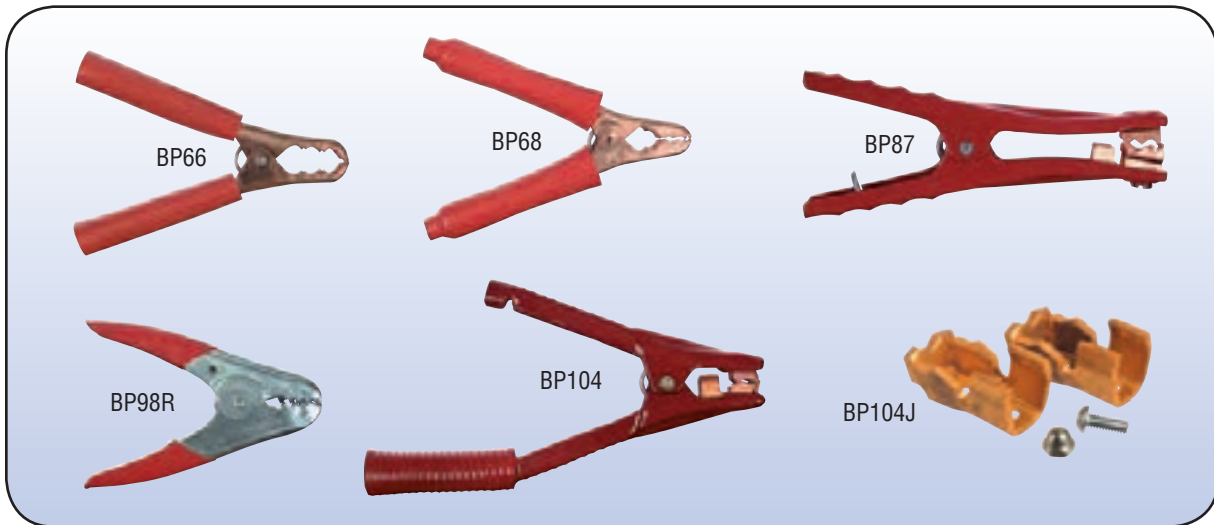

BULK BOOSTER CABLE

- Parallel bonded cable provides tangle free service
- Maintains flexibility in sub zero temperatures

Part No.	Qty	Gauge
BC6DL	50'	6 Ga.
BC4DL	50'	4 Ga.
BC2DL	50'	2 Ga.

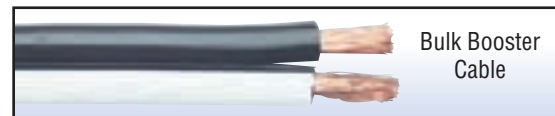

Bulk Booster Cable

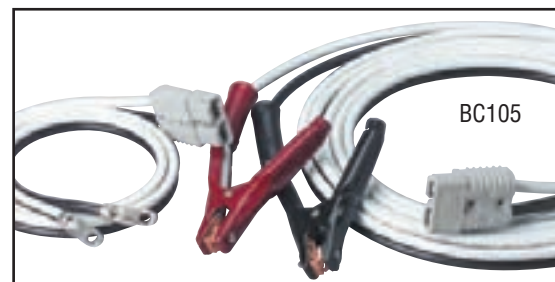

BC105

PLUG-IN 4 GA. INDUSTRIAL BOOSTER CABLES

BC105	25 ft. overall length. 5 ft. section attaches directly to vehicle. 20 ft. section has heavy duty 500 Amp. clamps and snaps easily into permanently mounted cable. Perfect for tow trucks or fork lifts.
BC106	5 foot section. Ideal where multiple tow trucks or fork lifts are used. Protective cap included.

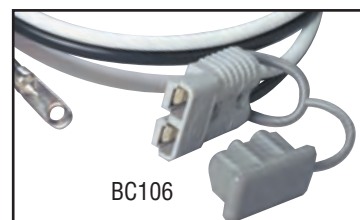

BC106

TROUBLE LIGHTS

- HEAVY DUTY
- BUILT TO TAKE RUGGED HANDLING
- ALL ITEMS SHOWN MEET OSHA STANDARDS AND ARE UL LISTED

FLUORESCENT DROPLIGHTS

Make light of the heaviest jobs! Great additions to repair shops, home workshops, basements, garages! Swivel hook. Tough plastic handle. Resists oil, grease, water, chemicals and vapors. Vinyl-coated wire.

Part No.	Description	Watt Rating	Amp. Rating	Cord Length	Qty. Per Pkg.
ZR95*	Reel light. 18/2 wire, wall mount.	15	.305	25 ft.	1
ZT31	Droplight. 18/2 wire.	15	.305	25 ft.	1
ZT31A	Repl. bulb for ZT31 & ZR95.	15	.305		1
ZT34	Droplight. 18/2 SJT.	13	.285	15 ft.	1
ZT34A	Repl. bulb for ZT34, ZR96.	13	.285		1
ZR96	Mini no switch reel light 18/2 wire, wall mount.	13	.350	40 ft.	1

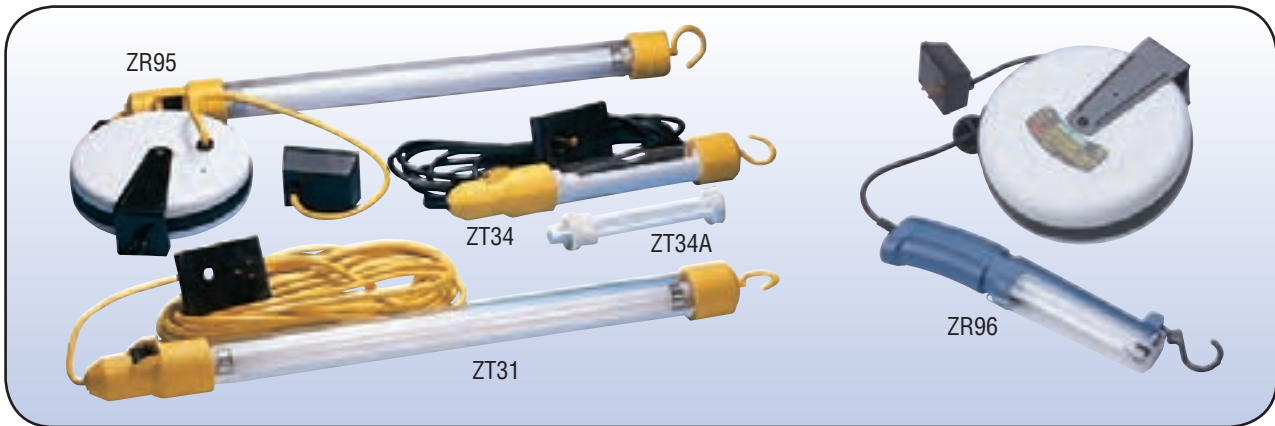

EMERGENCY DROPLIGHT

Part No.	Wire Gauge	Volt Rating	Cord Length	Description	Qty. Per Pkg.
ZT32*	18/2 SPT	12 Volt	15 ft.	w/2pc. Battery Clips	1

TROUBLE LIGHT - 2 WIRE

- Non-conductive plastic cage
- Switch in handle

Part No.	Wire Type	Watt Rating	Amp. Rating	Cord Length	Qty. Per Pkg.
ZT17	18/2 SJT	75	10	25 ft.	1

CORDLESS TROUBLE LIGHT

- Rechargeable, 120V, charger included
- Cordless, use anywhere
- LED

Part No.	Qty. Per Pkg.
ZT37*	1

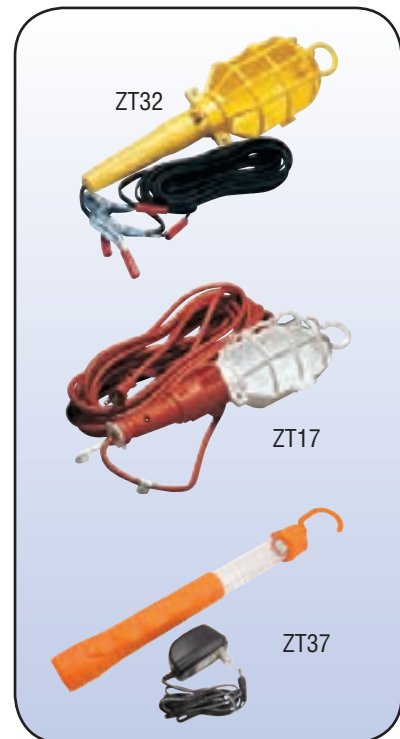

Note: Trouble lights and droplights not available in Canada.

* Available While Supplies Last

TROUBLE LIGHTS & ELECTRICAL CABLE



TROUBLE LIGHT - 3 WIRE

Droplights

- Vinyl cord, Grounded steel cage
- Three-prong extension side outlet

Part No.	Wire Type	Watt Rating	Amp. Rating	Cord Length	Qty. Per Pkg.
ZT11	18/3 SJT	1250	10	25 ft.	1
ZT21	16/3 SJT	1625	13	25 ft.	1
ZT22	16/3 SJT	1625	13	50 ft.	1



ZT11

NO SWITCH TROUBLE LIGHT - 3 WIRE

- Rubber cord flexible to -50°C
- Solid encapsulating injection molding

Part No.	Wire Type	Watt Rating	Amp. Rating	Cord Length	Qty. Per Pkg.
ZT23	18/3 SJT	1250	10	25 ft.	1



ZT23

ELECTRICAL CABLE - 125/250 VOLT - U.L. LISTED

- For use in rewiring drop lights, extension cords, portable tools and equipment

Part No. 100' Spool	Gauge & Cond.	UL Type	Stranding	Jacket	O.D.
C18-2SRB	18 - 2	SJO	41 x 34	Synthetic Rubber/Black	.298
C16-2SRB	16 - 2	SO	65 x 34	Synthetic Rubber/Black	.380
C18-3VY	18 - 3	SJT	16 x 30	Vinyl, Yellow	.328
C16-3SRB	16 - 3	SO	65 x 34	Synthetic Rubber/Black	.400
C16-3VB	16 - 3	SJT	36 x 30	Vinyl, Black	.353
C14-3SRB	14 - 3	SO	41 x 30	Synthetic Rubber/Black	.558

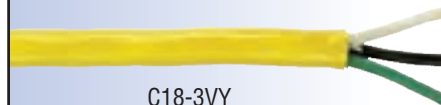

C18-3VY



C16-3SRB

TROUBLE LIGHTS & EXTENSION CORDS

3-WIRE REEL LIGHTS

With grounded side outlet. Durable steel cord housing. Fully retractable. Includes wall or ceiling mounting hardware. Includes switch on handle.

Part No.	Wire Type	Outlet Watt Rating	Outlet Amp. Rating	Cord Length	Qty. Per Pkg.
ZR91	16/3 SJT	1150	9.2	30 ft.	1
ZR92	18/3 SVT	775	6.2	50 ft.	1

ZR92 resettable circuit contains breaker in plug.

NO SWITCH 3-WIRE REEL LIGHTS

With plastic guard housing. Durable steel cord housing. Fully retractable. Includes wall or ceiling mounting hardware.

Part No.	Wire Type	Outlet Watt Rating	Outlet Amp. Rating	Cord Length	Qty. Per Pkg.
ZR97	18/3 SJT	—	—	35 ft.	1

3-WIRE INDOOR/OUTDOOR EXTENSION CORDS

- Rounded vinyl cord for outdoor use
- Weather-resistant and flexible
- Three-prong grounded plug and outlet
- 125 Volt Rating

Part No.	Wire Type	Outlet Watt Rating	Outlet Amp. Rating	Cord Length	Qty. Per Pkg.
ZX50	16/3 SJTW-A	1625	13	10 ft.	1
ZX51	16/3 SJTW-A	1625	13	25 ft.	1
ZX52	16/3 SJTW-A	1625	13	50 ft.	1
ZX53	16/3 SJTW-A	1250	10	100 ft.	1
ZT54	12/3 AGW SJEOW-A	1875	15	25 ft.	1

REPLACEMENT PARTS

Part No.	Description	Qty. Per Pkg.
ZM80	Replacement metal cage for grounded 3-wire lights. Display packaged.	1 bag
ZM81	Replacement plastic cage for ungrounded 2-wire lights Display packaged.	1 bag
ZM82	Replacement handle for 3-wire trouble light. Extended guard ground.	1
ZM85	Replacement socket — 15 Amp. 125 V.	1
ZM86	Replacement plug — 15 Amp. 125 V.	1
ZM87	Replacement push button switch socket. UL Approved.	1

Note: Trouble lights and droplights not available in Canada.





Ignition Wires

Battery Cables

Primary Wire

Terminals & Connectors

Trailer Connectors

Sockets, Pigtails & Switches

Safety Accessories

O.E. Interchanges

Index

O.E. INTERCHANGES

OEM TERMINALS

	Boxed Part #
ET507	CG7 & CG45
ET508	CG8 & CG47
ET701	CG1
ET708	CG2
ET709	CG5
ET704	CG6
ET705	CG18
ET706	CG19
ET707	CG20
ET708	CG7
ET709	CG8
ET710	CG45
ET711	CG46
ET712	CG47
ET713	CG3
ET714	CG4
ET715	CG21
ET716	CG22
ET717	CG23
ET718	CG24
ET719	CG25
ET720	CG26
ET721	CG27
ET722	CG28
ET723	CG12
ET724	CG14
ET725	CG15
ET726	CG30
ET727	CG31
ET728	CG32
ET729	CG33
ET731	CG36
ET732	CG37
ET733	CG35
ET734	CG9
ET735	CG10
ET736	CG11
ET737	CG64
ET738	CG65
ET739	CG16
ET740	CG17
ET741	CG29
ET742	CG13
ET743	CG38
ET744	CG39
ET745	CG40
ET746	CG41
ET747	CG42
ET748	CG43
ET749	CG44

TERMINALS & CONNECTORS

	Boxed Part #
ET97L	STP97
ET98L	STP98
ET120H	STP120H
ET120, ET120L	STP120
ET120XL	STP120
ET121	STP121

TERMINALS & CONNECTORS

	Boxed Part #
ET122	STP122
ET123, ET123L	STP123
ET124H	STP124H
ET124, ET124L	STP124
ET124XL	STP124
ET125, ET125L	STP125
ET126, ET126L	STP126
ET127H	STP127H
ET127, ET127L	STP127
ET127XL	STP127
ET128, ET128L	STP128
ET129, ET129L	STP129
ET129XL	STP129
ET130H	STP130H
ET130, ET130L	STP130
ET130XL	STP130
ET131, ET131L	STP131
ET131H	STP131H
ET131XL	STP131
ET132H	STP132H
ET132, ET132L	STP132
ET132XL	STP132
ET133	STP133
ET134	STP134
ET135	STP135
ET135XL	STP135
ET136	STP136
ET139, ET139L	STP139
ET139XL	STP139
ET140, ET140L	STP140
ET140XL	STP140
ET141, ET141L	STP141
ET141XL	STP141
ET142	STP142
ET143	STP143
ET143H	STP143H
ET144H	STP144H
ET144L	STP144
ET144XL	STP144
ET145H	STP145H
ET145L	STP145
ET145XL	STP145
ET146	STP146
	STP163
ET147	STP147
ET148, ET148L	STP148
ET148XL	STP148
ET149, ET149L	STP149
ET149XL	STP149
ET150	STP150
ET151	STP151
ET151H	STP151H
ET154	STP154
ET155	STP155
ET157	STP157
ET159L	STP159
ET161, ET161L	STP161
ET161XL	STP161
ET162, ET162L	STP162
ET163, ET163L	STP163
ET164	STP164

TERMINALS & CONNECTORS

	Boxed Part #
ET165	STP165
ET166	STP166
ET168L	STP168
ET170	STP170
ET171	STP171
ET176	STP176
ET176XL	STP176
ET178	STP178
ET179	STP179
ET182	STP182
ET183	STP183
ET196L	STP196
ET197L	STP197
ET198L	STP198
ET207	STP207
ET207XL	STP207
ET208	STP208
ET208XL	STP208
ET210	STP210
ET211	STP211
ET212	STP212
ET351	STP351
ET352	STP352
ET353	STP353
ET357	STP357
ET360	STP360
ET361	STP361
ET363	STP363
ET364	STP364
ET365	STP365
ET381	STP381
ET381XL	STP381
ET437L	STP437
ET470	STP470
ET474	STP474
ET476	STP476
ET480L	STP480
ET481L	STP481
ET482L	STP482
ET483L	STP483
ET486	STP486
ET492	STP492
ET497	STP497
ET497H	STP497H
ET501	STP501
ET502	STP144
	STP210
ET503	STP130
	STP131
	STP132
ET504	STP140
	STP141
	STP148
	STP149
	STP161
	STP207
ET509	ST110
ET511	SST95
ET512	SST97

TERMINALS & CONNECTORS

	Boxed Part #
ET513	STP120
	STP130
	STP150
	STP165
ET514	STP124
	STP131
	STP135
	STP155
ET523	STP523
ET524	STP524
ET526	STP149
	STP141
	STP161
ET529L	STP435
	STP436
	STP437
ET530	STP530
ET550	STP550
ET551	STP551
ET552	STP552
ET553	STP553
ET556	STP556
ET559	STP559
ET560	STP560
ET561	STP561
ET562	STP562
ET564	STP564
ET570	STP570
ET571	STP571
ET600L	STP600
ET601L	STP601

CLIPS, STRAPS, LOOM & HEAT SHRINK TUBING

	Boxed Part #
ET3	CL4S
ET4	CL11S
ET5	CL5S
ET6	CL6S
ET7	CL7
ET12	HST10
ET14	HST14
ET18	HST18
ET20	HST10
	HST14
	HST18
ET38	HST21
	HST28
	HST30
ET58	BP62
ET59	BP61
ET60	BP60
ET60 & ET57	BP80
ET62	ST62
ET250L & ET250	STT250
ET251L & ET251	STT251
ET252L & ET252	STT252
ET253L	STT253
ET254L & ET254	STT254

O.E. INTERCHANGES



O.E. INTERCHANGES

CLIPS, STRAPS, LOOM & HEAT SHRINK TUBING

	Boxed Part #
ET256	STT256
ET256E	STT256E
ET256R	STT256R
ET256W	STT256W
ET256Y	STT256Y
ET260	STT260
	STT261
	STT262
ET263	STT261
ET270	ST69
	ST66
	ST67
ET271EL	STT271E
ET271L	STT271
ET271RL	STT271R
ET271WL	STT271W
ET271YL	STT271Y
ET272	ST70
	ST71
	ST72
ET273	ST70
ET274	ST71
ET275	ST72
ET276L	STT276
ET279L	STT275
ET290	ST60
ET292	ST292
ET293	ST293

MISCELLANEOUS

	Boxed Part #
ET10	WTT5
ET26	ST26
ET40	GR2
ET44	GR1
ET45	GR3
ET100	WTT100
ET113	ST113
ET114	ST114
ET116	ST116
ET200	STP200
ET201	STP201
ET203	STP203
ET204	STP201
	STP203
	STP200
ET214	FH1
ET215	FH2
ET216	STP213
ET223	FH15
ET224	FH12
ET225	FH18
ET230	ST230
ET231	ST231
ET457	C16-4B
ET458	C16-3B

AMERICAN MOTORS

O.E.#	STD Part #
3690736	S69
3691072	S71
4486948	S49
4486949	S45N
4488908	S44
4489395	S74
4489412	S45N
8122474	S503
8124663	S69
8126900	S503
8983500650	S506

CHRYSLER

O.E.#	STD Part #
202096466	CG69
2096467	CG35
2822196	S-773
2926370	S-75
2926502	S-747
2983727	S-573
302919BK	S844
3032BK	S845
3513162	S-45N
3513558	S-505
3513686	S-99
3588314	S-100
3588421	S-516
3588427	S-69
3588650	S-100
3588883	S-69
3690736	S-69
3691072	S-71
3738020	S-99
3744750	S-500A
3764123	S-69
3764126	S-71
3764561	S-505
3764579	S-71
3764747	S-44
3764863	S-505
3764865	S-501
3780745	S-45N
3843386	CG37
3843386	CG48
3843432	S-504
3843601	CG36
3843601	CG49
4055028	S-99
4124081	S-600A
4124721	S-501
4163003	S-504
4274041	S-99
4274100	S-97
4304282	S-505
4304729	CG53
4331051	S-502
4362012	S1928
4368163	CG51
4368264	S-532
4368960	CG52
4374072	S-500A
4399576	S-600A
4399639	S862

CHRYSLER

O.E.#	STD Part #
4399900	S-776
4400147	S772
4400216	S-501
4400231	S872
4400396	S-525
4400448	S835
4400588	S-99
4400740	S-532
4400899	S772
4414184	S-557
4414332	S-525
4430976	S-525
4439076	S-525
4450799	S-532
4450807	S2000
4450816	S-502
4450817	S-506
4450820	S872
4450821	S-100
4486948	S-49
4486949	S-45N
4488908	S-44
4488909	S-45N
4489395	S-74
4489412	S-45N
4636358	S-770
4636359	S-532
4636360	S872
4636361	S2000
4636362	S-791
4636363	S-778
4676589	S-771
4782204	S-720
4857327AA	S-775
4864259	S-773
4897034AA	S949
4897087AA	S-738
5003316AA	S1936
5013933AA	S1838
5013940AA	S2055
5013942AA	S2056
5013949AA	S1958
5013961AA	S1960
5013971AA	S1933
5013979AB	S949
5014001AA	S2063
5014010AA	S1832
5014010AB	S1832
5016261AA	S1950
5017119AA	S1918
5017124AA	S1768
5017124AB	S1768
5017124AC	S1768
5019923AA	S1837
5019940AA	S2082
5019945AA	S2061
5019959AA	S1918
5102406AA	S1153
5102408AA	S1920
5127710AA	S1957
5161920AA	S1905
5173477AA	S1928
5183448AA	S1895

CHRYSLER

O.E.#	STD Part #
5288917AA	S-779
5288919AA	S907
55157102AB	S1916
56045501AC	S1956
68003675AA	S1938
68018959AA	S899
68018993AA	S1739
68052586AB	S1759
68052733AA	S1943
7368261	CG50
8122474	S-503A
8124663	S-69
8126900	S-503A
8983500650	S-506
8983501000	S-505
MB898192	S-790
MD611538	S834
MU805823	S-794

DELCO

O.E.#	STD Part #
8013	SPP33
FP51	S-722
LS101	S-74
LS11	S-548
LS12	S-559
LS13	S-592
LS14	S-590
LS15	S-584
LS17	S-586
LS19	S-95
LS2	S-63
LS25	S-97
LS32	S-669
LS37	S-673
LS39	S-767
LS4	S-55
LS44	S-789
LS5	S-95
LS50	S-768
LS51	S-97
LS53	S-506
LS54	S-585
LS6	S-507
LS63	S-98
LS64	S-766
LS65	S-54
LS7	S-502
LS71	S-766
LS8	S-77
PT100	S-639
PT101	S-709
PT1031	S-796
PT107	S-712
PT109	S-714
PT110	S-649
PT111	S-651
PT1115	S-742
PT113	SK25
PT114	S-569
PT115	S-701
PT117	S-656
PT1174	S-761

O.E. INTERCHANGES

DELCO

O.E.#	STD Part #
PT118.....	S-587
PT1184.....	S-795
PT119.....	S-605
PT120.....	S-553
PT1205.....	S-803
PT121.....	S-637
PT122.....	S-742
PT123.....	S-595
PT124.....	S-536
PT127.....	S-555
PT128.....	S-594
PT131.....	S-538
PT134.....	S-650
PT1346.....	S-804
PT1350.....	TX3A
PT140.....	S-668
PT143.....	S-700
PT146.....	S-717
PT147.....	S-754
PT148.....	S-577
PT1489.....	S-753
PT151.....	S-652
PT156.....	S-721
PT156.....	S-721
PT159.....	S-826
PT165.....	S-604
PT166.....	S-562
PT167.....	S-523
PT168.....	S-524
PT175.....	S-647
PT179.....	S-648
PT181.....	S-646
PT186.....	S-614
PT189.....	S-568
PT194.....	S-615
PT195.....	S-758
PT199.....	S-726
PT205.....	S-653
PT209.....	S-588
PT212.....	S-667
PT217.....	S-633
PT225.....	S-804
PT243.....	S-734
PT247.....	S-689
PT248.....	S-634
PT249.....	S-636
PT262.....	S-759
PT285.....	SK29
PT292.....	S-527
PT307.....	S-556
PT308.....	S-550
PT331.....	S-708
PT342.....	S-601
PT344.....	S-687
PT363.....	S-654
PT367.....	S-687
PT374.....	S-575
PT375.....	S-619
PT387.....	S-729
PT392.....	S-749
PT404.....	S-635
PT407.....	S-614
PT410.....	S-688

DELCO

O.E.#	STD Part #
PT419.....	S-578
PT420.....	S-724
PT430.....	S-564
PT433.....	S-525
PT450.....	S-753
PT466.....	S-618
PT486.....	S-643
PT487.....	S-711
PT494.....	S-552
PT516.....	S-735
PT517.....	S-554
PT643.....	S-750
PT656.....	S-733
PT689.....	S-732
PT730.....	S-721
PT743.....	S-619
PT757.....	S-551
PT768.....	S-818
PT782.....	S-574
PT786.....	S-811
PT819.....	S-800
PT919.....	S-817

FORD

O.E.#	STD Part #
1F1Z14A411BA.....	S-823
1U2Z14S411AA.....	S1094
1U2Z14S411ABA.....	S2036
1U2Z14S411ACA.....	S1859
1U2Z14S411ADA.....	S943
1U2Z14S411AFA.....	S867
1U2Z14S411AFB.....	S867
1U2Z14S411AJA.....	S942
1U2Z14S411AKA.....	S1756
1U2Z14S411AKB.....	S1754
1U2Z14S411AMA.....	S1888
1U2Z14S411AUA.....	S1839
1U2Z14S411AXA.....	S1874
1U2Z14S411AY.....	S1094
1U2Z14S411AYA.....	S1094
1U2Z14S411BBA.....	S1840
1U2Z14S411BCA.....	S1860
1U2Z14S411BDA.....	S898
1U2Z14S411BDB.....	S898
1U2Z14S411BEA.....	S911
1U2Z14S411BEB.....	S911
1U2Z14S411BFA.....	S1869
1U2Z14S411BHA.....	S1779
1U2Z14S411BJA.....	S1868
1U2Z14S411BNA.....	S918
1U2Z14S411BNB.....	S918
1U2Z14S411BRA.....	S1764
1U2Z14S411BRC.....	S1764
1U2Z14S411BSA.....	S1085
1U2Z14S411BSB.....	S1085
1U2Z14S411BVA.....	S1851
1U2Z14S411BXA.....	S-822
1U2Z14S411LLA.....	S1866
1U2Z14S411PA.....	S1785
1U2Z14S411TA.....	S-821
1U2Z14S411VA.....	S1896
1W3Z14S411AB.....	S1775
2U2Z14S411AA.....	S924

FORD

O.E.#	STD Part #
2U2Z14S411AC.....	S924
2U5Z13411AA.....	S875
2U5Z13411BB.....	S878
2U5Z13411CA.....	S876
2U5Z13411DA.....	S879
2U5Z13411FB.....	S2054
2U5Z13411HA.....	S877
2U5Z13411RA.....	S873
2U5Z13411SA.....	S874
3U2Z14S411ACAA.....	S2096
3U2Z14S411ACAB.....	S2096
3U2Z14S411ADA.....	S1897
3U2Z14S411AEA.....	S1789
3U2Z14S411ARA.....	S1850
3U2Z14S411ARB.....	S1850
3U2Z14S411AVA.....	S2051
3U2Z14S411BA.....	S1894
3U2Z14S411BKA.....	S1853
3U2Z14S411BNA.....	S1883
3U2Z14S411BNB.....	S1883
3U2Z14S411BYAA.....	S1795
3U2Z14S411BYAB.....	S1795
3U2Z14S411BYAC.....	S1795
3U2Z14S411CKAA.....	S895
3U2Z14S411CYA.....	S2092
3U2Z14S411DDA.....	S1899
3U2Z14S411DMAA.....	S893
3U2Z14S411DNAA.....	S892
3U2Z14S411DYA.....	S1770
3U2Z14S411DYB.....	S1770
3U2Z14S411EAA.....	S1755
3U2Z14S411EBAA.....	S1754
3U2Z14S411EEA.....	S1018
3U2Z14S411EEB.....	S1018
3U2Z14S411EKA.....	S941
3U2Z14S411EKB.....	S941
3U2Z14S411ERAA.....	S1085
3U2Z14S411EXB.....	S2031
3U2Z14S411EYAA.....	S2095
3U2Z14S411FAA.....	S1831
3U2Z14S411FKA.....	S1849
3U2Z14S411FKAA.....	S899
3U2Z14S411FKAB.....	S899
3U2Z14S411FKAE.....	S899
3U2Z14S411FLA.....	S1873
3U2Z14S411FNA.....	S1086
3U2Z14S411FNB.....	S1086
3U2Z14S411FNB.....	S1086
3U2Z14S411FPB.....	S1873
3U2Z14S411FRA.....	S1857
3U2Z14S411GDA.....	S2050
3U2Z14S411GFA.....	S1870
3U2Z14S411GLB.....	S1858
3U2Z14S411GMA.....	S1856
3U2Z14S411GSA.....	S2090
3U2Z14S411GVA.....	S1452
3U2Z14S411GZA.....	S2032
3U2Z14S411HRA.....	S2031
3U2Z14S411HSA.....	S2078
3U2Z14S411HSB.....	S2078
3U2Z14S411HXA.....	S1862
3U2Z14S411HYA.....	S2034
3U2Z14S411HYB.....	S2034

FORD

O.E.#	STD Part #
3U2Z14S411HZB.....	S1857
3U2Z14S411JBA.....	S2037
3U2Z14S411JGA.....	S2048
3U2Z14S411JLA.....	S1757
3U2Z14S411JLB.....	S1757
3U2Z14S411JPA.....	S1858
3U2Z14S411JTA.....	S1867
3U2Z14S411JUA.....	S1080
3U2Z14S411JVA.....	S1878
3U2Z14S411JYA.....	S1794
3U2Z14S411JYB.....	S1794
3U2Z14S411JZA.....	S1080
3U2Z14S411KBA.....	S843
3U2Z14S411LEA.....	S1858
3U2Z14S411LKA.....	S1796
3U2Z14S411LXA.....	S1082
3U2Z14S411MFA.....	S843
3U2Z14S411MGA.....	S1834
3U2Z14S411MHA.....	S940
3U2Z14S411MJA.....	S1891
3U2Z14S411MLA.....	S1765
3U2Z14S411MLB.....	S1765
3U2Z14S411PFA.....	S1787
3U2Z14S411PFB.....	S1787
3U2Z14S411PGA.....	S1861
3U2Z14S411RBA.....	S2079
3U2Z14S411RCA.....	S1835
3U2Z14S411RHA.....	S1777
3U2Z14S411RHB.....	S1777
3U2Z14S411RJA.....	S1781
3U2Z14S411RJJB.....	S1781
3U2Z14S411RPA.....	S1786
3U2Z14S411RPB.....	S1756
3U2Z14S411RPB.....	S1786
3U2Z14S411SA.....	S1848
3U2Z14S411SJB.....	S1873
3U2Z14S411SRA.....	S1773
3U2Z14S411SVA.....	S1021
3U2Z14S411SVB.....	S1021
3U2Z14S411TKA.....	S1875
3U2Z14S411UA.....	S1784
3U2Z14S411UB.....	S1784
3U2Z14S411UEA.....	S1788
3U2Z14S411USA.....	S1752
3U2Z14S411UZA.....	S2079
3U2Z14S411UZB.....	S2079
3U2Z14S411VA.....	S2034
3U2Z14S411VCA.....	S910
3U2Z14S411VLA.....	S1020
3U2Z14S411XA.....	S831
3U2Z14S411XRA.....	S1884
3U2Z14S411XUA.....	S2093
3U2Z14S411XVA.....	S2094
3U2Z14S411XVB.....	S2094
3U2Z14S411YBA.....	S1019
3U2Z14S411ZSA.....	S2080
4U2Z14S411JA.....	S1771
4U2Z14S411RA.....	S941
4W7Z14A411A.....	S1798
4W7Z14A411B.....	S1798
5U2Z14S411XA.....	S899
5U2Z14S411YA.....	S1799
5U2Z14S411YB.....	S1799

O.E. INTERCHANGES



O.E. INTERCHANGES

FORD

O.E. #	STD Part #
6U2Z14S411AA	S892
6U2Z14S411AA	S895
6U2Z14S411AB	S895
6U2Z14S411BA	S893
6U2Z14S411CA	S892
6U2Z14S411LB	S1772
89FZ14489HB	S1858
906790	S849
998129	S903
998130	S904
998278	S898
998312	S905
998470	S897
998509	S899
998533	S894
998612	S896
9U2Z14S411ASA	S1776
C1SF14474A	CG35
C5AB14474B	CG69
C80Z13711B	S-500A
C80Z13711A	S-500A
D0AZ13410B	S-75
D0DZ15A434B	S-74
DOOZ15536A	S-45N
D1AB14461AA	CG31
D1AB14488CA	CG30
D1AZ13410A	S831
D1AZ13410B	S-75
D1FZ13234A	S-519
D20814421BB	CG33
D20B14421CB	CG59
D2FZ13410A	S-69
D2OZ13410B	S-75
D3AB14474DA	CG32
D3AZ13410A	S-71
D3AZ13410B	S-69
D3AZ13410D	S-68
D3AZ13410E	S-509
D3AZ13410G	S-510
D3MY13410A	S-511
D40Z13234A	S-520
D4AZ13412A	S-36N
D4DZ13234A	S-511
D4FZ15536A	S-71
D4LY13410A	S-512
D4OZ13234A	S-520
D4OZ13410A	S-68
D4SZ13410A	S-68
D4ZZ13234A	S-521
D54Y13234A	S-511
D5AZ13234A	S-508
D5DZ13410A	S-69
D5UZ13410A	S-519
D5VY13410A	S-69
D5VY15A442A	S-74
D7AZ13412A	S-74
D7DZ13412A	S-74
D7FZ13234A	S-520
D7FZ13234B	S-520
D7FZ13234C	S-519
D7FZ13234D	S-520
D7LY13412A	S-74
D7MY13412A	S-74

FORD

O.E. #	STD Part #
D7OZ13410A	S-522
D7OZ13412A	S-74
D7VY13412A	S-74
D8BB14474BA	CG32
D8BZ13412B	S-74
D8HZ13711A	S-500A
D8OZ15A434A	S-71
D8VY15A442A	S-74
D9AZ13412B	S-74
D9MY13412A	S-74
D9MY15A442A	S-74
D9ZZ13412A	S-74
D9ZZ13412B	S-74
D9ZZ15A434A	S-74
E0AZ13412A	S-74
E0AZ15536A	S-74
E0BZ13412A	S-74
E0BZ13412B	S-74
E0DZ13412B	S-74
E0FZ13412A	S-74
E0MY13412A	S-74
E0MY13412B	S-74
E0MY15536A	S-570
E0SZ13412A	S-74
E0SZ15A442A	S-74
E0SZ15A442B	S-95
E0TZ13410A	S-533
E0VY13412A	S-74
E0ZZ13412A	S-74
E1AZ13410A	S-797
E1AZ13410A	S-533
E1BZ13412A	S-74
E1BZ13412B	S-74
E1DZ15536A	S-570
E1DZ15A434B	S-572
E1FZ13234A	S-531
E1FZ13410A	S-74
E1FZ13412A	S-74
E1VY13412A	S-74
E1ZZ15A434A	S-100
E25B14488AC	CG67
E25B14488DA	CG66
E25Y13410A	S-522
E25Y13410B	S-100
E25Y15A442	S-95
E25Y15A442A	S-95
E2SZ13410A	S-533
E2SZ15A442A	S-95
E2VY13410A	S-522
E3LY15A442A	S-95
E4DZ15A434A	S-572
E4FZ8C290A	S-549
E5SZ13B765A	S-500A
E6AZ15A434A	S-572
E6DB15A200AA	S-572
E6DB15A200AC	S-572
E6DZ14A411A	S-628
E6DZ15A434A	S-572
E6FZ13B764A	S-503A
E7EB14421EA	CG55
E7EB14474CA	CG57
E83Z13412C	S-100
E89Z13B765A	S-500A

FORD

O.E. #	STD Part #
E8EB1114474AMA	CG54
E8EB14421LA	CG56
E8EB14474AJA	CG58
E8EB14474VA	CG60
E8EB14488AGA	CG67
E8EB14488AHA	CG66
E8PZ13411A	S-547
E8PZ13411B	S-547
E8PZ13411C	S-547
E8PZ13411D	S-571
E9Z213B765A	S-500A
E9AZ15A434A	S-571
E9DZ15A434A	S-571
E9TZ13410A	S-898
F0Z213K371B	S-36N
F1TZ13411A	S-787
F1TZ13411B	S-806
F1TZ13411C	S-783
F1TZ13411E	S891
F1TZ13411F	S-786
F1TZ13411G	S-807
F24Y13410A	S-547
F2AZ13234A	S-547
F2AZ14489W	S-713
F2DZ13410A	S-547
F2DZ13412B	S-100
F2MY13234A	S-547
F2PZ14A464B	S-801
F2PZ14A464C	S-692
F2PZ14A464C	S-798
F2ZZ13412B	S-100
F3Z213K371A	S-769
F3Z213K371D	S-36N
F3TZ13411A	S841
F3LY13411A	S-808
F3XY12A112A	S-670
F3XY13410B	S1091
F4Z213K371D	S-36N
F4TZ13411A	S-809
F4UB14A464A	S-692
F4VY14A411S	S843
F5Z713234AA	S898
F58Z13411A	S-810
F5RZ13K371A	S-745
F5RZ13K371B	S-745
F6DZ13411A	S890
F6DZ13411B	S842
F6HZ14A464FUA	S-756
F6TZ14489A	S1785
F7PZ14A411AB	S918
F7ZZ13411AB	S2036
F81Z13411AA	S1836
F81Z13411BA	S923
F81Z19D887AA	S-805
F85Z13411AA	S-815
F87Z13411AA	S1091
F8AZ14A411BA	S943
F8ZZ14489DA	S943
F9PZ14A411AB	S918
FOOY14489A	S1775
WPT170	S867
YF1Z14489BA	S1839

GENERAL MOTORS

O.E. #	STD Part #
06298886	S-74
08901283	S1719
08912750	S-97
08918527	S-74
10042638	S-703
10486240	S1767
12001470	S-95
12003757	S-507
12003758	S-506
12003759	S-502
12003877	S-89
12003878	S-98
12003896	S-97
12004035	S840
12004311	S-500A
12004311	S-503A
12004706	S1134
12004996	CG20
12010085	CG17
12010182	CG16
12010300	CG29
12010717	CG42
12010973	CG40
12010974	CG71
12010975	CG75
12010996	CG38
12013813	S-77
12015323	CG9
12015387	CG44
12015791	CG39
12015792	CG41
12015793	CG43
12015797	CG70
12015798	S1594
12015799	CG74
12015857	CG3
12015861	CG26
12015870	CG28
12020116	CG4
12020120	CG27
12020126	CG62
12020320	CG5
12020347	CG6
12020757	CG12
12020758	CG15
12027133	S-768
12030055	S-673
12033674	CG10
12033817	CG18
12034046	CG24
12034047	CG25
12034051	CG11
12034053	CG13
12034342	CG72
12037105	S-669
12040902	CG14
12043215	S-553
12045781	CG22
12046623	TX3A
12046624	S-556
12047680	CG21
12047767	CG23

O.E. INTERCHANGES

GENERAL MOTORS

O.E. #	STD Part #
12051233.....	S-580
12051234.....	S-550
12052466.....	CG61
12052922.....	CG63
12058478.....	S836
12059800.....	S1399
12065158.....	CG73
12076946.....	S-590
12078187.....	S-95
12083005.....	S-548
12083006.....	S-559
12083007.....	S-592
12083460.....	S-669
12083462.....	S838
12083680.....	S-585
12083689.....	S-584
12085208.....	S974
12085212.....	S1337
12085247.....	S1099
12085330.....	S-586
12085480.....	S840
12085481.....	S1611
12085483.....	S-574
12085484.....	S1596
12085485.....	S-712
12085486.....	S1597
12085487.....	S-714
12085488.....	S-649
12085489.....	S-651
12085491.....	SK25
12085493.....	S-701
12085493.....	S1101
12085495.....	S-656
12085496.....	S-587
12085497.....	S-605
12085498.....	S-553
12085499.....	S-637
12085500.....	S-639
12085501.....	S-742
12085502.....	S-595
12085503.....	S-536
12085504.....	S1606
12085506.....	S-555
12085507.....	S-594
12085520.....	S-709
12085521.....	S-538
12085523.....	S1833
12085524.....	S-650
12085525.....	S-552
12085527.....	S-552
12085528.....	S-552
12085529.....	S956
12085530.....	S-668
12085531.....	S1040
12085532.....	S1614
12085533.....	S-700
12085534.....	S1103
12085535.....	S-717
12085536.....	S1104
12085537.....	S-754
12085538.....	S-638
12085538.....	S-577
12085539.....	S-638

GENERAL MOTORS

O.E. #	STD Part #
12089040.....	CG10
12089188.....	CG11
12089340.....	CG63
12089347.....	S-506
12089348.....	S-502
12089648.....	S1227
12092209.....	S1622
12092377.....	S-548
12092378.....	S-559
12092512.....	S1170
12101762.....	S1065
12101763.....	S1029
12101820.....	S-667
12101822.....	S1097
12101823.....	S1660
12101824.....	S1659
12101825.....	S-633
12101826.....	S1369
12101827.....	S1105
12101830.....	S1056
12101832.....	S1651
12101833.....	S-804
12101836.....	S1617
12101845.....	S1106
12101847.....	S1107
12101848.....	S1621
12101850.....	S908
12101851.....	S-734
12101852.....	S1747
12101853.....	S1609
12101854.....	S1647
12101855.....	S-689
12101856.....	S-634
12101857.....	S-636
12101858.....	S1350
12101862.....	S1644
12101864.....	S972
12101865.....	S1648
12101866.....	S1108
12101871.....	S-759
12101874.....	S1109
12101875.....	S1658
12101876.....	S1639
12101880.....	S-652
12101880.....	S1099
12101881.....	S860
12101885.....	S-721
12101886.....	S1016
12101887.....	S1650
12101888.....	S-826
12101889.....	S1641
12101894.....	S869
12101895.....	S-552
12101897.....	S-523
12101898.....	S-524
12101899.....	TX3A
12101900.....	S1098
12101901.....	S1110
12101903.....	S-647
12101905.....	S1335
12101906.....	S-568
12101907.....	S-648
12101909.....	S-78

GENERAL MOTORS

O.E. #	STD Part #
12101910.....	S1046
12101911.....	S1649
12101913.....	S1068
12101914.....	S-614
12101915.....	S1638
12101916.....	S1090
12101917.....	S-568
12101918.....	S1749
12101922.....	S-615
12101923.....	S-564
12101924.....	S1634
12101925.....	S839
12101927.....	S-726
12101928.....	S956
12101930.....	S1111
12101932.....	S1095
12101933.....	S-653
12101935.....	S2062
12101936.....	S1636
12101937.....	S-588
12101938.....	S1635
12101939.....	S-721
12102480.....	S1766
12102481.....	S1637
12102483.....	S1643
12102484.....	S1631
12102485.....	S1112
12102490.....	S1642
12102561.....	S1100
12102565.....	S-736
12102566.....	S1701
12102568.....	SK29
12102602.....	S1113
12102606.....	S1628
12102611.....	S966
12102614.....	S1632
12102616.....	S1640
12102619.....	S1474
12102620.....	S-556
12102621.....	S-550
12102627.....	S1633
12102628.....	S1114
12102629.....	S1115
12102630.....	S1630
12102632.....	S1112
12102635.....	S1117
12102636.....	S1118
12102638.....	S1629
12102639.....	S971
12102660.....	S1119
12102661.....	S982
12102664.....	S-708
12102668.....	S1120
12102670.....	S967
12102677.....	S1044
12102685.....	S1121
12102686.....	S1122
12102690.....	S1646
12102697.....	S1645
12102698.....	S945
12102741.....	S928
12102746.....	S1616
12102747.....	S-575

GENERAL MOTORS

O.E. #	STD Part #
12102748.....	S-619
12102750.....	S1123
12102754.....	S1605
12102756.....	S1124
12102757.....	S-729
12102759.....	S1125
12102762.....	S1615
12102763.....	S-749
12102768.....	S1652
12102769.....	S1126
12102775.....	S1607
12102776.....	S1339
12102777.....	S1627
12102778.....	S1613
12102900.....	S1051
12110250.....	S944
12112171.....	S-635
12112380.....	S1828
12112768.....	S-592
12116169.....	S-95
12116244.....	S979
12116247.....	S1819
12116251.....	S1127
12116257.....	S-564
12116930.....	S1128
12116958.....	S-578
12117025.....	S-724
12117269.....	S1604
12117270.....	S1129
12117271.....	S1130
12117273.....	S1058
12117277.....	S-753
12117320.....	S1338
12117321.....	S1131
12117322.....	S1132
12117323.....	S1624
12117324.....	S1140
12117339.....	S1133
12117342.....	S1623
12117344.....	S984
12117346.....	S960
12117350.....	S1603
12117353.....	S-643
12117354.....	S-711
12117360.....	S1134
12117361.....	S-552
12117369.....	S1743
12117371.....	S1625
12117372.....	S1135
12117379.....	S1137
12117380.....	S961
12117381.....	S1139
12117383.....	S1626
12117384.....	S-735
12117387.....	S1136
12117399.....	S1138
12121822.....	S1097
12124634.....	S1142
12125621.....	S1826
12125627.....	S1602
12125631.....	S1041
12125632.....	S1602
12125634.....	S1140

O.E. INTERCHANGES



O.E. INTERCHANGES

GENERAL MOTORS

O.E. #	STD Part #
12125635	S916
12125636	S1141
12125641	S1142
12125643	S1143
12125649	S1654
12125653	S1144
12125665	S1699
12125670	S1145
12125675	S1146
12125676	S1147
12125678	S1148
12125682	S1227
12125687	S1150
12125690	S1149
12125691	S1150
12125694	S915
12125695	S1720
12125910	S-97
12125966	S1727
12126011	S1349
12126016	S1176
12126023	S1151
12126025	S-733
12126032	S957
12126033	S1833
12126045	S1600
12126047	S951
12126048	S1599
12126058	S-732
12126059	S1595
12126430	S980
12126432	S1484
12126436	S955
12126438	S1598
12126444	S-688
12126449	S1594
12126452	S1783
12126453	S1593
12126458	S963
12126459	S1152
12126460	S-721
12126461	S1591
12126463	S1590
12126470	S1476
12126475	S1351
12126477	S1054
12126478	S1473
12126480	S932
12126486	S1153
12126487	S-551
12126498	S1622
12126499	S-818
12129427	S1230
12129565	S1352
12129946	S952
12141301	S-767
12141302	S829
12141388	S-789
12141493	S868
12159662	S-585
12159663	S1723
12160491	S1152
12160493	S1199

GENERAL MOTORS

O.E. #	STD Part #
12160948	S1377
12162414	S1372
12162873	S1444
12166036	S1730
12166325	S1733
12167101	S1656
12167113	S1154
12167120	S-811
12167121	S1099
12167122	S1657
12167123	S1026
12167126	S1620
12167127	S1610
12167129	S1619
12167130	S1618
12167133	S1329
12167136	S1355
12167138	S-766
12167140	S1608
12167144	S1343
12167150	S1320
12167151	S1155
12167154	S912
12167155	S-800
12167156	S1047
12167157	S1008
12187676	S1051
12187678	S1051
12202677	S-687
12335587	S1023
12335631	S1690
12335815	S1728
12456483	S999
12475138	S1156
13355748	S1477
13504128	S1745
13580103	S1491
13580104	S1072
13580107	S1384
13580108	S1801
13580111	S1426
13580112	S1010
13580114	S1717
13580114	S1717
13580115	S1323
13580116	S1048
13580860	S1694
13580864	S1265
13580868	S1216
13580869	S1329
13580871	S1025
13580873	S1445
13580873	S1741
13580874	S1288
13580877	S934
13580880	S1673
13580881	S1394
13580883	S1605
13583923	S1699
13583927	S1344
13584094	S1479
13584095	S1745
13584255	S1664

GENERAL MOTORS

O.E. #	STD Part #
13584255	S1708
13584311	S1458
13584479	S1469
13585849	S1437
15231500	S1800
15305801	S-817
15305802	S1383
15305839	S929
15305857	S1199
15305872	S1200
15305873	S2001
15305874	S2018
15305876	S912
15305878	S1201
15305880	S1071
15305883	S1202
15305886	S1158
15305887	S-796
15305888	S975
15305889	S1203
15305890	S1157
15305891	S1204
15305896	S1159
15305899	S1370
15305900	S1160
15305910	S1161
15305913	S1162
15305914	S1206
15305916	S1207
15305917	S1163
15305918	S1164
15305919	S1167
15305920	S1165
15305921	S1166
15305923	S1167
15305924	S1168
15305925	S-795
15305927	S1325
15305928	S1169
15305930	S1319
15305931	S1818
15305935	S2004
15305938	S2028
15305942	S-761
15305943	S1170
15305944	S1371
15305946	S1171
15305949	S1372
15305950	S1374
15305951	S1373
15305957	S1172
15305960	S1208
15305965	S1348
15305982	S1416
15305983	S1210
15305984	S1211
15305985	S1167
15305986	S1212
15305988	S1376
15305991	S1377
15305992	S1378
15305995	S1173
15305996	S1059

GENERAL MOTORS

O.E. #	STD Part #
15305997	S1096
15305998	S1362
15305999	S1174
15306000	S1213
15306002	S-742
15306005	S1175
15306007	S945
15306008	S1176
15306011	S1355
15306012	S1387
15306013	S1177
15306014	S1385
15306017	S1178
15306018	S1179
15306021	S1388
15306023	S1227
15306024	S1390
15306026	S1375
15306027	S1054
15306028	S1199
15306030	S1389
15306032	S1386
15306036	S1180
15306039	S1181
15306041	S1182
15306042	S1368
15306044	S1341
15306045	S-802
15306047	S1014
15306050	S1183
15306052	S1184
15306053	S1035
15306054	S1360
15306059	S1007
15306060	S1359
15306061	S1185
15306063	S1361
15306064	S1357
15306065	S1358
15306067	S1351
15306069	S1352
15306070	S1214
15306071	S1215
15306076	S1186
15306078	S1187
15306079	S932
15306080	S868
15306082	S1372
15306083	S1066
15306084	S1356
15306086	S1482
15306087	S1706
15306088	S1188
15306090	S1354
15306092	S1723
15306097	S1189
15306098	S1190
15306102	S1344
15306103	S1191
15306105	S1345
15306106	S1192
15306107	S1193

O.E. INTERCHANGES

GENERAL MOTORS

O.E. #	STD Part #
15306114	S1704
15306115	S1194
15306116	S1195
15306117	S1196
15306119	S1197
15306121	S1243
15306125	S1815
15306134	S1216
15306135	S1217
15306138	S1218
15306139	S1219
15306141	S1220
15306142	S1221
15306143	S1198
15306146	S1224
15306147	S919
15306148	S1225
15306153	S1226
15306155	S1227
15306156	S1717
15306157	S1022
15306159	S1222
15306160	S1014
15306162	S1340
15306163	S1280
15306164	S1344
15306166	S1491
15306167	S1228
15306168	S1229
15306169	S1399
15306173	S1398
15306174	S1793
15306176	S1230
15306178	S1395
15306181	S-804
15306182	S1230
15306182	S1231
15306185	S1823
15306186	S1406
15306188	S1725
15306189	S-804
15306194	S829
15306196	S1707
15306199	S1811
15306300	S1233
15306304	S1813
15306305	S1382
15306306	S1234
15306309	S1322
15306311	S938
15306312	S921
15306313	S1384
15306314	S952
15306316	S1411
15306317	S1380
15306319	S926
15306327	S1235
15306329	S1236
15306330	S1724
15306331	S947
15306332	S1237
15306334	S1238
15306335	S1239

GENERAL MOTORS

O.E. #	STD Part #
15306336	S1240
15306338	S1241
15306339	S1242
15306346	S1334
15306348	S1243
15306349	S1410
15306350	S1501
15306351	S1244
15306353	S1393
15306357	S1245
15306358	S1721
15306359	S1041
15306360	S1265
15306361	S1381
15306362	S1246
15306363	S1295
15306364	S1247
15306365	S927
15306370	S1803
15306371	S1248
15306372	S1223
15306373	S1249
15306375	S1250
15306376	S1214
15306377	S1394
15306379	S1396
15306380	S1694
15306384	S1251
15306385	S1494
15306386	S1252
15306387	S1253
15306388	S1025
15306389	S1321
15306390	S1254
15306392	S1397
15306393	S1400
15306394	S1347
15306395	S1336
15306396	S1074
15306398	S1407
15306399	S1075
15306401	S1408
15306403	S1409
15306405	S1255
15306406	S1256
15306407	S990
15306408	S1405
15306409	S1404
15306411	S1402
15306412	S1257
15306413	S1258
15306414	S1366
15306415	S1180
15306416	S1069
15306417	S977
15306418	S1259
15306419	S1112
15306420	S1057
15306422	S1260
15306424	S1401
15306425	S1346
15306426	S1364
15306427	S1379

GENERAL MOTORS

O.E. #	STD Part #
15306429	S1812
15306430	S1318
15306431	S953
15306434	S1787
15306438	S1811
15306439	S1261
15306441	S1365
15306554	S1327
15323418	S1051
15326808	S1025
15326835	S1010
15326924	S1793
15336745	S947
15383038	S1244
15839620	S1230
15862656	S916
15945363	S1489
16513367	S-97
16513368	S830
16522273	S1729
16530707	S1735
1893623	S1751
19115027	S1696
19115594	S1745
19115602	S1488
19115653	S1481
19115666	S1493
19115695	S1486
19120947	S1822
19120997	S1472
19121104	S1805
19121115	S1820
19121149	S1820
19138475	S835
19149287	S1687
19149288	S1741
19149289	S1499
19149297	S1740
19149301	S1698
19149302	S1710
19149305	S1718
19151493	S1485
19151498	S1262
19151499	S1491
19151505	S1825
19151506	S1712
19151508	S1808
19152589	S1265
19153187	S1744
19153751	S1793
19166999	S1266
19167001	S1804
19167008	S1704
19168034	S1824
19168035	S1713
19178087	S958
19178093	S1487
19178096	S1695
19178174	S1692
19178187	S1708
19178189	S1336
19179273	S1709
19179274	S1490

GENERAL MOTORS

O.E. #	STD Part #
19179278	S1717
19179278	S1717
19179280	S1697
19179283	S1714
19179748	S1801
19180245	S1496
19180246	S1693
19180278	S1694
19180287	S1074
19180287	S1074
19181247	S1793
19208396	S1827
19257374	S1167
19260871	S1181
1989457	S846
22710588	S1449
25117765	S-722
25851959	S1688
25851960	S1471
25851961	S1689
2962447	CG7
2962448	CG45
2962984	CG47
2962987	CG8
2965470	CG69
2965580	CG35
2965880	CG68
2973781	S1648
2973932	S-503A
2978302	S-45N
5585157	S861
5585170	S857
5655006	S-503A
5963268	S-63
6270498	S833
6288702	S1143
6294015	S-74
6294493	CG46
6294511	CG2
6294512	CG1
6298886	S-74
6298892	S-74
8077	S838
88952431	S1746
88952434	S1263
88952463	S1746
88952464	S1268
88952774	S1305
88952780	S1244
88952801	S1041
88952807	S1670
88952810	S1057
88952816	S1470
88952817	S1444
88952819	S1263
88952821	S1263
88952831	S1452
88952832	S1264
88952834	S986
88952835	S1446
88952837	S1006
88952838	S1001
88952839	S989

O.E. INTERCHANGES



O.E. INTERCHANGES

GENERAL MOTORS

O.E. #	STD Part #
88952841.....	S1005
88952843.....	S1004
88952885.....	S1267
88952886.....	S1268
88953129.....	S1269
88953130.....	S1244
88953131.....	S1270
88953145.....	S1672
88953150.....	S1671
88953152.....	S1443
88953154.....	S1673
88953155.....	S1674
88953157.....	S935
88953158.....	S1815
88953199.....	S1057
88953267.....	S1676
88953268.....	S934
88953271.....	S1677
88953272.....	S1454
88953273.....	S1678
88953274.....	S1711
88953290.....	S1675
88953299.....	S1334
88953301.....	S1470
88953302.....	S1444
88953303.....	S1263
88953306.....	S1452
88953307.....	S1264
88953308.....	S986
88953309.....	S1024
88953310.....	S1004
88953312.....	S1038
88953314.....	S1446
88953315.....	S989
88953316.....	S1006
88953319.....	S1001
88953320.....	S1005
88953321.....	S1031
88953345.....	S1271
88953350.....	S1272
88953351.....	S1273
88953352.....	S1274
88953353.....	S1669
88953354.....	S1662
88953355.....	S1275
88953357.....	S1726
88953358.....	S916
88953359.....	S1663
88953360.....	S1665
88953361.....	S1666
88953364.....	S1661
88953365.....	S1667
88953366.....	S1446
88953367.....	S1668
88953368.....	S1276
88953370.....	S1670
88953371.....	S946
88956482.....	S1802
88956483.....	S1748
88972567.....	S1722
88972568.....	S1734
88972570.....	S1732
88973647.....	S948

GENERAL MOTORS

O.E. #	STD Part #
88974055.....	S935
88983300.....	S1305
88986245.....	S1500
88986247.....	S1492
88986251.....	S1041
88986254.....	S1501
88986255.....	S1010
88986257.....	S1498
88986262.....	S1480
88986263.....	S1225
88986264.....	S1277
88986265.....	S1502
88986266.....	S1011
88986268.....	S1278
88986269.....	S1279
88986270.....	S1089
88986417.....	S1280
88986437.....	S1503
88986439.....	S1683
88986447.....	S1504
88986448.....	S1505
88986449.....	S1506
88986452.....	S1010
88986453.....	S1507
88986454.....	S1281
88986455.....	S1508
88986460.....	S1282
88986968.....	S2035
88987182.....	S1680
88987186.....	S1262
88987187.....	S1664
88987188.....	S1510
88987526.....	S1516
88987841.....	S1511
88987842.....	S1512
88987843.....	S1073
88987844.....	S1513
88987845.....	S1514
88987846.....	S1515
88987853.....	S1323
88987855.....	S1516
88987856.....	S1517
88987860.....	S1283
88987863.....	S1518
88987868.....	S1519
88987869.....	S1520
88987881.....	S1521
88987883.....	S1522
88987901.....	S989
88987910.....	S1523
88987913.....	S1524
88987916.....	S1806
88987921.....	S1324
88987925.....	S1526
88987927.....	S1527
88987928.....	S1528
88987929.....	S1284
88987940.....	S1070
88987948.....	S895
88987963.....	S1529
88987964.....	S1530
88987965.....	S1531
88987967.....	S1285

GENERAL MOTORS

O.E. #	STD Part #
88987968.....	S1532
88987971.....	S926
88987972.....	S934
88987973.....	S1025
88987976.....	S1286
88987980.....	S948
88987981.....	S1287
88987983.....	S1288
88987985.....	S1289
88987986.....	S1290
88987987.....	S1533
88987988.....	S1291
88987989.....	S1292
88987990.....	S1293
88987991.....	S1534
88987992.....	S1535
88987994.....	S1294
88987995.....	S1445
88987997.....	S952
88987998.....	S1295
88987999.....	S1536
88988054.....	S1537
88988055.....	S1538
88988056.....	S1342
88988059.....	S1305
88988060.....	S1539
88988061.....	S1540
88988063.....	S1541
88988064.....	S1542
88988066.....	S1544
88988067.....	S1306
88988104.....	S1543
88988105.....	S1545
88988109.....	S1307
88988111.....	S1296
88988112.....	S1546
88988113.....	S1297
88988114.....	S1547
88988116.....	S1475
88988117.....	S894
88988118.....	S1469
88988137.....	S1548
88988138.....	S1549
88988139.....	S895
88988140.....	S1550
88988141.....	S926
88988142.....	S1551
88988143.....	S1302
88988161.....	S1303
88988162.....	S1367
88988279.....	S1304
88988280.....	S1552
88988297.....	S1553
88988298.....	S1554
88988300.....	S1555
88988308.....	S1298
88988309.....	S1684
88988310.....	S943
88988311.....	S1299
88988312.....	S1300
88988314.....	S1557
88988315.....	S1324
88988317.....	S1558

GENERAL MOTORS

O.E. #	STD Part #
88988320.....	S1559
88988322.....	S1684
88988323.....	S1301
88988337.....	S1497
88988338.....	S1308
88988342.....	S1561
88988343.....	S1562
88988344.....	S1563
88988345.....	S1309
88988346.....	S1564
88988347.....	S1565
88988353.....	S1310
88988357.....	S1311
88988358.....	S1566
88988364.....	S1703
88988366.....	S1312
88988374.....	S1821
88988383.....	S1313
88988384.....	S1567
88988385.....	S1314
88988386.....	S1568
88988389.....	S1569
88988391.....	S1570
88988393.....	S1571
88988394.....	S1572
88988395.....	S1315
88988396.....	S1573
88988398.....	S1574
88988399.....	S1575
88988400.....	S1576
88988401.....	S1577
88988402.....	S1682
88988403.....	S1578
88988406.....	S1316
88988407.....	S1317
88988408.....	S1579
88988409.....	S1580
88988410.....	S1412
88988448.....	S1413
88988449.....	S1581
88988451.....	S1467
88988454.....	S1466
88988458.....	S1465
88988459.....	S1463
88988460.....	S1441
88988465.....	S1464
88988466.....	S1440
88988482.....	S1455
88988483.....	S1456
88988497.....	S1700
88988498.....	S1691
88988506.....	S1715
88988507.....	S1353
88988509.....	S1742
88988512.....	S1702
88988582.....	S1582
88988583.....	S1038
88988585.....	S1419
88988586.....	S1414
88988586.....	S1415
88988587.....	S1415
88988588.....	S1716
88988595.....	S1458

O.E. INTERCHANGES

GENERAL MOTORS

<u>O.E. #</u>	<u>STD Part #</u>
88988598.....	S912
88988599.....	S1448
88988600.....	S1583
88988601.....	S1266
88988602.....	S933
88988609.....	S1416
88988610.....	S1418
88988638.....	S1584
88988640.....	S1585
88988641.....	S1420
88988642.....	S1421
88988643.....	S1586
88988644.....	S1587
88988645.....	S1422
88988646.....	S1423
88988648.....	S1424
88988650.....	S1588
88988651.....	S1425
88988652.....	S1426
88988653.....	S1427
88988700.....	S1685
88988702.....	S1353
88988703.....	S1428
88988704.....	S1430
88988705.....	S1429
88988718.....	S1696
88988737.....	S1589
88988739.....	S1449
88988740.....	S1450
88988741.....	S1451
88988742.....	S991
88988744.....	S1477
88988745.....	S1453
88988747.....	S1442
88988764.....	S1431
88988814.....	S1014
88988815.....	S1684
88988815.....	S1684
88988815.....	S1684
88988877.....	S1802
88988878.....	S1748
88988939.....	S1478
88988942.....	S1707
88988944.....	S1479
88988963.....	S1024
8900524.....	CG5
8902485.....	S-59
8902487.....	S-59
89025035.....	S1729
8903202.....	S-55
8903203.....	S-54
8903283.....	S-59
8904437.....	S-63
89046626.....	S1326
89046627.....	S1327
89046628.....	S1328
89046632.....	S1432
89046633.....	S1075
89046634.....	S1330
89046635.....	S1076
89046638.....	S993
89046640.....	S1417
89046642.....	S1331

GENERAL MOTORS

<u>O.E. #</u>	<u>STD Part #</u>
89046643.....	S1072
89046644.....	S1332
89046645.....	S1433
89046647.....	S1679
89046649.....	S973
89046651.....	S1447
89046652.....	S1681
89046653.....	S1048
89046654.....	S959
89046658.....	S1281
89046731.....	S1434
89046732.....	S1333
89046735.....	S1384
89046742.....	S1435
89046743.....	S1436
89046833.....	S1334
89046834.....	S1462
89046835.....	S1461
89046837.....	S1437
89046839.....	S1683
89046842.....	S1460
89046845.....	S1459
89046846.....	S931
89046849.....	S1438
89046851.....	S1439
89047070.....	S1736
89047243.....	S1415
8905087.....	CG19
8909517.....	S-65
8909518.....	S-63
8909908.....	S-59
8909910.....	S-44
8910685.....	S-74
8912698.....	S-49
8912750.....	S-97
8913503.....	S-76
8914822.....	S-55
8914823.....	S-54
8918525.....	S-89
8918527.....	S-74
8918646.....	S-80
8919916.....	S-77
92143912.....	S930
92147004.....	S1731
94160702.....	S1444



403W.....	A6	723L.....	A9	741M.....	A10	827CA.....	A13
603W.....	A6	724AK.....	A8	742HA.....	A13	827XC.....	A11
605W.....	A6	724AL.....	A8	743UW.....	A12	828AH.....	A10
608W.....	A6	724BK.....	A8	744AL.....	A8	828AK.....	A10
700PLR-1.....	A14	724CD.....	A12	744U.....	A12	828GT.....	A11
700SLA-1.....	A14	724CL.....	A9	745CW.....	A9	828Q.....	A11
701PLA-1.....	A14	724EE.....	A12	748AL.....	A8	828R.....	A11
702PLA.....	A15	724U.....	A12	749M.....	A10	828X.....	A11
702PLR.....	A15	724US.....	A12	750U.....	A12	829N.....	A11
705PLA.....	A14	725BL.....	A8	752AL.....	A8	830FW.....	A11
707XD.....	A10	725CC.....	A12	754UW.....	A12	831FT.....	A10
708NS.....	A10	725HA.....	A13	756AL.....	A8	832AH.....	A10
710CS.....	A9	725T.....	A10	760US.....	A12	832AK.....	A10
711CE.....	A12	725UW.....	A12	760UX.....	A12	832P.....	A11
711NS.....	A10	726CE.....	A12	801W.....	A6	832Q.....	A11
712AF.....	A8	726CT.....	A9	804W.....	A6	832R.....	A11
712AK.....	A8	726K.....	A9	806W.....	A6	832X.....	A11
712AL.....	A8	726M.....	A10	809W.....	A6	834GT.....	A11
712CT.....	A9	726XA.....	A10	812AK.....	A10	834XC.....	A11
712GG.....	A13	727CK.....	A8	812CA.....	A13	835FW.....	A11
712K.....	A9	727CW.....	A9	812X.....	A11	836AH.....	A10
712XA.....	A10	727EE.....	A12	813FT.....	A10	836P.....	A11
713EE.....	A12	727L.....	A9	813HH.....	A13	836X.....	A11
713T.....	A10	727XD.....	A10	813XC.....	A11	838AK.....	A10
715NT.....	A10	728AK.....	A8	814CA.....	A13	838R.....	A11
716AF.....	A8	728AL.....	A8	814CB.....	A13	840AH.....	A10
716AK.....	A8	728BK.....	A8	814FW.....	A11	840GT.....	A11
716AL.....	A8	728CH.....	A8	814P.....	A11	840P.....	A11
716CC.....	A12	728JB.....	A9	816X.....	A11	840Q.....	A11
716CS.....	A9	729CD.....	A12	817CA.....	A13	840X.....	A11
716K.....	A9	730U.....	A12	817FT.....	A10	844AK.....	A10
716U.....	A12	731K.....	A9	818AH.....	A10	844R.....	A11
716UW.....	A12	731XA.....	A10	818AK.....	A10	845FW.....	A11
716XA.....	A10	732AK.....	A8	818CB.....	A13	845P.....	A11
716XD.....	A10	732AL.....	A8	818FW.....	A11	845X.....	A11
717CE.....	A12	732BK.....	A8	818N.....	A11	848AH.....	A10
717CL.....	A9	732M.....	A10	818P.....	A11	848AK.....	A10
717T.....	A10	734CS.....	A9	818Q.....	A11	848GT.....	A11
718BK.....	A8	734CT.....	A9	818R.....	A11	848R.....	A11
718EE.....	A12	734L.....	A9	818XC.....	A11	855AK.....	A10
718GG.....	A13	734U.....	A12	819DD.....	A13	855R.....	A11
718JB.....	A9	735K.....	A9	820GT.....	A11	856GT.....	A11
718L.....	A9	735XA.....	A10	820X.....	A11	860UP.....	A12
718UC.....	A13	736AK.....	A8	821XC.....	A11	3400.....	A6
719CH.....	A8	736AL.....	A8	822P.....	A11	3401.....	A6
719CT.....	A9	736BK.....	A8	822Q.....	A11	3402.....	A6
719HA.....	A13	736BL.....	A8	822R.....	A11	3403.....	A6
720AL.....	A8	736CE.....	A12	822X.....	A11	3600.....	A6
720CE.....	A12	736US.....	A12	824AK.....	A10	3601.....	A6
720U.....	A12	736UW.....	A12	824FW.....	A11	3602.....	A6
722GG.....	A13	737CW.....	A9	824GT.....	A11	3603.....	A6
722JB.....	A9	738U.....	A12	824X.....	A11	3800.....	A6
722K.....	A9	739CD.....	A12	825CB.....	A13	3801.....	A6
722M.....	A10	740BL.....	A8	825FT.....	A10	3802.....	A6
722XA.....	A10	741CK.....	A8	826P.....	A11	3803.....	A6
722XD.....	A10	741J.....	A9	826X.....	A11	3840.....	A6

INDEX

3850.....	A6	A8-00MN	B19	A15-00K	B20	A20-4LH.....	B11
3851.....	A6	A8-00MP	B19	A15-00MN	B19	A20-4TL.....	B14
6600R.....	A23	A8-00SN	B19	A15-00MP	B19	A21-00K	B20
6800R.....	A23	A8-00SP	B19	A15-00SN	B19	A21-2HD	B9
8613.....	A6	A8-1H	B8	A15-00SP	B19	A21-2L.....	B10
8840.....	A6	A8-2H	B8	A15-1H	B8	A21-4DN.....	B8
8852.....	A6	A8-2DBN.....	B6	A15-1L	B10	A21-4GEP	B8
9947.....	A4	A8-6DN	B8	A15-2H	B8	A21-4HD	B9
9952.....	A4	A8-6LM.....	B11	A15-2T.....	B12	A21-6TA.....	B12
9961.....	A4	A8-8L.....	B10	A15-4L.....	B10	A21-8KN.....	B10
9965.....	A4	A9-00K	B20	A15-4U.....	B14	A22-00K.....	B20
9984.....	A4	A9-6PP.....	B11	A15-6PN.....	B11	A22-1UT	B16
69401.....	A5	A10-2DN.....	B8	A16-0HDA.....	B9	A22-2L	B10
69402.....	A5	A10-2HD.....	B9	A16-1	B4	A22-4	B4
69403.....	A5	A10-2T.....	B12	A16-2DDF.....	B7	A22-4DNCL.....	B8
69404.....	A5	A10-4	B4	A16-2HDA.....	B9	A22-4HD	B9
69405.....	A5	A10-4D	B6	A16-4	B4	A22-4RDN.....	B12
69406.....	A5	A10-4L	B10	A16-4HD	B8	A22-4T	B12
69407.....	A5	A10-4T	B12	A16-4L.....	B10	A22-4TB	B13
69408.....	A5	A10-6T	B12	A16-4LF.....	B10	A22-4U	B14
69409.....	A5	A10-8L.....	B10	A16-4LT	B11	A22-4UT.....	B16
69410.....	A5	A11-4HD	B9	A16-4RDN.....	B12	A22-6HN.....	B11
69411.....	A5	A11-4T.....	B12	A16-4T.....	B12	A22-6PP.....	B11
69412.....	A5	A11-4TL.....	B14	A16-6LM	B11	A22-6TLA.....	B14
69414.....	A5	A11-6TLA.....	B14	A16-6UT.....	B16	A22-6U	B14
69415.....	A5	A11-6YN	B11	A17-1GEN	B8	A22-6UT.....	B16
69416.....	A5	A11-8L.....	B10	A17-4UTC	B16	A23-1	B4
69417.....	A5	A12-00	B4	A17-6.....	B4	A23-2CLT	B5
69418.....	A5	A12-00H	B8	A17-6CLT.....	B5	A23-2CLTB.....	B5
69419.....	A5	A12-1.....	B4	A17-8L.....	B10	A23-2DAC	B6
69420.....	A5	A12-1H	B8	A18-00	B4	A23-2L.....	B10
69421.....	A5	A12-1L	B10	A18-1H	B8	A23-4DAC	B6
69422.....	A5	A12-2.....	B4	A18-2DDF.....	B7	A23-4HD	B9
69423.....	A5	A12-2H	B8	A18-2T.....	B12	A23-4RDN.....	B12
69424.....	A5	A12-2LF	B10	A18-4L.....	B10	A23-6PN	B11
69425.....	A5	A12-4LF	B10	A18-6ACP	B4	A24-00	B4
69426.....	A5	A12-4T	B12	A18-6DN	B8	A24-00H	B8
69427.....	A5	A12-6.....	B4	A18-6L.....	B10	A24-1GEN	B8
69428.....	A5	A12-6PN.....	B11	A18-6T.....	B12	A24-2RDN.....	B12
69429.....	A5	A12-6T.....	B12	A19-00H	B8	A24-2TB	B13
69430.....	A5	A13-0D.....	B6	A19-1	B4	A24-4AEN	B4
69501.....	A5	A13-2L.....	B10	A19-1L	B10	A24-4GEN	B8
69502.....	A5	A13-4TAF.....	B13	A19-2RDN.....	B12	A24-4L	B10
A4-6L.....	B10	A13-4TB.....	B13	A19-4.....	B4	A24-4LH.....	B11
A5-10L.....	B10	A13-6L.....	B10	A19-4DNCL.....	B8	A24-4RDN.....	B12
A6-2T.....	B12	A14-00MN	B19	A19-4L.....	B10	A24-4TB	B13
A6-6KP.....	B10	A14-00MP	B19	A19-4TB	B13	A24-4TLA.....	B14
A6-6L.....	B10	A14-00SN	B19	A19-4TB2.....	B13	A24-6.....	B4
A6-6T.....	B12	A14-00SP	B19	A19-4U	B14	A24-6CLT	B5
A7-00MN	B19	A14-2AEN	B4	A19-6L.....	B10	A24-6L.....	B10
A7-00MP	B19	A14-2D.....	B6	A20-1TB.....	B13	A24-6LM.....	B11
A7-00SN	B19	A14-2DN	B8	A20-2D	B6	A24-6T	B12
A7-00SP	B19	A14-4.....	B4	A20-4D	B6	A24-6TA.....	B12
A7-6L.....	B10	A14-4L	B10	A20-4HD	B9	A24-6TD.....	B14
A7-6LT.....	B11	A14-6L	B10	A20-4L.....	B10	A24-6UH.....	B15
A8-00H	B8	A14-6UT	B16	A20-4LF.....	B10	A25-2D.....	B6



A25-2L.....	B10	A28-6TB2.....	B13	A32-2UTC.....	B16	A35-2TBB.....	B13
A25-2RPP.....	B12	A28-6U.....	B14	A32-4CLT.....	B5	A35-4AEN.....	B4
A25-4CLT.....	B5	A28-6UT.....	B16	A32-4CLTA.....	B5	A35-4CLT.....	B5
A25-4D.....	B6	A29-2TA.....	B12	A32-4HD.....	B9	A35-4CLTA.....	B5
A25-4DA.....	B6	A29-2TB.....	B13	A32-4HD2.....	B9	A35-4D.....	B6
A25-4DN.....	B8	A29-2TBC.....	B13	A32-4HDA.....	B9	A35-4DA.....	B6
A25-4DNCL.....	B8	A29-4HD.....	B9	A32-4RDN.....	B12	A35-4DD.....	B6
A25-4HD.....	B9	A29-4RDN.....	B12	A32-4TB.....	B13	A35-4DG.....	B7
A25-4TB.....	B13	A29-6.....	B4	A32-4TBC.....	B13	A35-4DN.....	B8
A25-4TL.....	B14	A29-6CLT.....	B5	A32-4UT.....	B16	A35-4HD.....	B9
A25-4U.....	B14	A30-00.....	B4	A32-6CLT.....	B5	A35-4HD2.....	B9
A25-6CLT.....	B5	A30-0DAC.....	B6	A32-6TB.....	B13	A35-4HDCL.....	B10
A25-6TB.....	B13	A30-1.....	B4	A32-6TBC.....	B13	A35-4HDCL2.....	B10
A25-6TLA.....	B14	A30-2CLT.....	B5	A32-6TLA.....	B14	A35-4TB.....	B13
A25-6UT.....	B16	A30-2D.....	B6	A32-6UD.....	B15	A35-4TCC.....	B14
A25-6UT2.....	B16	A30-2DBN.....	B6	A32-6UH.....	B15	A35-6CLT.....	B5
A26-2DG.....	B7	A30-2HD.....	B9	A33-0C.....	B5	A35-6TA.....	B12
A26-2L.....	B10	A30-2L.....	B10	A33-0U.....	B14	A36-00.....	B4
A26-2RDP.....	B12	A30-2TB.....	B13	A33-2CLT.....	B5	A36-00H.....	B8
A26-4.....	B4	A30-2TBB.....	B13	A33-2DAC.....	B6	A36-0HDA.....	B9
A26-4HD.....	B9	A30-2U.....	B14	A33-2DDC.....	B7	A36-2.....	B4
A26-4TB.....	B13	A30-4.....	B4	A33-2L.....	B10	A36-2CLT.....	B5
A26-6C.....	B5	A30-4CLT.....	B5	A33-2TB.....	B13	A36-2DDC.....	B7
A26-6KN.....	B10	A30-4D.....	B6	A33-2TBC.....	B13	A36-2HD.....	B9
A26-6TB.....	B13	A30-4DA.....	B6	A33-2UT.....	B16	A36-2TB.....	B13
A26-6TC.....	B13	A30-4HD.....	B9	A33-4AEN.....	B4	A36-2UD.....	B15
A26-6TCC.....	B14	A30-4L.....	B10	A33-4HD.....	B9	A36-4.....	B4
A26-6TL.....	B14	A30-4LF.....	B10	A33-4HDA.....	B9	A36-4AEP.....	B4
A26-6TLA.....	B14	A30-4RD.....	B11	A33-4LH.....	B11	A36-4CLT.....	B5
A26-6UD.....	B15	A30-4T.....	B12	A33-4LT.....	B11	A36-4HD.....	B9
A27-1.....	B4	A30-4TA.....	B12	A33-4RDN.....	B12	A36-4LF.....	B10
A27-2CLT.....	B5	A30-4TC.....	B13	A33-4T.....	B12	A36-4LTF.....	B11
A27-2L.....	B10	A30-4U.....	B14	A33-4TC.....	B13	A36-4T.....	B12
A27-2RPP.....	B12	A30-6CLT.....	B5	A33-4TLA.....	B14	A36-4TA.....	B12
A27-4DA.....	B6	A30-6L.....	B10	A33-6TLA.....	B14	A36-4TB.....	B13
A27-4DG2.....	B7	A30-6T.....	B12	A34-0C.....	B5	A36-4U.....	B16
A27-6L.....	B10	A30-6TA.....	B12	A34-0U.....	B14	A36-4UT.....	B16
A27-6TB.....	B13	A30-6UAC.....	B15	A34-2HD.....	B9	A36-6.....	B4
A27-6UAC.....	B15	A30-6UT.....	B16	A34-2TB.....	B13	A36-6T.....	B12
A27-6UD.....	B15	A31-1GEN.....	B8	A34-2TBC.....	B13	A36-6TA.....	B12
A27-6UT.....	B16	A31-2CLT.....	B5	A34-4CLT.....	B5	A36-6TAF.....	B13
A27-8ACN.....	B4	A31-2CLTB.....	B5	A34-4HD.....	B9	A36-6U.....	B14
A28-0DN.....	B8	A31-2DD.....	B6	A34-4TL.....	B14	A36-6UT.....	B16
A28-0RD.....	B11	A31-2TB.....	B13	A34-6CLT.....	B5	A37-0HD.....	B9
A28-2APN.....	B4	A31-4CLT.....	B5	A34-6L.....	B10	A37-0RDN.....	B12
A28-2CLT.....	B5	A31-4HD.....	B9	A34-6TA.....	B12	A37-2HD.....	B9
A28-2DAC.....	B6	A31-6TA.....	B12	A34-6TB.....	B13	A37-4CLT.....	B5
A28-2DG.....	B7	A31-6TBC.....	B13	A34-6TBB.....	B13	A37-4HD.....	B9
A28-2DG2.....	B7	A31-6TLA.....	B14	A35-0DN.....	B8	A37-4HDA.....	B9
A28-2UAC.....	B15	A31-6UD.....	B15	A35-1.....	B4	A37-4TB.....	B13
A28-4DD.....	B6	A32-0DAC.....	B6	A35-2CLT.....	B5	A37-4TLA.....	B14
A28-4LH.....	B11	A32-0TB.....	B13	A35-2CLTB.....	B5	A37-4UTC.....	B16
A24-4RDP.....	B12	A32-1L.....	B10	A35-2D.....	B6	A37-6CLT.....	B5
A28-4TLA.....	B14	A32-2DAC.....	B6	A35-2DA.....	B6	A37-6TAF.....	B13
A28-6CLT.....	B5	A32-2TB.....	B13	A35-2HD.....	B9	A37-6TB.....	B13
A28-6TB.....	B13	A32-2TL.....	B14	A35-2HDD.....	B10	A37-6UT.....	B15

INDEX

A38-2DF.....	B7	A41-2L.....	B10	A44-2DDC.....	B7	A48-4LT.....	B11
A38-2HD.....	B9	A41-2RPP.....	B12	A44-2HD.....	B9	A48-4T.....	B12
A38-2TB.....	B13	A41-2TA.....	B12	A44-2HDD.....	B10	A48-4TB.....	B13
A38-2UHL.....	B15	A41-2TB.....	B13	A44-2KP.....	B10	A48-4TLA.....	B14
A38-4CLT.....	B5	A41-4DDF.....	B7	A44-2UT.....	B16	A48-4U.....	B15
A38-4DE.....	B7	A41-4DE.....	B7	A44-4CLT.....	B5	A48-4UT.....	B16
A38-4L.....	B10	A41-2DF.....	B7	A44-4DE.....	B7	A48-6TA.....	B12
A38-4TLA.....	B14	A41-4DEF.....	B7	A44-4HD.....	B9	A48-6UT.....	B16
A38-4U.....	B14	A41-4HD.....	B9	A44-6L.....	B10	A49-1L.....	B10
A38-4UT.....	B16	A41-4HDA.....	B9	A45-ODDF.....	B7	A49-2AEP.....	B4
A38-6CLT.....	B5	A41-4TL.....	B14	A45-0U.....	B14	A49-2APN.....	B4
A38-6TB.....	B13	A41-4U.....	B14	A45-2D.....	B6	A49-2DEF.....	B7
A38-6TC.....	B13	A41-6C.....	B5	A45-2HD.....	B9	A49-4AEN.....	B4
A38-6TC2.....	B13	A41-6TB.....	B13	A45-2TB.....	B13	A49-4CLT.....	B5
A38-6UH.....	B15	A41-6TBB.....	B13	A45-4.....	B4	A49-4HD.....	B9
A38-6UTC.....	B16	A42-00.....	B4	A45-4D.....	B6	A49-4LTF.....	B11
A39-2CLT.....	B5	A42-1.....	B4	A45-4DA.....	B6	A49-4RDN.....	B12
A39-4AEP.....	B4	A42-1GEN.....	B8	A45-4DDF.....	B7	A49-4TA.....	B12
A39-4CLT.....	B5	A42-2.....	B4	A45-4DG.....	B7	A49-4TCC.....	B14
A39-4HD.....	B9	A42-2DDF.....	B7	A45-4TA.....	B12	A49-4UDC.....	B15
A39-4T.....	B12	A42-2HD.....	B9	A45-4TB.....	B13	A49-6TB.....	B13
A39-4TL.....	B14	A42-4.....	B4	A45-4U.....	B14	A50-0DF.....	B7
A39-6CLT.....	B5	A42-4CLT.....	B5	A45-4UC.....	B15	A50-2D.....	B6
A39-6TLA.....	B14	A42-4CLTA.....	B5	A45-6HD.....	B8	A50-4D.....	B6
A40-2D.....	B6	A42-4DE.....	B7	A45-6KP.....	B10	A50-4DA.....	B6
A40-2DA.....	B6	A42-4DEE.....	B7	A45-6YN.....	B11	A50-4TA.....	B12
A40-2DG.....	B7	A42-4DEF.....	B7	A46-ODAC.....	B6	A50-4TBC.....	B13
A40-2HD.....	B9	A42-4HD.....	B9	A46-0HD.....	B9	A50-4UA.....	B14
A40-2L.....	B10	A42-4HDA.....	B9	A46-2DDF.....	B7	A50-4UAC.....	B15
A40-2T.....	B12	A42-4T.....	B12	A46-2HD.....	B9	A50-4UTC.....	B16
A40-4CLT.....	B5	A42-4TA.....	B12	A46-2L.....	B10	A50-6C.....	B5
A40-4CLTA.....	B5	A42-4TB.....	B13	A46-2UHC.....	B15	A50-6TA.....	B12
A40-4CLTB.....	B5	A42-4TBB.....	B13	A46-4CLT.....	B5	A50-6U.....	B14
A40-4CLTD.....	B5	A42-4TBC.....	B13	A46-4DF.....	B7	A51-4HD.....	B9
A40-4D.....	B6	A42-4UA.....	B14	A46-4DG.....	B7	A51-4L.....	B10
A40-4DA.....	B6	A42-4UAB.....	B15	A46-4TCC.....	B14	A51-4TA.....	B12
A40-4DD.....	B6	A42-4UT.....	B16	A46-4UTC.....	B16	A51-4TB.....	B13
A40-4DDF.....	B7	A42-4UTC.....	B16	A46-6CLT.....	B5	A51-4TLCL.....	B14
A40-4DE.....	B7	A42-6U.....	B14	A46-6DN.....	B8	A52-2AEP.....	B4
A40-4DF.....	B7	A42-6UAC.....	B15	A46-6TA.....	B12	A52-2LT.....	B11
A40-4HD.....	B9	A42-6UT.....	B16	A47-ODDF.....	B7	A52-2LTF.....	B11
A40-4L.....	B10	A43-2DF.....	B7	A47-2DC.....	B6	A52-2TB.....	B13
A40-4LF.....	B10	A43-2HD.....	B9	A47-2DDF.....	B7	A52-4CLTC.....	B5
A40-4LFF.....	B10	A43-2L.....	B10	A47-2U.....	B14	A52-4HD.....	B9
A40-4LH.....	B11	A43-2T.....	B12	A47-4TA.....	B12	A52-4LF.....	B10
A40-4TB.....	B13	A43-4DE.....	B7	A47-6CLT.....	B5	A52-4TA.....	B12
A40-4TBB.....	B13	A43-4DG.....	B7	A47-6KP.....	B10	A52-4UD.....	B15
A40-4UTC.....	B16	A43-4HD.....	B9	A48-00.....	B4	A52-4UT.....	B16
A40-6ACN.....	B4	A43-4HD2.....	B9	A48-00H.....	B8	A53-1.....	B4
A40-6L.....	B10	A43-4L.....	B10	A48-1TA.....	B12	A53-2DAC.....	B6
A40-6T.....	B12	A43-4LF.....	B10	A48-2DC.....	B6	A53-2DDC.....	B7
A40-6TA.....	B12	A43-4T.....	B12	A48-2HDD.....	B10	A53-2LT.....	B11
A40-6TB.....	B13	A43-4TB.....	B13	A48-4.....	B4	A53-4LTF.....	B11
A40-6TD.....	B14	A43-4TBC.....	B13	A48-4CLT.....	B5	A53-4U.....	B14
A41-2CLT.....	B5	A43-4TBC.....	B13	A48-4DE.....	B7	A53-4UDC.....	B15
A41-2DEF.....	B7	A43-4UAC.....	B15	A48-4HD.....	B9	A53-4UTC.....	B16
		A43-6GEN.....	B8				



A53-6L.....	B10	A60-2DA.....	B6	A68-2UT.....	B16	A90-2D.....	B6
A54-00.....	B4	A60-2UT.....	B16	A68-4DE.....	B7	A90-2DA.....	B6
A54-2UAC.....	B15	A60-4D.....	B6	A69-4L.....	B10	A91-4TLCL.....	B14
A54-4APP.....	B4	A60-4DA.....	B6	A69-4RDN.....	B12	A92-0HD.....	B9
A54-4DE.....	B7	A60-4L.....	B10	A69-4UDC.....	B15	A94-0HD.....	B9
A54-4LF.....	B10	A60-4LF.....	B10	A70-0DN.....	B8	A95-0D.....	B6
A54-4TB.....	B13	A60-4RDF.....	B11	A70-0HD.....	B9	A95-2DA.....	B6
A54-4TLA.....	B14	A60-4TB.....	B13	A70-2D.....	B6	A95-6DS.....	B8
A54-4UC.....	B15	A60-6C.....	B5	A70-2DB.....	B6	A100-2FLP.....	B8
A54-6UT.....	B16	A60-6HD.....	B8	A70-2DDF.....	B7	A100-6PN.....	B11
A54-6UTC.....	B16	A60-6TB.....	B13	A70-2DF.....	B7	A116-00HP.....	B10
A55-1HD.....	B9	A61-2AEN.....	B4	A70-2HD.....	B9	A123-00HP.....	B10
A55-2D.....	B6	A61-2APP.....	B4	A70-2HDA.....	B9	A125-4L.....	B10
A55-2HD.....	B9	A61-2U.....	B14	A70-4RDN.....	B12	A136-2HD.....	B9
A55-2LT.....	B11	A62-4.....	B4	A70-6TA.....	B12	A137-0HDA.....	B9
A55-2UT.....	B16	A62-4RPP.....	B12	A71-00.....	B4	A143-4L.....	B10
A55-4APP.....	B4	A62-4TB.....	B13	A72-00.....	B4	A144-2HD.....	B9
A55-4D.....	B6	A62-4TC.....	B13	A72-2DBB.....	B6	A152-2HD.....	B9
A55-4DA.....	B6	A62-4UTC.....	B16	A72-4TC.....	B13	A199-2APP.....	B4
A55-4HD.....	B9	A63-0DAC.....	B6	A72-4UA.....	B14	A224-2AEP.....	B4
A55-4RDF.....	B11	A63-2HBD.....	B6	A72-4UT.....	B16	A245-0HD.....	B9
A55-4RDP.....	B12	A63-4RPP.....	B12	A72-6C.....	B5	A272-0HD.....	B9
A55-4TB.....	B13	A63-4TA.....	B12	A73-0HD.....	B9	AB10C.....	D34
A55-6TA.....	B12	A63-4TBCL.....	B13	A73-1.....	B4	AB11C.....	D34
A55-6TB.....	B13	A63-4U.....	B14	A73-2HD.....	B9	AB99W.....	D34
A56-0D.....	B6	A64-2DE.....	B7	A73-2HD.....	B9	AB200.....	D34
A56-2DD.....	B6	A64-2RPP.....	B12	A73-4TC.....	B13	AB201.....	D34
A56-4.....	B4	A64-4TAF.....	B13	A73-4UT.....	B16	AB202.....	D34
A56-4T.....	B12	A65-1.....	B4	A73-6C.....	B5	AB203.....	D34
A56-4TA.....	B12	A65-2D.....	B6	A74-4TC.....	B13	B2GV.....	B17
A56-6U.....	B14	A65-2DB.....	B6	A74-6TBC.....	B13	B4GV.....	B17
A56-6UH.....	B15	A65-2HBD.....	B6	A75-2HDCL.....	B10	B8G.....	B17
A56-6UT.....	B16	A65-2U.....	B14	A76-2D.....	B6	B9.....	B17
A56-6UTC.....	B16	A65-4CLT.....	B5	A76-2HDCL.....	B10	B9G.....	B17
A57-2AEN.....	B4	A65-4D.....	B6	A76-4RDF.....	B11	B10G.....	B17
A57-2LT.....	B11	A65-4DN.....	B8	A78-1.....	B4	B10GV.....	B17
A57-4CLT.....	B5	A65-4LF.....	B10	A78-2AEP.....	B4	B12G.....	B17
A57-4TA.....	B12	A65-4LTF.....	B11	A78-2HDCL.....	B10	B14.....	B17
A57-4UT.....	B16	A66-00.....	B4	A78-4TB.....	B13	B14G.....	B17
A57-6TA.....	B12	A66-2HD.....	B9	A78-4U.....	B14	B14G-5.....	B17
A58-1.....	B4	A66-4DN.....	B8	A78-4UT.....	B16	B16G.....	B17
A58-2AEN.....	B4	A66-4RDN.....	B12	A78-6PN.....	B11	B17.....	B17
A58-2DEF.....	B7	A66-4TC.....	B13	A79-2HDCL.....	B10	B17G2.....	B17
A58-4CLT.....	B5	A66-4UDC.....	B15	A80-2DN.....	B8	B18G.....	B17
A58-4LF.....	B10	A66-6C.....	B5	A82-4UA.....	B14	B20G.....	B17
A58-4LTF.....	B11	A66-6TB.....	B13	A83-2L.....	B10	B20G-5.....	B17
A58-4TA.....	B12	A67-2DG.....	B7	A83-6HDA.....	B9	B25E.....	B17
A58-4TB.....	B13	A67-4LF.....	B10	A84-4.....	B4	B26G.....	B17
A58-4UA.....	B14	A67-4TA.....	B12	A84-6HD.....	B8	B29E.....	B17
A58-6TA.....	B12	A67-4TB.....	B13	A84-6PN.....	B11	BC2DL.....	B23,G5
A59-0FLP.....	B8	A67-4UTC.....	B16	A85-2DA.....	B6	BC4DL.....	B23,G5
A59-6CLT.....	B5	A67-6U.....	B14	A87-0HD.....	B9	BC6DL.....	B23,G5
A59-6TB.....	B13	A68-00HD.....	B9	A87-2DB.....	B6	BC100.....	G4
A60-00.....	B4	A68-1L.....	B10	A87-2DBB.....	B6	BC105.....	B32,G5
A60-1L.....	B10	A68-2DE.....	B7	A87-2DFB.....	B6	BC106.....	B32,G5
A60-2D.....	B6	A68-2HD.....	B9	A88-2DFB.....	B6	BC120.....	G4

INDEX

BC124.....	G4	BP34.....	B32	BP67U.....	B27	BP128.....	B24
BC126.....	G4	BP35.....	B32	BP67UC.....	B27	BP135.....	B24
BC128.....	G4	BP36N.....	B28	BP68.....	G5	BP136.....	B24
BC164.....	G4	BP36P.....	B28	BP69.....	B34	BP137.....	B24
BC165.....	G4	BP37.....	B28	BP70L.....	B34	BP138.....	B24
BC166.....	G4	BP38.....	B28	BP70S.....	B34	BP139.....	B28
BC202.....	G4	BP39.....	B28	BP72A.....	B34	BP140.....	B24
BC204.....	G4	BP40.....	B30	BP72C.....	B34	BP141.....	B28
BC254.....	G4	BP40C.....	B30	BP73.....	B34	BP142.....	B24
BCA1.....	B17	BP40N.....	B30	BP77N.....	B28	BP143.....	B24
BCS1.....	B33	BP41B.....	B20	BP77P.....	B28	BP144.....	B24
BCS2.....	B33	BP41R.....	B20	BP78.....	B28	BP145.....	B24
BCS3.....	B33	BP42.....	B21	BP78L.....	B28	BP146.....	B24
BCS4.....	B33	BP43.....	B21	BP79.....	B28	BP147.....	B24
BCS5.....	B33	BP44.....	B21	BP80.....	B34	BP148.....	B24
BCS6.....	B33	BP45.....	B21	BP81.....	B27	BP149B.....	B31
BP1U.....	B26	BP46.....	B30	BP81C.....	B27	BP149R.....	B31
BP2.....	B26	BP47.....	B32	BP83N.....	B26	BP150B.....	B31
BP2U.....	B26	BP48.....	B32	BP83P.....	B26	BP150R.....	B31
BP3U.....	B26	BP48B.....	B31	BP87.....	G5	BP151B.....	B31
BP4U.....	B26	BP48R.....	B31	BP89.....	B28	BP151R.....	B31
BP5U.....	B26	BP49B.....	B31	BP90.....	B24	BP152B.....	B31
BP6N.....	B26	BP49R.....	B31	BP91.....	B24	BP152R.....	B31
BP6P.....	B26	BP50B.....	B31	BP92.....	B24	BP153B.....	B31
BP7U.....	B26	BP50R.....	B31	BP93.....	B24	BP153R.....	B31
BP8N.....	B26	BP51B.....	B31	BP94.....	B24	BP154B.....	B31
BP8P.....	B26	BP51R.....	B31	BP95.....	B24	BP154R.....	B31
BP9N.....	B26	BP52B.....	B31	BP96.....	B24	BP155.....	B31
BP9P.....	B26	BP52R.....	B31	BP97.....	B27	BP156B.....	B31
BP10N.....	B26	BP53B.....	B31	BP97C.....	B27	BP156R.....	B31
BP10P.....	B26	BP53R.....	B31	BP97U.....	B27	BP157B.....	B31
BP11U.....	B26	BP54B.....	B31	BP98B.....	G5	BP158B.....	B31
BP17U.....	B27	BP54R.....	B31	BP98R.....	G5	BP159B.....	B31
BP19C.....	B27	BP55B.....	B31	BP99.....	B20	BP159R.....	B31
BP19U.....	B27	BP55R.....	B31	BP101.....	B20	BP160.....	B24
BP20N.....	B26	BP56.....	B30	BP102.....	B20	BP161.....	B24
BP20P.....	B26	BP56C.....	B30	BP104.....	G5	BP162.....	B24
BP20U.....	B26	BP57.....	B30	BP104J.....	G5	BP163.....	B24
BP21U.....	B26	BP58N.....	B27	BP107.....	B24	BP164.....	B24
BP22.....	B27	BP58P.....	B27	BP108.....	B24	BP165.....	B24
BP22C.....	B27	BP58U.....	B27	BP109.....	B24	BP166.....	B24
BP22N.....	B27	BP59.....	B30	BP110.....	B24	BP167.....	B24
BP22P.....	B27	BP59C.....	B30	BP111.....	B28	BP168.....	B24
BP22PW.....	B27	BP60.....	B34	BP112.....	B28	BP169.....	B24
BP22U.....	B27	BP61.....	B34	BP113.....	B24	BP170.....	B24
BP22W.....	B27	BP61A.....	B34	BP114.....	B24	BP171.....	B24
BP23C.....	B27	BP62.....	B34	BP115.....	B24	BP172.....	B24
BP23U.....	B27	BP62A.....	B34	BP116.....	B24	BP173.....	B24
BP23UC.....	B27	BP63.....	B34	BP117.....	B24	BP174.....	B24
BP24.....	B28	BP63A.....	B34	BP118.....	B24	BP175.....	B24
BP25U.....	B26	BP64.....	B34	BP119.....	B30	BP176.....	B24
BP26U.....	B26	BP64A.....	B34	BP123.....	B24	BP177.....	B24
BP28.....	B27	BP65.....	B34	BP124.....	B24	BP182.....	B28
BP31.....	B34	BP65C.....	B34	BP125.....	B24	BP183.....	B28
BP32.....	B31	BP66.....	G5	BP126.....	B24	BP184.....	B28
BP33.....	B32	BP67C.....	B27	BP127.....	B24	BP185.....	B28



BP186.....	B23	BP322.....	B29	C8EB.....	C3	C14E.....	C3
BP187.....	B23	BP323.....	B29	C8ER.....	C3	C14E-10.....	C3
BP188.....	B23	BP326.....	B29	C10-2E.....	C5	C14EB.....	C3
BP189.....	B23	BP327.....	B29	C10E.....	C3	C14EB-10.....	C3
BP190.....	B23	BP328.....	B29	C10E-5.....	C3	C14EBR.....	C3
BP191.....	B23	BP329.....	B29	C10E-10.....	C3	C14EBR-10.....	C3
BP192.....	B23	BP330.....	B29	C10EB.....	C3	C14EG.....	C3
BP193.....	B28	BP331.....	B29	C10EB-5.....	C3	C14EG-10.....	C3
BP194.....	B28	BP332.....	B29	C10EB-10.....	C3	C14EP.....	C3
BP200.....	B25	BP333.....	B29	C10EBR.....	C3	C14EP-10.....	C3
BP201.....	B25	BP334.....	B29	C10EBR-5.....	C3	C14EPK.....	C3
BP203.....	B25	BP335.....	B29	C10EBR-10.....	C3	C14EPK-10.....	C3
BP205.....	B25	BP336.....	B29	C10EG.....	C3	C14ER.....	C3
BP207.....	B25	BP337.....	B29	C10EG-5.....	C3	C14ER-10.....	C3
BP209.....	B25	BP338.....	B29	C10EG-10.....	C3	C14ET.....	C3
BP211.....	B25	BP339.....	B29	C10ER.....	C3	C14ET-10.....	C3
BP213.....	B25	BP340.....	B29	C10ER-5.....	C3	C14EW.....	C3
BP215.....	B25	BP341.....	B29	C10ER-10.....	C3	C14EW-10.....	C3
BP217.....	B25	BP342.....	B29	C10EW.....	C3	C14EY.....	C3
BP219.....	B25	BP343.....	B30	C10EW-5.....	C3	C14EY-10.....	C3
BP220.....	B25	BP344.....	B30	C10EW-10.....	C3	C16-2E.....	C5
BP221.....	B25	BP345.....	B30	C10EY.....	C3	C16-2SRB.....	C4, G7
BP223.....	B25	BP346.....	B30	C10EY-5.....	C3	C16-3B.....	C5
BP224.....	B26	BP347.....	B29	C10EY-10.....	C3	C16-3E.....	C5
BP225.....	B25	BP348.....	B29	C12-2E.....	C5	C16-3SRB.....	C4, G7
BP226.....	B26	BP349.....	B29	C12-3J.....	C5	C16-3V.....	C5
BP227.....	B25	BP350.....	B29	C12-4E.....	C5	C16-3VB.....	C4, G7
BP229.....	B25	BP351.....	B29	C12E.....	C3	C16-4B.....	C5
BP230.....	B25	BP352.....	B29	C12E-5.....	C3	C16-4E.....	C5
BP231.....	B25	BP353.....	B29	C12E-10.....	C3	C16-4V.....	C5
BP232.....	B25	BP354.....	B29	C12EB.....	C3	C16E.....	C2
BP233.....	B25	BP355.....	B29	C12EB-5.....	C3	C16E-10.....	C2
BP234.....	B25	BP356.....	B29	C12EB-10.....	C3	C16EB.....	C2
BP235.....	B25	BP357.....	B29	C12EBR.....	C3	C16EB-10.....	C2
BP236.....	B25	BP358.....	B30	C12EBR-5.....	C3	C16EBR.....	C2
BP237.....	B25	BP359.....	B30	C12EBR-10.....	C3	C16EBR-10.....	C2
BP238.....	B25	BP360.....	B30	C12EG.....	C3	C16EG.....	C2
BP239.....	B25	BP361.....	B30	C12EG-5.....	C3	C16EG-10.....	C2
BP240.....	B25	BP362.....	B30	C12EG-10.....	C3	C16EP.....	C2
BP241.....	B25	BP363.....	B30	C12ER.....	C3	C16EP-10.....	C2
BP300.....	B29	BP364.....	B30	C12ER-5.....	C3	C16EPK.....	C2
BP301.....	B29	BP365.....	B30	C12ER-10.....	C3	C16EPK-10.....	C2
BP302.....	B29	BP366.....	B30	C12EW.....	C3	C16ER.....	C2
BP303.....	B29	BP367.....	B30	C12EW-5.....	C3	C16ER-10.....	C2
BP304.....	B29	BP368.....	B30	C12EW-10.....	C3	C16ET.....	C2
BP305.....	B29	BP369.....	B30	C12EY.....	C3	C16ET-10.....	C2
BP307.....	B29	BP370.....	B30	C12EY-5.....	C3	C16EW.....	C2
BP308.....	B29	BP371.....	B30	C12EY-10.....	C3	C16EW-10.....	C2
BP311.....	B29	BP372.....	B30	C14-2E.....	C5	C16EY.....	C2
BP313.....	B29	BPP71.....	B31	C14-3E.....	C5	C16EY-10.....	C2
BP314.....	B29	BPP73.....	B31	C14-3J.....	C5	C18-2SRB.....	C4, G7
BP316.....	B29	BPP74.....	B31	C14-3SRB.....	C4, G7	C18-3VY.....	C4, G7
BP317.....	B29	C4ER.....	C3	C14-4E.....	C5	C18E.....	C2
BP318.....	B29	C6E.....	B22, C3	C14-4J.....	C5	C18E-10.....	C2
BP319.....	B29	C6ER.....	C3	C14BS.....	C3	C18EB.....	C2
BP320.....	B29	C8E.....	C3	C14BS-10.....	C3	C18EB-10.....	C2

INDEX

C18EBR.....	C2	C118EY.....	C5	C216EPK.....	C7	CG26.....	D24
C18EBR-10.....	C2	C206-2E.....	C8	C216ER.....	C7	CG27.....	D24
C18EG.....	C2	C206-3E.....	C8	C216ES.....	C7	CG28.....	D24
C18EG-10.....	C2	C208-2E.....	C8	C216ET.....	C7	CG29.....	D25
C18ER.....	C2	C208-3E.....	C8	C216EW.....	C7	CG30.....	D27
C18ER-10.....	C2	C208EB.....	C7	C216EY.....	C7	CG31.....	D27
C18EW.....	C2	C208EG.....	C7	C218E.....	C7	CG32.....	D27
C18EW-10.....	C2	C208ER.....	C7	C218EB.....	C7	CG33.....	D27
C18EY.....	C2	C208EW.....	C7	C218EBR.....	C7	CG35.....	D28
C18EY-10.....	C2	C210-2E.....	C8	C218EG.....	C7	CG36.....	D28
C20E.....	C2	C210-3E.....	C8	C218ER.....	C7	CG37.....	D28
C20E-10.....	C2	C210E.....	C7	C218EY.....	C7	CG38.....	D25
C20EB.....	C2	C210EB.....	C7	CC7D.....	A23	CG39.....	D25
C20EG.....	C2	C210EBR.....	C7	CC7L.....	A23	CG40.....	D25
C20ER.....	C2	C210EG.....	C7	CC7M.....	A23	CG41.....	D25
C20ER-10.....	C2	C210EP.....	C7	CC7N.....	A23	CG42.....	D25
C20EW.....	C2	C210ER.....	C7	CC7S.....	A23	CG43.....	D26
C20EY.....	C2	C210ET.....	C7	CC8LC.....	A23	CG44.....	D26
C22E.....	C2	C210EW.....	C7	CC8LL.....	A23	CG45.....	D23
C22EB.....	C2	C210EY.....	C7	CC8M.....	A23	CG46.....	D23
C22ER.....	C2	C212-2E.....	C8	CC8S.....	A23	CG47.....	D23
C22EW.....	C2	C212-3E.....	C8	CC75C.....	A23	CG48.....	D28
C110E.....	C5	C212E.....	C7	CC85C.....	A23	CG49.....	D28
C110EB.....	C5	C212EB.....	C7	CD7L.....	A23	CG50.....	D28
C110EBR.....	C5	C212EBR.....	C7	CD7S.....	A23	CG51.....	D28
C110EG.....	C5	C212EG.....	C7	CF16-2HD.....	C4	CG52.....	D28
C110ER.....	C5	C212EGY.....	C7	CF16-2P.....	C4	CG53.....	D28
C110EW.....	C5	C212EP.....	C7	CF18-2HD.....	C4	CG54.....	D27
C110EY.....	C5	C212EPK.....	C7	CF18-2P.....	C4	CG55.....	D27
C112E.....	C5	C212ER.....	C7	CF18-2P-10.....	C4	CG56.....	D27
C112EB.....	C5	C212ES.....	C7	CF20-2P.....	C4	CG57.....	D27
C112EBR.....	C5	C212ET.....	C7	CF20-2P-10.....	C4	CG58.....	D27
C112EG.....	C5	C212EW.....	C7	CG1.....	D23	CG59.....	D27
C112ER.....	C5	C212EY.....	C7	CG2.....	D23	CG60.....	D27
C112EW.....	C5	C214-2E.....	C8	CG3.....	D23	CG61.....	D24
C112EY.....	C5	C214-3E.....	C8	CG4.....	D24	CG62.....	D24
C114E.....	C5	C214E.....	C7	CG5.....	D23	CG63.....	D24
C114EB.....	C5	C214EB.....	C7	CG6.....	D23	CG64.....	D25
C114EBR.....	C5	C214EBR.....	C7	CG7.....	D23	CG65.....	D25
C114EG.....	C5	C214EG.....	C7	CG8.....	D23	CG68.....	D27
C114ER.....	C5	C214EGY.....	C7	CG9.....	D24	CG69.....	D28
C114EW.....	C5	C214EP.....	C7	CG10.....	D25	CG70.....	D26
C114EY.....	C5	C214EPK.....	C7	CG11.....	D25	CG71.....	D26
C116E.....	C5	C214ER.....	C7	CG12.....	D24	CG72.....	D26
C116EB.....	C5	C214ES.....	C7	CG13.....	D25	CG73.....	D26
C116EBR.....	C5	C214ET.....	C7	CG14.....	D24	CG74.....	D26
C116EG.....	C5	C214EW.....	C7	CG15.....	D24	CG75.....	D26
C116ER.....	C5	C214EY.....	C7	CG16.....	D25	CG80.....	D23
C116EW.....	C5	C216-2E.....	C8	CG17.....	D25	CG81.....	D27
C116EY.....	C5	C216-3E.....	C8	CG18.....	D23	CGA1.....	D29
C118E.....	C5	C216E.....	C7	CG19.....	D23	CGA2.....	D29
C118EB.....	C5	C216EB.....	C7	CG21.....	D24	CJ12-4PC.....	E31
C118EBR.....	C5	C216EBR.....	C7	CG22.....	D24	CJ12-4PL.....	E31
C118EG.....	C5	C216EG.....	C7	CG23.....	D24	CJ12-6PC.....	E31
C118ER.....	C5	C216EGY.....	C7	CG24.....	D24	CJ12-6PL.....	E31
C118EW.....	C5	C216EP.....	C7	CG25.....	D24	CJ12-7AC.....	E31

INDEX



CJ12-7AL.....	E31	CL35.....	C10	CS1RV.....	B22	CW14Y.....	C3
CJ12-7BC.....	E31	CL36.....	C10	CS1V.....	B22	CW16-2.....	C4
CJ12-7BE.....	E31	CL37.....	C10	CS2C.....	B22	CW16B.....	C2
CJ12-7BL.....	E31	CL38.....	C9	CS2L.....	B22	CW16BR.....	C2
CJ12-7C.....	E31	CL39.....	C9	CS2RC.....	B22	CW16E.....	C2
CJ12-7DC.....	E31	CL40.....	C9	CS2RV.....	B22	CW16F.....	C4
CJ12-7DE.....	D31	CL41.....	C9	CS2V.....	B22	CW16G.....	C2
CJ12-7DL.....	E31	CL42.....	C9	CS4C.....	B22	CW16P.....	C2
CJ12-7L.....	E31	CL43.....	C9	CS4L.....	B22	CW16PK.....	C2
CJ14-2C.....	E31	CL44.....	C9	CS4RC.....	B22	CW16R.....	C2
CJ14-4BC.....	E31	CLB4.....	C9	CS4RV.....	B22	CW16T.....	C2
CJ14-4BL.....	E31	CLB5.....	C9	CS4V.....	B22	CW16W.....	C2
CJ14-4C.....	E31	CLB11.....	C9	CS6RC.....	B22	CW16Y.....	C2
CJ14-4L.....	E31	CLB12.....	C9	CS6RV.....	B22	CW18-2.....	C4
CJ14-6C.....	E31	CLB13.....	C9	CS6V.....	B22	CW18B.....	C2
CJ14-6L.....	E31	CLB16.....	C9	CS00C.....	B22	CW18BR.....	C2
CJ16-4BC.....	E31	CLB20.....	C9	CS00L.....	B22	CW18E.....	C2
CJ16-4BL.....	E31	CLB22.....	C9	CS00RC.....	B22	CW18F.....	C4
CJ16-4C.....	E31	CLB24.....	C9	CS00RL.....	B22	CW18G.....	C2
CJ16-4L.....	E31	CPBK100.....	A22	CS00RV.....	B22	CW18R.....	C2
CJ16-5C.....	E31	CPBK105.....	A22	CS00V.....	B22	CW18W.....	C2
CJ16-5L.....	E31	CPBK110.....	A22	CS000C.....	B22	CW18Y.....	C2
CJ16-6C.....	E31	CPBK120.....	A22	CS000L.....	B22	CW20-2.....	C4
CJ16-6L.....	E31	CPBK130.....	A22	CS000RC.....	B22	CW20B.....	C2
CL4S.....	C9	CPBK140.....	A22	CS000RL.....	B22	CW20E.....	C2
CL5N.....	C9	CPBK200.....	A22	CS000RV.....	B22	CW20F.....	C4
CL5S.....	C9	CPBK205.....	A22	CS000V.....	B22	CW20G.....	C2
CL5SE.....	C9, C13	CPBK210.....	A22	CS0000RV.....	B22	CW20R.....	C2
CL5SR.....	C9, C13	CPBK220.....	A22	CS0000V.....	B22	CW20W.....	C2
CL5SW.....	C9, C13	CPBK230.....	A22	CW10B.....	C3	CW20Y.....	C2
CL5SY.....	C9, C13	CPBK240.....	A22	CW10BR.....	C3	CW22B.....	C2
CL6S.....	C9	CPBK250.....	A22	CW10E.....	C3	CW22E.....	C2
CL7.....	C9	CPBK260.....	A22	CW10F.....	C4	CW22R.....	C2
CL8.....	C9	CPBK300.....	A22	CW10G.....	C3	CW22W.....	C2
CL9.....	C9	CPBK400.....	A22	CW10R.....	C3	DS116.....	F28
CL10S.....	C9	CPBK405.....	A22	CW10W.....	C3	DS123.....	F29
CL11S.....	C9	CPBK410.....	A22	CW10Y.....	C3	DS126.....	F28
CL12S.....	C9	CPBK420.....	A22	CW12B.....	C3	DS128.....	F28
CL13S.....	C9	CPBK430.....	A22	CW12BR.....	C3	DS135.....	F30
CL14S.....	C9	CPBK440.....	A22	CW12E.....	C3	DS167.....	F28
CL15.....	C9	CPBK450.....	A22	CW12F.....	C4	DS175.....	F30
CL16.....	C9	CPBK460.....	A22	CW12G.....	C3	DS184.....	F28
CL17S.....	C9	CPBK500.....	A22	CW12R.....	C3	DS191.....	F28
CL19.....	C9	CPBK600.....	A22	CW12W.....	C3	DS193.....	F28
CL20.....	C9	CPBK700.....	A22	CW12Y.....	C3	DS194.....	F28
CL21.....	C9	CPBK710.....	A22	CW14B.....	C3	DS208.....	F28
CL22.....	C9	CPBK720.....	A22	CW14BR.....	C3	DS226.....	F28
CL23.....	C9	CS0C.....	B22	CW14BS.....	C3	DS246.....	F30
CL24.....	C9	CS0L.....	B22	CW14E.....	C3	DS270.....	F28
CL26.....	C9	CS0RC.....	B22	CW14F.....	C4	DS271.....	F28
CL28.....	C9	CS0RL.....	B22	CW14G.....	C3	DS277.....	F29
CL29.....	C9	CS0RV.....	B22	CW14P.....	C3	DS280.....	F29
CL30.....	C9	CS0V.....	B22	CW14PK.....	C3	DS293.....	F29
CL32.....	C9	CS1C.....	B22	CW14R.....	C3	DS310.....	F28
CL33.....	C9	CS1L.....	B22	CW14T.....	C3	DS311.....	F28
CL34.....	C10	CS1RC.....	B22	CW14W.....	C3	DS312.....	F28

INDEX

DS313.....	F28	DS1346.....	F30	ET70.....	B34	ET130XL.....	D10
DS314.....	F28	DS1791.....	F30	ET71.....	B34	ET131.....	D10
DS315.....	F28	DS1821.....	F29	ET91.....	D3	ET131H.....	D10, D20
DS316.....	F28	ET2.....	B37	ET91L.....	D3	ET131HJ.....	D10, D20
DS317.....	F29	ET3.....	C9	ET92.....	D3	ET131L.....	D10
DS318.....	F29	ET4.....	C9	ET92L.....	D3	ET131XL.....	D10
DS319.....	F29	ET5.....	C9	ET93.....	D3	ET132.....	D10
DS320.....	F29	ET5E.....	C9, C13	ET93L.....	D3	ET132H.....	D10, D20
DS322.....	F28	ET5R.....	C9, C13	ET94.....	D3	ET132HJ.....	D10, D20
DS362.....	F29	ET5W.....	C9, C13	ET94L.....	D3	ET132L.....	D10
DS363.....	F30	ET5Y.....	C9, C13	ET95.....	D3	ET132XL.....	D10
DS364.....	F29	ET6.....	C9	ET95L.....	D3	ET133.....	D7
DS365.....	F29	ET7.....	C9	ET96.....	D3	ET134.....	D7
DS366.....	F30	ET7B.....	C9	ET96L.....	D3	ET134XL.....	D7
DS367.....	F30	ET7E.....	C9, C13	ET97L.....	D8	ET135.....	D7
DS368.....	F30	ET7R.....	C9, C13	ET98L.....	D8	ET135H.....	D7, D19
DS369.....	F30	ET7Y.....	C9, C13	ET100.....	A24, D35	ET135XL.....	D7
DS1307.....	F30	ET8.....	C9	ET113.....	A23	ET136.....	D6
DS1308.....	F30	ET9.....	C9	ET114.....	A23	ET136XL.....	D6
DS1309.....	F30	ET10.....	A25	ET116.....	A24	ET137.....	D9
DS1310.....	F30	ET11.....	C11	ET120.....	D3	ET139.....	D13
DS1311.....	F30	ET12.....	B37	ET120H.....	D3, D19	ET139L.....	D13
DS1312.....	F29	ET14.....	B37	ET120L.....	D3	ET139XL.....	D13
DS1313.....	F29	ET15.....	D31	ET120XL.....	D3	ET140.....	D8
DS1314.....	F29	ET16.....	D31	ET121.....	D3	ET140L.....	D8
DS1315.....	F29	ET18.....	B37	ET121H.....	D3, D19	ET140XL.....	D8
DS1316.....	F29	ET20.....	B37	ET122.....	D3	ET141.....	D8
DS1317.....	F29	ET21.....	B36	ET122H.....	D3, D19	ET141L.....	D8
DS1318.....	F29	ET26.....	A24	ET123.....	D3	ET141XL.....	D8
DS1319.....	F29	ET27.....	B36	ET123H.....	D4, D19	ET142.....	D7
DS1320.....	F29	ET28.....	B36	ET123L.....	D3	ET143.....	D7
DS1321.....	F29	ET29.....	B36	ET124.....	D3	ET144.....	D8
DS1322.....	F29	ET30.....	C4	ET124H.....	D4, D19	ET144H.....	D8, D20
DS1323.....	F29	ET31.....	C4	ET124L.....	D3	ET144L.....	D8
DS1324.....	F30	ET32.....	C4	ET124XL.....	D3	ET144XL.....	D8
DS1325.....	F30	ET33.....	C4	ET125.....	D3	ET145.....	D8
DS1326.....	F30	ET34.....	C4	ET125H.....	D4, D19	ET145H.....	D8, D20
DS1327.....	F30	ET35.....	C4	ET125L.....	D3	ET145L.....	D8
DS1328.....	F30	ET36.....	C4	ET125XL.....	D3	ET145XL.....	D8
DS1329.....	F30	ET37.....	C3	ET126.....	D3	ET146.....	D13
DS1330.....	F30	ET38.....	B36	ET126H.....	D4, D19	ET147.....	D11
DS1331.....	F30	ET40.....	C11	ET126L.....	D3	ET148.....	D7
DS1332.....	F29	ET41.....	C11	ET127.....	D4	ET148L.....	D7
DS1333.....	F29	ET42.....	C11	ET127H.....	D5, D19	ET148XL.....	D7
DS1334.....	F29	ET43.....	C11	ET127L.....	D4	ET149.....	D7
DS1335.....	F29	ET44.....	C11	ET127XL.....	D4	ET149L.....	D7
DS1336.....	F29	ET45.....	C11	ET128.....	D4	ET149XL.....	D7
DS1337.....	F29	ET46.....	C11	ET128L.....	D4	ET150.....	D6
DS1338.....	F29	ET57.....	B34	ET128XL.....	D4	ET151.....	D3
DS1339.....	F29	ET58.....	B34	ET129.....	D5	ET151H.....	D3, D19
DS1340.....	F29	ET59.....	B34	ET129L.....	D5	ET152.....	D14
DS1341.....	F29	ET60.....	B34	ET129XL.....	D5	ET154.....	D6
DS1342.....	F29	ET61.....	A23	ET130.....	D10	ET155.....	D6
DS1343.....	F29	ET62.....	C10	ET130H.....	D10, D20	ET156.....	D9
DS1344.....	F29	ET66.....	A23	ET130HJ.....	D10, D20	ET157.....	D3
DS1345.....	F29	ET67.....	B34	ET130L.....	D10	ET157H.....	D4, D19



ET158.....	D9	ET226.....	D15	ET355.....	D3, D20	ET497.....	D3, D20
ET159L.....	D5	ET227.....	D15	ET356.....	D3, D20	ET497H.....	D3, D19
ET161.....	D9	ET228.....	D15	ET357.....	D3, D20	ET498.....	D3
ET161L.....	D9	ET229.....	D15	ET359.....	D4, D20	ET500.....	D8, D12
ET161XL.....	D9	ET230.....	D14	ET360.....	D4, D20	ET501.....	D17
ET162.....	D11	ET231.....	D14	ET361.....	D4, D21	ET502.....	D13
ET162L.....	D11	ET232.....	D15	ET363.....	D5, D21	ET503.....	D12
ET163.....	D11	ET233.....	D15	ET364.....	D5, D21	ET504.....	D12
ET163L.....	D11	ET234.....	D15	ET365.....	D5, D21	ET505.....	C10
ET164.....	D11	ET235.....	D15	ET367.....	D7, D21	ET506.....	C10
ET165.....	D6	ET236.....	D15	ET381.....	D13	ET507.....	D23
ET166.....	D9	ET237.....	D15	ET381XL.....	D13	ET508.....	D23
ET168L.....	D4, D19	ET250.....	C12	ET383.....	D14	ET509.....	D15
ET170.....	D11	ET250L.....	C12	ET388L.....	D6	ET510.....	D15
ET171.....	D11	ET251L.....	C12	ET389L.....	D6	ET511.....	D12
ET172.....	D11	ET252L.....	C12	ET390L.....	D6	ET512.....	D9, D22
ET173.....	D11	ET253L.....	C12	ET394L.....	D7	ET513.....	D12
ET176.....	D13	ET254.....	C12	ET395L.....	D8	ET514.....	D12
ET176XL.....	D13	ET254L.....	C12	ET396L.....	D8	ET515.....	G2
ET178.....	D9	ET255L.....	C12	ET400.....	G3	ET516.....	G2
ET179.....	D9	ET256.....	C12	ET411.....	F15	ET517.....	G2
ET180.....	D13	ET256E.....	C13	ET437L.....	D10	ET518.....	G2
ET181.....	D13	ET256R.....	C13	ET446L.....	D7	ET519.....	G2
ET182.....	D9	ET256W.....	C13	ET447L.....	D7	ET520.....	G3
ET183.....	D9	ET256Y.....	C13	ET448.....	G3	ET521.....	G3
ET195.....	D9	ET260.....	B37	ET450.....	E29	ET522.....	G3
ET196.....	D10	ET261.....	C10	ET451.....	E29	ET523.....	D17
ET196L.....	D10	ET263.....	B37	ET452.....	E29	ET524.....	D4
ET197.....	D10	ET270.....	C10	ET456.....	E29	ET526.....	D12
ET197L.....	D10	ET271EL.....	C13	ET457.....	C5	ET527L.....	D11, D12
ET198.....	D10	ET271L.....	C12	ET458.....	C5	ET528.....	D7, D12
ET198L.....	D10	ET271RL.....	C13	ET460.....	D14	ET529L.....	D10, D12
ET200.....	D13	ET271WL.....	C13	ET461.....	D14	ET530.....	D17
ET201.....	D13	ET271YL.....	C13	ET468.....	D8, D22	ET533.....	D17
ET202.....	D13	ET272.....	C10	ET469.....	D8, D22	ET535.....	D17, E29
ET203.....	D13	ET273.....	C10	ET470.....	D8, D22	ET536.....	D17
ET204.....	D13	ET274.....	C10	ET471.....	D8, D22	ET537.....	D17
ET207.....	D9	ET275.....	C10	ET472.....	D9, D22	ET538.....	D17
ET207XL.....	D9	ET276L.....	C12	ET473.....	D9, D22	ET550.....	D10, D22
ET208.....	D7	ET279L.....	C12	ET474.....	D9, D22	ET551.....	D10, D22
ET208XL.....	D7	ET280L.....	C12	ET475.....	D3, D20	ET551J.....	D10, D22
ET210.....	D13	ET290.....	C10	ET476.....	D3, D20	ET552.....	D10, D22
ET211.....	D13	ET291.....	C10	ET478.....	D4, D21	ET552J.....	D10, D22
ET212.....	D13	ET292.....	C10	ET479.....	D5, D21	ET553.....	D10, D22
ET214.....	D15	ET293.....	C10	ET480L.....	D7	ET553J.....	D10, D22
ET215.....	D15	ET294.....	C10	ET481L.....	D7	ET556.....	D3, D22
ET216.....	D15	ET295.....	C10	ET482L.....	D8	ET559.....	D4, D22
ET217.....	D15	ET296.....	C10	ET483L.....	D8	ET560.....	D4, D22
ET218.....	D15	ET297.....	C10	ET484L.....	D7	ET561.....	D4, D22
ET219.....	D15	ET298.....	C10	ET485L.....	D8	ET562.....	D5, D22
ET220.....	D14	ET351.....	D10, D21	ET486.....	D6	ET564.....	D5, D22
ET221.....	D14	ET351J.....	D10, D21	ET491.....	D7	ET570.....	D8, D22
ET222.....	D14	ET352.....	D10, D21	ET492.....	D7	ET571.....	D8, D22
ET223.....	D15	ET352J.....	D10, D21	ET493.....	D4	ET600L.....	D7
ET224.....	D15	ET353.....	D10, D21	ET494L.....	D4	ET601L.....	D7
ET225.....	D15	ET353J.....	D10, D21	ET495L.....	D4	ET701.....	D23

INDEX

ET702.....	D23	GR8.....	C11	HST210.....	B36	PW14B.....	C3
ET703.....	D23	HB6B.....	F30	HST210R.....	B36	PW14BR.....	C3
ET704.....	D23	HB7.....	F30	HST230.....	B36	PW14BS.....	C3
ET705.....	D23	HD56.....	B35	HST230R.....	B36	PW14E.....	C3
ET706.....	D23	HD57.....	B35	HST240B.....	B36	PW14G.....	C3
ET708.....	D23	HD58.....	B35	HST240R.....	B36	PW14P.....	C3
ET709.....	D23	HD59C.....	B34	HST240SB.....	B36	PW14PK.....	C3
ET710.....	D23	HD60C.....	B34	HST240SR.....	B36	PW14R.....	C3
ET711.....	D23	HD61C.....	B34	HST401.....	B37	PW14T.....	C3
ET712.....	D23	HD62.....	B35	MC0BL.....	C8	PW14W.....	C3
ET713.....	D23	HD62C.....	B34	MC0RL.....	C8	PW14Y.....	C3
ET714.....	D24	HD63.....	B35	MC1BL.....	C8	PW16B.....	C2
ET715.....	D24	HD63C.....	B34	MC1RL.....	C8	PW16BR.....	C2
ET716.....	D24	HD64.....	B35	MC2BL.....	C8	PW16E.....	C2
ET717.....	D24	HD64C.....	B34	MC2RL.....	C8	PW16G.....	C2
ET718.....	D24	HD65.....	B35	MC4BL.....	C8	PW16P.....	C2
ET719.....	D24	HD66.....	B35	MC4RL.....	C8	PW16PK.....	C2
ET720.....	D24	HS98.....	F30	MC6BL.....	C8	PW16R.....	C2
ET721.....	D24	HST1A.....	B38, D33	MC6RL.....	C8	PW16T.....	C2
ET722.....	D24	HST2A.....	B38, D33	MC00BL.....	C8	PW16W.....	C2
ET723.....	D24	HST3.....	B37	MC00RL.....	C8	PW16Y.....	C2
ET724.....	D24	HST6.....	B37	MC000BL.....	C8	PW18B.....	C2
ET725.....	D24	HST6H.....	B37	MC000RL.....	C8	PW18BR.....	C2
ET726.....	D27	HST6L.....	B37	MC0000BL.....	C8	PW18E.....	C2
ET727.....	D27	HST10.....	B37	MC0000RL.....	C8	PW18G.....	C2
ET728.....	D27	HST10H.....	B37	MC1101.....	A5	PW18R.....	C2
ET729.....	D27	HST10L.....	B37	MC1102.....	A5	PW18W.....	C2
ET731.....	D28	HST14.....	B37	MC1103.....	A5	PW18Y.....	C2
ET732.....	D28	HST14H.....	B37	MC1104.....	A5	PW20B.....	C2
ET733.....	D28	HST14L.....	B37	MC1105.....	A5	PW20E.....	C2
ET734.....	D24	HST18.....	B37	MC1106.....	A5	PW20G.....	C2
ET735.....	D25	HST18B.....	B37	MC1107.....	A5	PW20R.....	C2
ET736.....	D25	HST18H.....	B37	MC1108.....	A5	PW20W.....	C2
ET737.....	D25	HST18L.....	B37	MC1109.....	A5	PW20Y.....	C2
ET738.....	D25	HST21.....	B36	MC1110.....	A5	QC10.....	B18
ET739.....	D25	HST28.....	B36	MC1111.....	A5	QC11.....	B18
ET740.....	D25	HST30.....	B37	MC1112.....	A5	QC12.....	B18
ET741.....	D25	HST81B.....	B36	MC1113.....	A5	QC14.....	B18
ET742.....	D25	HST81R.....	B36	MC1114.....	A5	QC15.....	B18
ET743.....	D25	HST81SB.....	B36	MC1115.....	A5	QC16.....	B18
ET744.....	D25	HST81SR.....	B36	MC1116.....	A5	QC17.....	B18
ET745.....	D25	HST82.....	B36	MC1117.....	A5	QC18.....	B18
ET746.....	D25	HST83.....	B36	PW10B.....	C3	QC19.....	B18
ET747.....	D25	HST83R.....	B36	PW10BR.....	C3	QC20.....	B18
ET748.....	D26	HST84.....	B36	PW10E.....	C3	QC21.....	B18
ET749.....	D26	HST85.....	B36	PW10G.....	C3	QC22.....	B18
ET904X.....	D34	HST86.....	B36	PW10R.....	C3	QC23.....	B18
ET912.....	D3	HST87.....	B36	PW10W.....	C3	S20.....	F2
ET2012.....	B17	HST88.....	B36	PW10Y.....	C3	S21.....	F2
GR1.....	C11	HST89.....	B36	PW12B.....	C3	S22.....	F2
GR2.....	C11	HST90.....	B37	PW12BR.....	C3	S23.....	F2
GR3.....	C11	HST91.....	B36	PW12E.....	C3	S24.....	F3
GR4.....	C11	HST92.....	B36	PW12G.....	C3	S25N.....	F3
GR5.....	C11	HST93.....	B36	PW12R.....	C3	S26N.....	F3
GR6.....	C11	HST146B.....	B36	PW12W.....	C3	S27.....	F3
GR7.....	C11	HST146R.....	B36	PW12Y.....	C3	S29.....	F3



S30N.....	F2	S99.....	F5	S556.....	F13	S620.....	F21
S31N.....	F3	S100.....	F5	S557.....	F6	S621.....	F24
S32.....	F3	S500A.....	F3	S558.....	F20	S622.....	F26
S35.....	F2	S501.....	F5	S559.....	F10	S623.....	F26
S36N.....	F4	S502.....	F9	S560.....	F13	S624.....	F21
S37N.....	F4	S503A.....	F5	S561.....	F20	S625.....	F24
S38N.....	F2	S504.....	F9	S562.....	F13	S626.....	F10
S39.....	F4	S505.....	F9	S563.....	F13	S627.....	F21
S40.....	F2	S506.....	F6	S564.....	F18	S628.....	F21
S43N.....	F4	S507.....	F9	S565.....	F18	S629.....	F21
S44.....	F4	S508.....	F6	S566.....	F13	S630.....	F21
S45N.....	F2	S509.....	F6	S567.....	F13	S631.....	F21
S46N.....	F4	S510.....	F9	S568.....	F13	S632.....	F26
S47N.....	F4	S511.....	F9	S569.....	F18	S633.....	F14
S49.....	F4	S512.....	F9	S570.....	F6	S634.....	F14
S51.....	F4	S513.....	F3	S571.....	F6	S635.....	F12
S54.....	F8	S514.....	F6	S572.....	F7	S636.....	F14
S55.....	F8	S515.....	F3	S573.....	F3	S637.....	F18
S56.....	F2	S516.....	F23	S574.....	F18	S638.....	F21
S57.....	F2	S517.....	F6	S575.....	F14	S639.....	F12
S58.....	F4	S518.....	F6	S576.....	F14	S640.....	F18
S59.....	F7	S519.....	F9	S577.....	F18	S641.....	F14
S60.....	F2	S520.....	F9	S578.....	F14	S643.....	F12
S61.....	F2	S521.....	F9	S579.....	F18	S647.....	F14
S62.....	F2	S522.....	F9	S581.....	F14	S648.....	F14
S63.....	F4	S523.....	F6	S582.....	F12	S649.....	F14
S64.....	F17	S524.....	F6	S583.....	F14	S650.....	F15
S65.....	F8	S525.....	F10	S584.....	F10	S651.....	F15
S67.....	F4	S526.....	F10	S585.....	F10	S652.....	F24
S68.....	F9	S527.....	F20	S586.....	F7	S653.....	F15
S69.....	F9	S528.....	F20	S587.....	F14	S654.....	F24
S71.....	F4	S529.....	F6	S588.....	F14	S655.....	F12
S72.....	F17	S530.....	F20	S589.....	F7	S656.....	F18
S74.....	F4	S531.....	F10	S590.....	F10	S657.....	F18
S75.....	F5	S532.....	F10	S591.....	F7	S658.....	F21
S76.....	F9	S533.....	F10	S592.....	F7	S659.....	F24
S77.....	F9	S535.....	F6	S594.....	F18	S660.....	F21
S78.....	F13	S536.....	F13	S595.....	F18	S661.....	F26
S79.....	F13	S537.....	F13	S596.....	F14	S662.....	F27
S80.....	F5	S538.....	F13	S598.....	F20	S663.....	F15
S81.....	F12	S539.....	F18	S600A.....	F10	S664.....	F27
S82.....	F17	S540.....	F6	S601.....	F21	S665.....	F26
S83.....	F17	S541.....	F6	S602.....	F18	S666.....	F27
S84.....	F13	S542.....	F18	S604.....	F21	S667.....	F15
S85.....	F13	S544.....	F25	S605.....	F23	S668.....	F21
S86.....	F9	S545.....	F18	S606.....	F25	S669.....	F7
S87.....	F3	S546.....	F25	S607.....	F26	S670.....	F15
S89.....	F5	S547.....	F10	S609.....	F26	S672.....	F27
S91.....	F9	S548.....	F10	S610.....	F14	S673.....	F10
S92.....	F18	S549.....	F23	S611.....	F25	S674.....	F18
S93.....	F20	S550.....	F12	S612.....	F14	S675.....	F26
S94.....	F25	S551.....	F20	S613.....	F18	S677.....	F19
S95.....	F5	S552.....	F18	S614.....	F14	S678.....	F25
S96.....	F5	S553.....	F13	S615.....	F23	S679.....	F25
S97.....	F5	S554.....	F12	S617.....	F21	S681.....	F15
S98.....	F5	S555.....	F20	S619.....	F18	S682.....	F19

INDEX

S683	F15	S751	F16	S810	F8	S890	F11
S685	F15	S752	F24	S811	F16	S891	F11
S686	F10	S753	F24	S812	F16	S893	F17
S687	F21	S754	F22	S813	F27	S896	F26
S688	F19	S755	F20	S814	F23	S897	F24
S689	F15	S756	F27	S815	F8	S904	F17
S690	F19	S757	F16	S816	F16	SD647	B17
S691	F15	S758	F20	S817	F23	SK25	F17
S692	F26	S759	F22	S818	F16	SK29	F17
S694	F19	S760	F20	S819	F16	SL3	A23
S695	F15	S761	F22	S820	F16	SL4	A23
S696	F15	S762	F24	S821	F20	SPP1	A17
S697	F15	S763	F22	S822	F27	SPP2	A17
S698	F21	S764	F25	S823	F16	SPP3	A17
S699	F15	S765	F22	S824	F17	SPP4	A17
S700	F21	S766	F7	S825	F23	SPP5	A17
S703	F3	S767	F7	S826	F17	SPP6	A17
S705	F15	S768	F7	S827	F17	SPP7	A16
S706	F21	S769	F7	S829	F11	SPP8	A16
S708	F7	S770	F7	S830	F8	SPP10	A17
S709	F15	S771	F3	S831	F17	SPP11	F17
S711	F19	S772	F7	S833	F12	SPP15	A17
S712	F16	S773	F7	S834	F23	SPP17	A17
S713	F25	S775	F10	S835	F8	SPP19	A17
S714	F21	S776	F10	S836	F27	SPP20	A16
S715	F16	S777	F10	S838	F17	SPP22	A17
S716	F23	S778	F8	S839	F12	SPP23	A17
S717	F16	S779	F10	S840	F12	SPP24	A17
S718	F24	S780	F24	S841	F8	SPP25	A17
S719	F22	S781	F24	S842	F8	SPP26	A17
S720	F26	S782	F27	S843	F12	SPP27	A18
S721	F22	S783	F10	S844	F11	SPP27E	A18
S722	F16	S784	F22	S845	F11	SPP27HT	A18
S723	F26	S785	F20	S846	F26	SPP27HTE	A18
S724	F19	S786	F10	S847	F11	SPP28	A17
S725	F19	S787	F10	S848	F17	SPP29	A17
S726	F24	S788	F25	S849	F17	SPP30	A17
S727	F16	S789	F8	S850	F23	SPP31	A17
S728	F22	S790	F12	S853	F12	SPP32	A17
S729	F22	S791	F10	S855	F20	SPP33	A16
S730	F22	S792	F16	S856	F8	SPP34	A16
S732	F19	S795	F22	S857	F23	SPP35	A16
S733	F12	S796	F25	S858	F8	SPP36	A16
S734	F19	S797	F10	S860	F23	SPP37	A16
S735	F16	S798	F26	S861	F23	SPP38	A17
S736	F24	S799	F16	S862	F11	SPP39	A18
S737	F16	S800	F27	S863	F8	SPP39E	A18
S738	F19	S801	F26	S865	F3	SPP39HT	A18
S740	F16	S802	F25	S866	F11	SPP39HTE	A18
S742	F24	S803	F24	S867	F20	SPP39L	A18
S743	F16	S804	F27	S868	F11	SPP40	A18
S744	F27	S805	F23	S872	F11	SPP40E	A18
S745	F19	S806	F8	S874	F11	SPP41	A18
S747	F19	S807	F8	S877	F8	SPP41E	A18
S749	F25	S808	F10	S878	F11	SPP42	A18
S750	F19	S809	F10	S879	F11	SPP42E	A18



SPP43.....	A18	SPP71E.....	A18	SPP100E.....	A19	SPP148E.....	A21
SPP44.....	A18	SPP72.....	A18	SPP101.....	A19	SPP149E.....	A21
SPP44E.....	A18	SPP72E.....	A18	SPP101E.....	A19	SPP150E.....	A21
SPP45.....	A18	SPP73.....	A19	SPP102.....	A19	SPP151E.....	A21
SPP45E.....	A18	SPP73E.....	A19	SPP102E.....	A19	SPP152E.....	A21
SPP46.....	A18	SPP74.....	A19	SPP103.....	A19	SPP153E.....	A21
SPP46E.....	A18	SPP74E.....	A19	SPP103E.....	A19	SPP154E.....	A21
SPP47.....	A18	SPP75.....	A19	SPP104.....	A19	SPP155E.....	A21
SPP47E.....	A18	SPP75E.....	A19	SPP104E.....	A19	SPP156E.....	A21
SPP48.....	A18	SPP76.....	A19	SPP105.....	A19	SPP157E.....	A21
SPP48E.....	A18	SPP76E.....	A19	SPP105E.....	A19	SPP158E.....	A21
SPP49.....	A18	SPP77.....	A19	SPP106.....	A19	SPP159E.....	A21
SPP49E.....	A18	SPP77E.....	A19	SPP106E.....	A19	SPP160E.....	A21
SPP50.....	A18	SPP78.....	A19	SPP107.....	A19	SPP161E.....	A21
SPP50E.....	A18	SPP78E.....	A19	SPP107E.....	A19	SPP162E.....	A21
SPP51.....	A18	SPP79.....	A19	SPP108.....	A19	SPP163E.....	A21
SPP51E.....	A18	SPP79E.....	A19	SPP108E.....	A19	SPP164E.....	A21
SPP52.....	A18	SPP80.....	A19	SPP109.....	A19	SPP165E.....	A21
SPP52E.....	A18	SPP80E.....	A19	SPP109E.....	A19	SPP166E.....	A21
SPP53.....	A18	SPP81.....	A19	SPP110.....	A19	SPP167E.....	A21
SPP53E.....	A18	SPP81E.....	A19	SPP110E.....	A19	SPP168E.....	A21
SPP54.....	A18	SPP82.....	A19	SPP111E.....	A20	SPP169E.....	A21
SPP54E.....	A18	SPP82E.....	A19	SPP112E.....	A20	SPP170E.....	A21
SPP55.....	A18	SPP83.....	A19	SPP113E.....	A20	SPP171E.....	A21
SPP55E.....	A18	SPP83E.....	A19	SPP114E.....	A20	SPP173E.....	A21
SPP56.....	A18	SPP84.....	A19	SPP115E.....	A20	SPP175E.....	A21
SPP56E.....	A18	SPP85.....	A19	SPP116E.....	A20	SSB2.....	F30
SPP57.....	A18	SPP85E.....	A19	SPP117E.....	A20	SSB3.....	F30
SPP57E.....	A18	SPP86.....	A19	SPP118E.....	A20	SSB5.....	F30
SPP58.....	A18	SPP86E.....	A19	SPP119E.....	A20	SST71.....	D16
SPP58E.....	A18	SPP87.....	A19	SPP120E.....	A20	SST72.....	D16
SPP59.....	A18	SPP87E.....	A19	SPP121E.....	A20	SST73.....	D16
SPP59E.....	A18	SPP88.....	A19	SPP122E.....	A20	SST74.....	D16
SPP60.....	A18	SPP88E.....	A19	SPP123E.....	A20	SST75.....	D16
SPP60E.....	A18	SPP89.....	A19	SPP124E.....	A20	SST76.....	D16
SPP61.....	A18	SPP89E.....	A19	SPP125E.....	A20	SST77.....	D16
SPP61E.....	A18	SPP90.....	A19	SPP127E.....	A20	SST80.....	D16
SPP62.....	A18	SPP91.....	A19	SPP128E.....	A20	SST81.....	D16
SPP62E.....	A18	SPP91E.....	A19	SPP129E.....	A20	SST82.....	D16
SPP63.....	A18	SPP92.....	A19	SPP130E.....	A20	SST83.....	D16
SPP63E.....	A18	SPP92E.....	A19	SPP131E.....	A20	SST84.....	D16
SPP64.....	A18	SPP93.....	A19	SPP132E.....	A20	SST86.....	D15
SPP64E.....	A18	SPP93E.....	A19	SPP133E.....	A20	SST87.....	D16
SPP65.....	A18	SPP94.....	A19	SPP134E.....	A20	SST88.....	D16
SPP65E.....	A18	SPP94E.....	A19	SPP135E.....	A20	SST89.....	B17, B30, D16
SPP66.....	A18	SPP95.....	A19	SPP136E.....	A20	SST90.....	B17, B30, D16
SPP66E.....	A18	SPP95E.....	A19	SPP137E.....	A20	SST91.....	D16
SPP67.....	A18	SPP96.....	A19	SPP138E.....	A20	SST92.....	D16
SPP67E.....	A18	SPP96E.....	A19	SPP139E.....	A20	SST92A.....	D16
SPP68.....	A18	SPP97.....	A19	SPP140E.....	A20	SST93.....	D16
SPP68E.....	A18	SPP97E.....	A19	SPP141E.....	A20	SST95.....	D12
SPP69.....	A18	SPP98.....	A19	SPP142E.....	A20	SST96.....	D12
SPP69E.....	A18	SPP98E.....	A19	SPP143E.....	A20	SST97.....	D9
SPP70.....	A18	SPP99.....	A19	SPP144E.....	A21	SST98.....	D15
SPP70E.....	A18	SPP99E.....	A19	SPP145E.....	A21	SST99.....	D15
SPP71.....	A18	SPP100.....	A19	SPP146E.....	A21	SST100.....	D15

INDEX

SST101.....	D16	ST83.....	C10	STP123.....	D3	STP144.....	D8
SST102.....	D15	ST84.....	C10	STP123H.....	D4, D19	STP144D.....	D8
SST103.....	D16	ST85.....	C10	STP124.....	D3	STP144H.....	D8, D20
SST104.....	D16	ST106.....	A23	STP124D.....	D3	STP144HL.....	D8, D20
SST200.....	D16	ST107.....	A23	STP124H.....	D4, D19	STP145.....	D8
SST201.....	D16	ST110.....	D15	STP124HL.....	D4, D19	STP145D.....	D8
SST202.....	D16	ST113.....	A23	STP125.....	D3	STP145H.....	D8, D20
SST203.....	D16	ST114.....	A23	STP125D.....	D3	STP145HL.....	D8, D20
SST205.....	D16	ST115.....	A24	STP125H.....	D4, D19	STP146.....	D13
SST206.....	D14	ST116.....	A24	STP126.....	D3	STP147.....	D11
SST299.....	B30	ST119.....	A23	STP126H.....	D4, D19	STP148.....	D7
SST300.....	B30	ST120.....	A24	STP127.....	D4, D19	STP149.....	D7
SST301.....	B30	ST121.....	A24	STP127H.....	D5, D19	STP150.....	D6
SST302.....	B30	ST122.....	A23	STP128.....	D4	STP150H.....	D7, D19
SST303.....	B30	ST131.....	A23	STP128D.....	D4	STP151.....	D3
SST304.....	B30	ST230.....	D14	STP128H.....	D5, D19	STP151H.....	D3, D19
SST305.....	B30	ST231.....	D14	STP129.....	D5	STP152.....	D14
SST306.....	B30	ST291.....	C10	STP129H.....	D5, D19	STP153.....	D9
SST307.....	B30	ST292.....	C10	STP130.....	D10	STP154.....	D6
SST308.....	B32	ST293.....	C10	STP130D.....	D10	STP155.....	D6
SST308T.....	B32	ST294.....	C10	STP130H.....	D10, D20	STP155C.....	D6
SST309.....	B32	ST295.....	C10	STP130HC.....	D10, D20	STP156.....	D9
SST309T.....	B32	ST296.....	C10	STP131.....	D10	STP157.....	D3
SST310.....	B32	ST297.....	C10	STP131C.....	D10	STP157C.....	D3
SST310T.....	B32	ST522.....	A23	STP131D.....	D10	STP157H.....	D4, D19
SST311.....	B32	ST523.....	A23	STP131H.....	D10, D20	STP158.....	D9
SST311T.....	B32	STA10.....	A24, D30	STP131HC.....	D10, D20	STP159.....	D5
SST312.....	B32	STA11.....	D30	STP132.....	D10	STP159H.....	D5, D19
SST312T.....	B32	STA12.....	D30	STP132D.....	D10	STP160.....	D14
SST313.....	B32	STA14.....	D32	STP132H.....	D10, D20	STP161.....	D9
ST22.....	A24	STA15.....	B23, D33	STP132HC.....	D10, D20	STP162.....	D11
ST25.....	A24	STA17.....	D32	STP133.....	D7	STP162C.....	D11
ST26.....	A24	STA23.....	D32	STP133D.....	D7	STP162H.....	D12, D20
ST27.....	A24	STA26.....	D33	STP133H.....	D7, D19	STP163.....	D11
ST28.....	A24	STA27.....	D33	STP134.....	D7	STP163C.....	D11
ST30.....	A24	STA28.....	D33	STP134H.....	D7, D19	STP163H.....	D12, D20
ST55.....	D16	STA50.....	C11	STP135.....	D7	STP164.....	D11
ST60.....	C10	STA51.....	D30	STP135D.....	D7	STP164C.....	D11
ST61.....	C10	STL1.....	D12	STP135H.....	D7, D19	STP165.....	D6
ST62.....	C10	STL2.....	D12	STP136.....	D6	STP166.....	D9
ST63.....	C10	STL3.....	D12	STP136H.....	D7, D19	STP166H.....	D9, D20
ST64.....	C10	STP91.....	D3	STP137.....	D9	STP167.....	D9
ST65.....	C10	STP92.....	D3	STP137H.....	D9, D20	STP168.....	D4, D19
ST66.....	C10	STP93.....	D3	STP138.....	D13	STP168H.....	D5, D19
ST67.....	C10	STP94.....	D3	STP139.....	D13	STP170.....	D11
ST68.....	D15	STP95.....	D3	STP139D.....	D13	STP170H.....	D11, D20
ST69.....	C10	STP96.....	D3	STP140.....	D8	STP171.....	D11
ST70.....	C10	STP97.....	D8	STP140D.....	D8	STP171H.....	D11, D20
ST71.....	C10	STP98.....	D8	STP141.....	D8	STP172.....	D11
ST72.....	C10	STP120.....	D3	STP141D.....	D8	STP173.....	D11
ST73.....	C10	STP120H.....	D3, D19	STP142.....	D7	STP174.....	D6
ST74.....	C10	STP120HL.....	D3	STP142H.....	D8, D20	STP175.....	D5
ST75.....	C10	STP121.....	D3	STP142HL.....	D8, D20	STP176.....	D13
ST80.....	C10	STP121H.....	D3, D19	STP143.....	D7	STP177.....	D5
ST81.....	C10	STP122.....	D3	STP143H.....	D8, D20	STP177H.....	D6, D19
ST82.....	C10	STP122H.....	D3, D19	STP143HL.....	D8, D20	STP178.....	D9



STP178H.....	D9, D20	STP355.....	D3, D20	STP438.....	D4	STP501C.....	D17
STP179.....	D9	STP356.....	D3, D20	STP439.....	D4	STP516.....	D17
STP179H.....	D9, D20	STP357.....	D3, D20	STP440.....	D4	STP517.....	D17
STP180.....	D13	STP358.....	D4, D20	STP441.....	D5	STP518.....	D17
STP181.....	D13	STP359.....	D4, D20	STP442.....	D5	STP519.....	D17
STP182.....	D9	STP359C.....	D4, D20	STP443.....	D5	STP520.....	D17
STP183.....	D9	STP360.....	D4, D20	STP444.....	D5	STP523.....	D17
STP184.....	D10	STP361.....	D4, D21	STP445.....	D6	STP523C.....	D17
STP185.....	D10	STP362.....	D5, D21	STP446.....	D7	STP524.....	D4
STP186.....	D10	STP363.....	D5, D21	STP447.....	D7	STP524D.....	D4
STP186H.....	D10, D20	STP364.....	D5, D21	STP462.....	D12	STP525.....	D13
STP187.....	D6	STP365.....	D5, D21	STP463.....	D12	STP527.....	D17
STP188.....	D5	STP366.....	D7, D21	STP464.....	D14	STP530.....	D17
STP188H.....	D6, D19	STP367.....	D7, D21	STP466.....	D14	STP530C.....	D17
STP189.....	D6	STP368.....	D7, D21	STP467.....	D14	STP531.....	D17
STP190.....	D6	STP369.....	D12	STP468.....	D8, D22	STP532.....	D17
STP191.....	D6	STP370.....	D12	STP468C.....	D8, D22	STP533.....	D17
STP192.....	D6	STP371.....	D11	STP469.....	D8, D22	STP534.....	D17
STP193.....	D6	STP372.....	D11	STP469C.....	D8, D22	STP536.....	D17
STP194.....	D6	STP373.....	D11	STP470.....	D8, D22	STP550.....	D10, D22
STP195.....	D9	STP374.....	D11	STP470C.....	D8, D22	STP551.....	D10, D22
STP196.....	D10	STP375.....	D11	STP471.....	D8, D22	STP551C.....	D10, D22
STP196D.....	D10	STP376.....	D11	STP471C.....	D8, D22	STP552.....	D10, D22
STP197.....	D10	STP377.....	D11	STP472.....	D9, D22	STP552C.....	D10, D22
STP197D.....	D10	STP378.....	D11	STP473.....	D9, D22	STP552D.....	D10, D22
STP198.....	D10	STP379.....	D11	STP474.....	D9, D22	STP553.....	D10, D22
STP198C.....	D10	STP380.....	D11	STP475.....	D3, D20	STP553C.....	D10, D22
STP198D.....	D10	STP381.....	D13	STP476.....	D3, D20	STP553D.....	D10, D22
STP199.....	D9	STP382.....	D14	STP477.....	D4, D20	STP556.....	D3, D22
STP200.....	D13	STP383.....	D14	STP478.....	D4, D20	STP559.....	D4, D22
STP201.....	D13	STP384.....	D11	STP479.....	D5, D21	STP560.....	D4, D22
STP202.....	D13	STP385.....	D11	STP480.....	D7	STP561.....	D4, D22
STP203.....	D13	STP386.....	D11	STP481.....	D7	STP562.....	D5, D22
STP204.....	D10	STP387.....	D11	STP482.....	D8	STP563.....	D5, D22
STP205.....	D10	STP388.....	D6	STP483.....	D8	STP564.....	D5, D22
STP206.....	D10	STP389.....	D6	STP484.....	D7	STP565.....	D5, D22
STP207.....	D9	STP390.....	D6	STP485.....	D8	STP570.....	D8, D22
STP208.....	D7	STP391.....	D6	STP486.....	D6	STP571.....	D8, D22
STP208H.....	D7, D19	STP392.....	D6	STP487.....	D8	STP572.....	D9, D22
STP210.....	D13	STP393.....	D6	STP488.....	D8	STP573.....	D9, D22
STP210D.....	D13	STP394.....	D7	STP489.....	D8	STP576.....	D7, D22
STP211.....	D13	STP395.....	D8	STP490.....	D8	STP577.....	D7, D22
STP212.....	D13	STP396.....	D8	STP491.....	D7	STP578.....	D7, D22
STP213.....	D15	STP397.....	D14	STP492.....	D7	STP600.....	D7
STP300.....	D6	STP398.....	D14	STP493.....	D4	STP601.....	D7
STP301.....	D6	STP400.....	D11	STP494.....	D4	STP602.....	D4
STP302.....	D3	STP401.....	D11	STP495.....	D4	STP606.....	D3
STP350.....	D10	STP402.....	D11	STP496.....	D4	STP606H.....	D3, D19
STP350H.....	D10, D20	STP430.....	D8	STP497.....	D3	STT250.....	C12
STP351.....	D10, D21	STP431.....	D8	STP497H.....	D3, D19	STT250C.....	C12
STP351C.....	D10, D21	STP432.....	D8	STP498.....	D3	STT250M.....	C12
STP352.....	D10, D21	STP433.....	D8	STP498D.....	D3	STT251.....	C12
STP352C.....	D10, D21	STP434.....	D13	STP498H.....	D4, D19	STT251C.....	C12
STP353.....	D10, D21	STP435.....	D10	STP499H.....	D7, D19	STT251D.....	C12
STP353C.....	D10, D21	STP436.....	D10	STP500H.....	D7, D19	STT252.....	C12
STP354.....	D3, D20	STP437.....	D10	STP501.....	D17	STT252C.....	C12

INDEX

STT252M.....	C12	SWR1.....	C3	TC420.....	E3	TC486.....	E5
STT253.....	C12	TC1.....	B34, E17, E29	TC420A.....	E3	TC487.....	E5
STT253C.....	C12	TC5.....	E30	TC421.....	E3	TC488.....	E5
STT253M.....	C12	TC6.....	E30	TC421A.....	E3	TC489.....	E5
STT254.....	C12	TC7.....	E30	TC422.....	E3	TC490.....	E5
STT255.....	C12	TC7T.....	E17, E29	TC422A.....	E3	TC492.....	E5
STT256.....	C12	TC8.....	E30	TC423.....	E11	TC494.....	E5
STT256E.....	C13	TC8T.....	E17	TC424.....	E11	TC495.....	E5
STT256M.....	C12	TC9.....	E30	TC427.....	E15	TC496.....	E5
STT256R.....	C13	TC10.....	E8	TC428.....	E14	TC497.....	E12
STT256W.....	C13	TC11.....	E8	TC430.....	E15	TC498.....	E5
STT256Y.....	C13	TC12.....	E30	TC431.....	E3	TC499.....	E5
STT259.....	C12	TC20.....	E16	TC431A.....	E3	TC499A.....	E5
STT260.....	B37	TC23.....	E14	TC432.....	E14	TC500.....	E5
STT261.....	B37	TC23P.....	E14	TC433.....	E11	TC501.....	E5
STT262.....	B37	TC30.....	E15	TC434.....	E14	TC502.....	E6
STT263.....	B37	TC41.....	E9	TC436.....	E3	TC503.....	E6
STT263R.....	B37	TC41S.....	E9	TC436A.....	E3	TC504.....	E6
STT264.....	B37	TC42.....	E16	TC437.....	E3	TC505.....	E6
STT264R.....	B37	TC44.....	E9	TC438.....	E3	TC506.....	E6
STT265.....	B37	TC44A.....	E11	TC439.....	E3	TC507.....	E13
STT265R.....	B37	TC44K.....	E9	TC441.....	E3	TC508.....	E13
STT270.....	C12	TC45.....	E15	TC441A.....	E3	TC509.....	E17
STT271.....	C12	TC45H.....	E15	TC451.....	E4	TC510.....	E6
STT271C.....	C12	TC46.....	E15	TC451A.....	E4	TC511.....	E6
STT271E.....	C13	TC48.....	E15	TC452.....	E14	TC512.....	E6
STT271M.....	C12	TC50.....	E16	TC453.....	E14	TC513.....	E6
STT271R.....	C13	TC51.....	E9	TC454.....	E14	TC515.....	E6
STT271W.....	C13	TC51A.....	E11	TC455.....	E17	TC516.....	E6
STT271Y.....	C13	TC51K.....	E9	TC456.....	E11	TC517.....	E6
STT272.....	C12	TC52.....	E14	TC457.....	E11	TC518.....	E6
STT272C.....	C12	TC61.....	E9	TC458.....	E11	TC519.....	E6
STT272D.....	C12	TC61A.....	E11	TC459.....	E12	TC520.....	E6
STT273.....	C12	TC61S.....	E9	TC460.....	E4	TC521.....	E6
STT273C.....	C12	TC62.....	E16	TC461.....	E4	TC522.....	E6
STT273M.....	C12	TC62K.....	E9	TC462.....	E4	TC523.....	E6
STT274.....	C12	TC63.....	E11	TC462A.....	E4	TC524.....	E7
STT274C.....	C12	TC65.....	E12	TC463.....	E4	TC525.....	E7
STT275.....	C12	TC72.....	E11	TC464.....	E4	TC526.....	E13
STT275C.....	C12	TC73.....	E11	TC466.....	E14	TC527.....	E13
STT275M.....	C12	TC75.....	E12	TC468.....	E17	TC528.....	E14
STT276.....	C12	TC76.....	E12	TC469.....	E4	TC529.....	E16
STT276C.....	C12	TC91.....	E10	TC469A.....	E4	TC530.....	E16
STT276M.....	C12	TC411.....	E3	TC470.....	E4	TC531.....	E16
STT277.....	C12	TC412.....	E3	TC472.....	E4	TC532.....	E16
STT277C.....	C12	TC412A.....	E3	TC473.....	E4	TC533.....	E16
STT277M.....	C12	TC413.....	E3	TC474.....	E4	TC534.....	E12
STT278.....	C12	TC413A.....	E3	TC475.....	E4	TC535.....	E12
STT278C.....	C12	TC414.....	E3	TC476.....	E4	TC536.....	E7
STT278D.....	C12	TC414A.....	E3	TC477.....	E4	TC537.....	E7
STT279.....	C12	TC416.....	E3	TC478.....	E5	TC538.....	E7
STT281C.....	C12	TC416A.....	E3	TC479.....	E5	TC539.....	E7
STT281M.....	C12	TC418.....	E3	TC481.....	E15	TC540.....	E7
STT282.....	C12	TC418A.....	E3	TC482.....	E5	TC541.....	E12
STT282C.....	C12	TC419.....	E3	TC483.....	E5	TC542.....	E7
SW4.....	B31	TC419A.....	E3	TC485.....	E5	TC543.....	E7



TC544	E7	TN20	A16	WTT20	B38
TC545	E7	TN21	A16	WTT21	B38
TC546	E7	TN22	A16	WTT22	B38
TC547	E7	TN23	A16	WTT27	A27, D35
TC548	E7	TN24	A16	WTT28	B38
TC549	E7	TN25	A16	WTT29	B38
TC550	E14	TN26	A16	WTT30	B35
TC551	E7	TN27	A16	WTT31	B38
TC552	E16	TN28	A16	WTT32	D35
TC553	E13	TX3A	F17	WTT33	B35
TC554	E7	WC0L	B23	WTT38	A24, D35
TC555	E8	WC0RL	B23	WTT39	A24, D35
TC556	E8, E12	WC0RV	B23	WTT110	D35
TC558	E8	WC0V	B23	WTT111	D35
TC559	E8	WC1L	B23	WTT112	D35
TC560	E8	WC1RL	B23	WTT113	D35
TC561	E8	WC1RV	B23	WTT114	D35
TC562	E12	WC1V	B23	WTT115	D35
TC563	E12	WC2L	B23	ZM80	G8
TC564	E12	WC2RL	B23	ZM81	G8
TC565	E12	WC2RV	B23	ZM82	G8
TC568	E12	WC2V	B23	ZM85	G8
TC569	E12	WC4L	B23	ZM86	G8
TC600	E13	WC4RL	B23	ZM87	G8
TC701K	E10	WC4RV	B23	ZR91	G8
TCP45C	E17	WC4V	B23	ZR92	G8
TCP62C	E17	WC00L	B23	ZR95	G6
TCP62F	E9	WC00RL	B23	ZR96	G6
TCP77B	E17	WC00RV	B23	ZR97	G8
TCP77F	E10	WC00V	B23	ZT11	G6
TCP77F-15	E10	WCB0	B23	ZT17	G6
TCP77F-20	E10	WCB0R	B23	ZT21	G6
TCP77F-30	E10	WCB1	B23	ZT22	G6
TCP77M	E10	WCB1R	B23	ZT23	G6
TCP77PF	E10	WCB2	B23	ZT31	G6
TCP77PG	E10	WCB2R	B23	ZT31A	G6
TCP77PM	E10	WCB4	B23	ZT32	G6
TCP78C	E17	WCB4R	B23	ZT34	G6
TCP78F	E10	WCB00	B23	ZT34A	G6
TCP78M	E10	WCB00R	B23	ZT37	G6
TCP701F	E10	WTA175	D31	ZT54	G8
TCP701M	E10	WTA208	D31	ZX50	G8
TCP713F	E11	WTT4	A24, D35	ZX51	G8
TCP713M	E11	WTT5	A24	ZX52	G8
TN7	A17	WTT6	A24	ZX53	G8
TN7E	A17	WTT7	B35		
TN8E	A16	WTT8	B35		
TN9	A17	WTT10	B35		
TN9E	A17	WTT11	B35		
TN10	A16	WTT12	D35		
TN11	A17	WTT13	D35		
TN15	A17	WTT14	D35		
TN16	A17	WTT15	D35		
TN17	A16	WTT16	B35		
TN18	A17	WTT17	A24, D35		
TN19	A16	WTT18	A24, D35		

IT'S TIME TO SHAKE UP YOUR HEAT SHRINK TERMINAL SALES WITH GRAB & GO JARS!

Benefits & Uses of Grab & Go Jars

- Designed for **Most Popular Connectors**
- Ideal for **High and Low Volume Users**
- **Attractive Packaging** for Organization while Providing a **Visual Stock Level**
- **Great for Service Trucks and Satellite Shops**
- Larger Quantity = **Bigger Sales**



Sealed Crimp Connectors



Part #	Qty	Gauge
ET130HJ	100	20-18
ET131HJ	100	16-14
ET132HJ	60	12-10



Sealed Solder Connectors



Part #	Qty	Gauge
ET351J	100	20-18
ET352J	100	16-14
ET353J	60	12-10



Sealed Crimp & Solder Connectors



Part #	Qty	Gauge
ET551J	100	20-18
ET552J	100	16-14
ET553J	60	12-10



Sealed Window Butt Connectors



Part #	Qty	Gauge
ET700J	100	20-18
ET701J	100	16-14
ET702J	60	12-10

2.75"

4.5"