

# FUEL SYSTEM

## SERVICE INSTRUCTION WORKSHEET

### TO REPAIR

ROCHESTER CARBURETOR

2 BARREL--- Models 2G, 2GC, 2GV

- Carefully read the text in the following pages to become familiar with the contents of this worksheet before performing carburetor overhaul.
- The exploded view shown is typical of the model carburetor this kit will service. The view may differ slightly from the actual carburetor being overhauled.

- Use the exploded view as a guide. The numerical sequence may generally be followed to disassemble the carburetor far enough to permit cleaning and inspection.
- Parts list shown DOES NOT reflect the contents of the kit.
- Kit may contain extra parts intended for other carburetors within this group. Substitute identical replacement parts for original worn parts found in carburetor.

☞ PARTS LIST SHOWN DOES NOT REFLECT THE CONTENTS OF THE KIT.

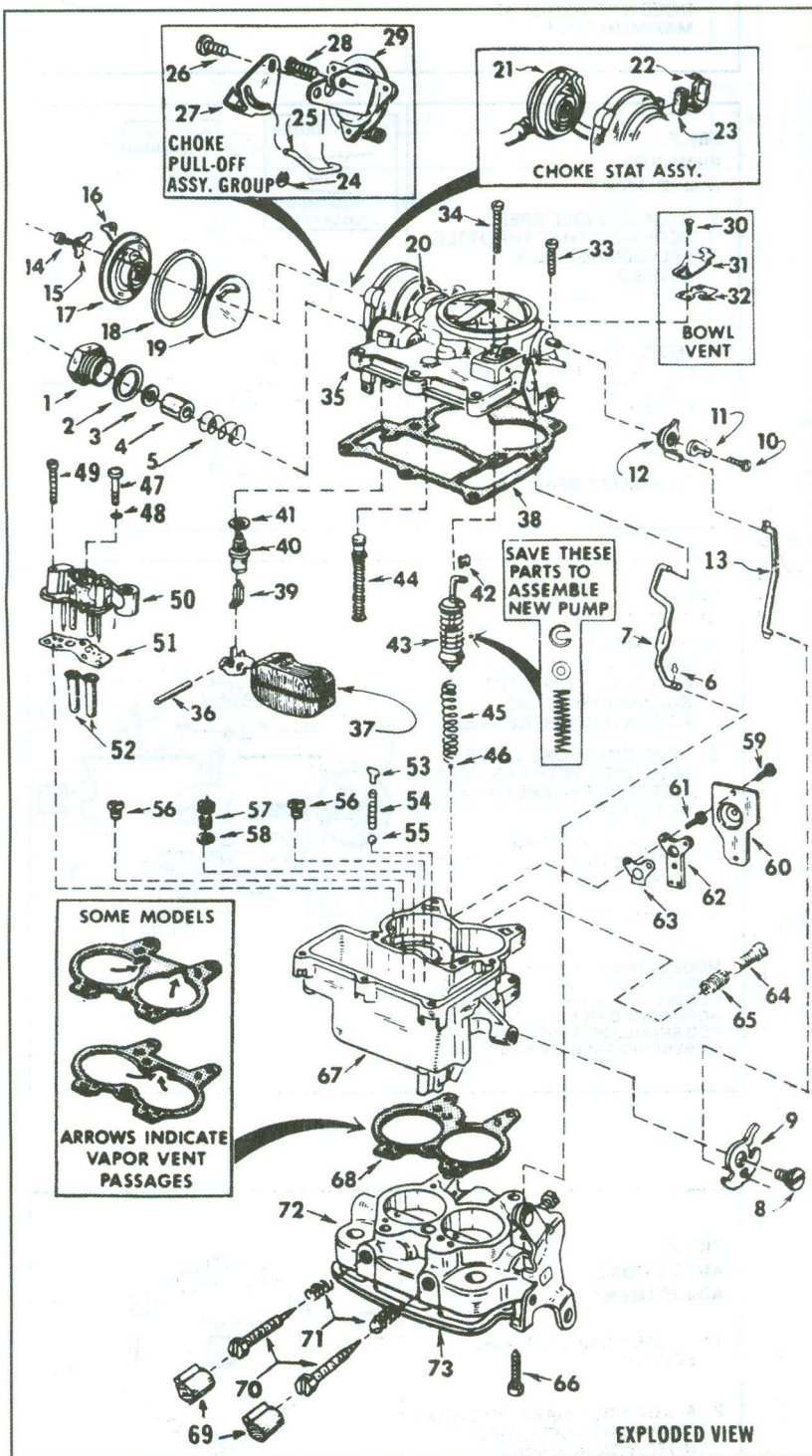

#### DISASSEMBLY - ASSEMBLY HIGHLIGHTS

- UPON DISASSEMBLY, MARK LOCATION & NOTE POSITION OF ALL SPRINGS WHICH HAVE TO BE REMOVED.
- RETAIN ALL OLD GASKETS FOR MACHING PURPOSES.
- SOME MODELS: REMOVE LIMITER CAPS (69) BY TURNING IN #8 SHEET METAL SCREW IN CENTER OF CROSS SLOTS FORCING LIMITER CAPS OFF.
- WHEN REMOVING MIXTURE SCREWS (70) MARK POSITION, TURN IN UNTIL LIGHTLY SEATED, COUNTING NUMBER OF TURNS, TURN OUT TO INDEX MARK, RECORD NUMBER OF TURNS FOR RE-ASSEMBLY AND THEN REMOVE. IF MIXTURE SCREWS WERE REMOVED WITHOUT INDEXING, TURN IN UNTIL LIGHTLY SEATED, TURN OUT TWO TURNS.
- COVER OPENING ON INTAKE MANIFOLD AFTER CARBURETOR IS REMOVED.
- TO PREVENT LOSS OF COOLANT, DO NOT DISCONNECT HOSE FROM CHOKE STAT (21).
- INSTALL CHOKE HOUSING SEAL (20) WITH LIP FACING OUTWARD.
- LIGHTLY LUBRICATE PISTON ASSEMBLY CUP (43) BEFORE INSTALLING.
- DO NOT ALLOW VITON NEEDLE (39) TO BE PRESSED INTO SEAT (40).
- CHECK THROTTLE LINKAGE FOR FREEDOM OF MOVEMENT BEFORE & AFTER INSTALLATION OF CARBURETOR ON ENGINE.
- WHEN RE-INSTALLING POWER VALVE PISTON (44) IN AIR HORN ASSEMBLY (35), LIGHTLY STAKE UNIT IN PLACE.
- TURN IN IDLE AIR SCREW (64, WHERE USED) UNTIL SEATED THEN TURN OUT 2 TURNS.

#### CLEANING

Cleaning must be done with carburetor disassembled. Use spray cleaner and a stiff bristle brush to remove dirt and carbon deposits. Do not use abrasives and wires to clean parts and passageways. Wash off in suitable solvent, and clear all passageways with compressed air.

**Caution:** When cleaning with solvent do not soak or spray parts containing rubber, leather, plastic and electrical components.

#### PARTS LIST

- |  |  |
|--|--|
| 1. Adapter, Fuel Inlet                 | 39. Needle, Fuel Inlet                                       |
| 2. Gasket, Adapter                     | 40. Seat, Fuel Inlet   |
| 3. Gasket, Fuel Filter                 | 41. Gasket, Seal   |
| 4. Filter, Fuel Inlet                  | 42. Clip, Pump Piston  |
| 5. Spring, Override, Filter            | 43. Piston Assembly, Pump                                    |
| 6. Clip, Pump Rod Lower                | 44. Piston Assembly, Power Valve                             |
| 7. Rod, Pump Piston                    | 45. Spring, Piston Return                                    |
| 8. Screw, Fast Idle Cam                | 46. Ball Check, Pump Intake (small)                          |
| 9. Cam, Fast Idle                      | 47. Screw, Center, Venturi Assy.                             |
| 10. Screw, Lever, Trip                 | 48. Gasket, Center Screw                                     |
| 11. Lever, Trip                        | 49. Screw, Mounting, Venturi Assembly                        |
| 12. Lever, Engaging Choke              | 50. Venturi Assembly   |
| 13. Rod, Connecting, Choke             | 51. Gasket, Venturi  |
| 14. Screw, Retainer, Choke Cover       | 52. Tube, Main Well (2)                                      |
| 15. Retainer, Serrated, Choke Cover    | 53. Retainer, Spring, Pump Discharge                         |
| 16. Retainer, Choke Cover              | 54. Spring, Pump Discharge Ball                              |
| 17. Cover, Choke Stat Assembly         | 55. Ball Check, Pump Discharge (Large)                       |
| 18. Gasket, Choke Cover                | 56. Jet, Main (2)  |
| 19. Deflector, Heat, Choke Cover       | 57. Power Valve  |
| 20. Seal, Choke Housing (Not Shown)    | 58. Gasket, Power Valve                                      |
| 21. Choke Stat Cover Assembly #        | 59. Screw, Hot Idle Compensator Cover                        |
| 22. Holder, Filter #                   | 60. Cover, Hot Idle Compensator                              |
| 23. Filter, Intake Air #               | 61. Screw, Bi-Metallic Valve                                 |
| 24. "E" Clip, Choke Pull-Off Link #    | 62. Bi-Metallic Valve, Hot Idle Compensator                  |
| 25. Link, Choke Pull-Off #             | 63. Gasket, Bi-Metallic Valve                                |
| 26. Screw, Choke Shaft Slotted Lever # | 64. Screw, Idle Air Adjusting (By-Pass Idle System)          |
| 27. Lever, Choke Shaft Slotted #       | 65. Spring, Idle Air Adjusting Screw                         |
| 28. Screw, Choke Pull-Off Mounting #   | 66. Screw, Throttle Body to Main Body                        |
| 29. Choke Pull-Off Assembly #          | 67. Main Body  |
| 30. Screw, Vent Valve Cover #          | 68. Gasket, Throttle Body to Main Body (Match up old Gasket) |
| 31. Cover, Vent Valve #                | 69. Cap, Limiter #   |
| 32. Valve, Vent #                      | 70. Screw, Idle Mixture                                      |
| 33. Screw, Air Horn Mounting (Short)   | 71. Spring, Idle Mixture Screw                               |
| 34. Screw, Air Horn Mounting (Long)    | 72. Throttle Body Assembly                                   |
| 35. Air Horn Assembly                  | 73. Gasket, Flange   |
| 36. Rod, Float Hinge                   |  |
| 37. Float Assembly                     |  |
| 38. Gasket, Air Horn                   |  |

# ADJUSTMENT DATA

**FIG. A  
FLOAT LEVEL  
ADJUSTMENT**

1. WITH GASKET IN PLACE, INVERT AIR HORN
2. GAUGE AS SPECIFIED FROM AIR HORN GASKET TO TOP OF FLOAT (NOT ON SEAM)
3. BEND HERE TO ADJUST FLOAT LEVEL

NOTE 1: TO AVOID DAMAGING FLOAT NEEDLE, DO NOT PRESS NEEDLE INTO SEAT.

NOTE 2: CHECK FLOAT FOR CORRECT ALIGNMENT.

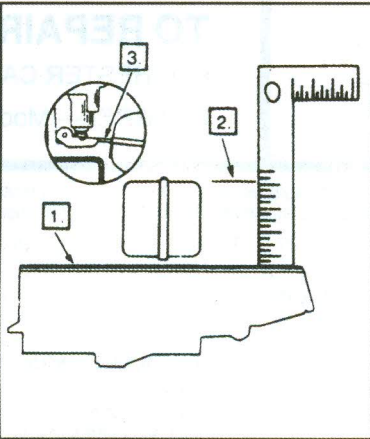

**FIG. E  
FLOAT DROP  
ADJUSTMENT**

1. POSITION AIR HORN UP RIGHT TO ALLOW FLOAT TO HANG FREE. GASKET MUST BE IN PLACE
2. MEASURE SPECIFIED DISTANCE FROM NOTCH AT FLOAT TO GASKET SURFACE
3. BEND TANG TO ADJUST FLOAT DROP

NOTE: BE SURE NEEDLE DOES NOT WEDGE AT MAXIMUM DROP

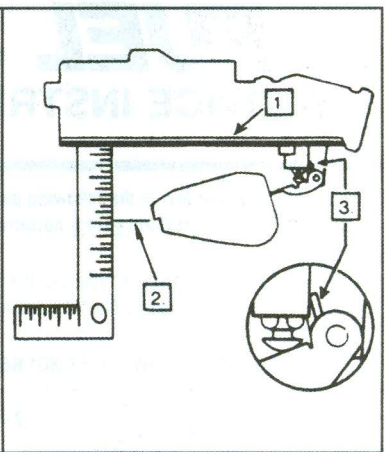

**FIG. B  
FLOAT LEVEL  
ADJUSTMENT**

1. INVERT AIR HORN WITH GASKET IN PLACE
2. MEASURE SPECIFIED DISTANCE OPPOSITE HINGE END FROM OUTWARD BOTTOM EDGE OF SEAM TO AIR HORN GASKET.
3. BEND HERE TO ADJUST FLOAT LEVEL

NOTE 1: TO AVOID DAMAGING FLOAT NEEDLE, DO NOT PRESS NEEDLE INTO SEAT.  
NOTE 2: CHECK FLOAT FOR CORRECT ALIGNMENT.

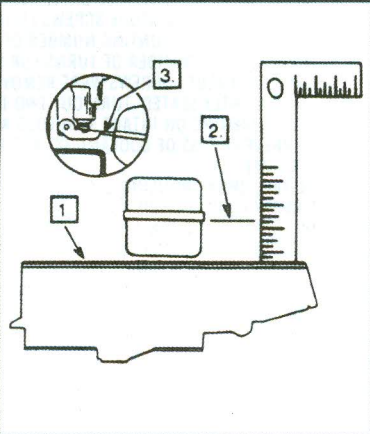

**FIG. F  
PUMP ROD  
ADJUSTMENT**

1. BACK OUT IDLE SPEED SCREW SO THAT THROTTLE VALVES ARE FULLY CLOSED
2. MEASURE SPECIFIED DISTANCE FROM TOP OF PUMP ROD TO TOP OF AIR HORN RING
3. TO ADJUST, BEND ROD

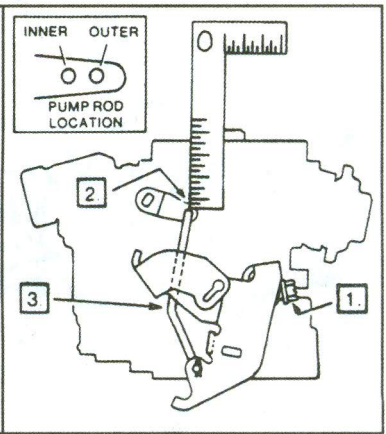

**FIG. C  
FLOAT LEVEL  
ADJUSTMENT**

1. INVERT AIR HORN & POSITION GASKET ON PARTING SURFACE
2. MEASURE AS SPECIFIED FROM AIR HORN GASKET TO NOTCH AT FLOAT AS SHOWN
3. BEND HERE TO ADJUST FLOAT LEVEL

NOTE: TO AVOID DAMAGING FLOAT NEEDLE, DO NOT PRESS NEEDLE INTO SEAT.

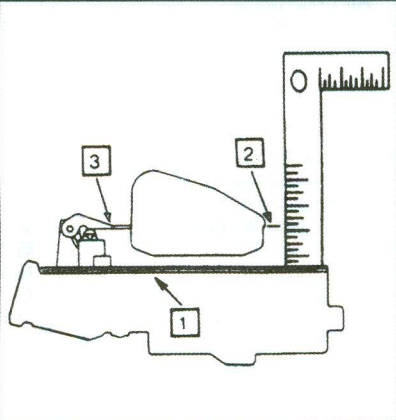

**FIG. G  
IDLE VENT  
ADJUSTMENT**

1. ADJUST IDLE TO SPECIFIED RPM. NOTE: IDLE STOP SOLENOID MUST BE ACTIVATED (WHERE USED)
2. POSITION CHOKE VALVE WIDE OPEN WITH FAST IDLE SCREW OFF STEPS OF FAST IDLE CAM
3. GAUGE AS SPECIFIED BETWEEN VALVE & SEAT AT WIDEST POINT
4. TO ADJUST, BEND TANG

MODELS PRIOR TO 1968 - OPEN THROTTLE UNTIL VENT VALVE JUST CLOSES. PLACE GAUGE ON TOP OF AIR HORN RING. DIMENSION TO TOP OF PUMP ROD SHOULD BE AS SPECIFIED. ADJUST BY BENDING TANG ON PUMP LEVER.

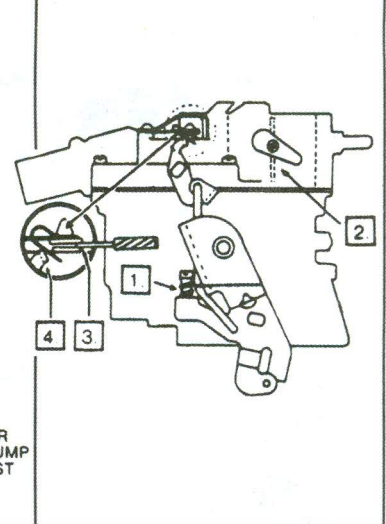

**FIG. D  
FLOAT DROP  
ADJUSTMENT**

1. POSITION AIR HORN UP RIGHT TO ALLOW FLOAT TO HANG FREE. GASKET MUST BE IN PLACE
2. MEASURE SPECIFIED DISTANCE FROM BOTTOM OF FLOAT TO GASKET SURFACE
3. TO ADJUST, BEND FLOAT TANG

NOTE: BE SURE NEEDLE DOES NOT WEDGE AT MAXIMUM DROP

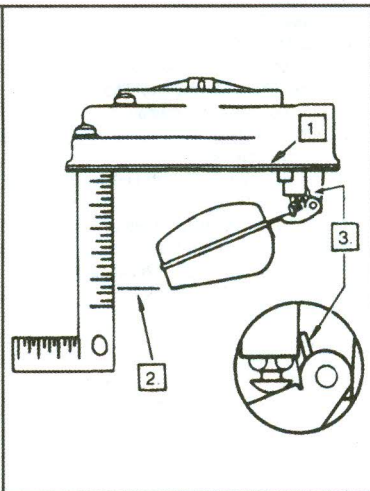

**FIG. H  
AUTO CHOKE  
ADJUSTMENT**

1. LOOSEN 3 HOLD-DOWN SCREWS
2. ALIGN INDEX MARK ON CHOKE COVER WITH SPECIFIED NOTCH ON HOUSING

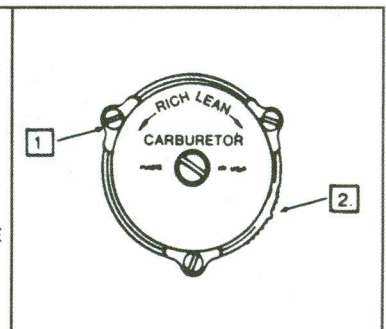

**FIG. I  
CHOKE COIL  
ROD ADJUSTMENTS**

1. FROM CHOKE LEVER, REMOVE UPPER END OF ROD & HOLD CHOKE VALVE FULLY CLOSED
2. LIFT UPWARD ON ROD AGAINST STOP.
3. END OF ROD SHOULD FIT GAUGE NOTCH.
4. BOTTOM OF ROD EVEN WITH TOP OF HOLE.
5. TO ADJUST, BEND ROD.

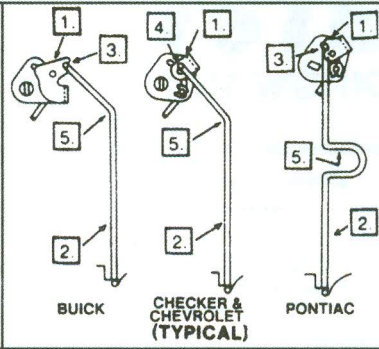

**FIG. L  
VACUUM BREAK  
ADJUSTMENT**

1. USING OUTSIDE VACUUM SOURCE SEAT DIAPHRAGM PLUNGER
2. POSITION CHOKE VALVE CLOSED WITH ROD IN BOTTOM OF SLOT
3. MEASURE AS SPECIFIED BETWEEN UPPER EDGE OF CHOKE VALVE AND WALL OF AIR HORN
4. TO ADJUST, BEND ROD

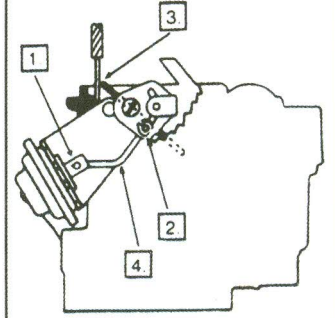

**FIG. J  
CHOKE ROD (FAST IDLE CAM)  
ADJUSTMENT**

IMPORTANT: BEFORE MAKING ADJUSTMENTS 1-2-3 READ NOTE AND PARAGRAPHS "PROCEDURE 1" AND "PROCEDURE 2" BELOW.

1. PLACE LOW IDLE SPEED SCREW ON 2ND STEP OF FAST IDLE CAM AGAINST SHOULDER OF HIGH STEP.
2. MEASURE AS SPECIFIED BETWEEN UPPER EDGE OF CHOKE VALVE AND WALL OF AIR HORN.
3. TO ADJUST, BEND TANG AS NECESSARY (SEE INSERT I OR II).

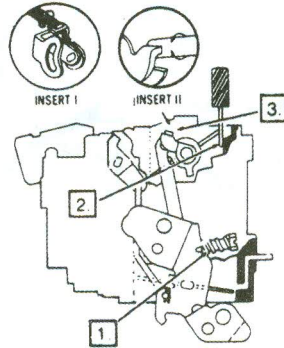

THEN TURN THIS SCREW IN ONE FULL TURN FROM THIS POINT. NEXT, TURN THE FAST IDLE SCREW IN UNTIL IT TOUCHES BOTTOM STEP OF FAST IDLE CAM.

PROCEDURE 2 - ALL MODELS- POSITION FAST IDLE SCREW ON SECOND STEP OF FAST IDLE CAM AGAINST SHOULDER OF HIGH STEP. WHILE HOLDING SCREW IN THIS POSITION, CHECK CLEARANCE BETWEEN UPPER EDGE OF CHOKE VALVE AND WALL OF AIR HORN. ADJUST TO SPECIFIED DIMENSION BY BENDING TANG ON CHOKE LEVER AND COLLAR ASSEMBLY.

**FIG. M  
CHOKE UNLOADER  
ADJUSTMENT**

1. MAINTAIN THROTTLE VALVES IN WIDE OPEN POSITION
2. GAUGE AS SPECIFIED BETWEEN WALL OF AIR HORN AND UPPER EDGE OF CHOKE VALVE
3. TO ADJUST, BEND TANG (See Insert I). NOTE: ON SPLIT LINKAGE MODEL 2GC, BEND TANG ON DECHOKE LEVER ON CHOKE SIDE OF CARBURETOR (See Insert II).

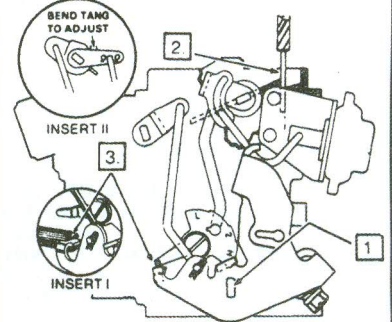

**FIG. K  
CHOKE ROD ADJUSTMENT  
(SPLIT CHOKE)**

NOTE: ADJUST SLOW & FAST IDLE SCREWS AS PER PROCEDURE 1, FIG. J

1. LOCATE FAST IDLE SCREW ON SECOND STEP OF FAST IDLE CAM AGAINST HIGH STEP
2. ROTATE LEVER COUNTERCLOCKWISE SO RODS ARE IN END OF SLOTS
3. MEASURE AS SPECIFIED BETWEEN WALL OF AIR HORN AND UPPER EDGE OF CHOKE VALVE.
4. TO ADJUST, BEND ROD

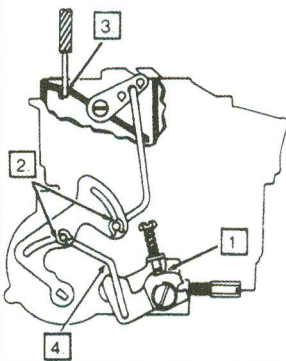

**SPECIFICATION BY APPLICATION**

Year	Application	Float Level		Float Drop		Pump Rod Fig. F	Idle Vent Fig. G	Auto Choke	Choke Rod Fig. J	Vac. Break Primary Fig. L	Unloader Fig. M
		Fig.	Fig.	Fig.	Fig.						

**CHECKER — SPECIFICATION I.D.-A**

1968-67	283, 307, 327 Eng.	3/4	C	1-3/4	E	1-1/8	.025	2	I	.060	.100 <sup>1</sup>	.200
1962	283 Eng.	3/4	B	1-3/4	D	1-1/8	1	2	I	.060	.090	.200

**CHEVROLET**

1969	307 Eng.	27/32	B	1-3/4	D	1-1/8	.020	2	I	.060	.100	.215
1968	307, 327 Eng.	3/4	B	1-3/4	D	1-1/8	.025	2	I	.060	.100	.200
1967	283, 327 Eng.	3/4	C	1-3/4	E	1-1/8	1	2	I	.060	.110 <sup>3</sup>	.200
1966-64	283 Eng.	3/4	B	1-3/4	D	1-1/8	1	2	I	.070	.090	.200
	Carb. No. 7024100, 102, 106, 108	3/4	B	1-3/4	D	1-1/8	1	2	I	.060	.110 <sup>3</sup>	.200
	Carb. No. 7036110, 112; 7024101, 110, 112	3/4	B	1-3/4	D	1-1/8	1	2	I	.060	.130	.200
	Carb. No. 7036101, 103	3/4	B	1-3/4	D	1-1/8	1	2	I	.060	—	.360
1963-62	283 Eng.	3/4	B	1-29/32	D	1-1/8	1	Index <sup>4</sup>	H	.090	—	.350
	Carb. No. 7023007, 008, 018 Carb. No. 7020007, 008, 018	1-11/32	A	1-29/32	D	1-1/8	1	Index <sup>4</sup>	H	.090	—	.375
1961-56	265, 283 Eng. Exc.	1-1/4	A	1-29/32	D	1-1/8	—	Index	H	.090	—	.375
	Carb. No. 7013652; 7012133, 451, 452, 500	1-9/32	A	1-29/32	D	1-1/8	1	Index	H	.090	—	.375
	Carb. No. 7019007, 008, 018; 7013007, 008, 018, 082	1-11/32	A	1-29/32	D	1-1/8	1	Index <sup>4</sup>	H	.090	—	.375

**CHRIS-CRAFT**

	283 Eng.	1-3/8	A	1-29/32	D	29/32	—	1NL	H	.090	—	.350
--	----------	-------	---	---------	---	-------	---	-----	---	------	---	------

**GM TRUCKS**

1969-56	265, 283, 307 Eng. Exc.	3/4	B	1-29/32	D	1-1/8	5	—	—	—	—	—
	Carb. No. 17054657, 7028100, 105, 106, 107, 111; 7027100, 105, 106	3/4	B	1-3/4	D	1-1/8	—	—	—	—	—	—
	Carb. No. 7029105	27/32	B	1-3/4	D	1-1/8	—	2	I	.095	.130	.215
	Carb. No. 17054656; 7028125, 127	3/4	B	1-3/4	D	1-5/32	.020	—	—	—	—	—
	Carb. No. 7012453, 455	1-5/16	A	1-29/32	D	1-5/32	1	—	—	—	—	—
	Carb. No. 7011132, 135; 7010649; 716, 718; 7008383, 389, 706	1-1/4	A	1-29/32	D	1-5/32	—	—	—	—	—	—

**STUDEBAKER**

1965	283 Eng.	3/4	B	1-3/4	D	1-1/8	1	2	I	.060	.120 <sup>1</sup>	.200
------	----------	-----	---	-------	---	-------	---	---	---	------	-------------------	------

**CADILLAC — SPECIFICATION I.D.-B**

1958	365 Eng. -Front & Rear Carb.	23/32	B	1-29/32	D	1-3/16	—	—	—	—	—	—
------	------------------------------	-------	---	---------	---	--------	---	---	---	---	---	---

**CHECKER**

1965	327 Eng. -Front & Rear Carb.	3/4	B	1-29/32	D	1-1/8	—	—	—	—	—	—
------	------------------------------	-----	---	---------	---	-------	---	---	---	---	---	---

**CHEVROLET**

1961-58	265, 348 Eng. -Front & Rear Carb.	1-5/16 <sup>6</sup>	A	1-29/32	D	1-3/16	—	—	—	—	—	—
	-Center Carb.	1-5/16 <sup>7</sup>	A	1-29/32	D	1-3/16	—	Index	H	.090	—	.375
1955	265 Eng.	1-5/32	A	1-29/32	D	1-3/16	—	Index	H	.090	—	.375

**GM TRUCKS**

1968-56	Carb. No. 7008393, 394; 7010717; 7011143, 155	1-1/4	A	1-29/32	D	1-5/32	—	—	—	—	—	—
	Carb. No. 7012233, 457	1-5/16	A	1-29/32	D	1-5/32	1	—	—	—	—	—
	Carb. No. 7013013, 353; 7015019; 7020109; 7023027	3/4	B	1-29/32	D	1-1/8	1	—	—	—	—	—
1955	Carb. No. 7006770; 7007171; 7008399	1-5/32	A	1-29/32	D	1-3/16	—	—	—	—	—	—

**OLDSMOBILE**

1958-57	Front & Rear Carb.	1-3/8	A	1-29/32	D	1-3/16	—	—	—	—	—	—
---------	--------------------	-------	---	---------	---	--------	---	---	---	---	---	---

**PONTIAC**

1966-57	389, 421 Eng.	23/32 <sup>8</sup>	B	1-3/4	D	1-1/8	1-1/32 <sup>9</sup>	Index	H	.055	—	.160
	Center Carb. Exc. Carb. No. 7011350, 500, 706, 709	1-9/32 <sup>10</sup>	A	1-29/32	D	1-1/8	—	Index	H	.060	—	.160
1958-57	347, 370 Eng. Front & Rear Carb.	1-13/32 <sup>10</sup>	A	1-29/32	D	1-3/16	—	—	—	—	—	—

**WHITE**

1967	327 Eng.	3/4	C	1-29/32	E	1-1/8	—	—	—	—	—	—
------	----------	-----	---	---------	---	-------	---	---	---	---	---	---

**BUICK — SPECIFICATION I.D.-C**

1964	300 Eng. -A/T	1/2	B	1-29/32	D	1-11/32 <sup>11</sup>	—	2NR	H	.040	—	.085
	-M/T	1/2	B	1-29/32	D	1-11/32 <sup>11</sup>	—	Index	H	.040	—	.085

**OLDSMOBILE**

1964	330 Eng.	11/16 <sup>12</sup>	B	1-13/16	D	1-3/32	1	1NL	H	.080	—	.260
------	----------	---------------------	---	---------	---	--------	---	-----	---	------	---	------

**AMC, JEEP — SPECIFICATION I.D.-D**

1967-66	225 Eng. -Cal.	1/2	B	1-9/32	D	1-1/16	31/32	Index	H	.055	—	.140
	Carb. No. 7027041 Carb. No. 7036144	1/2	B	1-27/32	D	1-1/16 <sup>13</sup>	31/32	Index	H	.055	—	.140

**SPECIFICATIONS BY APPLICATION (Cont'd)**

Year	Application	Float Level	Fig.	Float Drop	Fig.	Pump Rod	Fig. F	Idle Vent	Fig. G	Auto Choke	Fig.	Choke Rod	Fig. J	Vac. Break Primary	Fig. L	Unloader	Fig. M
<b>BUICK — SPECIFICATION I.D.-D</b>																	
1969-66	300, 340, 350 Eng.	15/32	C	1-9/32	E	1-5/32 <sup>13</sup>	—	1-1/16	—	Index	H	.055	—	—	—	.140	
	Carb. No. 7026146; 7036146, 248	15/32	C	1-9/32	E	1-5/32	—	31/32	—	Index	H	.055	—	—	—	.140	
	Carb. No. 7027044, 45, 46, 49; 7037034	15/32	C	1-9/32	E	1-11/32	.025	—	—	Index	J	.050	.120	—	—	.140	
	Carb. No. 7028140, 141	15/32	C	1-7/32	E	1-11/32 <sup>15</sup>	.020	—	—	Index	J	.050	.110	—	—	.140	
	Carb. No. 7029140, 141	1/2	B	1-27/32	D	1-5/32 <sup>13</sup>	—	—	—	Index	H	.055	—	—	—	.140	
	Carb. No. 7026046	15/32	C	1-9/32	E	1-11/32 <sup>11</sup>	—	—	—	Index	H	.055	—	—	—	.140	
	Carb. No. 7026147	1/2	B	1-27/32	D	1-11/32 <sup>11</sup>	—	—	—	Index	H	.055	—	—	—	.140	
	Carb. No. 7026047	1/2	B	1-27/32	D	1-5/32 <sup>13</sup>	—	—	—	Index	H	.055	—	—	—	.140	
Carb. No. 7036046, 048	1/2	B	1-27/32	D	1-5/32 <sup>13</sup>	—	1-1/16	—	Index	H	.055	—	—	—	.140		
1967-66	225 Eng.	1/2	B	1-27/32	D	1-5/32 <sup>13</sup>	—	—	—	Index	H	.055	—	—	—	.140	
	Carb. No. 7026144	1/2	B	1-27/32	D	1-11/32 <sup>11</sup>	—	—	—	Index	H	.055	—	—	—	.140	
	Carb. No. 7026145	1/2	B	1-9/32	D	1-1/16 <sup>16</sup>	—	31/32	—	Index	H	.055	—	—	—	.140	
	Carb. No. 7027050, 041, 042	1/2	B	1-27/32	D	1-1/16 <sup>13</sup>	—	31/32	—	Index	H	.055	—	—	—	.140	

**AMC, JEEP — SPECIFICATION I.D.-E**

1971	225 Eng. -Carb. No. 7041185	1-5/32 <sup>17</sup>	C	1-7/8	E	1-1/6	—	—	—	—	—	—	—	—	—	—
	-Carb. No. 7041186	1-5/32 <sup>17</sup>	C	1-7/8	E	1-1/6	—	—	—	Index	H	.055	—	—	—	.140
1968	350 Eng.	1-11/32	C	1-3/4	E	1-1/6	.025	—	—	Index	J	.035	.065	—	—	.140
1967-66	225 Eng.	1-5/32 <sup>17</sup>	A	1-3/4	D	1-5/32	—	—	—	—	—	—	—	—	—	—
	Carb. No. 7026082; 7027082	21/32	B	1-27/32	D	1-5/32	—	—	—	—	—	—	—	—	—	—
	Carb. No. 7026086	1-5/23 <sup>17</sup>	A	1-3/4	D	1-5/32	—	—	—	Index	H	.055	—	—	—	.140

**BUICK**

1965	300 Eng.	19/32	B	1-29/32	D	1-5/32 <sup>13</sup>	—	—	—	Index	H	.055	—	—	—	.140
1963-62	198 Eng. Exc.	21/32	B	1-29/32	D	1	—	—	—	1NR	H	.050	—	—	—	.180
	Carb. No. 7023048, 049	21/32	B	1-29/32	D	1	—	—	—	1NR <sup>18</sup>	H	.055	—	—	—	.160
1963-61	215, 300 Eng. Exc. '62 LeSabre	21/32	B	1-29/32	D	1-11/32	—	—	—	Index	H	.050	—	—	—	.160
	Carb. No. 70019042	11/16	B	1-29/32	D	1-1/8	—	—	—	1NR	H	.035	—	—	—	.080

**CHECKER**

1962	226 Eng.	5/8	B	1-29/32	D	1-11/32	—	—	—	Index	H	.050	—	—	—	.160
------	----------	-----	---	---------	---	---------	---	---	---	-------	---	------	---	---	---	------

**GRAY MARINE**

	215 Eng.	5/8	B	1-29/32	D	1-11/32	—	—	—	Index	H	.050	—	—	—	.160
--	----------	-----	---	---------	---	---------	---	---	---	-------	---	------	---	---	---	------

**OLDSMOBILE**

63-61	215 Eng. Exc.	9/16	B	1-13/16	D	1-3/16	—	—	—	19	H	.080	—	—	—	.260
	Carb. No. 7023056, 058	25/32	B	1-13/16	D	1-3/16	—	—	—	Index	H	.080	—	—	—	.260

**PALMER MARINE**

	215 Eng.	5/8	B	1-29/32	D	1-11/32	—	—	—	—	—	—	—	—	—	—
--	----------	-----	---	---------	---	---------	---	---	---	---	---	---	---	---	---	---

**PONTIAC**

62-61	215 Eng.	21/32	B	1-29/32	D	1-11/32	—	—	—	Index	H	.050	—	—	—	.160
-------	----------	-------	---	---------	---	---------	---	---	---	-------	---	------	---	---	---	------

**CRUSADER MARINE — SPECIFICATION I.D.-F**

	153 Eng.	5/8	B	1-29/32	D	1-5/32	—	—	—	Index	H	.040	—	—	—	.160
--	----------	-----	---	---------	---	--------	---	---	---	-------	---	------	---	---	---	------

**KIEKHAEFER MARINE**

	153 Eng.	5/8	B	1-29/32	D	1-5/32	—	—	—	Index	H	—	—	—	—	.160
--	----------	-----	---	---------	---	--------	---	---	---	-------	---	---	---	---	---	------

**FOOTNOTES:**

- 1 Carb. No. 7037080, 7024110 set .110".
- 2 Bottom of rod even with top of hole.
- 3 Carb. No. 7024101, 7027101, 103; 7037101, 103 set .120".
- 4 Carb. No. 7023007 set 1NL. Carb. No. 7020007; 7019007 set 1NR.
- 5 Carb. No. 7015015; 7013009, 011 set 1".
- 6 Carb. No. 7013015, 017, 973, 975 set 1-13/32".
- 7 Carb. No. 7011952; 7012503 set 1-1/4".
- 8 Carb. No. 7024074, 75, 173, 175; 7025070, 74, 75, 173, 175, 177 set 11/16".
- 9 Carb. No. 7024074, 75, 173, 175 do not set idle vent.
- 10 Carb. No. 7011350, 351, 352, 500 set 1-5/16".
- 11 Install pump rod in outer hole.
- 12 Carb. No. 7024057, 059 set 17/32".
- 13 Install pump rod in inner hole.
- 14 Rod in gauge notch.
- 15 Carb. No. 17054649 set 1-15/32".
- 16 Carb. No. 7027042 set 1-5/32".
- 17 From gasket to top of float at toe.
- 18 M/T set index.
- 19 1961 models set 1NL; 1962 models set Index.

**ABBREVIATIONS:**

- A/T - Automatic Transmission
- Cal. - California
- Exc. - Except
- M/T - Manual Transmission
- N/L - Notch Lean
- N/R - Notch Rich