

ST Suspensions, 1075 North Avenue  
Sanger, CA 93657 USA

Phone: 1-800-445-3767  
Fax: 1-559-876-2259

# INSTALLATION INSTRUCTIONS

## **Before you start to install, please read the following instructions carefully:**

- The suspension components must match the suspension application specifications (springs and shocks/struts identification numbers).
- The instructions must be followed !

## **Warning:**

- You must read the General Installation instructions, as well as the Technical Data documents carefully BEFORE attempting installation.
- The suspension components may only be installed by a properly trained technician using the proper tools.
- Always use the appropriate tools and safety equipment for each step to prevent any serious bodily harm or injury.
- Never use impact wrenches or guns to install or remove shock absorber piston hardware.
- Please take care that all attachment points of the suspension (for example: fittings of shock absorber housings or fittings of the lower control arm in the housing of the wheel bearing) are free of dust and oil. (see manufacturers guidelines).
- **CAUTION: Danger of explosion!!** Never disassemble or cut open shock absorbers and/or shock absorber inserts. They contain oil under pressure.
- The electronic suspension control (when applicable) needs to be disabled through an authorized dealer.
- We recommend the use of a vehicle hoist or lift when installing the suspension. If a lift is not available and jacking equipment is used, make sure that the vehicle is secured with commercial wheel blocks and jack stands to ensure safety.

## **General Instructions for Use:**

- When adjusting the vehicles height, make sure that the threads are clean and free of debris. After initial cleaning, move the perch downwards by 10 mm (0.4 Inches), and then clean the area that you desire to adjust the perch to (up or down).
- During height adjustments on separate shock and spring systems, remove the perch from the vehicle to adjust the height.
- The piston rod and the piston seal of the new and used damper may have oil and grease. This could either be caused by using special black grease during assembly or excess assembly oil. Furthermore, oil is used during assembly of the cartridge and rod guide. If dust and dirt has accumulated in these areas, there is no need to be worried about damage.

## **Copyright**

This assembly guideline is protected by copyright law. This assembly guideline is subject to a right to download and print the guideline which we grant for the purpose of the installation of products that have been purchased from us. Further reproduction is not allowed. Any devolution or sub-licensing of this copyright to a third party as well as any manipulation of the photographs is not allowed. We are entitled to cancel the granted copyright at any time. Copyright violations will be prosecuted.

## **General Mounting Specifications:**

1. We recommend the use of a vehicle hoist or lift when installing the suspension.
2. **Caution:** If the vehicle is equipped with ride height sensors, they should be removed before removal of struts or dampers, otherwise damage may occur. Disconnect the battery anytime any electrical parts are removed.
3. The struts should be removed as specified by manufacturer's instructions.
4. Manufacturer recommended tools for removal of the original struts, or a suitable spring compressor, has to be used in order to remove factory mounted suspension systems.
5. Mount the complete suspension system as described on the following pages.
6. Never use impact drivers to install nuts on the piston rods as permanent damage may occur. It is imperative that you do not damage the piston rod surface, such as use of pliers, as the smallest damage will result in seal damage, and will not be covered under warranty.
7. Ensure that the set screw on each spring collar is tightened to prevent movement of the spring perch. On vehicles with separate shock/spring combinations, a set screw is not necessary. **Caution:** Do not over tighten the set screw. Maximum torque is 1 - 2 Nm (0.74-1.47 ft-lb).
8. Install the suspension components to the vehicle as specified by the vehicle manufacturer in their factory service manual.
9. Except as noted, all torque values must comply with manufacturer recommended specifications.
10. After assembly and installation is complete, the vehicle should be rolled onto level ground. Once on level ground, measure the vehicle height and adjust to the customer's requirements, within the prescribed lowering range. **Caution:** It is possible that the vehicle suspensions will settle down for an additional 5 - 10 mm (0.2 - 0.4 Inches)
11. Examine the clearance between the tires and the suspension over the full range of motion of the wheel. The minimum clearance between the suspension and the tire is 5 mm (0.2 Inches). If this clearance is less than 5 mm (0.2 Inches), wheel spacers may be necessary. With strut designs which are located close to the wheel, but which don't have steering functions, place 100 mm (3.9 Inches) spacers underneath diagonally opposed tires (e.g. front right and rear left). In this position, you have to be able to achieve the minimum clearance required. You can also check the clearance between tire and body. **Caution:** Wheel hub center to wheel arch minimum and maximum measurement found in the installation documents may not be exceeded! Also take into account minimum road clearances as specified by local & state laws. **Caution:** With torsion beam trailing arm axles, this method is not sufficient. The vehicle has to be fully loaded test driven to properly calculate the clearances of 5 mm (0.2 Inches) from any other components.
12. The alignment of the suspension needs to be adjusted according the specifications of the vehicle manufacturer by a properly trained technician. If a value cannot be reached due to the difference in the height, an optimal value next to the tolerance range of the specifications should to be adjusted to.
13. All components that are controlled by vehicle ride height (e.g. headlights, brake bias regulator etc.) have to be adjusted as specified by the vehicle manufacturer instructions and procedures.
14. For vehicles with ESP, DSC or EPC your new suspension components may cause an engine fault code to appear. This is only temporary as the vehicle electronics adjust to the new components/ height. On some models this will end after driving approximately 3-5 miles, or through turning the steering wheel from full left to full right. On newer models, this must be reset through the factory diagnostic port by a qualified technician.
15. After you have completed installation of the suspension, check the clearance of the tires to the front suspension struts. The minimum clearance at the narrowest point is 5mm, please use wheels spacers if necessary.

### **Tightening torque for the piston rod nut:**

M8 = **25Nm (18 ft-lb)**, M10x1 = **20Nm (15 ft-lb)**, M10x1,25 = **20Nm (15 ft-lb)**, M12x1,25 = **35Nm (26 ft-lb)**, M12x1,5 = **40Nm (29 ft-lb)**, M14x1,5 = **50Nm (37 ft-lb)**, M16x1,5 = **50Nm (37 ft-lb)**

Technical data	Coilover part number 90616			
Vehicle model	VW Jetta IV Sedan + Wagon			
	front axle		rear axle	
Spring signature	20-60-80 / 60-170*		8001	
Coilover strut / Shock absorber signature	100 1005		100 1104	
Approximate adjustment range* A in mm / inch	min:	max:	min:	max:
	235 mm / 9,3"	240 mm / 9,4"	22 mm / 0,87"	52 mm / 2,05"
Approximate wheel hub center to fender edge measurement** B in mm / inch	min:		min:	
	355 mm / 14,0"		325 mm / 12,8"	

Calculating the adjustment range: (Photos are examples only)

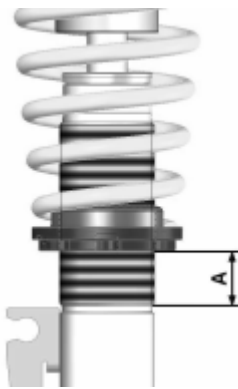

Remaining thread measurement of Strut A

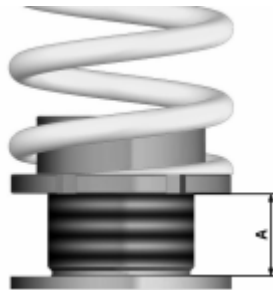

Remaining thread measurement A

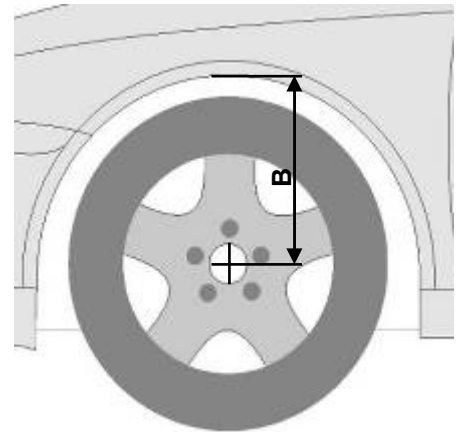

Measurement B  
Wheel hub center - fender edge

Please enter the adjusted height of the modified car into the list:

Coilover part no	Vehicle type	Measurement A		Wheel hub center to wheel arch Measurement B	
		Front	Rear	Front	Rear

\* The remaining thread measurement is approximate and is only intended as a general guide. Actual results may vary due to various axle weights.

\*\* **IMPORTANT:** The allowable measurement between wheel hub center and fender edge as indicated above, may not exceed this measurement when using standard fenders.

**Front axle:**

Due to the unfavourable set-up of the drive shaft, anti-roll bar and body of the car it is possible to lower the car only up to 40 mm (1.57 inches) without using an anti-sway bar conversion.

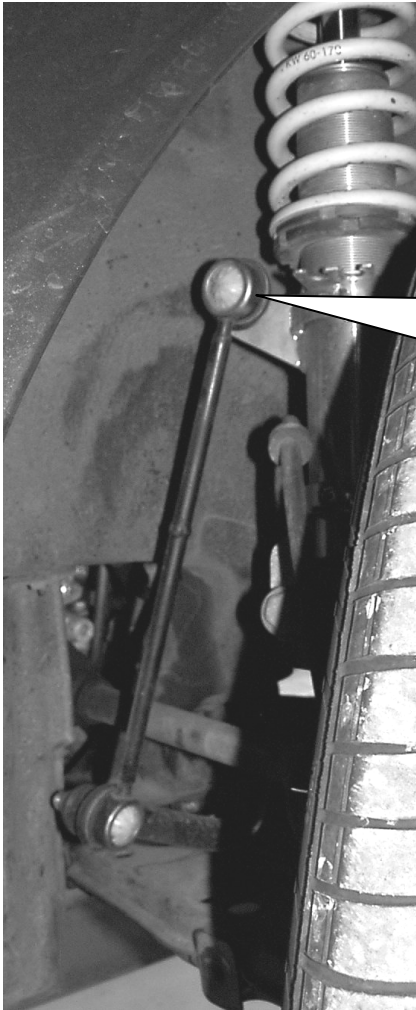

**Additional Note sway bar:**

Struts are supplied including a sway bar holder. This may be used to fix the anti-sway bar conversion kit for a lowering of more than 40 mm (1.57 inches).  
Part no for vehicles without Xenon headlights 685 50 000  
Part no for vehicles with Xenon headlights 685 50 005

**Note for lowering up to 40 mm (1.57 inches):**

Front struts are supplied with two 15 mm (0.59 inches) travel limiters (total height of the travel limiters 30 mm (1.18 inches)). These travel limiters have to be used if the anti-sway bar conversion kit is not used. In this case only a lowering up to 40 mm (1.57 inches) is possible (see TUEV Certificate).

**Note for lowering up to max. 55 mm (2.17 inches), for vehicles with a factory drive shaft with a diameter of 53 mm (2.09 inches) or smaller:**

Please use the anti-sway bar conversion kit (part-no. mentioned above) and remove one of the two additional travel limiters.

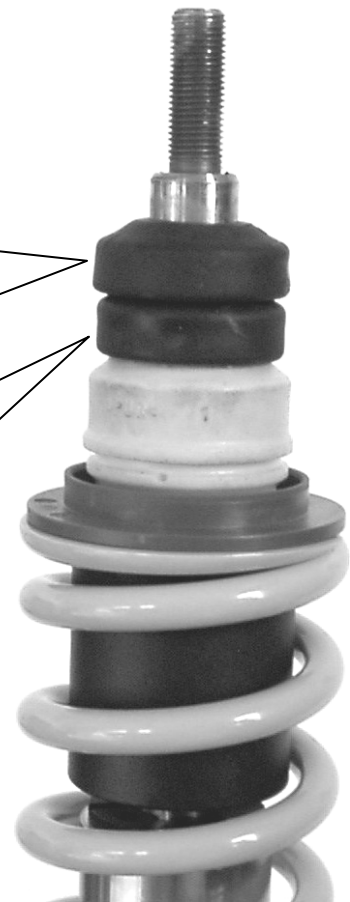

**Note for lowering up to max. 65 mm (2.5 inches), for vehicles with a factory drive shaft with a diameter of 43 mm (1.7 inches) or smaller:**

Please use the anti-sway bar conversion kit (part-no. mentioned above) and remove both of the travel limiters



**Rear axle:**

The rear axle shock absorber has to be installed according to the car manufacturer installation instructions. Unless there is no bump stop supplied the factory bump stop has to be used. The factory bump stop has to be in a good condition, otherwise it has to be replaced.

If necessary dismantle the pastic ring at the rear axle for instlling the suspension kit.

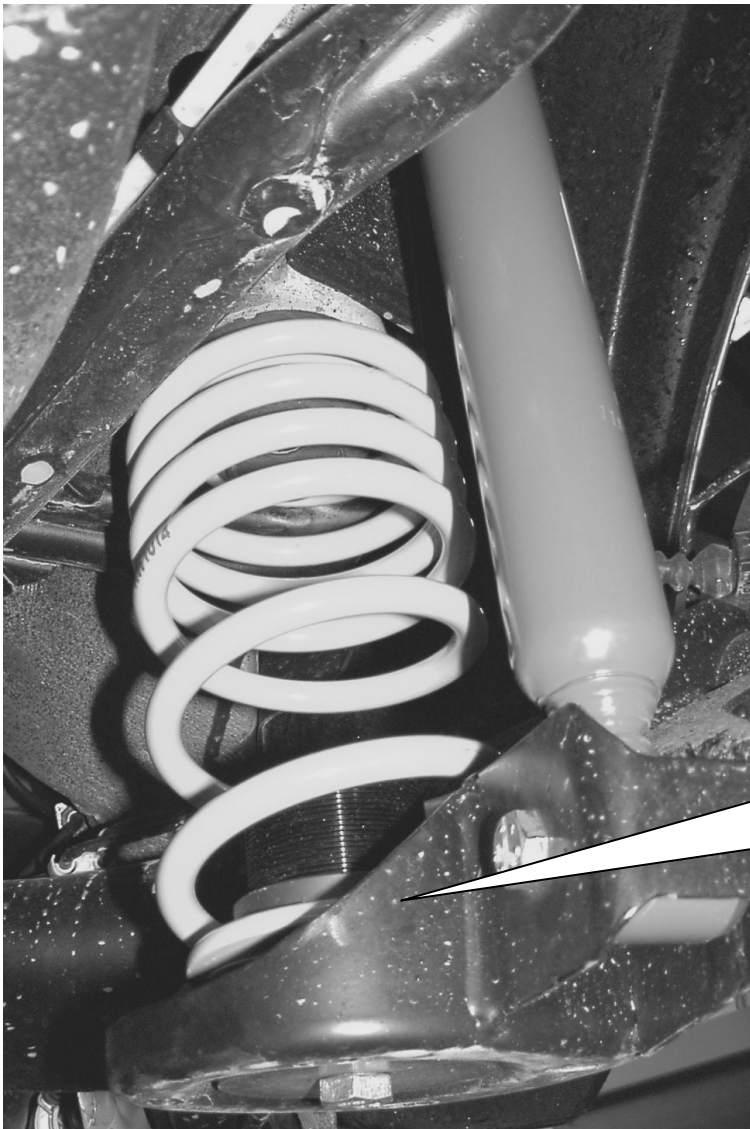
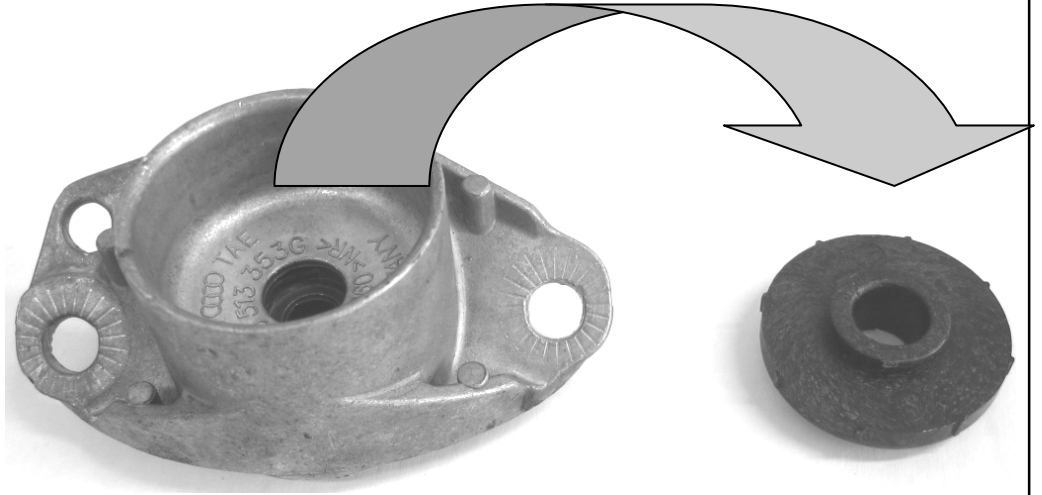

Original lower spring perch that is inserted into the axle must be removed.



Install the rear height adjustable perch using the bolt and washer provided (tightening torque is 50 Nm (37 ft-lb)). Attention: Before installing the height adjustment perch ensure that the surface has been thoroughly cleaned. Please remove the spring before adjusting the vehicle height.