

SIT[®]

SUSPENSIONS



made by  KW

Installation Instructions		<i>KW automotive</i>	
Instruction No.	688 10 0AW	Date	06.04.2020

KW automotive

INSTALLATION INSTRUCTIONS

**Before you start installation work,
please read the following carefully:**

- **Ensure that the certificate matches the vehicle specifications (front vehicle identification number (VIN)) etc...**
- **The suspension components must match the suspensions application specifications (springs and shock/struts identification numbers).**
- **The instructions have to be strictly observed.**

KW Coilovers for automobile suspensions are designed for easy installation. If not otherwise stipulated in these instructions, all suspension components are installed and removed in accordance with the manufacturer's specifications for installing and removing standard springs and damper components. At the time of printing all instructions and specifications are correct.

Installation Instructions			KW automotive	
Instruction No.	688 10 0AW		Date	06.04.2020

Technical data	Part number 253 10 0AW 273 10 0AW			
Vehicle model	Audi A4 sedan (B9) type B8		max. permissible front axle load: 1135 kg	
	front axle		rear axle	
Spring signature	5-80-70 / 70-70-225*		1058	
Coilover strut / Shock absorber signature	OEM		OEM	
Approximate distance measurement A Front axle: Fastening screw - spring contact area Rear axle: Seating height adjustment - spring contact area or fastening screw - spring contact area	min:	max:	min:	max:
	210 mm / 8,3 inch	230 mm / 9,1 inch	13 mm / 0,51 inch	33 mm / 1,3 inch
Approximate measurement* B in mm / inch: wheel hub center to fender edge	min:		min:	
	350 mm / 13,8 inch		350 mm / 13,8 inch	

Vehicle model	Audi A5 coupe (B9) type B8		max. permissible front axle load: 1135 kg	
	front axle		rear axle	
Spring signature	5-80-70 / 70-70-225*		1058	
Coilover strut / Shock absorber signature	OEM		OEM	
Approximate distance measurement A Front axle: Fastening screw - spring contact area Rear axle: Seating height adjustment - spring contact area or fastening screw - spring contact area	min:	max:	min:	max:
	215 mm / 8,5 inch	235 mm / 9,3 inch	13 mm / 0,51 inch	33 mm / 1,3 inch
Approximate measurement* B in mm / inch: wheel hub center to fender edge	min:		min:	
	350 mm / 13,8 inch		350 mm / 13,8 inch	

Installation Instructions			KW automotive	
Instruction No.	688 10 0AW		Date	06.04.2020

Calculating the adjustment range (distance measurement A) : (Photos are examples only)

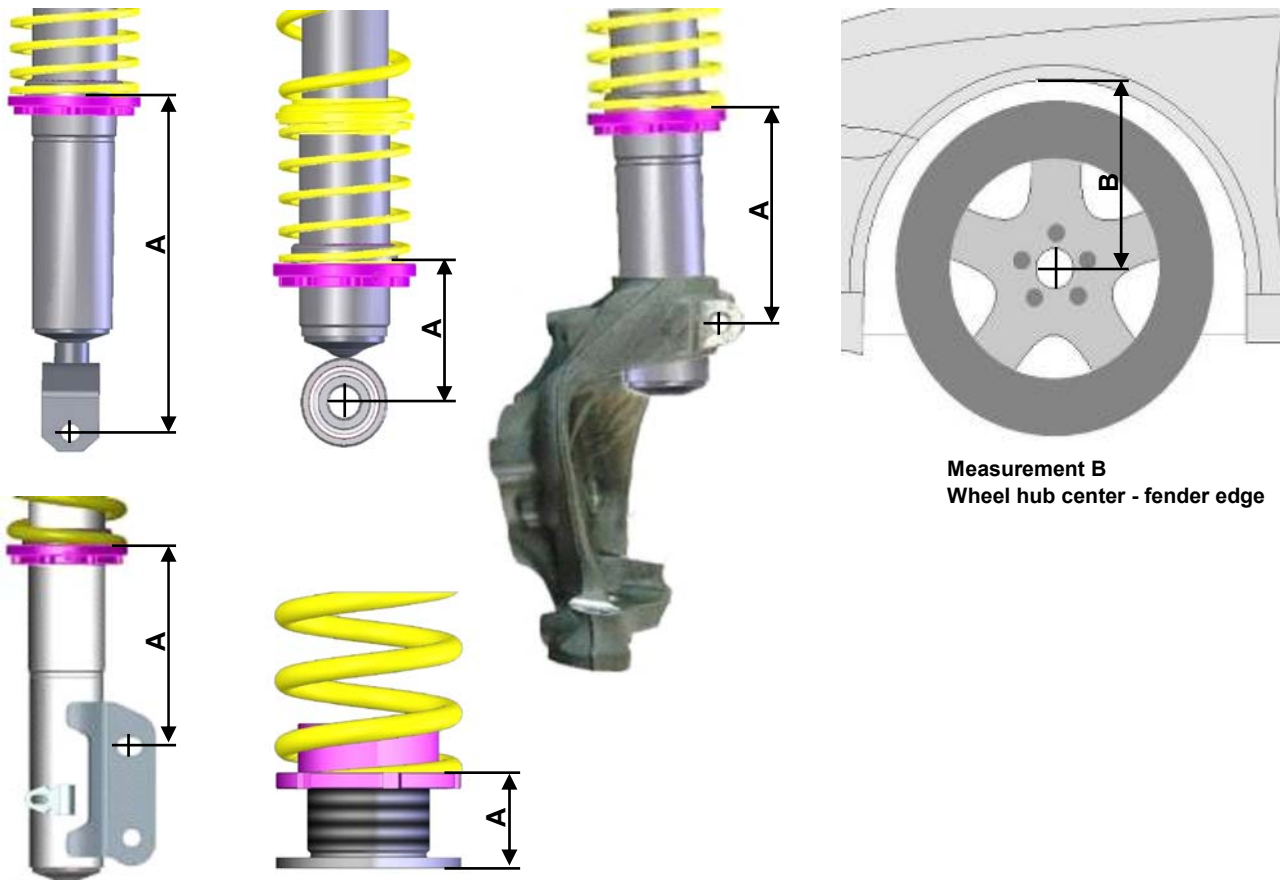

Measurement B
Wheel hub center - fender edge

Please enter the adjusted height of the modified car into the list:

Coilover part no	Vehicle type	Measurement A		Wheel hub center - fender edge Measurement B	
		Front	Rear	Front	Rear

* **IMPORTANT:** The allowable measurement between wheel hub center and fender edge as indicated above, may not exceed these measurements when using standard fenders.

Installation Instructions			<i>KW automotive</i>	
Instruction No.	688 10 0AW		Date	06.04.2020



Danger:

Always follow the latest accident prevention regulations (not applicable for North America) for each step to prevent any serious bodily harm or injury.

1. We recommend the use of a vehicle hoist or lift when installing the suspension. If a lift is not available and jacking equipment is used, make sure that the vehicle is secured with commercial wheel blocks and jack stand to ensure safety.
2. The suspension components may only be installed by trained technical personnel using the proper tools.
3. The General Installation instructions, as well as the Technical Inspectorate documents must be read BEFORE attempting installation.
4. Never use impact wrenches or guns to install or remove shock absorber piston hardware.
5. Never disassemble or cut open shock absorbers and/or shock absorber inserts. They contain oil under pressure. Danger of explosion.
6. Before driving on public highways, carry out the work steps on page 7, items 11 through 14 after installation.
7. Please take care in any case that fittings (for example fittings of shock absorber housings or fittings of the lower control arm in the housing of the wheel bearing) are free of dust and oil. (see manufacturer guideline)

General Instructions for Use:

1. When adjusting the vehicle height, make sure that the threads are clean and free of debris. After initial cleaning, move the perch by 10 mm (0.4 Inches) downwards, and then clean the area that you desire to adjust the perch (up or down).
2. During height adjustments on separate shock and spring systems, remove the perch from the vehicle to adjust the height.
3. After adjusting the vehicle height, repeat steps 11 through 14 from page 7.
4. In the area of the piston rod and the sealing package of the new and used damper there might be oil and grease collected. This could either be caused by using a special black grease during assembling the washer or due to accumulation of streak oil. Further more oil is used during assembling the cartridge and rod guide. There is no reason of worrying about and damage, as in this area also dust and dirt used to be collected.

Tightening torque for the piston rod nut:

M8 = **25Nm (18 ft-lb)**, M10x1 = **20Nm (15 ft-lb)**, M10x1,25 = **20Nm (15 ft-lb)**, M12x1,25 = **35Nm (26 ft-lb)**,
M12x1,5 = **40Nm (29 ft-lb)**, M14x1,5 = **50Nm (37 ft-lb)**, M16x1,5 = **50Nm (37 ft-lb)**

Copyright

This assembly guideline is protected by copyright law. This assembly guideline is subject to a right to download and print the guideline which we grant for the purpose of the installation of products that have been purchased from us. Further reproduction is not allowed. Any devolution or sub-licensing of this copyright to a third party as well as any manipulation of the photographs is not allowed. We are entitled to cancel the granted copyright at any time. Copyright violations will be prosecuted.”

Installation Instructions			KW automotive	
Instruction No.	688 10 0AW		Date	06.04.2020



General Mounting Specifications:

1. We recommend the use of a vehicle hoist or lift when installing the suspension.
2. **Caution:** If the vehicle is equipped with ride height sensors, they should be removed before removal of struts or dampers, otherwise damage may occur.
3. The struts should be removed as specified by manufacturer's instructions.
4. Manufacturer recommended tools for removal of the original struts, or a suitable spring compressor, must be used in order to remove most factory mounted suspension systems.
5. Mount the complete suspension system as described on the following pages.
6. Never use impact drivers to install nuts on the piston rods as permanent damage may occur. It is imperative that you do not damage the piston rod surface, through use of pliers etc, as the smallest damage will result in seal damage, and will not be covered under warranty.
7. Stay within the lowering range specified in the table on page 3.
Example: With a specified range of 20 - 60 mm (0.8 - 2.3 Inches), 40 mm (1.5 Inches) is your height adjustment range.
8. Ensure that the set screw on each spring collar is tightened to prevent movement of the spring perch. On vehicles with separate shock/spring combinations, no set screw is necessary.
Caution: Do not over tighten the set screw. Maximum torque is 1 - 2 Nm (0.74-1.47 ft-lb).
9. Install the suspension components in the vehicle as specified by the vehicle manufacturers in their document.
10. Except as noted, all torque values must comply with manufacturer recommended specifications.
11. After assembly and installation is complete, the vehicle should be rolled onto level ground. Once on level ground, measure the vehicle height and adjust to the customer's requirements, within the prescribed lowering range.
Caution: Wheel hub center—wheel arch maximum measurement in the table of page 3 must not be exceeded! Also take into account minimum road clearances specified in the table on page 7 (only valid for Germany!).
Caution: It is common for the vehicle suspensions to settle by an additional 5 - 10 mm (0.2 - 0.4 Inches)
12. Examine the clearance between the tires and the suspension over the full range of motion of the wheel. The minimum clearance between the suspension and the tire is 4 mm (0.16 Inches). If this clearance is less than 5 mm (0.2 Inches), wheel spacers may be necessary. With strut designs that are located close to the wheel, but that have no steering functions, use 100 mm (3.9 Inches) spacers on diagonally opposed wheel (e.g. front right, rear left). In this position, you must be able to achieve the minimum clearance required. You can also check the clearance between tire and body.
Caution: With torsion beam trailing arm axles, this method is not sufficient. The wheel must be under full load as well as test driven to properly calculate the clearances of 5 mm (0.2 Inches) from any other components.
13. The geometry of the suspension needs to be adjusted according the regulations of the vehicle manufacturer. If a value cannot be reached due to the difference in the height, a optimal value next to the tolerance range of the vehicle manufacturer needs to be adjusted.
14. All components that are controlled by vehicle ride height (e.g. headlights, brake bias regulator etc.) must be adjusted as specified by the vehicle manufacturer instructions and procedures.
15. For vehicles with ESP, DSC or EPC your new suspension components may cause an engine fault code to appear. This is only temporary as the vehicle electronics adjust to the new components/height. On some models this will end after driving approximately 3-5 miles, or through turning the steering wheel from full left to full right. On other models, this must be reset through the factory diagnostic port by a qualified technician.

Installation Instructions

KW automotive

Instruction No.

688 10 0AW

Date

06.04.2020

Front axle:

Remove the OEM spring, OEM bumpstopp and the OEM dust cover. In the next stepp remover (pull) the molded ventilation disk **1** and the spring perch **2**.

The OEM spring perch is no longer needed.



1

2

Remove the bush and the metalring. Ther are no longer needed.
Do not remove the safety ring on the damper.

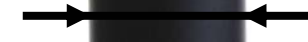

Only for damper diameter
53,0mm.



Installation Instructions			KW automotive	
Instruction No.	688 10 0AW		Date	06.04.2020

Front axle:

Clean thoroughly damper.



Insert the supplied threaded bush 1, threaded ring with adapter 2 and the ventilation cap 3 on the coilover strut.

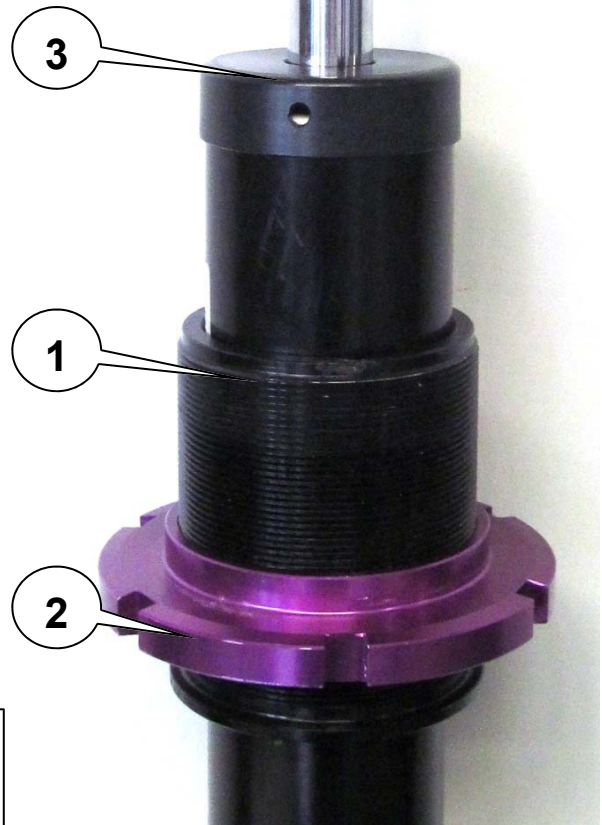

Remove all parts from the original supporting bearing. These components are no longer required.

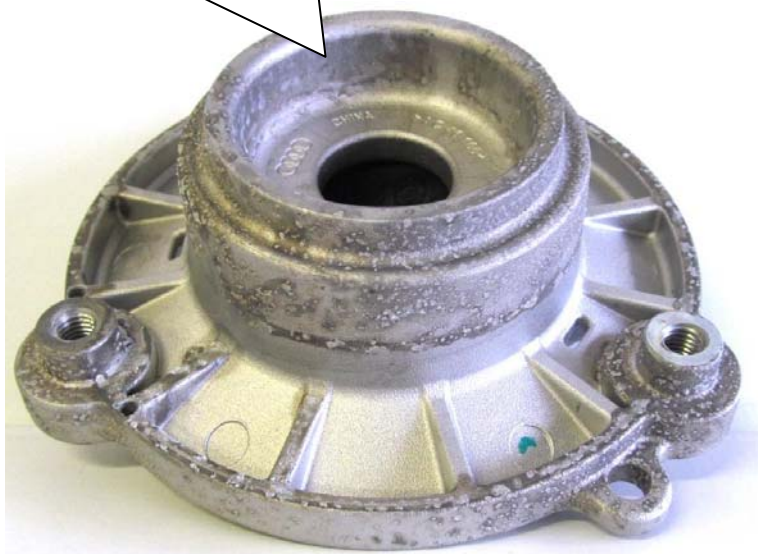

Installation Instructions

KW automotive

Instruction No.

688 10 0AW

Date

06.04.2020

Front axle:



Put on the supplied spring adapter.

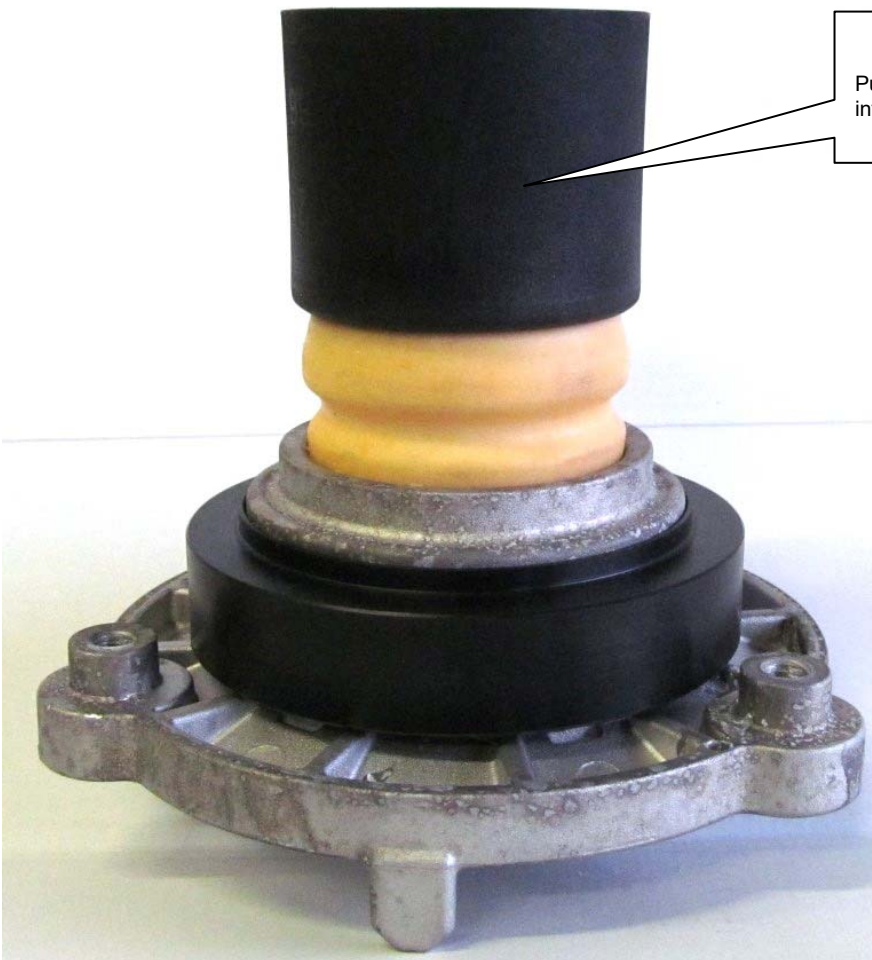

Put in the supplied bump stop with dust cover into the OEM top mount.

Installation Instructions

KW automotive

Instruction No.

688 10 0AW

Date

06.04.2020

Front axle:



Insert the following supplied parts in the same succession: spring 1, Intermediate ring 2 and Helper spring 3.

Install the original supporting bearing with supplied bumpstop and dustcover and fix it with the standard nut. Please install the strut unit to manufacturers recommended settings regarding tightening torque and fixing specifications.



Installation Instructions

KW automotive

Instruction No.

688 10 0AW

Date

06.04.2020

Rear axle:

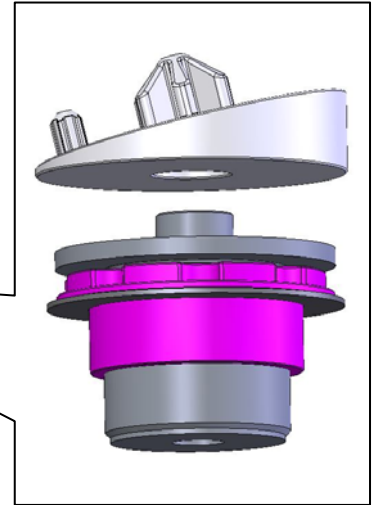

The height adjustment with the disc and the adapter has to be inserted at the top and the original upper spring support has to be removed. Please read the height adjustment for adjusting the car height.

Use the original spring support at the bottom end of the spring.

Installation Instructions

KW automotive

Instruction No.

688 10 0AW

Date

06.04.2020

Rear axle:

Dismantle the rear top mount:
Disassemble the plug on the strut with a suitable tool.
Note the positions of the lines (color and pin number).

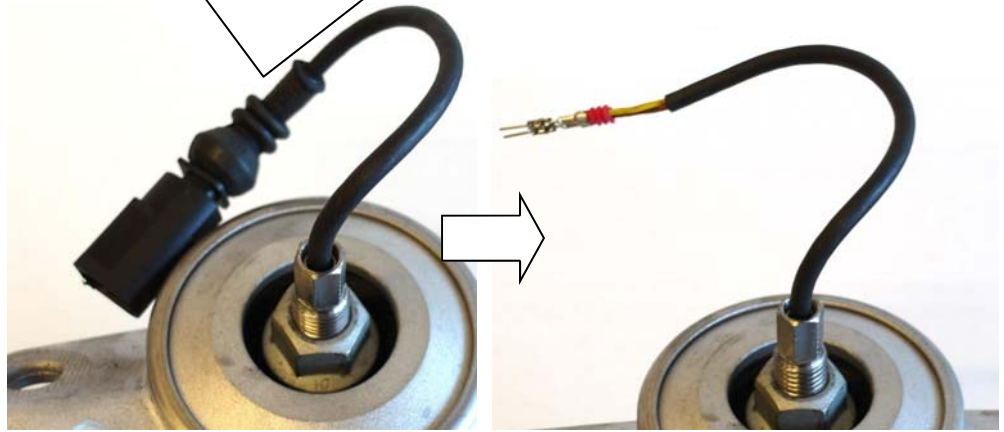

Dismantle the standard top-mount with a correct tool.



Remove the bumpstop with dustcover. These are no longer needed.



Put on the supplied bumpstop.



Installation Instructions

KW automotive

Instruction No.

688 10 0AW

Date

06.04.2020

Rear axle:



Put on the supplied bumpstopp with dust cover.

Install the original supporting bearing and fit with the standard nut. Please install the damper unit to manufacturers recommended settings regarding tightening torque and fixing specifications.

