

Speedmaster 15000lbs / 6803kgs 12V Electric 4wd Winch Kit w/ Wireless Remote

PCE553.1006

INSTALLATION METHOD FOR WINCH



SAFETY PRECAUTIONS

Clothing

Do not wear loose clothing or jewelry which may be caught by moving elements. Always wear leather clothes when holding the winch rope. Do not hold the steel rope with bare hands, even minor cracks on the line may cause injuries. It is recommended to wear non-slip shoes. Use headgear and pin up long hair.

Keep safe distance

Make sure unauthorized people are kept at appropriate distance from the working winch and its rope. The recommended distance is 1.5 times rope length.

REMEMBER THAT BREAKING ROPE MAY CAUSE SEVERE INJURIES OR EVEN DEATH TO THE PEOPLE IN ITS WAY.

Do not cross wind rope and do not stand over the rope.

Do not overload the winch

The details describing the winch capacity provided in the manual are the maximum, not working parameters. Remember that the winch pull force parameters are specified for ideal conditions, which does not consider land elevation, terrain obstacles, etc. Therefore, remember to select the winch that is appropriate to your needs. Details of the selection are specified further on in the manual.

If the motor is overheated, stop working for a couple of minutes and let it cool down.

If the motor stops, disconnect power supply and diagnose the cause.

WINCH PROPERTIES

Power: 6.0 HP

Motor: Series Wound

Gear Ratio: 265:1

PRINCIPLES OF WINCH OPERATION

The load should be pulled in a straight line. If it is necessary to pull the load at an angle, use appropriate pulley block.

When pulling the load, pay attention to correct arrangement of the rope on the drum. It is essential that the rope is not wound in one place and avoid jamming the rope between previous fakes. In such cases, unwind the rope and start winding again.

IMPORTANT: DO NOT LOAD THE WINCH MORE THAN UP TO 80%

Slope Inclination (Percent Gradient)	10%	20%	40%	60%	80%	100%
Slope Inclination (Degree)	5.7106°	11.3099°	21.8014°	30.9638°	38.6598°	45°

NOTE: Bracket for fairlead is not included.

MOUNTING THE WINCH

1. Use the diagram as a reference to drill the hole pattern onto desired location. (See Diagram 1)
ALL DIMENSIONS IN INCHES.



2. Install the bolts and nut as shown. (See Diagram 2) (Hardware not included.)

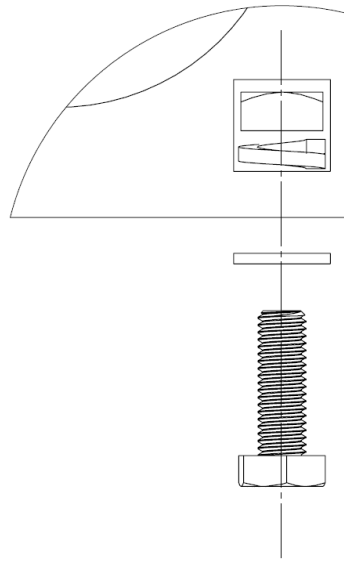

WIRING DIAGRAM

