

SPECTRE®

Performance

Intake Installation Instructions

P/N 9961 (red filter) - P/N 9961B (blue filter)

P/N 9961K (black filter) - P/N 9961W (white filter)

Year/Make/Model/Engine

2000-2004 Toyota Tundra 4.7L

2001-2004 Toyota Sequoia 4.7L

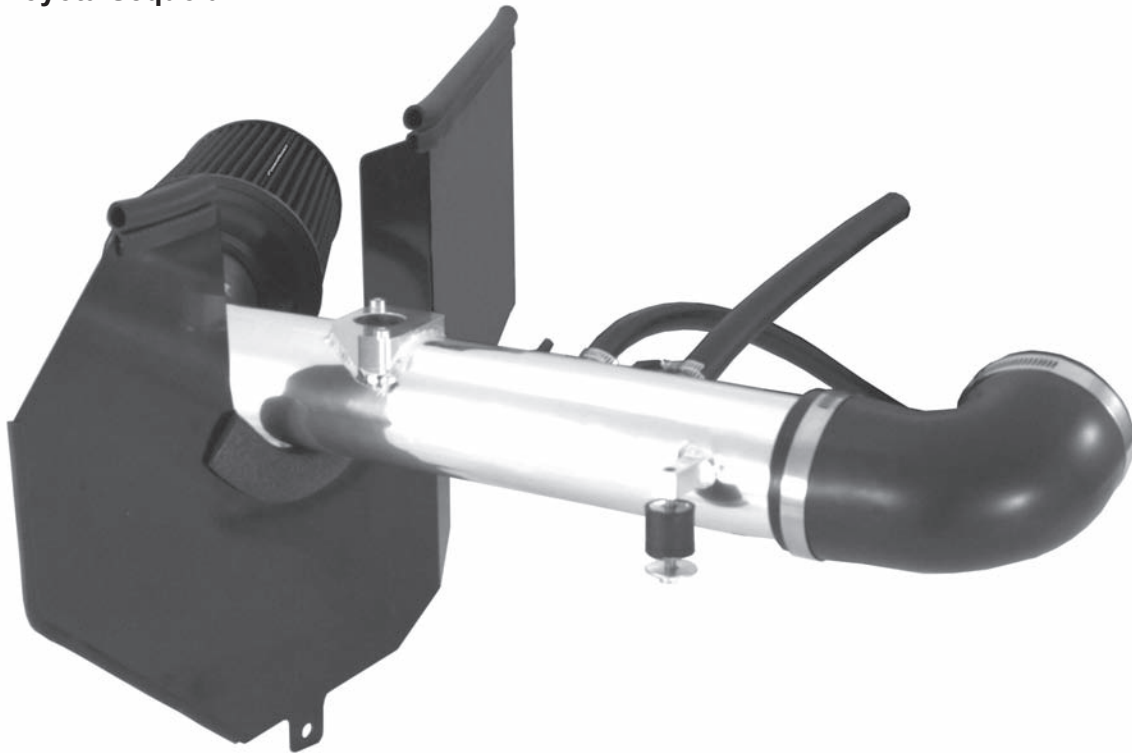

Parts List

- | | |
|--------------------------|---------------------|
| 1- Intake tube | 2- Edge Gaskets |
| 1- Air filter | 4- M5 allen bolts |
| 1- Heat Shield | 4-M5 lock nuts |
| 1- 6mm Rubber Mount | 4-M5 washers |
| 1- 6mm Washer | 1-M4 hex key wrench |
| 1- 6mm Nylock Nut | |
| 1- 90° 3.25"-3" Coupler | |
| 2- 3" Hose Clamps | |
| 1- 3.25" Hose Clamp | |
| 2- 1" Hose Clamps | |
| 2- 3/4" Hose Clamps | |
| 12"- 1/2" Breather Hose | |
| 19"- 5/16" Breather Hose | |
| 15"- 5/32" Breather Hose | |
| 1- 1/8" Grommet | |
| 1- 1/8" Straight Nipple | |
| 12- Rubber edge Trim | |

Tools Required:

- Phillips screwdriver
- Flat blade screwdriver
- 8mm wrench
- 10mm socket
- 12mm socket
- Socket wrench with extension
- Pliers

P/N HPR9884B (blue filter)
P/N HPR9884K (black filter)
P/N HPR9884W (white filter)

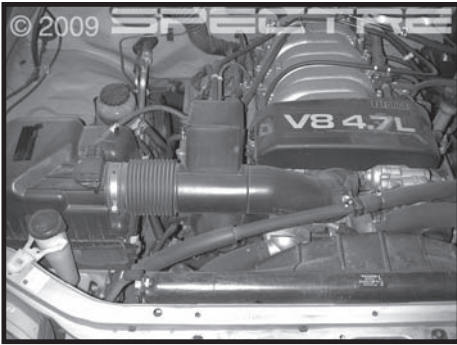

Step 1
Safety First! Before you begin, disconnect the negative battery terminal. Verify all components listed are present before beginning the installation.



Step 2
Remove the throttle body cover by removing the two nuts and lifting it out.

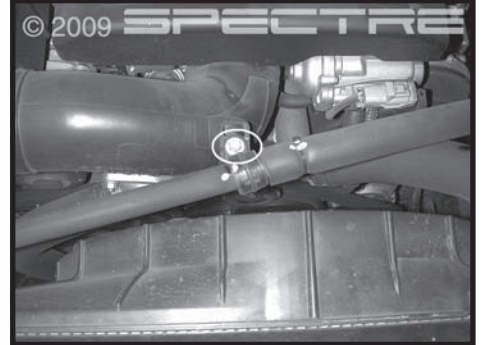

Step 3
Remove the bolt retaining the stock AC line to the factory intake (retain for later installation).

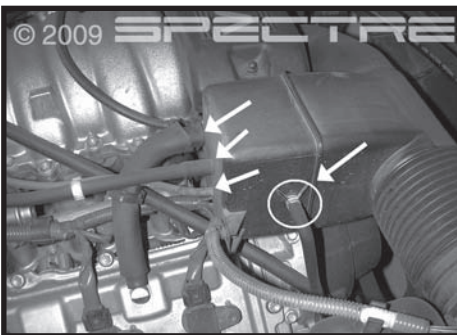

Step 4
Remove the 4 vacuum hoses from the stock air box. (Note: some models will have three hoses and a vacuum cap, which will need to be removed as well).

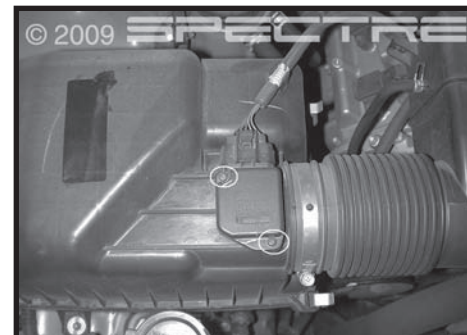

Step 5
Remove the Mass Air Flow (MAF) sensor from the factory air box by removing the two retaining screws.

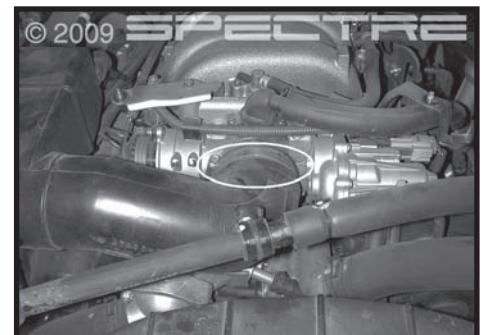

Step 6
Loosen the hose clamp retaining the stock intake to the throttle body.



Step 7
Remove the three bolts retaining the stock intake box and system, and remove stock intake assembly.

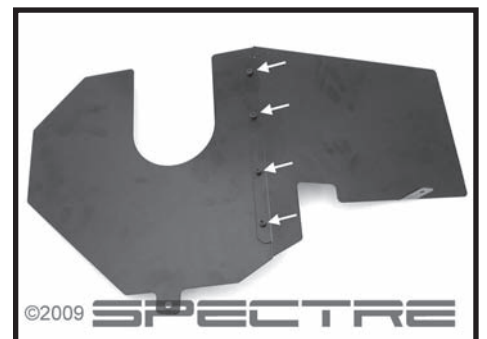
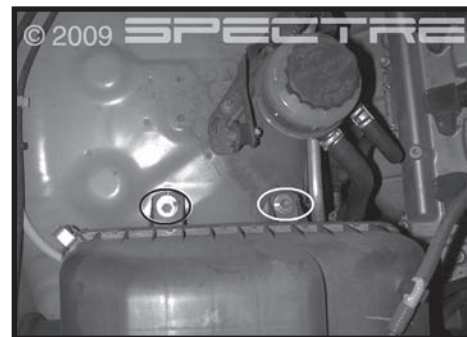

Step 8
Using the included 5mm Allen bolts, lock nuts and washers, assemble the heat shield as shown. Install the Allen bolts from the top of the flanges and put the flat washer and lock nuts on the back. Once all the hardware is installed, use the included hex key wrench and an 8mm (5/16" will also work) wrench to fully tighten all of the lock nuts.

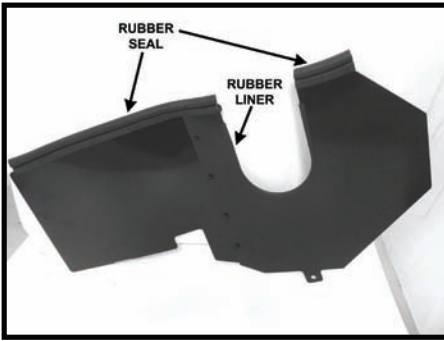

Step 9
Install the small rubber liner and rubber seals on the heat shield.

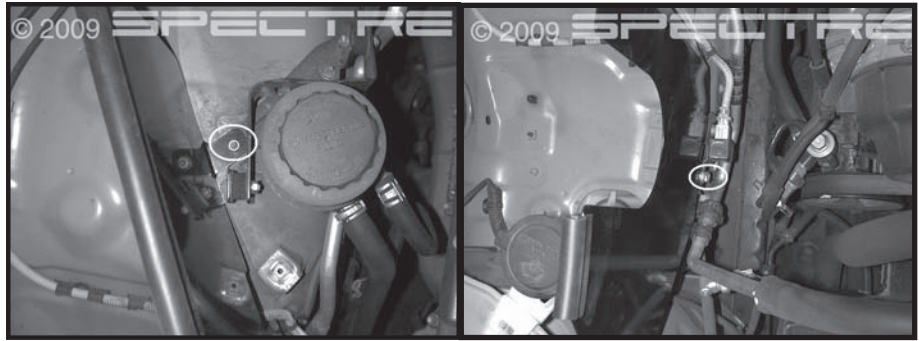

Step 10
Remove the nut on the power steering reservoir bracket. Remove the bolt on the bracket (shown above). Insert the heat shield and use the stock nut and bolt to secure in place.

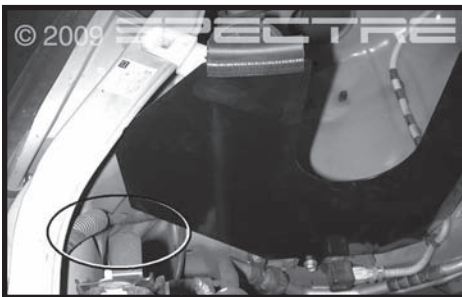

Step 11
Relocate the stock wiring harness to the lower front portion of the heat shield. Make sure that the shield is not interfering with the wires. If necessary, loosen the shield and adjust as needed.

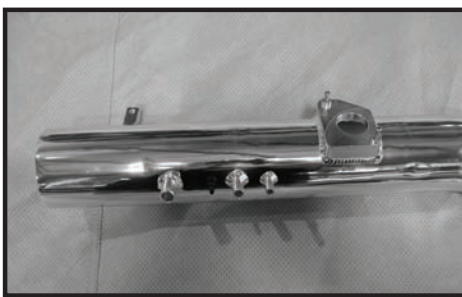

Step 12
Install the supplied grommet and hose nipple onto the intake tube.

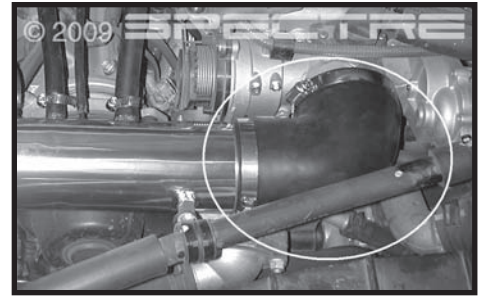

Step 13
Install the rubber coupler on the throttle body, insert the intake tube into the rubber coupler as shown, and secure with the supplied hose clamps.

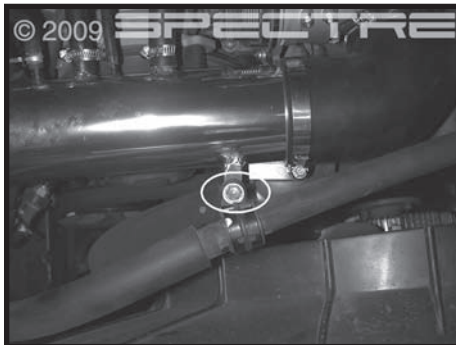

Step 14
Use the stock bolt (removed in step 3) to secure the A/C line to the mounting tab on the Spectre intake pipe.

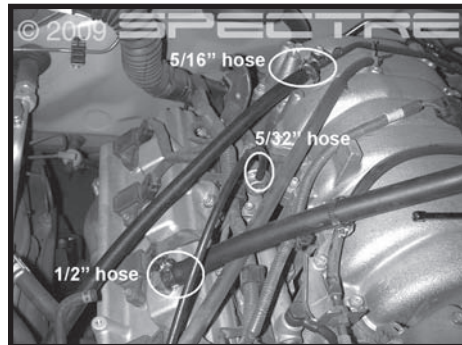

Step 15
Install the supplied hoses on 1) the fuel pressure regulator (5/32"), 2) the 5/16" tube (if applicable), and 3) the 1/2" barb, as shown. Secure the 5/16" and 1/2" hoses with the supplied clamps.



Step 16
Install the 3 new hoses and the factory hose (removed in step 5) and secure in place using the supplied hose clamps. If the vacuum cap was removed in step 4 install that now (there will be 3 hoses and 1 vacuum cap).



Step 17
Thread the rubber mount into the stock air box mounting hole as shown. Using the washer and nylock nut, install the intake tube bracket in place.

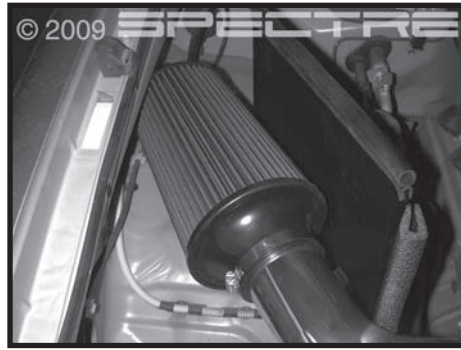

Step 18
Install the Spectre filter on the new intake and secure using the supplied hose clamp.

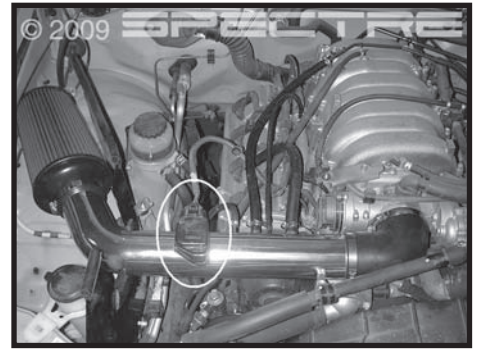

Step 19
Re-install the MAF sensor in the inlet pipe using the stock mounting screws and plug the wiring connector in.

Step 20
Make sure all bolts and clamps are now tight. Reconnect the negative terminal on the battery. Start up the engine and check for any air leaks. Affix the CARB. E.O. sticker in a prominent place under the hood. Your installation is now complete. Periodically check all clamps and brackets. Enjoy your Spectre Intake System.

SPECTRE
Performance