

SPECTRE®

Performance

Intake Installation Instructions

P/N 9900 (red filter) - P/N 9900B (blue filter)

P/N 9900K (black filter) - P/N 9900W (white filter)

Year/Make/Model/Engine

02-06 Cadillac Escalade 5.3L V8	V8 99-06 Chevy Silverado/GMC Sierra 2500 5.3L V8
02-06 Cadillac Escalade 6.0L V8	99-06 Chevy Silverado/GMC Sierra 2500 6.0L V8
02-06 Cadillac Escalade EXT 6.0L V8	01-05 Chevy Silverado/GMC Sierra 2500HD 6.0L V8
03-06 Cadillac Escalade ESV 6.0L V8	2007 Chevy Silverado/GMC Sierra 2500 HD Classic 6.0L V8
02-06 Chevy Avalanche 5.3L V8	03-06 Chevy Silverado SS 6.0L V8
99-06 Chevy Silverado/GMC Sierra 1500 4.8L V8	2007 Chevy Silverado SS Classic 6.0L V8
2007 Chevy Silverado/GMC Sierra 1500 Classic 4.8L V8	00-06 Chevy Tahoe/GMC Yukon 4.8L V8
99-06 Chevy Silverado/GMC Sierra 1500 5.3L V8	00-06 Chevy Tahoe/ Chevy Suburban 5.3L V8
2007 Chevy Silverado/GMC Sierra 1500 Classic 5.3L V8	00-06 GMC Yukon/GMC Yukon XL 5.3L V8
2007 Chevy Silverado/GMC Sierra 1500 Classic 6.0L V8	00-06 Chevy Tahoe/ Chevy Suburban 6.0L V8
01-05 Chevy Silverado/GMC Sierra 1500HD 6.0L V8	01-04 GMC Yukon Denali 6.0L V8
2007 Chevy Silverado/GMC Sierra 1500 HD Classic 6.0L	

Parts List

- 1 - Filter shield
- 1 - Air filter
- 1 - Intake tube
- 1 - MAF sensor adapter
- 1 - Rubber vibration mount
- 2 - M6 fender washers
- 2 - M6 locknuts
- 1 - 4" coupler
- 1 - 4" coupler 90°
- 4 - 4" hose clamps
- 1 - 6" hose clamp
- 1 - MAF adapter ring
- 3 - M5 allen bolts
- 3 - M5 flat washers
- 3 - M5 lock nuts

Tools Required:

- 10mm socket or wrench
- 5/16" nut driver or flat blade screwdriver
- 5/32 Allen wrench
- 5/16" wrench

P/N HPR9891 (red filter)
P/N HPR9891B (blue filter)
P/N HPR9891K (black filter)
P/N HPR9891W (white filter)

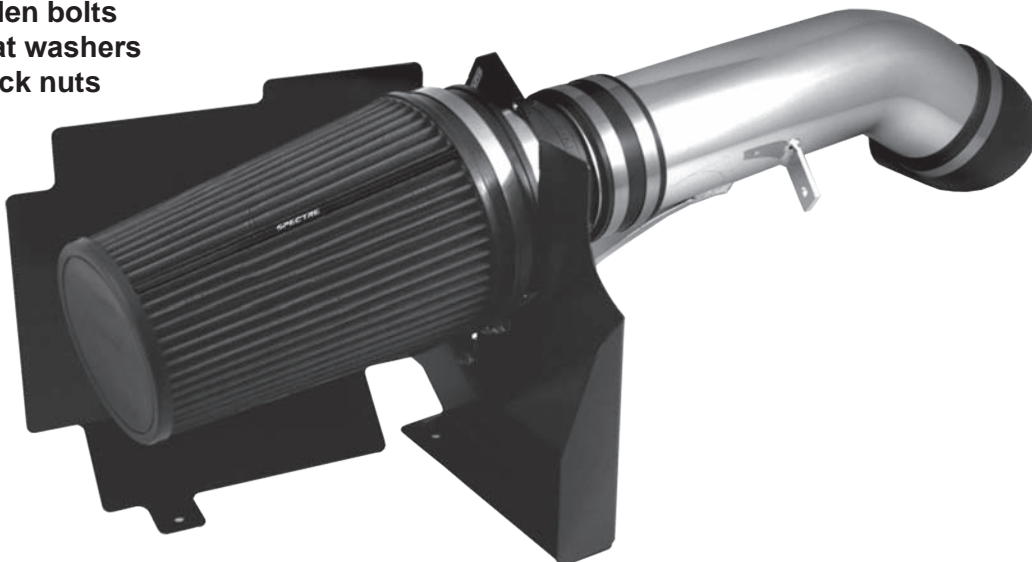

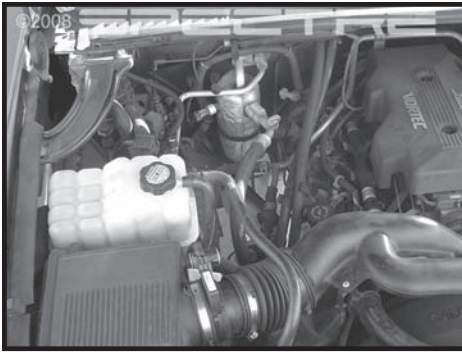

Step 1
Safety First! Before you begin, disconnect the negative terminal on your battery. Verify all components listed are present before beginning your installation.



Step 2
Start by loosening the clamps securing the OE intake tube to the throttle body and the MAF sensor

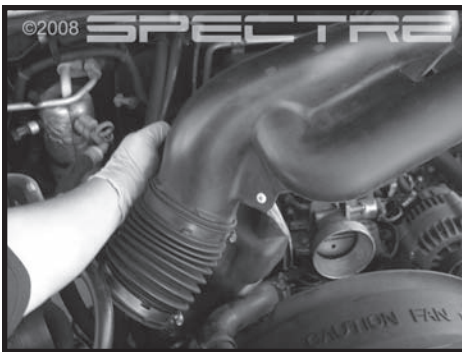
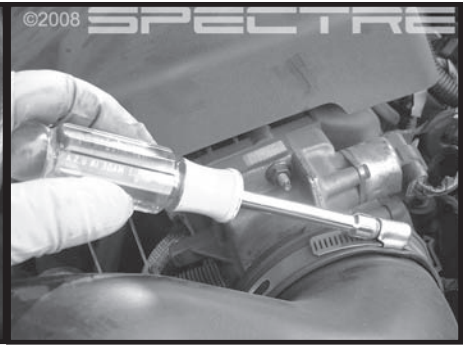

Step 3
Remove the OE intake assembly out of the engine.



Step 4
Disconnect the MAF sensor.



Step 5
Grab the air box from both sides and pull up and out. The air box is held in place with rubber grommets



Step 6
Loosen the hose clamp securing MAF sensor to the air box. Carefully remove MAF sensor and rubber ring from the air box assembly and set aside for later use.

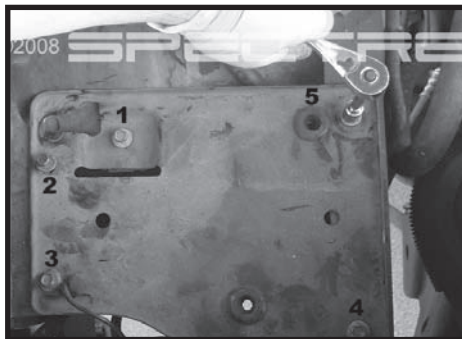

Step 7
Remove the five 10mm bolts securing the lower air box tray and remove tray. Set the bolts aside as they will be reused later.

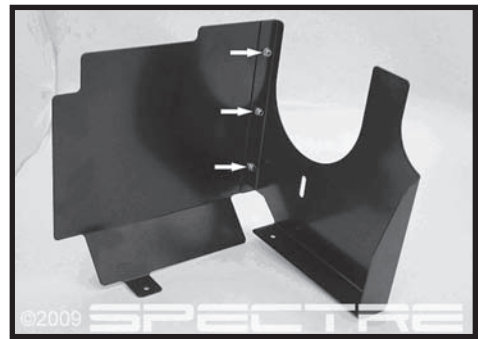

Step 8
Using the included 5mm Allen bolts, lock nuts and washers, assemble the heat shield as shown. Install the Allen bolts from the outside of the shield and put the flat washer and lock nuts on the inside. Once all the hardware is installed, use the included hex key wrench and an 8mm (5/16" will also work) wrench to fully tighten all of the lock nuts. Place the filter shield in the engine compartment. Secure the shield with the air box tray bolts removed in step 7.



Step 9
Place the rubber vibration mount, fender washers and M6 lock nuts on the side of the housing as shown. Do not tighten the bolts at this time.



Step 10
Slide the 4" angled coupler and two 4" hose clamps over the throttle body. Do not tighten the clamps at this time.



Step 11
Place the intake tube in the engine compartment. Slide the lower angled bracket between the vibration mount and the housing.

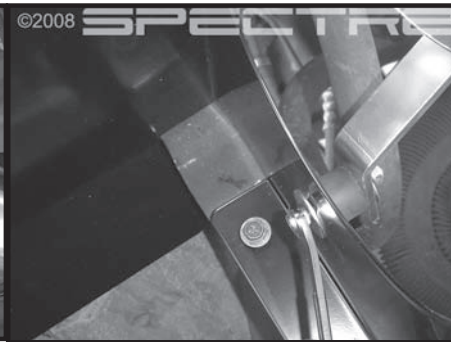

Step 12
Insert the radiator hose bracket into the bracket on the side of the intake tube.

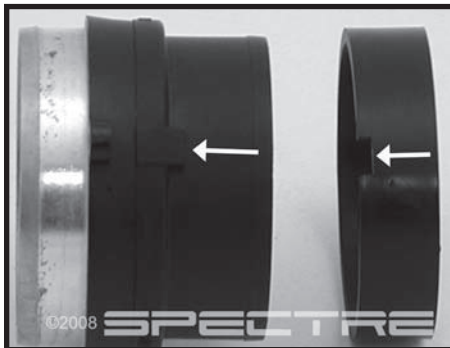

Step 13
Install the adapter ring onto the MAF as shown. Install the 4" coupler over the adapter ring and secure with the supplied hose clamp.

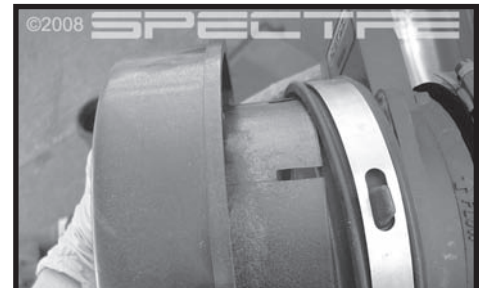

Step 14
Attach the MAF sensor and OE rubber ring to the MAF adapter. Slide the adapter between the rubber ring and the tabs as shown. Secure MAF sensor to the adapter with the OE hose clamp.



Step 15
Carefully insert the air filter over MAF sensor assembly and secure with the provided hose clamps.

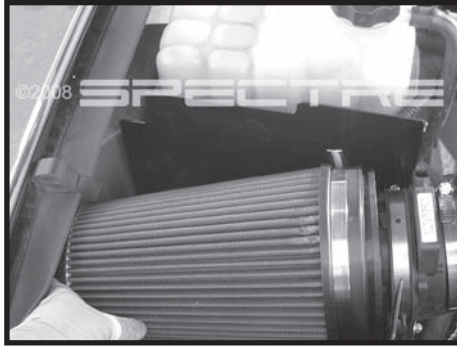

Step 16
Insert the supplied hose clamp over the 4" boot. Install the air filter assembly onto the intake tube. Position the MAF so that the connector points to the wiring harness. Connect the assembly to the intake tube.

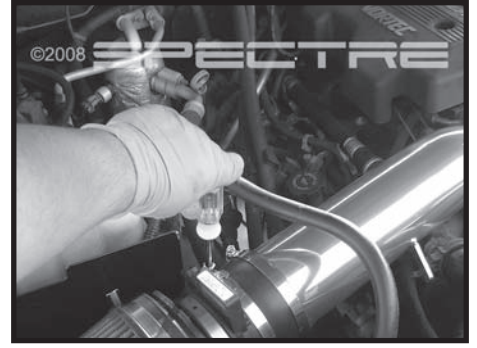

Step 17
Secure the vibration mount and tighten all the hose clamps. Do not over tighten. Reconnect the MAF sensor wiring connector.



Step 18
Gently close the hood and check to make sure the intake assembly does not come in contact with the hood when closed. Make any adjustments if necessary.

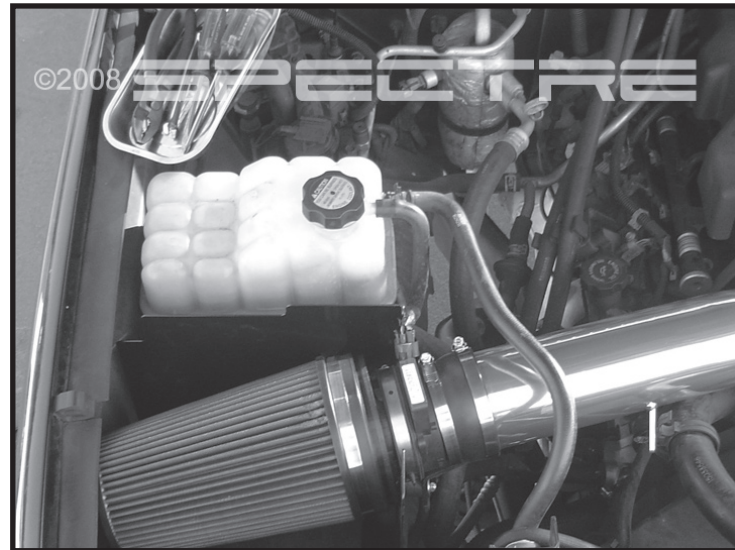

Step 19
Make sure all bolts and clamps are now tight. Reconnect the negative terminal on the battery. Start up the engine and check for any air leaks. Affix the CARB. E.O. sticker in a prominent place under the hood. Your installation is now complete. Periodically check all clamps and brackets. Enjoy your Spectre Intake System.

SPECTRE
Performance