

SPECTRE®

Performance

Intake Installation Instructions

P/N 9004 (red filter) - P/N 9004B (blue filter)
P/N 9004K (black filter) - P/N 9004W (white filter)

Year/Make/Model/Engine

2011-2013 GMC SIERRA 2500HD/3500HD 6.0L
2011-2013 CHEVROLET SILVERADO 2500HD/ 3500HD 6.0L

NOT LEGAL FOR SALE OR USE ON ANY POLLUTION
CONTROLLED MOTOR VEHICLE IN CALIFORNIA OR
STATES ADOPTING CALIFORNIA EMISSION PROCEDURES.

See Spectreperformance.com for CARB status on each part for a specific vehicle



Parts List

- 1- Intake tube
- 1- Heat shield Pc 1
- 1- Heat shield Pc 2
- 1- Air filter
- 1- 4" Offset velocity stack
- 1- 4" Flex coupler
- 3- 4" Wide hose clamps
- 1- 4" Hose clamp
- 1- 6" Hose clamp
- 1- MAFS Sleeve
- 1- 4" 90° Rubber elbow
- 3- Allen bolts, M5
- 3- Flat washers, M5
- 3- Locknuts, M5
- 1- Allen wrench
- 1- Rubber seal
- 1- 3/8" Breather hose
- 2- Machine screws
- 1- Hex bolt, M6
- 1- Flat washer, M6
- 1- Lock washer, M6

Tools Required:

- 5/16" or 8mm nut driver
- 1/4" nut driver
- 10mm socket
- T15 torx
- Phillips screwdriver

For filter reorders ask at the
special order counter of your
local parts store or call:

1-909-673-9800

ask for: P/N HPR9891 (red filter)

P/N HPR9891B (blue filter)

P/N HPR9891K (black filter)

P/N HPR9891W (white filter)



Step 1

Safety first! Before you begin the installation, make sure that the vehicle is in park (or neutral for a manual transmission) with the parking brake set. Disconnect the negative battery terminal and verify that all components that are listed are present. Note: This kit was designed and tested on a stock engine without any custom tuning done to the engine computer. Removing the battery cable may erase the programmed radio stations. The anti-theft code will need to be entered into some radios after the battery cable is connected. The anti-theft code can typically be found in the owner's manual or at your local dealership.

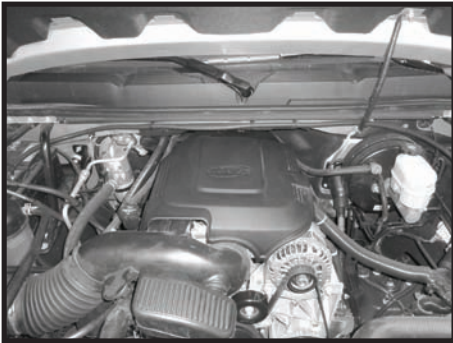

Step 2

Start by removing the engine cover that is attached by small ball and socket joints or fastened with hardware. Lift the cover up and off and it will come off easily. Depending on the year, make, and model the cover may vary.



Step 3

Loosen the clamp at the throttle body.

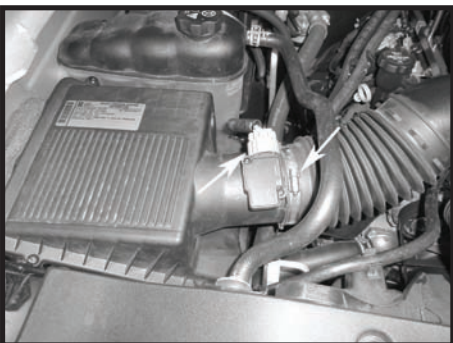

Step 4

Loosen the clamp at the Mass Air Flow Sensor (MAFS). Disconnect the MAFS electrical connector.

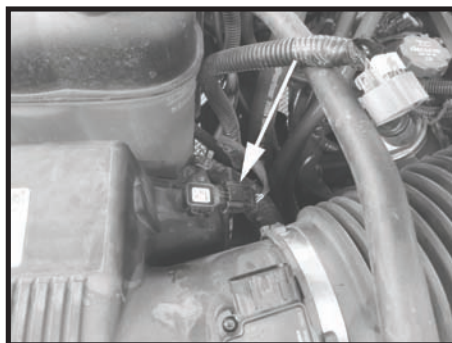

Step 5

Disconnect the pressure sensor connector.

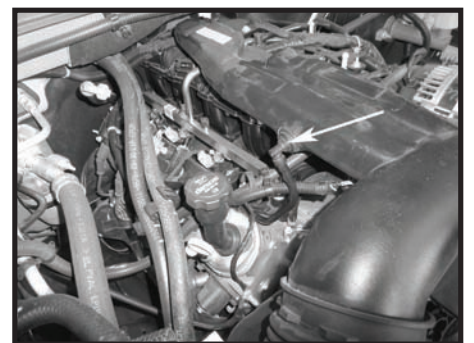

Step 6

Pull firmly and disconnect the breather hose from the stock intake resonator. Remove the factory intake tube.

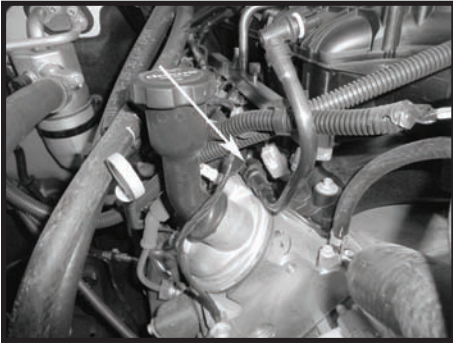

Step 7
Remove the breather tube from the engine. There is a small tab on the end of the tube. Push it to the right to release the breather tube.

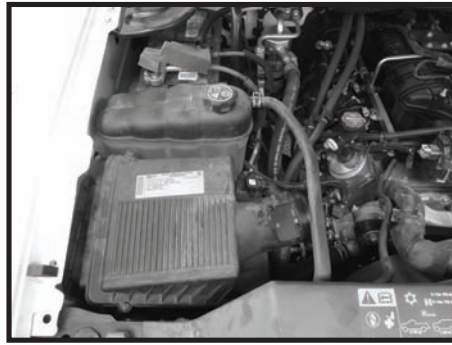

Step 8
Remove the air box assembly by pulling up and out firmly.

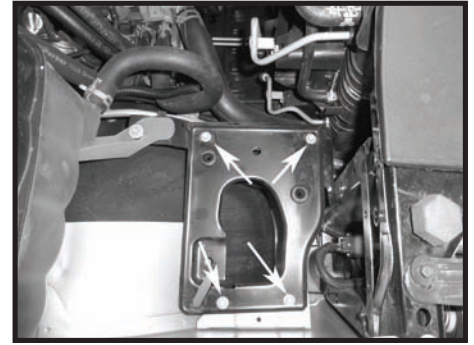

Step 9
Remove the air box mounting plate. Two of these bolts will be re installed with the new heat shield.

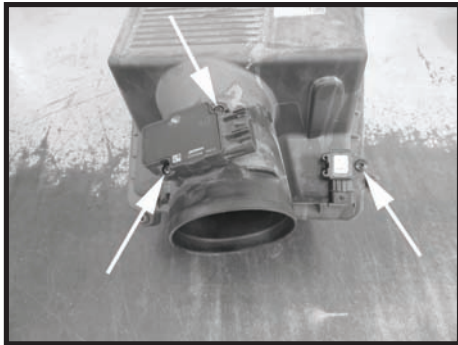

Step 10
Remove the MAFS and the pressure sensor from the factory air box.

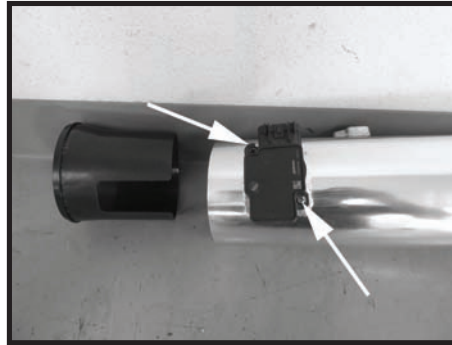

Step 11
Insert and fasten the MAFS onto the Spectre Performance intake tube with the provided machine screws. Insert the MAFS sleeve into the intake tube (note position of slot to allow clearance for the MAFS).

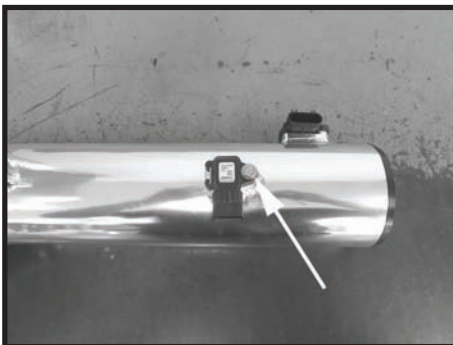

Step 12
Insert and fasten the pressure sensor onto the Spectre Performance intake tube with the provided hardware.



Step 13
Assemble the heat shield with the tabs placed on the outside of heat shield. Install the rubber bulb seal, this may require trimming to the correct length. Place the velocity stack adapter in the heat shield and install the supplied flex coupler making sure the coupler is pushed completely against the heat shield. Take note of the orientation of the funnel, this may be rotated slightly once the filter is installed in the vehicle. Once the adapter and coupler are tight against the heat shield, tighten the clamp.

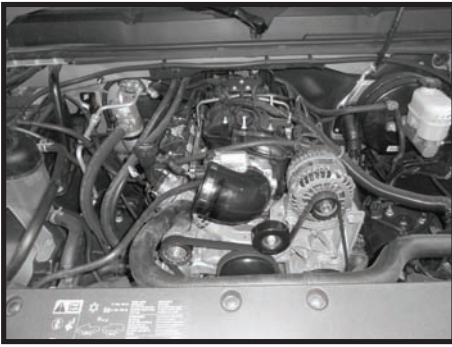

Step 14
Install the 90° boot on throttle body with the short side on the throttle body and clamp on the throttle body side to secure the boot in place. Install a second clamp but do not tighten at this time.

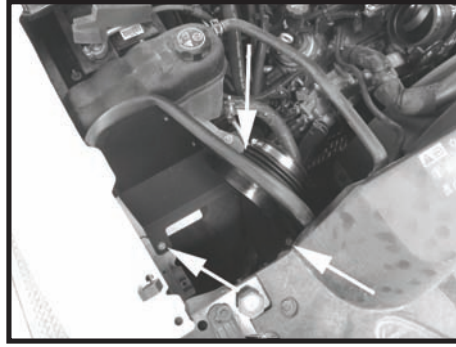

Step 15
Install the heat shield into the truck as shown by reusing the hardware from the tray.

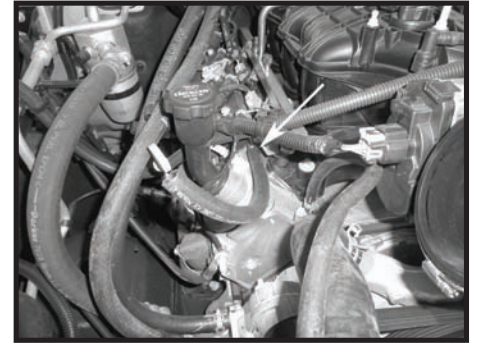

Step 16
Connect the supplied hose to the breather tube on the motor.

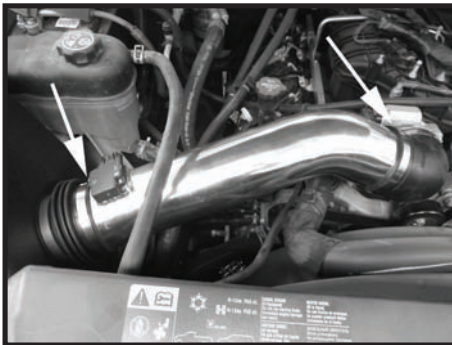

Step 17
Install the intake tube as shown and once in position tighten clamps.



Step 18
Reconnect the MAFS wiring harness and the pressure sensor connector.

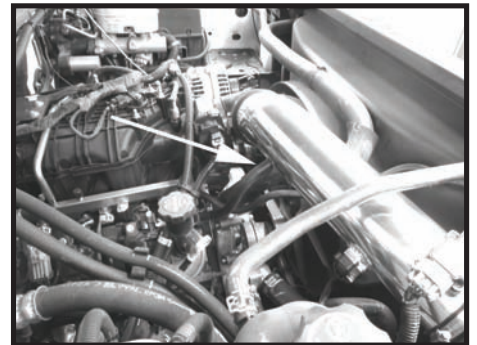

Step 19
Install the new hose onto the vacuum fitting on the intake tube.

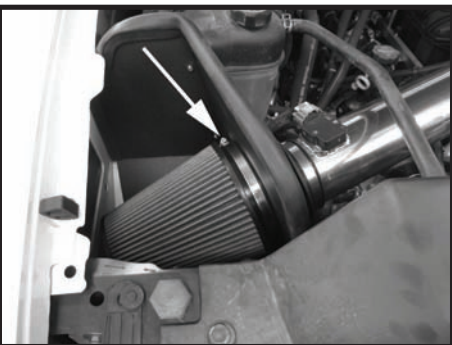

Step 20
Install the filter and fully tighten the clamp.



Step 21
Reinstall the engine cover. Make sure that all clamps and hardware are fully tightened. Reconnect the battery cable, start the vehicle and let it warm up. Shut off and inspect the installation once more for any loose clamps, wires, or hardware. Test drive & enjoy! Your installation is now complete. Periodically check all clamps and brackets.

If you have any difficulties or questions regarding the installation of this intake system, contact the Spectre Performance Technical Department by email - Tech@spectreperformance.com or by phone 1-909-673-9800 Monday thru Friday 6:00am to 2:00pm PST.

NOT LEGAL FOR SALE OR USE ON ANY POLLUTION CONTROLLED MOTOR VEHICLE IN CALIFORNIA OR STATES ADOPTING CALIFORNIA EMISSION PROCEDURES.
See Spectreperformance.com for CARB status on each part for a specific vehicle

SPECTRE
Performance

(909) 673-9800

www.spectreperformance.com

© 2014 SPECTRE PERFORMANCE Made in China

176137
9/8/14