

SPECTRA ***PREMIUM***

Spectra Premium Cooling System **Training Manual**



Complete Radiators • Condensers • Heaters

Table of Contents

1. Radiators

1.1	Cooling System Operation	5
1.2	Cooling System Maintenance and Repair	6
1.3	Components	8
1.4	Radiator Function and Different Types of Radiators	9
1.5	Measuring a Radiator	11
1.6	Oil Coolers	12
1.7	Oil Cooler Leaks	14
1.8	Common Radiator Failures	14
1.9	Diagnosis	16
1.10	Cooling System Testing	16
1.11	Testing procedure for Electrolysis	17
1.12	What Is Covered Under Warranty	17
1.13	What Is Not Covered Under Warranty	19

2. Heater Cores

2.1	Function	29
2.2	Heater Core Types	29
2.3	Common Failures	29
2.4	Diagnosis	30

3 Condensers

3.1	Function	33
3.2	Condenser Types	33
3.3	Diagnosis	35

SPECTRA
PREMIUM

WHY SPECTRA PREMIUM RADIATORS

ARE THE ONLY CHOICE

Radiators

- Full vehicle coverage from 1985-2003.
- All models are validated for fit, form, and function before released into the market.
- Built to meet or exceed all original equipment specifications.
- ISO 9001 certified manufacturing plants.
- All produced models are tested in an endurance simulator in order to ensure that we exceed original equipment standards.

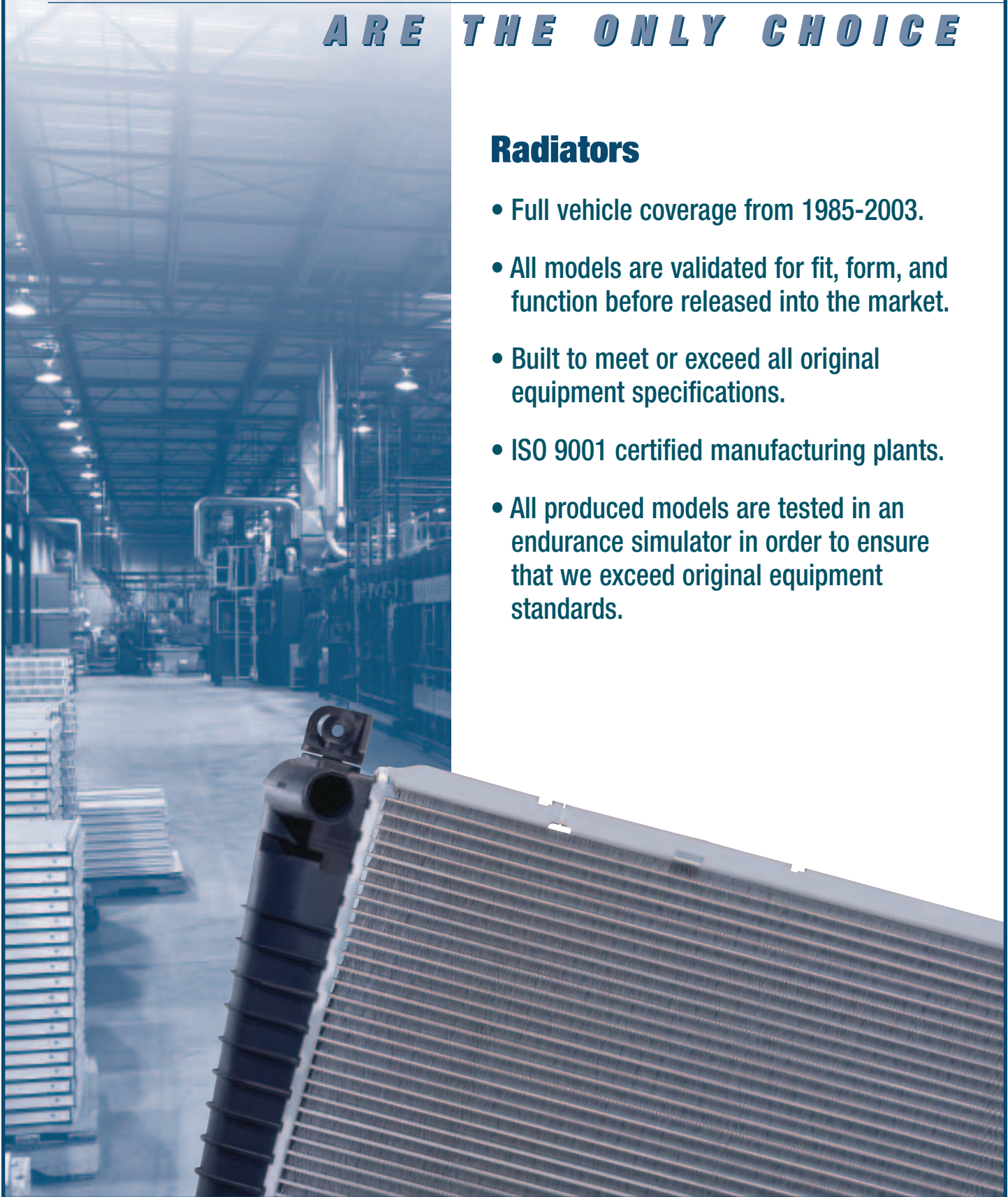

1.1 Cooling System Operation

The main purpose of the cooling system is to absorb excess heat generated by the engine, cool the transmission fluid on automatic transmissions and, on certain applications cool the engine oil as well.

The heat generated by internal combustion within an engine compartment can easily exceed 2000° F/1093° C. During this process, 33% of this heat is used to generate the mechanical energy required to run the engine. Another 33% is lost heat going out of the exhaust system and the last portion is the heat absorbed by the surrounding steel and aluminium of the engine. The temperature that is absorbed by the surrounding steel and aluminum can reach 700° F/371° C which can seriously damage the engine if not properly maintained.

Keep in mind that an engine that runs too cold is as bad as an engine that overheats. An overheating engine can produce temperatures around the combustion chamber (cylinder head) high enough to destroy cylinder heads and gaskets. A cold running engine, caused by a defective thermostat that is stuck open, will prevent the removal of condensation forming in the engine that can oxidize and create sludge build up in the oil pan.

Engine oil is also affected by the cooling system. To properly lubricate the internal engine components, the oil needs to reach an approximate temperature of 190° F; otherwise increased engine wear will occur. Automatic transmission fluid also needs to be cooled in order to maintain the right temperature and avoid damage to gears and other internal components.

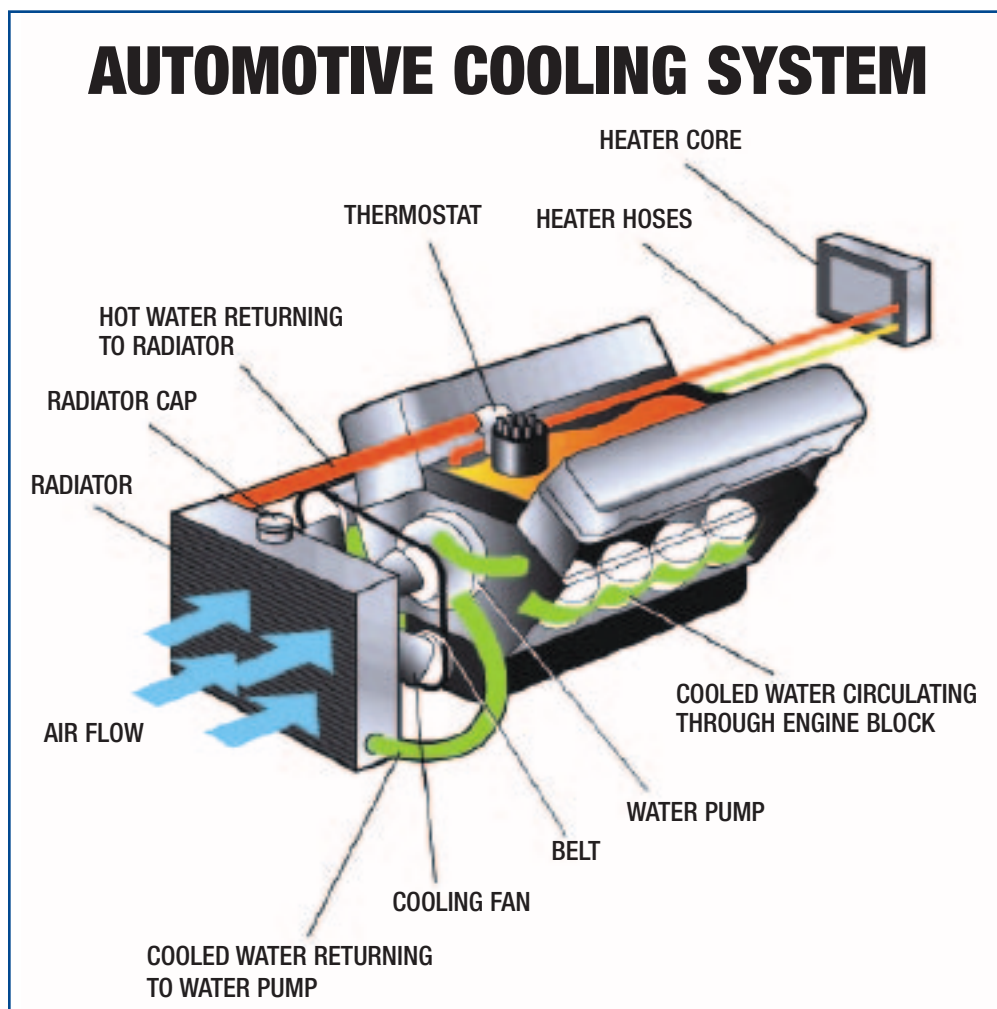

1.2 Cooling System Maintenance and Repair



RADIATOR CAP



THERMOSTAT

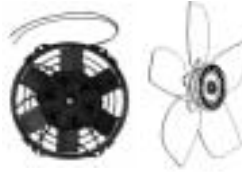

COOLING FANS



AIR DEFLECTORS

When replacing a radiator

Many reasons cause a radiator to fail. Finding the real cause will surely reduce shop comebacks. Here are a few steps that will help prevent comebacks.

- 1- Always ask yourself what caused the radiator to fail.
Check all possible causes for the radiator deterioration.
- 2- Inspect radiator cap with tester.
The radiator cap increases the boiling point of the coolant and ensures a constant level of coolant in the radiator.
- 3- Thoroughly flush the system including the heater core and overflow container.
Any residue in the system may contaminate the new coolant and cause premature failure.
- 4- Install a new thermostat.
Keeping the temperature right is what it's all about... install the right temperature range thermostat.
- 5- Inspect hoses and install new clamps.
- 6- 50/50 mix of antifreeze and clean water (distilled water is recommended if water treatment in the region shows high signs of by-products).
This mix will provide protection against boiling and freezing temperatures while providing maximum corrosion protection.
- 7- Once the work is completed, run the engine long enough for the electric cooling fans to turn on or inspect the mechanical thermal clutch fan for proper engagement.
Cooling fans are crucial for proper system operation and preventing cooling problems at low speeds. For electric cooling fans, see manufacturer specification in the shop manual as most vehicles use the on-board computer via the engine coolant temperature sensor to turn on the fans.
- 8- Ensure the drive belts, specially the one that runs the water pump is tight and in good condition.

ANTIFREEZE CHART

Percent Coolant Mix	Boiling Point at 0 psi in °F	Freezing Point in °F
10	215	+25
20	217	+16
30	219	+4
40	222	-12
50	226	-34
60	231	-62
70	238	-84
80	250	-57
90	272	-33
100	330	-9

1.2 Cooling System Maintenance and Repair (cont'd)

Radiator Cap

The radiator cap is used to control cooling system pressure and coolant recovery. The cap is spring-loaded to the manufacturer specification that varies between 5 and 15 Psi. This pressure is used to increase the boiling point of the coolant and prevent vapor build up around the engine. As vapor is the last step in the change of state for a liquid, vapor cannot absorb anymore heat. Depending where the vapor will be located in the engine (usually on the upper portion, near the cylinder heads where the combustion occurs), this will cause the temperature around those components to rise beyond thermal breakdown. A defective radiator cap can easily damage radiator tanks if system pressure exceeds manufacturer specification.

Thermostat

The thermostat is mounted on the upper part of the engine usually near the cylinder heads. The thermostat incorporates a heat-sensing pellet that will cause the opening of a passage to the radiator. The sensing pellet is filled with wax impregnated of copper that will expand when heated and contract when cooled. When the sensing pellet warms up, it will act on the piston and open the valve that will let the coolant flow to the radiator. When the temperature is below the opening threshold, the thermostat is closed and coolant only circulates in the engine to absorb more heat. Coolant is also directed to the heater core. When the thermostat is opened, hot-soaked coolant will flow through the thermostat to the upper radiator hose and into the radiator. At the same time, cooled liquid that was in the radiator returns to the engine by the lower radiator hose ready to start the cycle over again.

Cooling Fans

The cooling fans are used to force the air through the radiator to accelerate heat exchange and cool the liquid. Cooling fans can be driven directly by the engine or driven by an electric motor. Cooling fans must be inspected on a regular basis and especially during radiator or condenser replacement.

Deflector baffles and Shrouds

Baffles and fan shrouds are designed to insure maximum airflow through the radiator and increasing cooling. Baffles are usually mounted in the front and below the radiator so a ram air effect is created. Missing baffles will cause a portion of the air to by-pass the radiator and reduce cooling. All missing baffles must be replaced. On vehicles with low profile front ends, a lower radiator air deflector will carry the air upwards insures airflow to the radiator. If the air deflector is missing, overheat condition will occur at speeds over 30 mph (50kmh).

Water Pump

The water is used to circulate coolant in the system. The coolant is circulated around the cylinder's water jackets and heater core. When the coolant has reached a certain temperature, the water pump will push the coolant into the radiator where it will be cooled and returned to the engine. The water pump depends on the antifreeze ability to lubricate the seals and extend pump life. Corrosion in the system, will breakdown the water pump metallic impellers and reduce coolant circulation in the system.

Coolant

Coolant must be replaced at recommended intervals. A 50/50 mix of water and antifreeze will insure maximum system protection against freezing and overheating conditions. When a cooling system is serviced, a thorough cleaning of the system is imperative. Any traces of old coolant in the system can reduce corrosion inhibitor ability to protect the new replacement components. Test coolant pH level and electrolysis during regular vehicle maintenance.

1.3 Radiator Components

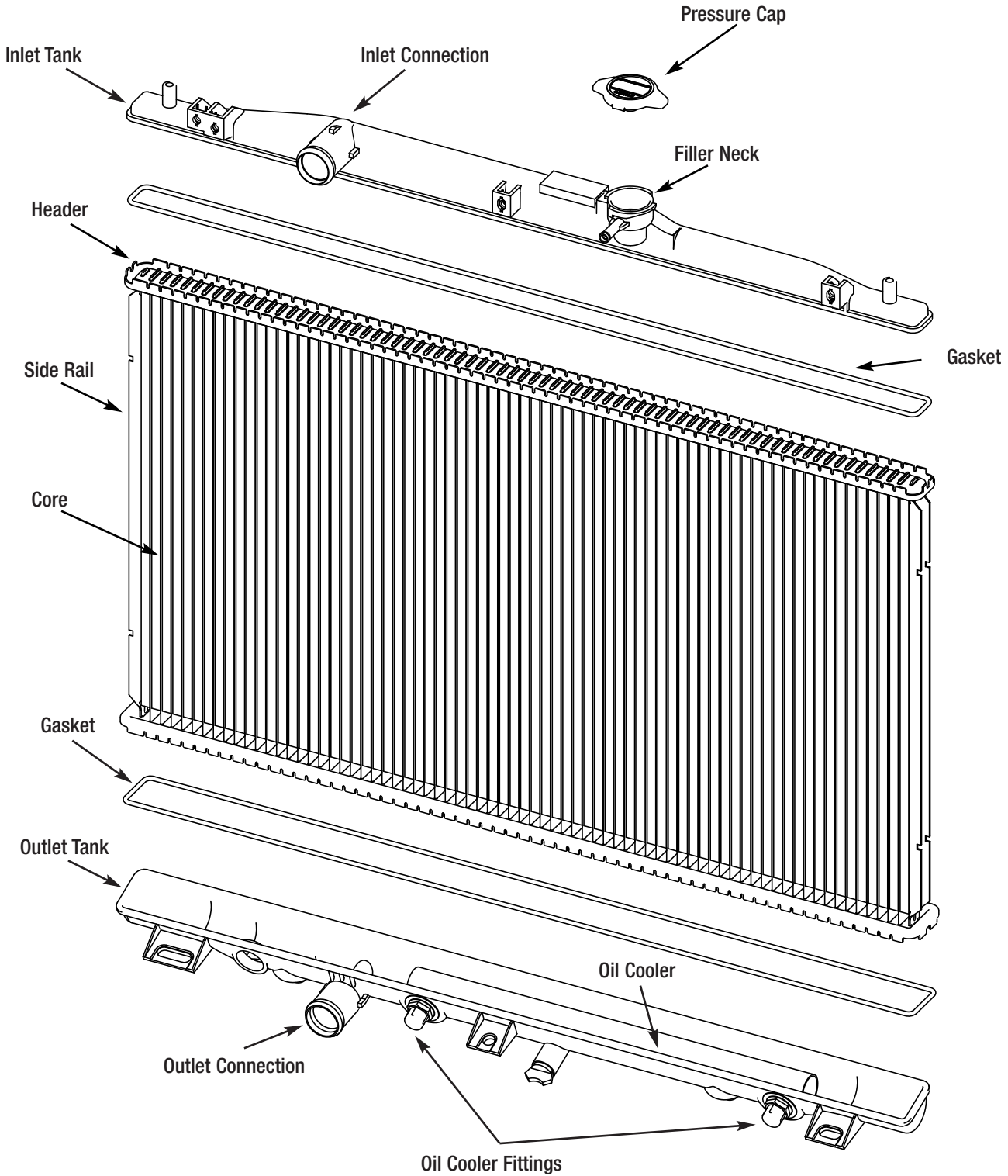

1.4 Radiator Function and Types of Radiators

Radiator Function

The radiator is the heart of the cooling system. It is positioned in front of the engine in order to have access to the air flow and the most ambient air possible. Radiators are made of tubes and fins; all have an inlet and outlet tank. Hot coolant goes through the inlet and comes out the outlet tank at a lower temperature. This is due to the engine coolant running through its tubes. The radiator fins then absorb the heat, which, in turn, transfer it to the ambient air.

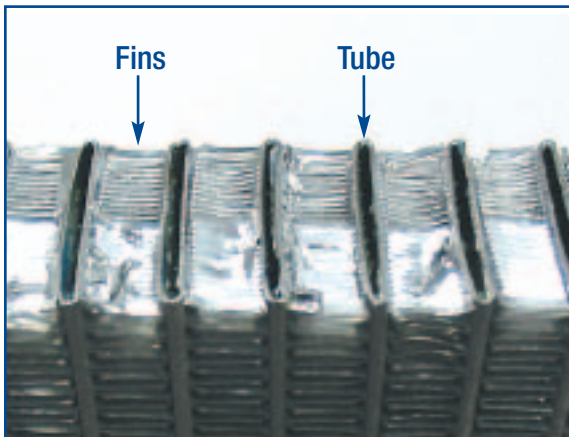

Types of Radiators

Although radiators come in many shapes and sizes, they share similar characteristics.

On today's vehicles, you will find four possible radiator constructions. The first is copper brass. In this construction, the fins are made of copper and the inlet outlet tanks are made of brass. These brass tanks are soldered to the header of the core.

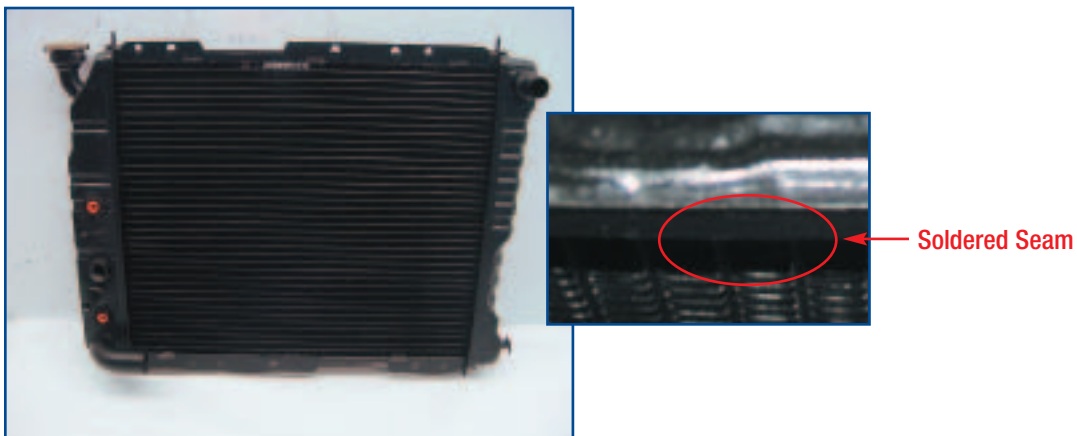

Illustration of a Copper Brass Radiator

1.4 Radiator Function and Types of Radiators (cont'd)

Second there is the plastic copper in which the fins are made of copper, but the inlet outlet tanks are plastic and crimped to the core with a gasket.



← Tab header crimped seam

Copper Plastic Radiator

The third type is plastic aluminum, found in 90% of today's new production vehicles. The core is all aluminum but also uses the plastic tanks crimped to the header plate.



← Crimped seam

Plastic Aluminium Radiator

Last, the latest addition to the radiator family is an all-aluminum radiator, which car manufacturers are using in some new applications. This construction is commonly used in the racing industry since, in addition to providing high-performance heat transfer, it is reliable and lightweight.



← Soldered Seam

All-Aluminum Radiator

1.5 Measuring a Radiator

The tubes of a radiator are always mounted parallel to the fins and perpendicular to the inlet/outlet tanks. Measuring a radiator is very simple but, certain rules apply. The first measurement is always the height (A) which is always taken in the same direction of the tubes. Second the width (B) is always measured in between the side plates. Last, core thickness (C) is measured.

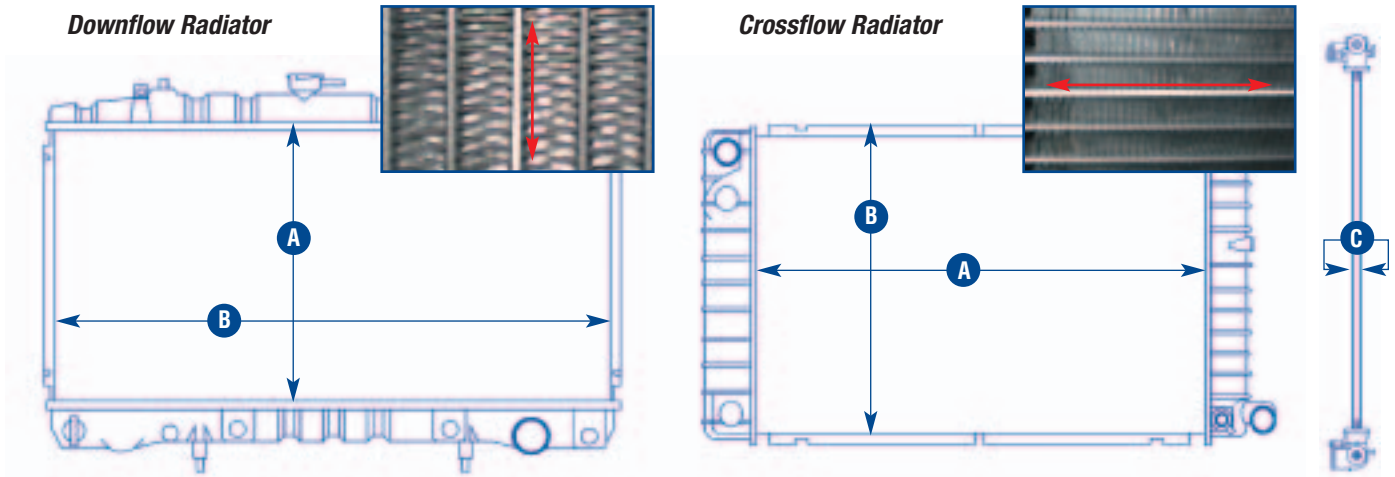

For both types of radiators: A = Height / B = Width / C = Core Thickness

It is very important to note that the core thickness will differ from one radiator to another but, can still provide the same cooling capabilities. There are many examples of possible tube sizes based on the combination of the number of rows used.

For example, in the case of copper brass radiators versus aluminum radiators, copper brass radiators will have tube sizes ranging from 3/8" to 3/4" in diameter and can have up to four rows.

An aluminum radiator will have one to two rows of tubes, which can be from 5/8" (16 mm) to 1 9/16" (39 mm) in diameter.



Two Rows of 1/2" Tubes



One Row (26 mm) Aluminum

1.5 Measuring a Radiator (cont'd)

In order to make sure the cooling capacity remains the same, manufacturers reduce the distance between tubes to make radiators with a higher tube count. This is called the "tube pitch" Manufacturers will also use more fins per inch to compensate for the heat transfer loss. This is done for two reasons; One is the limited amount of space available under the hood with today's engine configurations, and two is that this construction is cost effective.

On some models you will find a two row copper brass radiator of 1/2" tubes which can be replaced with either one row of 1" (26 mm) or 1 1/4" (32 mm) which will cool more efficiently than the two-row model. In this case, the tube pitch will be closer and, instead of having 12 or 13 fins per inch, there will be 16 to 20 fins per inch. The higher number of tubes due to tube pitch will increase the coolant flow through the radiator. As well, the number of fins increases the radiator's ability to dissipate the heat.



High-Fin Density Core
(Approx. 17 fins per inch)

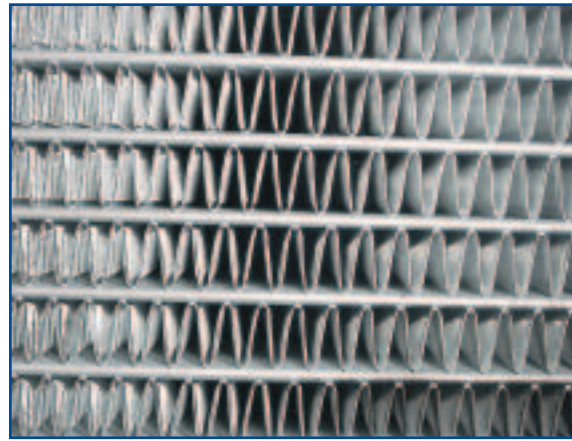

Low-Fin Density Core
(Approx. 12 fins per inch)

1.6 Oil Coolers

Today every vehicle equipped with automatic transmission requires a transmission oil cooler. Most of the time the cooler is located inside the radiator inlet or outlet tanks.

An automatic transmission tends to heat up very quickly and, if the specified temperature is not maintained, internal damage to the gears will occur. The automotive transmission fluid flows through the cooler so its heat can be absorbed by the engine coolant and released through the radiator.



Concentric Coolers

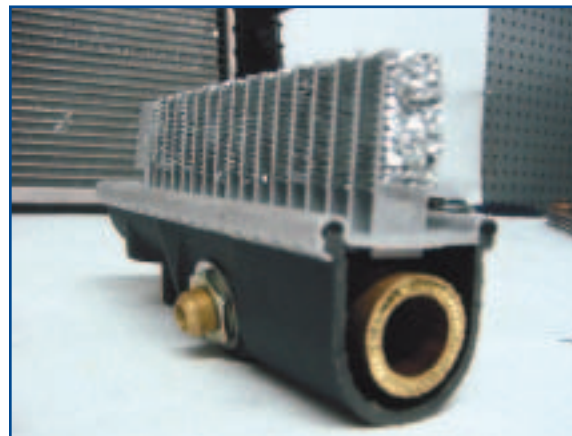

Cutaway View of a Concentric Cooler

1.6 Oil Coolers (cont'd)

Although the cooling system works to absorb excessive heat created by the engine via the radiator, for some cars or light trucks this is not enough, so engine oil is also cooled in a separate engine oil cooler, which operates similarly to the transmission cooler.

There are many types and configurations used for oil coolers. The two most commonly used are concentric oil coolers, which have a circular shape, and plated oil coolers.



View of a Plated Cooler

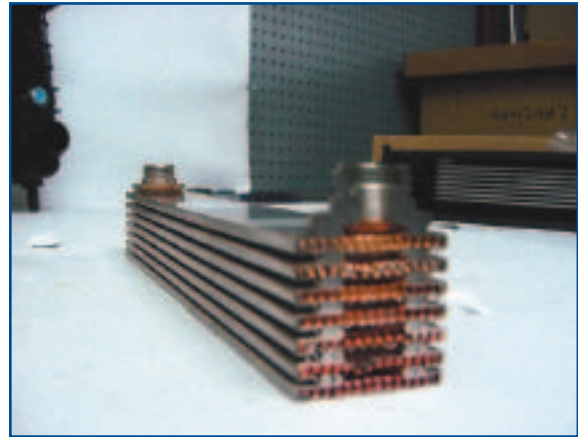

Cutaway View of a Plated Cooler

Plated coolers can come with a different number of plates, stacked one on top of the other. This configuration allows the unit to cool a greater amount of oil per minute. The greater the amount of plates found in the plated oil cooler, the greater the cooling capacity of the cooler.

Most imports only use automatic transmission oil coolers and no engine oil coolers. The concentric oil cooler is the most popular. Current Ford, Chrysler and GM models mostly use plated coolers for both transmission and engine oil.

There are many different oil cooler fitting sizes, which serve as ports of entry to the transmission and engine lines. Some simply come with hose barb fittings; others come with Imperial or metric fittings and will differ in thread size.

For example, on most GM models, the transmission oil coolers will come with either a 5/16 or 3/8 NPT (National Pipe Thread) fitting. This is why most radiators come with a variety of brass adapters so that the technician can select the size required for the application.

When servicing a new radiator, it is very important to respect the type of oil cooler being used by the OEM manufacturer; for example, always replace a concentric cooler with a concentric cooler. If a plated cooler is used, the number of plates must be the same as OEM.



Various Fittings Types That Can Come with a Cooler

1.7 Oil Coolers Leaks

The most common oil cooler leaks occur from the brazed joints and fittings, and are normally due to solder fatigue located at the extremity of the cooler. A leak from the fitting is also possible. In most cases, this means the line was not properly installed. An oil cooler leak has occurred if the engine coolant turns into a milky pink colour.

Whatever the case, when this occurs, it is imperative that the radiator be replaced and the cooling system and transmission be completely flushed.

When this problem is not treated immediately, the mixture of coolant and transmission oil will create a chemical reaction that will damage all internal parts of the transmission.

1.8 Common Radiator Failures



Example of poor crimping



Example of a bad end crimp

There are many types of radiator failures. The most common cause of failure for copper brass radiators is seam leaks. Seam leaks will occur between the header and the inlet or outlet tanks. Very often these types of radiators will also leak from the solder joint of the inlet or outlet connection, primarily due to solder fatigue or corrosion of the solder joint. Poorly inhibited coolant will cause seam leaks, since it will slowly corrode the inside of the solder joint.

On plastic aluminum radiators, seam leaks will occur from poor crimping or a weakened gasket.

In the case of gasket leaks, many failures occur due to the weakening or breaking down of the gasket material, which, in most cases, is caused by the constant change in operating temperatures in the vehicle over time.

Special attention is required when a radiator seam and tank are blown. A blown tank is evident because the base of the tank will be off its original seating. In the case of a plastic tank radiator, the gasket will be out of its original seating. Although a blown tank can be caused by restricted flow in the radiator, it can also be related to the vehicle itself when there is excessive pressure in the system. When these conditions are seen, further investigation into the problem is required, such as the inspection of:

- 1) Cylinder head gasket leak
- 2) Faulty radiator cap
- 3) Debris restricting flow in radiator

1.8 Common Radiator Failures (cont'd)

Another radiator failure results from fin deterioration, which is caused by road salt or seawater. Salt will literally eat away at the fins of the radiator core, leaving the tubes with no support and potentially producing leaks in the tube joint. In this condition, the radiator also loses its ability to dissipate heat, resulting in overheating.

A visual inspection of the radiator can very easily diagnose this problem. Further, by running your fingers along the fins of the radiator, you will detect the problem. Deteriorated fins will easily crumble to pieces if a person runs his fingers through them (Be sure to perform this test when the radiator is cool). This is one of the most common failures for copper brass radiators.

"This quick inspection should be carried out each time a vehicle is serviced."



Blown Tank Seam



Blown Seam on a Plastic Aluminum Radiator



Illustration of Fin Deterioration

1.9 Diagnosis

When a customer complains about an overheating engine or that the heater is not working, it is important to properly diagnose the problem.

When a customer states that the engine is overheating, there are many things to look for. The obvious component to look at is the radiator. Is it leaking? Are the fins in good shape? Are there debris restricting airflow through the radiator? If the car has A/C, are there leaves or debris blocking the condenser and preventing the airflow?

If the radiator is leaking it is important to determine the root cause of the leak. Is it wear and tear that led to solder fatigue? Are the tanks blown off their seams? Did a rock or road debris, puncture the tubes? Did contaminated coolant, which was never changed, slowly eroded the seams?

If the radiator is aluminum and is leaking from its tubes, could it be suffering from electrolysis? (See examples of electrolysis under failure in the warranty section.)

If the radiator has been ruled out but is still overheating, there are other probable causes. Is the thermostat working? Are the inlet outlet hoses bloated? If so, it could be a sign of a head gasket leak. The next section explains how to test the cooling system for leaks. It is important to check the belts on the water pump pulley and see whether they are tight enough to ensure proper coolant flow.

It could also be bad coolant or an incorrect mixture. If in doubt, flush the whole system and fill with new coolant using the mixture ratio specified by the manufacturer.

WARNING: When testing or servicing, proceed with extreme caution. Hot coolant and moving parts can cause bodily harm. Never open a radiator cap until the vehicle's engine is cooled completely.

1.10 Cooling System Testing

A cooling system tester is an important tool to have. It is inexpensive and easy to use. The tester consists of a manual pump attached to a pressure gauge, with filler neck adapters to fit all types of radiators. It is used to determine any possible leaks throughout the cooling system.

Simply pump the pressure to the specified pressure that the system is designed to hold. Let the pressure hold for at least 30 minutes and see whether if there is a pressure drop in the system.

Note that some applications have a freeze plug behind the flywheel. If that plug leaks, it may go unnoticed and inaccurate pressure reading will result.



Illustration of Cooling System Tester

1.11 Testing Procedure for Electrolysis

Electrolysis is a stray current caused by a bad ground from one of the car's accessories. Electrolysis occurs when electrical current routes itself through the engine's coolant in search of an electrical ground. The most common causes are poor grounding of the system's electrical fan or bad grounding of the starter motor. However, any accessory bolted to the radiator support, or nearby component, is also a good candidate for electrolysis.

If there are concerns that the radiator leak is due to electrolysis, there are simple ways to confirm this suspicion. Using a digital volt-ohms meter (DVOM) set to DC volts, with the engine off, hook the negative lead from the meter to the negative post of the battery. Submerge the positive lead of the meter in the coolant, touching only coolant. If the lead touches any metal part of the radiator or overflow container, the reading will be incorrect. Check the readings with the engine off. Start the engine, take the readings while cranking and then while running. Any voltage higher than 0.3 volt will accelerate the deterioration of an aluminum radiator or heater core. To find the source of a bad ground, turn on all the car's accessories then turn them off one by one while taking your reading each time. When the voltmeter falls to zero, the last accessory turned off is the one causing the condition.

1.12 What Is Covered Under Warranty

Since warranties are sometimes hard to understand, it is important to be clear on what is covered and what is not.

A warranty return is valid only when there has been premature failure of the part itself or its components due to a manufacturing process.

Here are a few examples of what is covered under warranty:

Oily residue shows signs of a leak



Tank Seam Leak due to a bad crimp or faulty gasket

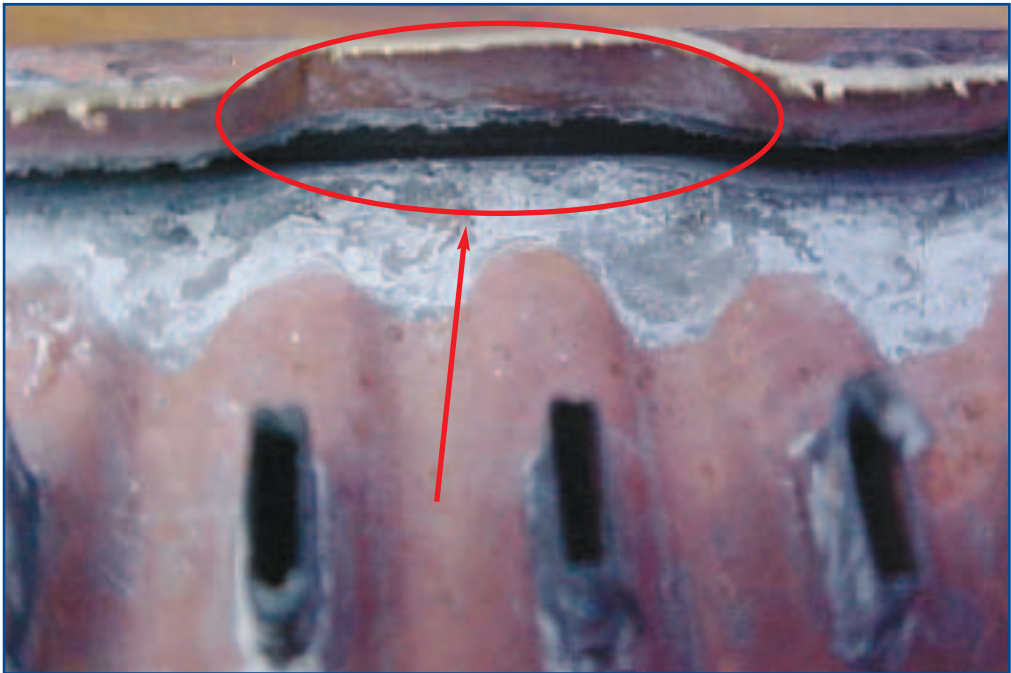

Premature seam failure



Loose or broken connection due to bad soldering

1.13 What Is Not Covered Under Warranty

The warranty does not cover any damages caused by mishandling or poor maintenance of the part.

Failures due to road debris, like rocks, are not covered. Many failures due to poor maintenance are also not covered, such as contaminated coolant or cooling system component failure. Here are several examples not covered under warranty:

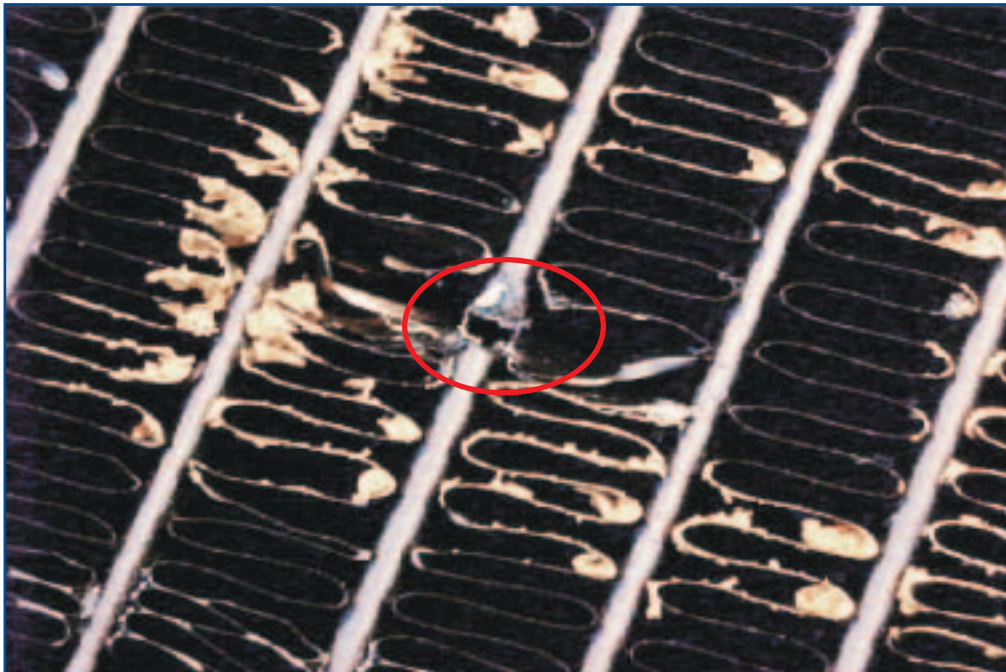

Punctured tube from rock or road debris



Steam erosion from excessive steam buildup

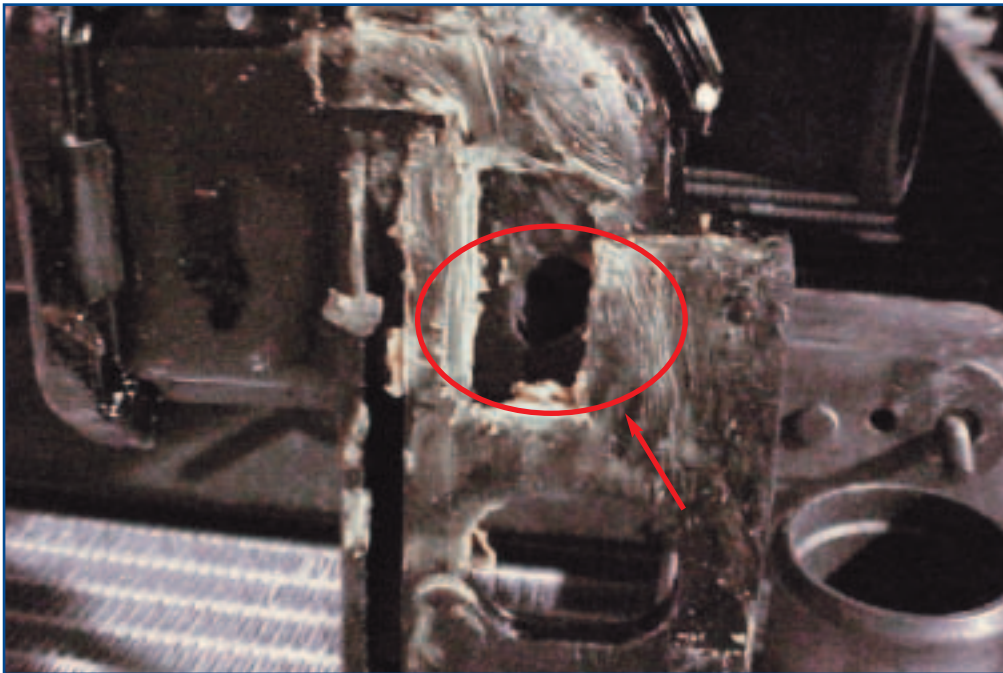

Drilled hole during installation



Solder bloom resulting of contaminated coolant, which creates restricted flow within the radiator



Additives used to stop leakes render warranties null and void

Electrolysis

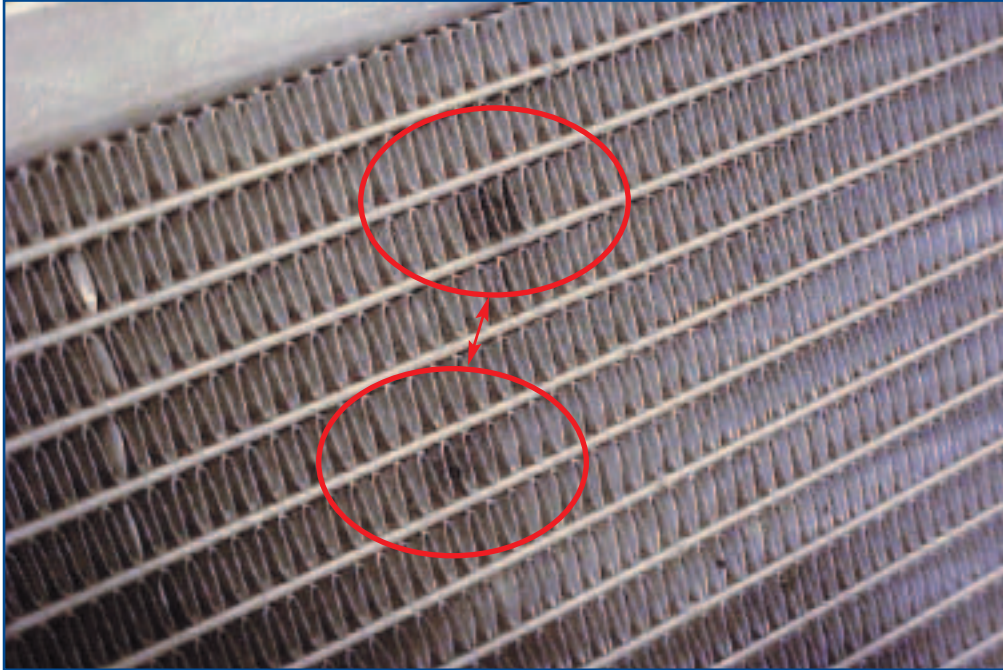

Black spots in the illustration above shows signs of electrolysis

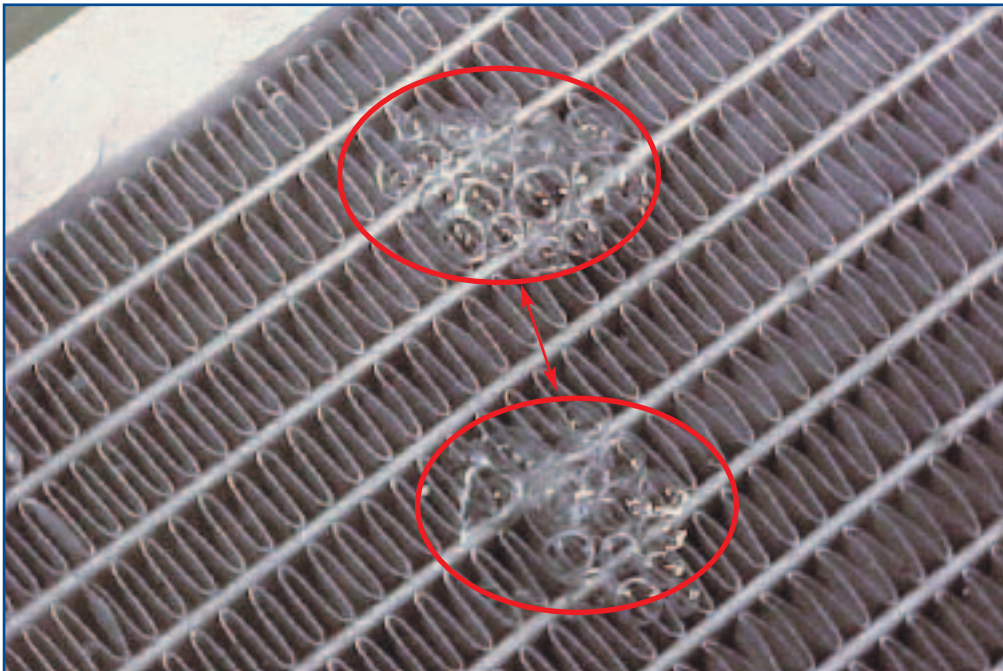
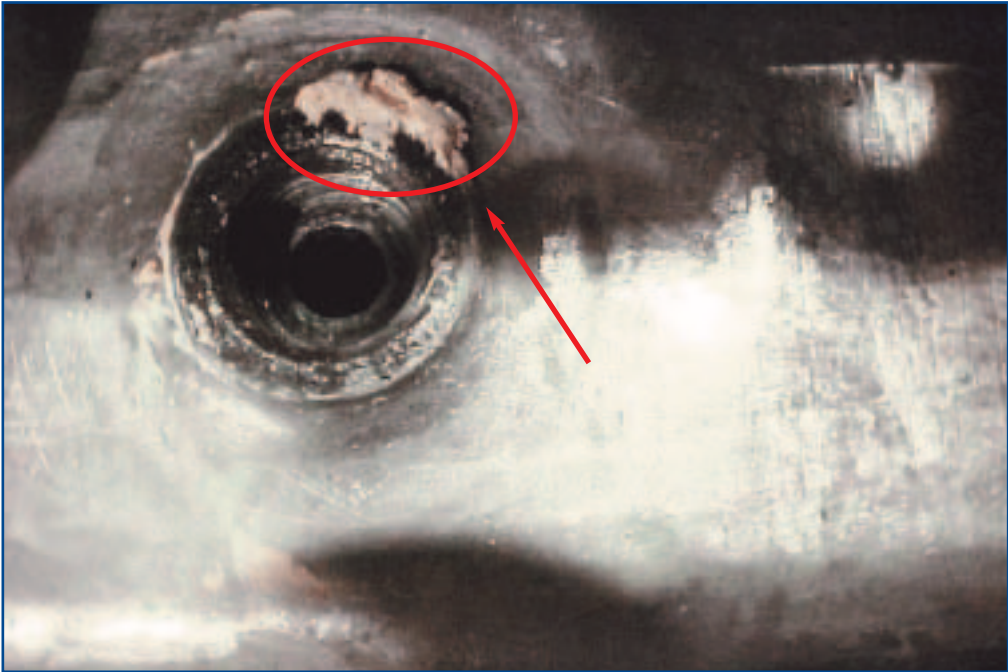
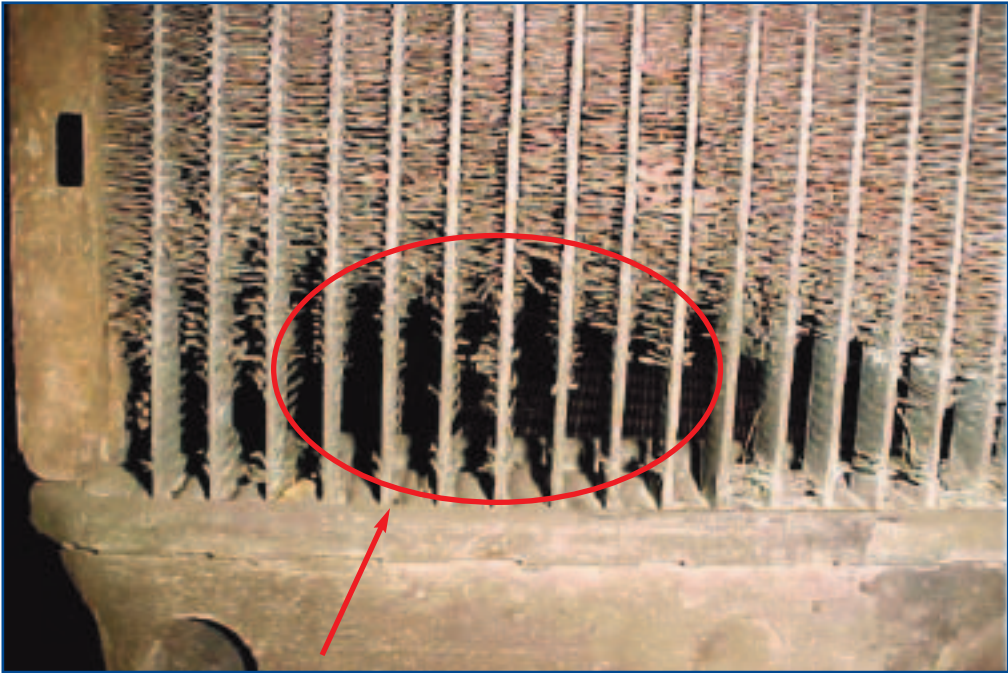

Illustration above shows tube leaks caused by electrolysis



Attempted repair



Fin deterioration

Excessive System Pressure

Crushed fins
show evidence
of over pressure

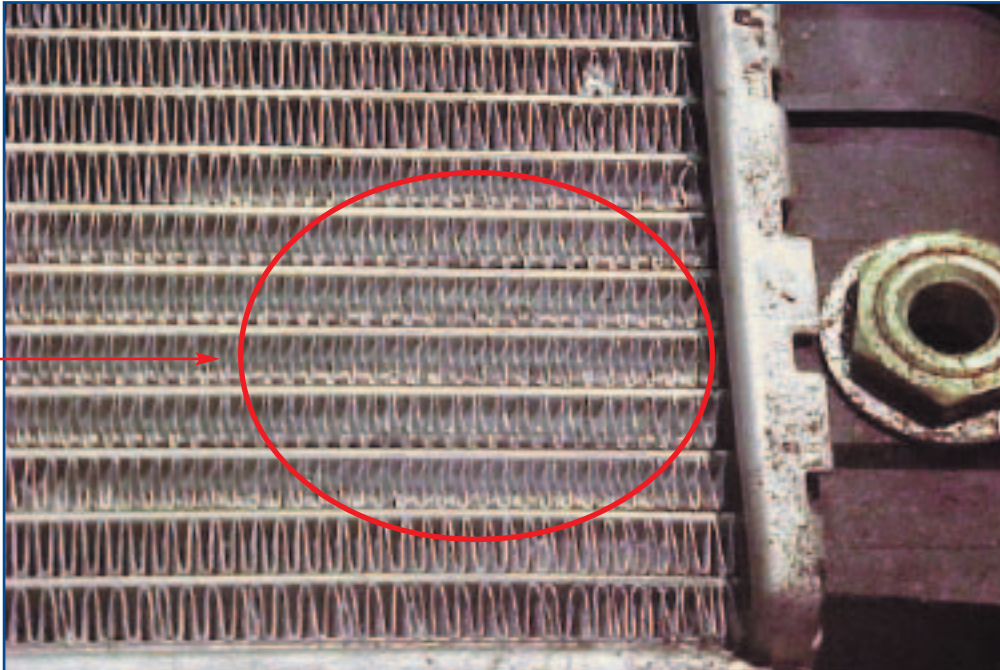

Crushed fins caused by tube swelling

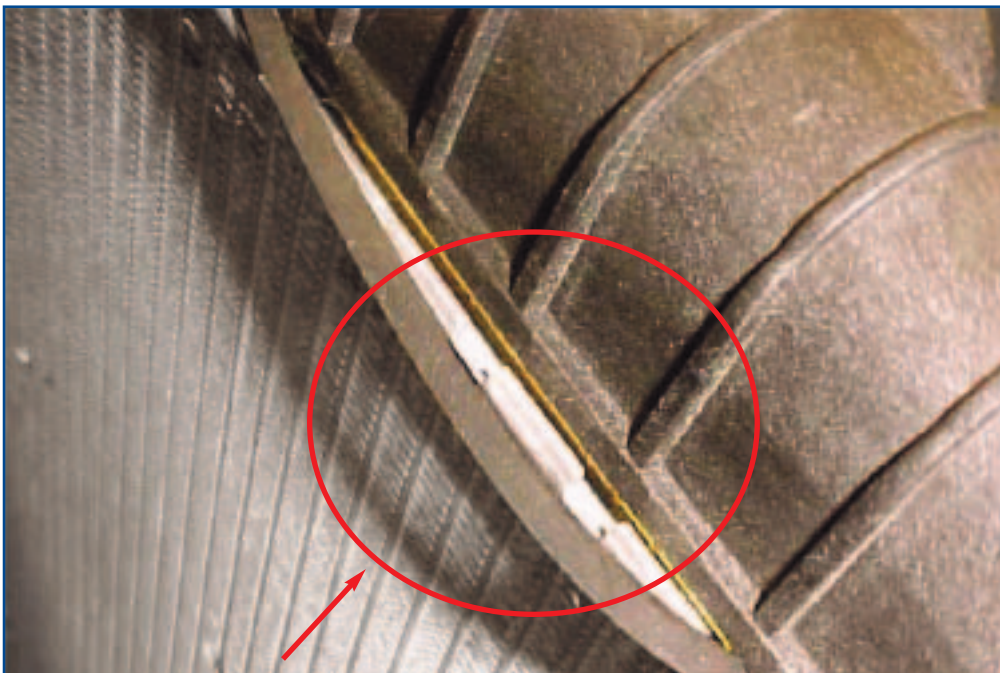

Blown gasket seam caused by excessive pressure



Stripped oil cooler threads

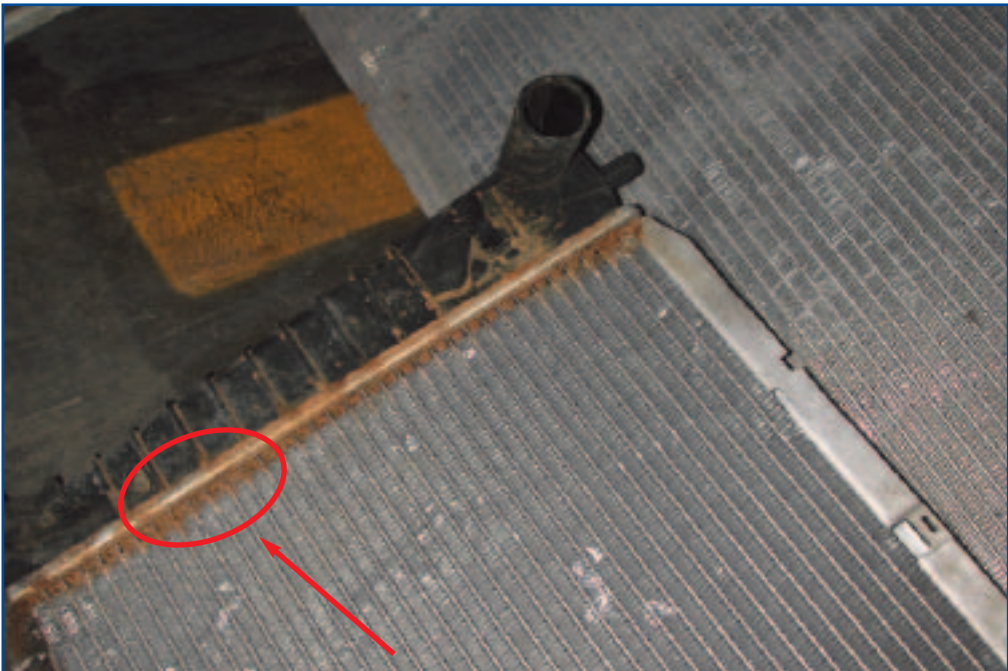

Eroded tube to header joint due to coolant contamination

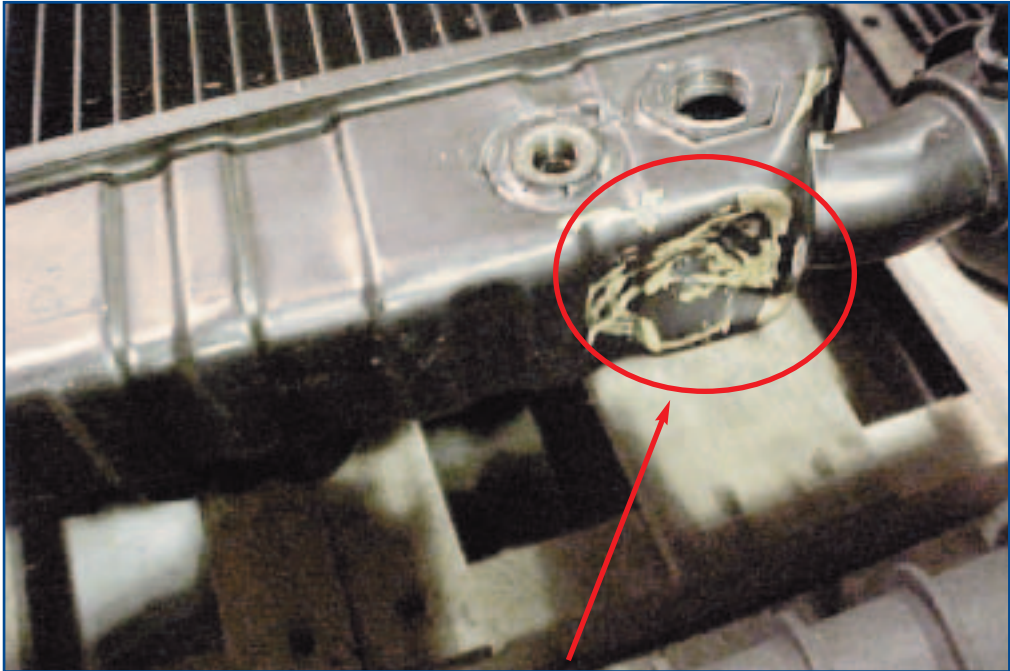

Damage due to shipping or handling

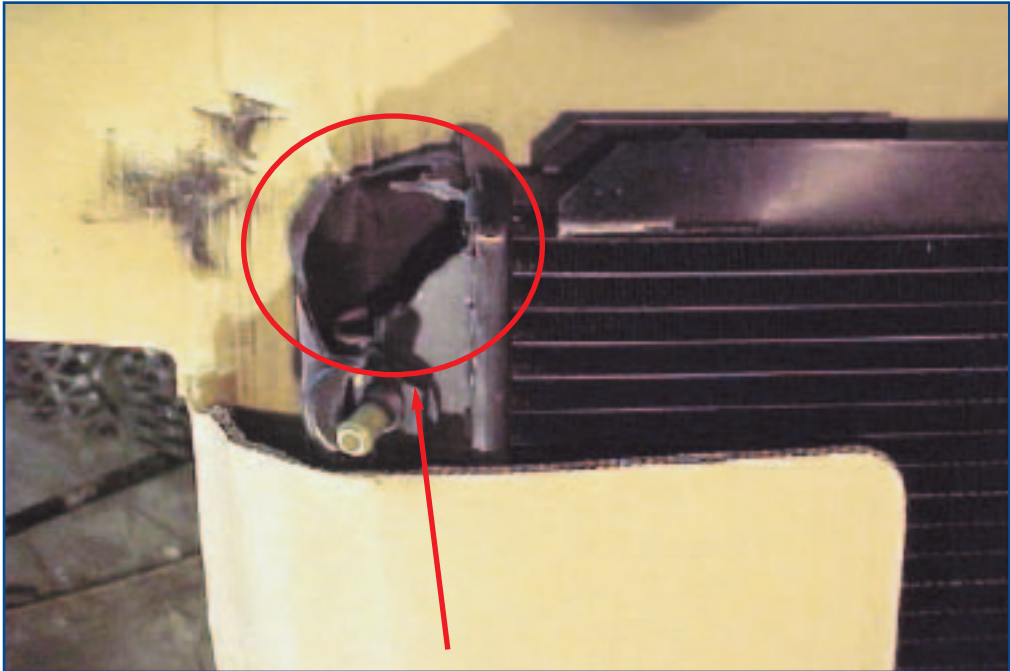

Damage due to shipping or handling

SPECTRA
PREMIUM

WHY SPECTRA PREMIUM HEATERS

ARE THE ONLY CHOICE

Heaters

- Built to meet or exceed all original equipment specifications.
- Designed for exact fit in the vehicle's original equipment heater casing.
- All heater cores are 100% leak tested.
- State of the art manufacturing equipment.
- Only the highest grades of materials are used in our production to ensure product longevity.
- Original equipment quality at a very competitive price.



2.0 Heater Cores

2.1 Function

Heater cores are like miniature radiators. They are located inside the dash of the vehicle next to the A/C evaporator. Their function is to supply heat to the passenger compartment, using heat created by the engine. Hot coolant flows through the heater core to provide enough heat to warm the passenger compartment. It uses a blower motor that pushes the heat into the vehicles ventilation system.

2.2 Heater Core Types

Many late model cars and trucks are equipped with complete aluminum heater cores. Older applications mostly use a copper brass heater core. On some applications, the heater core may consist of an aluminum core with plastic tanks and inlet/outlet tubes. Very often, these tubes will end up broken or damaged due to road vibrations or careless hose removal. To help reduce these problems, many OEM manufacturers are using all-aluminum heater cores with aluminum inlet/outlet tanks.



All-Aluminum Heater



Plastic Aluminum Heater

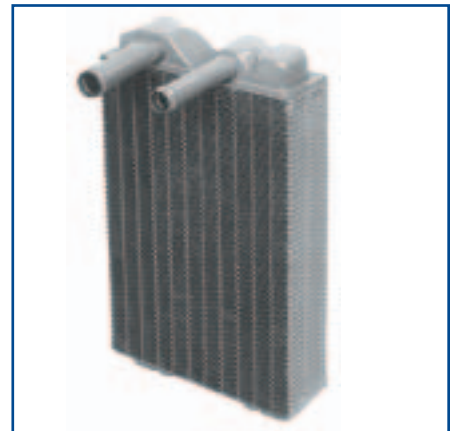

Copper Brass Heater

2.3 Common Failures

Most heater core failures include internal erosion, solder fatigue and corrosion. Electrolysis is fast becoming one of the most frequent failures for aluminum heater cores, causing the alloy in the metal to deteriorate (see examples under failure in the “what is not covered under warranty”).

Another cause of failure is clogging. Clogging occurs mainly because of debris due to corrosion particles circulating in the system. When servicing the cooling system, always flush all components and the system before adding new coolant.

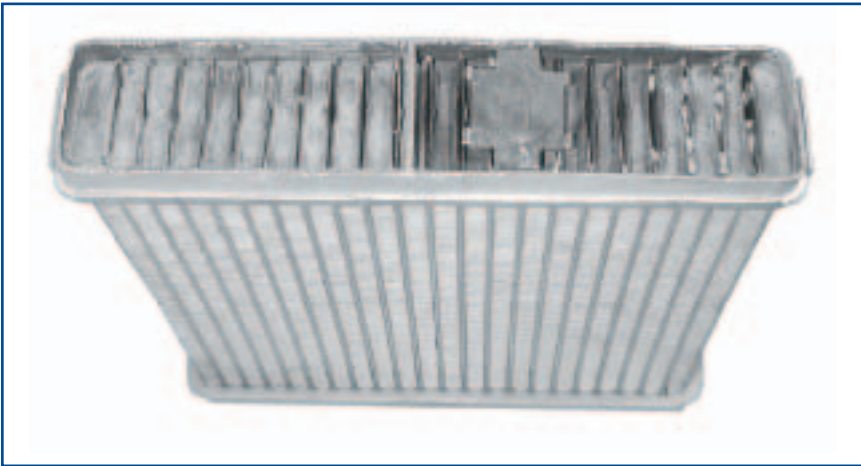

Example of a Clogged Heater Core from Coolant Debris

2.4 Diagnosis

If there is no heat detected in the car, there is a good chance the heater core is not functioning properly. A quick way to check is to examine the inlet outlet hoses. If there is one much warmer than the other, then the heater core could be clogged. The heater valve could also be the problem if it is not operating correctly with the control lever. The doors in the system could be shut closed, preventing the coolant to flow through the heater core.

Like a radiator, a heater core has very similar leakage failures. A leaking heater core will always give off a sweet smelling odor from the passenger vents and will most likely produce fog on the inside of the windshield. Leaks will probably occur at the bottom of the front passenger area.

The coolant mixture could also be a probable cause. Since the coolant mixture is what determines the boiling point, lowering the boiling-point temperature does not help in providing sufficient heat. If in doubt, flush the system completely and fill it with new coolant using the suggested mixture.

If these steps have been followed and there still is no heat from the heater, there is probably air in the system affecting the boiling point. There could be a bleeder valve in the vehicle. Refer to the shop manual of the vehicle to make sure. The bleeder valve is usually mounted close to the thermostat. To bleed the system, loosen the bleeder valve and run the engine until coolant drips out of the valve. This will ensure that there is no more air in the system.

WHY SPECTRA PREMIUM CONDENSERS

ARE THE ONLY CHOICE

A/C Condensers

- Built to meet or exceed all original equipment cooling specifications.
- All models are supplied in the same construction style of the Original equipment manufacturer.
- QS9000/ISO9001 manufacturers supply all A/C Condensers.
- Drop in fit for easy installation.
- Original equipment quality at a very competitive price.

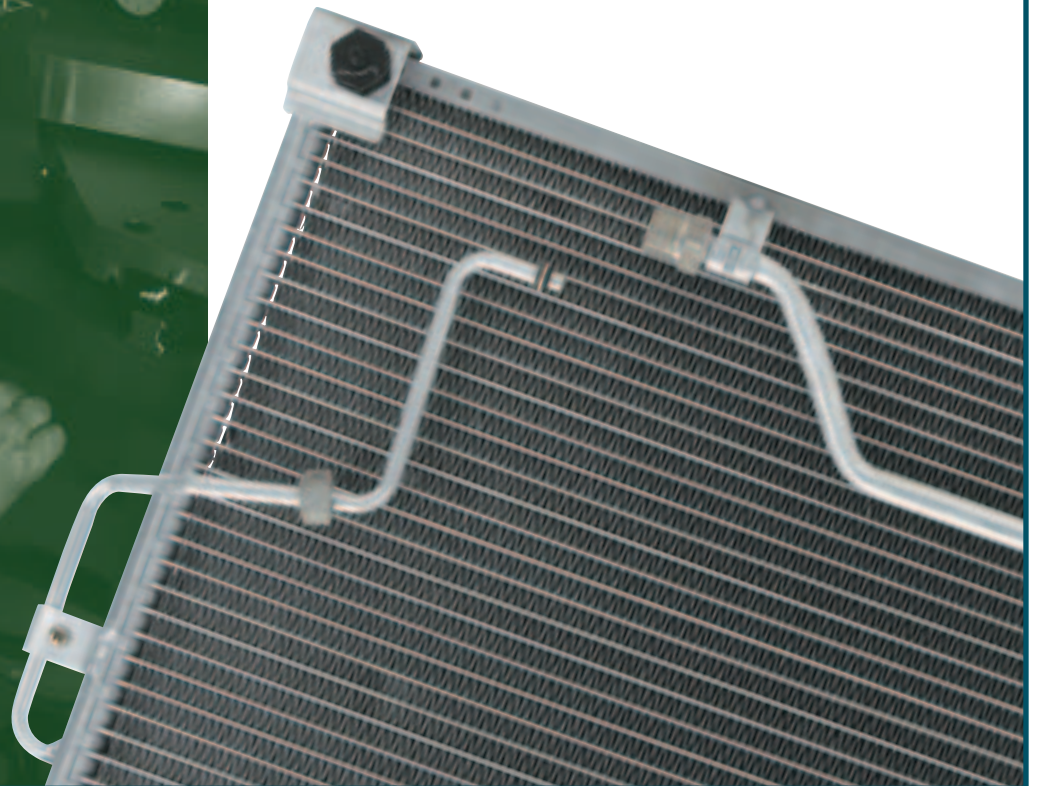

Condensers

3.1 Function

The function of a condenser is exactly the same as that of a radiator. For instance, it has tubes and fins to release heat. The radiator uses its tubes and fins to absorb heat from the engine coolant, the condenser does the same except it absorbs heat from the A/C refrigerant.

A condenser is always installed in between the radiator and the front grill. It needs as much airflow as possible to go through the fins and cool properly. If the condenser is not cooled sufficiently, it will not be able to change the refrigerant back from gas to liquid, which is the state needed for cool air.

As its name suggests, a condenser will condense the refrigerant that circulates through it. At this point, this is where the refrigerant must release its heat.

Heat is released from the condenser in many ways. First, when the A/C system is engaged, an electric or engine-driven coolant fan pulls fresh air through the condenser. Secondly, the front of the grill enables the outside ambient air to flow through the condenser. Some more aerodynamic vehicles have no front grill to let the fresh air from the outside in. These vehicles use special air deflectors located under the front body to direct the air flow when the fan is running or when the vehicle is in motion.

Lastly, the majority of today's vehicles have deflectors in between the condenser and the front grill to concentrate the flow of fresh air to the condenser

3.2 Condenser Types

Currently there are four types of condensers used in today's vehicles. There is an older style known as a regular **tube and fin** with 3/8 tubes. This type will be found on older domestic models.



Regular Tube and Fin

Second, there is the **serpentine** condenser that is used in older imports, as well as in some recent applications.

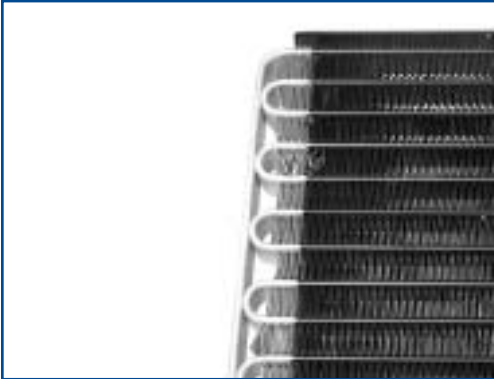

Serpentine

Third, there is the new **piccolo** tube and fin 6 mm tube that is used in recent domestic models.



6 mm Piccolo Design

The latest design used in all new imports and some new domestics is the **parallel flow** condenser.

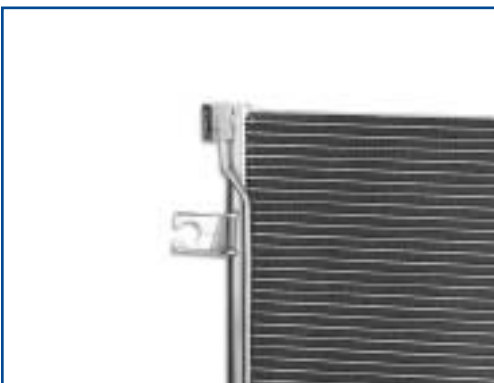

Parallel Flow Design

The parallel flow condenser is the most efficient of the four types. The only problem with this type of condenser is that its design uses tubes with small passages therefore, if the A/C compressor fails, it will most likely clog up the condenser. This unit cannot be flushed. It is recommended that the unit be replaced if a catastrophic compressor failure occurs or even if a recently installed compressor fails.



Cutaway View of Parallel Flow Condenser Tubes

3.3 Diagnosis

When examining the performance of a condenser, it is important to check for proper airflow through the condenser. Remember that if there are airflow restrictions due to broken or missing air deflectors or baffles, the condenser will not release enough heat to change the refrigerant state from gas to liquid.

If the condenser appears to be the root of the problem, try spraying it with cold water, while checking the temperature, then see whether the temperature drops immediately after spraying. If it does, the probable causes are airflow restrictions, internal restrictions (due to debris), or the condenser being used is not the same design as recommended by the manufacturer.

If the condenser appears to be leaking, here is a quick way to check it. First, using your A/C evacuation machine, be sure to evacuate any leftover refrigerant. Disconnect the hoses from the condenser and use special connectors to re-connect the condenser to the A/C gauges. Then use the evacuation pump to pull the condenser down to a vacuum. Check the pressure gauges after 30 minutes to see whether pressure has dropped. If it does drop, the condenser is leaking. When the leak is too small to detect, add an OEM approved dye to the system. A leak will show up as fluorescent green under an ultraviolet light.

When replacing the condenser, it is important to use the recommended amount of refrigerant oil specified by the OEM manufacturer. When replacing the condenser, it is strongly recommended to replace the accumulator/drier.