



# TOYOTA/LEXUS U140E, U140F, U240E, U241E ZIP KIT®

PART NUMBER U140E-U241E-ZIP

QUICK GUIDE

Parts are labeled here in order of installation. See other side of sheet for details on kit contents.

## INSTALLATION DIAGRAM

### Upper Valve Body

Install with open end out.

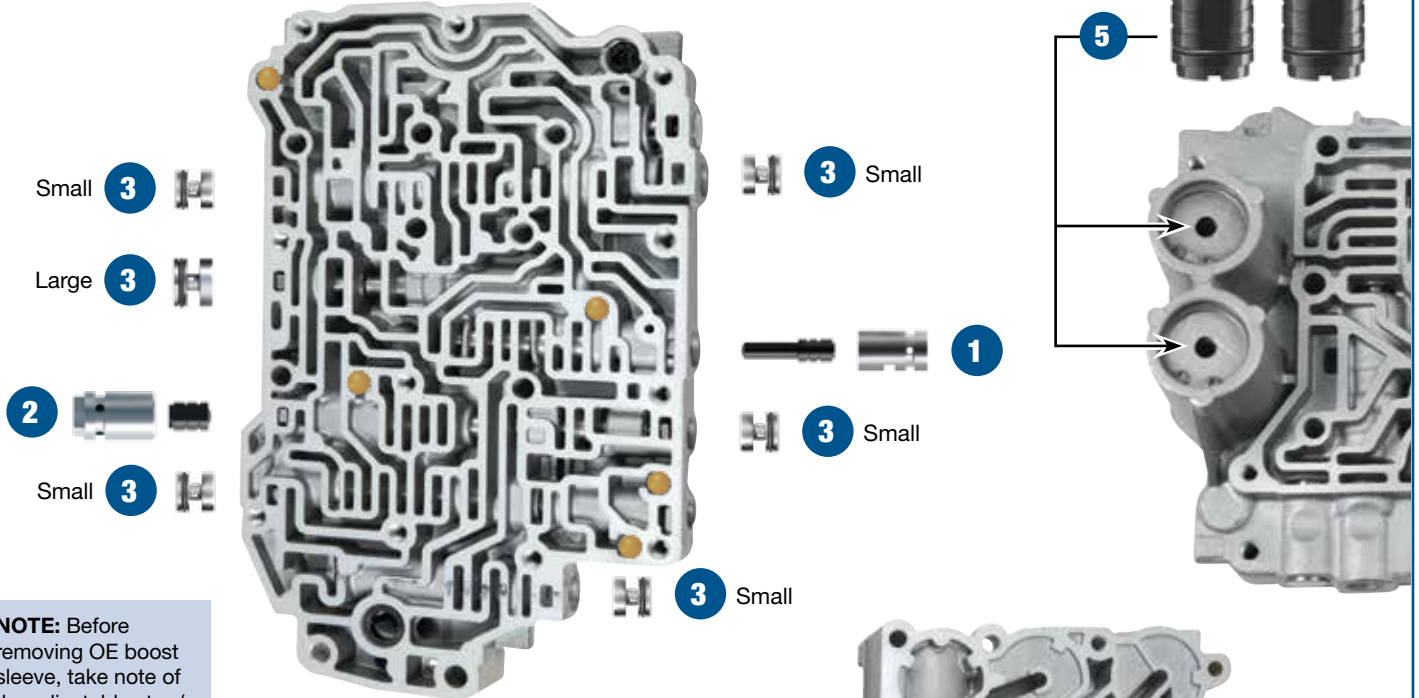

**NOTE:** Before removing OE boost sleeve, take note of the adjustable step/pin location and ensure the Sonnax sleeve is installed at the same height/location. Failure to do so will result in incorrect line rise.



Cutaway shows a side view of lower valve body with Sonnax boost valve kit installed.

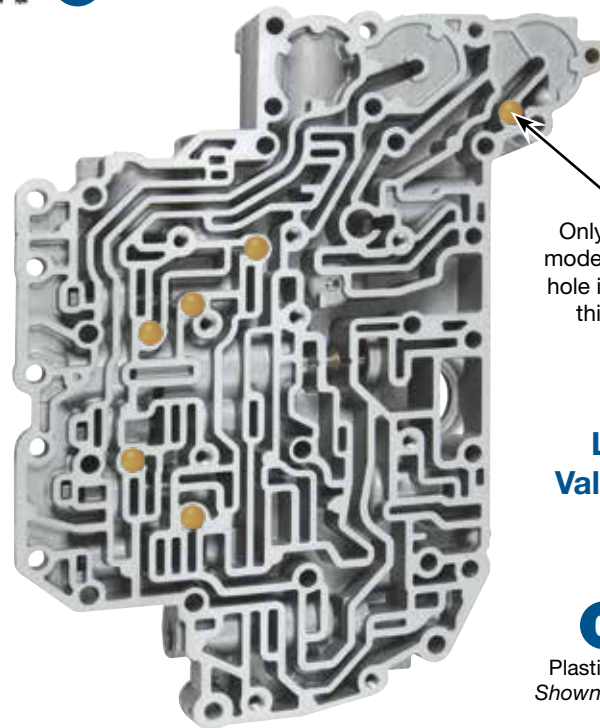
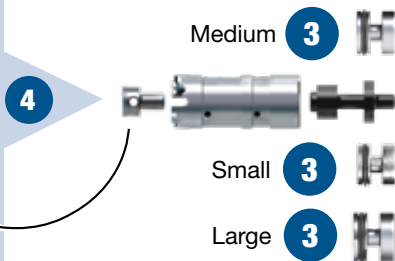

Only use here in models that have a hole in the plate at this location.

### Lower Valve Body

**6**  
Plastic Checkball  
Shown in 11 places.

In addition to general rebuilding tips and technical information, the technical booklet included in this kit contains vacuum testing and additional repair options for higher mileage units or for repairing specific complaints which are beyond the scope of this kit.

## Kit Contents & Installation Steps

### Step 1 Replace OE Clutch Apply Control Sleeve & Plunger Valve

#### Packaging Pocket 1

- Plunger Valve
- Plunger Sleeve

### Step 2 Replace OE Lockup Control Sleeve & Plunger Valve



**NOTE:** Reuse OE spring if applicable.

#### Packaging Pocket 2

- Plunger Valve
- Plunger Sleeve

### Step 3 Replace OE End Plugs



**NOTE:** Install all end plugs with the O-ring outboard. Place O-ring into end plug groove. Lubricate with Sonnax Slippery Stick **O-LUBE** and roll on bench to size.

#### Packaging Pocket 3

- Small End Plugs (6)
- Small O-Rings (9) 3 Extra

#### Packaging Pocket 4

- Medium End Plug
- Medium O-Rings (2) 1 Extra

#### Packaging Pocket 5

- Large End Plugs (2)
- Large O-Rings (3) 1 Extra

### Step 4 Replace OE Boost Sleeve & Valve

#### Packaging Pocket 6

- Boost Valve
- Boost Sleeve
- Boost Plug

### Step 5 Replace OE Accumulator Pistons



**NOTE:** Place O-ring into deepest piston groove. Lubricate with Sonnax Slippery Stick **O-LUBE** and roll on bench to size. Install into casting bore with the O-Ring inboard.

#### Packaging Pocket 7

Accumulator Piston

#### Packaging Pocket 8

Accumulator Piston

#### Packaging Pocket 9

O-Rings (3)

1 Extra

### Step 6 Replace OE Checkballs

#### Packaging Pocket 10

Plastic Checkballs (11)



# TOYOTA/LEXUS U140E, U140F, U240E, U241E ZIP KIT®

PART NUMBER U140E-U241E-ZIP

INSTALLATION & TESTING BOOKLET

Torque Specifications	
<b>Pan Filter to Valve Body</b> 96 in-lb	<b>Oil Pan to Transaxle</b> 72 in-lb
Component Pack Clearance	
<b>Forward (C1) Clutch</b> U140E/F: 4-Cyl .069-.082" U140E/F: V6 .082-.095" U240/241E: .056-.069"	<b>Low &amp; Reverse (B2) Brake</b> U140E/F: 4-Cyl .040-.048" U140E/F: V6 .043-.051" U240/241E: .043-.049"
<b>2nd (B1) Brake</b> U140E/F: .024-.036" U240E: .024-.029" U241E: .024-.036"	<b>Direct (C2) Input</b> U140E/F: .024-.033" U240/241E: .024-.029"
<b>Underdrive (C3) Clutch</b> U140E/F: .059-.075" U240E/241E: .058-.067"	<b>Underdrive (B3) Brake</b> U140E/F: .071-.087" U240/241E: .074-.082"
End Play	
<b>Input Shaft</b> U140E/F: .010-.049" U240E/241E: .011-.049"	<b>Underdrive Unit</b> U140E/F: .020-.039" U240E/241E: .008-.027"
<b>Direct Clutch Assembly</b> U140E/F: .008-.037" U240E/241E: .008-.035"	
Fluid	
Toyota Type T-IV	

## Electronic Cautions

### Resetting Shift Adapts

The ECM (engine control module) has memorized values which must be relearned after transmission repair. Use a scan tool (OE factory tool recommended) to reset the ECM.

### Post-Adapt Road Test

After resetting the ECM, a road test is required. Start the engine and warm it to normal operating temperature. Perform a thorough road test with multiple accelerations from a stop until proper shifting is obtained.

### TSB TC002-06

Toyota published a Technical Service Bulletin regarding computer hardware problems in 2001-2003 RAV4 vehicles. Resetting the ECM will not eliminate shifting complaints for this unit. A new ECM will be required.

### Solenoids

Solenoids should be cleaned to remove debris that results in sticking and malfunction.

**Toyota/Lexus U140E/F, U240E, U241E Clutch Application Chart**

Gear Range	C1	C2	C3	B1	B2	B3	F1	F2
Park						ON		
Reverse		ON			ON	ON		
Neutral						ON		
D-1st Gear	ON					ON	ON	ON
D-2nd Gear	ON			ON		ON		ON
D-3rd Gear	ON	ON				ON		ON
D-Overdrive	ON	ON	ON					
2-1st Gear	ON					ON	ON	ON
2-2nd Gear	ON			ON	ON	ON		ON
Low-1st Gear	ON				ON	ON	ON	ON

**Toyota/Lexus U140E/F, U240E, U241E Solenoid Function & Apply Chart**

Gear	SL1 Controls B1 Brake	SL2 Controls C2 Clutch	S4 Controls 3-4 Shift
1st	ON	ON	Off
2nd	Off	ON	Off
3rd		Off	Off
4th		Off	ON

**SLT:** Controls line pressure.

**DSL:** Controls lockup clutch.

**N-D ENGAGEMENT:** 3rd gear is commanded during the engagement, then 1st after the engagement is complete.

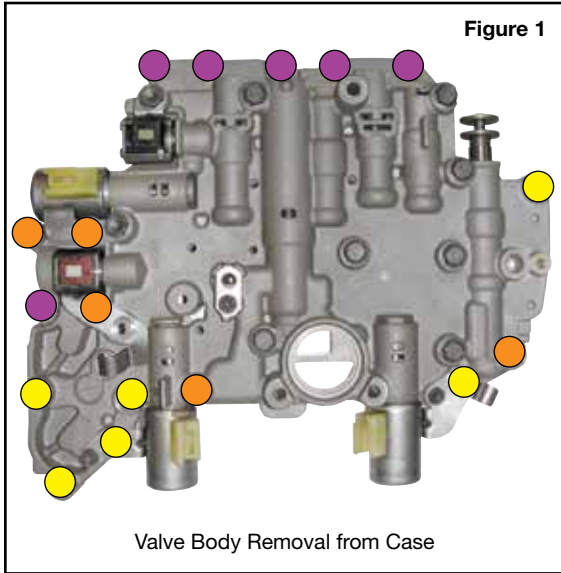

## Zip Kit Instructions

### 1. Valve Body Removal from Case

**NOTE:** See color chart for bolt lengths.

Remove the 17 bolts indicated (**Figure 1**).

### 2. Valve Body Disassembly: Step 1

**NOTE:** See **Figure 2** and **3** for bolt locations.

The solenoids have differing resistance amounts (**Figure 2**). Ensure each of the solenoids are put back in their correct location.

a. Remove the five solenoids and bolts shown in **Figure 2**.

**NOTE:** Reference **Figure 3** for steps b through e.

b. Remove the eight upper valve body bolts, **#1** and **#2**.

c. Remove the seven upper valve body cover bolts, **#3** and **#4**.

d. Remove bolt **#5**, bracket and checkball.

e. Remove checkball, location **A**.

Bolt Color Code		Bolt Length
Red		10mm
Green		12mm
Blue		14mm
Purple		25mm
White		30mm
Yellow		41mm
Orange		45mm

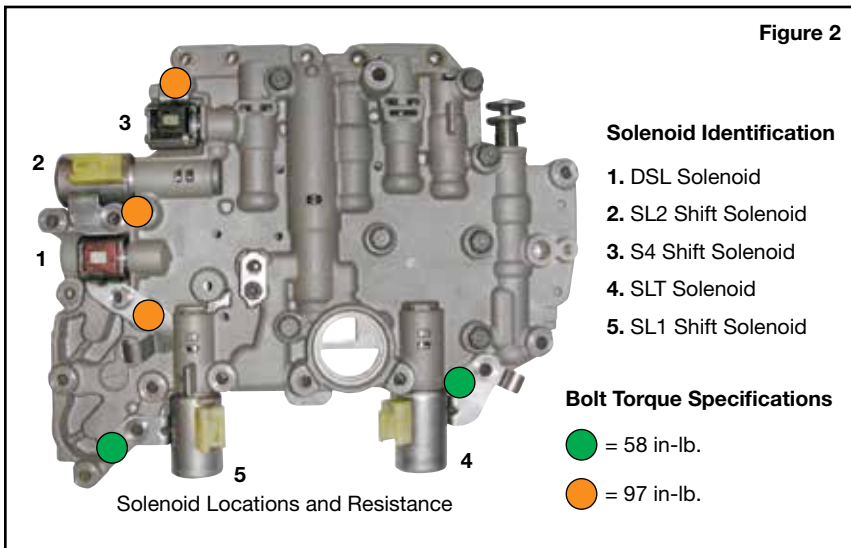

## Solenoid Resistance Chart

Solenoid	U140E	U140F	U240E	U241F
SL1	5.1–5.5 ohms	5.0–5.6 ohms	5.0–5.6 ohms	5.0–5.6 ohms
SL2	5.1–5.5 ohms	5.1–5.5 ohms	5.1–5.5 ohms	5.1–5.5 ohms
S4	11–15 ohms	11–15 ohms	11–15 ohms	11–15 ohms
DSL	11–15 ohms	11–13 ohms	11–13 ohms	11–13 ohms
SLT	5.0–5.6 ohms	5.1–5.5 ohms	5.1–5.5 ohms	5.1–5.5 ohms

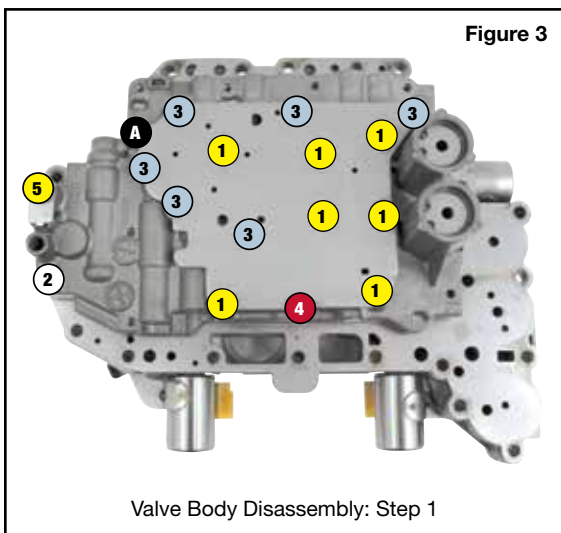

### 3. Valve Body Disassembly: Step 2

**NOTE:** See **Figure 4** for bolt locations.

- Remove the seven lower valve body bolts shown.
- Hold separator plate against lower valve body. Lift off of upper valve body and lay on bench with separator plate side up.
- Remove separator plate from lower valve body. Note the location of all the checkballs and retainers. Verification on page 8 in booklet.

### 4. Installation

Install Zip Kit parts as shown on diagram of separate quick guide sheet included in this Zip Kit.

- When installing the lockup control plunger valve and sleeve kit in Step 2, reuse the OE spring in between the new valve and sleeve if applicable.
- The Sonnax O-ringed end plugs in Step 3 must be installed with the O-ring outboard.

### 5. Valve Body Assembly: Step 1

**NOTE:** See **Figure 4** for bolt locations.

- Loosely install the seven bolts.
- Torque all bolts to 97 in-lb.

### 6. Valve Body Assembly: Step 2

**NOTE:** See **Figure 5** for bolt locations and torque specifications.

- Reinstall checkball, location **A**.
- Install checkball and bracket, then loosely install bolt **#1**.
- Loosely install the seven upper valve body cover bolts, **#2** and **#3**.
- Loosely install the eight upper valve body bolts **#4** and **#5**.
- Torque all bolts in previous steps according to specs in **Figure 5**.
- Install the five solenoids and bolts shown in **Figure 2** and torque per spec indicated.

### 7. Valve Body Reinstallation to Case

**NOTE:** See **Figure 6** for bolt locations.

- Loosely install all 17 bolts. Reference bolt color and length chart on previous page.
- Torque all bolts to 8 ft-lb.

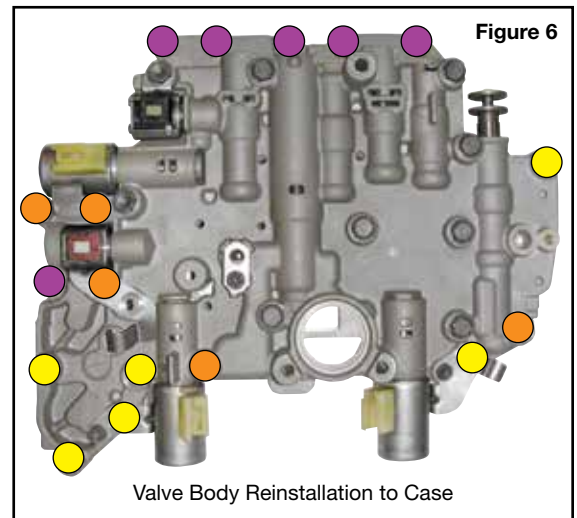
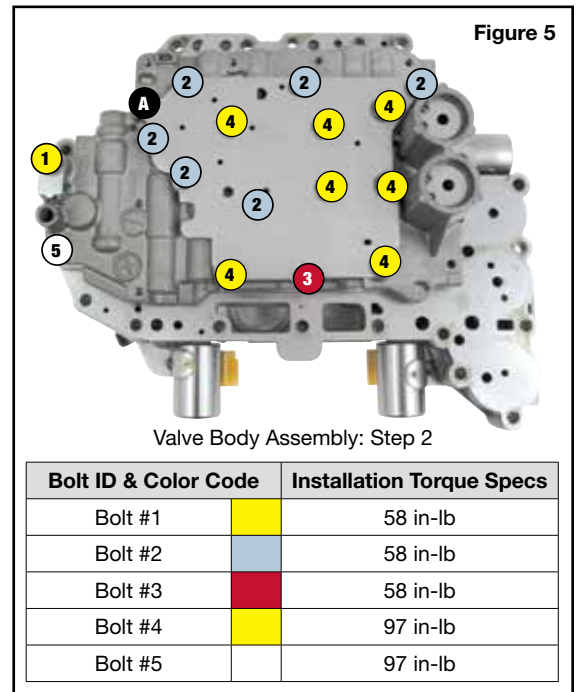
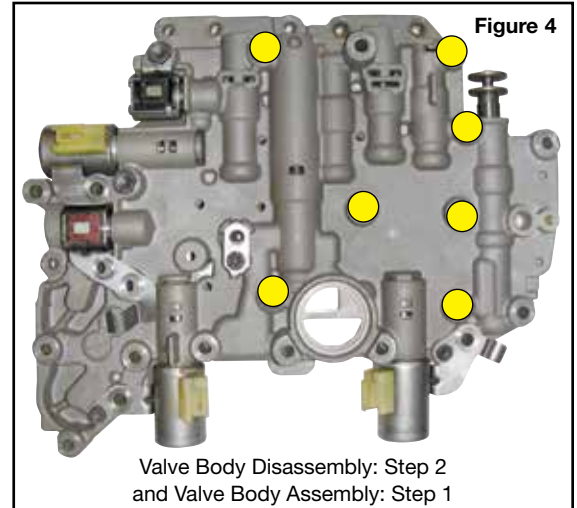



## Critical Wear Areas & Vacuum Test Locations

**NOTE:** OE valves are shown in rest position and should be tested in rest position unless otherwise indicated. Test locations are pointed to with an arrow. Springs are not shown for visual clarity. Low vacuum reading indicates wear and Sonnax parts noted for replacement.

### Upper Valve Body – Bottom Side • U241E Shown Here

#### End Plugs, Multiple Locations

- Inconsistent shift quality • Clutch failure
- Flare/Bump/Bang shifts • Shift codes

Replace with Sonnax Part No.  
**57917E-20K** **NOTE:** Six Locations = ★

#### C2 (Direct) Exhaust Valve

- C2 Clutch burned
- Slipping/Flares in 3rd and 4th

#### Clutch Apply Control Plunger Valve Assembly

- Clutch failure • Burnt clutches • Shift concerns

Replace with Sonnax Part No.  
**57917E-05K**

#### C2 (Direct) Lockup Valve

- C2 Clutch burned
- Slipping/Flares in 3rd and 4th

#### Secondary Regulator Valve

- TCC apply & release concerns • TCC codes
- Burnt converter • Lube failures

Replace with Sonnax Part No.  
**57917E-16K** Requires F-57917E-TL16 & VB-FIX

#### Lockup Control Valve

- TCC apply & release concerns • TCC codes
- Burnt converter • Harsh downshifts

Replace with Sonnax Part No.  
**27741-25K** Requires F-27741-TL25 & VB-FIX  
**NOTE:** Test both ports at the same time.

#### Lockup Control Plunger Assembly

- TCC apply & release concerns
- Burnt converter • TCC codes

Replace with Sonnax Part No. **57917E-03K**

**NOTE:** Vacuum testing of lockup control plunger assembly not possible while in casting. Perform visual inspection to identify wear.

#### Lockup Relay Valve

- TCC apply & release concerns
- Overheating • TCC codes • Burnt converter

#### Solenoid Modulator Valve

- Slips & flares • Harsh upshifts • Bind-up • Harsh Reverse
- TCC cycling/slip • Low cooler flow • Overheating
- Excess Reverse pressure & distorted housings

Replace with Sonnax Part No.  
**57917E-13K** Requires F-57917E-TL13 & VB-FIX

#### B1 (2nd Gear Brake) Control Valve

- B1 Brake clutches burned
- 2nd Quality poor

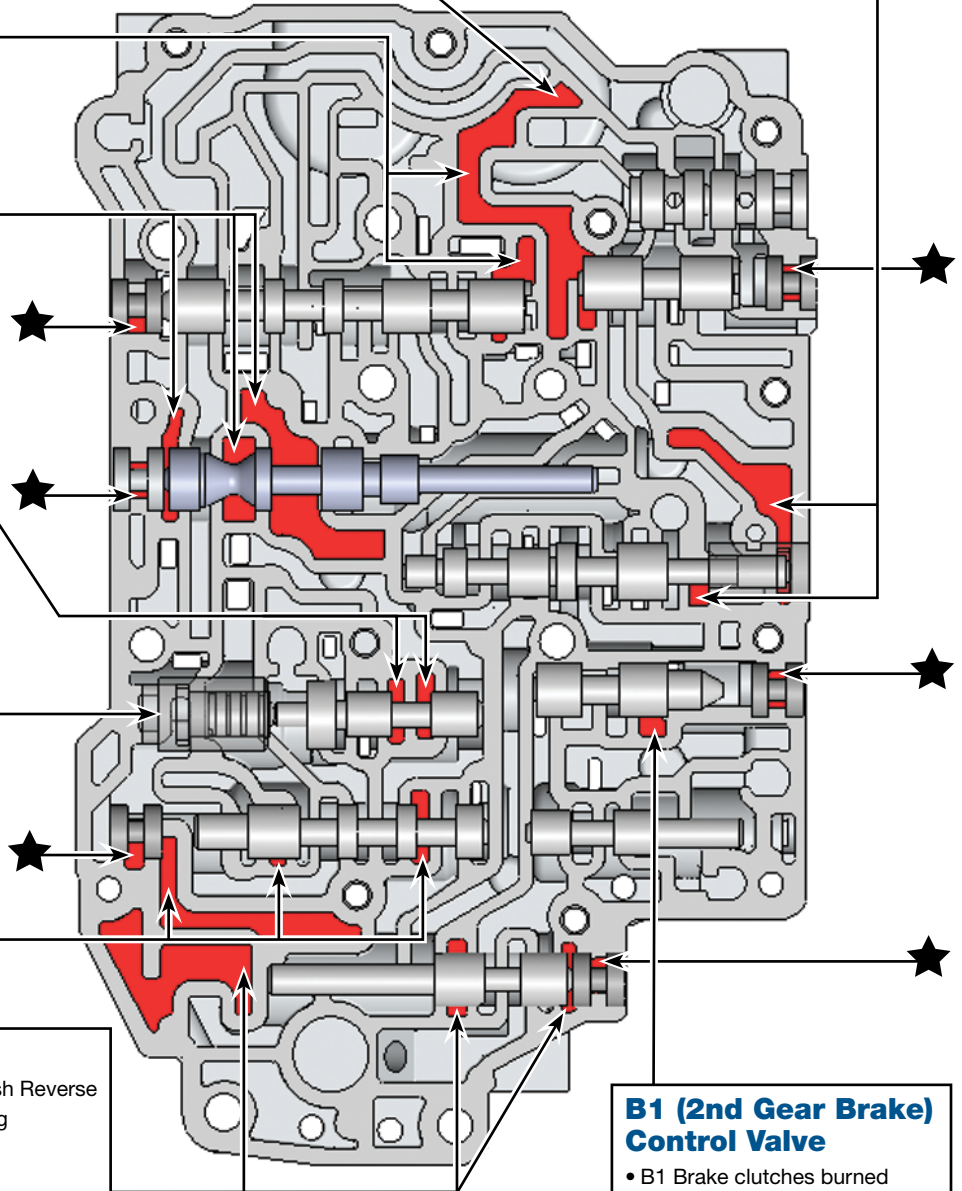

\*Part numbers with an asterisk (\*) are included in this Zip Kit. Other part numbers are available separately.



For specific vacuum test information, refer to individual part instructions included in kits and available at [www.sonnax.com](http://www.sonnax.com).

## Upper Valve Body – Top Side • U241E Shown Here

### C2 (Direct) Accumulator Piston

- Delayed engagement • Flare shifts
- Forward slip • Burnt clutches

Replace with Sonnax Part No.  
**57917E-19K**

### B1 (2nd Gear) Accumulator Piston

- Delayed engagement • Flare shifts
- Forward slip • Burnt clutches

Replace with Sonnax Part No.  
**57917E-19K**

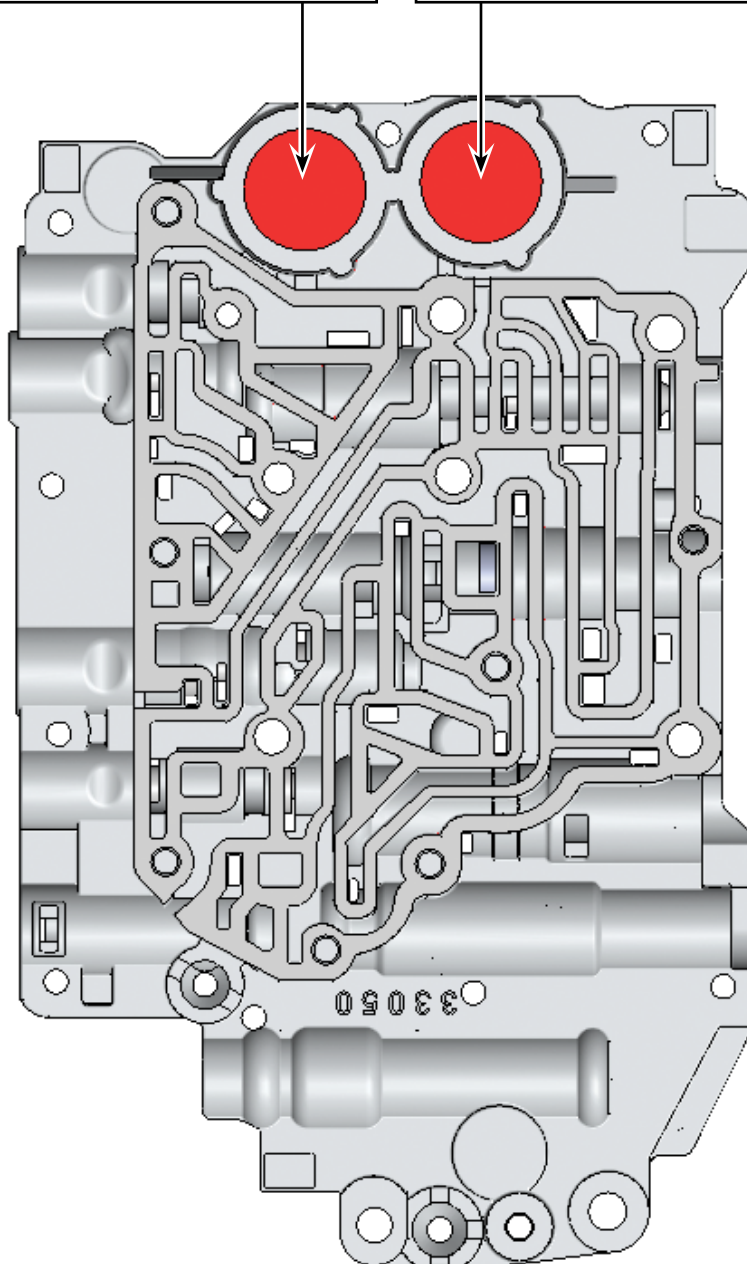

Items without part numbers are valid vacuum test locations for indicated drivability complaints, but do not have corresponding Sonnax parts due to low percentage of bore wear.

## Critical Wear Areas & Vacuum Test Locations

**NOTE:** OE valves are shown in rest position and should be tested in rest position unless otherwise indicated. Test locations are pointed to with an arrow. Springs are not shown for visual clarity. Low vacuum reading indicates wear and Sonnax parts noted for replacement.

### Lower Valve Body – Bottom Side • U241E Shown Here

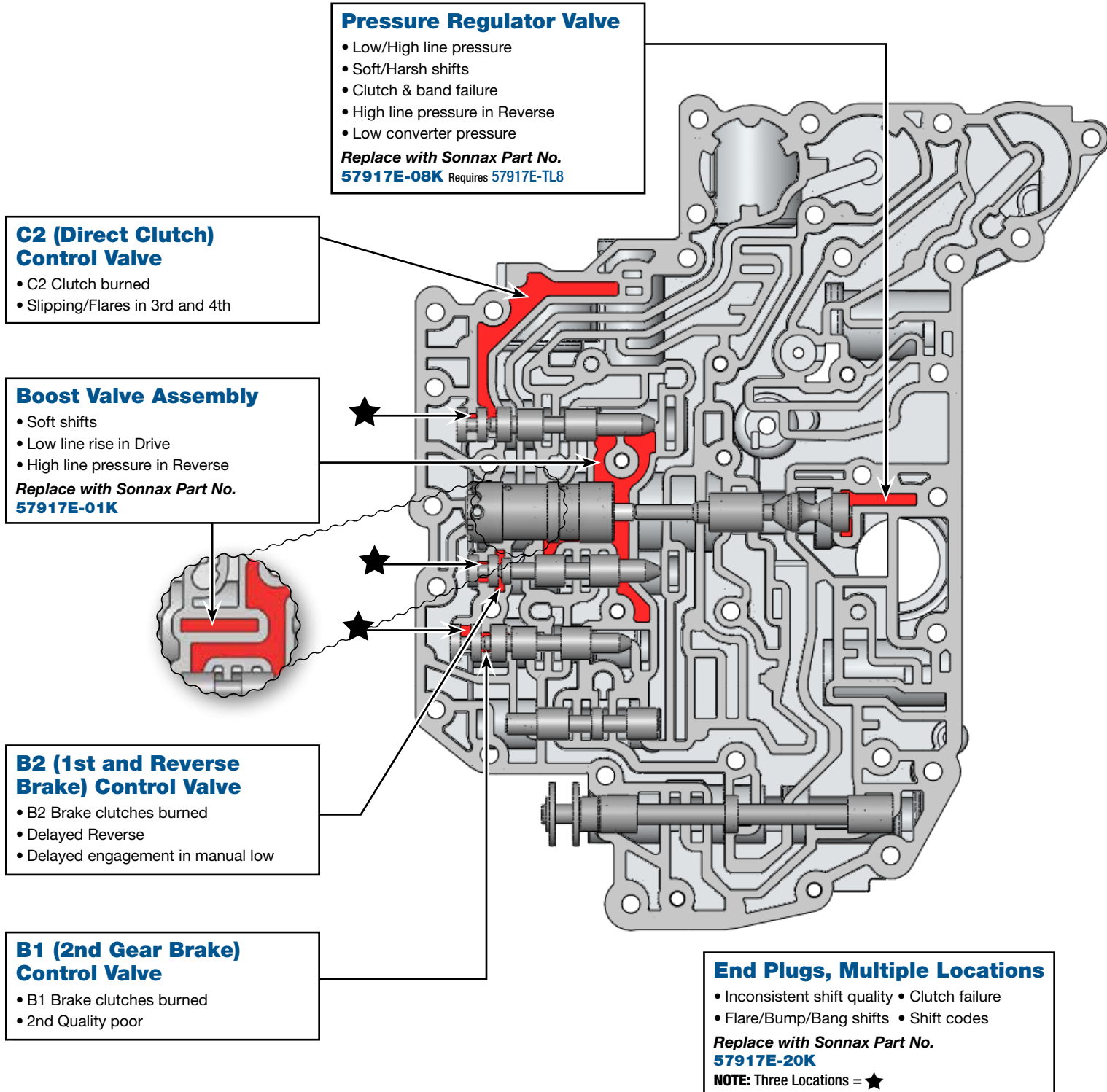

\*Part numbers with an asterisk (\*) are included in this Zip Kit. Other part numbers are available separately.



## OE Exploded View

### Upper & Lower Valve Body • U241E Shown Here

#### Upper Valve Body Descriptions

I.D No.	Description
101	C2 Lockup Valve
102	Secondary Regulator Valve
103	Lockup Control Valve
104	Lockup Relay Valve
105	Solenoid Modulator Valve
106	B3 Orifice Control Valve
107	B1 Lockup Valve
108	Clutch Apply Control Valve
109	C2 Exhaust Valve
110	Three-Way Check Valve

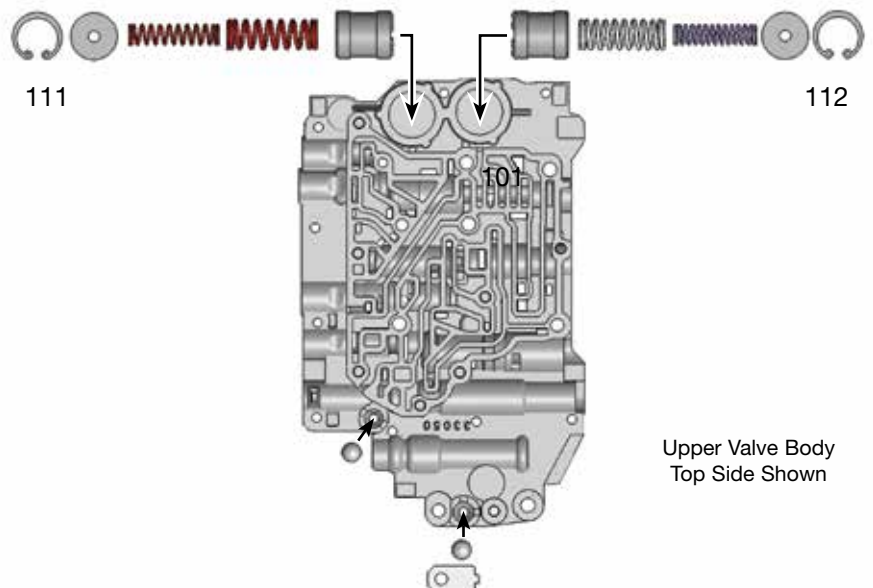
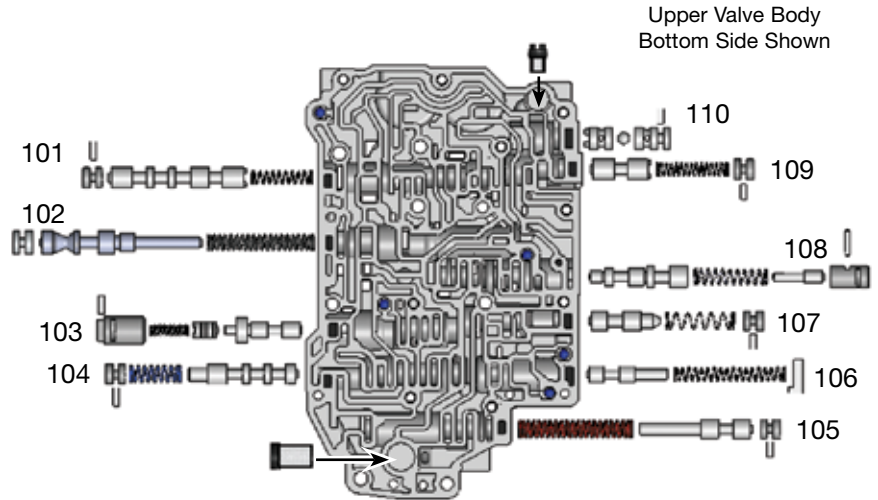

#### Upper Valve Body Descriptions

I.D. No.	Description
111	C2 Accumulator Piston
112	B1 Accumulator Piston

## OE Exploded View

### Upper & Lower Valve Body • U241E Shown Here

#### Lower Valve Body Descriptions

I.D No.	Description
201	C2 Control Valve
202	Main Regulator Valve
203	B2 Control Valve
204	B1 Control Valve
205	3-4 Shift Valve
206	Manual Valve

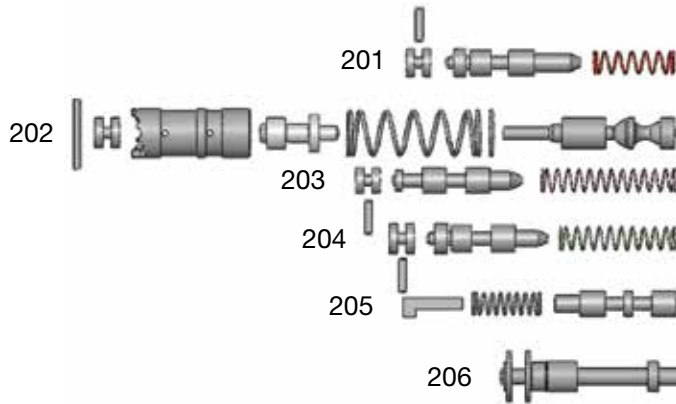

*Checkball is not used in all units.  
Only use in models that have a  
corresponding hole in the  
separator plate at this location.*

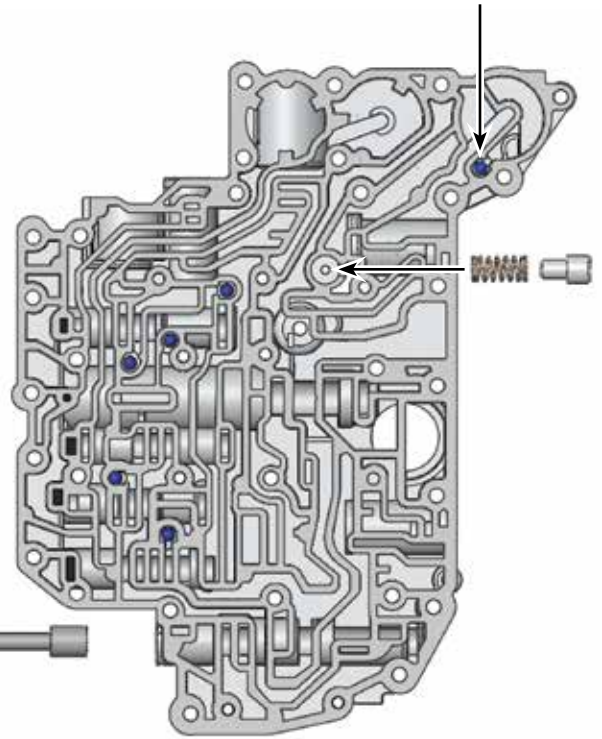

Lower Valve Body  
Bottom Side Shown

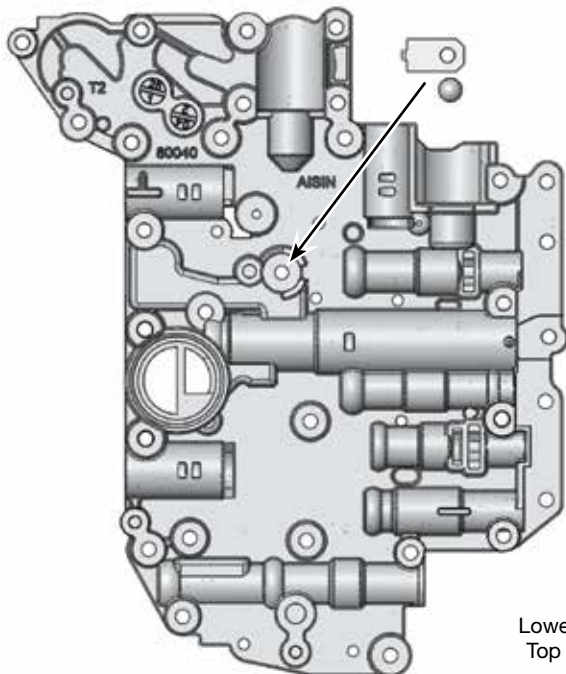

Lower Valve Body  
Top Side Shown