

**Thank you for purchasing your new SOLO WERKS S1 Coilover suspension.  
IMPORTANT PLEASE READ BEFORE BEGINNING INSTALLATION:**

Please take a moment to review this installation process and verify that your kit is complete and all components have been received. If there are any questions during the process, contact us directly.

SOLO WERKS recommends that you have this kit installed by a qualified professional. Solo Werks or its authorized agents are not responsible for damage or failure resulting from an improper or modified installation. Do not use a pneumatic impact gun to torque the upper strut nut as damage may occur. All suspension related components must be inspected and in good working condition. You should inspect all bushings, tie rods, hubs, bearings, strut mounts, sway bar end links, wheels, tires, etc. and replace if necessary.

This suspension system was designed to work best with the factory wheel/tire combination. Any deviations from these specifications could result in significantly altered handling characteristics and/or increased interference risk to other vehicle components.

**SOLO WERKS TIP: Depending on the offset & size your wheels/tires, wheel spacers may be required for proper fitment.**

If suspension is lowered past the recommended measurements there can be possible interference with multiple vehicle components; (i.e. modification may be necessary to fender lips, seams etc...). This will also void your Solo Werks warranty.

After installing the suspension system, a four wheel alignment must be performed according to manufacturer's specifications. Check and reset load- dependent brake compensator, ABS system and headlight aim according to manufacturer's specifications (If applicable).

ALL RUBBER- MOUNTED STRUT/ DAMPER ATTACH-MENTS MUST NOT BE FULLY TIGHTENED UNTIL AFTER THE SUSPENSION SYSTEM IS LOADED (WHEELS ON THE GROUND). OTHER MOUNTING FASTENERS (FOR EXAMPLE BRACKETS) MUST BE SECURELY TIGHTENED BEFORE LOAD IS PLACED ON THE SUSPENSION SYSTEM

Every effort has been made to avoid printing errors in our literature. However, if there are any application or specification errors or omissions we must disclaim responsibility.

# INSTALLATION INSTRUCTIONS

SOLO WERKS S1 Coilover Suspension  
BMW F22 /F30/F31/F32/F33/F34 Platform  
Part Number: S1BW010 / S1BW020

**Fig. 1**

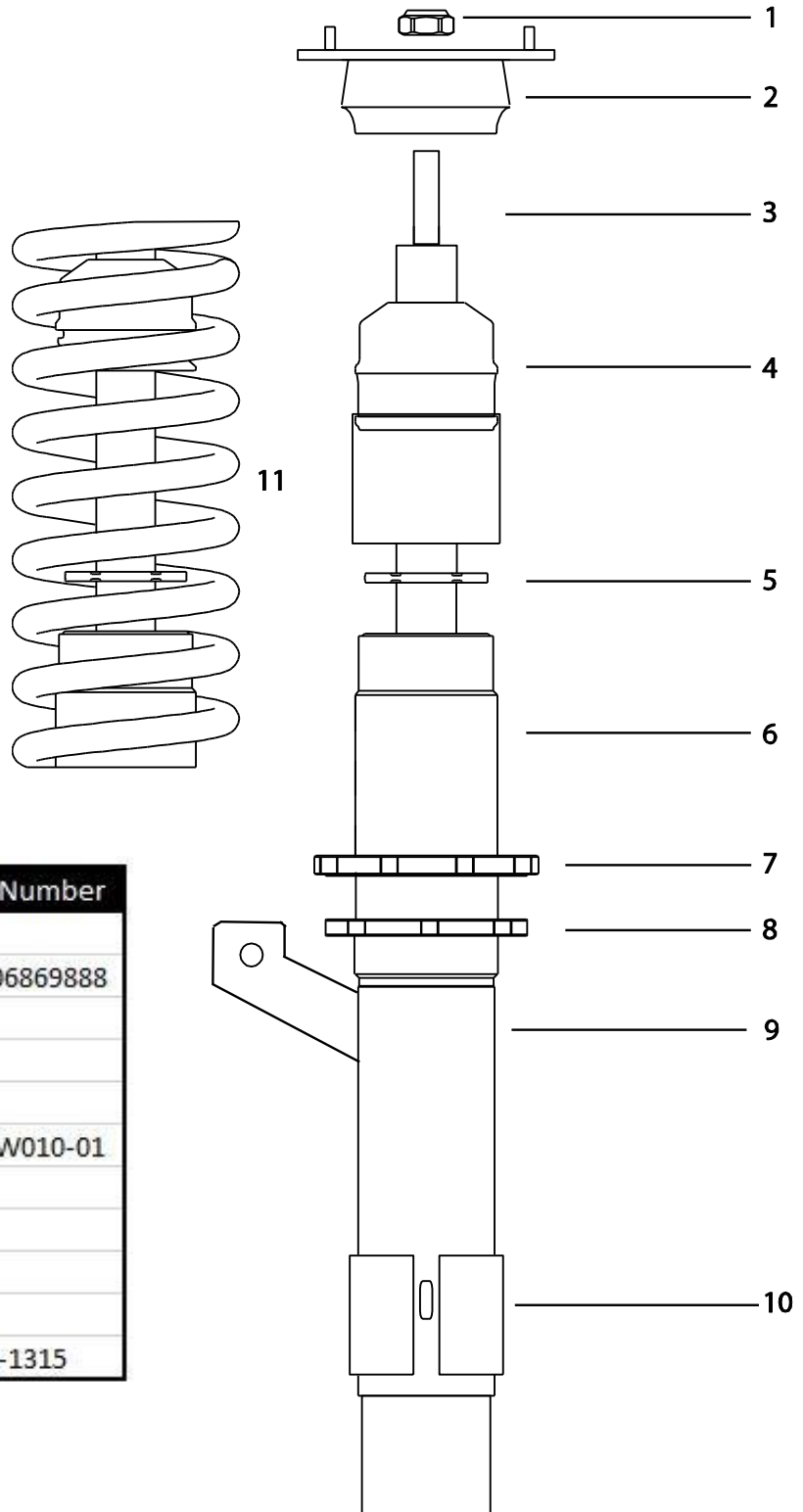

#	Description	Part Number
1	Top Nut	
2	OEM Upper Mount	31306869888
3	Damper Shaft	
4	Bumpstop /Dustboot	
5	Vent Disc	
6	Strut Housing	S1BW010-01
7	Lower Spring Perch	
8	Lock Ring	
9	Sway bar Mount	
10	Adapter Spacer	
11	Main Spring	S-1315

# INSTALLATION INSTRUCTIONS

SOLO WERKS S1 Coilover Suspension  
BMW F22 /F30/F31/F32/F33/F34 Platform  
Part Number: S1BW010 / S1BW020

**Fig. 2**

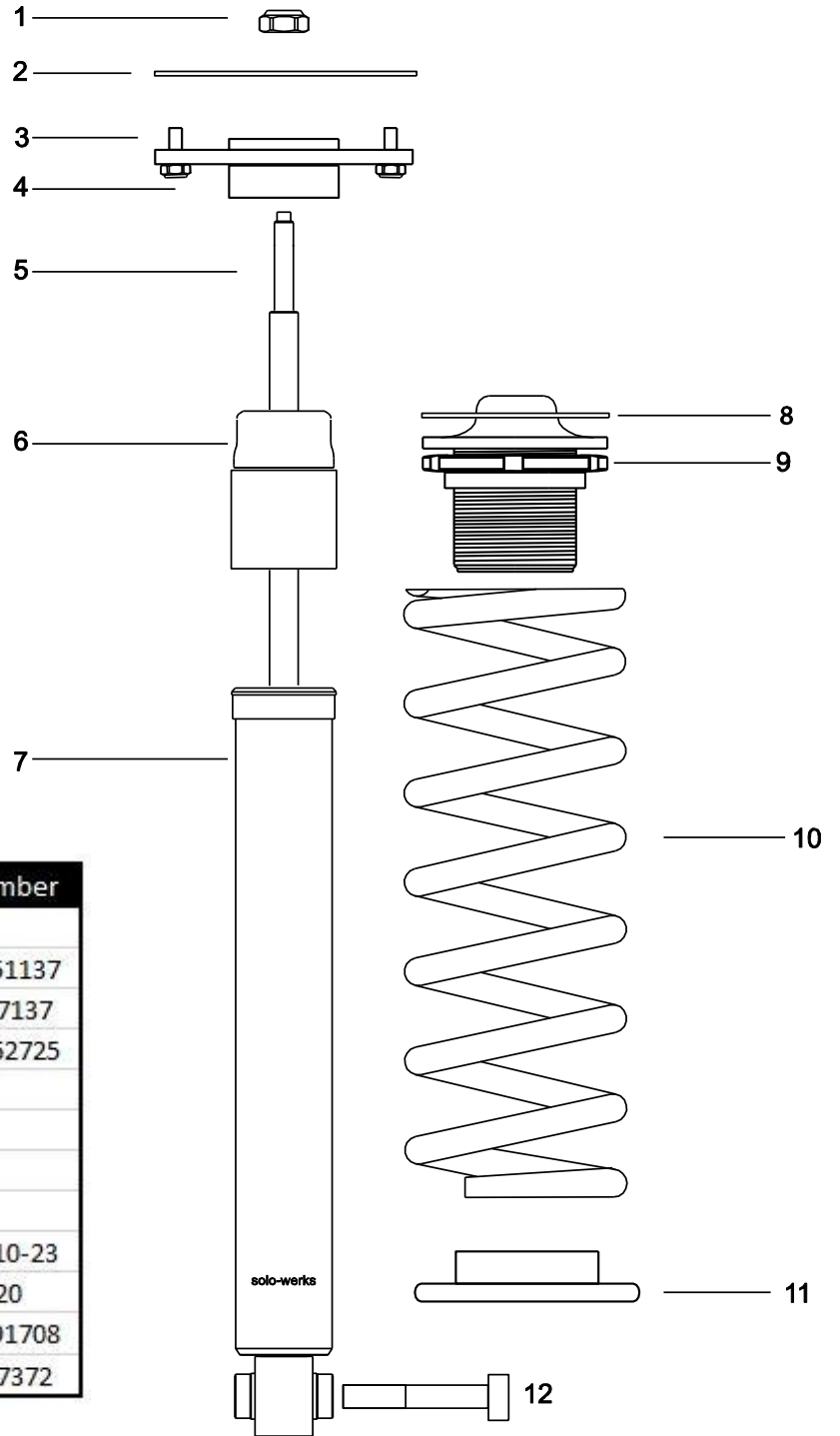

#	Description	Part Number
1	Top Nut	
2	Washer-Gasket	33506851137
3	Star-Socket Screw	7119907137
4	Guide Support	33506862725
5	Damper Shaft	
6	Bumpstop / Dustshield	
7	Damper Housing	
8	Spring Perch Isolator	
9	Rear Adjustable Spring Perch	S1BW010-23
10	Rear Spring	S-2220
11	OEM Spring Pad	33536791708
12	OEM Lower Torque Screw	7119907372

## Original Suspension Removal

### Front

1. Support Lower Control Arm/Spindle with floor jack
2. Remove the upper strut mount cover

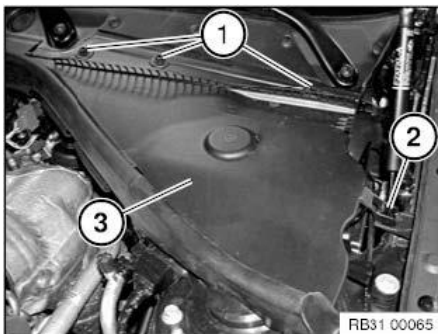

3. Remove three (3) upper strut mount bolts and the 1x strut tower brace bolt

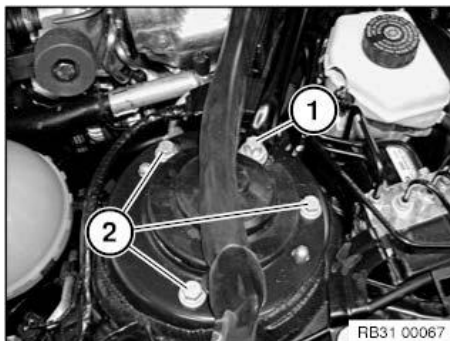

4. Remove ride height sensor (if equipped) from wishbone

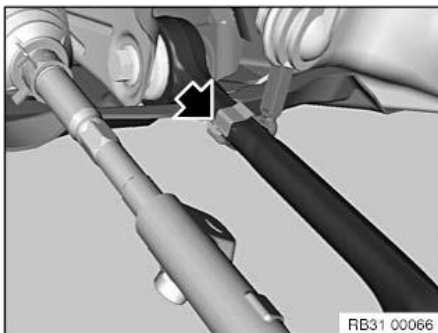

5. Remove sway bar end link from strut housing and sway bar

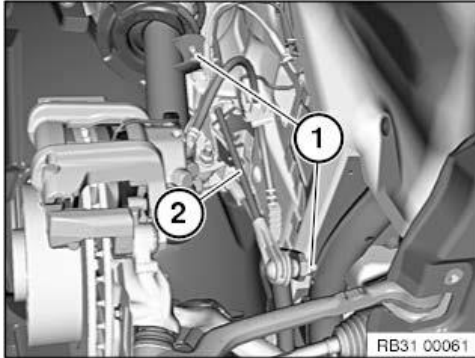

6. Remove Lower spindle (Pinch) Bolt from spindle (1&3)

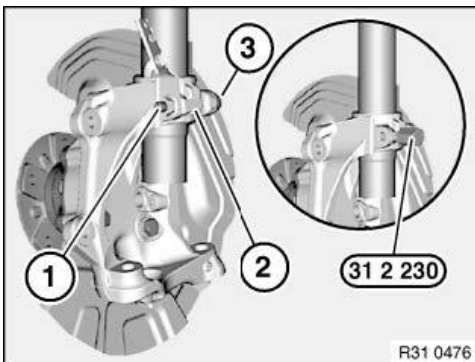

7. Using Strut Spreader Tool, spread spindle mount (#2)
8. Using the floor jack, slowly allow Lower control arm to droop and remove strut assembly
9. Leave the Strut Spreader in place

**SOLO WERKS TIP:** As the strut mounts are a consumable/wear item and are a known fail point on this chassis. Solo Werks recommends using new replacement parts and leaving your original suspension as an assembly. These parts are available from your Solo Werks Dealer or your local BMW parts dealer.

NOTE: If you are using your existing OEM upper strut mount you must remove this from the strut assembly. This component is under extreme pressure from the coil spring and must be removed using an appropriate spring compressor to relieve the pressure. Follow the directions given by the manufacturer of the Spring Compressor to safely remove the spring and disassemble the Strut Assembly.

## Solo Werks Coilover Pre Assembly – Priming the Dampers

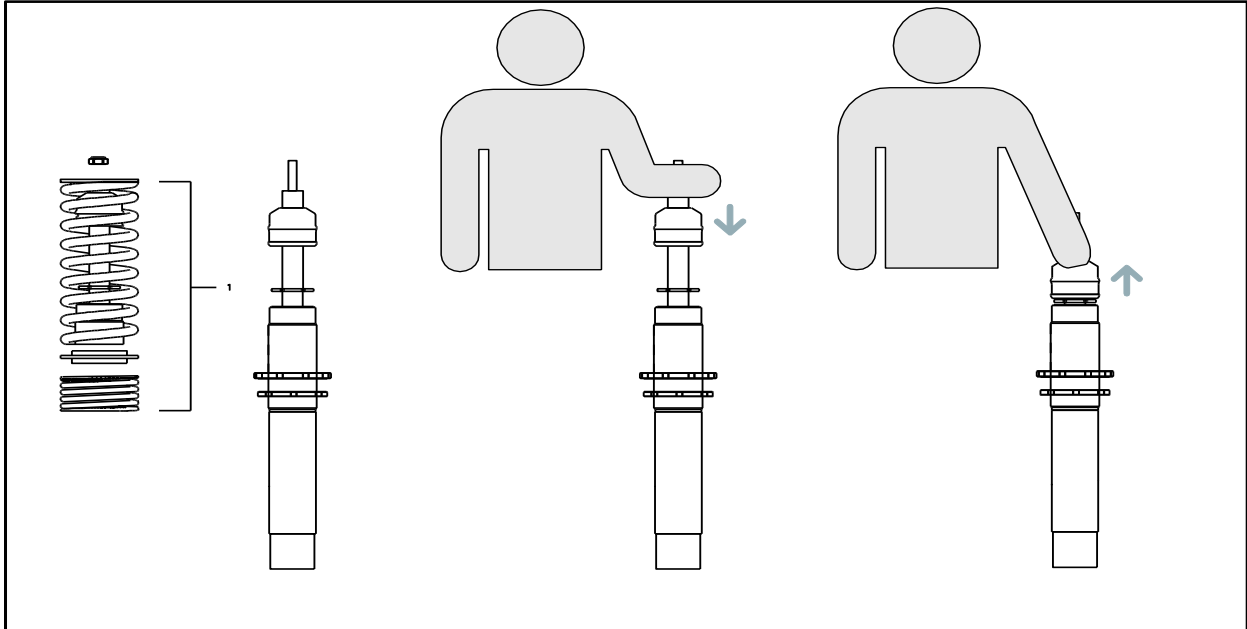

**SOLO WERKS TIP:** As the suspension is shipped and stored in a horizontal position, it is advisable to exercise or Prime ALL shock absorbers before you install them to ensure that the internal contents are in the correct chambers. Therefore we advise that before you assemble the front coilover shock absorber, take a moment to purge the shock absorber.

To do this, one side at a time remove the following from one of the front Coilover Assemblies:

- Two Upper fasteners (lock nut and securing nut)
- Upper Spring Perch
- Main Spring
- Spring Isolator
- Helper Spring

You will then be left with the coilover strut with the bumpstop and vent disc on the shaft. Pull the bumpstop up to the top of the chrome shock shaft, just before the threaded portion.

With the shock upright (as it would be installed in the vehicle) compress the shock shaft until the bump stop touches the shock housing, and then pull to extend the shock shaft back to full extension.

Repeat 3-5 times. You will notice the shock forces getting progressively harder each time. Once they feel consistent each way, you are ready to install.

### Solo Werks Coilover Assembly and Installation

#### Front

1. Assemble the coilover assembly with the OEM Strut Mount using the provided hardware as in the diagram (Fig. 1) Torque supplied upper strut nyloc nut to **M12/ 64Nm 47ft lbs.**

**NOTE:** Use of an anti-corrosion spray such as the Boeshield T-9 on the threads & main perch/spring seat at this point can make the adjustment process much easier and will add an extra layer of protection. Boeshield T-9 is available from your Solo Werks dealer.

2. Insert strut assembly into vehicle
  - a. Hand tighten three (3) upper strut mount nuts

**NOTE:** Before proceeding with the next step, inspect the Spindle for debris (rust/dirt etc. as this can make installation difficult.

3. Connect strut housing to spindle:
  - a. Insert Strut into spindle using the locating pin to center and making sure housing is completely seated within spindle. Remove strut spreader tool and insert OEM Pinch bolt and nut, torque to spec. **M10 (44Nm / 33ft lbs.)**.
4. Reattach sway bar endlink to strut housing (M8/28Nm & M10/56Nm)
5. Reattach any brake, ABS lines and ride height sensors that were removed.
6. Repeat procedure on the other side of vehicle.
7. Once vehicle is placed back on the ground tighten three (3) upper strut mount nuts (**30Nm/22ft lbs.**) to proper torque specifications. (Or supporting lower control arm in the compressed position (loaded as if it is on the ground) using floor jack, jack stand or equivalent.
8. Replace plastic upper strut mount cover.
9. Adjust lower spring perch to desired vehicle height.

## Original Suspension Removal

While supporting lower control arm in the compressed position (loaded as if it is on the ground) using floor jack, jack stand or equivalent.

1. Remove lower shock bolt (#1)

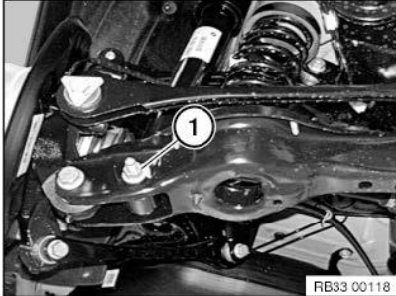

2. While supporting the LCA with a jack stand loosen and remove outboard LCA bolt.
3. Slowly lower the LCA to remove tension from rear coil spring.
4. With tension relieved from the LCA remove rear coil spring.

(OEM Upper spring cup must be removed to accept adjustable spring perch)



5. Remove the upper bolts from the upper shock mount on each side & remove rear shocks.

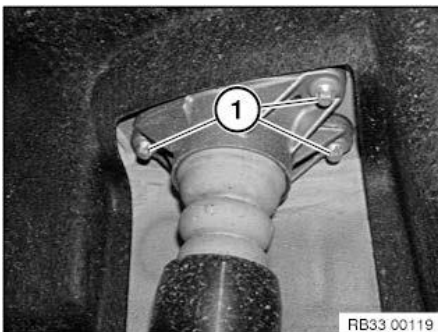

6. Remove factory upper mount and bumpstop/dust shield assembly from OEM shock.
  - a. These will be reused with new Solo Werks rear shock.
  - b. Note orientation as they will be reinstalled in same fashion.



### Solo Werks Coilover Assembly and Installation

#### Rear

The Rear of this platform is a combination of a rear lowering spring & adjustable spring perch and specially matched shock absorber. The shock absorber does not need to be adjusted in any way to change the ride height.

**SOLO WORKS TIP:** *Just like the front struts, it is advisable to Prime the rear shocks as well. To purge the rear shocks: Refer to procedure on page 5.*

#### Rear Spring Assembly:

1. Remove the lower factory spring pad from the control arm, and ensure that the area is clean and clear of any dirt or debris. – Note: This lower spring pad will be reused.
2. Remove the upper spring pad and metal cup from the factory pocket on the body and ensure that that the area is clean and clear of any dirt or debris. This IS NOT reused.
3. With the adjustable perch on top of the spring, place the assembly into the lower control arm pocket & body spring locator.
  - a. You will need to raise the rear axle to keep the assembly in place.
  - b. Make sure bottom of rear spring is oriented properly in OEM lower spring pad.
  - c. Note: with the spring perch installed on top, this allows for easier access for adjustment once installed in vehicle.

**Solo Werks Tip:** *Make sure the supplied rubber spring perch isolator is installed in-between the chassis and the adjustable spring perch. (Fig. 2 #xx)*

#### Rear Shock Absorbers Assembly:

1. Assemble new Solo Werks rear shock absorber using original upper shock mounts and dust shield/bumpstop assembly. M10 (**28Nm / 20ft lbs.**)
2. Install shock into upper shock mount and tighten shock mount nut to proper spec.
3. Compress lower control arm until LCA bolt can be reinstalled. M8 (**38Nm / 28ft lbs.**)
  - a. Install and torque lower shock bolt to proper torque settings. M12 (**100Nm / 74ft lbs.**)
4. Final check that all hardware is tight and torqued properly.

**SOLO WERKS TIP:** *It is advisable that all attaching hardware be checked after approx. 200 miles to ensure it has retained appropriate OEM torque settings.*

## Solo Werks Coilover Final Details – Heights & Working Ranges

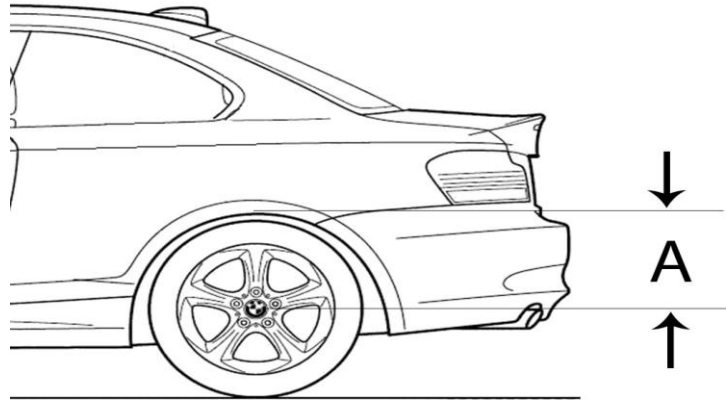

		Lowering Range			
		in mm		in Inch	
Model	Year	Front	Rear	Front	Rear
BMW F30 Sedan W/O EDC	12-'17	40-65mm	30-60mm	1.6"-2.5"	1.2"-2.4"

Front Measurement					
Max low mm	Max low Inch	Max high mm	Max high Inch	OEM mm	OEM Inch
325mm	12.8"	348mm	13.7"	389mm	15.3"

Rear Measurement					
Max low mm	Max low Inch	Max high mm	Max high Inch	OEM mm	OEM Inch
320mm	12.6"	351mm	13.8"	381mm	15"

- These measurements are in place to allow both front and rear dampers to operate properly and allow for ample shock travel.
- All measurements will be referenced from "center of wheel hub to bottom lip of fender" (see example figure "a")
- Using this system outside of this range can cause premature failure and is cause to void your manufacturer specified warranty.
- Helper springs are intended to keep preload on the main spring under full suspension extension, do not remove!

## My Setup - Heights & Working Ranges

# INSTALLATION INSTRUCTIONS

SOLO WERKS S1 Coilover Suspension  
BMW F22 /F30/F31/F32/F33/F34 Platform  
Part Number: S1BW010 / S1BW020

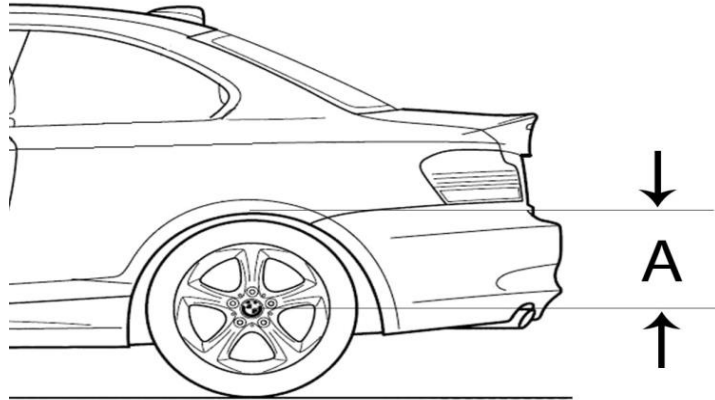

Use this page to record your setup heights for easy future reference

Front Measurement						
Date	Max low mm	Max low Inch	Max high mm	Max high Inch	OEM mm	OEM Inch
Solo Spec	325mm	12.8"	348mm	13.7"	389mm	15.3"

Rear Measurement						
Date	Max low mm	Max low Inch	Max high mm	Max high Inch	OEM mm	OEM Inch
Solo Spec	320mm	12.6"	351mm	13.8"	381mm	15"