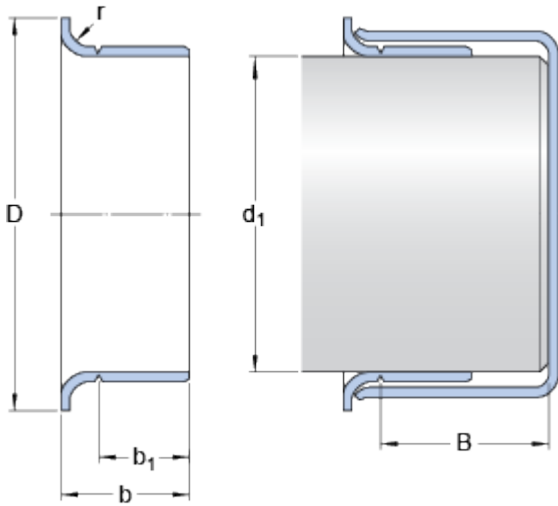

99868
Dimensions

Shaft diameter range
 d_1 min. 25.349 mm

 d_1 max. 25.476 mm

Nominal dimensions
 d_1 25.4 mm

D 30.963 mm

± 1.6 mm

b 11.125 mm

± 0.8 mm

 b_1 7.95 mm

± 0.8 mm

B max. 50.8 mm

r max. 3.18 mm