

99346

Dimensions

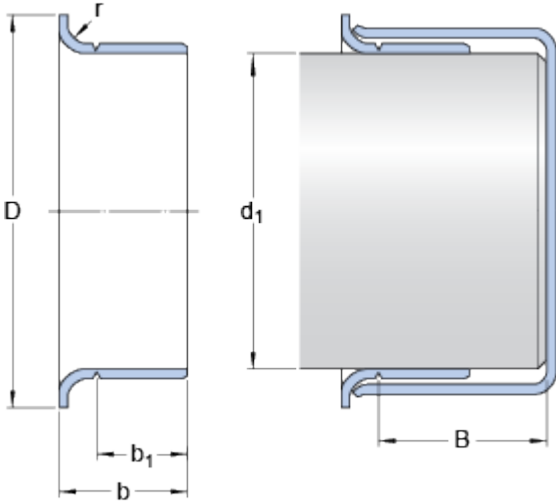

Shaft diameter range

d_1 min. 88.824 mm

d_1 max. 89.002 mm

Nominal dimensions

d_1 88.9 mm

D 97.638 mm

± 1.6 mm

b 20.65 mm

± 0.8 mm

b_1 15.875 mm

± 0.8 mm

B max. 34.214 mm

r max. 3.18 mm