

99254

Dimensions

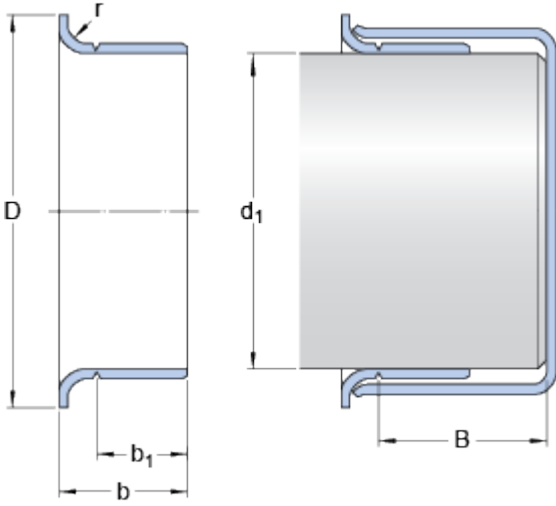

Shaft diameter range

d_1 min. 64.922 mm

d_1 max. 65.1 mm

Nominal dimensions

d_1 65 mm

D 72.39 mm

\pm 1.6 mm

b 22.987 mm

\pm 0.8 mm

b_1 19.99 mm

\pm 0.8 mm

B max. 34.925 mm

r max. 3.18 mm