

99215

Dimensions

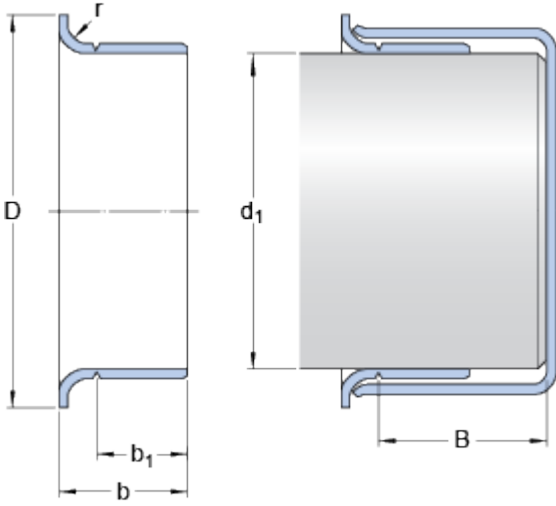

Shaft diameter range

d_1	min.	54.915	mm
d_1	max.	55.067	mm

Nominal dimensions

d_1		55	mm
D		62.001	mm
	\pm	1.6	mm
b		22.987	mm
	\pm	0.8	mm
b_1		19.99	mm
	\pm	0.8	mm
B	max.	31.75	mm
r	max.	3.18	mm