

99199

Dimensions

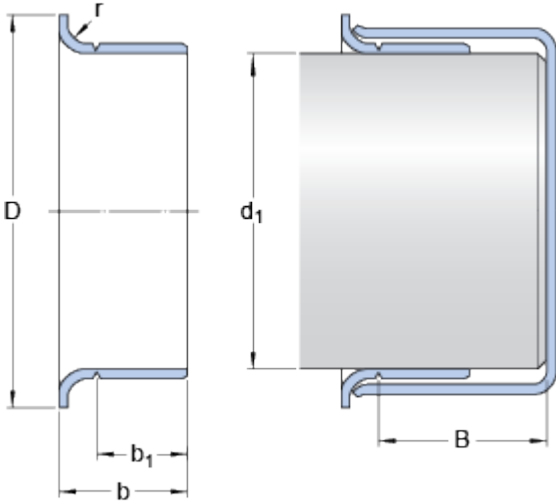

Shaft diameter range

d_1 min. 50.724 mm

d_1 max. 50.876 mm

Nominal dimensions

d_1 50.8 mm

D 61.112 mm

\pm 1.6 mm

b 17.475 mm

\pm 0.8 mm

b_1 14.3 mm

\pm 0.8 mm

B max. 25.4 mm

r max. 3.18 mm