

99169

Dimensions

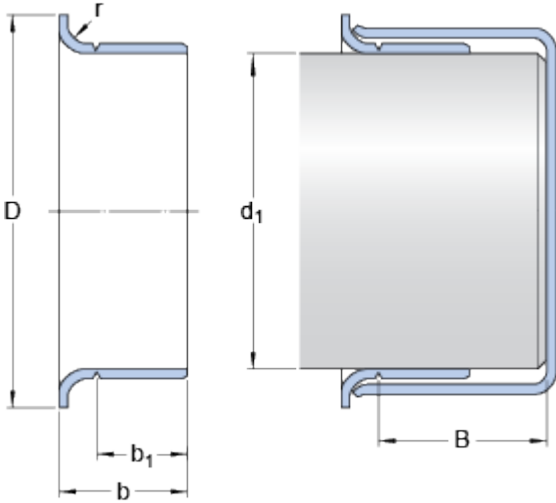

Shaft diameter range

d_1 min. 41.834 mm

d_1 max. 41.986 mm

Nominal dimensions

d_1 42 mm

D 53.01 mm

± 1.6 mm

b 17.501 mm

± 0.8 mm

b_1 14.3 mm

± 0.8 mm

B max. 21.006 mm

r max. 3.18 mm