

# 99157

## Dimensions

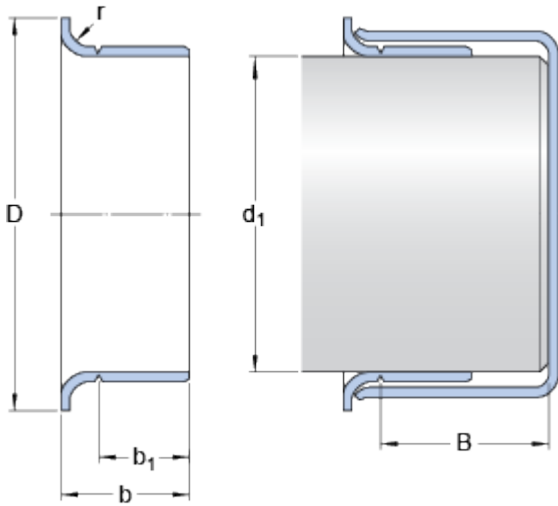

### Shaft diameter range

$d_1$  min. 39.929 mm

$d_1$  max. 40.081 mm

### Nominal dimensions

$d_1$  40 mm

$D$  46.99 mm

$\pm$  1.6 mm

$b$  16.002 mm

$\pm$  0.8 mm

$b_1$  13.005 mm

$\pm$  0.8 mm

$B$  max. 25.984 mm

$r$  max. 3.18 mm