

99152

Dimensions

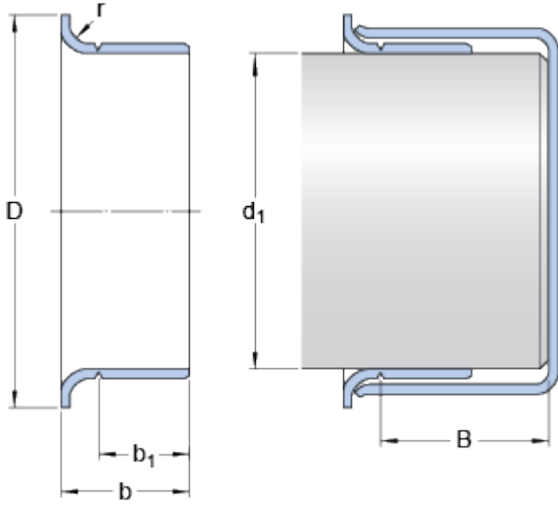

Shaft diameter range

d_1	min.	38.608	mm
d_1	max.	38.76	mm

Nominal dimensions

d_1		38.684	mm
D		47.219	mm
	±	1.6	mm
b		14.3	mm
	±	0.8	mm
b_1		11.125	mm
	±	0.8	mm
B	max.	25.806	mm
r	max.	3.18	mm