

99150

Dimensions

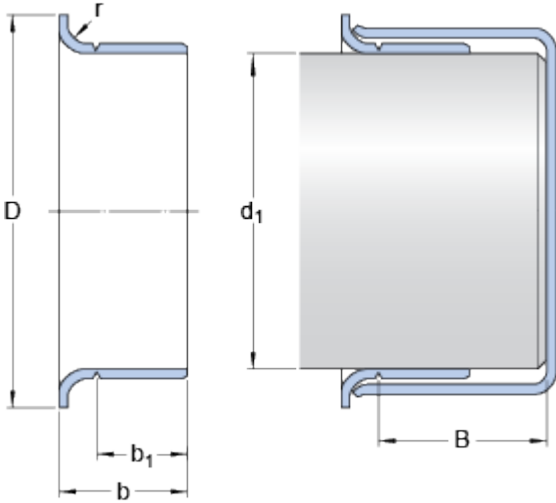

Shaft diameter range

d_1 min. 38.024 mm

d_1 max. 38.176 mm

Nominal dimensions

d_1 38.1 mm

D 45.237 mm

\pm 1.6 mm

b 12.7 mm

\pm 0.8 mm

b_1 9.525 mm

\pm 0.8 mm

B max. 25.806 mm

r max. 3.18 mm