

99143

Dimensions

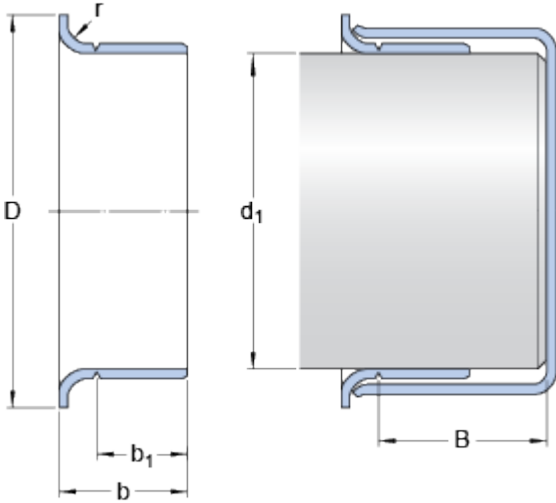

Shaft diameter range

d_1	min.	36.373	mm
d_1	max.	36.525	mm

Nominal dimensions

d_1		36.525	mm
D		45.237	mm
	\pm	1.6	mm
b		17.475	mm
	\pm	0.8	mm
b_1		14.3	mm
	\pm	0.8	mm
B	max.	25.806	mm
r	max.	3.18	mm