

# 99131

## Dimensions

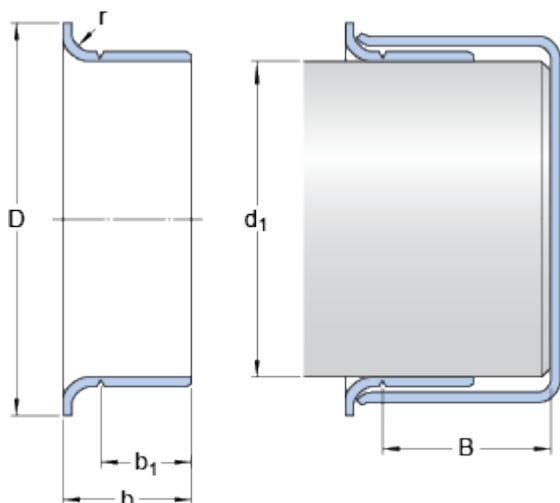

### Shaft diameter range

$d_1$  min. 33.274 mm

$d_1$  max. 33.426 mm

### Nominal dimensions

$d_1$  33.35 mm

$D$  40.488 mm

$\pm$  1.6 mm

$b$  15.875 mm

$\pm$  0.8 mm

$b_1$  12.7 mm

$\pm$  0.8 mm

$B$  max. 20.65 mm

$r$  max. 3.18 mm