

99087

Dimensions

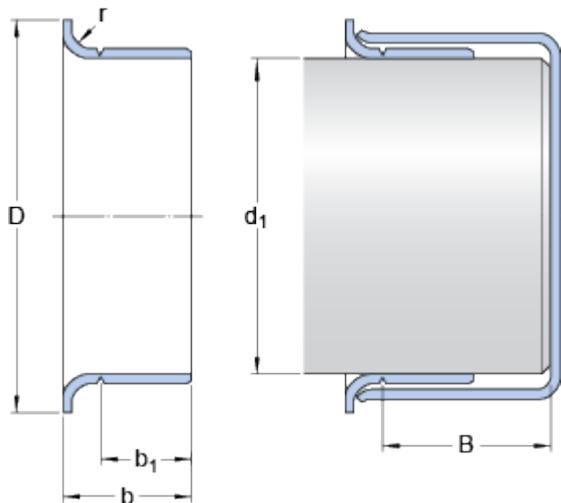

Shaft diameter range

d_1 min. 22.174 mm

d_1 max. 22.276 mm

Nominal dimensions

d_1 22.225 mm

D 27.788 mm

± 1.6 mm

b 11.125 mm

± 0.8 mm

b_1 7.95 mm

± 0.8 mm

B max. 50.8 mm

r max. 3.18 mm