

99050

Dimensions

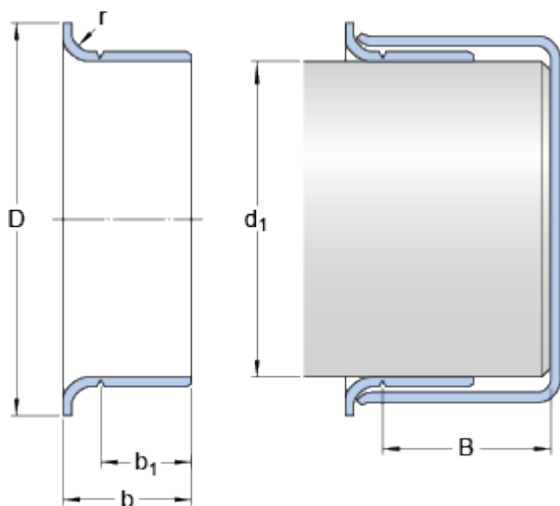

Shaft diameter range

d_1 min. 12.649 mm

d_1 max. 12.751 mm

Nominal dimensions

d_1 12.7 mm

D 15.494 mm

\pm 1.6 mm

b 8.738 mm

\pm 0.8 mm

b_1 6.35 mm

\pm 0.8 mm

B max. 50.8 mm

r max. 3.18 mm