

SIRCO



**HEAVY DUTY
REPLACEMENT PARTS**
FOR TRUCKS, TRAILERS & TRACTORS

The Best Value in Truck Parts

TABLE OF CONTENTS

	<u>PAGE</u>
AIR SPRINGS.....	250 - 273
AIR SYSTEM PARTS.....	209 - 216
AXLE NUTS AND WRENCHES.....	188 - 193
BEARINGS AND SEALS.....	217 - 219
BRAKE HARDWARE KITS.....	2 - 34
BRAKE PARTS.....	38 - 61
CAMSHAFT ENCLOSURE TUBES/BRACKETS.....	120 - 121
CAMSHAFT PARTS.....	149 - 166
CAMSHAFT REPAIR KITS.....	122 - 148
CAMSHAFTS.....	75 - 119
FASTENERS.....	198 - 199
FIFTH WHEEL COMPONENTS.....	200 - 208
HUB CAPS AND GASKETS.....	194 - 197
INDEX.....	350 - 358
INTERCHANGES.....	274 - 349
LINED BRAKE SHOES AND BOX O'BRAKES.....	35 - 37
SLACK ADJUSTERS.....	62 - 74
SUSPENSION PARTS.....	220 - 249
WHEEL ATTACHING PARTS.....	167 - 187

Manufacturers' and replacement parts suppliers' names and numbers are used for reference purposes only, and, it is not implied any part listed is a product of these manufacturers or suppliers.

ACKNOWLEDGEMENTS

Printed by Multicopy Corporation, Northfield, Illinois

Composition by Susan Papa

Photography by Kerry Glassman

BRAKE KIT QUICK CROSS-REFERENCE

KITS INTERCHANGE FUNCTIONALLY, SOME PARTS MAY DIFFER

DESCRIPTION	FMS NUMBER	SIRCO	PAGE	AUTOMANN	BATCO
B E N D I X					
15" Front Brake	4693 (4")	FF-1	16		08-114000
Less Anchor Pin	4693 (4")	FF-1A	16		08-114002
15" Spring Kit	4693 (4")	FF-1S	16		08-114052
16-1/2" Rear Brake	4515E (7")	FR-1	21		08-114200
Less Anchor Pin & Bushing	4515E (7")	FR-1A	21		08-114212
16-1/2" Spring Kit	4515E (7")	FR-1S	21		

BPW-BERGISCHE ACHSEN					
16.53" Chassis Brake Minor Kit	1477TT (7.08")	KK-1A	33		08-115012

D A N A					
12-1/4" "U" Brake - Old Style	4692 (7-1/2")	LB-7	10		08-105100
12-1/4" "U" Brake - New Style	4692 (7-1/2")	LB-6	10		08-114601
	4692 (7-1/2")	LB-8	10		08-114600
12-1/4" w/Fabricated Shoes	4536 (5-1/2"), 4591 (7-1/2")	LB-1	10	100.4591.30	08-107400
	4536 (5-1/2"), 4692 (7-1/2")	LB-2	11	100.4692.13	08-114401
	4536 (5-1/2"), 4692 (7-1/2")	LB-9	11	100.4692.14	08-114400
	4661 (5"), 4536 (5-1/2"), 4692 (7-1/2")	LB-10	11	100.4692.15	
	4661 (5"), 4536 (5-1/2"), 4692 (7-1/2")	LB-10R	11		08-104900
	4661 (5"), 4536 (5-1/2"), 4692 (7-1/2")	LB-11	11	100.4692.16	
	4661 (5"), 4536 (5-1/2"), 4692 (7-1/2")	LB-11R	11		08-105000
	4661 (5"), 4536 (5-1/2"), 4692 (7-1/2")	LB-12	12		
	4661 (5"), 4536 (5-1/2"), 4692 (7-1/2")	LB-12R	12		08-105010
12-1/4" Special Kit	4661 (5"), 4536 (5-1/2"), 4692 (7-1/2")	LB-10S	12		
15" "HA" Steer & Lift Axle	4693 (4")	SF-1	16		08-116600
16-1/2" "Fast Change" & "XLII" - See Meritor "Q" / "Q-Plus"					
16-1/2" "XL"	4701 (7")	XL-1	22	100.4701.10	08-116260

D E X T E R					
12-1/4" w/Fabricated Shoes	4700 (4"), 4661C (5")	LB-1	13	100.4591.30	08-107400
	4661 (5"), 4536 (5-1/2"), 4692 (7-1/2")	LB-10D	13		08-104800
12-1/4" "PQ"	4700 (4"), 4661C (5"), 4591 (7-1/2")	LB-3D	13	100.4591.20	08-104700

E A T O N					
12-1/4" S.A.P. Brake	4591 (7-1/2")	LB-4	14		08-107600
	4591 (7-1/2")	LB-4A	14		08-107602
15" S.A.P. Front	1308 (4"), 1443TT (3.95")	EF-1	17	100.1308.30	08-111300 1308E00
15" "ES" Front	4716 (6")	ES-3	17		08-104300
15" "ES-II" Front	4716 (6")	ES-3R	17		08-104400
	4729 (4")	ES-5	17	100.4729.10	08-114700
15" "ES" Drive Axle	4717 (8-5/8")	ES-4	18	100.4717.10	08-104330
15" "ES-II" Drive Axle	4717 (8-5/8")	ES-4R	18		08-104430
16-1/2" S.A.P. Brake	4223A (5"), 4317G (6"), 4311J (7"), 4674 (8-5/8")	EK-1HD	22	100.4311.10	08-104200 431101

BRAKE KIT QUICK CROSS-REFERENCE

KITS INTERCHANGE FUNCTIONALLY, SOME PARTS MAY DIFFER

BWP	EUCLID	HALDEX	LELAND	MERITOR	OEM	SPICER
M-K94	E-7231	CQ65519	K-297 K-298	R507080	104627	HK70
M-K119	E-7232				104623	
M-K95	E-7237	CQ65520	K-299 K-300	R507081	104628	HK71
M-K121	E-7238			R507082	104624	

			K-379		R9000B	
--	--	--	-------	--	--------	--

M-K104	E-5306	CQ67396	K-137	R507078		
M-K83	E-3782 E-9283	CQ69002 CQ69006	K-279 K-336	R507076 R507090		HK47XLS-125 HK47XLS-150
M-K12	E-2402HD	CQ67398	K-352	R507015	M12LK101X	HK43XLS
M-K80	E-3373HD E-9281	CQ67403 CQ67405	K-277 K-335	R507074 R507088		HK48XLS-125 HK48XLS-150
M-K108	E-10756	CQ67437	K-373 K-501	R507092		
M-K109	E-10757	CQ67436	K-377	R507093	M12KBH10	
M-K117						
						HK49-150
M-K120	E-11493	CQ69008	K-374	R507096		HK95XLS
M-K91	E-5515	CQ65515	K-305	R507063		HK32SD

M-K12	E-2402HD	CQ67398	K-352	R507015	K71-98	HK43XLS
M-K118			K-353			
M-K112	E-10875	CQ65620	K-369	R507095	K71-460-00	HK58XLS

M-K46	E-2126	CQ67388	K-106	R507000		HK40
M-K77	E-5139 E-1308E	CQ66917	K-263 1308E	R507004 MKT1308E	1008306	HK54
M-K114	E-9141	CQ66947	K-356	R507086	823141	HK90XLS
M-K122	E-11981	CQ69007				HK97XLS
M-K115	E-9039	CQ66948	K-358	R507083	815626	HK91XLS
M-K10	E-1887SHD	CQ67319	K-42	R507002	1001238	HK24SLM
M-K99	E-4311EHD		K-119	MKT4311EHDK		HK24SDLM

BRAKE KIT QUICK CROSS-REFERENCE

KITS INTERCHANGE FUNCTIONALLY, SOME PARTS MAY DIFFER

DESCRIPTION	FMS NUMBER	SIRCO	PAGE	AUTOMANN	BATCO
E A T O N (cont'd)					
16-1/2" Spring Kit	4223A (5"), 4317G (6"), 4311J (7"), 4674 (8-5/8")	K-2	22		
16-1/2" S.A.P. Ford	4223 (5"), 4317G (6"), 4311J (7")	EK-3	23	100.4311.12	08-104220
16-1/2" "ES-II" Front	4719 (5"), 4725 (6")	EF-2	23	100.4719.10	08-114920
16-1/2" "ES" & "ES-II"	4709 (7")	ES-12	24		470999
16-1/2" "ES" Brake	4709 (7")	ES-1	23	100.4709.10	08-114800 470901
16-1/2" Spring Kit	4709 (7")	K-3	23		
	4719 (5"), 4725 (6"), 4709 (7"), 4726 (8-5/8")	K-4	24		08-114950
16-1/2" "ES-II"	4719 (5"), 4725 (6"), 4709 (7"), 4726 (8-5/8")	ES-2	24	100.4709.11	08-114900 470902
16-1/2" Top Spec Fruehauf	4708 (7")	EX-1	25		08-115800/05
16-1/2" Top Spec Meritor "Q"	4708 (7")	EQ-1	25	100.4708.11	08-115400/05
16-1/2" Top Spec "P"	4708 (7")	ET-1	25		08-115500/05
18" S.A.P. Brake	4527B (7")	EK-2	33	100.4527.10	08-109600

FRUEHAUF					
12-1/4" "Propar"	4649 (8")	LB-5	14		08-107700
16-1/2" #5	4515 (7"), 4551 (8-5/8")	FK-2	26		08-100601/05
	4515 (7"), 4551 (8-5/8")	FK-2HD	26		08-100661/65
16-1/2" "Propar"	4515 (7"), 4551 (8-5/8")	FK-1	26		08-100600/04
	4515 (7"), 4551 (8-5/8")	FK-1HD	26		08-100660/64
16-1/2" "XEM" Early	4515 (7"), 4551 (8-5/8")	XK-1	26		08-109001/05
	4515 (7"), 4551 (8-5/8")	XK-1HD	26	100.4515.34	08-109031/35
16-1/2" "XEM" 3 Premium	4515 (7"), 4551 (8-5/8")	XK-3MP	27		08-109100/04
	4515 (7"), 4551 (8-5/8")	XK-3MPHD	27		08-109130/34
16-1/2" "XEM" 3 Standard	4515 (7"), 4551 (8-5/8")	XK-3	27	100.4515.31	08-109101/05 4515X01
	4515 (7"), 4551 (8-5/8")	XK-3HD	27	100.4515.32	08-109131/35 4515X31

H E N D R I C K S O N - See Meritor "Q" / "Q-Plus"

M A C K					
15" "Q-Plus" Front	4702 (4"), 4703 (5"), 4704 (6"), 4705 (7")	RF-6	18		08-116030/40
16-1/2" Meritor "Q" Front	4524B (5"), 4514G (6")	MF-1	28	100.4524.10	08-111600/05
	4524B (5"), 4720 (5"), 4514G (6"), 4715 (6")	MF-2	28	100.4524.11	08-111630/35
16-1/2" "FL" Series	4524B (5"), 4514G (6")	MF-3	28		08-116700/05
16-1/2" w/Bushed Shoes	4549C (4"), 4524B (5"), 4514G (6"), 4515E (7")	TK-7	29		08-108200/05
	4549C (4"), 4524B (5"), 4514G (6"), 4515E (7")	TK-7HD	29		08-108260/65

BRAKE KIT QUICK CROSS-REFERENCE

KITS INTERCHANGE FUNCTIONALLY, SOME PARTS MAY DIFFER

BWP	EUCLID	HALDEX	LELAND	MERITOR	OEM	SPICER
M-K123						
M-K6	E-3801	CQ69004	K-316	R507077		HK24XLSHM
M-K113	E-10760	CQ65446	K-376	R507094	314146	HK62
M-K124			K-495			
M-K84	E-5481A E-4709ES E-11318 E-11319	CQ65481 CQ65416	K-295 4709ES1	R507057 MKT4709ES	808330	HK63
M-K105	E-10244/S E-4709ES2	CQ65477	K-375 4709ES2	R507064 MKT4709ES2	314147	HK61/SD/XLS
M-K130	E-8923	CQ65478		R507061	5-3321	HK65SD
M-K131	E-8925 E-8925SHD	CQ65479	K-322	R507062	5-3319	HK67XLS
M-K132		CQ65495	K-364		5-3320	HK69XLS
M-K58	E-2821	CQ67406	K-275	R507072	1005006	HK26

M-K47	E-2286 KIT 5	CQ67394	K-105 K-58	R507005 R507013		HK41
M-K5					MBCBK0014	
	E-2121S	CQ67316	K-43	R507011	MBCBK0013	HK17XLS
M-K8	E-2121SHD	CQ67399		R507012	ACC001996-902	
	E-4880S	CQ67401	K-127	R507006		
M-K41	E-4880SHD	CQ66875		R507007		HK31XLS
	E-3710HD		K-136 K-372			
	E-3710S	CQ66913	K-315	R507008		HK34XLS
	E-4515X		4515X	MKT4515XK		
M-K42/XHD	E-3710SHD E-4515XHD	CQ66914	K-330	R507010 MKT4515XHDK		HK34SD

--	--	--	--	--	--	--

			K-504K			
M-K92	E-3858	CQ69005	K-292			HK81XLS
M-K106	E-9644	CQ66887	K-334/K-334K 4524MQ	KIT 8081		HK74XLS
	E-9070	CQ66889	K-366	KIT 8037		HK80XLS
				R509004		
M-K56	E-1607HD	CQ67357	K-46	R509409		HK75SD

BRAKE KIT QUICK CROSS-REFERENCE

KITS INTERCHANGE FUNCTIONALLY, SOME PARTS MAY DIFFER

DESCRIPTION	FMS NUMBER	SIRCO	PAGE	AUTOMANN	BATCO
M A C K (cont'd)					
16-1/2" Meritor	4625B (7")	MK-1HD	29		08-108300
16-1/2" Meritor 50,000#	4515H (7")	MK-2	29		08-111500
	4515H (7")	MK-2HD	29		08-111560

MERITOR					
12-1/4" "Q" Brake	4670 (7-1/2")	LB-3	14		08-109300
14-1/2" Coach - Steer	4227G (4"), 4398B (5"), 4228B (6")	BK-145F	15		08-125100
	4227G (4"), 4398B (5"), 4228B (6")	BK-145FM	15		08-125102
14-1/2" Coach - Drive	4592A (10")	BK-145R	15		08-125300
15" "Q" Front	1308TT (4")	RF-3	19	100.1308.10	08-111100 1308Q00
	1308TT (4")	RF-3A	19	100.1308.12	08-111102 1308Q02
15" "Q-Plus" Front	4702 (4"), 4703 (5"), 4704 (6"), 4705 (7")	RF-5	19	100.4702.10	08-116000/04 4702Q00
15" "T" Hold Down	1307 (3-1/2"), 1308 (4")	ARK	19	100.1308.21	01-390
15" "T" Front	1307 (3-1/2"), 1308 (4")	RF-1ARK	20	100.1308.20	08-110700
	1307 (3-1/2"), 1308 (4")	RF-2ARK	20	100.1308.22	08-110702
16-1/2" w/Bushed Shoe	4549C (4"), 4524B (5"), 4514G (6"), 4515E (7")	TK-7	30		08-108200/05
	4549C (4"), 4524B (5"), 4514G (6"), 4515E (7")	TK-7HD	30	100.4515.16	08-108260/65
16-1/2" "P" Brake	4549C (4"), 4524B (5"), 4514G (6") 4515E (7"), 4551E (8-5/8"), 4567A (10")	TK-1	30	100.4515.14	08-100100/05
	4549C (4"), 4524B (5"), 4514G (6") 4515E (7"), 4551E (8-5/8"), 4567A (10")	TK-1HD	30		08-100160/65
16-1/2" "Q"/"Q-Plus" Premium	4549C (4")	QK-1MP QK-1MPHD	30 30	100.4515.21	08-108804 08-108834
16-1/2" "Q"/"Q-Plus"	4524B (5"), 4720 (5")	QK-1	31	100.4515.23	08-108800 4515Q00
	4514G (6"), 4715 (6")	QK-1HD	31	100.4515.22	08-108830 4515Q30
	4515E (7"), 4707 (7")	QK-1HDO	31		08-108839
16-1/2" "Q"/"Q-Plus" Minor	4718 (8"), 4551E (8-5/8")	QK-8	31	100.4515.25	08-108810/14 4515Q10
	4711 (8-5/8")	QK-8HD	31	100.4515.26	08-108840/44 4515Q40
	4514G (10")	QK-2S	31	100.4515.40	08-108812/16 4515Q12
		QK-2SHD	31	100.4515.41	08-108842/46 4515Q42
16-1/2" Spring Kit	N/A	K-1	32		
	N/A	K-1A	32		
16-1/2" "P" Cast	4515 (7")	RK-3	34		
18" Cast - Old Style	4471B (7")	RK-1	33	100.4471.10	08-109830
18" Cast - New Style	4471B (7")	RK-2	33		08-109800

BRAKE KIT QUICK CROSS-REFERENCE

KITS INTERCHANGE FUNCTIONALLY, SOME PARTS MAY DIFFER

BWP	EUCLID	HALDEX	LELAND	MERITOR	OEM	SPICER
M-K54	E-2675HD	CQ67356	K-77	R509406		HK19SD
M-K93	E-5086	CQ62767	K-293M	KIT 8026HD		HK82SD
M-K45	E-3484	CQ67395	K-154	KIT 8004		HK44XLS
	E-10841			KIT 6004		HK87
	E-10866	CQ69012				HK86
	E-10870			KIT 6003		HK84
M-K79	E-3869	CQ69001	K-283	KIT 8029		HK55
	E-1308Q		LBW1308Q	MKT1308Q		
M-K79B	E-7899	CQ67899	K-282	KIT 8061		HK77
	E-1308QMA		1308Q			
M-K98	E-9064	CQ65642	K-318	KIT 8824HD		HK66XLS
	E-4702		K-318K	MKT4702KTK		
M-2720	E-4800	CQ66759	K-259(2)	KIT 9425		19-921
M-K52	E-4691	CQ66919	K-260	KIT 9094		HK51
	E-1308T			MKT1308T		
	E-6879	CQ69003	K-265	KIT 1125		HK50
M-K56	E-1607HD	CQ67357	K-46	R509004 R509409		HK75SD
	KIT 4S	CQ67315	K-44A	KIT 9017N		HK16
M-K3	KIT 4SHD	CQ67390	K-115	R509002		HK16XLS
M-K4						
			K-70/K-117			
	E-2769HD		K-128/K-128K			HK29SD
	E-2769S	CQ66861	K-306	KIT 8000		HK29
	E-4515Q		4515AQ	MKT4515QK		
M-K39	E-2769SHD	CQ66867	K-329/K-332	KIT 8000HD		HK29XLS
M-K72	E-4515QHD		4515AQHD	MKT4515QHDK		
	E-6999S	CQ66878	K-70A	KIT 8000MB		
	E-4515QMB		4515AQM	MKT4515QMBK		
	E-6999SHD	CQ66882	K-128A	KIT 8000MBHD		
	E-4515QMBHD		4515AQMHD	MKT4515QMBHDK		
	E-3895S	CQ6861	K-303	KIT 8014		HK38
	E-4515U		K-303K	MKT4515UK		
	E-3895SHD	CQ6867	K-304/K-304K	KIT 8014HD		
	E-4515UHD		4515QMMHD	MKT4515UHDK		
M-K125			K-320(2)	KIT 8002HD(2)		
		CQ69010	K-320	KIT 8002HD		
	E-11974			KIT 9081		
M-K59	E-3518	CQ67407	K-274	KIT 9179		HK68
	E-3992	CQ67408	K-281	R509408		HK76

BRAKE REPAIR KITS

DANA 12-1/4" OLD STYLE "U" BRAKE

	LB-7	REPLACES		
	2 - B132 Pin 2 - B133 Roller 2 - B217 Anchor Pin 1 - B218 Retainer 1 - B307 Spring 2 - B358 Retainer 2 - B379 Lock	Batco 08-105100 BWP M-K104 Euclid E-5306 Haldex CQ67396 Leland K-137 Meritor R507078		
	FMS LINING NUMBER(S) 4692 (7-1/2")			

DANA 12-1/4" NEW STYLE "U" BRAKE - "FC" SERIES

	LB-6	REPLACES		
	2 - B151 Retainer 2 - B217 Anchor Pin 1 - B218 Retainer 1 - B307 Spring 2 - B423 Pin 2 - B911 Roller "Fast Rise" Cams July 1989-1994	LB-6	LB-8	
		Batco 08-114601 BWP M-K83 Euclid E-3782 Haldex CQ69002 Leland K-279 Meritor R507076 Spicer HK47XLS-125	08-114600 E-9283 CQ69006 K-336 R507090 HK47XLS-150	
	LB-8	FMS LINING NUMBER(S)		
2 - B586 Roller (Replaces B911) For New Head Design Camshafts Since July 1994	4692 (7-1/2")			

DANA 12-1/4" "FT" WITH CLOSED ROLLER END

	LB-1	REPLACES		
	2 - B132 Pin 2 - B133 Roller 2 - B216 Anchor Pin 1 - B307 Spring 2 - B358 Retainer 2 - B362 Bushing 2 - B379 Lock 4 - B380 Lock 4 - B392 Washer	Automann 100.4591.30 Batco 08-107400 BWP M-K12 Euclid E-2402HD Haldex CQ67398 Leland K-352 Meritor R507015 Spicer HK43XLS M12LK101X		
	FMS LINING NUMBER(S) 4536 (5-1/2") 4591 (7-1/2")			

BRAKE REPAIR KITS

DANA 12-1/4" "FT" WITH OPEN ROLLER END

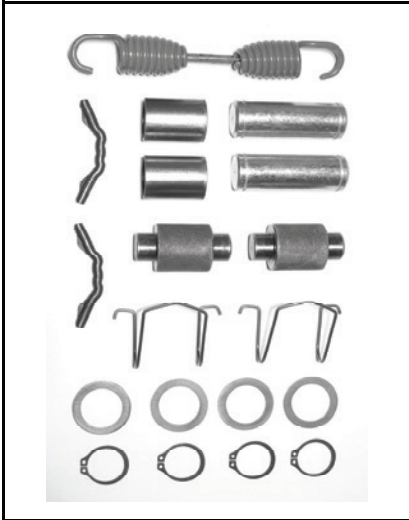
	LB-2	REPLACES	
	2 - B151 Retainer 2 - B216 Anchor Pin 1 - B307 Spring 2 - B362 Bushing 4 - B380 Lock 4 - B392 Washer 2 - B423 Pin 2 - B911 Roller "Fast Rise" Cams July 1989-1994	LB-2	LB-9
		Automann 100.4692.13 Batco 08-114401 BWP M-K80 Euclid E-3373HD Haldex CQ67403 Leland K-277 Meritor R507074 Spicer HK48XLS-125	100.4692.14 08-114400 E-9281 CQ67405 K-335 R507088 HK48XLS-150
	LB-9	FMS LINING NUMBER(S)	
	2 - B586 Roller (Replaces B911) For New Head Design Camshafts Since July 1994	4536 (5-1/2") 4692 (7-1/2")	

DANA 12-1/4" "FC-III" TRAILER AXLE

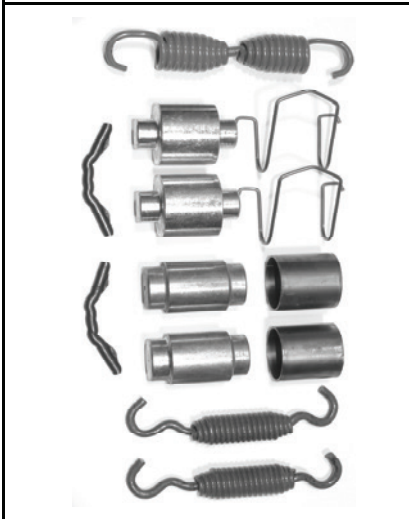
	LB-10	REPLACES	
	2 - B120 Anchor Pin 2 - B151 Retainer 2 - B220 Spring 1 - B307 Spring 2 - B423 Pin 2 - B586 Roller 2 - B888 Bushing	LB-10	LB-10R
		Automann 100.4692.15 Batco BWP M-K108 Euclid E-10756 Haldex CQ67437 Leland K-373 Meritor R507092	08-104900 K-501
	LB-10R	FMS LINING NUMBER(S)	
	2 - B434S Spring (Replaces B220)	4661 (5") 4536 (5-1/2") 4692 (7-1/2")	

RETRO-FITS SPIDERS WITH 1" ANCHOR PIN TO "FC-III" SHOE

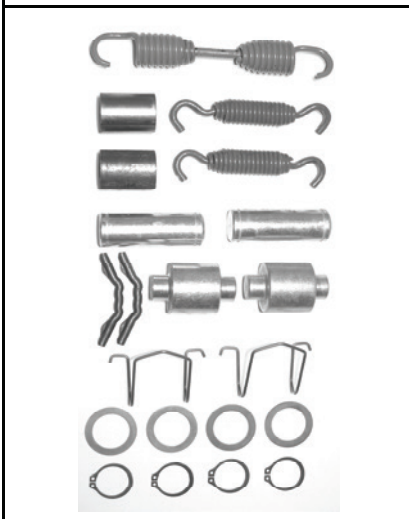
	LB-11	REPLACES	
	2 - B151 Retainer 2 - B216 Anchor Pin 2 - B220 Spring 1 - B307 Spring 2 - B362 Bushing 4 - B380 Lock 4 - B392 Washer 2 - B423 Pin 2 - B586 Roller	LB-11	LB-11R
		Automann 100.4692.16 Batco BWP M-K109 Euclid E-10757 Haldex CQ67436 Leland K-377 Meritor R507093 Spicer M12KBH10	08-105000
	LB-11R	FMS LINING NUMBER(S)	
	2 - B434S Spring (Replaces B220)	4661 (5") 4536 (5-1/2") 4692 (7-1/2")	

BRAKE REPAIR KITS

RETRO-FITS SPIDERS WITH 1" ANCHOR PIN TO "FC-III" SHOE			
	LB-12	REPLACES	
	2 - B151 Retainer 2 - B216 Anchor Pin 2 - B220 Spring 1 - B307 Spring 2 - B362 Bushing 4 - B380 Lock 4 - B392 Washer 2 - B423 Pin 2 - B911 Roller	LB-12	LB-12R
	LB-12R 2 - B434S Spring (Replaces B220)	Batco BWP	M-K117
		FMS LINING NUMBER(S) 4661 (5") 4536 (5-1/2") 4692 (7-1/2")	

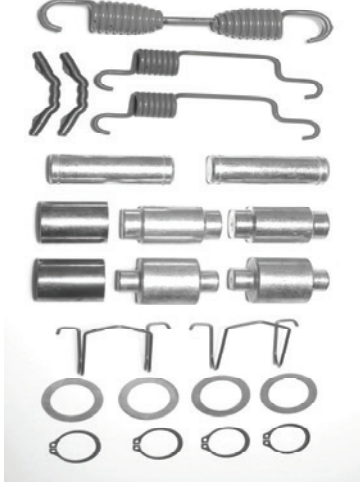
SPECIAL KIT CONTAINS 1" AND 1-1/4" ANCHOR PINS				
	LB-10S	REPLACES		
	2 - B120 Anchor Pin 2 - B151 Retainer 2 - B216 Anchor Pin 1 - B307 Spring 4 - B380 Lock 4 - B392 Washer 2 - B423 Pin 2 - B434 Spring 2 - B586 Roller 2 - B888 Bushing	Spicer	HK49-150	
			FMS LINING NUMBER(S) 4661 (5") 4536 (5-1/2") 4692 (7-1/2")	

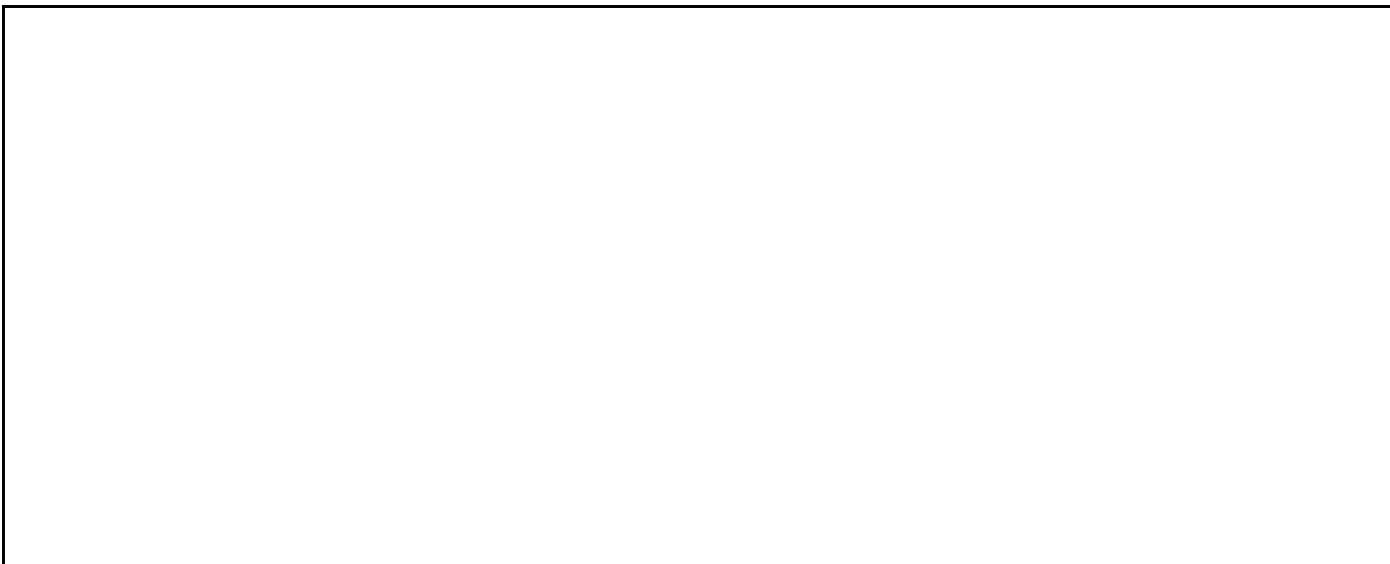

BRAKE REPAIR KITS

DEXTER 12-1/4" WITH 1" ANCHOR PIN

	LB-1		REPLACES	
		2 - B132	Pin	Automann
2 - B133		Roller	Batco	08-107400
	2 - B216	Anchor Pin	BWP	M-K12
	1 - B307	Spring	Dexter	K71-98
	2 - B358	Retainer	Euclid	E-2402HD
	2 - B362	Bushing	Haldex	CQ67398
	2 - B379	Lock	Leland	K-352
	4 - B380	Lock	Meritor	R507015
	4 - B392	Washer	Spicer	HK43XLS
FMS LINING NUMBER(S)				
4700 (4") 4661C (5")				

DEXTER 12-1/4" WITH 1-1/4" ANCHOR PIN AND ROLLER

	LB-10D		REPLACES	
		2 - B120	Anchor Pin	Batco
2 - B151		Retainer	BWP	
	2 - B220	Spring	Leland	K-353
	1 - B307	Spring		
	2 - B423	Pin		
	2 - B888	Bushing		
	2 - B911	Roller		
FMS LINING NUMBER(S)				
4661 (5") 4536 (5-1/2") 4692 (7-1/2")				

DEXTER 12-1/4" "PQ" BRAKE

	LB-3D		REPLACES	
		2 - B120	Anchor Pin	Automann
2 - B132		Roller Pin	Batco	08-104700
	2 - B133	Roller	BWP	M-K112
	2 - B220	Spring	Dexter	K71-460-00
	1 - B307	Spring	Euclid	E-10875
	2 - B379	Lock	Haldex	CQ65620
	2 - B423	Pin	Leland	K-369
	2 - B888S	Stainless Bushing	Meritor	R507095
FMS LINING NUMBER(S)				
4700 (4") 4661C (5") 4591 (7-1/2")				

BRAKE REPAIR KITS

EATON 12-1/4" SINGLE ANCHOR PIN BRAKE

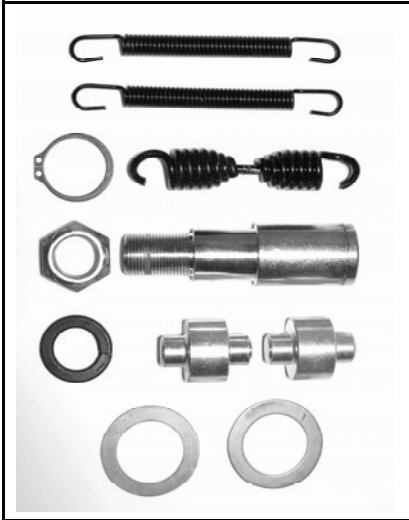
	LB-4	REPLACES							
	1 - B424 Anchor Pin 2 - B425 Roller 1 - B426 Spring 2 - B427 Spring 1 - B428 Washer 1 - B429 Nut 1 - B8604 Lock 2 - B8607 Washer	<table border="1" style="width: 100%; border-collapse: collapse;"> <tr> <th style="width: 20%;"></th> <th style="width: 40%;">LB-4</th> <th style="width: 40%;">LB-4A</th> </tr> <tr> <td style="vertical-align: top;"> Batco BWP Euclid Haldex Leland Meritor Spicer </td> <td style="vertical-align: top;"> 08-107600 M-K46 E-2126 CQ67388 R507000 HK40 </td> <td style="vertical-align: top;"> 08-107602 K-106 </td> </tr> </table>		LB-4	LB-4A	Batco BWP Euclid Haldex Leland Meritor Spicer	08-107600 M-K46 E-2126 CQ67388 R507000 HK40	08-107602 K-106	
		LB-4	LB-4A						
Batco BWP Euclid Haldex Leland Meritor Spicer	08-107600 M-K46 E-2126 CQ67388 R507000 HK40	08-107602 K-106							
LB-4A	FMS LINING NUMBER(S)								
Above Less: 1 - B424 Anchor Pin 1 - B428 Washer 1 - B429 Nut	4591 (7-1/2")								

FRUEHAUF "PROPAR" 12-1/4" BRAKE

	LB-5	REPLACES			
	2 - B054 Roller 2 - B423 Pin 2 - B495 Bushing 2 - B832 Anchor Pin 2 - B868 Retainer 1 - B869 Spring 2 - B932 Lock	<table border="1" style="width: 100%; border-collapse: collapse;"> <tr> <td style="vertical-align: top;"> Batco BWP Euclid Haldex Leland Meritor Spicer </td> <td style="vertical-align: top;"> 08-107700 M-K47 E-2286 CQ67394 K-105 R507005 HK41 </td> </tr> </table>	Batco BWP Euclid Haldex Leland Meritor Spicer	08-107700 M-K47 E-2286 CQ67394 K-105 R507005 HK41	
	Batco BWP Euclid Haldex Leland Meritor Spicer	08-107700 M-K47 E-2286 CQ67394 K-105 R507005 HK41			
	FMS LINING NUMBER(S)				
	4649 (8")				

MERITOR 12-1/4" "Q" BRAKE

	LB-3	REPLACES			
	2 - B120 Anchor Pin 2 - B134 Roller Pin 2 - B135 Roller 2 - B220 Spring 1 - B308 Spring 4 - B379 Lock 2 - B423 Pin 2 - B888 Bushing	<table border="1" style="width: 100%; border-collapse: collapse;"> <tr> <td style="vertical-align: top;"> Batco BWP Euclid Haldex Leland Meritor Spicer </td> <td style="vertical-align: top;"> 08-109300 M-K45 E-3484 CQ67395 K-154 KIT 8004 HK44XLS </td> </tr> </table>	Batco BWP Euclid Haldex Leland Meritor Spicer	08-109300 M-K45 E-3484 CQ67395 K-154 KIT 8004 HK44XLS	
	Batco BWP Euclid Haldex Leland Meritor Spicer	08-109300 M-K45 E-3484 CQ67395 K-154 KIT 8004 HK44XLS			
	FMS LINING NUMBER(S)				
	4670 (7-1/2")				

BRAKE REPAIR KITS

MERITOR 14-1/2" "W" SERIES COACH BRAKE - STEER AXLE		
	BK-145F	REPLACES
	2 - BP-100 Spring 1 - BP-101 Lock 1 - BP-102 Lock Screw 1 - BP-103 Washer 2 - BP-104 Anchor Pin 2 - BP-105 Roller 2 - BP-112 Fitting	Batco 08-125100 Euclid E-10841 Meritor KIT 6004 Spicer HK87
	FMS LINING NUMBER(S) 4227G (4") 4398B (5") 4228B (6")	

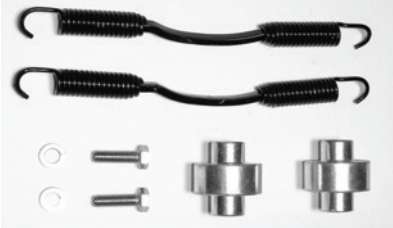
MERITOR 14-1/2" "W" SERIES COACH BRAKE - STEER AXLE		
	BK-145FM	REPLACES
	2 - BP-100 Spring 2 - BP-102 Lock Screw 2 - BP-103 Washer 2 - BP-105 Roller	Batco 08-125102 Euclid E-10866 Haldex CQ69012 Spicer HK86
	FMS LINING NUMBER(S) 4227G (4") 4398B (5") 4228B (6")	

MERITOR 14-1/2" "W" SERIES COACH BRAKE - DRIVE AXLE		
	BK-145R	REPLACES
	1 - BP-106 Spring 4 - BP-107 Lock 2 - BP-108 Bushing 2 - BP-109 Roller 2 - BP-110 Anchor Pin 2 - BP-111 Lock	Batco 08-125300 Euclid E-10870 Meritor KIT 6003 Spicer HK84
	FMS LINING NUMBER(S) 4592A (10")	

BRAKE REPAIR KITS

BENDIX 15" FRONT AXLE BRAKE				
	FF-1		REPLACES	
			FF-1	FF-1A
	2 - B136 Roller Pin 2 - B137 Roller 1 - B138 Anchor Pin 1 - B139 Spring 2 - B140 Spring	Batco 08-114000 Bendix 104627 BWP M-K94 Euclid E-7231 Haldex CQ65519 Leland K-297 Meritor R507080 Spicer HK70	08-114002 K-298	
	FF-1A	FMS LINING NUMBER(S)		
Above Less: 1 - B138 Anchor Pin	4693 (4")			

BENDIX 15" FRONT AXLE BRAKE - SPRINGS ONLY				
	FF-1S		REPLACES	
	2 - B139 Spring 4 - B140 Spring	Batco 08-114052 Bendix 104623 BWP M-K119 Euclid E-7232		
	FMS LINING NUMBER(S)			
	4693 (4")			

DANA 15" "HA" SERIES STEER AND LIFT AXLE				
	SF-1		REPLACES	
	1 - B142 Spring 2 - B151 Retainer 2 - B220 Spring 2 - B423 Pin 2 - B586 Roller	Batco 08-116600 BWP M-K120 Euclid E-11493 Haldex CQ69008 Leland K-374 Meritor R507096 Spicer HK95XLS		
	FMS LINING NUMBER(S)			
	4693 (4")			

BRAKE REPAIR KITS

EATON 15" "EB" AND "ES" SERIES

	EF-1	REPLACES
	1 - B562 Spring 2 - B725 Roller 1 - B999 Spring	Automann 100.1308.30 Batco 08-111300/1308E00 BWP M-K77 Eaton 1008306 Euclid E-5139 E-1308E Haldex CQ66917 Leland K-263/1308E Meritor R507004 MKT1308E Spicer HK54
	FMS LINING NUMBER(S) 1443TT (3.95") 1308 (4")	

EATON 15" x 6" "ES" AND "ES-II" REDUCED ENVELOPE FRONT BRAKE

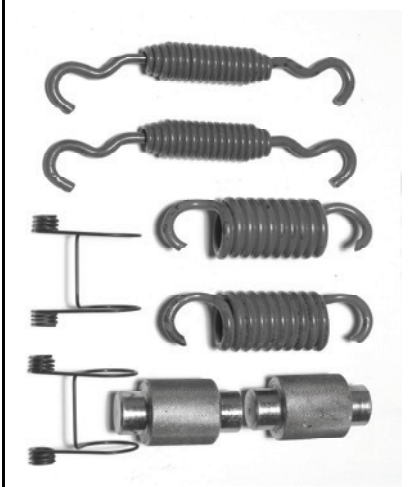
	ES-3	REPLACES	
	2 - B220 Spring 2 - B430K Roller 2 - B431 Retainer 2 - B433 Spring	ES-3	ES-3R
	2 - B434 Spring (Replaces B220)	Batco 08-104300 BWP M-K114 Eaton 823141 Euclid E-9141 Haldex CQ66947 Leland K-356 Meritor R507086 Spicer HK90XLS	08-104400
FMS LINING NUMBER(S) 4716 (6")			

EATON 15" "ES-II" FRONT BRAKE

	ES-5	REPLACES
	2 - B430K Roller 2 - B431 Retainer 2 - B434 Spring 1 - B435 Spring	Automann 100.4729.10 Batco 08-114700 BWP M-K122 Euclid E-11981 Haldex CQ69007 Spicer HK97XLS
	FMS LINING NUMBER(S) 4729 (4")	

BRAKE REPAIR KITS

EATON 15" x 8-5/8" "ES" AND "ES-II" REDUCED ENVELOPE BRAKE DRIVE AXLE

	ES-4	REPLACES	
	2 - B220 Spring 2 - B430K Roller 2 - B431 Retainer 1 - B436 Spring	ES-4	ES-4R
		Automann 100.4717.10 Batco 08-104330 BWP M-K115 Eaton 815626 Euclid E-9039 Haldex CQ66948 Leland K-358 Meritor R507083 Spicer HK91XLS	08-104430
	ES-4R	FMS LINING NUMBER(S)	
	2 - B434 Spring (Replaces B220)	4717 (8-5/8")	

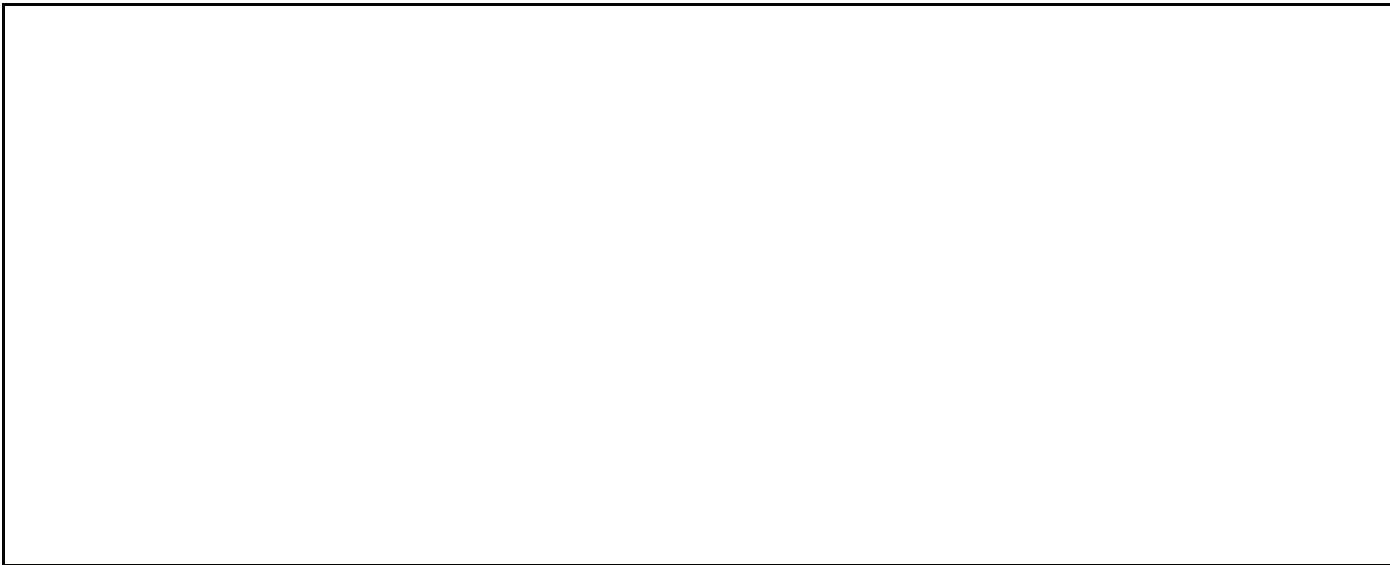

MACK 15" "Q-PLUS" FRONT BRAKE

	RF-6	REPLACES	
	2 - B120 Anchor Pin 2 - B161 Retainer 2 - B220 Spring 2 - B423 Pin 2 - B888S Bushing 2 - B911 Roller 1 - B957 Spring	Batco	08-116030/40
		Leland	K-504K
		FMS LINING NUMBER(S)	
		4702 (4")	4703 (5")
		4704 (6")	4705 (7")

BRAKE REPAIR KITS

MERITOR 15" "Q" FRONT BRAKE																																					
	RF-3	<table style="width: 100%; border-collapse: collapse;"> <tr><td style="width: 10%;">2 - 073</td><td>Lock Nut</td></tr> <tr><td>2 - B725</td><td>Roller</td></tr> <tr><td>2 - B950</td><td>Anchor Pin</td></tr> <tr><td>1 - B951</td><td>Wear Plate</td></tr> <tr><td>1 - B952</td><td>Spring</td></tr> <tr><td>1 - B953</td><td>Spring</td></tr> <tr><td>2 - B954</td><td>Washer</td></tr> <tr><td>2 - B955</td><td>Clip</td></tr> </table>	2 - 073	Lock Nut	2 - B725	Roller	2 - B950	Anchor Pin	1 - B951	Wear Plate	1 - B952	Spring	1 - B953	Spring	2 - B954	Washer	2 - B955	Clip																			
	2 - 073	Lock Nut																																			
	2 - B725	Roller																																			
2 - B950	Anchor Pin																																				
1 - B951	Wear Plate																																				
1 - B952	Spring																																				
1 - B953	Spring																																				
2 - B954	Washer																																				
2 - B955	Clip																																				
RF-3A	<table style="width: 100%; border-collapse: collapse;"> <tr><td style="width: 10%;">2 - B725</td><td>Roller</td></tr> <tr><td>1 - B952</td><td>Spring</td></tr> <tr><td>1 - B953</td><td>Spring</td></tr> </table>	2 - B725	Roller	1 - B952	Spring	1 - B953	Spring																														
2 - B725	Roller																																				
1 - B952	Spring																																				
1 - B953	Spring																																				
<table style="width: 100%; border-collapse: collapse;"> <thead> <tr> <th colspan="3" style="text-align: center; padding: 5px;">REPLACES</th> </tr> <tr> <th style="width: 10%;"></th> <th style="width: 20%; text-align: center; padding: 5px;">RF-3</th> <th style="width: 20%; text-align: center; padding: 5px;">RF-3A</th> </tr> </thead> <tbody> <tr> <td style="padding: 5px;">Automann</td> <td style="padding: 5px;">100.1308.10</td> <td style="padding: 5px;">100.1308.12</td> </tr> <tr> <td style="padding: 5px;">Batco</td> <td style="padding: 5px;">08-111100/1308Q00</td> <td style="padding: 5px;">08-111102/1308Q02</td> </tr> <tr> <td style="padding: 5px;">BWP</td> <td style="padding: 5px;">M-K79</td> <td style="padding: 5px;">M-K79B</td> </tr> <tr> <td style="padding: 5px;">Euclid</td> <td style="padding: 5px;">E-3869</td> <td style="padding: 5px;">E-7899</td> </tr> <tr> <td></td> <td style="padding: 5px;">E-1308Q</td> <td style="padding: 5px;">E-1308QMA</td> </tr> <tr> <td style="padding: 5px;">Haldex</td> <td style="padding: 5px;">CQ69001</td> <td style="padding: 5px;">CQ67899</td> </tr> <tr> <td style="padding: 5px;">Leland</td> <td style="padding: 5px;">K-283/LBW1308Q</td> <td style="padding: 5px;">K-282/1308Q</td> </tr> <tr> <td style="padding: 5px;">Meritor</td> <td style="padding: 5px;">KIT 8029</td> <td style="padding: 5px;">KIT 8061</td> </tr> <tr> <td></td> <td style="padding: 5px;">MKT1308Q</td> <td></td> </tr> <tr> <td style="padding: 5px;">Spicer</td> <td style="padding: 5px;">HK55</td> <td style="padding: 5px;">HK77</td> </tr> </tbody> </table>		REPLACES				RF-3	RF-3A	Automann	100.1308.10	100.1308.12	Batco	08-111100/1308Q00	08-111102/1308Q02	BWP	M-K79	M-K79B	Euclid	E-3869	E-7899		E-1308Q	E-1308QMA	Haldex	CQ69001	CQ67899	Leland	K-283/LBW1308Q	K-282/1308Q	Meritor	KIT 8029	KIT 8061		MKT1308Q		Spicer	HK55	HK77
REPLACES																																					
	RF-3	RF-3A																																			
Automann	100.1308.10	100.1308.12																																			
Batco	08-111100/1308Q00	08-111102/1308Q02																																			
BWP	M-K79	M-K79B																																			
Euclid	E-3869	E-7899																																			
	E-1308Q	E-1308QMA																																			
Haldex	CQ69001	CQ67899																																			
Leland	K-283/LBW1308Q	K-282/1308Q																																			
Meritor	KIT 8029	KIT 8061																																			
	MKT1308Q																																				
Spicer	HK55	HK77																																			
<p style="text-align: center;">FMS LINING NUMBER(S)</p> <p style="text-align: center;">1308TT (4")</p>																																					

MERITOR 15" "Q-PLUS" FRONT AND DRIVE AXLE BRAKES																																					
	RF-5	<table style="width: 100%; border-collapse: collapse;"> <tr><td style="width: 10%;">2 - B120</td><td>Anchor Pin</td></tr> <tr><td>2 - B161</td><td>Retainer</td></tr> <tr><td>2 - B220</td><td>Spring</td></tr> <tr><td>2 - B423</td><td>Pin</td></tr> <tr><td>2 - B888S</td><td>Bushing</td></tr> <tr><td>2 - B911</td><td>Roller</td></tr> <tr><td>1 - B956</td><td>Spring</td></tr> </table>	2 - B120	Anchor Pin	2 - B161	Retainer	2 - B220	Spring	2 - B423	Pin	2 - B888S	Bushing	2 - B911	Roller	1 - B956	Spring																					
	2 - B120	Anchor Pin																																			
	2 - B161	Retainer																																			
2 - B220	Spring																																				
2 - B423	Pin																																				
2 - B888S	Bushing																																				
2 - B911	Roller																																				
1 - B956	Spring																																				
RF-5	<table style="width: 100%; border-collapse: collapse;"> <tr><td style="width: 10%;">2 - B120</td><td>Anchor Pin</td></tr> <tr><td>2 - B161</td><td>Retainer</td></tr> <tr><td>2 - B220</td><td>Spring</td></tr> <tr><td>2 - B423</td><td>Pin</td></tr> <tr><td>2 - B888S</td><td>Bushing</td></tr> <tr><td>2 - B911</td><td>Roller</td></tr> <tr><td>1 - B956</td><td>Spring</td></tr> </table>	2 - B120	Anchor Pin	2 - B161	Retainer	2 - B220	Spring	2 - B423	Pin	2 - B888S	Bushing	2 - B911	Roller	1 - B956	Spring																						
2 - B120	Anchor Pin																																				
2 - B161	Retainer																																				
2 - B220	Spring																																				
2 - B423	Pin																																				
2 - B888S	Bushing																																				
2 - B911	Roller																																				
1 - B956	Spring																																				
<table style="width: 100%; border-collapse: collapse;"> <thead> <tr> <th colspan="3" style="text-align: center; padding: 5px;">REPLACES</th> </tr> </thead> <tbody> <tr> <td style="padding: 5px;">Automann</td> <td style="padding: 5px;">100.4702.10</td> <td></td> </tr> <tr> <td style="padding: 5px;">Batco</td> <td style="padding: 5px;">08-116000/04/4702Q00</td> <td></td> </tr> <tr> <td style="padding: 5px;">BWP</td> <td style="padding: 5px;">M-K98</td> <td></td> </tr> <tr> <td style="padding: 5px;">Euclid</td> <td style="padding: 5px;">E-9064</td> <td></td> </tr> <tr> <td></td> <td style="padding: 5px;">E-4702</td> <td></td> </tr> <tr> <td style="padding: 5px;">Haldex</td> <td style="padding: 5px;">CQ65642</td> <td></td> </tr> <tr> <td style="padding: 5px;">Leland</td> <td style="padding: 5px;">K-318</td> <td></td> </tr> <tr> <td></td> <td style="padding: 5px;">K-318K</td> <td></td> </tr> <tr> <td style="padding: 5px;">Meritor</td> <td style="padding: 5px;">KIT 8824HD</td> <td></td> </tr> <tr> <td></td> <td style="padding: 5px;">MKT4702KTK</td> <td></td> </tr> <tr> <td style="padding: 5px;">Spicer</td> <td style="padding: 5px;">HK66XLS</td> <td></td> </tr> </tbody> </table>		REPLACES			Automann	100.4702.10		Batco	08-116000/04/4702Q00		BWP	M-K98		Euclid	E-9064			E-4702		Haldex	CQ65642		Leland	K-318			K-318K		Meritor	KIT 8824HD			MKT4702KTK		Spicer	HK66XLS	
REPLACES																																					
Automann	100.4702.10																																				
Batco	08-116000/04/4702Q00																																				
BWP	M-K98																																				
Euclid	E-9064																																				
	E-4702																																				
Haldex	CQ65642																																				
Leland	K-318																																				
	K-318K																																				
Meritor	KIT 8824HD																																				
	MKT4702KTK																																				
Spicer	HK66XLS																																				
<p style="text-align: center;">FMS LINING NUMBER(S)</p> <p style="text-align: center;">4702 (4") 4703 (5") 4704 (6") 4705 (7")</p>																																					

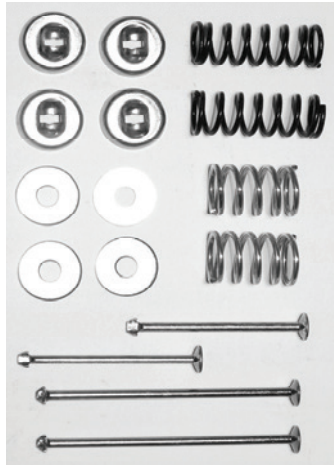
MERITOR 15" "T" SERIES HOLD DOWN KIT																												
	ARK	<p style="text-align: center;">Parts Not Sold Separately</p>																										
	ARK	<p style="text-align: center;">Parts Not Sold Separately</p>																										
	<table style="width: 100%; border-collapse: collapse;"> <thead> <tr> <th colspan="3" style="text-align: center; padding: 5px;">REPLACES</th> </tr> </thead> <tbody> <tr> <td style="padding: 5px;">Automann</td> <td style="padding: 5px;">100.1308.21</td> <td></td> </tr> <tr> <td style="padding: 5px;">Batco</td> <td style="padding: 5px;">01-390</td> <td></td> </tr> <tr> <td style="padding: 5px;">BWP</td> <td style="padding: 5px;">M-2720</td> <td></td> </tr> <tr> <td style="padding: 5px;">Euclid</td> <td style="padding: 5px;">E-4800</td> <td></td> </tr> <tr> <td style="padding: 5px;">Haldex</td> <td style="padding: 5px;">CQ66759</td> <td></td> </tr> <tr> <td style="padding: 5px;">Leland</td> <td style="padding: 5px;">K-259(2)</td> <td></td> </tr> <tr> <td style="padding: 5px;">Meritor</td> <td style="padding: 5px;">KIT 9425</td> <td></td> </tr> <tr> <td style="padding: 5px;">Spicer</td> <td style="padding: 5px;">19-921</td> <td></td> </tr> </tbody> </table>		REPLACES			Automann	100.1308.21		Batco	01-390		BWP	M-2720		Euclid	E-4800		Haldex	CQ66759		Leland	K-259(2)		Meritor	KIT 9425		Spicer	19-921
REPLACES																												
Automann	100.1308.21																											
Batco	01-390																											
BWP	M-2720																											
Euclid	E-4800																											
Haldex	CQ66759																											
Leland	K-259(2)																											
Meritor	KIT 9425																											
Spicer	19-921																											
<p style="text-align: center;">FMS LINING NUMBER(S)</p> <p style="text-align: center;">1307 (3-1/2") 1308 (4")</p>																												

BRAKE REPAIR KITS

MERITOR 15" "T" SERIES FRONT BRAKE

	RF-1ARK	REPLACES	
	RF-1ARK	RF-2ARK	
	2 - 073 Lock Nut 1 - ARK Hold Down Kit 2 - B262 Anchor Pin 2 - B556 Washer 1 - B579 Spring 2 - B725 Roller 2 - B793 Lock	Automann 100.1308.20 Batco 08-110700 BWP M-K52 Euclid E-4691 E-1308T Haldex CQ66919 Leland K-260 Meritor KIT 9094 MKT1308T Spicer HK51	100.1308.22 08-110702 E-6879 CQ69003 K-265 KIT 1125 HK50
RF-2ARK	FMS LINING NUMBER(S)		
1 - ARK Hold Down Kit 1 - B579 Spring 2 - B725 Roller 2 - B793 Lock	1307 (3-1/2") 1308 (4")		

WAGNER 15" x 4" FRONT BRAKE

	WF-1	REPLACES	
	WF-1	WF-1A	
	2 - 073 Lock Nut 2 - B725 Roller 2 - B823 Lock 4 - B829 Kit 1 - B870 Spring 2 - B898 Anchor Pin	Batco 08-109900 BWP M-K50 Euclid E-3291 Haldex CQ66926 Leland Meritor R507073 Spicer HK53 Wagner	08-109902 CQ65428 K-134 F97506
WF-1A	FMS LINING NUMBER(S)		
2 - B725 Roller 2 - B823 Lock 4 - B829 Kit 1 - B870 Spring	1308A (4")		

BRAKE REPAIR KITS

BENDIX 16-1/2" TRUCK AND TRACTOR BRAKE

	FR-1	REPLACES	
	2 - B136 Roller Pin 2 - B137 Roller 2 - B141 Anchor Pin 1 - B142 Spring 2 - B143 Spring 2 - B144 Bushing 2 - B423 Pin	FR-1	FR-1A
	Batco 08-114200 Bendix 104628 BWP M-K95 Euclid E-7237 Haldex CQ65520 Leland K-299 Meritor R507081 Spicer HK71	08-114212 K-300	
FR-1A	FMS LINING NUMBER(S)		
Above Less: 2 - B141 Anchor Pin 2 - B144 Bushing	4515E (7")		

BENDIX 16-1/2" TRUCK AND TRACTOR BRAKE - SPRINGS ONLY

	FR-1S	REPLACES	
	2 - B142 Spring 4 - B143 Spring	Bendix 104624 BWP M-K121 Euclid E-7238 Meritor R507082	
		FMS LINING NUMBER(S)	
	4515E (7")		

BRAKE REPAIR KITS

EATON 16-1/2" SINGLE ANCHOR PIN BRAKE - FORD		
	EK-3	REPLACES
	2 - B152 Roller Pin 2 - B769 Spring 2 - B942 Roller 1 - B983 Spring	Automann 100.4311.12 Batco 08-104220 BWP M-K6 Euclid E-3801 Haldex CQ69004 Leland K-316 Meritor R507077 Spicer HK24XLSHM
	For High Mount Shoes With Offset Retainer Pin	FMS LINING NUMBER(S) 4223A (5") 4317G (6") 4311J (7")

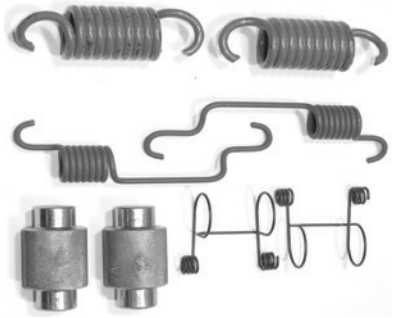
EATON 16-1/2" "ES-II" "EXTENDED SERVICE" FRONT AXLE BRAKE		
	EF-2	REPLACES
	2 - B430K Roller 2 - B431 Retainer 2 - B433 Spring 2 - B434 Spring	Automann 100.4719.10 Batco 08-114920 BWP M-K113 Eaton 314146 Euclid E-10760 Haldex CQ65446 Leland K-376 Meritor R507094 Spicer HK62
	Use With "ES-II" Shoe And "ES" Cams Only	FMS LINING NUMBER(S) 4719 (5") 4725 (6")

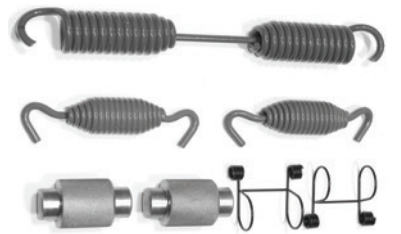
EATON 16-1/2" "ES" "EXTENDED SERVICE" BRAKE								
	ES-1	REPLACES						
	2 - B430K Roller 2 - B431 Retainer 1 - B432A Spring 2 - B769 Spring	<table border="1" style="width: 100%; border-collapse: collapse;"> <thead> <tr> <th style="width: 50%;"></th> <th style="width: 25%; text-align: center; background-color: black; color: white; font-weight: bold;">ES-1</th> <th style="width: 25%; text-align: center; background-color: black; color: white; font-weight: bold;">K-3</th> </tr> </thead> <tbody> <tr> <td style="padding: 5px;"> Automann 100.4709.10 Batco 08-114800/470901 BWP M-K84 Eaton 808330 Euclid E-5481A/E-4709ES Haldex CQ65481 Leland K-295/4709ES1 Meritor R507057 MKT4709ES Spicer HK63 </td> <td style="text-align: center; vertical-align: middle;">E-11318</td> <td></td> </tr> </tbody> </table>		ES-1	K-3	Automann 100.4709.10 Batco 08-114800/470901 BWP M-K84 Eaton 808330 Euclid E-5481A/E-4709ES Haldex CQ65481 Leland K-295/4709ES1 Meritor R507057 MKT4709ES Spicer HK63	E-11318	
		ES-1	K-3					
Automann 100.4709.10 Batco 08-114800/470901 BWP M-K84 Eaton 808330 Euclid E-5481A/E-4709ES Haldex CQ65481 Leland K-295/4709ES1 Meritor R507057 MKT4709ES Spicer HK63	E-11318							
Use Only With "ES" Camshafts	FMS LINING NUMBER(S) 4709 (7")							

BRAKE REPAIR KITS

EATON 16-1/2" "ES-II" "EXTENDED SERVICE" BRAKE																																
	ES-2		REPLACES																													
	2 - B430K Roller 2 - B431 Retainer 1 - B432A Spring 2 - B434* Spring		ES-2	K-4																												
	*Installed Coil End At Top		<table border="1" style="width: 100%; border-collapse: collapse;"> <tr> <td style="width: 10%; padding: 2px;">Automann</td> <td style="padding: 2px;">100.4709.11</td> <td style="padding: 2px;"></td> </tr> <tr> <td style="padding: 2px;">Batco</td> <td style="padding: 2px;">08-114900/470902</td> <td style="padding: 2px;">08-114950</td> </tr> <tr> <td style="padding: 2px;">BWP</td> <td style="padding: 2px;">M-K105</td> <td style="padding: 2px;"></td> </tr> <tr> <td style="padding: 2px;">Eaton</td> <td style="padding: 2px;">314147</td> <td style="padding: 2px;"></td> </tr> <tr> <td style="padding: 2px;">Euclid</td> <td style="padding: 2px;">E-10244/S/E-4709ES2</td> <td style="padding: 2px;">E-11319</td> </tr> <tr> <td style="padding: 2px;">Haldex</td> <td style="padding: 2px;">CQ65477</td> <td style="padding: 2px;">CQ65416</td> </tr> <tr> <td style="padding: 2px;">Leland</td> <td style="padding: 2px;">K-375/4709ES2</td> <td style="padding: 2px;"></td> </tr> <tr> <td style="padding: 2px;">Meritor</td> <td style="padding: 2px;">R507064</td> <td style="padding: 2px;"></td> </tr> <tr> <td style="padding: 2px;"></td> <td style="padding: 2px;">MKT4709ES2</td> <td style="padding: 2px;"></td> </tr> <tr> <td style="padding: 2px;">Spicer</td> <td style="padding: 2px;">HK61/SD/XLS</td> <td style="padding: 2px;"></td> </tr> </table>	Automann	100.4709.11		Batco	08-114900/470902	08-114950	BWP	M-K105		Eaton	314147		Euclid	E-10244/S/E-4709ES2	E-11319	Haldex	CQ65477	CQ65416	Leland	K-375/4709ES2		Meritor	R507064			MKT4709ES2		Spicer	HK61/SD/XLS
Automann	100.4709.11																															
Batco	08-114900/470902	08-114950																														
BWP	M-K105																															
Eaton	314147																															
Euclid	E-10244/S/E-4709ES2	E-11319																														
Haldex	CQ65477	CQ65416																														
Leland	K-375/4709ES2																															
Meritor	R507064																															
	MKT4709ES2																															
Spicer	HK61/SD/XLS																															
K-4		FMS LINING NUMBER(S)																														
Spring Kit 1 - B432A Spring 2 - B434 Spring Use With "ES-II" Shoe And "ES" Cams Only		4719 (5") 4725 (6") 4709 (7") 4726 (8-5/8")																														

EATON 16-1/2" "ES" AND "ES-II" DRIVE, STEER AND TRAILER AXLES												
	ES-12		REPLACES									
	2 - B430K Roller 2 - B431 Retainer 1 - B432A Spring 2 - B434 Spring 2 - B769 Spring		<table border="1" style="width: 100%; border-collapse: collapse;"> <tr> <td style="width: 10%; padding: 2px;">Batco</td> <td style="padding: 2px;">470999</td> <td style="padding: 2px;"></td> </tr> <tr> <td style="padding: 2px;">BWP</td> <td style="padding: 2px;">M-K124</td> <td style="padding: 2px;"></td> </tr> <tr> <td style="padding: 2px;">Leland</td> <td style="padding: 2px;">K-495</td> <td style="padding: 2px;"></td> </tr> </table>	Batco	470999		BWP	M-K124		Leland	K-495	
	Batco	470999										
BWP	M-K124											
Leland	K-495											
Contains Both "ES" And "ES-II" Style Retainer Spring Use B434 Only On "ES-II" Shoes		FMS LINING NUMBER(S)										
		4709 (7")										

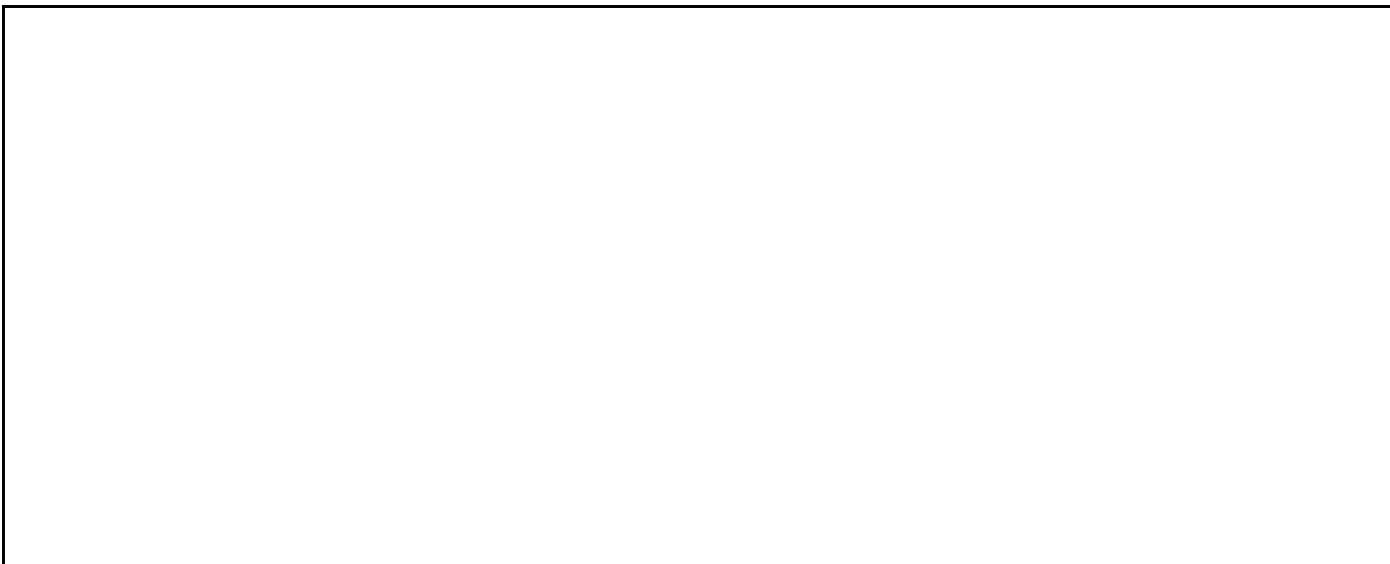



BRAKE REPAIR KITS

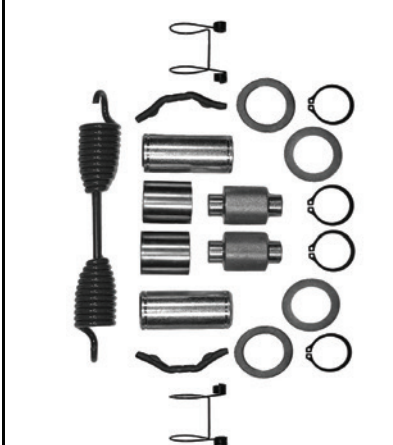

EATON RETRO-FIT 16-1/2" BRAKE FOR MERITOR "Q"			
	EQ-1	REPLACES	
	2 - B120 Anchor Pin 2 - B220 Spring 1 - B349 Heavy Duty Spring 2 - B423 Retainer 2 - B431 Retainer 2 - B888S Bushing 2 - B911 Roller	Automann 100.4708.11 Batco 08-115400/05 BWP M-K131 Euclid E-8925 E-8925SHD Haldex CQ65479 Leland K-322 Meritor R507062 Spicer HK67XLS Top Spec 5-3319	
	FMS LINING NUMBER(S) 4708 (7")		

EATON RETRO-FIT 16-1/2" FOR MERITOR "P"			
	ET-1	REPLACES	
	1 - B349 Heavy Duty Spring 2 - B423 Pin 2 - B431 Retainer 4 - B793 Lock 2 - B887 Anchor Pin 2 - B888S Bushing 2 - B911 Roller 4 - B988 Washer	Batco 08-115500/05 BWP M-K132 Haldex CQ65495 Leland K-364 Spicer HK69XLS Top Spec 5-3320	
	FMS LINING NUMBER(S) 4708 (7")		

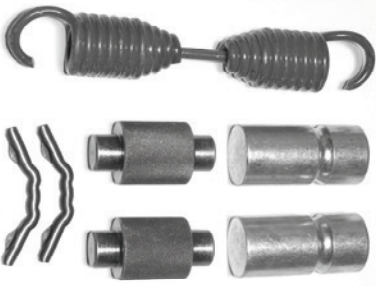
EATON RETRO-FIT 16-1/2" BRAKE FOR FRUEHAUF "XEM"			
	EX-1	REPLACES	
	2 - B220 Spring 2 - B277 Anchor Pin 1 - B349 Heavy Duty Spring 2 - B423 Pin 2 - B431 Retainer 2 - B888S Bushing 2 - B911 Roller	Batco 08-115800/05 BWP M-K130 Euclid E-8923 Haldex CQ65478 Meritor R507061 Spicer HK65SD Top Spec 5-3321	
	FMS LINING NUMBER(S) 4708 (7")		

BRAKE REPAIR KITS

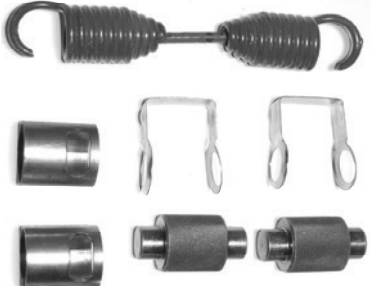
FRUEHAUF (MODIFIED #5) 16-1/2" EARLY MODEL BRAKE					
	FK-2		REPLACES		
			FK-2		FK-2HD
	2 - B151 Retainer 2 - B423 Pin 2 - B832 Anchor Pin 2 - B911 Roller 2 - B932 Lock 1 - B971 Spring	Batco BWP Euclid Fruehauf Leland Meritor	08-100601/05 KIT 5 K-58 R507013	08-100661/65 M-K5 MBCBK0014	
	FK-2HD		FMS LINING NUMBER(S)		
			4515 (7") 4551 (8-5/8")		
	1 - B728 Heavy Duty Spring (Replaces B971)				

FRUEHAUF "PROPAR" 16-1/2" BRAKE					
	FK-1		REPLACES		
			FK-1		FK-1HD
	2 - B423 Pin 2 - B495 Bushing 2 - B498 Retainer 2 - B832 Anchor Pin 2 - B911 Roller 2 - B932 Lock 1 - B971 Spring	Batco BWP Euclid Fruehauf Haldex Leland Meritor Spicer	08-100600/04 E-2121S MBCBK0013 CQ67316 K-43 R507011 HK17XLS	08-100660/64 M-K8 E-2121SHD ACC001996-902 CQ67399 R507012	
	FK-1HD		FMS LINING NUMBER(S)		
			4515 (7") 4551 (8-5/8")		
	1 - B728 Heavy Duty Spring (Replaces B971)				

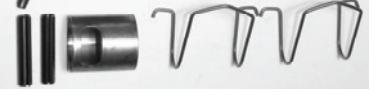
FRUEHAUF "PROPAR" 16-1/2" (EARLY MODEL) "XEM"					
	XK-1		REPLACES		
			XK-1		XK-1HD
	2 - B151 Retainer 2 - B220 Spring 1 - B302 Spring 2 - B377 Anchor Pin 2 - B423 Pin 2 - B495 Bushing 2 - B911 Roller 2 - B932 Lock	Automann Batco BWP Euclid Haldex Leland Meritor Spicer	08-109001/05 E-4880S CQ67401 K-127 R507006	100.4515.34 08-109031/35 M-K41 E-4880SHD CQ66875 R507007 HK31XLS	
	XK-1HD		FMS LINING NUMBER(S)		
			4515 (7") 4551 (8-5/8")		
	1 - B349 Heavy Duty Spring (Replaces B302)				

BRAKE REPAIR KITS

FRUEHAUF "PROPAR" 16-1/2" "XEM" BRAKE PREMIUM			
	XK-3MP	REPLACES	
	2 - B220 Spring 2 - B277 Anchor Pin 1 - B302 Spring 2 - B423 Pin 2 - B498 Retainer 2 - B888S Bushing 2 - B911 Roller 1 - 5403 Cotter Pin 1 - 9014 "O" Ring	XK-3MP	XK-3MPHD
	Batco Euclid Leland	08-109100/04	08-109130/34 E-3710HD K-136 K-372
XK-3MPHD	FMS LINING NUMBER(S)		
1 - B349 Heavy Duty Spring (Replaces B302)	4515 (7") 4551 (8-5/8")		

FRUEHAUF "PROPAR" 16-1/2" "XEM" BRAKE STANDARD DUTY			
	XK-3	REPLACES	
	2 - B161 Retainer 2 - B220 Spring 2 - B277 Anchor Pin 1 - B302 Spring 2 - B423 Pin 2 - B888 Bushing 2 - B911 Roller	XK-3	XK-3HD
	Automann Batco BWP Euclid Haldex Leland Meritor Spicer	100.4515.31 08-109101/05 4515X01 E-3710S/E-4515X CQ66913 K-315/4515X R507008 MKT4515XK HK34XLS	100.4515.32 08-109131/35 4515X31 M-K42/XHD E-3710SHD/E-4515XHD CQ66914 K-330 R507010 MKT4515XHDK HK34SD
XK-3HD	FMS LINING NUMBER(S)		
1 - B349 Heavy Duty Spring (Replaces B302)	4515 (7") 4551 (8-5/8")		

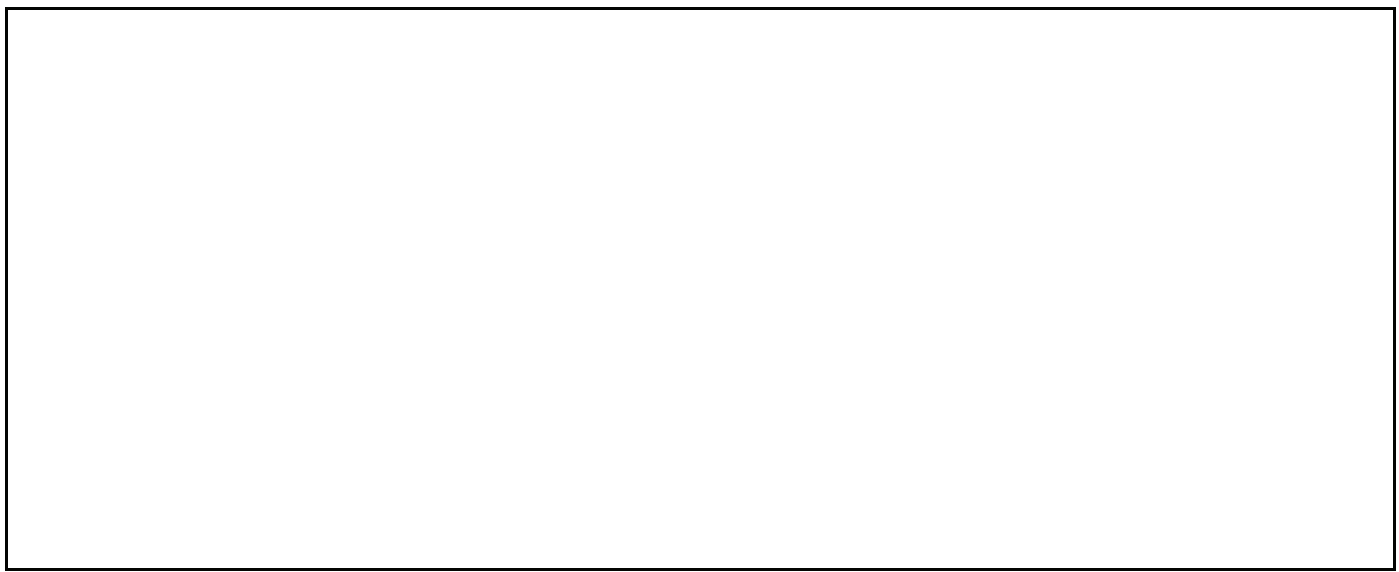

BRAKE REPAIR KITS

MACK WITH MERITOR 16-1/2" "Q" FRONT BRAKE		
	MF-1	REPLACES
	2 - B120 Anchor Pin 2 - B151 Retainer (or B161) 2 - B220 Spring 2 - B423 Pin 1 - B871 Spring 2 - B888 Bushing 2 - B911 Roller	Automann 100.4524.10 Batco 08-111600/05 BWP M-K92 Euclid E-3858 Haldex CQ69005 Leland K-292 Spicer HK81XLS
		FMS LINING NUMBER(S)
		4524B (5") 4514G (6")

MACK WITH MERITOR 16-1/2" "Q" FRONT BRAKE		
	MF-2	REPLACES
	2 - B120 Anchor Pin 2 - B151 Retainer (or B161) 2 - B220 Spring 1 - B348 Spring 2 - B423 Pin 2 - B888 Bushing 2 - B911 Roller	Automann 100.4524.11 Batco 08-111630/35 BWP M-K106 Euclid E-9644 Haldex CQ66887 Leland K-334/K-334K 4524MQ Meritor KIT 8081 Spicer HK74XLS
		FMS LINING NUMBER(S)
		4524B (5") 4720 (5") 4514G (6") 4715 (6")

MERITOR 16-1/2" "Q" FRONT BRAKE "FH" AND "FL" AXLE		
	MF-3	REPLACES
	2 - B120 Anchor Pin 2 - B151 Retainer (or B161) 2 - B220 Spring 1 - B347 Spring 2 - B423 Pin 2 - B888 Bushing 2 - B911 Roller	Batco 08-116700/05 Euclid E-9070 Haldex CQ66889 Leland K-366 Meritor KIT 8037 Spicer HK80XLS
		FMS LINING NUMBER(S)
		4524B (5") 4514G (6")

BRAKE REPAIR KITS

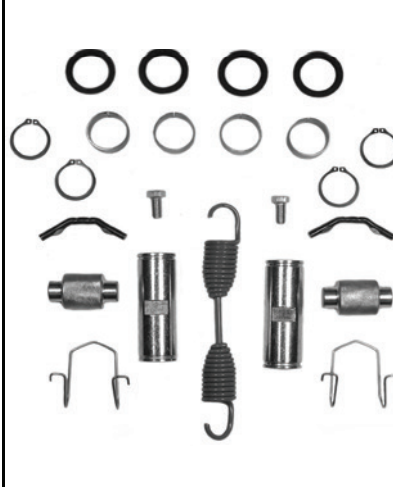
MACK 16-1/2" BRAKE WITH BUSHED HEAVY DUTY SHOE				
	TK-7		REPLACES	
			TK-7	TK-7HD
	2 - B151 Retainer 4 - B211 Bushing 2 - B311 Anchor Pin 2 - B423 Pin 4 - B501 Seal 4 - B793 Lock 2 - B861 Lock 2 - B911 Roller 1 - B971 Spring		Batco 08-108200/05 BWP Euclid Haldex Leland Meritor R509004 Spicer	08-108260/65 M-K56 E-1607HD CQ67357 K-46 R509409 HK75SD
TK-7HD		FMS LINING NUMBER(S)		
1 - B728 Heavy Duty Spring (Replaces B971)		4549C (4") 4524B (5") 4514G (6") 4515E (7")		

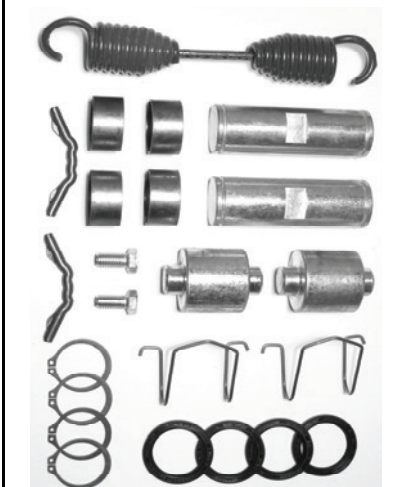
MACK WITH MERITOR 16-1/2" BRAKE				
	MK-1HD		REPLACES	
	2 - B151 Retainer 4 - B211 Bushing 2 - B311 Anchor Pin 2 - B423 Pin 4 - B501 Seal 1 - B728 Spring 4 - B793 Lock 2 - B861 Lock 2 - B922 Roller		Batco 08-108300 BWP M-K54 Euclid E-2675HD Haldex CQ67356 Leland K-77 Meritor R509406 Spicer HK19SD	
FMS LINING NUMBER(S)		4625B (7")		

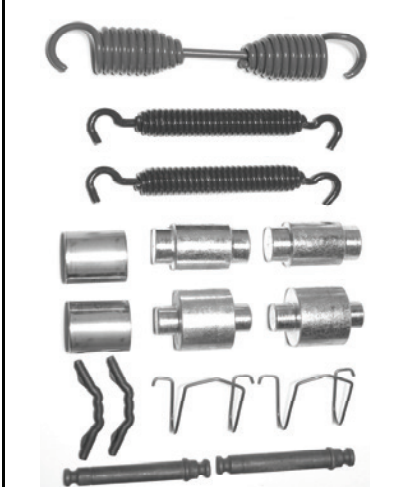
MACK WITH MERITOR "Q" BRAKE 50,000 LB. REAR AXLE				
	MK-2		REPLACES	
			MK-2	MK-2HD
	2 - B122 Anchor Pin 2 - B151 Retainer (or B161) 2 - B221 Spring 1 - B349 Heavy Duty Spring 2 - B421* Lock 2 - B422* Pin 2 - B423 Pin 2 - B888S Bushing 2 - B924 Roller		Batco 08-111500 BWP Euclid Haldex Leland Meritor Spicer	08-111560 M-K93 E-5086 CQ62767 K-293M KIT 8026HD HK82SD
MK-2HD		FMS LINING NUMBER(S)		
1 - B728 Heavy Duty Spring (Replaces B349)		4515H (7")		
* Not Available Separately				

BRAKE REPAIR KITS

16-1/2" "Q", "Q-PLUS", "FC", "XLII", "INTRAAX" BRAKE				
	QK-1		REPLACES	
	2 - B120	Anchor Pin		
	2 - B161	Retainer		
	2 - B220	Spring		
	1 - B302	Spring		
2 - B423	Pin			
2 - B888	Bushing			
2 - B911	Roller			
QK-1HD				
1 - B349	Heavy Duty Spring (Replaces B302)			
QK-1HDO				
2 - B611	Roller (Replaces B911)			
Batco	08-108839			
		REPLACES		
		QK-1	QK-1HD	
		Automann 100.4515.23	100.4515.22	
		Batco 08-108800	08-108830	
		4515Q00	4515Q30	
		BWP	M-K39/M-K72	
		Euclid E-2769S	E-2769SHD	
		E-4515Q	E-4515QHD	
		Haldex CQ66861	CQ66867	
		Leland K-306	K-329/K-332	
		4515AQ	4515AQHD	
		Meritor KIT 8000	KIT 8000HD	
		MKT4515QK	MKT4515QHDK	
		Spicer HK29	HK29XLS	
		FMS LINING NUMBER(S)		
		4549C (4")	4524B (5")	4720 (5")
		4514G (6")	4715 (6")	4515E (7")
		4707 (7")	4718 (8")	4551E (8-5/8")
		4711 (8-5/8")	4514G (10")	

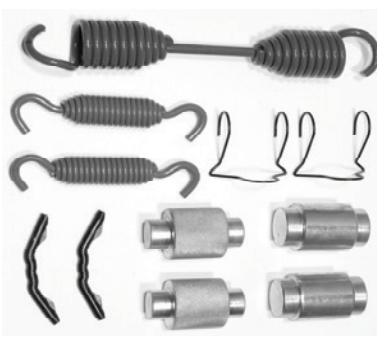
16-1/2" "Q", "Q-PLUS", "FC", "XLII", "INTRAAX" BRAKE - LESS BUSHINGS				
	QK-8		REPLACES	
	2 - B120	Anchor Pin		
	2 - B161	Retainer		
	2 - B220	Spring		
	1 - B302	Spring		
2 - B423	Pin			
2 - B911	Roller			
QK-8HD				
1 - B349	Heavy Duty Spring (Replaces B302)			
		REPLACES		
		QK-8	QK-8HD	
		Automann 100.4515.25	100.4515.26	
		Batco 08-108810/14	08-108840/44	
		4515Q10	4515Q40	
		Euclid E-6999S	E-6999SHD	
		E-4515QMB	E-4515QMBHD	
		Haldex CQ66878	CQ66882	
		Leland K-70A	K-128A	
		4515AQM	4515AQMHD	
		Meritor KIT 8000MB	KIT 8000MBHD	
		MKT4515QMBK	MKT4515QMBHDK	
		FMS LINING NUMBER(S)		
		4549C (4")	4524B (5")	4720 (5")
		4514G (6")	4715 (6")	4515E (7")
		4707 (7")	4718 (8")	4551E (8-5/8")
		4711 (8-5/8")	4514G (10")	

16-1/2" "Q", "Q-PLUS", "FC", "XLII", "INTRAAX" BRAKE - LESS BUSHINGS/ANCHOR PINS				
	QK-2S		REPLACES	
	2 - B161	Retainer		
	2 - B220	Spring		
	1 - B302	Spring		
	2 - B423	Pin		
2 - B911	Roller			
QK-2SHD				
1 - B349	Heavy Duty Spring (Replaces B302)			
		REPLACES		
		QK-2S	QK-2SHD	
		Automann 100.4515.40	100.4515.41	
		Batco 08-108812/16	08-108842/46	
		4515Q12	4515Q42	
		Euclid E-3895S/E-4515U	E-3895SHD/E-4515UHD	
		Haldex CQ66861	CQ66867	
		Leland K-303	K-304/K-304K	
		K-303K	4515QMMHD	
		Meritor KIT 8014	KIT 8014HD	
		MKT4515UK	MKT4515UHDK	
		Spicer HK38		
		FMS LINING NUMBER(S)		
		4549C (4")	4524B (5")	4720 (5")
		4514G (6")	4715 (6")	4515E (7")
		4707 (7")	4718 (8")	4551E (8-5/8")
		4711 (8-5/8")	4514G (10")	

BRAKE REPAIR KITS

SPRING KIT FOR "Q", "Q-PLUS", "FC", "XLII", "INTRAAX"				
	K-1		REPLACES	
	4 - B220 Retainer	Heavy Duty Spring	K-1	
	2 - B349		K-1A	
For (1) Axle		BWP Haldex Leland Meritor	M-K125 K-320(2) KIT 8002HD(2)	CQ69010 K-320 KIT 8002HD
K-1A				
2 - B220 Retainer				
1 - B349 Spring				
For (1) Wheel				

UNIVERSAL KIT FOR 16-1/2" BRAKE (PREMIUM)				
	TK-4MP		REPLACES	
	2 - B151 Retainer	Pin	TK-4MP	
	2 - B423		TK-4MPHD	
4 - B793 Lock	2 - B887 Anchor Pin	Batco BWP Euclid Haldex	08-100300/05	08-100360/65 M-K133 E-1816HD CQ66735
2 - B888S Stainless Bushing	2 - B911 Roller			
1 - B971 Spring	4 - B988 Washer	FMS LINING NUMBER(S) 4549C (4") 4524B (5") 4514 (6") 4515E (7") 4551E (8-5/8") 4567A (10")		
TK-4MPHD				
1 - B728 Heavy Duty Spring (Replaces B971)				

UNIVERSAL KIT FOR 16-1/2" BRAKE (STANDARD)				
	TK-4		REPLACES	
	2 - B151 Retainer	Pin	TK-4	
	2 - B423		TK-4HD	
4 - B793 Lock	2 - B887 Anchor Pin	Automann Batco BWP Euclid Haldex Leland Meritor Spicer	4515P00 E-1816S E-4515P CQ67317 R509000 MKT4515PK HK14XLS	100.4515.10 4515P60 M-K2/M-K7 E-1816SHD E-4515PHD K-45/K-116 R509001 MKT4515PHDK HK14SD
2 - B888 Bushing	2 - B911 Roller			
1 - B971 Spring	4 - B988 Washer	FMS LINING NUMBER(S) 4549C (4") 4524B (5") 4514 (6") 4515E (7") 4551E (8-5/8") 4567A (10")		
TK-4HD				
1 - B728 Heavy Duty Spring (Replaces B971)				

BRAKE REPAIR KITS

BPW - BERGISCHE ACHSEN 16.53" CHASSIS BRAKE								
	KK-1A	REPLACES						
	Minor Kit Sold Only As A Kit	<table style="width: 100%; border: none;"> <tr> <td style="width: 150px;">Batco</td> <td>08-115012</td> </tr> <tr> <td>Jost</td> <td>R9000B</td> </tr> <tr> <td>Leland</td> <td>K-379</td> </tr> </table>	Batco	08-115012	Jost	R9000B	Leland	K-379
	Batco	08-115012						
Jost	R9000B							
Leland	K-379							
FMS LINING NUMBER(S) 1477TT (7.08")								

EATON 18" SINGLE ANCHOR PIN BRAKE - CAST SHOES																												
	EK-2	REPLACES																										
	<table style="width: 100%; border: none;"> <tr> <td style="width: 100px;">2 - B053</td> <td>Roller</td> </tr> <tr> <td>2 - B154</td> <td>Roller Pin</td> </tr> <tr> <td>2 - B770</td> <td>Spring</td> </tr> <tr> <td>1 - B982</td> <td>Spring</td> </tr> </table>	2 - B053	Roller	2 - B154	Roller Pin	2 - B770	Spring	1 - B982	Spring	<table style="width: 100%; border: none;"> <tr> <td style="width: 150px;">Automann</td> <td>100.4527.10</td> </tr> <tr> <td>Batco</td> <td>08-109600</td> </tr> <tr> <td>BWP</td> <td>M-K58</td> </tr> <tr> <td>Eaton</td> <td>1005006</td> </tr> <tr> <td>Euclid</td> <td>E-2821</td> </tr> <tr> <td>Haldex</td> <td>CQ67406</td> </tr> <tr> <td>Leland</td> <td>K-275</td> </tr> <tr> <td>Meritor</td> <td>R507072</td> </tr> <tr> <td>Spicer</td> <td>HK26</td> </tr> </table>	Automann	100.4527.10	Batco	08-109600	BWP	M-K58	Eaton	1005006	Euclid	E-2821	Haldex	CQ67406	Leland	K-275	Meritor	R507072	Spicer	HK26
	2 - B053	Roller																										
2 - B154	Roller Pin																											
2 - B770	Spring																											
1 - B982	Spring																											
Automann	100.4527.10																											
Batco	08-109600																											
BWP	M-K58																											
Eaton	1005006																											
Euclid	E-2821																											
Haldex	CQ67406																											
Leland	K-275																											
Meritor	R507072																											
Spicer	HK26																											
FMS LINING NUMBER(S) 4527B (7")																												

MERITOR 18" BRAKE WITH CAST SHOES																			
	RK-1 (OLD STYLE)	REPLACES																	
	<table style="width: 100%; border: none;"> <tr> <td style="width: 100px;">4 - B211S</td> <td>Bushing</td> </tr> <tr> <td>2 - B311</td> <td>Anchor Pin</td> </tr> <tr> <td>4 - B501</td> <td>Seal</td> </tr> <tr> <td>4 - B793</td> <td>Lock</td> </tr> <tr> <td>2 - B861</td> <td>Lock</td> </tr> <tr> <td>2 - B923</td> <td>Roller</td> </tr> <tr> <td>1 - B972</td> <td>Spring</td> </tr> <tr> <td>2 - B973</td> <td>Retainer</td> </tr> </table>	4 - B211S	Bushing	2 - B311	Anchor Pin	4 - B501	Seal	4 - B793	Lock	2 - B861	Lock	2 - B923	Roller	1 - B972	Spring	2 - B973	Retainer	RK-1	RK-2
	4 - B211S	Bushing																	
	2 - B311	Anchor Pin																	
4 - B501	Seal																		
4 - B793	Lock																		
2 - B861	Lock																		
2 - B923	Roller																		
1 - B972	Spring																		
2 - B973	Retainer																		
<table style="width: 100%; border: none;"> <tr> <td style="width: 150px;">Automann</td> <td>100.4471.10</td> <td rowspan="8" style="vertical-align: top; padding: 5px;">08-109800</td> </tr> <tr> <td>Batco</td> <td>08-109830</td> </tr> <tr> <td>BWP</td> <td>M-K59</td> </tr> <tr> <td>Euclid</td> <td>E-3518</td> </tr> <tr> <td>Haldex</td> <td>CQ67407</td> </tr> <tr> <td>Leland</td> <td>K-274</td> </tr> <tr> <td>Meritor</td> <td>KIT 9179</td> </tr> <tr> <td>Spicer</td> <td>HK68</td> </tr> </table>	Automann	100.4471.10	08-109800	Batco	08-109830	BWP	M-K59	Euclid	E-3518	Haldex	CQ67407	Leland	K-274	Meritor	KIT 9179	Spicer	HK68	FMS LINING NUMBER(S) 4471B (7")	
Automann	100.4471.10	08-109800																	
Batco	08-109830																		
BWP	M-K59																		
Euclid	E-3518																		
Haldex	CQ67407																		
Leland	K-274																		
Meritor	KIT 9179																		
Spicer	HK68																		
<table style="width: 100%; border: none;"> <tr> <td style="width: 100px;">2 - B595S</td> <td>Bushing</td> </tr> <tr> <td>1 - B974</td> <td>Spring</td> </tr> </table> (Replaces B972)	2 - B595S	Bushing	1 - B974	Spring															
2 - B595S	Bushing																		
1 - B974	Spring																		
Less (2) - B973																			

BRAKE REPAIR KITS

MERITOR 16-1/2" "P" WITH CAST SHOES

	RK-3	REPLACES	
	<ul style="list-style-type: none"> 4 - B011 Felt Retainer 2 - B311 Anchor Pin 2 - B495 Bushing 4 - B793 Lock 4 - B901 Anchor Pin Felt 2 - B923 Roller 1 - B972 Spring 2 - B973 Retainer 	Euclid Meritor	E-11974 KIT 9081
			FMS LINING NUMBER(S) 4515 (7")

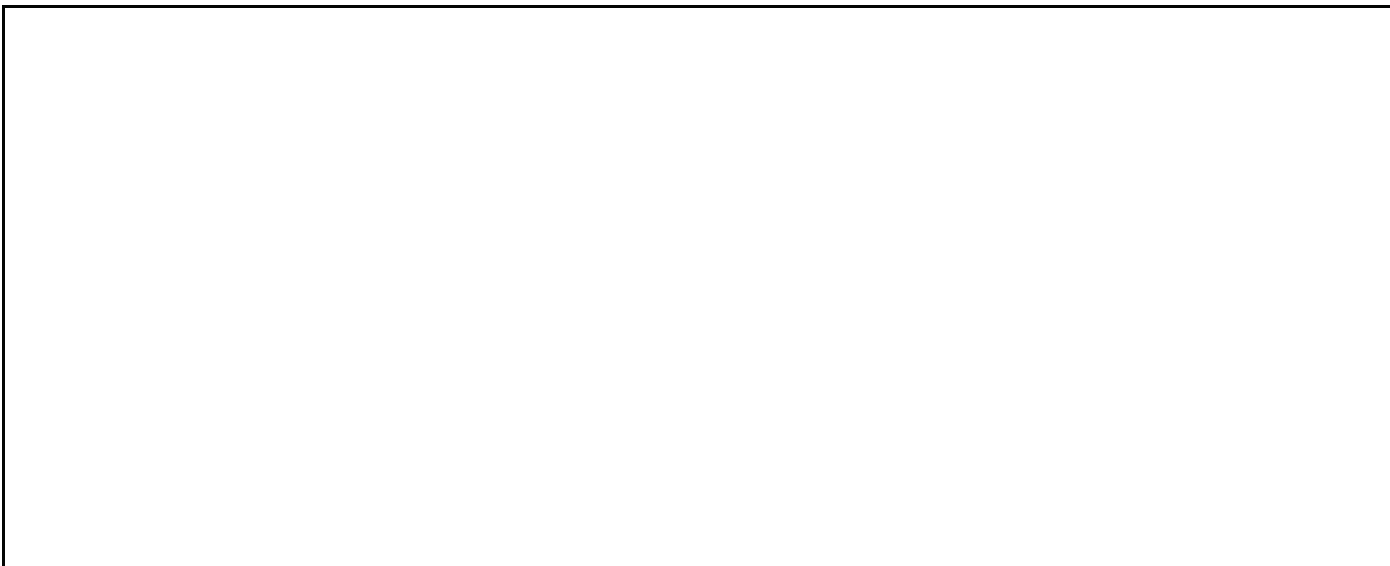
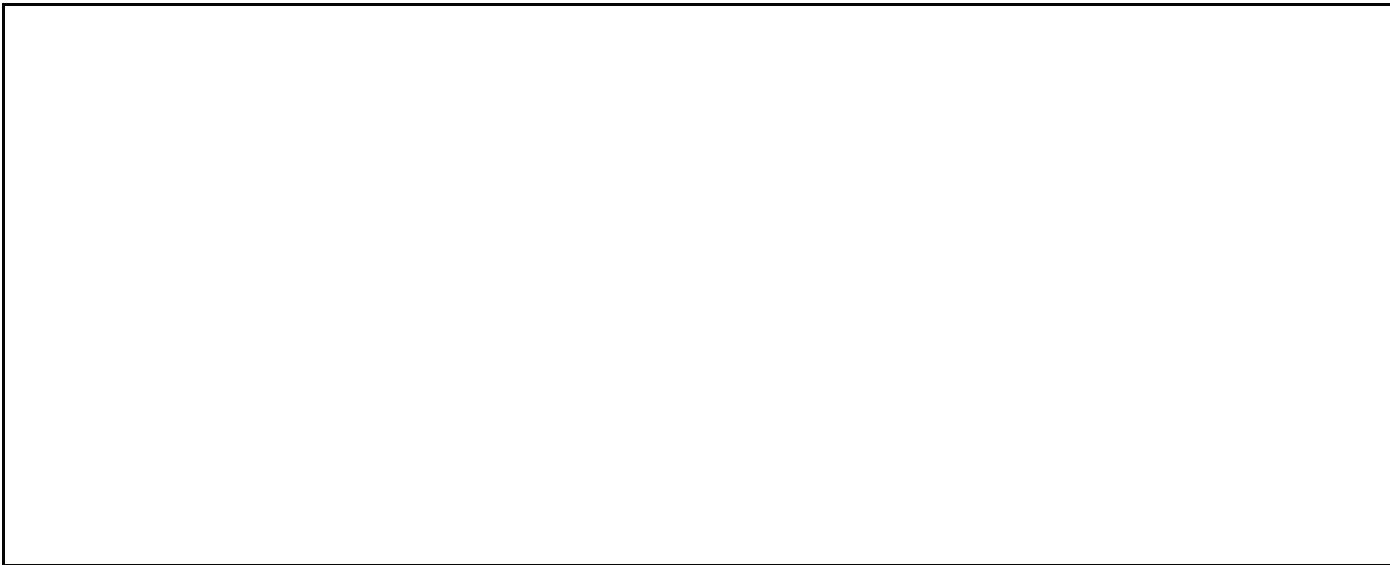

NEW LINED SHOES/LINED SHOE KITS

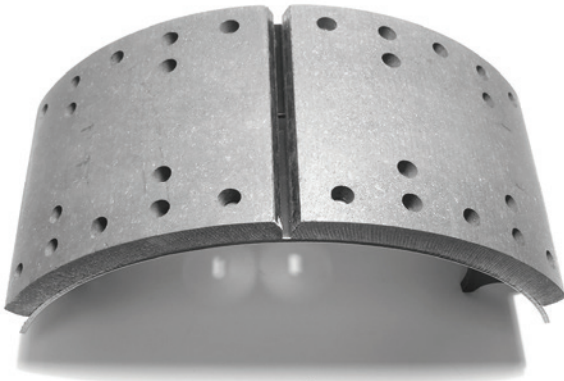

PART NO.	NOTES	REPLACES	SHOE	KIT
L1308E Lined Shoe (2) Lined Shoes With Hardware Kit EF1 L1308E-EF1	15 x 4 Eaton Front FMS No. 1308TT 23K Rating	Automann Batco Euclid Leland Meritor Spicer	143.130880.30 1308EW SF5551308 L1308E20 SF5571308E 1308ERED	144.130880.3030 1308EW00 K1308E20 KSF5571308E SB1308ERED
L1443E Lined Shoe (2) Lined Shoes With Hardware Kit EF1 L1443E-EF1	15 x 4 "ES" Eaton Front FMS No. 1443TT 23K Rating	Automann Batco Meritor Spicer	143.144380.30 1443W SMA2121443E 1443ERED	144.144380.3030 1443W00 KSMA2121443E SB1443ERED
L1308Q Lined Shoe (2) Lined Shoes With Hardware Kit RF3 L1308Q-RF3	15 x 4 "Q" Meritor Front FMS No. 1308TT 23K Rating	Automann Batco Euclid Leland Meritor Spicer	143.130882.30 1308QW L5571308Q L1308QL SF5571308Q 1308QRED	144.130882.3010 1308QW00 EK5571308Q K1308QL KSF5571308Q SB1308QRED



NEW LINED SHOES/LINED SHOE KITS

PART NO.	NOTES	REPLACES	SHOE	KIT
L4702Q Lined Shoe (2) Lined Shoes With Hardware Kit RF5 L4702Q-RF5	15 x 4 "Q-Plus" Meritor Front FMS No. 4702 23K Rating	Automann Batco Euclid Leland Meritor Spicer	143.470280.30 4702W SF5504702QP L4702Q20 SF5554702QP 4702RRED	144.470280.3010 4702W00 EK5504702QP K4702Q20 KSF5554702QP SB4702RRED
L4524M Lined Shoe (2) Lined Shoes With Hardware Kit MF2 L4524M-MF2	16-1/2 x 5 "Q" Mack FMS No. 4524B 20K Rating	Batco Leland Spicer	4524ML L4524MQ20 4524QMBLU	4524ML30 K4524MQ20 SB4524QMBLU
L4524Q Lined Shoe (2) Lined Shoes With Hardware Kit QK1HD L4524Q-QK1HD	16-1/2 x 5 "Q" Meritor FMS No. 4524B 20K Rating	Batco Leland Meritor Spicer	4524QL L4524Q20 SF5234524Q 4524QBLU	4524QL00 K4524Q20 KSF5234524Q SB4524QBLU
L4311J Lined Shoe (2) Lined Shoes With Hardware Kit EK1HD L4311J-EK1HD	16-1/2 x 7 Eaton FMS No. 4311J 23K Rating	Automann Batco Euclid Meritor Spicer	143.431180.30 4311W E-9027-78 SMA2124311J 4311EBLU	144.431180.3030 4311W00 EK5551443EM K SMA2121443EQ SB4311EBLU
L4709N Lined Shoe (2) Lined Shoes With Hardware Kit ES2 L4709N-ES2	16-1/2 x 7 "ES-II" Eaton FMS No. 4709 23K Rating	Automann Batco Euclid Leland Meritor Spicer	143.470980.30 47092W E-10272-78 L4709E23 SF5554709E2 4709EIIRED	144.470980.3011 47092W02 EK5554709E2 K4709E23 KSF5554709E2 SB4709EIIRED
L4515X Lined Shoe (2) Lined Shoes With Hardware Kit XK3HD L4515X-XK3HD	16-1/2 x 7 "XEM3" Fruehauf FMS No. 4515E 23K Rating	Automann Batco BWP Euclid Leland Meritor Spicer	143.451582.30 4515XW M-2686N E-3920-78 L4515FX323 SF5554515F3 4515X3RED	144.451582.3032 4515XW31 EK5554515F3HD K4515FX323 KSF5554515F3 SB4515X3RED

NEW LINED SHOES/LINED SHOE KITS

PART NO.	NOTES	REPLACES	SHOE	KIT
L4515Q-20 Lined Shoe (2) Lined Shoes With Hardware Kit QK1HD L4515Q-20-QK1HD	16-1/2 x 7 "Q" Meritor FMS No. 4515E 20K Rating	Automann Batco Euclid Leland Meritor Spicer	143.451584.40 4515QM E-2778-55 L4515Q20 SF5504515Q 4515QBLU	(L4515Q-20-QK1HD) 144.451582.4022 4515QM30 EK5404515QHD K4515Q20 KSF5404515Q SB4515QBLU (L4515Q-20-QK1) 4515QL00
L4515Q Lined Shoe (2) Lined Shoes With Hardware Kit QK1HD L4515Q-QK1HD	16-1/2 x 7 "Q" Meritor FMS No. 4515E 23K Rating	Automann Batco BWP Euclid Leland Meritor Spicer	143.451584.30 4515QW M-1421N E-2778-78 L4515Q23 SF5554515Q 4515QRED	144.451584.4022 4515QM31 EK5504515QHD K4515Q23 KSF5504515Q SB4515QRED
L4707Q-20 Lined Shoe (2) Lined Shoes With Hardware Kit QK1HD L4707Q-20-QK1HD	16-1/2 x 7 "Q-Plus" Meritor FMS No. 4707 20K Rating	Automann Batco Euclid Leland Meritor Spicer	143.470780.40 4707M E-5503-77 L4707Q20 SF5504707QP 4707RBLU	(L4707Q-20-QK1HD) 144.470782.4022 4707M30 EK5404707QPHD K4707Q20 KSF5404707QP SB4707RBLU (L4707Q-20-QK1) NONE
L4707 Lined Shoe (2) Lined Shoes With Hardware Kit QK1HD L4707-QK1HD	16-1/2 x 7 "Q-Plus" Meritor FMS No. 4707 23K Rating	Automann Batco Euclid Leland Meritor Spicer	143.470780.30 4707W E-5503-78 L4707Q23 SF5554707QP 4707RRED	144.470784.4022 4707M31 EK5504707QPHD K4707Q23 KSF5504707QP SB4707RRED

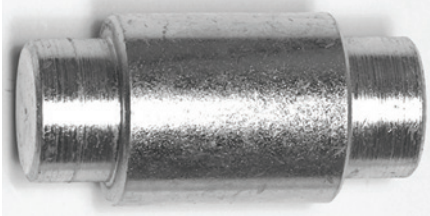
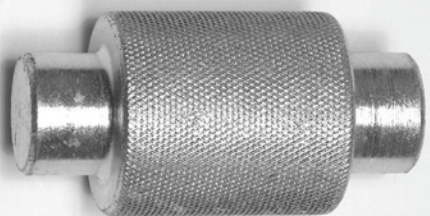
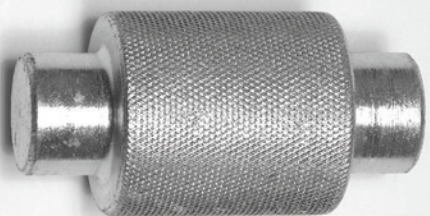

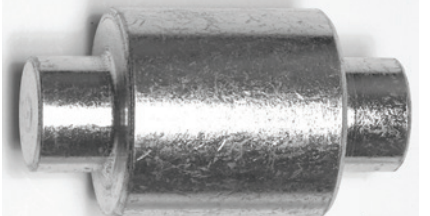
BRAKE SHOE ROLLERS

PART NO.	NOTES	REPLACES
<p data-bbox="277 243 350 275">B054</p> 	<p data-bbox="578 216 906 300">Overall Length 2-7/32" Length/Large Dia. 1-1/4" Outside Diameter 1"</p> <p data-bbox="578 331 695 359">Clear Zinc</p> <p data-bbox="578 390 834 417">"Propar" 12-1/4" Brake</p> <p data-bbox="578 449 906 476">Spicer "XL" "Xtra-Life" Brake</p>	<p data-bbox="1034 216 1276 243">Batco 01-227</p> <p data-bbox="1034 249 1276 277">BWP M-1054</p> <p data-bbox="1034 283 1276 310">Euclid E-1582</p> <p data-bbox="1034 317 1276 344">Haldex C67447</p> <p data-bbox="1034 350 1276 378">Leland L-1696</p> <p data-bbox="1034 384 1276 411">Meritor R517002</p> <p data-bbox="1034 417 1276 445">Spicer 32-1430</p>
<p data-bbox="277 669 350 701">B136</p> 	<p data-bbox="578 680 873 707">Bendix 15" x 16-1/2" Brake</p> <p data-bbox="578 739 743 766">Use With B137</p> <p data-bbox="578 795 906 879">Overall Length 2-1/4" Length/Large Dia. 1-7/16" Outside Diameter 1"</p> <p data-bbox="578 911 695 938">Clear Zinc</p> <p data-bbox="578 995 971 1022">16-1/2" Brake With Fabricated Shoe</p> <p data-bbox="578 1079 906 1163">Overall Length 2-7/32" Length/Large Dia. 1-9/32" Outside Diameter 1-1/4"</p> <p data-bbox="578 1194 695 1222">Clear Zinc</p> <p data-bbox="578 1278 915 1306">Same As B941 Except Knurled</p>	<p data-bbox="1034 533 1276 560">Batco 01-272</p> <p data-bbox="1034 567 1276 594">Bendix 2251804</p> <p data-bbox="1034 600 1276 627">BWP M-3254</p> <p data-bbox="1034 634 1276 661">Leland L-2984</p> <p data-bbox="1034 667 1276 695">Spicer 32-1480</p> <p data-bbox="1034 827 1276 854">Automann 101.2072</p> <p data-bbox="1034 861 1276 888">Batco 01-200</p> <p data-bbox="1034 894 1276 921">BWP M-596</p> <p data-bbox="1034 928 1276 955">Euclid E-523</p> <p data-bbox="1034 961 1276 989">Leland L-149</p> <p data-bbox="1034 995 1276 1022">Spicer 32-1425</p> <p data-bbox="1034 1079 1276 1106">Automann 101.2072K</p> <p data-bbox="1034 1113 1276 1140">Batco 01-234</p> <p data-bbox="1034 1146 1276 1173">BWP M-2204</p> <p data-bbox="1034 1180 1276 1207">Euclid E-2177</p> <p data-bbox="1034 1213 1276 1241">Haldex C66901</p> <p data-bbox="1034 1247 1276 1274">Leland L-1533</p> <p data-bbox="1034 1281 1276 1308">Spicer 32-1428</p>
<p data-bbox="277 816 350 848">B941</p> 	<p data-bbox="578 1362 906 1446">Overall Length 2-7/32" Length/Large Dia. 1-9/32" Outside Diameter 1-1/4"</p> <p data-bbox="578 1499 695 1526">Clear Zinc</p> <p data-bbox="578 1583 863 1610">Eaton 16-1/2" "ES" Brake</p>	<p data-bbox="1034 1362 1276 1390">Automann 101.2051K</p> <p data-bbox="1034 1396 1276 1423">Batco 01-247</p> <p data-bbox="1034 1430 1276 1457">BWP M-3360</p> <p data-bbox="1034 1463 1276 1491">Eaton 806234</p> <p data-bbox="1034 1497 1276 1524">Euclid E-5477</p> <p data-bbox="1034 1530 1276 1558">Leland L-2960</p> <p data-bbox="1034 1564 1276 1591">Meritor R517510</p> <p data-bbox="1034 1598 1276 1625">Spicer 32-1471</p>
<p data-bbox="77 1446 196 1474">13/16" --></p>  <p data-bbox="269 1614 358 1646">B430K</p>  <p data-bbox="277 1923 350 1955">B611</p>	<p data-bbox="578 1671 906 1755">Overall Length 2-5/32" Length/Large Dia. 1-1/4" Outside Diameter 1-1/4"</p> <p data-bbox="578 1808 764 1835">Zinc Dichromate</p> <p data-bbox="578 1892 911 1919">1/8" Oversize Version Of B941</p>	<p data-bbox="1034 1671 1276 1698">Automann 101.2073</p> <p data-bbox="1034 1705 1276 1732">Batco 01-201</p> <p data-bbox="1034 1738 1276 1766">BWP M-596A</p> <p data-bbox="1034 1772 1276 1799">Euclid E-781</p> <p data-bbox="1034 1806 1276 1833">Haldex C64534</p> <p data-bbox="1034 1839 1276 1866">Leland L-294</p> <p data-bbox="1034 1873 1276 1900">Meritor 1779C81</p> <p data-bbox="1034 1906 1276 1934">Spicer 32-1426</p>

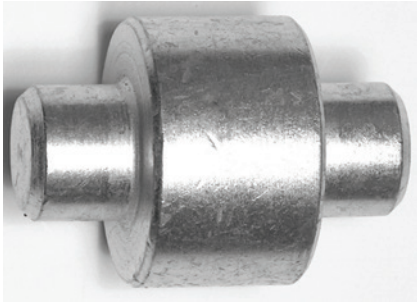
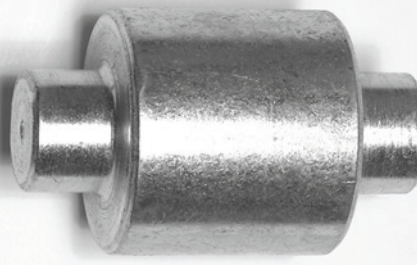
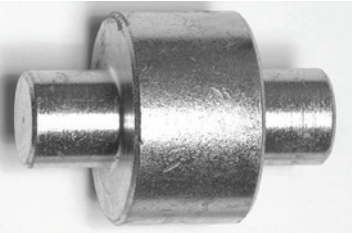
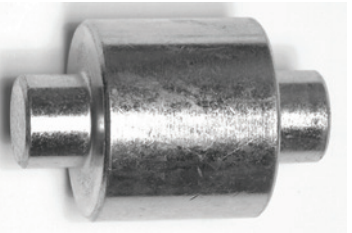

BRAKE SHOE ROLLERS

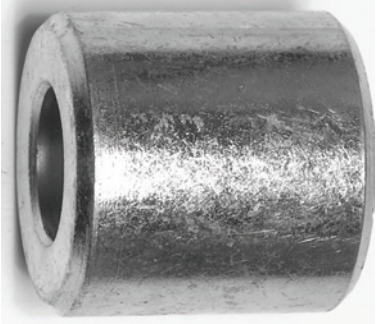
PART NO.	NOTES	REPLACES
<p data-bbox="358 243 461 275">BP-105</p>  <p data-bbox="375 669 444 701">B425</p>	<p data-bbox="672 216 1016 302">Overall Length 1-47/64" Length/Large Dia. 1-1/2" Outside Diameter 47/64"</p> <p data-bbox="672 333 789 359">Clear Zinc</p> <p data-bbox="672 417 1037 443">Meritor 14-1/2" x 5" Coach Brake</p> <hr/> <p data-bbox="672 501 989 588">Overall Length 2" Length/Large Dia. 7/8" Outside Diameter 1-1/2"</p> <p data-bbox="672 617 789 642">Clear Zinc</p> <p data-bbox="672 701 894 726">Eaton 12-1/4" Brake</p>	<p data-bbox="1127 249 1406 386">Batco 01-2091 Euclid E-10812 Leland L-260 Meritor 1779J114 Spicer 32-1560</p> <hr/> <p data-bbox="1127 501 1395 726">Batco 01-225 BWP M-787 Eaton 820165 Euclid E-1406 Haldex C66650 Leland L-1600 Meritor R517005 Spicer 32-1429</p>
<p data-bbox="375 816 444 848">B586</p>  <p data-bbox="358 1241 461 1272">BP-109</p>	<p data-bbox="672 789 1005 875">Overall Length 2-7/32" Length/Large Dia. 1-9/32" Outside Diameter 1-1/2"</p> <p data-bbox="672 905 789 930">Clear Zinc</p> <p data-bbox="672 989 1005 1014">1/4" Oversize Version Of B941</p> <hr/> <p data-bbox="672 1073 1016 1159">Overall Length 2-41/64" Length/Large Dia. 1-1/2" Outside Diameter 1-25/64"</p> <p data-bbox="672 1188 789 1213">Clear Zinc</p> <p data-bbox="672 1272 1053 1297">Meritor 14-1/2" x 10" Coach Brake</p>	<p data-bbox="1127 789 1398 989">Automann 101.2074 Batco 01-202 BWP M-597 Euclid E-586 Leland L-158 Meritor 1779D82 Spicer 32-1427</p> <hr/> <p data-bbox="1127 1104 1406 1241">Batco 01-2093 Euclid E-10838 Leland L-430 Meritor 1779L116 Spicer 32-1562</p>
 <p data-bbox="375 1614 444 1646">B923</p>	<p data-bbox="672 1362 997 1449">Overall Length 2-3/16" Length/Large Dia. 15/16" Outside Diameter 1-5/8"</p> <p data-bbox="672 1499 789 1524">Clear Zinc</p> <p data-bbox="672 1583 989 1608">Rockwell 18" x 7" Cast Shoe</p>	<p data-bbox="1127 1362 1422 1583">Automann 101.2061 Batco 01-236 BWP M-2719 Euclid E-3511 Haldex C66610 Leland L-1646 Meritor 1199U3765 Spicer 32-1458</p>
 <p data-bbox="375 1929 444 1961">B924</p>	<p data-bbox="672 1677 1016 1764">Overall Length 2-21/64" Length/Large Dia. 1-5/16" Outside Diameter 1-5/8"</p> <p data-bbox="672 1814 789 1839">Clear Zinc</p> <p data-bbox="672 1898 997 1923">Mack With 50,000# Rear Axle</p>	<p data-bbox="1127 1703 1406 1866">Batco 01-204 BWP M-3243 Euclid E-5089 Leland L-2954 Meritor 2247X128 Spicer 32-1475</p>



BRAKE SHOE ROLLERS

PART NO.	NOTES	REPLACES
 B922	Overall Length 2-17/64" Length/Large Dia. 1-1/2" Outside Diameter 1-5/8" Clear Zinc Mack With 4625B Block	Batco 01-229 BWP M-2722 Euclid E-2672 Haldex C67366 Leland L-1475 Meritor 1199A3719 Spicer 32-1431
 B725	Overall Length 1-3/8" Outside Diameter 1-1/4" Groove Width 3/8" Clear Zinc Meritor, Eaton And Wagner 15" x 4" Brake	Automann 101.1121 Batco 01-237 BWP M-2724 Euclid E-3421A Haldex C66834 Leland L-2811 Meritor 1199G3725 Spicer 32-1464 Wagner 80433
B500	Overall Length 1" Outside Diameter 1-1/4" Inside Diameter 3/4" Clear Zinc For Cast Shoes Use With B499 Pin	Automann 101.1001 Batco 01-205 BWP M-602 Euclid E-500 Leland L-100 Meritor 1199A625 Spicer 32-1435
 B133	Overall Length 1-3/8" Outside Diameter 1-1/2" Inside Diameter 3/4" Clear Zinc Dexter, Spicer And Std Forge 12-1/4" Brake Use With B132 Pin	Automann 101.1122K Batco 01-223 BWP M-594 Euclid E-2395 Haldex C67490 Leland L-1280 Meritor R517003 Spicer 32-1445 Std Forge 204108-001
B135	Overall Length 1-7/16" Outside Diameter 1-1/2" Inside Diameter 3/4" Clear Zinc Meritor 12-1/4" "Q" Brake Use With B134 Pin	Automann 101.1141K Batco 01-238 BWP M-2727 Euclid E-3483 Haldex C67466 Leland L-2352 Meritor 2297C5021 Spicer 32-1467
 B137	Overall Length 1-7/16" Outside Diameter 1-1/2" Inside Diameter 1-1/32" Clear Zinc Bendix 15" x 16-1/2" Brake Use With B136 Pin	Batco 01-248 Bendix 2251797 BWP M-3255 Leland L-2983 Spicer 32-1479

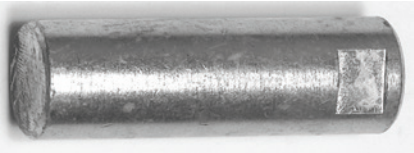
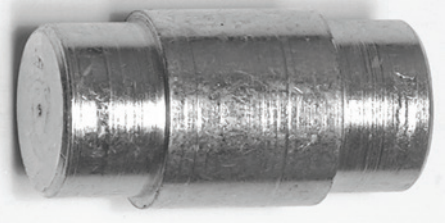
BRAKE SHOE ROLLERS/PINS

PART NO.	NOTES	REPLACES
B052	 <p>Overall Length 25/32" Outside Diameter 1-5/8" Inside Diameter 15/16"</p> <p>Clear Zinc</p> <p>Eaton 16-1/2" Brake With Fabricated Shoes</p> <p>Use With B152 Pin</p>	<p>Automann 101.0251 Batco 01-217 BWP M-592 Eaton 39074 Euclid E-595 Haldex C66902 Leland L-250 Meritor R517006 Spicer 32-1441</p>
B942	<p>Overall Length 25/32" Outside Diameter 1-5/8" Inside Diameter 15/16"</p> <p>Clear Zinc</p> <p>Same As B052 Except Knurled</p>	<p>Automann 101.0251K Batco 01-21702 BWP M-3261 Euclid E-2217A Leland L-1534 Spicer 32-1441A</p>
B055	 <p>Overall Length 25/32" Outside Diameter 1-3/4" Inside Diameter 15/16"</p> <p>Clear Zinc</p> <p>1/8" Oversize Version B052</p>	<p>Automann 101.0252 Batco 01-218 BWP M-592A Euclid E-795 Leland L-326</p>
B053	 <p>Overall Length 1-1/4" Outside Diameter 1-5/8" Inside Diameter 15/16"</p> <p>Clear Zinc</p> <p>Eaton 18" x 7" Cast Shoes</p> <p>Use With B154 Pin</p>	<p>Automann 101.1081 Batco 01-215 BWP M-2725 Eaton 1003831 Euclid E-2802 Haldex C66608 Leland L-1622 Meritor R517016 Spicer 32-1443</p>
B499	 <p>Outside Diameter 3/4" Length 2-1/4"</p> <p>Clear Zinc</p> <p>For Cast Shoes</p> <p>Use With B500 Roller</p>	<p>Automann 101.1001.99 Batco 01-250 BWP M-613 Euclid E-501 Leland L-101 Meritor 1246G475 Spicer 32-1440</p>
B152	 <p>Outside Diameter 59/64" Length 1-25/32"</p> <p>Clear Zinc</p> <p>Eaton 16-1/2" Brake</p> <p>Use With B052 Or B942 Rollers</p>	<p>Automann 101.0251.99 Batco 01-262 BWP M-612 Eaton 39075 Euclid E-596A Haldex C65431 Leland L-251 Meritor R517509 Spicer 32-1442A</p>

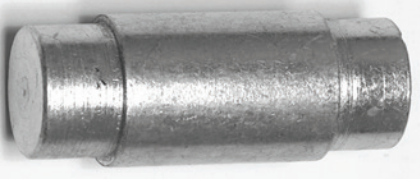
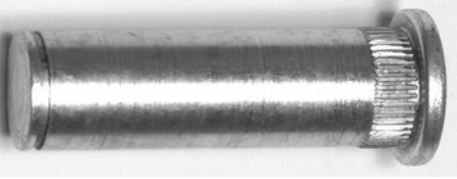
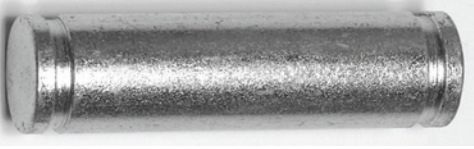
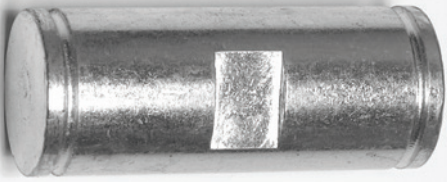
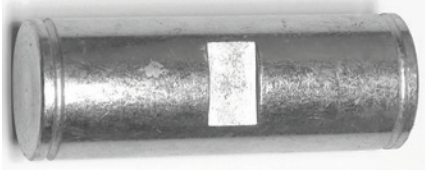
BRAKE SHOE ROLLER PINS/ANCHOR PINS

PART NO.	NOTES	REPLACES
 B154	Outside Diameter 5/8" Length 2-5/32" Clear Zinc Eaton 18" x 7" Cast Shoe Use With B053 Roller	Automann 101.1081.99 Batco 01-264 BWP M-2717 Eaton 1003832 Euclid E-2803 Haldex C66609 Leland L-1623 Meritor R517017 Spicer 32-1444
 B132	Outside Diameter 3/4" Length 2-1/4" Clear Zinc Use With B133 Roller	Automann 101.1122.99 Batco 01-263 BWP M-1005 Euclid E-2396 Haldex C67487 Leland L-1281 Meritor R517506 Spicer 32-1446 Std Forge 205107-001
 B134	Outside Diameter 3/4" Length 2-13/32" Clear Zinc Meritor 12-1/4" "Q" Brake Use With B135 Roller	Automann 101.1141.99 Batco 01-271 BWP M-2718 Euclid E-3482 Haldex C67467 Leland L-2353 Meritor 1246F1020 Spicer 32-1468
 B251	Outside Diameter 1-1/4" Length 2-7/8" Clear Zinc "P" Style Fabricated Shoe	Automann 102.2281 Batco 01-440 BWP M-620 Euclid E-512 Haldex C66910 Leland L-152 Meritor 1259Q251 Spicer 15-526
 B311	Outside Diameter 1-1/4" Length 3-3/4" Clear Zinc Cast And Fabricated Shoe With Bushings	Automann 102.3241 Batco 01-424 BWP M-618 Euclid E-502 Haldex C65307 Leland L-113 Meritor 1259R252 Spicer 15-532
 B832	Outside Diameter 1-1/4" Length 2-15/32" Clear Zinc "Propar" With Offset Lock Pin	Batco 01-400 BWP M-622 Euclid E-609 Haldex C65344 Leland L-238 Meritor 1259N170 Spicer 15-529



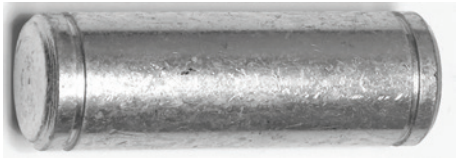
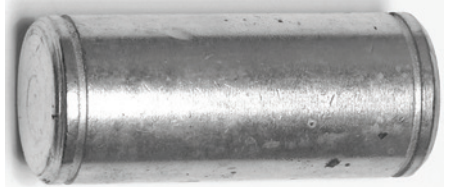
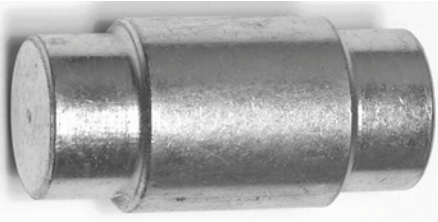
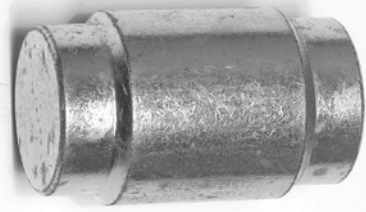
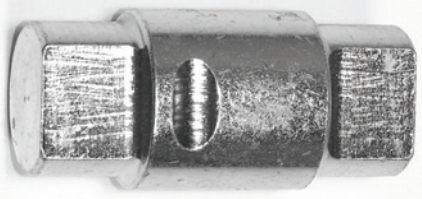

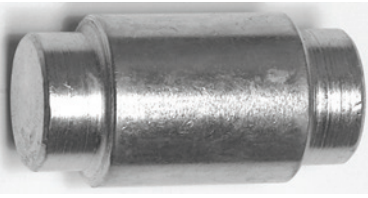
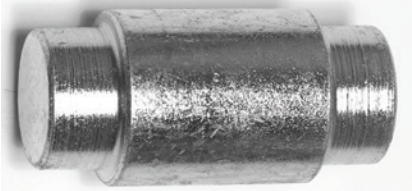
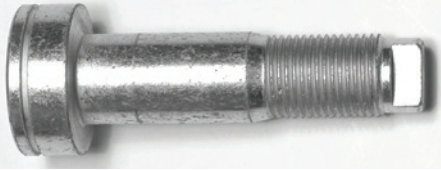
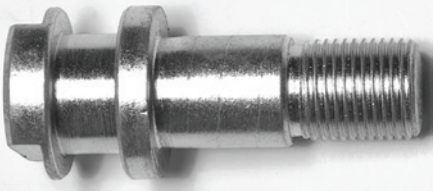
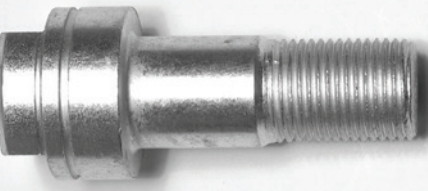

BRAKE ANCHOR PINS

PART NO.	NOTES	REPLACES
 <p data-bbox="375 470 448 499">B216</p>	<p data-bbox="672 216 987 275">Outside Diameter 1" Length 2-3/4"</p> <p data-bbox="672 327 789 352">Clear Zinc</p> <p data-bbox="672 415 976 466">12-1/4" Diameter Std Forge Fabricated Shoe</p>	<p data-bbox="1127 216 1425 466">Automann 102.2242 Batco 01-417 BWP M-1003 Euclid E-2390 Haldex C67473 Leland L-1368 Meritor R537001 Spicer 15-537 Std Forge 203108-001</p>
 <p data-bbox="375 751 448 781">B887</p>	<p data-bbox="672 531 987 590">Outside Diameter 1-1/4" Length 2-3/4"</p> <p data-bbox="672 621 789 646">Clear Zinc</p> <p data-bbox="672 699 997 749">16-1/2" Brake With "Floating" Anchor Pin</p>	<p data-bbox="1127 531 1406 749">Automann 102.2243 Batco 01-401 BWP M-771 Euclid E-1112A Haldex C65369 Leland L-788 Meritor 1259J218 Spicer 15-527</p>
<p data-bbox="375 842 448 871">B141</p>  <p data-bbox="375 1268 448 1297">B277</p>	<p data-bbox="672 816 992 905">Outside Dia.-Large 1-1/8" Outside Dia.-Small 31/32" Length 2-1/4"</p> <p data-bbox="672 936 789 961">Clear Zinc</p> <p data-bbox="672 993 911 1018">Bendix 16-1/2" Brake</p> <p data-bbox="672 1102 1003 1190">Outside Dia.-Large 1-1/4" Outside Dia.-Small 1-1/16" Length 2-3/8"</p> <p data-bbox="672 1222 789 1247">Clear Zinc</p> <p data-bbox="672 1310 976 1335">Late Model Fruehauf "XEM"</p>	<p data-bbox="1127 848 1393 987">Batco 01-455 Bendix 2258199 BWP M-3256 Leland L-2996 Spicer 15-564</p> <p data-bbox="1127 1071 1446 1331">Automann 102.2122 Batco 01-448 BWP M-2748 Euclid E-3711 Fruehauf ACF3378-001 Haldex C66915 Leland L-2364 Meritor R537005 Spicer 15-536</p>
 <p data-bbox="375 1612 448 1642">B138</p>	<p data-bbox="672 1388 1003 1476">Outside Dia.-Large 1-1/2" Outside Dia.-Small 1-5/16" Length 2-1/4"</p> <p data-bbox="672 1507 789 1533">Clear Zinc</p> <p data-bbox="672 1585 867 1610">Bendix 15" Brake</p>	<p data-bbox="1127 1413 1393 1551">Batco 01-454 Bendix 2251254 BWP M-3253 Leland L-2987 Spicer 15-563</p>
 <p data-bbox="375 1927 448 1957">B377</p>	<p data-bbox="672 1673 987 1732">Outside Diameter 1-1/4" Length 2-3/8"</p> <p data-bbox="672 1785 789 1810">Clear Zinc</p> <p data-bbox="672 1894 911 1919">Early Fruehauf "XEM"</p>	<p data-bbox="1127 1673 1446 1892">Batco 01-435 BWP M-1426 Euclid E-2773 Fruehauf ACE9909-001 Haldex C66862 Leland L-1496 Meritor R537004 Spicer 15-543</p>

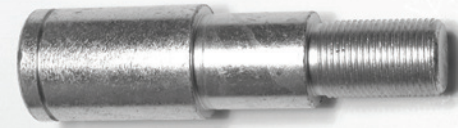

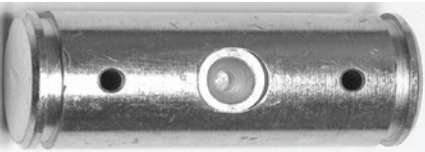

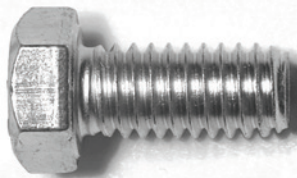
BRAKE ANCHOR PINS

PART NO.	NOTES	REPLACES
 <p>1" --></p> <p>B120</p>	<p>Outside Dia.-Large 1-1/4" Outside Dia.-Small 1" Length 2-7/32"</p> <p>Clear Zinc</p> <p>Meritor "Q", "Q-Plus", "Intraax", Spicer "Fast Change"</p>	<p>Automann 102.2071 Batco 01-434 BWP M-1422 Euclid E-2766 Haldex C66686 Leland L-1416 Meritor 1259N274 Spicer 15-542</p>
 <p>B122</p>	<p>Outside Dia.-Large 1-1/4" Outside Dia.-Small 1" Length 2-11/32"</p> <p>Clear Zinc</p> <p>Meritor (Mack) "Q" With 50,000# Rear Axle</p>	<p>Batco 01-452 BWP M-3246 Euclid E-5087 Leland L-2952 Meritor 1259V308 Spicer 15-565</p>
 <p>B217</p>	<p>Outside Diameter 1" Length 2-1/4"</p> <p>Clear Zinc</p> <p>Spicer 12-1/4" "U" Brake</p>	<p>Batco 01-447 BWP M-3238 Euclid E-5304 Haldex C67489 Leland L-2368 Meritor R547010 Spicer 15-545 Std Forge 203113-001</p>
 <p>B898</p>	<p>Outside Diameter 13/16" Length 3-5/16"</p> <p>Clear Zinc</p> <p>Wagner 15" x 4" Brake</p>	<p>Batco 01-446 BWP M-2712 Euclid E-2798 Haldex C66879 Meritor R547022 Spicer 15-557 Wagner 80414</p>
 <p>B950</p>	<p>Outside Diameter 13/16" Length 2-11/16"</p> <p>Clear Zinc</p> <p>Meritor 15" x 4" "Q" Brake</p>	<p>Automann 102.2221 Batco 01-451 BWP M-3355 Euclid E-3870 Leland L-2930 Meritor 1259X1012 Spicer 15-562</p>
 <p>B262</p>	<p>Outside Diameter 13/16" Length 2-3/4"</p> <p>Clear Zinc</p> <p>Meritor 15" x 4" "T" Brake</p>	<p>Automann 102.2241 Batco 01-437 BWP M-2706 Euclid E-3424 Haldex C66841 Leland L-1736 Meritor 1259B262 Spicer 15-550</p>



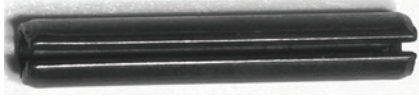
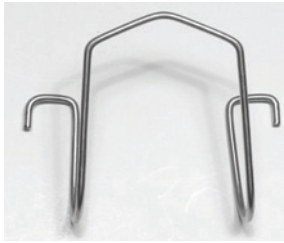

BRAKE ANCHOR PINS/LOCKS

PART NO.	NOTES	REPLACES																
 <p data-bbox="370 470 448 499">B424</p>	<p data-bbox="672 214 1003 273">Outside Diameter 1-1/2" Length 5-1/16"</p> <p data-bbox="672 327 789 352">Clear Zinc</p> <p data-bbox="672 411 987 470">Eaton 12-1/4" Single Anchor Pin Brake</p>	<table border="0"> <tr><td>Batco</td><td>01-432</td></tr> <tr><td>BWP</td><td>M-782</td></tr> <tr><td>Eaton</td><td>B1705</td></tr> <tr><td>Euclid</td><td>E-1403</td></tr> <tr><td>Haldex</td><td>C66649</td></tr> <tr><td>Leland</td><td>L-1209</td></tr> <tr><td>Meritor</td><td>R537003</td></tr> <tr><td>Spicer</td><td>15-540</td></tr> </table>	Batco	01-432	BWP	M-782	Eaton	B1705	Euclid	E-1403	Haldex	C66649	Leland	L-1209	Meritor	R537003	Spicer	15-540
Batco	01-432																	
BWP	M-782																	
Eaton	B1705																	
Euclid	E-1403																	
Haldex	C66649																	
Leland	L-1209																	
Meritor	R537003																	
Spicer	15-540																	
 <p data-bbox="363 751 461 785">BP-104</p>	<p data-bbox="672 529 990 588">Outside Diameter 1-1/4" Length 4-3/8"</p> <p data-bbox="672 642 789 667">Clear Zinc</p> <p data-bbox="672 726 971 751">Meritor 14-1/2" "W" Series</p>	<table border="0"> <tr><td>Batco</td><td>01-4411</td></tr> <tr><td>BWP</td><td>M-626</td></tr> <tr><td>Euclid</td><td>E-10814</td></tr> <tr><td>Leland</td><td>L-103</td></tr> <tr><td>Meritor</td><td>1259X76</td></tr> <tr><td>Spicer</td><td>15-600</td></tr> </table>	Batco	01-4411	BWP	M-626	Euclid	E-10814	Leland	L-103	Meritor	1259X76	Spicer	15-600				
Batco	01-4411																	
BWP	M-626																	
Euclid	E-10814																	
Leland	L-103																	
Meritor	1259X76																	
Spicer	15-600																	
 <p data-bbox="363 1041 461 1071">BP-110</p>	<p data-bbox="672 814 1000 873">Outside Diameter 1-1/4" Length 3-7/16"</p> <p data-bbox="672 928 789 953">Clear Zinc</p> <p data-bbox="672 1012 971 1037">Meritor 14-1/2" "W" Series</p>	<table border="0"> <tr><td>Batco</td><td>01-4191</td></tr> <tr><td>Euclid</td><td>E-10835</td></tr> <tr><td>Leland</td><td>L-470</td></tr> <tr><td>Meritor</td><td>1259L194</td></tr> <tr><td>Spicer</td><td>15-601</td></tr> </table>	Batco	01-4191	Euclid	E-10835	Leland	L-470	Meritor	1259L194	Spicer	15-601						
Batco	01-4191																	
Euclid	E-10835																	
Leland	L-470																	
Meritor	1259L194																	
Spicer	15-601																	
 <p data-bbox="375 1327 448 1356">B428</p>	<p data-bbox="672 1100 948 1125">Inside Diameter 1"</p> <p data-bbox="672 1293 964 1318">Use With B424 Anchor Pin</p>	<table border="0"> <tr><td>Automann</td><td>109.6004</td></tr> <tr><td>Batco</td><td>SLW-100</td></tr> <tr><td>BWP</td><td>M-843</td></tr> <tr><td>Eaton</td><td>821231</td></tr> <tr><td>Euclid</td><td>E-3975</td></tr> <tr><td>Haldex</td><td>C66654</td></tr> <tr><td>Meritor</td><td>R303975</td></tr> <tr><td>Spicer</td><td>34-1546</td></tr> </table>	Automann	109.6004	Batco	SLW-100	BWP	M-843	Eaton	821231	Euclid	E-3975	Haldex	C66654	Meritor	R303975	Spicer	34-1546
Automann	109.6004																	
Batco	SLW-100																	
BWP	M-843																	
Eaton	821231																	
Euclid	E-3975																	
Haldex	C66654																	
Meritor	R303975																	
Spicer	34-1546																	
 <p data-bbox="375 1612 448 1642">B861</p>	<p data-bbox="672 1386 1016 1444">Thread 3/8" - 16 Length 3/4"</p> <p data-bbox="672 1499 880 1524">No Lock Wire Hole</p> <p data-bbox="672 1558 948 1617">Use With B251 And B311 Anchor Pins</p>	<table border="0"> <tr><td>Automann</td><td>109.6003</td></tr> <tr><td>Batco</td><td>01-490</td></tr> <tr><td>BWP</td><td>M-648</td></tr> <tr><td>Euclid</td><td>E-579A</td></tr> <tr><td>Haldex</td><td>C65331</td></tr> <tr><td>Leland</td><td>L-168</td></tr> <tr><td>Meritor</td><td>S265D</td></tr> <tr><td>Spicer</td><td>34-1539</td></tr> </table>	Automann	109.6003	Batco	01-490	BWP	M-648	Euclid	E-579A	Haldex	C65331	Leland	L-168	Meritor	S265D	Spicer	34-1539
Automann	109.6003																	
Batco	01-490																	
BWP	M-648																	
Euclid	E-579A																	
Haldex	C65331																	
Leland	L-168																	
Meritor	S265D																	
Spicer	34-1539																	
 <p data-bbox="375 1923 448 1953">B793</p>	<p data-bbox="672 1671 987 1730">Inside Diameter 1-1/8" Thickness 1/16"</p> <p data-bbox="672 1869 971 1927">Use On 1-1/4" Anchor Pins With Grooves</p>	<table border="0"> <tr><td>Automann</td><td>108.1041</td></tr> <tr><td>Batco</td><td>01-482</td></tr> <tr><td>BWP</td><td>M-1523</td></tr> <tr><td>Euclid</td><td>E-801</td></tr> <tr><td>Haldex</td><td>C65358</td></tr> <tr><td>Leland</td><td>L-397</td></tr> <tr><td>Meritor</td><td>1229X1116</td></tr> <tr><td>Spicer</td><td>34-1525</td></tr> </table>	Automann	108.1041	Batco	01-482	BWP	M-1523	Euclid	E-801	Haldex	C65358	Leland	L-397	Meritor	1229X1116	Spicer	34-1525
Automann	108.1041																	
Batco	01-482																	
BWP	M-1523																	
Euclid	E-801																	
Haldex	C65358																	
Leland	L-397																	
Meritor	1229X1116																	
Spicer	34-1525																	



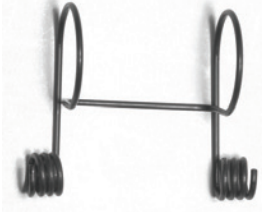



LOCKS AND RETAINERS

PART NO.	NOTES	REPLACES
 B380	Inside Diameter 15/16" Thickness 3/64" Use With B216 Anchor Pin	Automann 108.0301 Batco 01-489 BWP M-1008 Euclid E-2392 Haldex C67475 Leland L-1370 Meritor R547004 Spicer 34-1527 Std Forge 214107
 B379	Inside Diameter 3/4" Thickness 1/32" Use With 3/4" Pins On 12-1/4" Brake	Automann 108.0241 Batco 01-301 BWP M-645 Euclid E-527 Haldex C65311 Leland L-118 Meritor 1229T3166 Spicer 34-1526
 B823	Inside Diameter 1-1/4" Thickness 1/16" Use With B898 Anchor Pin	Batco 01-499 BWP M-2713 Euclid E-2723 Haldex C66894 Leland L-1670 Meritor R547019 Spicer 34-1550 Wagner FC31926
 BP-107	Inside Diameter 1-1/8" Square Wire Use With BP-110 Anchor Pin	Euclid E-10834 Meritor 1218Z52
 B932	Outside Diameter 5/16" Length 1-1/4" Use With B832 And B377 Anchor Pins	Batco 01-491 BWP M-647 Euclid E-626 Haldex C65345 Leland L-239 Meritor 1199E1695 Spicer 34-1533
 B151	Use With B586, B611, B911 And B941 Rollers	Automann 105.1003 Batco 01-300 BWP M-644 Euclid E-539 Haldex 67357 Leland L-151 Meritor 1718Y103 Spicer 34-1529

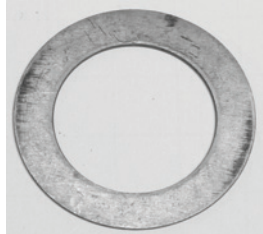

RETAINERS/WASHERS

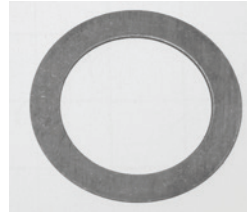
PART NO.	NOTES	REPLACES
 B161	Use With "Q" And "Q-Plus"	Automann 105.1005 Batco 01-313 BWP M-1433 Euclid E-3007A Haldex C66903 Leland L-1537 Meritor 3105B210 Spicer 34-1532
 B431	Use With Eaton "ES" 16-1/2" Brake	Automann 105.1004 Batco 01-294 BWP M-3361 Eaton 808058 Euclid E-5478 Leland L-2961 Spicer 34-1570
 B868	Stainless Steel Use With "Propar" 12-1/4" Brake	Automann 105.1001 Batco 01-310 BWP M-1055 Euclid E-1581 Fruehauf ACD2233-1 Haldex C67448 Leland L-1697 Meritor R527001 Spicer 34-1531
 B498	Stainless Steel Use With "Propar" 16-1/2" Brake	Automann 105.1002 Batco 01-311 BWP M-1428 Euclid E-3227 Fruehauf ACF1328-001 Haldex C65376 Leland L-894 Meritor R527002 Spicer 34-1530
 B011	Outside Diameter 1-3/4" Inside Diameter 1-1/4" Thickness 5/32" Felt Retainer	Automann 106.1241 Batco 01-470 BWP M-642 Euclid E-563 Leland L-110 Meritor 1205K193
 B901	Outside Diameter 1-5/8" Inside Diameter 1-1/4" Length 1-15/32" Anchor Pin Felt	Automann 106.1201 Batco 01-460 BWP M-641 Euclid E-537 Leland L-109 Meritor 5X640





WASHERS/MISCELLANEOUS

PART NO.	NOTES	REPLACES
 B501	Outside Diameter 1-3/4" Inside Diameter 1-1/4" Thickness 9/64" Neoprene Seal	Automann 106.1242 Batco 01-462 BWP M-641A Euclid E-1269 Haldex C65302 Leland L-105 Meritor A1205S1943 Spicer 35-1582
 B954	Outside Diameter 1-1/4" Inside Diameter 13/16" Thickness 5/32" Meritor 15" x 4" "Q" Brake	Automann 107.0261 Batco 01-477 BWP M-3359 Euclid E-3874 Leland L-2933 Meritor 1229V1504 Spicer 34-1562
 B988	Outside Diameter 1-7/8" Inside Diameter 1-17/64" Thickness .060" Use With B887 Anchor Pin	Automann 107.1091 Batco 01-472 BWP M-748 Euclid E-1113 Haldex C65373 Leland L-889 Meritor 1229B1848 Spicer 35-1580
 B556	Outside Diameter 1-3/8" Inside Diameter 25/32" Thickness 1/8" Use With B262 Anchor Pin For 15" x 4" "T" Brake	Automann 107.0251 Batco 334-166 BWP M-2714 Euclid E-3427 Haldex C66843 Leland L-1751 Meritor 1229V1556 Spicer 34-1552
 B392	Outside Diameter 1-1/2" Inside Diameter 1" Thickness 1/32" Use With B216 Anchor Pin	Automann 107.1001 Batco 01-473 BWP M-1007 Euclid E-2391 Haldex C67474 Leland L-1369 Meritor R547003 Spicer 35-1581 Std Forge 403147
 B951	Hole Diameter 15/16" Length 4" Hole Centers 2-5/16" Use With B950 Anchor Pin For 15" x 4" "Q" Brake	Automann 105.4001 Batco 01-478 BWP M-3358 Euclid E-3871 Leland L-2934 Meritor 2205P1004 Spicer 34-1561

MISCELLANEOUS

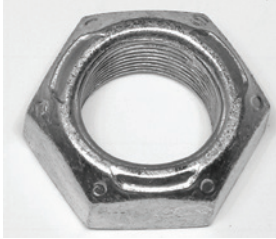
PART NO.	NOTES	REPLACES																								
 <p data-bbox="375 443 448 470">B955</p>	<p data-bbox="672 415 1068 443">Hold Down For 15" "Q" Front Brake</p>	<table data-bbox="1127 247 1419 415"> <tr><td>Automann</td><td>105.3003</td></tr> <tr><td>Batco</td><td>01-391</td></tr> <tr><td>BWP</td><td>M-850</td></tr> <tr><td>Leland</td><td>K-284</td></tr> <tr><td>Meritor</td><td>2257T1060</td></tr> <tr><td>Spicer</td><td>19-920</td></tr> </table>	Automann	105.3003	Batco	01-391	BWP	M-850	Leland	K-284	Meritor	2257T1060	Spicer	19-920												
Automann	105.3003																									
Batco	01-391																									
BWP	M-850																									
Leland	K-284																									
Meritor	2257T1060																									
Spicer	19-920																									
 <p data-bbox="375 758 448 785">B429</p>	<table data-bbox="672 506 1003 590"> <tr><td>Thread</td><td>1" - 14</td></tr> <tr><td>Hex</td><td>1-7/16"</td></tr> <tr><td>Height</td><td>7/8"</td></tr> </table> <p data-bbox="672 730 964 758">Use With B424 Anchor Pin</p>	Thread	1" - 14	Hex	1-7/16"	Height	7/8"	<table data-bbox="1127 506 1403 758"> <tr><td>Automann</td><td>109.6002</td></tr> <tr><td>Batco</td><td>SLN-107</td></tr> <tr><td>BWP</td><td>M-1889</td></tr> <tr><td>Eaton</td><td>821616</td></tr> <tr><td>Euclid</td><td>E-937</td></tr> <tr><td>Haldex</td><td>C66651</td></tr> <tr><td>Leland</td><td>SA1201</td></tr> <tr><td>Meritor</td><td>R587001</td></tr> <tr><td>Spicer</td><td>34-1545</td></tr> </table>	Automann	109.6002	Batco	SLN-107	BWP	M-1889	Eaton	821616	Euclid	E-937	Haldex	C66651	Leland	SA1201	Meritor	R587001	Spicer	34-1545
Thread	1" - 14																									
Hex	1-7/16"																									
Height	7/8"																									
Automann	109.6002																									
Batco	SLN-107																									
BWP	M-1889																									
Eaton	821616																									
Euclid	E-937																									
Haldex	C66651																									
Leland	SA1201																									
Meritor	R587001																									
Spicer	34-1545																									







BRAKE SHOE/ANCHOR PIN BUSHINGS

PART NO.	NOTES	REPLACES
 <p data-bbox="289 470 342 499">073</p>	<p data-bbox="576 216 919 300">Thread 3/4" - 16 Hex 1-1/16" Height 21/32"</p> <p data-bbox="576 359 867 384">Use With B262 Anchor Pin</p> <p data-bbox="576 443 846 468">Available In Pails (1250)</p>	<p data-bbox="1032 247 1292 438">Automann LN105 Batco SLN-105 BWP M-2459 Euclid E-4961A Leland W-451 Meritor N-112-1 Spicer 34-1551</p>
 <p data-bbox="280 785 352 814">B829</p>	<p data-bbox="576 726 943 779">For Wagner 15" Front Brakes FC018788/FC015915/FC004395</p>	<p data-bbox="1032 558 1317 749">Automann 109.6009 Batco 01-392 BWP M-2721 Euclid E-2724/5/6 Haldex C66895 Leland L-1671/3/4 Spicer 19-892A</p>
<p data-bbox="280 873 352 903">B211</p>  <p data-bbox="269 1297 363 1327">B211S</p>	<p data-bbox="576 842 899 926">Outside Diameter 1-3/8" Inside Diameter 1-1/4" Thickness 11/16"</p> <p data-bbox="576 957 724 982">Carbon Steel</p> <p data-bbox="576 1045 943 1071">For Cast Or Bushed Brake Shoes</p> <p data-bbox="576 1129 899 1213">Outside Diameter 1-3/8" Inside Diameter 1-1/4" Length 11/16"</p> <p data-bbox="576 1329 743 1354">Stainless Steel</p>	<p data-bbox="1032 905 1289 1014">BWP M-538 Haldex C65306 Leland L-112 Spicer 23-1026</p> <p data-bbox="1032 1188 1308 1297">Automann 103.1082 Batco 01-509 Euclid E-2218 Meritor 1225F266</p>
<p data-bbox="280 1444 352 1474">B362</p>  <p data-bbox="280 1871 352 1900">B144</p>	<p data-bbox="576 1413 907 1497">Outside Diameter 1-1/8" Inside Diameter 1" Length 1-7/16"</p> <p data-bbox="576 1528 724 1554">Carbon Steel</p> <p data-bbox="576 1617 889 1642">For Std Forge 12-1/4" Brake</p> <p data-bbox="576 1701 922 1785">Outside Diameter 1-1/4" Inside Diameter 1-1/8" Length 1-15/32"</p> <p data-bbox="576 1816 743 1841">Stainless Steel</p> <p data-bbox="576 1900 919 1925">Bendix 16-1/2" Brazilian Brake</p>	<p data-bbox="1032 1388 1300 1642">Automann 103.1001 Batco 02-235 BWP M-1016 Euclid E-2389 Haldex C67476 Leland L-1373 Meritor R557001 Spicer 16-564 Std Forge 405131</p> <p data-bbox="1032 1728 1292 1866">Batco 02-234 Bendix 2258191 BWP M-3257 Leland L-2995 Spicer 16-566</p>

ANCHOR PIN BUSHINGS





PART NO.	NOTES	REPLACES
B495S	Outside Diameter 1-3/8" Inside Diameter 1-1/4" Length 1-15/32" Stainless Steel Use B888T Driver Offset Slot For Use With B832 And B377 Anchor Pins	Automann 103.1086 Batco 02-216 BWP M-4107 Euclid E-920S Fruehauf AXA0068 Meritor 1225S1267
B495	Outside Diameter 1-3/8" Inside Diameter 1-1/4" Length 1-15/32" Carbon Steel Use B888T Driver Offset Slot For Use With B832 And B377 Anchor Pins	Batco 02-216S BWP M-741 Euclid E-920 Haldex C65366 Leland L-594 Spicer 16-561
B595S	Outside Diameter 1-3/8" Inside Diameter 1-1/4" Length 1-15/32" Stainless Steel Use B888T Driver Center Slot For Use With B311 And B251 Anchor Pins	Batco 02-217 BWP M-4106 Euclid E-919 Meritor 1225G449
B595	Outside Diameter 1-3/8" Inside Diameter 1-1/4" Length 1-15/32" Carbon Steel Use B888T Driver Offset Slot For Use With B311 And B251 Anchor Pins	BWP M-742 Haldex C65448 Leland L-595 Spicer 16-562
B888S	Outside Diameter 1-3/8" Inside Diameter 1-1/4" Length 1-15/32" Stainless Steel Use B888T Driver No Slot For Use With B887, B120 And B277 Anchor Pins	Automann 103.1084S Batco 02-219 BWP M-4108 Euclid E-1893 Leland L-1498 Meritor 1225B496 Spicer 16-563
B888	Outside Diameter 1-3/8" Inside Diameter 1-1/4" Length 1-15/32" Carbon Steel Use B888T Driver No Slot For Use With B887, B120 And B277 Anchor Pins	Automann 103.1084 BWP M-747 Euclid E-1893S Haldex C65372 Leland L-888 Meritor R547008 Spicer 16-565

BUSHINGS/MISCELLANEOUS



PART NO.	NOTES	REPLACES
 <p data-bbox="267 470 358 499">B888D</p>	<p data-bbox="576 216 922 300">Outside Diameter 1-3/8" Inside Diameter* 1-1/4" Length 1-15/32"</p> <p data-bbox="576 327 686 352">* Dimpled</p> <p data-bbox="576 386 724 411">Carbon Steel</p> <p data-bbox="576 443 946 499">No Slot For Use With B887, B120, And B277 Anchor Pins</p>	<p data-bbox="1032 302 1284 386">BWP M-4109 Euclid E-8938* Spicer 16-700*</p> <p data-bbox="1032 474 1222 499">* Stainless Steel</p>
 <p data-bbox="267 756 358 785">B888T</p>	<p data-bbox="576 531 797 556">Anchor Pin Bushing</p> <p data-bbox="576 726 911 751">Removal And Installation Tool</p>	<p data-bbox="1032 617 1284 669">Batco 11-1830 Euclid E-1362</p>
 <p data-bbox="267 1041 358 1071">BP-108</p>	<p data-bbox="576 816 922 900">Outside Diameter 1-1/2" Inside Diameter 1-1/4" Length 1-15/32"</p> <p data-bbox="576 930 659 955">Bronze</p> <p data-bbox="576 1014 850 1039">For 14-1/2" Coach Brake</p>	<p data-bbox="1032 846 1308 982">Batco 02-237 Euclid E-10836 Leland L-566 Meritor 1225X440 Spicer 16-702</p>
 <p data-bbox="267 1327 358 1356">B8662</p>	<p data-bbox="576 1102 873 1127">1/8" Pipe Thread - Straight</p> <p data-bbox="576 1297 959 1323">For Support Brackets And Spiders</p>	<p data-bbox="1032 1131 1292 1297">Automann G1803 Batco 334-475 BWP M-1414 Euclid E-1307 Meritor R301307 Spicer 34-1541</p>
 <p data-bbox="267 1612 358 1642">B8663</p>	<p data-bbox="576 1388 899 1413">1/8" Pipe Thread - 45 Degree</p> <p data-bbox="576 1583 959 1608">For Support Brackets And Spiders</p>	<p data-bbox="1032 1446 1284 1530">BWP M-1415 Euclid E-1308 Spicer 34-1542</p>
 <p data-bbox="267 1923 358 1953">B8664</p>	<p data-bbox="576 1673 899 1698">1/8" Pipe Thread - 90 Degree</p> <p data-bbox="576 1898 959 1923">For Support Brackets And Spiders</p>	<p data-bbox="1032 1757 1276 1810">Automann G1815 BWP M-1416</p>

BRAKE SHOE RETURN SPRINGS







Springs are listed by brake size and overall length. Overall length is measured between hooks at free length. Lengths may vary slightly and be functional. Colors are for identification purposes only.

FOR 12-1/4" BRAKES	NOTES	REPLACES
 B426	Overall Length 5" Outside Diameter 1" Wire Diameter .192" Black Eaton 12-1/4" Brake	Batco 01-341 BWP M-790 Eaton 820276 Euclid E-1402 Haldex C66652 Leland L-1034 Meritor R567004 Spicer 19-864
 B256	Overall Length 6-1/4" Outside Diameter 1" Wire Diameter .140" Black Std Forge 12-1/4" Brake	Automann 104.06081 Batco 01-339 BWP M-1507 Euclid E-757 Haldex C66849 Leland L-385 Meritor 2258V256
 B869	Overall Length 6-3/4" Outside Diameter 1-1/8" Wire Diameter .148" Black Fruehauf 12-1/4" Brake	Batco 01-350 BWP M-1056 Euclid E-1583 Fruehauf ACD2287-1 Haldex C67446 Leland L-1695 Meritor R567002 Spicer 19-863
 B307	Overall Length 6-9/16" Outside Diameter 1" Wire Diameter .171" Blue Heavy Duty Version Of B256 Std Forge 12-1/4" Brake	Automann 104.06181 Batco 01-331 BWP M-1009 Euclid E-2398 Haldex C67492 Leland L-3148 Meritor R567005 Spicer 19-862 Std Forge 208106
 B308	Overall Length 6-7/8" Outside Diameter 1-1/8" Wire Diameter .175" Blue Meritor 12-1/4" "Q" Brake	Batco 01-378 BWP M-2728 Euclid E-3481A Haldex C67465 Leland L-2351 Meritor 2258B704 Spicer 19-882







BRAKE SHOE RETURN SPRINGS

FOR 12-1/4" BRAKES (CONT'D)	NOTES	REPLACES
 <p>B427</p>	<p>Overall Length 6" Outside Diameter 1/2" Wire Diameter .098"</p> <p>Black</p> <p>Eaton 12-1/4" Brake</p>	<p>Batco 01-345 BWP M-791 Eaton B2010 Euclid E-1400 Haldex C66653 Leland L-1035 Meritor R567003 Spicer 19-866</p>
FOR 14-1/2" BRAKES		
 <p>BP-100</p>	<p>Overall Length 8-11/16" Outside Diameter 5/8" Wire Diameter .105"</p> <p>Black</p> <p>Meritor 14-1/2" Steer Axle Brake</p>	<p>Batco 01-3462 BWP M-823 Euclid E-10818 Leland L-573 Meritor 2258J1440 Spicer 19-952</p>
 <p>BP-106</p>	<p>Overall Length 8-1/2" Outside Diameter 1-1/4" Wire Diameter .192"</p> <p>Black</p> <p>Meritor 14-1/2" Rear Brake</p>	<p>Batco 01-3461 BWP M-4110 Euclid E-10826 Leland L-574 Meritor 2258J400 Spicer 19-953</p>
FOR 15" BRAKES		
 <p>B562</p>	<p>Overall Length 7-1/8" Outside Diameter 13/16" Wire Diameter .128"</p> <p>Blue</p> <p>Eaton Front Brake</p>	<p>Automann 104.07041 Batco 01-358 BWP M-3346 Eaton 1006562 Euclid E-5123 Haldex C66836 Leland L-2829 Meritor R567009 Spicer 19-923</p>
 <p>B579</p>	<p>Overall Length 7-3/16" Outside Diameter 7/8" Wire Diameter .125"</p> <p>Green</p> <p>Meritor 15" "T" Brake</p>	<p>Automann 104.07061 Batco 01-374 BWP M-2729 Euclid E-3437 Haldex C66842 Leland L-1734 Meritor 2258G579 Spicer 19-896</p>
 <p>B952</p>	<p>Overall Length 7-11/16" Outside Diameter 13/16" Wire Diameter .146"</p> <p>Black</p> <p>Meritor 15" x 4" "Q" Brake</p>	<p>Automann 104.07221 Batco 01-363 BWP M-3356 Euclid E-3872 Haldex C66853 Leland L-2931 Meritor 2258K1181 Spicer 19-902</p>





BRAKE SHOE RETURN SPRINGS

FOR 15" BRAKES (CONT'D)	NOTES	REPLACES
 <p>B956</p>	<p>Overall Length 8-3/8" Outside Diameter 1-1/8" Wire Diameter .162"</p> <p>Gray</p> <p>Meritor 15" "Q-Plus"</p>	<p>Automann 104.08123 Batco 01-3696 BWP M-3260 Euclid E-9063 Haldex C63043 Leland L-3069 Meritor 2258L1234 Spicer 19-856</p>
 <p>B436</p>	<p>Overall Length 10-1/8" Outside Diameter 1-1/8" Wire Diameter .203"</p> <p>White</p> <p>Eaton "ES" 15" x 8-5/8" Drive Axle</p>	<p>Automann 104.10042 Batco 01-347 BWP M-3987 Eaton 812992 Euclid E-9038 Haldex C63051 Leland L-3175 Meritor R567013 Spicer 19-925</p>
 <p>B870</p>	<p>Overall Length 10-1/8" Outside Diameter 1" Wire Diameter .150"</p> <p>Blue</p> <p>Wagner 15" x 4" Front Brake</p>	<p>Batco 01-377 BWP M-2737 Euclid E-2770 Haldex C66880 Leland L-1693 Meritor R567015 Spicer 19-891 Wagner FC89177/8</p>
 <p>B433</p>	<p>Overall Length 3-9/16" Outside Diameter 1-3/16" Wire Diameter .187"</p> <p>Red</p> <p>Eaton "ES" 15" x 6" Front Brake</p>	<p>Automann 104.03181 Batco 01-340 BWP M-3498 Eaton 817017 Euclid E-9037 Haldex C63054 Leland L-3173 Meritor R567012 Spicer 19-924</p>
FOR 16-1/4" BRAKES		
 <p>B256</p>	<p>Overall Length 6-1/4" Outside Diameter 1" Wire Diameter .140"</p> <p>Black</p> <p>Meritor "T" Brake</p>	<p>Automann 104.06081 Batco 01-339 BWP M-1507 Euclid E-757 Haldex C66849 Leland L-385 Meritor 2258V256</p>
FOR 16-1/2" BRAKES		
 <p>B971</p>	<p>Overall Length 8" Outside Diameter 1-1/8" Wire Diameter .162"</p> <p>Green</p> <p>"P" Type Brake</p>	<p>Automann 104.08001 Batco 01-354 BWP M-548 Euclid E-545A Haldex C65310 Leland L-179 Meritor 2258P354 Spicer 19-851</p>







BRAKE SHOE RETURN SPRINGS

FOR 16-1/2" BRAKES (CONT'D)	NOTES	REPLACES
 <p>B728</p>	<p>Overall Length 8" Outside Diameter 1-1/4" Wire Diameter .192"</p> <p>Red</p> <p>Heavy Duty Version B971</p>	<p>Automann 104.08001HD Batco 01-322 BWP M-792 Euclid E-1880B Haldex C65337 Leland L-827 Meritor 2258Z416 Spicer 19-853</p>
 <p>B142</p>	<p>Overall Length 8-5/16" Outside Diameter 1-1/8" Wire Diameter .162"</p> <p>Blue</p> <p>Bendix 16-1/2" Truck/Tractor Brake</p>	<p>Batco 01-384 Bendix 2258196 BWP M-3251 Leland L-2993 Spicer 19-906</p>
 <p>B302</p>	<p>Overall Length 8-3/8" Outside Diameter 1-1/8" Wire Diameter .162"</p> <p>Orange</p> <p>Meritor "Q", Spicer "FC", And Fruehauf "XEM"</p>	<p>Automann 104.08121 Batco 01-369 BWP M-1424 Euclid E-2768/E-3228 Fruehauf ACE009911 Haldex C66864 Leland L-1418 Meritor 2258U619 Spicer 19-856A</p>
 <p>B349</p>	<p>Overall Length 8-3/8" Outside Diameter 1-1/4" Wire Diameter .192"</p> <p>Red</p> <p>Heavy Duty Version B302</p>	<p>Automann 104.08121HD Batco 01-379 BWP M-2732 Euclid E-3490B E-3490S Haldex C66565 Leland L-2370 Meritor 2258W803 Spicer 19-853A</p>
 <p>B350</p>	<p>Overall Length 8-13/32" Outside Diameter 1-1/8" Wire Diameter .192"</p> <p>Red</p> <p>Eaton "ES" For Meritor And Fruehauf Brakes</p>	<p>Automann 104.08131HD Batco 01-3862 BWP M-4111 Eaton 810292 Euclid E-8907 Leland L-3118 Meritor R567022 Spicer 19-930</p>
 <p>B347</p>	<p>Overall Length 8-9/16" Outside Diameter 1-1/8" Wire Diameter .162"</p> <p>Red</p> <p>Meritor Front "FL" Brake</p>	<p>Batco 01-372 BWP M-4112 Euclid E-9069 Haldex C63045 Leland L-3183 Meritor 2258S643 Spicer 19-913</p>





BRAKE SHOE RETURN SPRINGS

FOR 16-1/2" BRAKES (CONT'D)	NOTES	REPLACES
 B974	Overall Length 9" Outside Diameter 1-1/8" Wire Diameter .162" Black Meritor "P" Cast Shoe	Batco 01-323 BWP M-549 Euclid E-543 Leland L-115 Meritor 2258K349 Spicer 19-878
 B348	Overall Length 9-1/16" Outside Diameter 1-3/16" Wire Diameter .171" Green Meritor 16-1/2" Front Brake	Automann 104.09021 Batco 01-3751 BWP M-3497 Euclid E-9643 Leland L-3126 Meritor 2258Y1273 Spicer 19-950
 B957	Overall Length 7-5/8" Outside Diameter 1-3/16" Wire Diameter .150" Orange Meritor 15" "Q-Plus"	Batco 01-3697 BWP M-4113
 B871	Overall Length 9-1/8" Outside Diameter 1-1/8" Wire Diameter .164" Brown Mack 16-1/2" "Q" Front Brake	Automann 104.09041 Batco 01-375 BWP M-2746 Euclid E-3824 Haldex C65565 Leland L-2843 Spicer 19-910
 B139	Overall Length 9-3/4" Outside Diameter 1-1/8" Wire Diameter .162" Blue Bendix 16-1/2" Truck/Tractor Front Brake	Batco 01-382 Bendix 2260285 BWP M-3249 Leland L-2985 Spicer 19-904
 B983	Overall Length 10" Outside Diameter 1-3/16" Wire Diameter .176" Red Eaton (Ford) High Mount	Automann 104.10001 Batco 01-362 BWP M-2733 Eaton 1000406 Euclid E-2475 Haldex C67786 Leland L-1603 Meritor R567001 Spicer 19-874



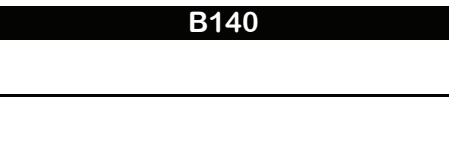

BRAKE SHOE RETURN SPRINGS

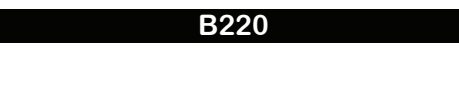
FOR 16-1/2" BRAKES (CONT'D)	NOTES	REPLACES
 B432A	Overall Length 10-3/4" Outside Diameter 1-1/8" Wire Diameter .192" Gray Eaton 16-1/2" "ES", "ES-II" Brake	Automann 104.10241HD Batco 01-3864 BWP M-3362 Eaton 818278 Euclid E-10197 Haldex C63060 Leland L-3370 Meritor R567503 Spicer 19-915
 B981	Overall Length 10-13/16" Outside Diameter 1-1/8" Wire Diameter .192" Red Eaton 16-1/2" S.A.P. Brake	Automann 104.10261HD Batco 01-349 BWP M-1014 Eaton 78580 Euclid E-1428A Haldex C65450 Leland L-835 Meritor R567006 Spicer 19-854
FOR 18" BRAKES		
 B728	Overall Length 8" Outside Diameter 1-1/4" Wire Diameter .192" Red Spicer 18" "XL" Brake	Automann 104.08001HD Batco 01-322 BWP M-792 Euclid E-1880B Haldex C65337 Leland L-827 Meritor 2258Z416 Spicer 19-853
 B974	Overall Length 9" Outside Diameter 1-1/8" Wire Diameter .162" Black Meritor 18" Brake With Cast Shoes	Batco 01-323 BWP M-549 Euclid E-543 Leland L-115 Meritor 2258K349 Spicer 19-878
 B972	Overall Length 6" Outside Diameter 3/4" Wire Diameter .135" Green Meritor 18" Brake With Cast Shoes	Automann 104.06002 Batco 01-371 BWP M-2739 Euclid E-3512 Haldex C66612 Leland L-2858 Meritor 2258R590 Spicer 19-865
 B982	Overall Length 11-3/8" Outside Diameter 1-1/4" Wire Diameter .225" Green Eaton 18" x 7" Brake	Automann 104.11121 Batco 01-360 BWP M-2740 Eaton 1000091 Euclid E-2804 Haldex C66607 Leland L-1624 Meritor R567027 Spicer 19-876



BRAKE SHOE RETAINER SPRINGS

PART NO.	NOTES	REPLACES
 B999	Overall Length 3-7/8" Outside Diameter 5/8" Wire Diameter .100" Black Eaton 15" x 4" Front Brake	Automann 104.03281 Batco 01-357 M-3345 Eaton 1003999 Euclid E-5122 Haldex C66835 Leland L-2825 Meritor R567501 Spicer 19-922
 B953	Overall Length 5-9/32" Outside Diameter 7/64" Wire Diameter .112" Blue Meritor 15" x 4" "Q" Brake	Automann 104.05091 Batco 01-380 BWP M-3357 Euclid E-3873 Haldex C66854 Leland L-2932 Meritor 2258E1123 Spicer 19-903
 B769	Overall Length 4-17/32" Outside Diameter 1" Wire Diameter .142" Orange Eaton 16-1/2" S.A.P. Brake	Automann 104.04171 Batco 01-348 BWP M-844 Eaton 70326 Euclid E-1418 Haldex C65320 Leland L-967 Meritor R567502 Spicer 19-859
 B140	Overall Length 5-13/16" Outside Diameter 3/4" Wire Diameter .162" Black Bendix 15" Front Brake	Batco 01-383 Bendix 2261362 BWP M-3250 Spicer 19-905
 B143	Overall Length 5-1/4" Outside Diameter 11/16" Wire Diameter .125" Black Bendix 16-1/2" Brake	Batco 01-385 Bendix 2258200 BWP M-3252 Leland L-2994 Spicer 19-907
 B220	Overall Length 5-1/2" Outside Diameter 3/4" Wire Diameter .125" Orange Eaton 15" x 8-5/8", Meritor & Spicer "Q", "FC" And Fruehauf "XEM"	Automann 104.05161 Batco 01-370 BWP M-1423 Euclid E-2767 Haldex C66863 Leland L-1417 Meritor 2258Q615 Spicer 19-860

BRAKE SHOE RETAINER SPRINGS/PINS

RETAINER SPRINGS (CONT'D)	NOTES	REPLACES
 <p>B434</p>	Overall Length 5-1/2" Outside Diameter 13/16" Wire Diameter .128" Orange Eaton "ES-II" Retainer Spring	Automann 104.05162 Batco 01-3481 BWP M-3491 Eaton 819725 Euclid E-10198 Haldex C63005 Leland L-3369 Meritor R567505 Spicer 19-940
	Overall Length 5-1/4" Outside Diameter 13/16" Wire Diameter .128" Brown Dana 12-1/4" "FC-III"	Batco 01-3482 BWP M-4114 Leland L-3501 Spicer 19-938
 <p>B221</p>	Overall Length 6-5/16" Outside Diameter 3/4" Wire Diameter .140" Blue Mack 50,000# "Q" Brake	Batco 01-381 BWP M-3245 Euclid E-5088 Leland L-2953 Meritor 2258X804 Spicer 19-900
 <p>B770</p>	Overall Length 4-5/8" Outside Diameter 1-1/4" Wire Diameter .160" Green Eaton 18" x 7" Brake	Automann 104.04201 Batco 01-361 BWP M-2738 Eaton 1000092 Euclid E-2805 Haldex C66606 Leland L-1625 Meritor R567028 Spicer 19-877
 <p>B218</p>	Overall Length 5" Outside Diameter 3/16" Wire Diameter .175" Unpainted Spicer 12-1/4" "U" Brake	Batco 01-305 BWP M-3239 Euclid E-5305 Haldex C67488 Leland L-2367 Meritor R547011 Spicer 34-1563
<p>SPRING RETAINERS</p>  <p>B423</p>	Overall Length 2-3/4" Outside Diameter 1/4" Unpainted For All Fabricated Shoes	Automann 105.2004 Batco 01-320 BWP M-1500 Euclid E-747 Haldex C65351 Leland L-324 Meritor 1218G85 Spicer 20-881

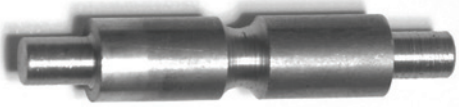
BRAKE SHOE RETAINER PINS

SPRING RETAINERS (CONT'D)	NOTES	REPLACES																		
 <p data-bbox="375 470 448 499">B358</p>	<p data-bbox="672 216 992 270">Overall Length 2-1/8" Outside Diameter 15/32"</p> <p data-bbox="672 327 789 354">Unpainted</p> <p data-bbox="672 443 1081 470">Spicer And Std Forge 12-1/4" Brakes</p>	<table border="0"> <tr><td>Automann</td><td>105.2002</td></tr> <tr><td>Batco</td><td>01-318</td></tr> <tr><td>BWP</td><td>M-1558</td></tr> <tr><td>Euclid</td><td>E-2399</td></tr> <tr><td>Haldex</td><td>C67471</td></tr> <tr><td>Leland</td><td>L-1535</td></tr> <tr><td>Meritor</td><td>R577001</td></tr> <tr><td>Spicer</td><td>20-882</td></tr> <tr><td>Std Forge</td><td>207100</td></tr> </table>	Automann	105.2002	Batco	01-318	BWP	M-1558	Euclid	E-2399	Haldex	C67471	Leland	L-1535	Meritor	R577001	Spicer	20-882	Std Forge	207100
Automann	105.2002																			
Batco	01-318																			
BWP	M-1558																			
Euclid	E-2399																			
Haldex	C67471																			
Leland	L-1535																			
Meritor	R577001																			
Spicer	20-882																			
Std Forge	207100																			
 <p data-bbox="375 785 448 814">B973</p>	<p data-bbox="672 531 789 558">Unpainted</p> <p data-bbox="672 753 870 781">Meritor 18" Brake</p>	<table border="0"> <tr><td>Automann</td><td>105.2003</td></tr> <tr><td>Batco</td><td>01-314</td></tr> <tr><td>BWP</td><td>M-2742</td></tr> <tr><td>Euclid</td><td>E-3513</td></tr> <tr><td>Haldex</td><td>C66611</td></tr> <tr><td>Leland</td><td>L-2859</td></tr> <tr><td>Meritor</td><td>1218C107</td></tr> <tr><td>Spicer</td><td>34-1565</td></tr> </table>	Automann	105.2003	Batco	01-314	BWP	M-2742	Euclid	E-3513	Haldex	C66611	Leland	L-2859	Meritor	1218C107	Spicer	34-1565		
Automann	105.2003																			
Batco	01-314																			
BWP	M-2742																			
Euclid	E-3513																			
Haldex	C66611																			
Leland	L-2859																			
Meritor	1218C107																			
Spicer	34-1565																			

MANUAL SLACK ADJUSTERS

		PART NO.	SPLINE	A	B	C	REPLACES	
	Zinc-Dichromate Finish						Automann	134.1010
	Positive Locking Adjustment		For All 1-1/4" - 10 Spline Camshafts				Batco	05-214
	Heat Treated Alloy Gears	S2026					Bendix	278302
	Threaded Grease Fitting		1-1/4" - 10	4-1/2"	5-1/2"	---	BWP	M-3375
	Bi-Directional Body Design						Euclid	E-4904
							Haldex	KN48031
							Leland	L-2494
							Meritor	R822009
							Norforge	A-7134
							Spicer	10-399
			For Meritor 15" x 4" "Q" Brakes				Automann	134.2410
		S2024					Batco	05-254
			1-1/4" - 24	5-1/2"	---	---	BWP	M-3984
							Euclid	E-9102
							Haldex	KN55001
							Leland	L-3225
							Meritor	R825020
							Automann	134.1040
		S2021A					Batco	05-202
			1-1/2" - 10	5"	6"	---	Bendix	278010
							BWP	M-452
							Euclid	E-1063HD
							Haldex	KN47081
							Leland	L-562
							Meritor	R823000
							Norforge	A-7022
							Spicer	M16WR105
							Automann	134.1041
		S2010A					Batco	05-203
			1-1/2" - 10	5"	6"	7"	Bendix	278323
							BWP	M-434
							Euclid	E-612S
							Haldex	KN47001
							Leland	L-196EC
							Meritor	R824000
							Norforge	A-7076
							Spicer	M10WR119
							Automann	134.1031
		S2020A					Batco	05-201
			1-1/2" - 10	5-1/2"	6-1/2"	---	Bendix	278321
							BWP	M-457
							Euclid	E-940BK
							Haldex	KN47011
							Leland	L-845EC
							Meritor	R824001
							Norforge	A-7044
							Spicer	10-354
							Automann	134.1042
			Curved Arm For 12-1/4" Brakes				Batco	05-250
		S2025					Bendix	278084
			1-1/2" - 10	6"	---	---	BWP	M-475
							Euclid	E-2091
							Haldex	KN51000
							Leland	L-1275
							Meritor	R002091
							Norforge	A-7225
							Spicer	M12WR101

MANUAL SLACK ADJUSTERS

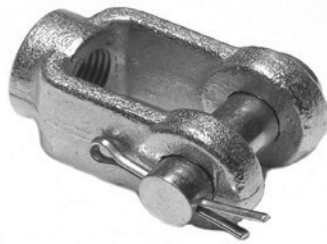
		PART NO.	SPLINE	A	B	C	REPLACES	
	C	S2011A	1-1/2" - 28	5"	6"	---	Automann 134.2840 BWP M-638 Haldex KN44051	
	B	S2022A					1-1/2" - 28	5"
	A	S2019A	1-1/2" - 28	5-1/2"	6-1/2"	---	Automann 134.2831 Batco 05-237 Bendix 288753 BWP M-2577 Euclid E-2459S Haldex KN44061 Leland L-1648EC Meritor R824004 Norforge A-7094 Spicer 10-368	
								Automann 134.2842 Batco 05-251 BWP M-3374 Euclid E-5498 Haldex KN51010 Leland L-2349 Meritor A3275J686 Norforge A-7228
			S2023	1-1/2" - 28	6"	---	---	Automann 134.3741 Batco 05-240 Bendix 283411 BWP M-474 Euclid E-1574S Haldex KN44041 Leland L-841EC Meritor R824007 Norforge A-7100 Spicer 10-367
			S2012A	1-5/8" - 37	6"	---	---	Automann 179.YK5812 Batco 12-40202 Bendix 228790 BWP M-1382 Euclid E-8897 Haldex KN36470 Meritor 1245C185 Norforge A-7531 Spicer 10-131
		CLEVIS ASSEMBLY						
		S2000	No Style Manual Slack					
			Thread Diameter	5/8" - 18				
			Pin Diameter	1/2"				
			Available In Pails (325)					

MANUAL SLACK ADJUSTERS

	PART NO.	NOTES	REPLACES					
		CLEVIS ASSEMBLY		<table border="0"> <tr> <td data-bbox="1109 338 1182 365">Batco</td> <td data-bbox="1273 338 1377 365">12-40201</td> </tr> <tr> <td data-bbox="1109 365 1182 392">Euclid</td> <td data-bbox="1273 365 1352 392">E-8896</td> </tr> </table>	Batco	12-40201	Euclid	E-8896
	Batco	12-40201						
	Euclid	E-8896						
	No Style Manual Slack							
S2001	Thread Diameter	1/2" - 20						
	Pin Diameter	1/2"						

BENDIX STYLE AUTOMATIC SLACK ADJUSTERS

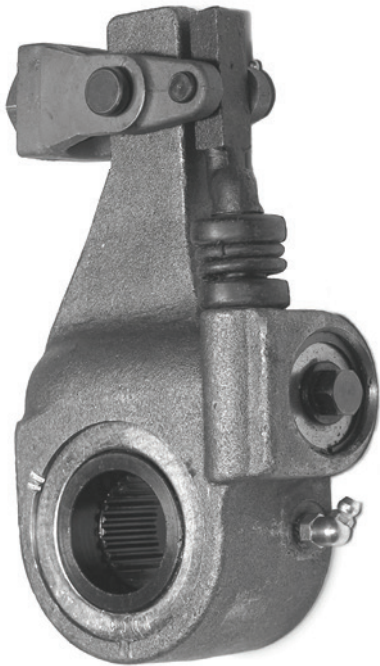

FEATURES

- * Unhanded Design
- * Clearance and Load Sensing
- * Link Rod Actuation
- * Easy Manual Adjustment
- * Positive Grease Sealing
- * Corrosion Resistant "E" Coating



PART NO.	SPLINE	ARM LENGTH	REPLACES
SA2164	1-1/4" - 10	5-1/2"	Automann 137.1010 Batco 05-470 Bendix 065164 Haldex 40020235
SA2167	1-1/4" - 24	5-1/2"	Automann 137.2410 Batco 05-472 Bendix 065167 Haldex 40010073
SA2170	1-1/2" - 10	5-1/2"	Automann 137.1011 Batco 05-461 Bendix 065170 Haldex 40020239
SA2172	1-1/2" - 10	6"	Automann 137.1030 Batco 05-460 Bendix 065172 Haldex 40020233

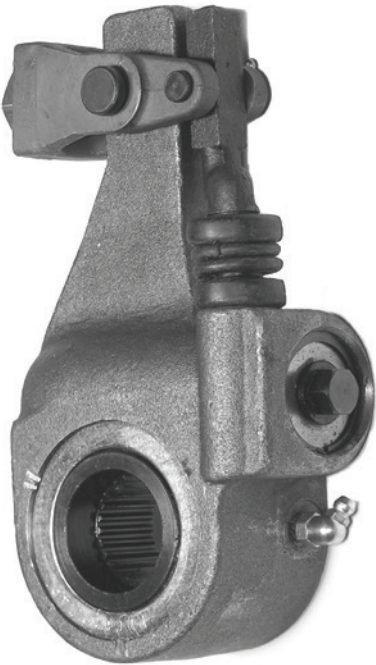



BENDIX STYLE AUTOMATIC SLACK ADJUSTERS

	PART NO.	SPLINE	ARM LENGTH	REPLACES
	SA2174	1-1/2" - 28	5-1/2"	Automann 137.2810 Batco 05-463 Bendix 065174 Haldex 40020230
	SA2175	1-1/2" - 28	6"	Automann 137.2830 Batco 05-462 Bendix 065175/065176 Haldex 40020234
	SA2178	1-5/8" - 37	5-1/2"	Batco 05-465 Bendix 065178 Haldex 40020213
	SA2179	1-5/8" - 37	6"	Batco 05-464 Bendix 065179 Haldex 40020212
		CLEVIS ASSEMBLY		Bendix 107158
	S2008	Bendix Style Automatic Slack		
		Thread Diameter	5/8" - 18	
		Large Pin Diameter	1/2"	
		Small Pin Diameter	0.245"	
		CLEVIS PIN		
	BCP2174	Large And Small Clevis Pins No Cotter Pins For Bendix Auto Slack SA2174		



CREWSON STYLE AUTOMATIC SLACK ADJUSTERS

FEATURES

- * Clearance and Load Sensing
- * Adjusts On Return Stroke
- * Link Rod Actuation
- * Easy Manual Adjustment
- * Positive Grease Sealing
- * Corrosion Resistant "E" Coating

		PART NO.	SPLINE	ARM LENGTH	REPLACES
					
			15" Meritor "T" And Eaton S.A.P. Brakes		Automann 136.1010 Batco 05-570 BWP M-3363 Euclid E-6987A Haldex CS52331 Leland L-3009
	SA24100		1-1/4" - 10	5-1/2"	
					
			15" Meritor "T" And "Q" Brakes		Automann 136.2410 Batco 05-572 BWP M-3365 Euclid E-6989A Haldex CS52336 Leland L-3010
	SA25100		1-1/4" - 24	5-1/2"	
					
			12-1/4" Trailer Axle Brakes		Batco 05-550 BWP M-3493 Euclid E-10950A Haldex CS52338 Leland L-3352
	SA21953		1-1/2" - 10	5" - 6"	
					
			12-1/4" Trailer Axle Brakes		Batco 05-552 BWP M-3492 Euclid E-10949A Haldex CS52341 Leland L-3161
	SA22953		1-1/2" - 28	5" - 6"	

CREWSON AUTOMATIC SLACK ADJUSTERS

		PART NO.	SPLINE	ARM LENGTH	REPLACES
					
				16-1/2" Drive And Trailer Axles Bendix, Eaton, Fruehauf, Meritor And Spicer	Automann 136.1030 Batco 05-560 BWP M-3367 Euclid E-6991A Haldex CS52315 Leland L-3003
	SA21103		1-1/2" - 10	5" - 6"	
				16-1/2" Drive And Trailer Axles Bendix, Eaton, Fruehauf, Meritor And Spicer	Automann 136.1031 Batco 05-561 BWP M-3369 Euclid E-6992A Haldex CS52316 Leland L-3004
	SA21102		1-1/2" - 10	5-1/2" - 6-1/2"	
			16-1/2" Drive And Trailer Axles Eaton, Meritor And Spicer	Automann 136.2830 Batco 05-562 BWP M-3368 Euclid E-6993A Haldex CS52321 Leland L-3005	
SA22103		1-1/2" - 28	5" - 6"		
			16-1/2" Drive And Trailer Axles Eaton, Meritor And Spicer	Automann 136.2831 Batco 05-563 BWP M-3370 Euclid E-6994A Haldex CS52320 Leland L-3006	
SA22102		1-1/2" - 28	5-1/2" - 6-1/2"		
			16-1/2" Fruehauf Trailer Brakes	Automann 136.3741 Batco 05-564 BWP M-3371 Euclid E-6995A Haldex CS52325 Leland L-3007	
SA23106		1-5/8" - 37	5" - 6"		
		CLEVIS ASSEMBLY			
		Crewson Style Automatic Slack		BWP M-3386 Euclid E-9133 Haldex CQ36543 Leland L-3063	
	S2002	Thread Diameter	5/8" - 18		
	Large Pin Diameter	1/2"			
	Small Pin Diameter	0.235"			



GUNITE STYLE AUTOMATIC SLACK ADJUSTERS

FEATURES

- * Clearance and Load Sensing
- * Factory Lubricated and Sealed
- * Unhanded Design
- * Compact Housing for Easy Installation
- * Drilled Worm Wheel
- * O-Ring on Spline Gear

	PART NO.	SPLINE	ARM LENGTH	REPLACES				
	SA1136	1-1/4" - 10	5-1/2"	Automann 138.1010 Euclid E-15020 Gunite AS1136/AS1152 Haldex CS56036				
	SA1138			1-1/4" - 24	5-1/2"	Automann 138.2410 Euclid E-15022 Gunite AS1138/AS1154 Haldex CS56038		
	SA1132					1-1/2" - 10	5-1/2"	Automann 138.1011 Euclid E-15016 Gunite AS1132/AS1146
	SA1133							1-1/2" - 10

GUNITE STYLE AUTOMATIC SLACK ADJUSTERS

		PART NO.	SPLINE	ARM LENGTH	REPLACES
		SA1140			Automann 138.2810 Euclid E-15024 Gunite AS1140/AS1149
			1-1/2" - 28	5-1/2"	
		SA1141			
			1-1/2" - 28	6"	
		SA1144			Automann 138.3741 Euclid E-15028 Gunite AS1144 Haldex CS56044
			1-5/8" - 37	6"	
		CLEVIS ASSEMBLY Gunite Style Automatic Slack			Euclid E-15069 Gunite AS3016 Haldex CQ36544
		S2006			
			Thread Diameter	5/8" - 18	
			Large Pin Diameter	1/2"	
			Small Pin Diameter	0.235"	
		CLEVIS ASSEMBLY Gunite Style Automatic Slack			Automann 179.YK5814 Batco 05-590 BWP ZE9133 Euclid E-15061 Gunite AS3000
		S2007			
			Thread Diameter	5/8" - 18	
			Large Pin Diameter	1/2"	
			Small Pin Diameter	0.244"	

HALDEX STYLE AUTOMATIC SLACK ADJUSTERS

FEATURES

- * Adjust on Stroke Return
- * External Bracket Actuation
- * Manual Adjustment/Low Rotation Force
- * Clearance Sensing
- * Bolt on Slotted Bracket
- * No Clevis

		PART NO.	SPLINE	ARM LENGTH	REPLACES
					Automann 133.2832
				For Mack Drive Axles	Batco 05-659
					BWP M-4056
		SA10144			Euclid E-6918A
			1-1/2" - 28	6"	Haldex 40010144
					Leland L-3608
					Meritor R806016
					Automann 133.1030
				Standard Drive Axle Brakes	Batco 05-654
					BWP M-4057
		SA10102			Euclid E-6923B
			1-1/2" - 10	5" - 6"	Haldex 40010142
					Leland L-3606
					Meritor R806023
					Automann 133.1031
				Standard Drive Axle Brakes	Batco 05-661
				BWP M-4058	
	SA10103			Euclid E-6924B	
		1-1/2" - 10	5-1/2" - 6-1/2"	Haldex 40010143	
				Leland L-3607	
				Meritor R806022	
				Automann 133.2830	
			Standard Drive Axle Brakes	Batco 05-655	
				BWP M-4059	
	SA10100			Euclid E-6925B	
		1-1/2" - 28	5" - 6"	Haldex 40010140	
				Leland L-3604	
				Meritor R806024	

HALDEX STYLE AUTOMATIC SLACK ADJUSTERS

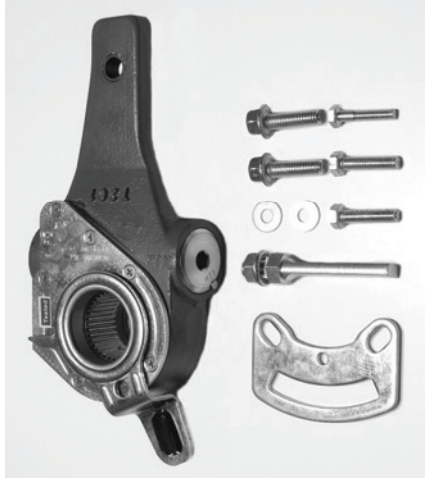
		PART NO.	SPLINE	ARM LENGTH	REPLACES	
					Automann 133.2831 Batco 05-663 BWP M-4060	
					Standard Drive Axle Brakes	
		SA10101				Euclid E-6927B Haldex 40010141 Leland L-3605 Meritor R806004/26
			1-1/2" - 28	5-1/2" - 6-1/2"		
						Automann 133.1042 Batco 05-650 BWP M-4061
						12-1/4" Trailer Axle Brakes
		SA10306				Euclid E-6928 Haldex 40010306 Leland L-3615 Meritor R806007
			1-1/2" - 10	6"		
					Automann 133.2842 Batco 05-651 BWP M-4062	
					12-1/4" Trailer Axle Brakes	
	SA10305				Euclid E-6933 Haldex 40010305 Leland L-3614 Meritor R806006	
		1-1/2" - 28	6"			
					Automann 133.1040 Batco 05-667 BWP M-4063	
					16-1/2" Trailer Axle Brakes	
	SA10215				Euclid E-6940 Haldex 40010215 Leland L-3612 Meritor R806021	
		1-1/2" - 10	5-1/2"			
					Automann 133.1041 Batco 05-660 BWP M-4064	
					16-1/2" Trailer Axle Brakes	
	SA10216				Euclid E-6936 Haldex 40010216 Leland L-3613 Meritor R806015	
		1-1/2" - 10	6"			
					Automann 133.2840 Batco 05-668 BWP M-4065	
					16-1/2" Trailer Axle Brakes	
	SA10211				Euclid E-6944 Haldex 40010211 Leland L-3618 Meritor R806019	
		1-1/2" - 28	5-1/2"			

HALDEX STYLE AUTOMATIC SLACK ADJUSTERS





		PART NO.	SPLINE	ARM LENGTH	REPLACES
					Automann 133.2841 Batco 05-662 BWP M-4066 Euclid E-6942 Haldex 40010212 Leland L-3610 Meritor R806013
				16-1/2" Trailer Axle Brakes	
	SA10212				
		1-1/2" - 28	6"		
					Automann 133.3741 Batco 05-664 BWP M-4067 Euclid E-6946 Haldex 40010214 Leland L-3611 Meritor R806014
				16-1/2" Fruehauf Trailer Axle Brakes	
SA10214					
	1-5/8" - 37	6"			

MERITOR STYLE AUTOMATIC SLACK ADJUSTERS

FEATURES

- * Completely Sealed Against Corrosion
- * Factory Lubricated
- * Corrosion Resistant Plating
- * Includes Installation Guide
- * Includes Template

PART NO.	SPLINE	ARM LENGTH	REPLACES
----------	--------	------------	----------

	SA1041	1-1/2" - 10	5-1/2"	Automann 139.1031 BWP M-4043 Euclid E-11398 Meritor R801041
	SA1042	1-1/2" - 10	6"	Automann 139.1030 BWP M-4044 Euclid E-11399 Meritor R801042
	SA1073	1-1/2" - 28	5-1/2"	Automann 139.2831 BWP M-4046 Euclid E-11401 Meritor R801073
	SA1074	1-1/2" - 28	6"	Automann 139.2830 BWP M-4047 Euclid E-11402 Meritor R801074
	S2009	CLEVIS ASSEMBLY		Automann 179.YK5005 Euclid E-11430/A Meritor R810009/19
		Meritor Style Automatic Slack		
		Thread Diameter	5/8" - 18	
		Large Pin Diameter	1/2"	
		Small Pin Diameter	0.245"	

CAMSHAFT F.I.F. CHART

11/16"		1-1/16"		1-1/8"		1-3/16"		1-3/8"	
									
TYPE 1		TYPE 2		TYPE 3		TYPE 4		TYPE 5	
LENGTH	HEAD	SPLINE	JOURNAL	PART NO.	AXLE	CAM KIT		APPLICATION	
7-21/32"	4	1-1/4" - 10	1-1/4"	C750L/1R	S	B8743 (T), B8744 (Q)		Meritor 15" T & Q	
7-23/32"	3	1-1/2" - 28	1-1/2"	C645L/6R	D	B8707, B8771, B8745		Meritor 16-1/2" Q-Plus	
7-7/8"	5	1-1/2" - 10	1-1/2"	C707L/6R	D	B8646		Meritor 16-1/2" P & Q	
7-7/8"	3	1-1/2" - 10	1-1/2"	C707BL/6BR	D	B8707		Meritor 16-1/2" Q-Plus	
7-15/16"	4	1-1/4" - 10	1-1/4"	C752L/3R	S	B8743 (T), B8744 (Q)		Meritor 15" T & Q	
8-1/16"	5	1-1/2" - 28	1-1/2"	C499L/0R	D	B8707, B8771, B8745		Meritor 16-1/2" Q	
8-1/16"	3	1-1/2" - 28	1-1/2"	C647L/8R	D	B8707, B8771, B8745		Meritor 16-1/2" Q-Plus	
8-1/2"	4	1-1/4" - 10	1-1/4"	C754L/5R	S	B8743 (T), B8744 (Q)		Meritor 15" T & Q	
8-9/16"	5	1-1/2" - 10	1-1/2"	C800L/9R	D	B8648		Eaton 16-1/2"	
8-9/16"	5	1-1/2" - 10	1-1/2"	C479L/8R	D	B8646		Meritor 16-1/2" P & Q	
8-9/16"	3	1-1/2" - 10	1-1/2"	C479BL/8BR	D	B8707		Meritor 16-1/2" Q-Plus	
8-9/16"	5	1-1/2" - 28	1-1/2"	C896L/7R	D	B8707, B8771, B8745		Meritor 16-1/2" Q	
8-9/16"	3	1-1/2" - 28	1-1/2"	C427L/6R	D	B8707, B8771, B8745		Meritor 16-1/2" Q-Plus	
8-5/8"	3	1-1/2" - 10	1-1/2"	C490L/1R	D	B8746Z		Eaton 16-1/2" ES	
9-1/16"	5	1-1/2" - 28	1-1/2"	C898L/9R	D	B8707, B8771, B8745		Meritor 16-1/2" Q	
9-1/16"	3	1-1/2" - 28	1-1/2"	C651L/2R	D	B8707, B8771, B8745		Meritor 16-1/2" Q-Plus	
9-1/4"	4	1-1/4" - 10	1-1/4"	C756L/7R	S	B8743 (T), B8744 (Q)		Meritor 15" T & Q	
9-7/16"	5	1-1/2" - 28	1-1/2"	C649L/0R	D	B8707, B8771, B8745		Meritor 16-1/2" Q	
9-7/16"	3	1-1/2" - 28	1-1/2"	C653L/4R	D	B8707, B8771, B8745		Meritor 16-1/2" Q-Plus	
9-9/16"	4	1-1/4" - 10	1-1/4"	C763L/4R	S	B8743 (T), B8744 (Q)		Meritor 15" T & Q	
9-13/16"	4	1-1/4" - 10	1-1/4"	C761L/2R	S	B8743 (T), B8744 (Q)		Meritor 15" T & Q	
10-3/16"	3	1-1/2" - 28	1-1/2"	C504L/5R	D	B8707, B8771, B8745		Meritor 16-1/2" Q-Plus	
10-13/32"	5	1-1/2" - 28	1-1/2"	C347L/8R	D	B8707, B8771, B8745		Meritor 16-1/2" Q	
10-13/32"	3	1-1/2" - 28	1-1/2"	C655L/6R	D	B8707, B8771, B8745		Meritor 16-1/2" Q-Plus	
10-1/2"	3	1-1/2" - 10	1-1/2"	C886L/7R	D	B8648		Eaton 16-1/2" ES	
10-19/32"	3	1-1/2" - 28	1-1/2"	C541L/0R	D	B8707, B8771, B8745		Meritor 16-1/2" Q-Plus	
10-7/8"	5	1-1/2" - 28	1-1/2"	C727L/6R	D	B8707, B8771, B8745		Meritor 16-1/2" Q	
10-7/8"	3	1-1/2" - 28	1-1/2"	C657L/8R	D	B8707, B8771, B8745		Meritor 16-1/2" Q-Plus	
11-1/16"	3	1-1/2" - 10	1-1/2"	C607L/6R	T	B8790, B8805		Intraax 16-1/2" ES	
11-1/16"	3	1-1/2" - 28	1-1/2" D	C609L/8R	T	B8794, B8805		Intraax 16-1/2" ES	
11-1/8"	3	1-1/2" - 28	1-1/2"	C524L/2R	D	B8707, B8771, B8745		Meritor 16-1/2" Q-Plus	
11-1/8"	5	1-1/2" - 10	1-1/2"	C601L/0R	T	B8790, B8805		Intraax 16-1/2"	
11-1/8"	5	1-1/2" - 28	1-1/2"	C603L/2R	T	B8790, B8805		Intraax 16-1/2"	
11-1/8"	3	1-1/2" - 28	1-1/2"	C605L/4R	T	B8790, B8805		Intraax 16-1/2" ES	
11-7/32"	5	1-1/2" - 28	1-1/2"	C349L/0R	D	B8707, B8771, B8745		Meritor 16-1/2" Q	
11-9/32"	5	1-1/2" - 10	1-1/2"	C774L/3R	D	B8646		Meritor 16-1/2" P & Q	
11-9/32"	3	1-1/2" - 10	1-1/2"	C774CL/3CR	D	B8707		Meritor 16-1/2" Q-Plus	
11-1/2"	5	1-1/2" - 10	1-1/2"	C776L/5R	D	B8648		Eaton 16-1/2"	
11-1/2"	3	1-1/2" - 10	1-1/2"	C148CL/7CR	D	B8707		Meritor 16-1/2" Q-Plus	
11-1/2"	5	1-1/2" - 10	1-1/2"	C148L/7R	D	B8646		Meritor 16-1/2" P & Q	
11-1/2"	3	1-1/2" - 10	1-1/2"	C492L/3R	D	B8746Z		Eaton 16-1/2" ES	

CAMSHAFT F.I.F. CHART

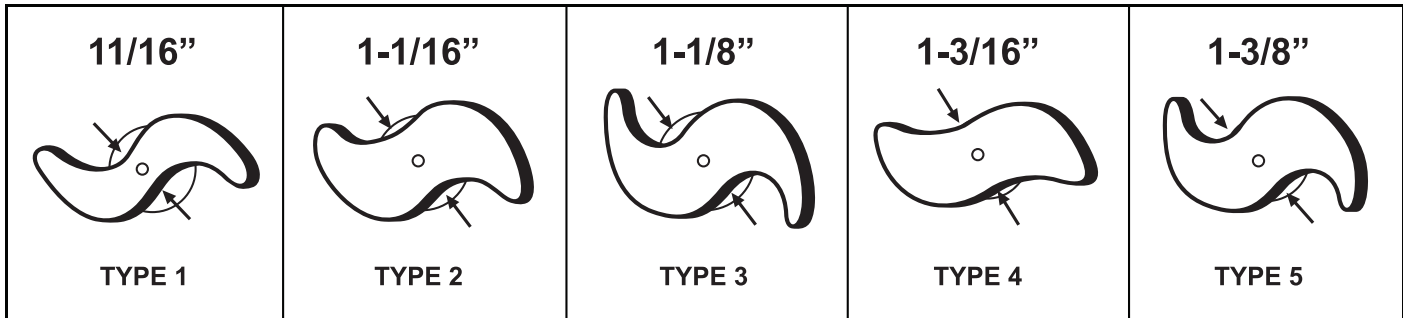

LENGTH	HEAD	SPLINE	JOURNAL	PART NO.	AXLE	CAM KIT	APPLICATION
11-9/16"	5	1-1/2" - 28	1-1/2"	C351L/2R	D	B8707, B8771, B8745	Meritor 16-1/2" Q
11-9/16"	3	1-1/2" - 28	1-1/2"	C537L/6R	D	B8707, B8771, B8745	Meritor 16-1/2" Q-Plus
11-11/16"	5	1-1/2" - 28	1-1/2"	C882L/3R	D	B8707, B8771, B8745	Meritor 16-1/2" Q
11-11/16"	3	1-1/2" - 28	1-1/2"	C663L/4R	D	B8707, B8771, B8745	Meritor 16-1/2" Q-Plus
11-3/4"	5	1-1/2" - 10	1-1/2"	C703L/2R	D	B8646	Meritor 16-1/2" P & Q
11-3/4"	3	1-1/2" - 10	1-1/2"	C703BL/2BR	D	B8707	Meritor 16-1/2" Q-Plus
11-15/16"	3	1-1/2" - 28	1-1/2"	C665L/6R	D	B8707, B8771, B8745	Meritor 16-1/2" Q-Plus
12-7/16"	5	1-1/2" - 10	1-1/2"	C787L/6R	D	B8648	Eaton 16-1/2"
12-7/16"	5	1-1/2" - 28	1-1/2"	C894L/5R	D	B8707, B8771, B8745	Meritor 16-1/2" Q
12-7/16"	3	1-1/2" - 28	1-1/2"	C667L/8R	D	B8707, B8771, B8745	Meritor 16-1/2" Q-Plus
12-1/2"	3	1-1/2" - 10	1-1/2"	C769L/0R	D	B8746Z	Eaton 16-1/2" ES
12-1/2"	5	1-1/2" - 10	1-1/2"	C709L/8R	D	B8646	Meritor 16-1/2" P & Q
12-1/2"	3	1-1/2" - 10	1-1/2"	C709BL/8BR	D	B8707	Meritor 16-1/2" Q-Plus
12-15/16"	5	1-1/2" - 10	1-1/2"	C888L/9R	D	B8648	Eaton 16-1/2"
12-15/16"	5	1-1/2" - 28	1-1/2"	C729L/8R	D	B8707, B8771, B8745	Meritor 16-1/2" Q
12-15/16"	3	1-1/2" - 28	1-1/2"	C669L/0R	D	B8707, B8771, B8745	Meritor 16-1/2" Q-Plus
13-7/32"	5	1-1/2" - 28	1-1/2"	C731L/0R	D	B8707, B8771, B8745	Meritor 16-1/2" Q
13-7/32"	3	1-1/2" - 28	1-1/2"	C595L/4R	D	B8707, B8771, B8745	Meritor 16-1/2" Q-Plus
13-7/16"	3	1-1/2" - 10	1-1/2"	C740L/1R	D	B8648	Eaton 16-1/2" ES
13-7/16"	5	1-1/2" - 28	1-1/2"	C733L/2R	D	B8707, B8771, B8745	Meritor 16-1/2" Q
13-7/16"	3	1-1/2" - 28	1-1/2"	C733AL/2AR	D	B8707, B8771, B8745	Meritor 16-1/2" Q-Plus
13-19/32"	3	1-1/2" - 28	1-1/2"	C569L/8R	D	B8707, B8771, B8745	Meritor 16-1/2" Q-Plus
14-3/32"	5	1-1/2" - 28	1-1/2"	C735L/4R	D	B8707, B8771, B8745	Meritor 16-1/2" Q
14-3/32"	3	1-1/2" - 28	1-1/2"	C675L/6R	D	B8707, B8771, B8745	Meritor 16-1/2" Q-Plus
14-1/8"	5	1-1/2" - 10	1-1/2"	C880L/1R	D	B8646	Meritor 16-1/2" P & Q
14-19/32"	5	1-1/2" - 28	1-1/2"	C085L/6R	D	B8707, B8771, B8745	Meritor 16-1/2" Q
14-19/32"	3	1-1/2" - 28	1-1/2"	C677L/8R	D	B8707, B8771, B8745	Meritor 16-1/2" Q-Plus
14-3/4"	3	1-1/2" - 28	1-1/2"	C679L/0R	D	B8707, B8771, B8745	Meritor 16-1/2" Q-Plus
15"	5	1-1/2" - 10	1-1/2"	C055L/6R	D	B8648	Eaton 16-1/2"
15-3/16"	5	1-1/2" - 28	1-1/2"	C083L/4R	D	B8707, B8771, B8745	Meritor 16-1/2" Q
15-3/16"	3	1-1/2" - 28	1-1/2"	C681L/2R	D	B8707, B8771, B8745	Meritor 16-1/2" Q-Plus
15-19/32"	3	1-1/2" - 28	1-1/2"	C306L/7R	D	B8707, B8771, B8745	Meritor 16-1/2" Q-Plus
15-23/32"	5	1-1/2" - 28	1-1/2"	C185L/6R	D	B8707	Meritor 16-1/2" Q
15-23/32"	3	1-1/2" - 28	1-1/2"	C683L/4R	D	B8707, B8771, B8745	Meritor 16-1/2" Q-Plus
15-3/4"	5	1-1/2" - 10	1-1/2"	C711L/0R	D	B8646	Meritor 16-1/2" P & Q
15-3/4"	3	1-1/2" - 10	1-1/2"	C711BL/0BR	D	B8707	Meritor 16-1/2" Q-Plus
15-13/16"	3	1-1/2" - 28	1-1/2"	C585L/4R	D	B8707, B8771, B8745	Meritor 16-1/2" Q-Plus
16-1/8"	5	1-5/8" - 37	1-5/8"	C563L/4R	T	B8649, B8650	Fruehauf 16-1/2"
16-1/2"	5	1-1/2" - 10	1-1/2"	C687L/6R	T	----	Multiple
16-1/2"	3	1-1/2" - 28	1-1/2" D	C528L/9R	T	B8652	Spicer 16-1/2" XL
17-3/16"	3	1-1/2" - 28	1-1/2" D	C096L/7R	T	B8652	Spicer 16-1/2" XL

CAMSHAFT F.I.F. CHART

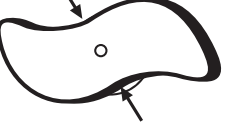
11/16"		1-1/16"		1-1/8"		1-3/16"		1-3/8"	
									
TYPE 1		TYPE 2		TYPE 3		TYPE 4		TYPE 5	
LENGTH	HEAD	SPLINE	JOURNAL	PART NO.	AXLE	CAM KIT		APPLICATION	
17-5/16"	5	1-1/2" - 10	1-5/8" D	C447L/8R	T	B8683, B8747		Meritor 16-1/2" Q	
17-5/16"	3	1-1/2" - 10	1-5/8" D	C447AL/8AR	T	B8683, B8747		Meritor 16-1/2" Q-Plus	
17-5/16"	5	1-1/2" - 28	1-5/8" D	C441L/2R	T	B8683, B8747		Meritor 16-1/2" Q	
17-5/16"	3	1-1/2" - 28	1-5/8" D	C441BL/2BR	T	B8683, B8747		Meritor 16-1/2" Q-Plus	
17-5/16"	5	1-1/2" - 28	1-5/8" D	C091L/2R	T	B8772M, B8773M		Meritor 16-1/2" Q	
17-5/16"	3	1-1/2" - 28	1-5/8" D	C867L/6R	T	B8772M, B8773M		Meritor 16-1/2" Q-Plus	
17-3/8"	5	1-1/2" - 10	1-1/2"	C795L/4R	T	-----		Multiple	
17-3/8"	5	1-1/2" - 28	1-1/2" D	C724L/5R	T	B8652		Spicer 16-1/2"	
17-3/8"	3	1-1/2" - 10	1-1/2" D	C516L/7R	T	B8652		Spicer 16-1/2" XL	
17-7/16"	3	1-1/2" - 28	1-1/2" D	C518L/9R	T	B8652		Spicer 16-1/2" XL	
17-7/16"	3	1-1/2" - 28	1-5/8"	C931L/2R	T	B8792		Spicer 16-1/2" XL	
17-3/4"	5	1-1/2" - 10	1-1/2"	C715L/4R	T	-----		Multiple	
17-3/4"	3	1-1/2" - 10	1-1/2"	C715AL/4AR	D	B8707		Meritor 16-1/2" Q-Plus	
18-3/8"	3	1-1/2" - 10	1-1/2"	C691L/0R	T	-----		Multiple And Q-Plus	
18-5/8"	5	1-1/2" - 10	1-1/2"	C413L/2R	T	-----		Multiple	
18-5/8"	3	1-1/2" - 10	1-1/2"	C413AL/2AR	D	B8707		Meritor 16-1/2" Q-Plus	
19-1/2"	5	1-1/2" - 10	1-5/8"	C693L/4R	T	B8684		Eaton 16-1/2"	
19-1/2"	3	1-1/2" - 10	1-5/8"	C494L/5R	T	B8684		Eaton 16-1/2" ES	
19-1/2"	3	1-1/2" - 28	1-5/8"	C057L/8R	T	B8684		Eaton 16-1/2" ES	
20-7/32"	5	1-1/2" - 28	1-5/8"	C723L/2R	T	B8684		Eaton 16-1/2"	
20-3/8"	5	1-1/2" - 10	1-1/2" D	C425L/4R	T	-----		Multiple	
20-3/8"	3	1-1/2" - 10	1-1/2" D	C425AL/4AR	T	-----		Multiple And Q-Plus	
20-3/8"	5	1-1/2" - 28	1-1/2" D	C854L/5R	T	B8652		Spicer 16-1/2"	
20-3/8"	3	1-1/2" - 10	1-1/2" D	C514L/5R	T	B8652		Spicer 16-1/2" XL	
20-13/32"	5	1-1/2" - 10	1-5/8" D	C449L/0R	T	B8683, B8747		Meritor 16-1/2" Q	
20-13/32"	3	1-1/2" - 10	1-5/8" D	C449AL/0BR	T	B8683, B8747		Meritor 16-1/2" Q-Plus	
20-13/32"	5	1-1/2" - 28	1-5/8" D	C443L/4R	T	B8683, B8747		Meritor 16-1/2" Q	
20-13/32"	3	1-1/2" - 28	1-5/8" D	C443BL/4BR	T	B8683, B8747		Meritor 16-1/2" Q-Plus	
20-13/32"	5	1-1/2" - 28	1-5/8" D	C087L/8R	T	B8772M, B8773M		Meritor 16-1/2" Q	
20-13/32"	3	1-1/2" - 28	1-5/8" D	C871L/0R	T	B8772M, B8773M		Meritor 16-1/2" Q-Plus	
20-7/16"	3	1-1/2" - 28	1-1/2" D	C520L/1R	T	B8652		Spicer 16-1/2" XL	
20-7/16"	3	1-1/2" - 28	1-5/8"	C933L/4R	T	B8792		Spicer 16-1/2" XL	
21-3/32"	5	1-1/2" - 10	1-1/2"	C688L/9R	T	-----		Multiple	
21-1/8"	5	1-5/8" - 37	1-5/8"	C101L/0R	T	B8649, B8650		Fruehauf 16-1/2"	
21-1/8"	2	1-1/2" - 10	1-1/2" D	C411L/0R	T	B8655, B8655Z		Spicer 12-1/4"	
21-3/8"	3	1-1/2" - 28	1-5/8"	C310L/1R	T	B8792		Spicer 16-1/2" XL	
22-3/8"	5	1-1/2" - 10	1-1/2"	C089L/0R	T	-----		Multiple	
22-7/8"	5	1-1/2" - 10	1-1/2"	C884L/5R	T	-----		Multiple	
22-7/8"	3	1-1/2" - 10	1-1/2" D	C611L/2R	T	B8652		Spicer 16-1/2" XL	
22-7/8"	5	1-1/2" - 28	1-1/2" D	C890L/1R	T	B8652		Spicer 16-1/2"	
22-7/8"	3	1-1/2" - 28	1-5/8"	C312L/3R	T	B8792		Spicer 16-1/2" XL	

CAMSHAFT F.I.F. CHART

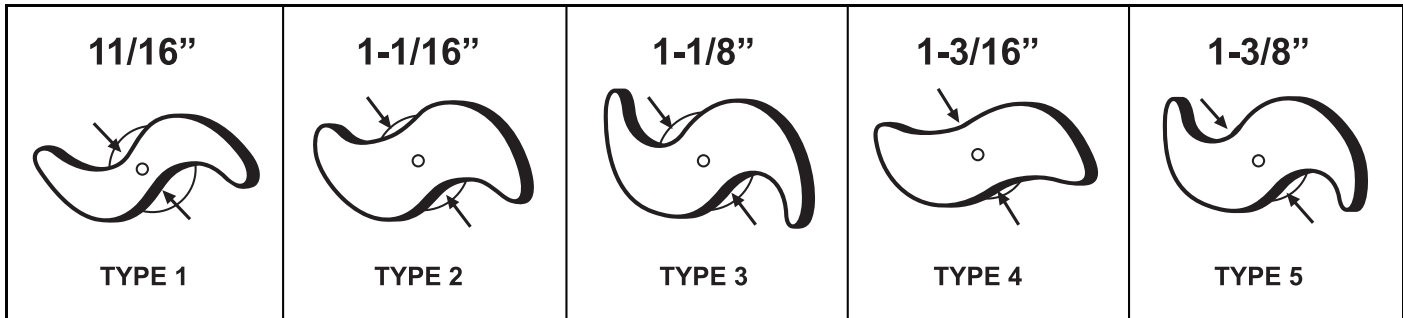

LENGTH	HEAD	SPLINE	JOURNAL	PART NO.	AXLE	CAM KIT	APPLICATION
22-15/16"	3	1-1/2" - 28	1-1/2" D	C098L/9R	T	B8652	Spicer 16-1/2" XL
23-3/16"	1	1-1/2" - 28	1-1/2"	C759L/0R	T	B8655, B8655Z	Spicer 12-1/4"
23-3/16"	1	1-1/2" - 28	1-5/8"	C905L/6R	T	B8792	Spicer 12-1/4"
23-1/4"	2	1-1/2" - 10	1-1/2" D	C423L/2R	T	B8655, B8655Z	Spicer 12-1/4"
23-7/16"	5	1-1/2" - 10	1-1/2" D	C095L/4R	T	-----	Multiple
23-7/16"	5	1-1/2" - 28	1-1/2" D	C856L/7R	T	B8652	Spicer 16-1/2"
23-1/2"	3	1-1/2" - 10	1-1/2" D	C512L/3R	T	B8652	Spicer 16-1/2" XL
23-9/16"	3	1-1/2" - 28	1-1/2" D	C526L/7R	T	B8652	Spicer 16-1/2" XL
23-9/16"	3	1-1/2" - 28	1-5/8"	C935L/6R	T	B8792	Spicer 16-1/2" XL
23-3/4"	5	1-1/2" - 10	1-5/8"	C721L/0R	T	B8684	Eaton 16-1/2"
23-3/4"	3	1-1/2" - 10	1-5/8"	C496L/7R	T	B8684	Eaton 16-1/2" ES
23-3/4"	3	1-1/2" - 28	1-5/8"	C059L/0R	T	B8684	Eaton 16-1/2" ES
23-7/8"	2	1-1/2" - 10	1-1/2" D	C421L/0R	T	B8655, B8655Z	Spicer 12-1/4"
23-7/8"	3	1-1/2" - 28	1-1/2" D	C530L/1R	T	B8652	Spicer 16-1/2" XL
23-7/8"	5	1-5/8" - 37	1-5/8"	C861L/2R	T	B8649, B8650	Fruehauf 16-1/2"
24"	5	1-1/2" - 10	1-1/2" D	C717L/6R	T	-----	Multiple
24"	3	1-1/2" - 10	1-1/2" D	C927L/8R	T	B8652	Spicer 16-1/2" XL
24-1/16"	5	1-1/2" - 10	1-5/8" D	C451L/2R	T	B8683, B8747	Meritor 16-1/2" Q
24-1/16"	3	1-1/2" - 10	1-5/8" D	C451AL/2AR	T	B8683, B8747	Meritor 16-1/2" Q-Plus
24-1/16"	5	1-1/2" - 28	1-5/8" D	C445L/6R	T	B8683, B8747	Meritor 16-1/2" Q
24-1/16"	3	1-1/2" - 28	1-5/8" D	C445BL/6BR	T	B8683, B8747	Meritor 16-1/2" Q-Plus
24-1/16"	5	1-1/2" - 28	1-5/8" D	C081L/2R	T	B8772M, B8773M	Meritor 16-1/2" Q
24-1/16"	3	1-1/2" - 28	1-5/8" D	C868L/9R	T	B8772M, B8773M	Meritor 16-1/2" Q-Plus
24-1/16"	3	1-1/2" - 28	1-1/2" D	C102L/3R	T	B8652	Spicer 16-1/2" XL
24-1/16"	3	1-1/2" - 28	1-5/8"	C910L/1R	T	B8792	Spicer 16-1/2" XL
24-1/16"	5	1-1/2" - 28	1-1/2" D	C892L/3R	T	B8652	Spicer 16-1/2" XL
24-3/8"	5	1-1/2" - 10	1-1/2" D	C797L/6R	T	-----	Multiple
25-3/4"	5	1-1/2" - 10	1-1/2"	C719L/8R	T	-----	Multiple
26-1/4"	5	1-1/2" - 10	1-1/2"	C217L/8R	T	B8652	Spicer 16-1/2"
26-1/4"	3	1-1/2" - 10	1-1/2" D	C742L/3R	T	B8652	Spicer 16-1/2" XL
26-1/4"	3	1-1/2" - 28	1-1/2" D	C532L/3R	T	B8652	Spicer 16-1/2" XL
26-1/4"	3	1-1/2" - 28	1-5/8"	C314L/5R	T	B8792	Spicer 16-1/2" XL
26-1/2"	5	1-1/2" - 10	1-1/2"	C219L/0R	T	B8652	Spicer 16-1/2"
26-15/16"	3	1-1/2" - 28	1-1/2" D	C972L/3R	T	B8652	Spicer 16-1/2" XL
26-15/16"	3	1-1/2" - 28	1-5/8"	C737L/8R	T	B8792	Spicer 16-1/2" XL

Copyright 2016 Sirco Industries, Inc.

"D" = Double-Grooved

BRAKE CAMSHAFTS - STEER AXLE

Meritor 15" "T" and "Q" - New Style "S"

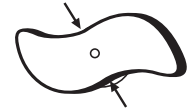
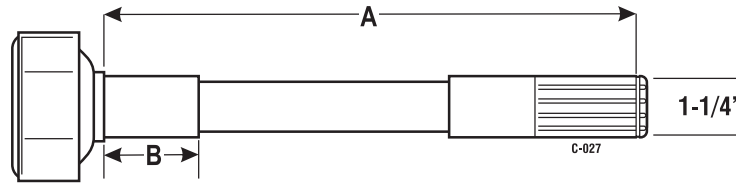

1-3/16"
LEFT HAND

1-1/4" Dia. - 10 Spline

"A" Dimension: under head to beginning of lock ring groove

LH	RH	A	B	C	NOTES	REPLACES	
C750L		7-21/32"	---	---	Camshaft Kits B8743 (T) B8744 (Q)	Automann 122.100721.03 Batco 04-200772 BWP M-3122L Euclid E-9693 Leland L-3579	Meritor 2210D6842 Spicer 18-955
	C751R					Automann 122.100721.04 Batco 04-200771 BWP M-3122R Euclid E-9694 Leland L-3578	Meritor 2210E6843 Spicer 18-954
C752L		7-15/16"	---	---	Camshaft Kits B8743 (T) B8744 (Q)	Automann 122.100730.03 Batco 04-200812 BWP M-3123L Euclid E-9695 Haldex CS40106	Leland L-3323 Meritor 2210F6844 Spicer 18-951
	C753R					Automann 122.100730.04 Batco 04-200811 BWP M-3123R Euclid E-9696 Haldex CS40107	Leland L-3322 Meritor 2210G6845 Spicer 18-950
C754L		8-1/2"	---	---	Camshaft Kits B8743 (T) B8744 (Q)	Automann 122.100816.05 Batco 04-200852 BWP M-3124L Euclid E-9697 Haldex CS40108	Leland L-3327 Meritor 2210M6851 Spicer 18-953
	C755R					Automann 122.100816.06 Batco 04-200851 BWP M-3124R Euclid E-9698 Haldex CS40109	Leland L-3326 Meritor 2210N6852 Spicer 18-952
C756L		9-1/4"	---	---	Camshaft Kits B8743 (T) B8744 (Q)	Automann 122.100908.03 Batco 04-200932 BWP M-4073L Euclid E-9699 Haldex CS40102	Leland L-3577 Meritor 2210R6856 Spicer 18-957
	C757R					Automann 122.100908.04 Batco 04-200931 BWP M-4073R Euclid E-9700 Haldex CS40103	Leland L-3576 Meritor 2210S6857 Spicer 18-956
C763L		9-9/16"	---	---	Camshaft Kits B8743 (T) B8744 (Q)	Automann 122.100918.03 Batco 04-200962 BWP M-3125L Euclid E-9701 Haldex CS40110	Leland L-3325 Meritor 2210V6860 Spicer 18-959
	C764R					Automann 122.100918.04 Batco 04-200961 BWP M-3125R Euclid E-9702 Haldex CS40111	Leland L-3324 Meritor 2210W6861 Spicer 18-958

BRAKE CAMSHAFTS - DRIVE AXLE

Meritor 15" "T" and "Q" - New Style "S"

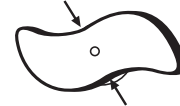
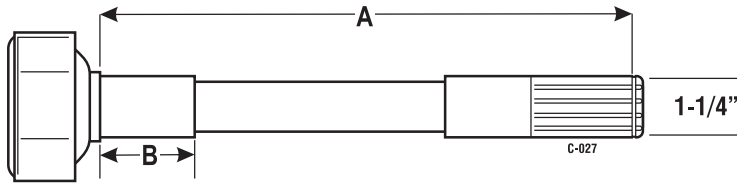

1-3/16"
LEFT HAND

1-1/4" Dia. - 10 Spline

"A" Dimension: under head to beginning
of lock ring groove

LH	RH	A	B	C	NOTES	REPLACES
		9-13/16"	---	---	Automann 122.100926.03	Meritor 2210X6862
C761L					Batco 04-201002	Spicer 18-949
					Camshaft Kits	
					B8743 (T)	
					B8744 (Q)	
					Automann 122.100926.04	Meritor 2210Y6863
					Batco 04-201001	Spicer 18-948
	C762R				BWP M-4074R	
					Euclid E-9704	
					Leland L-3580	

BRAKE CAMSHAFTS - DRIVE AXLE

Eaton Standard and "ES"

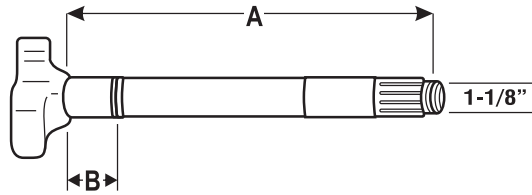

1-1/2" Dia. - 10 Spline

"A" Dimension: under head to beginning of lock ring groove

LH	RH	A	B	C	NOTES	REPLACES	
C800L		8-9/16"	---	---	For Mack and Navistar	Automann 120.100818.01	Haldex CS41026
	Batco 04-370862					Leland L-1632	
	C799R				Camshaft Kit B8648	BWP M-2615L	Meritor R607036
						Eaton 1000087	Spicer 18-727
						Euclid E-2800	
						Automann 120.100818.02	Haldex CS41027
						Batco 04-370861	Leland L-1631
						BWP M-2615R	Meritor R607035
						Eaton 1000088	Spicer 18-726
						Euclid E-2799	
C490L		8-5/8"	---	---	"ES"	Automann 120.100820.01	Haldex CS41450
	Batco 04-390862					Leland L-2971	
	C491R				Camshaft Kit B8746Z	BWP M-3129L	Meritor R607111
						Eaton 808708	Spicer 18-941
						Euclid E-5490	
						Automann 120.100820.02	Haldex CS41451
						Batco 04-390861	Leland L-2970
						BWP M-3129R	Meritor R607112
						Eaton 808709	Spicer 18-940
						Euclid E-5491	
C886L		10-1/2"	---	---	"ES"	Automann 120.101016.01	Haldex CS41032
	Batco 04-371052					Leland L-3077	
	C887R				Camshaft Kit B8648	BWP M-3176L	Meritor R607261
						Eaton 70308	Spicer 18-735
						Euclid E-4886	
						Automann 120.101016.02	Haldex CS41033
						Batco 04-371051	Leland L-3076
						BWP M-3176R	Meritor R607262
						Eaton 70309	Spicer 18-734
						Euclid E-4887	
C776L		11-1/2"	---	---		Automann 120.101116.01	Haldex CS41760
	Batco 04-371152					Leland L-1203	
	C775R				Camshaft Kit B8648	BWP M-1571L	Meritor R607016
						Eaton 70306	Spicer 18-739
						Euclid E-1776	
						Automann 120.101116.02	Haldex CS41761
						Batco 04-371151	Leland L-1202
						BWP M-1571R	Meritor R607015
						Eaton 70307	Spicer 18-738
						Euclid E-1775	
C492L		11-1/2"	---	---	"ES"	Automann 120.101118.01	Haldex CS41458
	Batco 04-391162					Leland L-2975	
	C493R				Camshaft Kit B8746Z	BWP M-3128L	Meritor R607105
						Eaton 806526	Spicer 18-943
						Euclid E-5492	
						Automann 120.101118.02	Haldex CS41459
						Batco 04-391161	Leland L-2974
						BWP M-3128R	Meritor R607106
						Eaton 806527	Spicer 18-942
						Euclid E-5493	

BRAKE CAMSHAFTS - DRIVE AXLE

Eaton Standard and "ES"

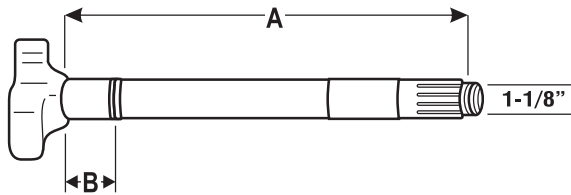

1-1/2" Dia. - 10 Spline

"A" Dimension: under head to beginning of lock ring groove

LH	RH	A	B	C	NOTES	REPLACES	
C787L		12-7/16"	---	---	For Mack and Navistar	Automann 120.101214.01	Haldex CS41042
	Batco 04-371252					Leland L-1620	
	C786R				Camshaft Kit B8648	BWP M-2616L	Meritor R607030
						Eaton 71306	Spicer 18-741
						Euclid E-2787	
						Automann 120.101214.02	Haldex CS41043
						Batco 04-371251	Leland L-1619
						BWP M-2616R	Meritor R607029
						Eaton 71307	Spicer 18-740
						Euclid E-2786	
C769L		12-1/2"	---	---	"ES"	Automann 120.101216.01	Haldex CS41460
	Batco 04-391252					Leland L-2977	
						BWP M-3127L	Meritor R607153
						Eaton 808290	Spicer 18-985
						Euclid E-9769	
						Automann 120.101216.02	Haldex CS41461
						Batco 04-391251	Leland L-2976
						BWP M-3127R	Meritor R607154
						Eaton 808291	Spicer 18-984
						Euclid E-9770	
C888L		12-15/16"	1-21/32"	---		Automann 120.101230.01	Haldex CS41046
	Batco 04-371312					Leland L-2483	
						BWP M-3184L	Meritor R607125
						Eaton 1000839	Spicer 18-749
						Euclid E-4888	
						Automann 120.101230.02	Haldex CS41047
						Batco 04-371311	Leland L-2482
						BWP M-3184R	Meritor R607126
						Eaton 1000840	Spicer 18-748
						Euclid E-4889	
C740L		13-7/16"	2-7/32"	---	"ES"	Batco 04-391352	Leland L-3079
	BWP M-4101L					Meritor R607279	
						Eaton 808068	Spicer 18-995
						Euclid E-10911	
						Haldex CS41048	
						Batco 04-391351	Leland L-3078
						BWP M-4101R	Meritor R607280
						Eaton 808069	Spicer 18-994
						Euclid E-10912	
						Haldex CS41049	
C055L		15"	---	---		Automann 120.101500.01	Haldex CS41448
	Batco 04-371512					Leland L-3145	
						BWP M-4017L	Meritor R607103
						Eaton 35430	Spicer 18-745
						Euclid E-9055	
						Automann 120.101500.02	Haldex CS41449
						Batco 04-371511	Leland L-3144
						BWP M-4017R	Meritor R607104
						Eaton 35431	Spicer 18-744
						Euclid E-9056	

BRAKE CAMSHAFTS - DRIVE AXLE

Meritor With 16-1/2" Brakes

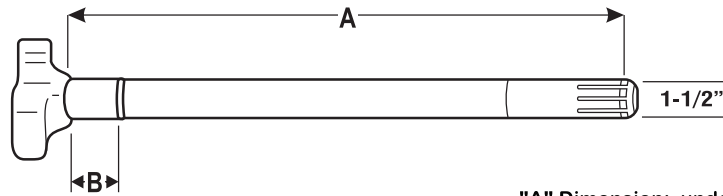

1-1/2" Dia. - 10 Spline

"A" Dimension: under head to beginning of lock ring groove

LH	RH	A	B	C	NOTES	REPLACES	
					"P" & "Q"	Batco 04-450812 BWP M-989L Euclid E-4707A Haldex CS41024 Leland L-2457	Meritor 2210X5718 Spicer 18-803
C707L		REPLACED BY C707BL					
		7-7/8"	---	---	Camshaft Kit B8646	Batco 04-450811 BWP M-989R Euclid E-4706A Haldex CS41025 Leland L-2456	Meritor 2210W5717 Spicer 18-802
	C706R	REPLACED BY C706BR					
C707BL		7-7/8"	---	---	"Q-Plus"	Automann 122.100728.02 BWP M-4018L Euclid E-4707B Meritor R607096	
	C706BR					REPLACED BY C706BR	
					Camshaft Kit B8707	Automann 122.100728.01 BWP M-4018R Euclid E-4706B Meritor R607095	
C479L		REPLACED BY C479BL			"P" & "Q"	Batco 04-450862 BWP M-996L Euclid E-2479A Haldex CS41028 Leland L-1413	Meritor 2210X5640 Spicer 18-805
		8-9/16"	---	---			
	C478R	REPLACED BY C478BR			Camshaft Kit B8646	Batco 04-450861 BWP M-996R Euclid E-2478A Haldex CS41029 Leland L-1412	Meritor 2210W5639 Spicer 18-804
C479BL		8-9/16"	---	---	"Q-Plus"	Automann 122.100818.03 BWP M-4019L Euclid E-2479B Meritor R607092	
	C478BR					REPLACED BY C478BR	
					Camshaft Kit B8707	Automann 122.100818.04 BWP M-4019R Euclid E-2478B Meritor R607091	
C774L		REPLACED BY C774CL			"P" & "Q"	Batco 04-451122 BWP M-997L Euclid E-1774B Haldex CS41014 Leland L-1205	Meritor 2210X5354 Spicer 18-809
		11-9/32"	---	---			
	C773R	REPLACED BY C773CR			Camshaft Kit B8646	Batco 04-451121 BWP M-997R Euclid E-1773B Haldex CS41015 Leland L-1204	Meritor 2210W5353 Spicer 18-808

BRAKE CAMSHAFTS - DRIVE AXLE

Meritor With 16-1/2" Brakes

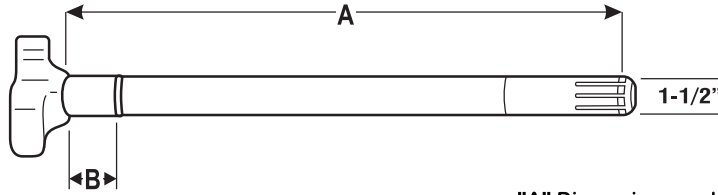

1-1/2" Dia. - 10 Spline

"A" Dimension: under head to beginning of lock ring groove

LH	RH	A	B	C	NOTES	REPLACES
					"Q-Plus"	BWP M-4020L Euclid E-1774C Meritor R607072
C774CL		11-9/32"	---	---		
					Camshaft Kit B8707	BWP M-4020R Euclid E-1773C Meritor R607071
	C773CR					

BRAKE CAMSHAFTS - DRIVE AXLE

Meritor

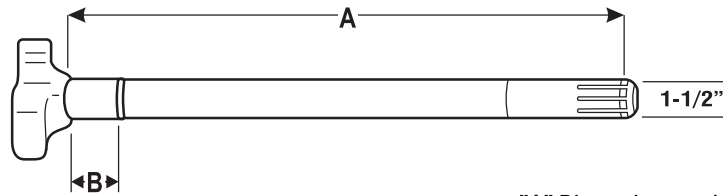

1-1/2" Dia. - 10 Spline

"A" Dimension: under head to beginning of lock ring groove

LH	RH	A	B	C	NOTES	REPLACES	
					"P" & "Q"	Batco 04-451152 BWP M-743L Euclid E-1148B Haldex CS41016 Leland L-508	Meritor 2210D5360 Spicer 18-811
C148L		REPLACED BY C148CL					
		11-1/2"	---	---	Camshaft Kit B8646	Batco 04-451151 BWP M-743R Euclid E-1147B Haldex CS41017 Leland L-507	Meritor 2210C5359 Spicer 18-810
	C147R	REPLACED BY C147CR					
					"Q-Plus"	Automann 122.101116.01 BWP M-4021L Euclid E-1148C Meritor R607076	
C148CL		11-1/2"	---	---			
					Camshaft Kit B8707	Automann 122.101116.02 BWP M-4021R Euclid E-1147C Meritor R607075	
	C147CR	REPLACED BY C147CR					
					"P" & "Q"	Batco 04-451172 BWP M-3181L Euclid E-4703A Haldex CS41036 Leland L-2453	Meritor 2210Z5720 Spicer 18-787
C703L		REPLACED BY C703BL					
		11-3/4"	---	---	Camshaft Kit B8646	Batco 04-451171 BWP M-3181R Euclid E-4702A Haldex CS41037 Leland L-2452	Meritor 2210Y5719 Spicer 18-786
	C702R	REPLACED BY C702BR					
					"Q-Plus"	Automann 122.101124.02 BWP M-4075L Euclid E-4703B Meritor R607098	
C703BL		11-3/4"	---	---			
					Camshaft Kit B8707	Automann 122.101124.01 BWP M-4075R Euclid E-4702B Meritor R607097	
	C702BR	REPLACED BY C702BR					
					"P" & "Q"	Batco 04-451252 BWP M-998L Euclid E-4709A Haldex CS41044 Leland L-2451	Meritor 2210B5358 Spicer 18-813
C709L		REPLACED BY C709BL					
		12-1/2"	---	---	Camshaft Kit B8646	Batco 04-451251 BWP M-998R Euclid E-4708A Haldex CS41045 Leland L-2450	Meritor 2210A5357 Spicer 18-812
	C708R	REPLACED BY C708BR					

BRAKE CAMSHAFTS - DRIVE AXLE

Meritor

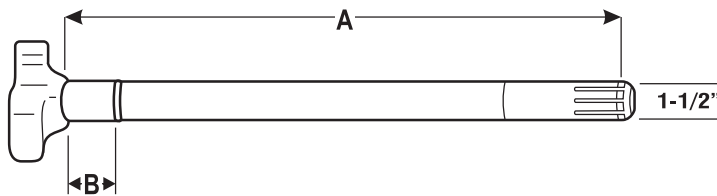

1-1/2" Dia. - 10 Spline

"A" Dimension: under head to beginning of lock ring groove

LH	RH	A	B	C	NOTES	REPLACES		
C709BL		12-1/2"	---	---	"Q-Plus" BWP Euclid Meritor	M-4076L E-4709B R607074		
	C708BR				Camshaft Kit B8707	BWP Euclid Meritor	M-4076R E-4708B R607073	
C880L		14-1/8"	---	---	"P" & "Q" Automann Batco BWP Euclid Haldex	122.101404.01 04-451422 M-4077L E-6880 CS40142	Leland Meritor Spicer	L-2402 2210H5390 18-817
	C881R				Camshaft Kit B8646	Automann Batco BWP Euclid Haldex	122.101404.02 04-451421 M-4077R E-6881 CS40143	Leland Meritor Spicer
C711L		REPLACED BY C711BL			"P" & "Q" Automann Batco BWP Euclid Haldex	122.101524.01 04-451562 M-1570L E-4711A CS41260	Spicer	18-819
	C710R	15-3/4"	---	---		122.101524.02 04-451561 M-1570R E-4710A CS41261		
		REPLACED BY C710BR			Camshaft Kit B8646			
C711BL		15-3/4"	---	---	"Q-Plus" BWP Euclid Meritor	M-4078L E-4711B R607090		
	C710BR				Camshaft Kit B8707	BWP Euclid Meritor	M-4078R E-4710B R607089	
C715L		REPLACED BY C715AL			Automann Batco Euclid Haldex Leland	122.101724.01 04-571762 E-4715 CS41278 L-2439	Meritor Spicer	2210R5712 17-573
	C714R	17-3/4"	2-7/32"	---		122.101724.02 04-571761 E-4714 CS41279 L-2438		
		REPLACED BY C714AR						

BRAKE CAMSHAFTS - DRIVE AXLE

Meritor

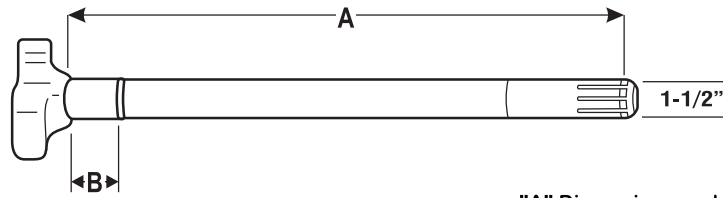

1-1/2" Dia. - 10 Spline

"A" Dimension: under head to beginning of lock ring groove

LH	RH	A	B	C	NOTES	REPLACES	
C715AL		17-3/4"	2-7/32"	---	"Q-Plus"	BWP M-4079L Euclid E-4715A Meritor R607094	
	C714AR				Camshaft Kit B8707	BWP M-4079R Euclid E-4714A Meritor R607093	
C413L		REPLACED BY C413AL				Automann 124.101820.01 Batco 04-571862 BWP M-3178L Euclid E-2413 Haldex CS41162	Leland L-262 Spicer 17-579 M16WK111-4
	C412R	18-5/8"	2-7/32"	---		Automann 124.101820.02 Batco 04-571861 BWP M-3178R Euclid E-2412 Haldex CS41163	Leland L-261 Spicer 17-578 M16WK110-4
C413AL		18-5/8"	2-7/32"	---	"Q-Plus"	BWP M-4080L Euclid E-2413A Meritor R607084	
	C412AR				Camshaft Kit B8707	BWP M-4080R Euclid E-2412A Meritor R607083	

BRAKE CAMSHAFTS - DRIVE AXLE

Meritor "Q" And "Q-Plus"

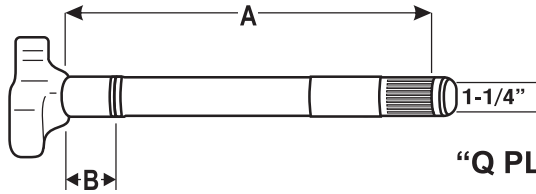

1-1/2" Dia. - 28 Spline

"A" Dimension: under head to beginning of lock ring groove

LH	RH	A	B	C	NOTES	REPLACES
C645L		7-23/32"	---	---	"Q-Plus"	Automann 122.280723.01 Batco 04-480772 BWP M-3108L Euclid E-9645 Haldex CS40172 Leland L-3039 Meritor 2210L7396 Spicer 18-501
	C646R				Camshaft Kits B8707 B8771 B8745 (Mack)	Automann 122.280723.02 Batco 04-480771 BWP M-3108R Euclid E-9646 Haldex CS40173 Leland L-3038 Meritor 2210K7395 Spicer 18-500
C499L		REPLACED BY C647L			"Q"	Automann 122.208802.01 Batco 04-460822 BWP M-4081L Euclid E-4999 Leland L-2869 Meritor 2210H5338 Spicer 18-861
	C500R	8-1/16"	---	---	Camshaft Kits B8707 B8771 B8745 (Mack)	Automann 122.208802.02 Batco 04-460821 BWP M-4081R Euclid E-5000 Leland L-2868 Meritor 2210G5337 Spicer 18-860
		REPLACED BY C648R				
C647L		8-1/16"	---	---	"Q-Plus"	Automann 122.280802.03 Batco 04-480822 BWP M-4082L Euclid E-9647 Haldex CS41172 Leland L-3437 Meritor 2210Y7409 Spicer 18-503
	C648R				Camshaft Kits B8707 B8771 B8745 (Mack)	Automann 122.280802.04 Batco 04-480821 BWP M-4082R Euclid E-9648 Haldex CS41173 Leland L-3436 Meritor 2210X7408 Spicer 18-502
C896L		REPLACED BY C427L			"Q"	Automann 122.280818.01 Batco 04-460852 BWP M-2605L Euclid E-4896 Haldex CS41550 Leland L-2871 Meritor 2210F5440 Spicer 18-825
	C897R	8-9/16"	---	---	Camshaft Kits B8707 B8771 B8745 (Mack)	Automann 122.280818.02 Batco 04-460851 BWP M-2605R Euclid E-4897 Haldex CS41551 Leland L-2870 Meritor 2210E5439 Spicer 18-824
		REPLACED BY C426R				
C427L		8-9/16"	---	---	"Q-Plus"	Automann 122.280818.03 Batco 04-480862 BWP M-3109L Euclid E-9649 Haldex CS40174 Leland L-3351 Meritor 2210Q7427 Spicer 18-505
	C426R				Camshaft Kits B8707 B8771 B8745 (Mack)	Automann 122.280818.04 Batco 04-480861 BWP M-3109R Euclid E-9650 Haldex CS40175 Leland L-3350 Meritor 2210P7426 Spicer 18-504

BRAKE CAMSHAFTS - DRIVE AXLE

Meritor "Q" And "Q-Plus"

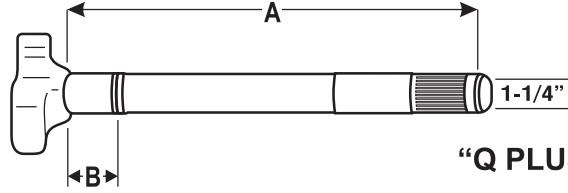

1-1/2" Dia. - 28 Spline

"A" Dimension: under head to beginning of lock ring groove

LH	RH	A	B	C	NOTES	REPLACES	
					"Q"	Automann 122.280902.01 Batco 04-460922 BWP M-3121L Euclid E-4898 Haldex CS41552	Meritor 2210V5456 Spicer 18-851
C898L		REPLACED BY C651L					
		9-1/16"	---	---	Camshaft Kits B8707 B8771 B8745 (Mack)	Automann 122.280902.02 Batco 04-460921 BWP M-3121R Euclid E-4899 Haldex CS41553	Meritor 2210U5455 Spicer 18-850
	C899R	REPLACED BY C652R					
		9-1/16"	---	---	"Q-Plus"	Automann 122.280902.03 Batco 04-480922 BWP M-4083L Euclid E-9651 Haldex CS41158	Leland L-3399 Meritor 2210G7443 Spicer 18-507
C651L		REPLACED BY C652R					
	C652R	REPLACED BY C652R			Camshaft Kits B8707 B8771 B8745 (Mack)	Automann 122.280902.04 Batco 04-480921 BWP M-4083R Euclid E-9652 Haldex CS41159	Leland L-3398 Meritor 2210F7442 Spicer 18-506
		REPLACED BY C653L					
		9-7/16"	---	---	"Q"	Automann 122.280914.01 Batco 04-460952 Euclid E-4725 Haldex CS41554 Leland L-2875	Meritor 2210T5428 Spicer 18-865
C649L		REPLACED BY C654R					
	C650R	REPLACED BY C654R			Camshaft Kits B8707 B8771 B8745 (Mack)	Automann 122.280914.02 Batco 04-460951 Euclid E-4724 Haldex CS41555 Leland L-2874	Meritor 2210S5427 Spicer 18-864
		REPLACED BY C653L					
		9-7/16"	---	---	"Q-Plus"	Automann 122.280914.05 Batco 04-480952 BWP M-4000L Euclid E-9653 Haldex CS41150	Leland L-3417 Meritor 2210U7457 Spicer 18-509
C653L		REPLACED BY C654R					
	C654R	REPLACED BY C654R			Camshaft Kits B8707 B8771 B8745 (Mack)	Automann 122.280914.06 Batco 04-480951 BWP M-4000R Euclid E-9654 Haldex CS41151	Leland L-3416 Meritor 2210T7456 Spicer 18-508
		REPLACED BY C654L					
		10-3/16"	---	---	"Q-Plus"	Automann 122.281006.01 Batco 04-481032 BWP M-4084L Euclid E-5504A Haldex CS40176	Leland L-3091 Meritor 2210J6822 Spicer 2210U7483 18-931
C504L		REPLACED BY C505R					
	C505R	REPLACED BY C505R			Camshaft Kits B8707 B8771 B8745 (Mack)	Automann 122.281006.02 Batco 04-481031 BWP M-4084R Euclid E-5505A Haldex CS40177	Leland L-3090 Meritor 2210H6820 2210T7482 Spicer 18-930
		REPLACED BY C504L					

BRAKE CAMSHAFTS - DRIVE AXLE

Meritor "Q" And "Q-Plus"

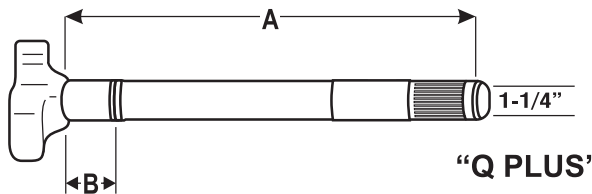

1-1/2" Dia. - 28 Spline

"A" Dimension: under head to beginning of lock ring groove

LH	RH	A	B	C	NOTES	REPLACES	
					"Q"	Automann 122.281013.01 Batco 04-461052 BWP M-3179L Euclid E-3347 Leland L-2873	Meritor 2210F5362 Spicer 18-827
C347L		REPLACED BY C655L					
		10-13/32"	---	---	Camshaft Kits B8707 B8771 B8745 (Mack)	Automann 122.281013.02 Batco 04-461051 BWP M-3179R Euclid E-3348 Leland L-2872	Meritor 2210E5361 Spicer 18-826
	C348R	REPLACED BY C656R					
C655L		10-13/32"	---	---	"Q-Plus"	Automann 122.281013.03 Batco 04-481042 BWP M-4001L Euclid E-9655 Haldex CS40178	Leland L-3093 Meritor 2210E7493 Spicer 18-511
	C656R					Automann 122.281013.04 Batco 04-481041 BWP M-4001R Euclid E-9656 Haldex CS40179	Leland L-3092 Meritor 2210D7492 Spicer 18-510
C541L		10-19/32"	---	---	"Q-Plus"	Batco 04-481052 Euclid E-11541 Meritor 2210L7500	
	C540R					Batco 04-481051 Euclid E-11540 Meritor 2210K7499	
					"Q"	Automann 122.281030.01 Batco 04-461102 BWP M-2612L Euclid E-4727 Haldex CS41558	Leland L-2877 Meritor 2210Z5434 Spicer 18-829
C727L		10-7/8"	---	---			
					Camshaft Kits B8707 B8771 B8745 (Mack)	Automann 122.281030.02 Batco 04-461101 BWP M-2612R Euclid E-4726 Haldex CS41559	Leland L-2876 Meritor 2210Y5433 Spicer 18-828
	C726R	REPLACED BY C658R					
C657L		10-7/8"	---	---	"Q-Plus"	Automann 122.281030.03 Batco 04-481112 BWP M-4002L Euclid E-9657 Haldex CS41160	Leland L-3415 Meritor 2210A7515 Spicer 18-515
	C658R					Automann 122.281030.04 Batco 04-481111 BWP M-4002R Euclid E-9658 Haldex CS41161	Leland L-3414 Meritor 2210Z7514 Spicer 18-514

BRAKE CAMSHAFTS - DRIVE AXLE

Meritor "Q" And "Q-Plus"

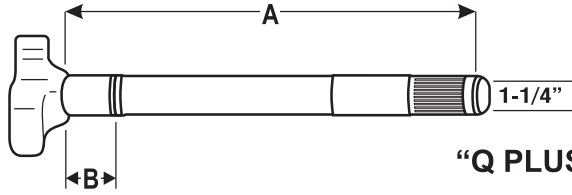

1-1/2" Dia. - 28 Spline

"A" Dimension: under head to beginning of lock ring groove

LH	RH	A	B	C	NOTES	REPLACES	
					"Q"	Automann 122.281107.01 Batco 04-461122 BWP M-2613L Euclid E-3349 Haldex CS41560	Leland L-2341 Meritor 2210V5326 Spicer 18-831
C349L		REPLACED BY C524L					
		11-7/32"	---	---	Camshaft Kits B8707 B8771 B8745 (Mack)	Automann 122.281107.02 Batco 04-461121 BWP M-2613R Euclid E-3350 Haldex CS41561	Leland L-2340 Meritor 2210U5325 Spicer 18-830
	C350R	REPLACED BY C522R					
C524L		11-1/8"	---	---	"Q-Plus"	Automann 122.281104.03 Batco 04-481122 BWP M-3111L Euclid E-9659 Haldex CS40182	Leland L-3097 Meritor 2210J7524 Spicer 18-517
	C522R					Automann 122.281104.04 Batco 04-481121 BWP M-3111R Euclid E-9660 Haldex CS40183	Leland L-3096 Meritor 2210H7522 Spicer 18-516
C351L					"Q"	Automann 122.281118.01 Batco 04-461152 BWP M-2614L Euclid E-3351 Haldex CS41562	Leland L-2339 Meritor 2210B5332 Spicer 18-833
		REPLACED BY C537L					
		11-9/16"	---	---	Camshaft Kits B8707 B8771 B8745 (Mack)	Automann 122.281118.02 Batco 04-461151 BWP M-2614R Euclid E-3352 Haldex CS41563	Leland L-2338 Meritor 2210A5331 Spicer 18-832
	C352R	REPLACED BY C536R					
C537L		11-9/16"	---	---	"Q-Plus"	Automann 122.281118.03 Batco 04-481152 BWP M-3112L Euclid E-9661 Haldex CS40184	Leland L-3099 Meritor 2210W7537 Spicer 18-519
	C536R					Automann 122.281118.04 Batco 04-481151 BWP M-3112R Euclid E-9662 Haldex CS40185	Leland L-3098 Meritor 2210V7536 Spicer 18-518
C882L					"Q"	Automann 122.281122.01 Batco 04-461162 BWP M-4026L Euclid E-6882 Haldex CS40152	Leland L-3035 Meritor 2210H5416 Spicer 18-867
		REPLACED BY C663L					
		11-11/16"	---	---	Camshaft Kits B8707 B8771 B8745 (Mack)	Automann 122.281122.02 Batco 04-461161 BWP M-4026R Euclid E-6883 Haldex CS40153	Leland L-3034 Meritor 2210G5415 Spicer 18-866
	C883R	REPLACED BY C664R					

BRAKE CAMSHAFTS - DRIVE AXLE

Meritor "Q" And "Q-Plus"

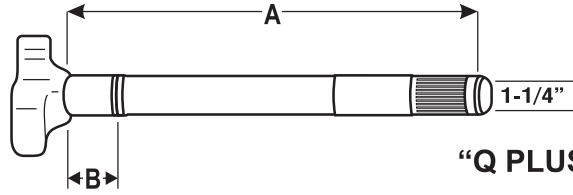

1-1/2" Dia. - 28 Spline

"A" Dimension: under head to beginning of lock ring groove

LH	RH	A	B	C	NOTES	REPLACES
C663L		11-11/16"	---	---	"Q-Plus"	Automann 122.281122.03 Batco 04-481172 BWP M-4003L Euclid E-9663 Haldex CS41152 Leland L-3575 Meritor 2210C7543 Spicer 18-521
	C664R				Camshaft Kits B8707 B8771 B8745 (Mack)	Automann 122.281122.04 Batco 04-481171 BWP M-4003R Euclid E-9664 Haldex CS41153 Leland L-3574 Meritor 2210B7542 Spicer 18-520
C665L		11-15/16"	---	---	"Q-Plus"	Automann 122.281130.01 Batco 04-481212 BWP M-3113L Euclid E-9665 Leland L-3419 Meritor 2210L7552 Spicer 18-523
	C666R				Camshaft Kits B8707 B8771 B8745 (Mack)	Automann 122.281130.02 Batco 04-481211 BWP M-3113R Euclid E-9666 Leland L-3418 Meritor 2210K7551 Spicer 18-522
C894L		REPLACED BY C667L			"Q"	Automann 122.281214.01 Batco 04-461252 BWP M-2606L Euclid E-4894 Haldex CS41564 Leland L-2881 Meritor 2210X5328 Spicer 18-869
		12-7/16"	---	---	Camshaft Kits B8707 B8771 B8745 (Mack)	Automann 122.281214.02 Batco 04-461251 BWP M-2606R Euclid E-4895 Haldex CS41565 Leland L-2880 Meritor 2210W5327 Spicer 18-868
	C895R	REPLACED BY C668R				
C667L		12-7/16"	---	---	"Q-Plus"	Automann 122.281214.03 Batco 04-481252 BWP M-4004L Euclid E-9667 Haldex CS41154 Leland L-3483 Meritor 2210C7569 Spicer 18-525
	C668R				Camshaft Kits B8707 B8771 B8745 (Mack)	Automann 122.281214.04 Batco 04-481251 BWP M-4004R Euclid E-9668 Haldex CS41155 Leland L-3482 Meritor 2210B7568 Spicer 18-524
C729L		REPLACED BY C669L			"Q"	Automann 122.281230.01 Batco 04-461312 BWP M-2607L Euclid E-4729L Haldex CS41566 Leland L-2883 Meritor 2210L5342 Spicer 18-837
		12-15/16"	---	---	Camshaft Kits B8707 B8771 B8745 (Mack)	Automann 122.281230.02 Batco 04-461311 BWP M-2607R Euclid E-4728R Haldex CS41567 Leland L-2882 Meritor 2210K5341 Spicer 18-836
	C728R	REPLACED BY C670R				

BRAKE CAMSHAFTS - DRIVE AXLE

Meritor "Q" And "Q-Plus"

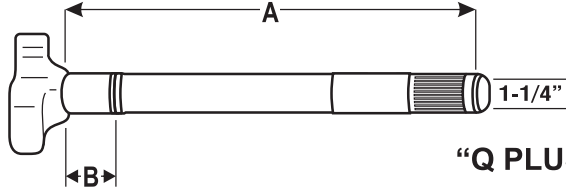

1-1/2" Dia. - 28 Spline

"A" Dimension: under head to beginning of lock ring groove

LH	RH	A	B	C	NOTES	REPLACES
C669L		12-15/16"	---	---	"Q-Plus" Automann 122.281230.03 Batco 04-481312 BWP M-4005L Euclid E-9669 Haldex CS41156	Leland L-3403 Meritor 2210U7587 Spicer 18-527
	C670R				Camshaft Kits B8707 B8771 B8745 (Mack) Automann 122.281230.04 Batco 04-481311 BWP M-4005R Euclid E-9670 Haldex CS41157	Leland L-3402 Meritor 2210T7586 Spicer 18-526
C731L		REPLACED BY C595L			"Q" Automann 122.281307.01 Batco 04-461332 BWP M-2597L Euclid E-4731 Haldex CS41568	Leland L-2885 Meritor 2210D5334 Spicer 18-821
		13-7/32"	---	---		
	C730R	REPLACED BY C594R			Camshaft Kits B8707 B8771 B8745 (Mack) Automann 122.281307.02 Batco 04-461331 BWP M-2597R Euclid E-4730 Haldex CS41569	Leland L-2884 Meritor 2210C5333 Spicer 18-820
C595L		13-7/32"	---	---	"Q-Plus" Automann 122.281307.03 Batco 04-481332 BWP M-3114L Euclid E-9671 Haldex CS40186	Leland L-3101 Meritor 2210C7595 Spicer 18-529
	C594R				Camshaft Kits B8707 B8771 B8745 (Mack) Automann 122.281307.04 Batco 04-481331 BWP M-3114R Euclid E-9672 Haldex CS40187	Leland L-3100 Meritor 2210B7594 Spicer 18-528
C733L		REPLACED BY C733AL			"Q" Automann 122.281314.01 Batco 04-461352 BWP M-2598L Euclid E-4733 Haldex CS41770	Leland L-2889 Meritor 2210N5396 Spicer 18-823
		13-7/16"	---	---		
	C732R	REPLACED BY C732AR			Camshaft Kits B8707 B8771 B8745 (Mack) Automann 122.281314.02 Batco 04-461351 BWP M-2598R Euclid E-4732 Haldex CS41771	Leland L-2888 Meritor 2210M5395 Spicer 18-822
C733AL		13-7/16"	---	---	"Q-Plus" Automann 122.281314.03 Batco 04-481352 Euclid E-4733A Haldex CS40188 Leland L-3105	Meritor 2210L7838
	C732AR				Camshaft Kits B8707 B8771 B8745 (Mack) Automann 122.281314.04 Batco 04-481351 Euclid E-4732A Haldex CS40189 Leland L-3104	Meritor 2210K7837

BRAKE CAMSHAFTS - DRIVE AXLE

Meritor "Q" And "Q-Plus"

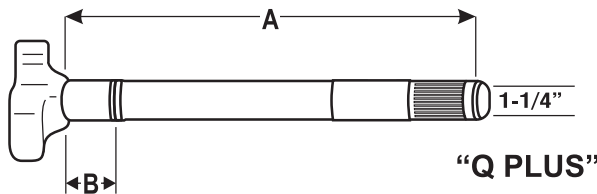

1-1/2" Dia. - 28 Spline

"A" Dimension: under head to beginning of lock ring groove

LH	RH	A	B	C	NOTES	REPLACES	
C569L		13-19/32"	---	---	"Q-Plus"	BWP M-4006L Euclid E-11569 Meritor 2210Q7609	
	C568R				Camshaft Kits B8707 B8771 B8745 (Mack)	BWP M-4006R Euclid E-11568 Meritor 2210P7608	
C735L		REPLACED BY C675L			"Q"	Automann 122.281403.01 Batco 04-461422 BWP M-2599L Euclid E-4735 Haldex CS41772	Leland L-2343 Meritor 2210N5370 Spicer 18-835
	C734R	14-3/32"	---	---		Camshaft Kits B8707 B8771 B8745 (Mack)	Automann 122.281403.02 Batco 04-461421 BWP M-2599R Euclid E-4734 Haldex CS41773
C675L		14-3/32"	---	---	"Q-Plus"	Automann 122.281403.03 Batco 04-481422 BWP M-3683L Euclid E-9675 Haldex CS40192	Leland L-3107 Meritor 2210J7628 Spicer 18-535
	C676R					Camshaft Kits B8707 B8771 B8745 (Mack)	Automann 122.281403.04 Batco 04-481421 BWP M-3683R Euclid E-9676 Haldex CS40193
C085L		REPLACED BY C677L			"Q"	Automann 122.281419.01 Batco 04-461462 BWP M-3115L Euclid E-9081 Haldex CS40160	Leland L-2891 Meritor 2210L5446 Spicer 18-781
	C086R	14-19/32"	---	---		Camshaft Kits B8707 B8771 B8745 (Mack)	Automann 122.281419.02 Batco 04-461461 BWP M-3115R Euclid E-9082 Haldex CS40161
C677L		14-19/32"	---	---	"Q-Plus"	Automann 122.281419.03 Batco 04-481462 BWP M-4007L Euclid E-9677 Haldex CS40196	Leland L-3339 Meritor 2210A7645 Spicer 18-537
	C678R					Camshaft Kits B8707 B8771 B8745 (Mack)	Automann 122.281419.04 Batco 04-481461 BWP M-4007R Euclid E-9678 Haldex CS40197

BRAKE CAMSHAFTS - DRIVE AXLE

Meritor "Q" And "Q-Plus"

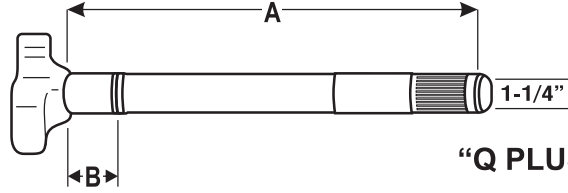

1-1/2" Dia. - 28 Spline

"A" Dimension: under head to beginning of lock ring groove

LH	RH	A	B	C	NOTES	REPLACES
C679L		14-3/4"	---	---	"Q-Plus"	Automann 122.281424.01 Batco 04-481472 BWP M-3684L Euclid E-9679 Haldex CS40194 Leland L-3109 Meritor 2210J7654 Spicer 18-539
	C680R				Camshaft Kits B8707 B8771 B8745 (Mack)	Automann 122.281424.02 Batco 04-481471 BWP M-3684R Euclid E-9680 Haldex CS40195 Leland L-3108 Meritor 2210H7652 Spicer 18-538
C083L		REPLACED BY C681L			"Q"	Automann 122.281506.01 Batco 04-461532 BWP M-3116L Euclid E-9083 Haldex CS40164 Leland L-3335 Meritor 2210L5784 Spicer 18-713
	C084R	15-3/16"	---	---	Camshaft Kits B8707 B8771 B8745 (Mack)	Automann 122.281506.02 Batco 04-461531 BWP M-3116R Euclid E-9084 Haldex CS40165 Leland L-3334 Meritor 2210K5783 Spicer 18-712
C681L		15-3/16"	---	---	"Q-Plus"	Automann 122.281506.03 Batco 04-481532 BWP M-3685L Euclid E-9681 Haldex CS40198 Leland L-3111 Meritor 2210A7671 Spicer 18-541
	C682R				Camshaft Kits B8707 B8771 B8745 (Mack)	Automann 122.281506.04 Batco 04-481531 BWP M-3685R Euclid E-9682 Haldex CS40199 Leland L-3110 Meritor 2210Z7670 Spicer 18-540
C306L		15-19/32"	---	---	"Q-Plus"	Batco 04-481562 Euclid E-10306A Haldex CS40200 Meritor 2210N7684
	C307R				Camshaft Kits B8707 B8771 B8745 (Mack)	Batco 04-481561 Euclid E-10307A Haldex CS40201 Meritor 2210M7683
C185L		REPLACED BY C683L			"Q"	Batco 04-461572 BWP M-3117L Euclid E-9085 Leland L-3331 Meritor 2210L5394
	C186R	15-23/32"	---	---	Camshaft Kit B8707	Batco 04-461571 BWP M-3117R Euclid E-9086 Leland L-3330 Meritor 2210K5393

BRAKE CAMSHAFTS - DRIVE AXLE

Meritor "Q" And "Q-Plus"

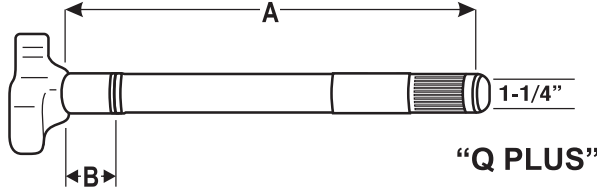

1-1/2" Dia. - 28 Spline

"A" Dimension: under head to beginning of lock ring groove

LH	RH	A	B	C	NOTES	REPLACES	
C683L		15-23/32"	---	---	"Q-Plus"	Automann 122.281523.03 Batco 04-481572 BWP M-4008L Euclid E-9683 Leland L-3507	Meritor 2210S7689 Spicer 18-543
					Camshaft Kits B8707 B8771 B8745 (Mack)	Automann 122.281523.04 Batco 04-481571 BWP M-4008R Euclid E-9684 Leland L-3506	Meritor 2210R7688 Spicer 18-542
C585L		15-13/16"	---	---	"Q-Plus"	Batco 04-481602 Euclid E-11585 Haldex CS40202 Meritor 2210W7693	
					Camshaft Kits B8707 B8771 B8745 (Mack)	Batco 04-481601 Euclid E-11584 Haldex CS40203 Meritor 2210V7692	
	C684R						

BRAKE CAMSHAFTS - TRAILER

Hendrickson Intraax

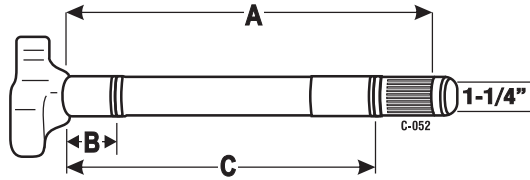

1-1/2" Dia. - 10 Spline
1-1/2" Dia. - 28 Spline

"A" Dimension: under head to beginning of lock ring groove

LH	RH	A	B	C	NOTES	REPLACES	
C607L		11-1/16"	2-5/16"	8-11/16"	"ES" 1-1/2" Dia. 10 Spline 1-1/8" Head	Automann 125.101100.01 Batco 04-851122 BWP M-4031L Euclid E-11864 Hendrickson S-23857-1L	Meritor R607323
	C606R				Camshaft Kit B8790 B8805	Automann 125.101100.02 Batco 04-851121 BWP M-4031R Euclid E-11865 Hendrickson S-23857-1R	Meritor R607324
C609L		11-1/16"	2-5/16"	8-11/16"	"ES" 1-1/2" Dia. 28 Spline 1-1/8" Head	Automann 125.281102.01 Batco 04-871122 BWP M-4009L Euclid E-11866 Haldex CS41764	Hendrickson S-24636-1L Leland L-3445 Meritor R607325 Spicer
	C608R				Camshaft Kit B8794 B8805	Automann 125.281102.02 Batco 04-871121 BWP M-4009R Euclid E-11867 Haldex CS41765	Hendrickson S-24636-1R Leland L-3444 Meritor R607326 Spicer
C601L		11-1/8"	2-5/16"	---	1-1/2" Dia. 10 Spline 1-3/8" Head	Hendrickson S-21717-1L	
	C600R				Camshaft Kit B8790 B8805	Hendrickson S-21717-1R	
C603L		11-1/8"	2-5/16"	---	1-1/2" Dia. 28 Spline 1-3/8" Head	Automann 125.281104.01 Batco 04-861122 BWP M-3798L Euclid E-10899 Haldex CS41174	Hendrickson S-20806-1L Meritor R607267 Spicer 17-11055
	C602R				Camshaft Kit B8790 B8805	Automann 125.281104.02 Batco 04-861121 BWP M-3798R Euclid E-10900 Haldex CS41175	Hendrickson S-20806-1R Meritor R607268 Spicer 17-11056
C605L		11-1/8"	2-5/16"	---	"ES" 1-1/2" Dia. 28 Spline 1-1/8" Head	Automann 125.281102.01 Batco 04-871122 BWP M-3799L Euclid E-11433 Hendrickson S-23347-1L	
	C604R				Camshaft Kit B8790 B8805	Automann 125.281102.02 Batco 04-871121 BWP M-3799R Euclid E-11434 Hendrickson S-23347-1R	

BRAKE CAMSHAFTS - TRAILER

Multiple Applications

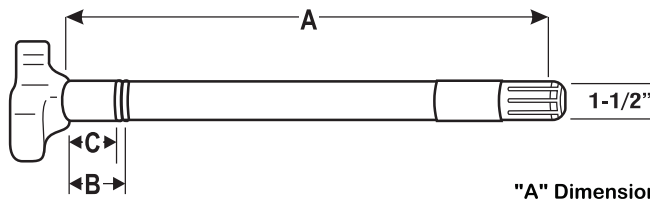

1-1/2" Dia. - 10 Spline

"A" Dimension: under head to beginning of lock ring groove

LH	RH	A	B	C	NOTES	REPLACES	
C687L		16-1/2"	2-7/32"	---	Eaton B1691-47/8	Automann 124.101616.01 Batco 04-571652 BWP M-561L Euclid E-687 Haldex CS41264	Leland L-235 Spicer 17-577 M16WK103-9
	C686R					Automann 124.101616.02 Batco 04-571651 BWP M-561R Euclid E-686 Haldex CS41265	Leland L-234 Spicer 17-576 M16WK102-9
C795L		17-3/8"	2-7/32"	---	Std Forge 202100-175L/R	Automann 124.101712.01 Batco 04-571742 BWP M-1015L Euclid E-2795 Haldex CS41266	Leland L-2441 Meritor R607032 Spicer 17-569 M16WK117
	C794R					Automann 124.101712.02 Batco 04-571741 BWP M-1015R Euclid E-2794 Haldex CS41267	Leland L-2440 Meritor R607031 Spicer 17-568 M16WK116
C691L		18-3/8"	2-3/16"	---	"Q-Plus"	Batco 04-571842 BWP M-4090L Euclid E-689A Meritor R607064 Spicer 17-567	
	C690R					Batco 04-571841 BWP M-4090R Euclid E-688A Meritor R607063 Spicer 17-566	
C425L		20-3/8"	2-7/32"	1-5/8"	Double-Grooved	Automann 124.102014.01 Batco 04-572042 BWP M-562L Euclid E-1425 Leland L-174	Meritor 2210F5414 Spicer 17-581 M16WK103-17
	C424R					REPLACED BY C425AL	REPLACED BY C424AR
C425AL		20-3/8"	2-7/32"	1-5/8"	Double-Grooved	Batco 04-572042 BWP M-4025L Euclid E-1425A Haldex CS41506 Meritor R607082	
	C424AR					Batco 04-572041 BWP M-4025R Euclid E-1424A Haldex CS41507 Meritor R607081	
					"Q-Plus"		

BRAKE CAMSHAFTS - TRAILER

Multiple Applications

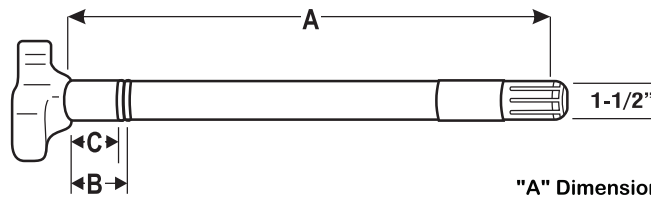

1-1/2" Dia. - 10 Spline

"A" Dimension: under head to beginning of lock ring groove

LH	RH	A	B	C	NOTES	REPLACES	
C688L		21-3/32"	2-7/32"	---	Eaton B11691-17/8	Automann 124.102103.01	Leland L-225
	Batco 04-572112					Meritor 2210A6319	
	BWP M-567L	Spicer 17-583					
	Euclid E-685	M16WK103-19					
	C689R					Haldex CS41514	
						Automann 124.102103.02	Leland L-224
						Batco 04-572111	Meritor 2210Z6318
						BWP M-567R	Spicer 17-582
						Euclid E-684	M16WK102-19
						Haldex CS41515	
C089L		22-3/8"	2-7/32"	---	Std Forge 202100-225L/R	Automann 122.102212.01	Leland L-2357
	Batco 04-572242					Meritor 2210J2948	
	BWP M-4091L	Spicer 17-585					
	Euclid E-9089						
	C090R					Haldex CS41518	
						Automann 122.102212.02	Leland L-2356
						Batco 04-572241	Meritor 2210H2946
						BWP M-4091R	Spicer 17-584
						Euclid E-9090	
						Haldex CS41519	
C884L		22-7/8"	2-7/32"	---	Dana 16408/7	Automann 124.102228.01	Leland L-2949
	Batco 04-572302					Meritor 2210A6345	
	BWP M-3173L	Spicer 17-595					
	Euclid E-4884	M16WK102-23					
	C885R					Haldex CS41542	
						Automann 124.102228.02	Leland L-2948
						Batco 04-572301	Meritor 2210Z6344
						BWP M-3173R	Spicer 17-594
						Euclid E-4885	M16WK103-23
						Haldex CS41543	
C095L		23-7/16"	2-7/32"	1-5/8"	Double-Grooved Eaton B1691-25/6	Automann 124.102314.01	Leland L-580
	Batco 04-572352					Meritor R607002	
	BWP M-744L	Spicer 17-575					
	Euclid E-1095	M16WK103-25					
	C094R					Haldex CS41522	
						Automann 124.102314.02	Leland L-581
						Batco 04-572351	Meritor R607001
						BWP M-744R	Spicer 17-574
						Euclid E-1094	M16WK102-25
						Haldex CS41523	
C717L		24"	2-7/32"	1-5/8"	Double-Grooved Dana 16396/5	Automann 124.102400.01	Leland L-903
	Batco 04-572412					Meritor R607042	
	BWP M-746L	Spicer 17-587					
	Euclid E-4717	M16WK103-26					
	C716R					Haldex CS41524	
						Automann 124.102400.02	Leland L-902
						Batco 04-572411	Meritor R607041
						BWP M-746R	Spicer 17-586
						Euclid E-4716	M16WK102-26
						Haldex CS41525	

BRAKE CAMSHAFTS - TRAILER

Multiple Applications

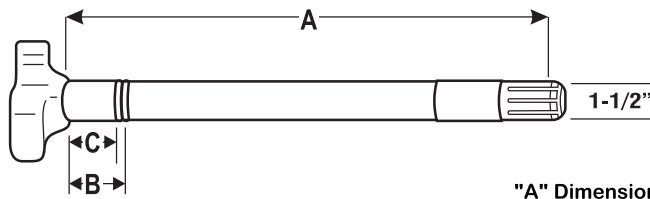

1-1/2" Dia. - 10 Spline

"A" Dimension: under head to beginning of lock ring groove

LH	RH	A	B	C	NOTES	REPLACES	
C797L		24-3/8"	2-7/32"	1-5/8"	Double-Grooved	Automann 124.102412.01	Leland L-2090
						Batco 04-572442	Meritor R607034
	C796R				Std Forge 202100-245L/R	BWP M-2601L	Spicer 17-589
						Euclid E-2797	M16WK102-83
						Haldex CS41754	
						Automann 124.102412.02	Leland L-2089
						Batco 04-572441	Meritor R607033
						BWP M-2601R	Spicer 17-588
						Euclid E-2796	M16WK103-83
						Haldex CS41755	
C719L		25-3/4"	2-7/32"	---	Eaton B1691-60/9 820087/8	Automann 122.102524.01	Meritor R607044
						Batco 04-572572	Spicer 17-597
						BWP M-3183L	M16WK102-88
						Euclid E-4719	
						Haldex CS41756	
						Automann 122.102524.02	Meritor R607043
						Batco 04-572571	Spicer 17-596
						BWP M-3183R	M16WK103-88
						Euclid E-4718	
						Haldex CS41757	

BRAKE CAMSHAFTS - TRAILER

Eaton "501"

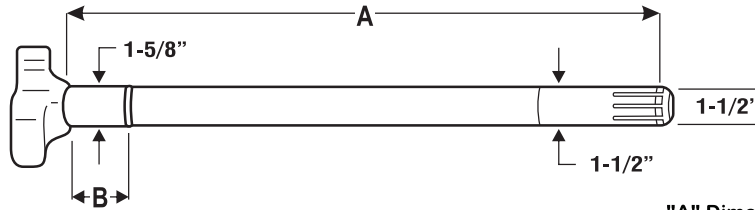

1-1/2" Dia. - 10 Spline

"A" Dimension: under head to beginning of lock ring groove

LH	RH	A	B	C	NOTES	REPLACES	
C693L		19-1/2"	2-7/32"	---	Camshaft Kit B8684	Automann 120.101916.01 Batco 04-711952 BWP M-2600L Eaton 807286 Euclid E-2693	Haldex CS41292 Leland L-1618 Meritor R607026 Spicer 17-635
	C694R					Automann 120.101916.02 Batco 04-711951 BWP M-2600R Eaton 807287 Euclid E-2694	Haldex CS41293 Leland L-1617 Meritor R607025 Spicer 17-634
C721L		23-3/4"	2-7/32"	---	Camshaft Kit B8684	Automann 120.102324.01 Batco 04-712372 BWP M-2604L Eaton 807304 Euclid E-4721	Haldex CS41544 Leland L-2467 Meritor R607046 Spicer 17-637
	C720R					Automann 120.102324.02 Batco 04-712371 BWP M-2604R Eaton 807305 Euclid E-4720	Haldex CS41545 Leland L-2466 Meritor R607045 Spicer 17-636

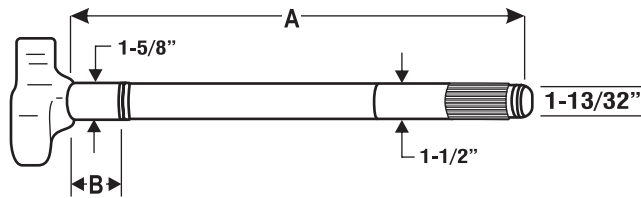

1-1/2" Dia. - 28 Spline

"A" Dimension: under head to beginning of lock ring groove

LH	RH	A	B	C	NOTES	REPLACES	
C723L		20-7/32"	2-13/32"	---	Camshaft Kit B8684	Automann 120.282007.01 Batco 04-722022 BWP M-3174L Eaton 125042 Euclid E-4723	Haldex CS41549 Leland L-3027 Meritor R607048 Spicer 17-639
	C722R					Automann 120.282007.02 Batco 04-722021 BWP M-3174R Eaton 125043 Euclid E-4722	Haldex CS41548 Leland L-3026 Meritor R607047 Spicer 17-638

BRAKE CAMSHAFTS - TRAILER

Eaton 16-1/2" "ES" Brakes

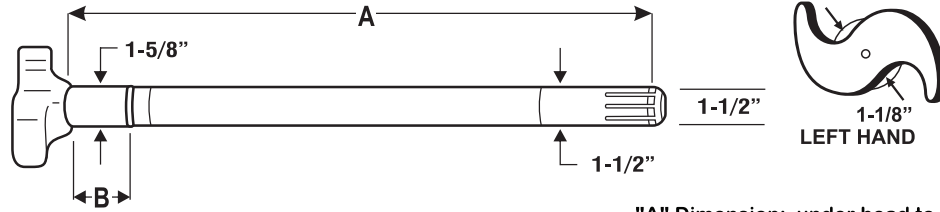

1-1/2" Dia. - 10 Spline

"A" Dimension: under head to beginning of lock ring groove

LH	RH	A	B	C	NOTES	REPLACES	
C494L		19-1/2"	2-5/32"	---	"ES"	Automann 120.101916.03 Batco 04-731942 BWP M-3143L Eaton 808078 Euclid E-5494	Haldex CS41476 Leland L-2967 Meritor R607109 Spicer 17-461
	C495R				Camshaft Kit B8684	Automann 120.101916.04 Batco 04-731941 BWP M-3143R Eaton 808079 Euclid E-5495	Haldex CS41477 Leland L-2966 Meritor R607110 Spicer 17-460
C496L		23-3/4"	2-5/32"	---	"ES"	Automann 120.102324.03 Batco 04-732362 BWP M-3144L Eaton 806654 Euclid E-5496	Haldex CS41478 Leland L-2969 Meritor R607107 Spicer 17-463
	C497R				Camshaft Kit B8684	Automann 120.102324.04 Batco 04-732361 BWP M-3144R Eaton 806655 Euclid E-5497	Haldex CS41479 Leland L-2968 Meritor R607108 Spicer 17-462

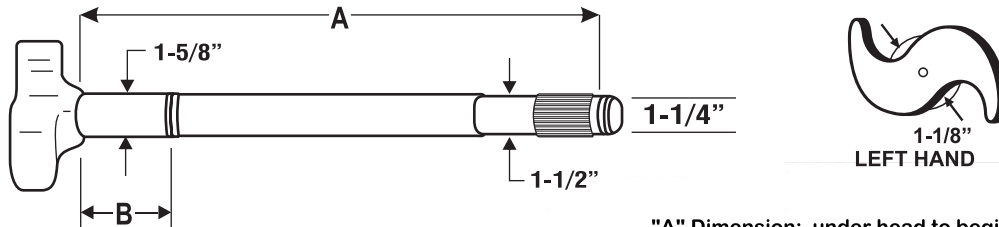

1-1/2" Dia. - 28 Spline

"A" Dimension: under head to beginning of lock ring groove

LH	RH	A	B	C	NOTES	REPLACES	
C057L		19-1/2"	2-5/32"	---	"ES"	Automann 120.281916.01 Batco 04-741942 BWP M-3130L Eaton 810538 Euclid E-9057	Haldex CS41480 Leland L-3201 Meritor R607115
	C058R				Camshaft Kit B8684	Automann 120.281916.02 Batco 04-741941 BWP M-3130R Eaton 810539 Euclid E-9058	Haldex CS41481 Leland L-3200 Meritor R607116
C059L		23-3/4"	2-7/32"	---	"ES"	Automann 120.282324.01 Batco 04-742362 BWP M-3131L Eaton 810025 Euclid E-9059	Haldex CS41482 Leland L-3203 Meritor R607113 Spicer 17-473
	C060R				Camshaft Kit B8684	Automann 120.282324.02 Batco 04-742361 BWP M-3131R Eaton 810026 Euclid E-9060	Haldex CS41483 Leland L-3202 Meritor R607114 Spicer 17-472

BRAKE CAMSHAFTS - TRAILER

Fruehauf "Propar" 16-1/2" Brakes

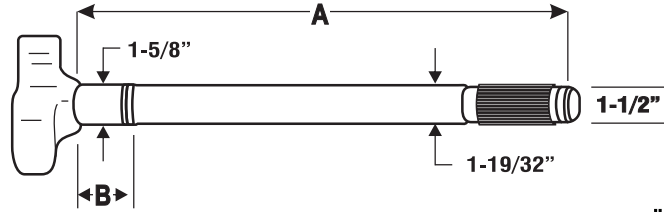

1-5/8" Dia. - 37 Spline

"A" Dimension: under head to beginning of lock ring groove

LH	RH	A	B	C	NOTES	REPLACES	
C563L		16-1/8"	2-5/32"	---	Camshaft Kits B8649 B8650	Automann 121.371604.01 Batco 04-811622 BWP M-563L Euclid E-1563 Fruehauf AXA0420-1	Haldex CS41528 Leland L-838 Meritor R607011 Spicer 17-621
	C564R					Automann 121.371604.02 Batco 04-811621 BWP M-563R Euclid E-1564 Fruehauf AXA0420-2	Haldex CS41529 Leland L-839 Meritor R607012 Spicer 17-620
C101L		21-1/8"	2-5/32"	---	Camshaft Kits B8649 B8650	Automann 121.372104.01 Batco 04-812122 BWP M-566L Euclid E-2099 Fruehauf AXA0420-3	Haldex CS41512 Leland L-1024 Meritor R607020 Spicer 17-623
	C100R					Automann 121.372104.02 Batco 04-812121 BWP M-566R Euclid E-2100 Fruehauf AXA0420-4	Haldex CS41513 Leland L-1023 Meritor R607019 Spicer 17-622
C861L		23-7/8"	2-7/32"	---	Camshaft Kits B8649 B8650	Automann 121.372328.01 Batco 04-812402 BWP M-3180L Euclid E-3861 Fruehauf AXA0420-6	Haldex CS41492 Leland L-3319 Meritor R607162 Spicer 17-617
	C862R					Automann 121.372328.02 Batco 04-812401 BWP M-3180R Euclid E-3862 Fruehauf AXA0420-5	Haldex CS41493 Leland L-3318 Meritor R607161 Spicer 17-616

BRAKE CAMSHAFTS - TRAILER

Meritor 4000 - 6000

Double-Grooved

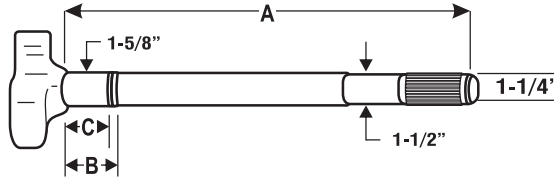

1-1/2" Dia. - 10 Spline
1-1/2" Dia. - 28 Spline

"A" Dimension: under head to beginning of lock ring groove

LH	RH	A	B	C	NOTES	REPLACES	
					10 - Spline	Automann 122.101710.01 Batco 04-881732 BWP M-993L Euclid E-2447 Haldex CS41276	Leland L-1652 Meritor 2210S4179 Spicer 17-641
C447L		REPLACED BY C447AL			"Q"		
		17-5/16"	2-5/64"	1-25/32"	Double-Grooved		
					Camshaft Kits	Automann 122.101710.02 Batco 04-881731 BWP M-993R Euclid E-2448 Haldex CS41277	Leland L-1651 Meritor 2210R4178 Spicer 17-640
	C448R	REPLACED BY C448AR			B8683 B8747		
C447AL		17-5/16"	2-5/64"	1-25/32"	10 - Spline	Automann 122.101710.03 BWP M-4092L Euclid E-2447A Meritor R607066	
					"Q-Plus"		
					Double-Grooved	Automann 122.101710.04 BWP M-4092R Euclid E-2448A Meritor R607065	
	C448AR	REPLACED BY C448AL			Camshaft Kits		
					B8683 B8747		
C441L					28 - Spline	Automann 122.281710.01 Batco 04-891732 BWP M-990L Euclid E-2441A Haldex CS41504	Leland L-1299 Meritor 2210M4329 Spicer 17-627
		REPLACED BY C441BL			"Q"		
		17-5/16"	2-5/64"	1-25/32"	Double-Grooved	Automann 122.281710.02 Batco 04-891731 BWP M-990R Euclid E-2442A Haldex CS41505	Leland L-1298 Meritor 2210L4328 Spicer 17-626
					Camshaft Kits		
	C442R	REPLACED BY C442BR			B8683 B8747		
C441BL		17-5/16"	2-5/64"	1-25/32"	28 - Spline	Automann 122.281710.03 Batco 04-931732 BWP M-3170L M-4010L Euclid E-2441B/E-5506	Haldex CS41110 Leland L-3113 Meritor 2210C6867 2210R8156 Spicer 17-721
					"Q-Plus"	Automann 122.281710.04 Batco 04-931731 BWP M-3170R M-4010R Euclid E-2442B/E-5507	Haldex CS41111 Leland L-3112 Meritor 2210B6866 2210Q8155 Spicer 17-720
					Double-Grooved		
	C442BR	REPLACED BY C442BL			Camshaft Kits		
					B8683 B8747		
C449L					10 - Spline	Automann 122.102013.01 Batco 04-882042 BWP M-994L Euclid E-2449 Haldex CS41532	Leland L-1656 Meritor 2210W4183 Spicer 17-633
		REPLACED BY C449AL			"Q"		
		20-13/32"	2-5/64"	1-25/32"	Double-Grooved	Automann 122.102013.02 Batco 04-882041 BWP M-994R Euclid E-2450 Haldex CS41533	Leland L-1655 Meritor 2210V4182 Spicer 17-632
					Camshaft Kits		
	C450R	REPLACED BY C450AR			B8683 B8747		

BRAKE CAMSHAFTS - TRAILER

Meritor 4000 - 6000

Double-Grooved



1-1/8"
LEFT HAND
"Q PLUS"

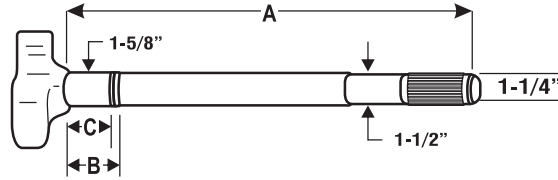

1-3/8"
LEFT HAND

1-1/2" Dia. - 10 Spline
1-1/2" Dia. - 28 Spline

"A" Dimension: under head to beginning
of lock ring groove

LH	RH	A	B	C	NOTES	REPLACES			
C449AL		20-13/32"	2-5/64"	1-25/32"	10 - Spline "Q-Plus"	Automann	122.102013.03		
					BWP	M-4093L			
					Double-Grooved	Euclid	E-2449A		
						Meritor	R607070		
	C450AR				Camshaft Kits	Automann	122.102013.04		
					B8683	BWP	M-4093R		
					B8747	Euclid	E-2450A		
						Meritor	R607069		
C443L		REPLACED BY C443BL			28 - Spline	Automann	122.282013.01	Leland	L-1477
					"Q"	Batco	04-892042	Meritor	2210R4334
		20-13/32"	2-5/64"	1-25/32"	Double-Grooved	BWP	M-991L	Spicer	17-629
						Euclid	E-2443A		
						Haldex	CS41526		
	C444R	REPLACED BY C444BR			Camshaft Kits	Automann	122.282013.02	Leland	L-1476
					B8683	Batco	04-892041	Meritor	2210Q4333
					B8747	BWP	M-991R	Spicer	17-628
						Euclid	E-2444A		
						Haldex	CS41527		
C443BL		20-13/32"	2-5/64"	1-25/32"	28 - Spline	Automann	122.282013.03	Haldex	CS41112
							"Q-Plus"	Batco	04-932042
					Double-Grooved	BWP	M-3171L	Meritor	2210G6871
						M-4011L			2210T8158
						Euclid	E-2443B/E-5508	Spicer	17-723
						Automann	122.282013.04	Haldex	CS41113
						Batco	04-932041	Leland	L-3114
	C444BR				Camshaft Kits	BWP	M-3171R	Meritor	2210F6870
					B8683	M-4011R			2210S8157
					B8747	Euclid	E-2444B/E-5509	Spicer	17-722
C451L		REPLACED BY C451AL			10 - Spline	Automann	122.102402.01	Leland	L-1654
					"Q"	Batco	04-882422	Meritor	2210U4181
		24-1/16"	2-5/64"	1-25/32"	Double-Grooved	BWP	M-995L	Spicer	17-643
						Euclid	E-2451		
						Haldex	CS41752		
						Automann	122.102402.02	Leland	L-1653
						Batco	04-882421	Meritor	2210T4180
	C452R	REPLACED BY C452AR			Camshaft Kits	BWP	M-995R	Spicer	17-642
					B8683	Euclid	E-2452		
					B8747	Haldex	CS41753		
C451AL		24-1/16"	2-5/64"	1-25/32"	10 - Spline	Automann	122.102402.03		
							"Q-Plus"	BWP	M-4032L
					Double-Grooved	Euclid	E-2451A		
						Meritor	R607068		
						Automann	122.102402.04		
						BWP	M-4032R		
	C452AR				Camshaft Kits	Euclid	E-2452A		
					B8683	Meritor	R607067		
					B8747				

BRAKE CAMSHAFTS - TRAILER

Meritor 4000 - 6000

Double-Grooved

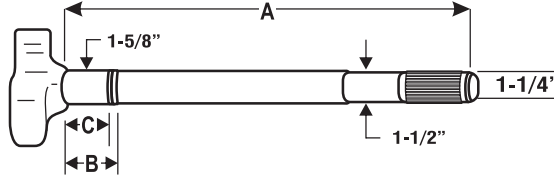

1-1/2" Dia. - 10 Spline
1-1/2" Dia. - 28 Spline

"A" Dimension: under head to beginning of lock ring groove

LH	RH	A	B	C	NOTES	REPLACES	
					28 - Spline	Automann 122.282402.01 Batco 04-892422 BWP M-992L Euclid E-2445A Haldex CS41758	Leland L-1658 Meritor 2210P4332 Spicer 17-631
C445L		REPLACED BY C445BL			"Q"		
		24-1/16"	2-5/64"	1-25/32"	Double-Grooved	Automann 122.282402.02 Batco 04-892421 BWP M-992R Euclid E-2446A Haldex CS41759	Leland L-1657 Meritor 2210N4330 Spicer 17-630
	C446R	REPLACED BY C446BR			Camshaft Kits		
					B8683 B8747		
C445BL		24-1/16"	2-5/64"	1-25/32"	28 - Spline	Automann 122.282402.03 Batco 04-932422 BWP M-3172L M-4012L Euclid E-2445B/E-5510	Haldex CS41114 Leland L-3117 Meritor 2210E6869 2210V8160 Spicer 17-725
	C446BR				Double-Grooved	Automann 122.282402.04 Batco 04-932421 BWP M-3172R M-4012R Euclid E-2446B/E-5511	Haldex CS41115 Leland L-3116 Meritor 2210D6868 2210U8159 Spicer 17-724
					Camshaft Kits		
					B8683 B8747		

BRAKE CAMSHAFTS - TRAILER

Meritor 16-1/2" "Q" And "Q-Plus"

Double-Grooved



1-1/8"
LEFT HAND
"Q PLUS"

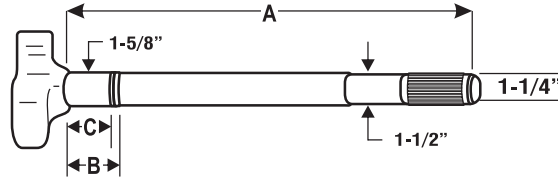

1-3/8"
LEFT HAND

1-1/2" Dia. - 28 Spline

"A" Dimension: under head to beginning of lock ring groove

LH	RH	A	B	C	NOTES	REPLACES	
					"Q"	Automann 122.281710.03 Batco 04-911732 BWP M-4094L Euclid E-9091 Haldex CS41504	Meritor 2210V6574 Spicer 17-657
C091L		REPLACED BY C441BL					
		17-5/16"	2-5/64"	1-25/32"	Camshaft Kits	Automann 122.281710.04 Batco 04-911731 BWP M-4094R Euclid E-9092 Haldex CS41505	Meritor 2210U6573 Spicer 17-656
	C092R	REPLACED BY C442BR				B8772M B8773M	
					"Q-Plus"	Automann 122.281710.03 Batco 04-931732 BWP M-3170L Euclid E-5506 Haldex CS41110	Leland L-3113 Meritor 2210C6867 Spicer 17-721
C867L		REPLACED BY C441BL					
		17-5/16"	2-5/64"	1-25/32"	Camshaft Kits	Automann 122.281710.04 Batco 04-931731 BWP M-3170R Euclid E-5507 Haldex CS41111	Leland L-3112 Meritor 2210B6866 Spicer 17-720
	C866R	REPLACED BY C442BR				B8772M B8773M	
					"Q"	Batco 04-912042 BWP M-4095L Euclid E-9093 Haldex CS41526 Meritor 2210P6594	Spicer 17-659
C087L		REPLACED BY C443BL					
		20-13/32"	2-5/64"	1-25/32"	Camshaft Kits	Batco 04-912041 BWP M-4095R Euclid E-9094 Haldex CS41527 Meritor 2210N6592	Spicer 17-658
	C088R	REPLACED BY C444BR				B8772M B8773M	
					"Q-Plus"	Automann 122.282013.03 Batco 04-932042 BWP M-3171L Euclid E-5508 Haldex CS41112	Leland L-3115 Meritor 2210G6871 Spicer 17-723
C871L		REPLACED BY C443BL					
		20-13/32"	2-5/64"	1-25/32"	Camshaft Kits	Automann 122.282013.04 Batco 04-932041 BWP M-3171R Euclid E-5509 Haldex CS41113	Leland L-3114 Meritor 2210F6870 Spicer 17-722
	C870R	REPLACED BY C444BR				B8772M B8773M	
					"Q"	Batco 04-912422 BWP M-4096L Euclid E-6081L Haldex CS41758 Meritor 2210X6576	Spicer 17-661
C081L		REPLACED BY C445BL					
		24-1/16"	2-5/64"	1-25/32"	Camshaft Kits	Batco 04-912421 BWP M-4096R Euclid E-6082R Haldex CS41759 Meritor 2210W6575	Spicer 17-660
	C082R	REPLACED BY C446BR				B8772M B8773M	

BRAKE CAMSHAFTS - TRAILER

Meritor 16-1/2" "Q" And "Q-Plus"

Double-Grooved

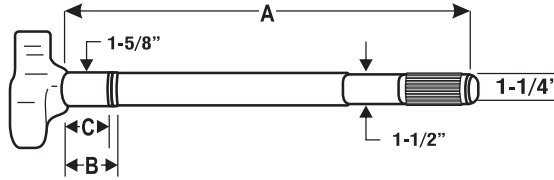

1-1/2" Dia. - 28 Spline

"A" Dimension: under head to beginning of lock ring groove

LH	RH	A	B	C	NOTES	REPLACES	
					"Q-Plus"	Automann 122.282402.03	Leland L-3117
C868L		REPLACED BY C445BL				Batco 04-932422	Meritor 2210E6869
		24-1/16"	2-5/64"	1-25/32"		BWP M-3172L	Spicer 17-725
					Camshaft Kits	Euclid E-5510	
						Automann 122.282402.04	Leland L-3116
					B8772M	Batco 04-932421	Meritor 2210D6868
					B8773M	BWP M-3172R	Spicer 17-724
						Euclid E-5511	
						Haldex CS41115	

BRAKE CAMSHAFTS - TRAILER

Spicer 12-1/4"

Double-Grooved

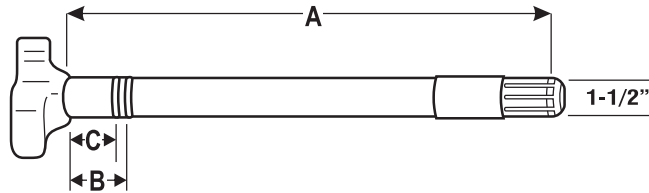

1-1/16"
LEFT HAND

1-1/2" Dia. - 10 Spline

"A" Dimension: under head to beginning of lock ring groove

LH	RH	A	B	C	NOTES	REPLACES	
C411L		21-1/8"	2-21/32"	2-7/32"	Std Forge 202103-213L/R	Automann 123.102104.01 Batco 04-612122 BWP M-477L Euclid E-1411 Haldex CS41762	Leland L-1075 Meritor R607006 Spicer 17-685 M12WK107-6
	C410R				Camshaft Kits B8655 B8655Z	Automann 123.102104.02 Batco 04-612121 BWP M-477R Euclid E-1410 Haldex CS41763	Leland L-1074 Meritor R607005 Spicer 17-684 M12WK106-6
C423L		23-1/4"	2-21/32"	2-7/32"	Std Forge 202103-233L/R	Automann 123.102308.01 Batco 04-612322 BWP M-478L Euclid E-1423 Haldex CS41718	Leland L-734 Meritor R607010 Spicer 17-691 M12WK101-17
	C422R				Camshaft Kits B8655 B8655Z	Automann 123.102308.02 Batco 04-612321 BWP M-478R Euclid E-1422 Haldex CS41719	Leland L-733 Meritor R607009 Spicer 17-690 M12WK100-17
C421L		23-7/8"	2-21/32"	2-7/32"	Std Forge 202103-241L/R	Automann 123.102328.01 Batco 04-612402 BWP M-479L Euclid E-1421 Haldex CS41722	Leland L-736 Meritor R607008 Spicer 17-695 M12WK101-19
	C420R				Camshaft Kits B8655 B8655Z	Automann 123.102328.02 Batco 04-612401 BWP M-479R Euclid E-1420 Haldex CS41723	Leland L-735 Meritor R607007 Spicer 17-694 M12WK100-19

BRAKE CAMSHAFTS - TRAILER

Spicer 12-1/4" "New" Head Design

Double-Grooved

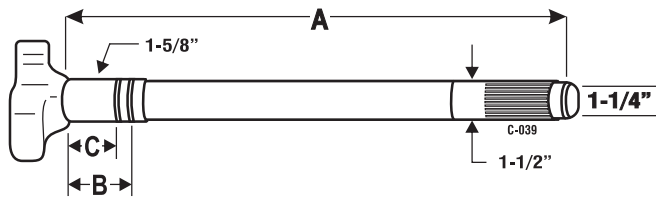

11/16"
LEFT HAND

1-1/2" Dia. - 28 Spline

"A" Dimension: under head to beginning of lock ring groove

LH	RH	A	B	C	NOTES	REPLACES	
C759L		23-3/16"	2-7/32"	2-21/32"	1-1/2" Journal	Automann 123.282306.01	Leland L-3171
						Batco 04-642322	Meritor R607253
	C760R				Camshaft Kits	BWP M-3789L	Spicer 17-783
					B8655 (Nylon)	Euclid E-9759	M12WKL20-233
					B8655Z (Bronze)	Haldex CS41362	
C905L		23-3/16"	2-7/32"	---	1-5/8" Journal	Automann 123.282306.03	Leland L-3277
						Batco 04-542322	Meritor R607273
	C906R				Camshaft Kit	BWP M-3796L	Spicer 17-417
					B8792	Euclid E-10905	M12WKL25-233
						Haldex CS41182	
						Automann 123.282306.04	Leland L-3276
						Batco 04-542321	Meritor R607274
						BWP M-3796R	Spicer 17-416
						Euclid E-10906	M12WKR25-233
						Haldex CS41183	

BRAKE CAMSHAFTS - TRAILER

Spicer 16-1/2"

Double-Grooved

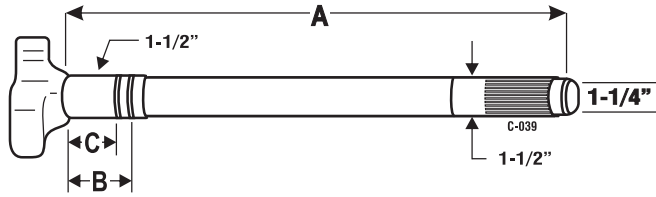

1-1/2" Dia. - 10 Spline

"A" Dimension: under head to beginning of lock ring groove

LH	RH	A	B	C	NOTES	REPLACES	
C217L		26-1/4"	2-7/32"	---	Camshaft Kit	Automann 123.102608.01 Batco 04-572632 BWP M-4022L Euclid E-7217 Meritor R607191	Spicer 17-591 M16WKL10-264
					B8652	Automann 123.102608.02 Batco 04-572631 BWP M-4022R Euclid E-7218 Meritor R607192	Spicer 17-590 M16WKR10-264
C219L		26-1/2"	2-7/32"	---	Camshaft Kit	Automann 123.102616.01 Batco 04-572652 BWP M-4023L Euclid E-7219 Haldex CS41168	Leland L-3359 Meritor R607193 Spicer 17-593 M16WKL10-266
					B8652	Automann 123.102616.02 Batco 04-572651 BWP M-4023R Euclid E-7220 Haldex CS41169	Leland L-3358 Meritor R607194 Spicer 17-592 M16WKR10-266
	C220R						

BRAKE CAMSHAFTS - TRAILER

Spicer 16-1/2" And Hayes Dana

Double-Grooved

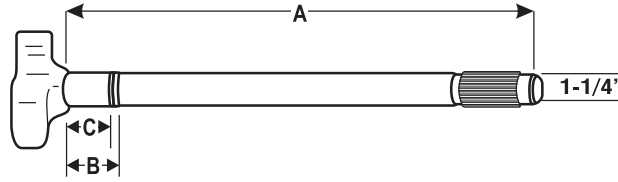

"A" Dimension: under head to beginning of lock ring groove

1-1/2" Dia. - 28 Spline

LH	RH	A	B	C	NOTES	REPLACES	
C724L		17-3/8"	2-7/32"	1-5/8"	Camshaft Kit	Automann 123.281712.01 Batco 04-581742 BWP M-3136L Euclid E-9725 Haldex CS41054	Meritor R607221 Spicer 17-479 M16WK104-10
	C725R				B8652	Automann 123.281712.02 Batco 04-581741 BWP M-3136R Euclid E-9726 Haldex CS41055	Meritor R607222 Spicer 17-478 M16WK105-10
C854L		20-3/8"	2-7/32"	1-5/8"	Camshaft Kit	Automann 123.282012.01 Batco 04-582042 BWP M-3175L Euclid E-3854 Haldex CS41053	Leland L-2898 Meritor R607169 Spicer 17-481 M16WK105-17
	C855R				B8652	Automann 123.282012.02 Batco 04-582041 BWP M-3175R Euclid E-3855 Haldex CS41052	Leland L-2897 Meritor R607170 Spicer 17-480 M16WK104-17
C890L		22-7/8"	2-7/32"	1-5/8"	Camshaft Kit	Automann 123.282228.01 Batco 04-582272 BWP M-3137L Euclid E-6884 Meritor R607189	Spicer 17-525 M16WK104-23
	C891R				B8652	Automann 123.282228.02 Batco 04-582271 BWP M-3137R Euclid E-6885 Meritor R607190	Spicer 17-524 M16WK105-23
C856L		23-7/16"	2-7/32"	1-5/8"	Camshaft Kit	Automann 123.282314.01 Batco 04-582352 BWP M-3186L Euclid E-3856 Haldex CS41164	Meritor R607171 Spicer 17-483 M16WK104-25
	C857R				B8652	Automann 123.282314.02 Batco 04-582351 BWP M-3186R Euclid E-3857 Haldex CS41165	Meritor R607172 Spicer 17-482 M16WK105-25
C892L		24-1/16"	2-7/32"	1-5/8"	Camshaft Kit	Batco 04-582412 BWP M-4027L Spicer M16WK104-26	
	C893R				B8652	Batco 04-582411 BWP M-4027R Spicer M16WK105-26	

BRAKE CAMSHAFTS - TRAILER

Spicer With 16-1/2" "XL" Brakes

Double-Grooved

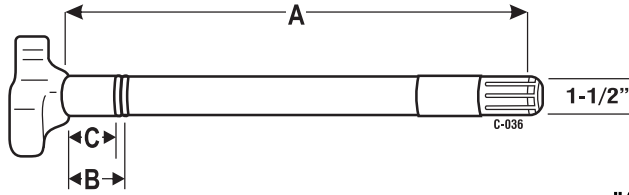

"A" Dimension: under head to beginning of lock ring groove

1-1/2" Dia. - 10 Spline

LH	RH	A	B	C	NOTES	REPLACES
C516L		17-3/8"	2-7/32"	1-5/8"	Camshaft Kit B8652	Automann 123.101512.01 Batco 04-591742 BWP M-3132L Euclid E-5516 Leland L-3293 Meritor R607173 Spicer 17-517 M16WKL10-175
	C517R				Automann 123.101512.02 Batco 04-591741 BWP M-3132R Euclid E-5517 Leland L-3292 Meritor R607174 Spicer 17-516 M16WKR10-175	
C514L		20-3/8"	2-7/32"	1-5/8"	Camshaft Kit B8652	Automann 123.102012.01 Batco 04-592042 BWP M-3145L Euclid E-5518 Haldex CS41328 Leland L-3381 Meritor R607175 Spicer 17-505 M16WKL10-205
	C515R				Automann 123.102012.02 Batco 04-592041 BWP M-3145R Euclid E-5519 Haldex CS41329 Leland L-3380 Meritor R607176 Spicer 17-504 M16WKR10-205	
C611L		22-7/8"	2-7/32"	1-5/8"	Camshaft Kit B8652	Automann 123.102228.01 Batco 04-592302 BWP M-3133L Euclid E-6101 Leland L-3599 Meritor R607185 Spicer 17-519 M16WKL10-231
	C612R				Automann 123.102228.02 Batco 04-592301 BWP M-3133R Euclid E-6102 Leland L-3598 Meritor R607186 Spicer 17-518 M16WKR10-231	
C512L		23-1/2"	2-7/32"	1-5/8"	Camshaft Kit B8652	Automann 123.102316.01 Batco 04-592352 BWP M-3134L Euclid E-5520 Haldex CS41390 Leland L-3291 Meritor R607177 Spicer 17-509 M16WKL10-236
	C513R				Automann 123.102316.02 Batco 04-592351 BWP M-3134R Euclid E-5521 Haldex CS41391 Leland L-3290 Meritor R607178 Spicer 17-508 M16WKR10-236	
C927L		24"	2-7/32"	1-5/8"	Camshaft Kit B8652	Automann 123.102400.01 Batco 04-592412 BWP M-3135L Euclid E-9727 Leland L-3307 Meritor R607223 Spicer 17-507 M16WKL10-242
	C928R				Automann 123.102400.02 Batco 04-592411 BWP M-3135R Euclid E-9728 Leland L-3306 Meritor R607224 Spicer 17-506 M16WKR10-242	

BRAKE CAMSHAFTS - TRAILER

Spicer With 16-1/2" "XL" Brakes

Double-Grooved

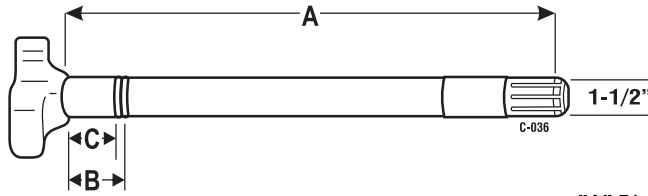

1-1/2" Dia. - 10 Spline

"A" Dimension: under head to beginning of lock ring groove

LH	RH	A	B	C	NOTES	REPLACES
					Automann 123.102608.03	Leland L-3125
C742L					Batco 04-592632	Meritor R607237
					BWP M-3148L	Spicer 17-557
					Euclid E-9741	M16WKL10-264
		26-1/4"	2-7/32"	1-5/8"	Camshaft Kit	
					B8652	
					Automann 123.102608.04	Leland L-3124
					Batco 04-592631	Meritor R607238
	C743R				BWP M-3148R	Spicer 17-556
					Euclid E-9742	M16WKR10-264
					Haldex CS41395	

BRAKE CAMSHAFTS - TRAILER

Spicer With 16-1/2" "XL" Brakes

Double-Grooved

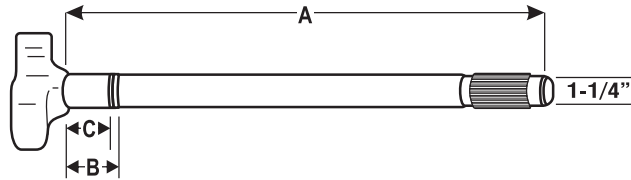

1-1/2" Dia. - 28 Spline

"A" Dimension: under head to beginning of lock ring groove

LH	RH	A	B	C	NOTES	REPLACES			
C528L		16-1/2"	2-7/32"	1-5/8"	Camshaft Kit B8652	BWP Spicer	M-4015L 17-520 M16WKL20-166		
	C529R					BWP Spicer	M-4015R 17-521 M16WKR20-166		
C096L		17-3/16"	2-7/32"	1-5/8"	Camshaft Kit B8652	Automann Batco BWP Euclid Haldex	123.281706.01 04-601722 M-4097L E-9096 CS41396	Leland Meritor Spicer	L-3241 R607195 17-531 M16WKL20-173
	C097R					Automann Batco BWP Euclid Haldex	123.281706.02 04-601721 M-4097R E-9097 CS41397	Leland Meritor Spicer	L-3240 R607196 17-530 M16WKR20-173
C518L		17-7/16"	2-7/32"	1-5/8"	Camshaft Kit B8652	Automann Batco BWP Euclid Haldex	123.281714.01 04-601742 M-3187L E-5522 CS41398	Leland Meritor Spicer	L-3031 R607179 17-513 M16WKL20-175
	C519R					Automann Batco BWP Euclid Haldex	123.281714.02 04-601741 M-3187R E-5523 CS41399	Leland Meritor Spicer	L-3030 R607180 17-512 M16WKR20-175
C520L		20-7/16"	2-7/32"	1-5/8"	Camshaft Kit B8652	Automann Batco BWP Euclid Haldex	123.282014.01 04-602042 M-3140L E-5524 CS41400	Leland Meritor Spicer	L-3073 R607181 17-501 M16WKL20-205
	C521R					Automann Batco BWP Euclid Haldex	123.282014.02 04-602041 M-3140R E-5525 CS41401	Leland Meritor Spicer	L-3072 R607182 17-500 M16WKR20-205
C098L		22-15/16"	2-7/32"	1-5/8"	Camshaft Kit B8652	Automann Batco BWP Euclid Haldex	123.282230.01 04-602302 M-3188L E-9098 CS41402	Leland Meritor Spicer	L-3047 R607197 17-511 M16WKL20-231
	C099R					Automann Batco BWP Euclid Haldex	123.282230.02 04-602301 M-3188R E-9099 CS41403	Leland Meritor Spicer	L-3046 R607198 17-510 M16WKR20-231

BRAKE CAMSHAFTS - TRAILER

Spicer With 16-1/2" "XL" Brakes

Double-Grooved

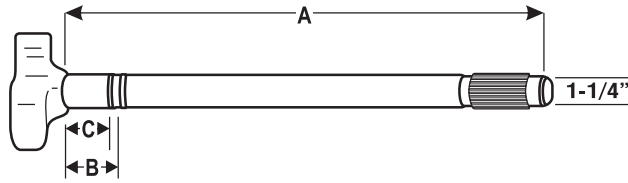

"A" Dimension: under head to beginning of lock ring groove

1-1/2" Dia. - 28 Spline

LH	RH	A	B	C	NOTES	REPLACES
C526L		23-9/16"	2-7/32"	1-5/8"	Camshaft Kit B8652	Automann 123.282318.01 Batco 04-602352 BWP M-3142L Euclid E-5526 Haldex CS41404 Leland L-3045 Meritor R607183 Spicer 17-503 M16WKL20-236
	C527R				Automann 123.282318.02 Batco 04-602351 BWP M-3142R Euclid E-5527 Haldex CS41405 Leland L-3044 Meritor R607184 Spicer 17-502 M16WKR20-236	
C530L		23-7/8"	2-7/32"	1-5/8"	Camshaft Kit B8652	Batco 04-602402 BWP M-4016L Leland L-3309 Spicer 17-490 M16WKL20-241
	C531R				Batco 04-602401 BWP M-4016R Leland L-3308 Spicer 17-491 M16WKR20-241	
C102L		24-1/16"	2-7/32"	1-5/8"	Camshaft Kit B8652	Automann 123.282402.03 Batco 04-602412 BWP M-3169L Euclid E-9100 Haldex CS41408 Leland L-3311 Meritor R607199 Spicer 17-515 M16WKL20-242
	C103R				Automann 123.282402.04 Batco 04-602411 BWP M-3169R Euclid E-9101 Haldex CS41409 Leland L-3310 Meritor R607200 Spicer 17-514 M16WKR20-242	
C532L		26-1/4"	2-7/32"	1-5/8"	Camshaft Kit B8652	Batco 04-602632 BWP M-4099L Leland L-3557 Spicer 17-526 M16WKL20-264
	C533R				Batco 04-602631 BWP M-4099R Leland L-3556 Spicer 17-527 M16WKR20-264	
C972L		26-15/16"	2-7/32"	1-5/8"	Camshaft Kit B8652	Automann 123.282630.01 Batco 04-602702 BWP M-3138L Euclid E-9729 Leland L-3377 Meritor R607225 Spicer M16WKL20-271
	C973R				Automann 123.282630.02 Batco 04-602701 BWP M-3138R Euclid E-9730 Leland L-3376 Meritor R607226 Spicer M16WKR20-271	

BRAKE CAMSHAFTS - TRAILER

Spicer "XL" And "Xtra-Life" With 1-5/8" Journal

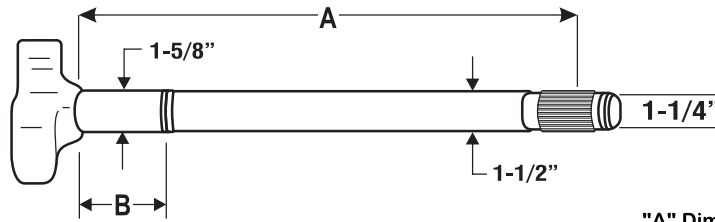

1-1/2" Dia. - 28 Spline

"A" Dimension: under head to beginning of lock ring groove

LH	RH	A	B	C	NOTES	REPLACES
C931L		17-7/16"	2-1/4"	---	Camshaft Kit B8792	Automann 123.281714.03 Batco 04-561742 BWP M-3696L Euclid E-9731 Haldex CS41414 Leland L-3283 Meritor R607227 Spicer 17-915 M16WKL25-175
	C932R				Automann 123.281714.04 Batco 04-561741 BWP M-3696R Euclid E-9732 Haldex CS41415 Leland L-3282 Meritor R607228 Spicer 17-914 M16WKR25-175	
C933L		20-7/16"	2-1/4"	---	Camshaft Kit B8792	Automann 123.282014.03 Batco 04-562042 BWP M-3697L Euclid E-9733 Haldex CS41416 Leland L-3287 Meritor R607229 Spicer 17-921 M16WKL25-205
	C934R				Automann 123.282014.04 Batco 04-562041 BWP M-3697R Euclid E-9734 Haldex CS41417 Leland L-3286 Meritor R607230 Spicer 17-920 M16WKR25-205	
C310L		21-3/8"	2-1/4"	---	Camshaft Kit B8792	Automann 123.282112.01 Batco 04-562142 BWP M-4013L Leland L-3425 Spicer 17-923 Leland L-3285 M16WKL25-215
	C311R				Automann 123.282112.02 Batco 04-562141 BWP M-4013R Leland L-3424 Spicer 17-922 M16WKR25-215	
C312L		22-7/8"	2-1/4"	---	Camshaft Kit B8792	Batco 04-562302 BWP M-3698L Euclid E-11858 Haldex CS41430 Leland L-3285 Meritor R607317 Spicer 17-926 M16WKL25-231
	C313R				Batco 04-562301 BWP M-3698R Euclid E-11859 Haldex CS41431 Leland L-3284 Meritor R607318 Spicer 17-927 M16WKR25-231	
C935L		23-9/16"	2-1/4"	---	Camshaft Kit B8792	Automann 123.282318.03 Batco 04-562352 BWP M-3147L Euclid E-9735 Haldex CS41420 Leland L-3289 Meritor R607231 Spicer 17-929 M16WKL25-236
	C936R				Automann 123.282318.04 Batco 04-562351 BWP M-3147R Euclid E-9736 Haldex CS41421 Leland L-3288 Meritor R607232 Spicer 17-928 M16WKR25-236	

BRAKE CAMSHAFTS - TRAILER

Spicer "XL" And "Xtra-Life" With 1-5/8" Journal

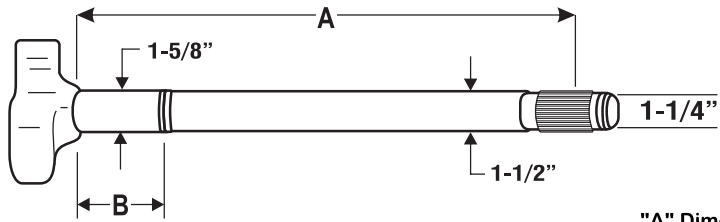

1-1/2" Dia. - 28 Spline

"A" Dimension: under head to beginning of lock ring groove

LH	RH	A	B	C	NOTES	REPLACES	
C910L		24-1/16"	2-1/4"	---	Camshaft Kit	Automann 123.282402.01 Batco 04-562412 BWP M-3699L Euclid E-10909 Haldex CS41422	Leland L-3321 Meritor R607277 Spicer 17-931 M16WKL25-242
	C911R				B8792	Automann 123.282402.02 Batco 04-562411 BWP M-3699R Euclid E-10910 Haldex CS41423	Leland L-3320 Meritor R607278 Spicer 17-930 M16WKR25-242
C314L		26-1/4"	2-1/4"	---	Camshaft Kit	Automann 123.282608.01 Batco 04-562632 BWP M-4014L Euclid E-11860 Haldex CS41434	Leland L-3379 Meritor R607319 Spicer 17-937 M16WKL25-264
	C315R				B8792	Automann 123.282608.02 Batco 04-562631 BWP M-4014R Euclid E-11861 Haldex CS41435	Leland L-3378 Meritor R607320 Spicer 17-936 M16WKR25-264
C737L		26-15/16"	2-1/4"	---	Camshaft Kit	Automann 123.282630.03 Batco 04-562702 BWP M-3141L Euclid E-9737 Haldex CS41436	Leland L-3407 Meritor R607233 Spicer 17-941 M16WKL25-271
	C738R				B8792	Automann 123.282630.04 Batco 04-562701 BWP M-3141R Euclid E-9738 Haldex CS41437	Leland L-3406 Meritor R607234 Spicer 17-940 M16WKR25-271

CAMSHAFT ENCLOSURE TUBES

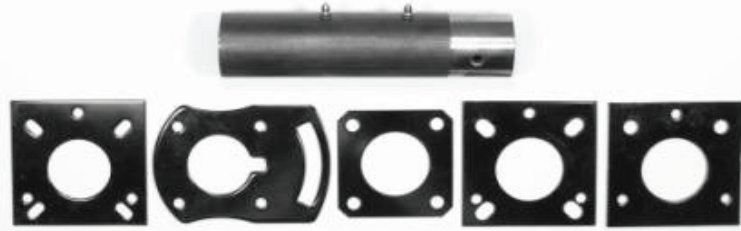

PART NO.	SPIDER I.D.	SUPPORT I.D.	TUBE LENGTH	CAM LENGTH	CAM PART NO.	APPLICATION	REPLACES
CT375	1.50"	1.50"	8.31"	11-1/8"	C604R/5L	Intraax 16-1/2" ES	Batco 03-1451 BWP M-4171 Euclid E-11497 Spicer 31-1466
CT336	1.50"	1.50"	14.75"	17-3/8" 17-3/8" 17-3/8" 17-7/16"	C794R/5L C724L/5R C516L/7R C518L/9R	Multiple Spicer 16-12" Spicer 16-12" XL Spicer 16-12" XL	Batco 03-149 Euclid E-9591 Spicer 31-1400
CT338	1.50"	1.50"	15.88"	18-5/8"	C412AR/3AL	Meritor 16-1/2" Q+	Batco 03-151 Euclid E-9593 Spicer 31-1403
CT332	1.50"	1.50"	17.75"	20-3/8" 20-3/8" 20-7/16"	C424AR/5AL C854L/5R C520L/1R	Multiple Spicer 16-1/2" Spicer 16-1/2" XL	Batco 03-146 BWP M-4172 Euclid E-4737A Spicer 31-1401
CT351	1.50"	1.50"	18.38"	21-1/8"	C410R/1L	Spicer 12-1/4"	Batco 03-155 Euclid E-9597 Spicer 31-1413
CT350	1.50"	1.50"	20.38"	23-3/16" 23-1/4"	C759L/0R C422R/3L	Spicer 12-1/4" Spicer 12-1/4"	Batco 03-154 Euclid E-9596 Spicer 31-1412
CT333	1.50"	1.50"	21.00"	23-7/16" 23-7/16" 23-1/2" 23-9/16"	C094R/5L C856L/7R C512L/3R C526L/7R	Multiple Spicer 16-1/2" Spicer 16-1/2" XL Spicer 16-1/2" XL	Batco 03-147 BWP M-4173 Euclid E-4738A Spicer 31-1402
CT337	1.50"	1.50"	23.63"	26-1/4" 26-1/4"	C217L/8R C742L/3R	Spicer 16-1/2" Spicer 16-1/2" XL	Batco 03-150 Euclid E-9592 Spicer 31-1420
CT361	1.62"	1.50"	14.81"	17-5/16" 17-5/16" 17-7/16"	C447AL/8AR C441BL/2BR C931L/2R	Meritor 16-1/2" Q+ Meritor 16-1/2" Q+ Spicer 16-1/2" XL	Batco 03-182 Euclid E-5242A Spicer 31-1439
CT369	1.62"	1.50"	16.75"	19-1/2" 19-1/2"	C693L/4R C494L/5R	Eaton 16-1/2" Eaton 16-1/2" ES	Euclid E-9601 Spicer 31-1442

CAMSHAFT ENCLOSURE TUBES

PART NO.	SPIDER I.D.	SUPPORT I.D.	TUBE LENGTH	CAM LENGTH	CAM PART NO.	APPLICATION	REPLACES	
CT359	1.62"	1.50"	17.94"	20-13/32" 20-13/32" 20-7/16"	C449AL/0AR C443BL/4BR C933L/4R	Meritor 16-1/2" Q+ Meritor 16-1/2" Q+ Spicer 16-1/2" XL	Batco Euclid Spicer	03-180 E-5243A 31-1440
CT370	1.62"	1.50"	21.00"	23-9/16" 23-3/4" 23-3/4"	C935L/6R C496L/7R C059L/0R	Spicer 16-12" XL Eaton 16-1/2" ES Eaton 16-1/2" ES	Batco BWP Euclid Spicer	03-184 M-4175 E-9602 31-1443
CT360	1.62"	1.50"	21.63"	24-1/16" 24-1/16"	C451AL/2AR C445BL/6BR	Meritor 16-1/2" Q+ Meritor 16-1/2" Q+	Batco BWP Euclid Spicer	03-181 M-4176 E-5244A 31-1441
CT356	1.62"	1.62"	13.75"	16-1/8"	C563L/4R	Fruehauf 16-1/2"	Batco Euclid Spicer	03-160 E-4934A 31-1430
CT357	1.62"	1.62"	19.00"	20-1/8"	C100R/1L	Fruehauf 16-1/2"	Batco Euclid Spicer	03-161 E-5241A 31-1431

BRACKETS

PART NO.	I.D.	THICK	APPLICATION	REPLACES
CT334	1.87"	0.12"	1.50" x 1.50" Cam	Batco 03-168 BWP M-4177 Euclid E-4739 Spicer 31-1405
CT310	2.00"	0.12"	1.62" x 1.50" Cam (Meritor)	Spicer 31-1406
CT312			1-7/8" Cam With Haldex Control Arm Slot	Batco 03-170 BWP M-4178 Euclid E-8906 Spicer 31-1468
CT311	2.00"	0.25"	1.62" x 1.62" Cam	Batco 03-169 Euclid E-4935 Spicer 31-1467
CT313			2" Cam With Haldex Control Arm Slot	Euclid E-10947 Spicer 31-1415-2
CT331			1.62" x 1.50" Cam	Euclid E-10946 Spicer 31-1415-1

CAM KIT QUICK CROSS-REFERENCE

KITS INTERCHANGE FUNCTIONALLY, SOME PARTS MAY DIFFER

DESCRIPTION	NOTES	SIRCO	PAGE	AUTOMANN	BATCO
B E N D I X					
15" Axle Kit	Steer Axle	B8795	134	110.2501	08-137800
Wheel End Kit		B8795A	134		08-137850
16-1/2" Axle Kit	Drive Axle	B8796	136	110.2502	08-137900
Wheel End Kit		B8796A	136		08-137950
D A N A					
12-1/4" "FT" Axle Kit	Nylon Bushing	B8682	130	110.2306	08-134100
Wheel End Kit		B8682A	130		08-134150
12-1/4" "FT" Axle Kit	Bronze Bushing	B8682Z	130		08-134110
Wheel End Kit		B8682ZA	130		08-134160
12-1/4" "FT" Axle Kit	3-Bolt Retainer	B8685Z	130	110.2304	08-132111
Wheel End Kit		B8685ZA	130		08-132161
12-1/4" "FT" And "FC" Axle Kit	Weld-On Spider	B8655	130	110.2307	08-132300
Wheel End Kit		B8655A	130		08-132350
12-1/4" "FT" And "FC" Axle Kit	Bronze Bushing	B8655Z	131	110.2305	08-132310
Wheel End Kit		B8655ZA	131		08-132360
12-1/4" "FC-III" Axle Kit		B8798	131		08-132900
Wheel End Kit		B8798A	131		08-132950
12-1/4" "FC-III" Axle Kit	Support Bracket	B8797	131		08-132903
Wheel End Kit		B8797R	131		08-132901
Wheel End Kit		B8797L	131		08-132902
15" "HA" Axle Kit	Front And Lift Axle	B8801	134		08-138100
Wheel End Kit		B8801A	134		08-138150
16-1/2" "Xtra-Life" Axle Kit	Drive Axle	B8802	137		08-138200
Wheel End Kit		B8802A	137		08-138250
16-1/2" "FT", "FC" And "Xtra-Life" Axle Kit	Trailer Axle	B8652	137	110.2302	08-132100
Wheel End Kit		B8652A	137		08-132150
16-1/2" "FT", "FC" And "Xtra-Life" Axle Kit	Bronze Bushing	B8652Z	137		
16-1/2" "FT", "FC" And "Xtra-Life" Axle Kit	Rigid Cam Support	B8651	137		08-132102
Wheel End Kit		B8651A	137		08-132152
16-1/2" "FT" And "FC" Axle Kit	Rigid Support With Seals	B8656	138	110.2301	08-132103
Wheel End Kit		B8656A	138		08-132153
16-1/2" Axle Kit	Weld-On Spider	B8653	138		
16-1/2" "Xtra-Life" Axle Kit	1-1/2" Camshaft	B8687	138	110.2308	08-132110
Wheel End Kit		B8687A	138		08-132160
16-1/2" "Xtra-Life II" Axle Kit	Trailer Axle	B8792	139	110.2303	08-132800
Wheel End Kit		B8792A	139		08-132850
16-1/2" "Xtra-Life II" Axle Kit	Support Bracket	B8803	139	110.2010	08-132803
Wheel End Kit		B8803R	139		08-132801
Wheel End Kit		B8803L	139		08-132802

CAM KIT QUICK CROSS-REFERENCE

KITS INTERCHANGE FUNCTIONALLY, SOME PARTS MAY DIFFER

BWP	EUCLID	HALDEX	LELAND	MERITOR	SPICER	OEM
M-K96	E-7235	CQ67138	K-301	R615016	43-7064 43-7064-1	
M-K97	E-7241	CQ67100	K-302	R615017	43-7065 43-7065-1	
M-K25	E-2526	CQ67411	K-87 K-144	R615001	43-7031 43-7031-1	M12KY100
M-K64	E-2680 E-2680-2	CQ67353	K-151	R615007	43-7030 43-7030-1	
M-K26	E-2469 E-2469-2	CQ67382	K-345 K-145	R615010	43-7033 43-7033-1	M12KY101
M-K102	E-5307 E-5307-2	CQ67383	K-347 K-337	R615014	43-7062 43-7062-1	
	E-11910		K-494 K-482 K-483		43-7118	M10KY105
M-K23	E-2287 E-2287-2	CQ67332	K-343 K-314	R615008	43-7032 43-7032-1	M16KY20
M-K22						
M-K27	E-2087 E-2087-2	CQ67331	K-346 K-146	R615009	43-7029 43-7029-1	
M-K24						
M-K101			K-348 K-327			
M-K111	E-9790A E-9790A-2	CQ67111	K-505 K-355	R615019		

CAM KIT QUICK CROSS-REFERENCE

KITS INTERCHANGE FUNCTIONALLY, SOME PARTS MAY DIFFER

DESCRIPTION	NOTES	SIRCO	PAGE	AUTOMANN	BATCO
D E X T E R					
12-1/4" Pivot, "QM" And "Q" Axle Kit	Nylon Bushing	B8655	130	110.2307	08-132300
Wheel End Kit		B8655A	130		08-132350
Axle Kit	Bronze Bushing	B8655Z	131	110.2305	08-132310
Wheel End Kit		B8655ZA	131		08-132360

E A T O N					
12-1/4" "SA" Axle Kit	Nylon Bushing	B8712	132	110.2006	08-136600
Wheel End Kit		B8712A	132		08-136650
12-1/4" "SA" Axle Kit	Bronze Bushing	B8712Z	132		08-136610
Wheel End Kit		B8712ZA	132		08-136660
15" "EB" And "ES" Axle Kit	Drive Axle	B8742	134	110.2003	08-137500
Wheel End Kit		B8742A	134		08-137550
15" "Reduced Envelope" Axle Kit	Nylon Bushing	B8746	135	110.2004	08-135101
Wheel End Kit		B8746A	135		08-135151
15" "Reduced Envelope" Axle Kit	Bronze Bushing	B8746Z	135	110.2005	08-135111
Wheel End Kit		B8746ZA	135		08-135161
16-1/2" "SC" Axle Kit	Drive Axle	B8648	139	110.2001	08-135100
Wheel End Kit		B8648A	139		08-135150
16-1/2" "ES" Axle Kit	Drive Axle	B8746	135	110.2004	08-135101
Wheel End Kit		B8746A	135		08-135151
16-1/2" "ES" Axle Kit	Bronze Bushing	B8746Z	135	110.2005	08-135111
Wheel End Kit		B8746ZA	135		08-135161
16-1/2" "ES" Axle Kit	Drive Axle - Bronze Bushing	B8793	140	110.2007	08-135110
Wheel End Kit		B8793A	140		08-135160
16-1/2" Round Axle Kit	Bolt-On Spider	B8657	140	110.2008	08-130800
Wheel End Kit		B8657A	140		08-130850
16-1/2" Square Axle Kit	Weld-On Spider	B8647	140	110.2009	08-130801
Wheel End Kit		B8647A	140		08-130851
16-1/2" "EB" And "ES" Axle Kit		B8684	141	110.2002	08-136400
Wheel End Kit		B8684A	141		08-136450

F R U E H A U F					
12-1/4" "F" Axle Kit	Propar	B8649	132	110.2101	08-133100
Wheel End Kit		B8649A	132		08-133150
16-1/2" "F" Axle Kit	Propar	B8650	141	110.2102	08-133101
Wheel End Kit		B8650A	141		08-133151
16-1/2" "XEM" And "FQ" Axle Kit	Propar	B8649	141	110.2101	08-133100
Wheel End Kit		B8649A	141		08-133150

H E N D R I C K S O N					
16-1/2" "Intraax" Axle Kit	Standard	B8790	142		08-130301
Wheel End Kit		B8790A	142		08-130351
16-1/2" "Intraax" Axle Kit	Standard	B8790HD	142		
Wheel End Kit		B8790HDA	142		

CAM KIT QUICK CROSS-REFERENCE

KITS INTERCHANGE FUNCTIONALLY, SOME PARTS MAY DIFFER

BWP	EUCLID	HALDEX	LELAND	MERITOR	SPICER	OEM
M-K26	E-2469	CQ67382	K-345	R615010	43-7033	M12KY101
	E-2469-2		K-145		43-7033-1	
M-K102	E-5307	CQ67383	K-347	R615014	43-7062	
	E-5307-2		K-337		43-7062-1	
M-K60	E-2494	CQ67410		R615000	43-7040	
			K-147		43-7040-1	
M-K78	E-5140	CQ66918	K-493	R615013	43-7060	1008325
	E-5140-2		K-264		43-7060-1	
M-K86	E-5501	CQ65501	K-499	R615015	43-7069	127808
	E-5501-2		K-296		43-7069-1	
	E-10897			R615021		
M-K19	E-2125	CQ67326	K-357	R615002	43-7041	78500
	E-2125-2		K-140		43-7041-1	
M-K86	E-5501	CQ65501	K-499	R615015	43-7069	127808
	E-5501-2		K-296		43-7069-1	
	E-10897			R615021		
M-K116	E-9053	CQ67412		R615018	43-7068	1008047
			K-312		43-7068-1	
M-K62	E-2089	CQ67384			43-7042	
			K-138		43-7042-1	
M-K18	E-2123	CQ67325		R615003		
			K-139			
M-K63	E-2696A	CQ67354	K-360	R615004	43-7043A	1008347
	E-2696A-2		K-141		43-7043A-1	

M-K20	E-2090	CQ67324	K-88	R615005	43-7039	AXA0420-900
	E-2090-2		K-108		43-7039-1	
M-K21	E-2122	CQ66740		R615006	43-7038	305680-900
	E-2122-2		K-52		43-7038-1	
M-K20	E-2090	CQ67324	K-88	R615005	43-7039	AXA0420-900
	E-2090-2		K-108		43-7039-1	

M-K107	E-9791	CQ67414	K-506	R615020	43-7090	S-21181
			K-361		43-7090-1	
	E-9791HD			R615022		

CAM KIT QUICK CROSS-REFERENCE

KITS INTERCHANGE FUNCTIONALLY, SOME PARTS MAY DIFFER

DESCRIPTION	NOTES	SIRCO	PAGE	AUTOMANN	BATCO
H E N D R I C K S O N (cont'd)					
16-1/2" "Intraax" Axle Kit	"HXS"	B8794	142	110.2220	08-130311
Wheel End Kit		B8794A	142		08-130361
16-1/2" "Intraax" Axle Kit	"HXS"	B8794HD	142		
Wheel End Kit		B8794HDA	142		
16-1/2" "Intraax" Axle Kit	With Cam Tube	B8805	142	110.2505	

M A C K					
16-1/2" "P" Axle Kit	Drive Axle	B8646	143	110.2201	08-130200
Wheel End Kit		B8646A	143		08-130250
16-1/2" "P" Axle Kit	With Winged Washer	B8804	143		08-137400
Wheel End Kit		B8804A	143		08-137450
16-1/2" "Q" Axle Kit	50,000# Axle	B8745	143	110.2504	08-137300
Wheel End Kit		B8745A	143		08-137350

M E R I T O R					
12-1/4" "Q" Axle Kit	Trailer Brake	B8645	132	110.2215	08-130600
Wheel End Kit		B8645A	132		08-130650
12-1/4" "Q" Axle Kit	With Bronze Bushing	B8645Z	132		08-130620
Wheel End Kit		B8645ZA	132		08-130670
12-1/4" "Q" Axle Kit	With Support Bracket	B8683	133	110.2204	08-130601
Wheel End Kit		B8683A	133		08-130651
12-1/4" "Q" Axle Kit	With HD Bracket	B8683HD	133		
Wheel End Kit		B8683HDA	133		
12-1/4" "Q" Axle Kit	With Bronze Bushing	B8683Z	133		08-130621
Wheel End Kit		B8683ZA	133		08-130671
14-1/2" "W" Axle Kit	Front And Drive Axle	B8800	133		08-140500
Wheel End Kit		B8800A	133		08-140550
15" "T" Front Axle Kit	With 1-1/4" Camshaft	B8743	135	110.2202	08-136900
Wheel End Kit		B8743A	135		08-136950
15" And 16-1/4" "T" Axle Kit	With 1-1/2" Camshaft	RC-1	135	110.2203	08-136800
Wheel End Kit		RC-1A	135		08-136850
15" And 16-1/4" "T" Axle Kit	With Bronze Bushing	RC-1Z	135		08-136810
Wheel End Kit		RC-1ZA	135		08-136860
15" "Q" Axle Kit	Front Axle	B8744	136	110.2205	08-136100
Wheel End Kit		B8744A	136		08-136150
15" And 16-1/2" "Q" And "Q-Plus" Axle Kit	Drive Axle	B8707	136	110.2207	08-131800
Wheel End Kit		B8707A	136		08-131850
15" And 16-1/2" "Q" And "Q-Plus" Axle Kit	With Bronze Bushing	B8707Z	136		08-131810
Wheel End Kit		B8707ZA	136		08-131860
16-1/2" And 18" "P" Axle Kit	Front And Drive Axle	B8646	144	110.2201	08-130200
Wheel End Kit		B8646A	144		08-130250

CAM KIT QUICK CROSS-REFERENCE

KITS INTERCHANGE FUNCTIONALLY, SOME PARTS MAY DIFFER

BWP	EUCLID	HALDEX	LELAND	MERITOR	SPICER	OEM
	E-11450	CQ67444	K-481	R615023		S-23974
	E-11450HD			R615024		
	E-11450HD-2					
	E-11897	CQ67443	K-503	R615025		S-26348

M-K17	E-2086B	CQ67327		KIT 9078	43-7047	
	E-2086B-2			KIT 9078A	43-7047-1	
	E-5094A	CQ66939				

M-K16	E-2382	CQ67334	K-97	KIT 970	43-7037	
			K-53		43-7037-1	
M-K61	E-3520A	CQ67386	K-270	KIT 8048	43-7037A	
	E-3520A-2		K-269		43-7037A-1	
	E-3520AHD					
	E-3520AHD-2					
			K-489			
			K-289			
M-K68	E-3446	CQ66922		KIT 9300	43-7051	
	E-3446-2		K-273		43-7051-1	
M-K69	E-3468A	CQ66920		KIT 9304	43-7050	
			K-272		43-7050-1	
M-K87	E-3876	CQ62768	K-285		43-7059	
	E-3876-2			KIT 8022	43-7059-1	
M-K81	E-3993B	CQ67387	K-81	KIT 8042	43-7048	
	E-3993B-2		K-48		43-7048-1	
M-K17	E-2086B	CQ67327		KIT 9078	43-7047	
	E-2086B-2			KIT 9078A	43-7047-1	

CAM KIT QUICK CROSS-REFERENCE

KITS INTERCHANGE FUNCTIONALLY, SOME PARTS MAY DIFFER

DESCRIPTION	NOTES	SIRCO	PAGE	AUTOMANN	BATCO
M E R I T O R (cont'd)					
16-1/2" "P" Trailer Axle Kit	Less Bracket Assembly	B8644	144		08-130100
Wheel End Kit		B8644A	144		08-130150
16-1/2" "P" Trailer Axle Kit	With 1-1/2" Camshaft	B8681	144	110.2216	08-130101
Wheel End Kit		B8681A	144		08-130151
16-1/2" "P" Trailer Axle Kit	With HD Bracket	B8681HD	144		
Wheel End Kit		B8681HDA	144		
16-1/2" "P" Trailer Axle Kit	"TKL" Axle	B8686	145		08-130111
Wheel End Kit		B8686A	145		08-130161
16-1/2" "P" Trailer Axle Kit	With HD Bracket	B8686HD	145	110.2213	
16-1/2" "P" Trailer Axle Kit	With 2-Piece Bushing	B8643	145	110.2212	08-130122
Wheel End Kit		B8643A	145		08-130172
16-1/2" 4000-6000 Axle Kit	Without Support Bracket	B8645	145	110.2215	08-130600
Wheel End Kit		B8645A	145		08-130650
16-1/2" 4000-6000 Axle Kit	With Bronze Bushing	B8645Z	145		08-130620
Wheel End Kit		B8645ZA	145		08-130670
16-1/2" 4000-6000 Axle Kit	With Support Bracket	B8683	146	110.2204	08-130601
Wheel End Kit		B8683A	146		08-130651
16-1/2" 4000-6000 Axle Kit	With HD Bracket	B8683HD	146		
Wheel End Kit		B8683HDA	146		
16-1/2" 4000-6000 Axle Kit	With Bronze Bushing	B8683Z	146		08-130621
Wheel End Kit		B8683ZA	146		08-130671
16-1/2" 4000-6000 Axle Kit	Alternate For B8683	B8747	146		
Wheel End Kit		B8747A	146		
16-1/2" 4000-6000 Axle Kit	With HD Bracket	B8747HD	146	110.2206	
Wheel End Kit		B8747HDA	146		
16-1/2" "Q" And "Q-Plus" Axle Kit	Minor Kit	B8766	147	110.2208	02-2101
16-1/2" "Q" Drive Axle Kit	With Offset Spider	B8771	147	110.2211	
Wheel End Kit		B8771A	147		
16-1/2" "Q" And "Q-Plus"	With Press-In Bushing	B8772M	147	110.2209	08-130631
Trailer Axle Kit					
Wheel End Kit		B8772MA	147		08-130681
16-1/2" "Q" And "Q-Plus"	With HD Bracket	B8772MHD	148		
Trailer Axle Kit					
Wheel End Kit		B8772MHDA	148		
16-1/2" "Q" And "Q-Plus"	Minor Kit	B8788	148	110.2217	
Trailer Axle Kit					
16-1/2" "Q" And "Q-Plus"	With Bolt-On Bushing	B8773M	148	110.2210	08-130611
Trailer Axle Kit					
Wheel End Kit		B8773MA	148		08-130661
16-1/2" "Q" And "Q-Plus"	With HD Bracket	B8773MHD	148		
Trailer Axle Kit					
Wheel End Kit		B8773MHDA	148		

CAM KIT QUICK CROSS-REFERENCE

KITS INTERCHANGE FUNCTIONALLY, SOME PARTS MAY DIFFER

BWP	EUCLID	HALDEX	LELAND	MERITOR	SPICER	OEM
M-K15	E-2363	CQ67764		KIT 969	43-7044A	
			K-149		43-7044A-1	
M-K14	E-2088A E-2088AHD E-2088AHD-2	CQ67328	K-368	KIT 8046	43-7044	
			K-268		43-7044-1	
M-K65	E-2679A E-2679AHD	CQ67385		KIT 9035	43-7046	
			K-152		43-7046-1	
M-K13	E-1357A	CQ67329				
			K-51			
M-K16	E-2382	CQ67334	K-97	KIT 970	43-7037	
			K-53		43-7037-1	
M-K61	E-3520A E-3520A-2 E-3520AHD E-3520AHD-2	CQ67386	K-270	KIT 8048	43-7037A	
			K-269		43-7037A-1	
				R003520AHD		
			K-489			
			K-289			
M-K85	E-3989AHD E-3989AHD-2 E-5513 E-9080	CQ65517 CQ66940 CQ67413			43-7037B	
					43-7037B-1	
				KIT 8033 (2)	43-7048A	
			K-310			
M-K89	E-9078 E-9078HD E-9078HD-2	CQ67128	K-490	KIT 8058	43-7071	
					43-7071-1	
M-K90	E-6078	CQ66941	K-491	KIT 8289	43-7072A	
M-K88	E-9079 E-9079HD E-9079HD-2	CQ67416	K-363	KIT 8091	43-7072	
			K-313	KIT 8078A	43-7072-1	

CAMSHAFT REPAIR KITS

FOR 12-1/4" DIAMETER BRAKES

DANA 12-1/4" "FT" SERIES AXLE (RIGID SUPPORT)

	B8682	REPLACES		
	2 - B8600 Bushing 2 - B8602 Bushing 6 - B8604 Lock 4 - B8610 Washer 8 - B8612A Seal 2 - B8697 Washer	B8682	B8682A	
		Automann 110.2306 Batco 08-134100 BWP M-K25 Euclid E-2526 Haldex CQ67411 Leland K-87 Meritor R615001 Spicer 43-7031 M12KY100	08-134150	K-144 43-7031-1
	B8682A			
	Wheel End Kit			
	B8682Z	B8682Z	B8682ZA	
	2 - B807 Replaces B8602	Batco 08-134110	08-134160	
	B8682ZA			
	Wheel End Kit			

DANA 12-1/4" "FT" SERIES AXLE (3-BOLT RETAINER)

	B8685Z	REPLACES		
	2 - B807 Bronze Bushing 4 - B8604 Lock 2 - B8607 Washer 2 - B8608 Washer 2 - B8611 Washer 4 - B8612 Seal 4 - B8621 O-Ring 2 - B8699 Bushing	B8685Z	B8685ZA	
		Automann 110.2304 Batco 08-132111 BWP M-K64 Euclid E-2680 Haldex CQ67353 Leland K-151 Meritor R615007 Spicer 43-7030	08-132161	E-2680-2 K-151 43-7030-1
	B8685ZA			
	Wheel End Kit			

DANA 12-1/4" "FT" AND "FC" SERIES (WELD-ON SPIDER)

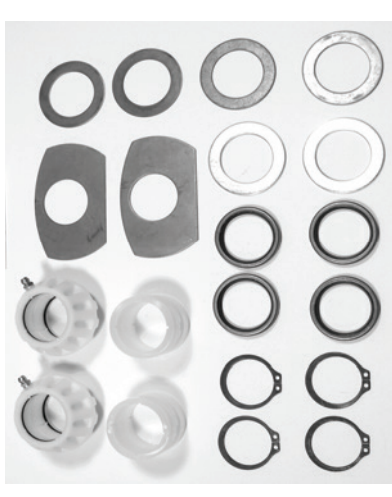
	B8655	REPLACES		
	2 - B8602 Bushing 4 - B8604 Lock 2 - B8605 Washer 2 - B8606 Bushing 2 - B8607 Washer 4 - B8612A Seal 2 - B8631 Washer 2 - B8632 Washer	B8655	B8655A	
		Automann 110.2307 Batco 08-132300 BWP M-K26 Euclid E-2469 Haldex CQ67382 Leland K-345 Meritor R615010 Spicer 43-7033 M12KY101	08-132350	E-2469-2 K-145 43-7033-1
	B8655A			
	Wheel End Kit			

CAMSHAFT REPAIR KITS

FOR 12-1/4" DIAMETER BRAKES

DANA 12-1/4" "FT" AND "FC" SERIES (WELD-ON SPIDER)

	B8655Z	REPLACES	
	2 - B807 Bronze Bushing 4 - B8604 Lock 2 - B8606 Bushing 2 - B8607 Washer 4 - B8612A Seal 2 - B8631 Washer 2 - B8632 Washer	B8655Z	B8655ZA
	B8655ZA	Automann 110.2305 Batco 08-132310 BWP M-K102 Euclid E-5307 Haldex CQ67383 Leland K-347 Meritor R615014 Spicer 43-7062	08-132360 E-5307-2 K-337 43-7062-1
	Wheel End Kit		

DANA 12-1/4" "FC-III" SERIES AXLE

	B8798	REPLACES	
	2 - B793 Lock 2 - B800 Washer 2 - B805 Bronze Bushing 2 - B963 Washer 2 - B8604 Lock 2 - B8606 Bushing 4 - B8625 Seal 2 - B8632 Washer 2 - B8634A Lock 2 - B8752 Washer	B8798	B8798A
	B8798A	Batco 08-132900	08-132950
	Wheel End Kit		

DANA 12-1/4" "FC-III" SERIES AXLE (WITH SUPPORT BRACKET)

	B8797	REPLACES	
	2 - B145 Washer 2 - B148 Washer 2 - B793 Lock 2 - B800 Washer 2 - B801 Spacer 2 - B805 Bronze Bushing 1 - B8150R Support 1 - B8150L Support 2 - B8604 Lock 2 - B8606A Lock 2 - B8622 Lock 2 - B8634A Lock 4 - B8764 Seal	B8797	
	B8797R/L	Batco 08-132903 Euclid E-11910 Leland K-494 Spicer 43-7118 M10KY105	
	Wheel End Kit	B8797R	B8797L
		Batco 08-132901 Leland K-482	08-132902 K-483

CAMSHAFT REPAIR KITS

FOR 12-1/4" DIAMETER BRAKES

EATON 12-1/4" "SA" SERIES

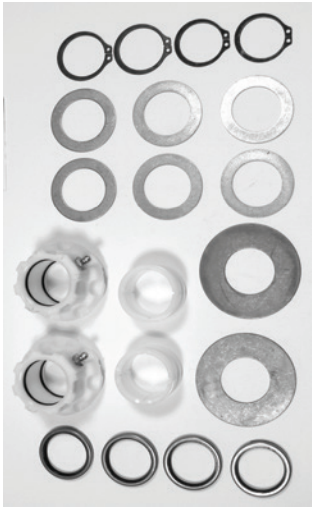
	B8712		REPLACES	
	2 - B811	Washer	B8712	
	2 - B8600	Bushing	Automann	110.2006
	2 - B8604	Lock	Batco	08-136600
	6 - B8607	Washer	BWP	M-K60
	4 - B8612A	Seal	Euclid	E-2494
2 - B8616	Bushing	Haldex	CQ67410	
2 - B8622	Lock	Leland		
B8712A		Meritor	R615000	K-147
Wheel End Kit		Spicer	43-7040	43-7040-1
B8712Z		B8712Z		B8712ZA
2 - B667	Replaces B8600	Batco	08-136610	08-136660
B8712ZA				
Wheel End Kit				

FRUEHAUF 12-1/4" "PROPAR" "F" SERIES BRAKE

	B8649		REPLACES	
	2 - B8604	Lock	B8649	
	2 - B8607	Washer	Automann	110.2101
	6 - B8619	Washer	Batco	08-133100
	4 - B8620	Bushing	BWP	M-K20
	2 - B8622	Lock	Euclid	E-2090
2 - B8624	Bushing	Fruehauf	AXA0420-900	E-2090-2
B8649A		Haldex	CQ67324	
Wheel End Kit		Leland	K-88	K-108
		Meritor	R615005	
		Spicer	43-7039	43-7039-1

MERITOR 12-1/4" "Q" SERIES

	B8645		REPLACES	
	2 - B793	Lock	B8645	
	4 - B960	Washer	Automann	110.2215
	2 - B988	Washer	Batco	08-130600
	2 - B8610	Washer	BWP	M-K16
	4 - B8621	O-Ring	Euclid	E-2382
2 - B8622	Lock	Haldex	CQ67334	
2 - B8636	Bushing	Leland	K-97	K-53
2 - B8661	Assembly	Meritor	KIT 970	
2 - B8689	Lock	Spicer	43-7037	43-7037-1
B8645A				
Wheel End Kit				
B8645Z		B8645Z		B8645ZA
2 - B8661Z	Replaces B8661	Batco	08-130620	08-130670
B8645ZA				
Wheel End Kit				

CAMSHAFT REPAIR KITS

FOR 12-1/4" AND 14-1/2" BRAKES

MERITOR 12-1/4" "Q" SERIES (WITH SUPPORT BRACKET)				
	B8683		REPLACES	
	2 - B793	Lock	B8683	
	4 - B960	Washer	B8683A	
	2 - B988	Washer	Automann	110.2204
	2 - B8610	Washer	Batco	08-130601
	2 - B8622	Lock	BWP	M-K61
2 - B8661	Assembly	Euclid	E-3520A	
2 - B8689	Lock	Haldex	CQ67386	
2 - B8696	Bracket	Leland	K-270	
		Meritor	KIT 8048	08-130651
		Spicer	43-7037A	E-3520A-2
				K-269
				43-7037A-1
B8683A				
Wheel End Kit				
B8683HD		B8683HD		B8683HDA
2 - B8696HD Replaces B8696		Euclid	E-3520AHD	E-3520AHD-2
B8683HDA				
Wheel End Kit				

MERITOR 12-1/4" "Q" SERIES (WITH BRONZE BUSHING)				
	B8683Z		REPLACES	
	2 - B793	Lock	B8683Z	
	4 - B960	Washer	B8683ZA	
	2 - B988	Washer	Batco	08-130621
	2 - B8610	Washer	Leland	K-489
	2 - B8622	Lock		
2 - B8661Z	Bushings Assembly			
2 - B8689	Lock			
2 - B8696	Bracket			
B8683ZA				
Wheel End Kit				

MERITOR 14-1/2" "W" SERIES TYPE 3 FRONT AND DRIVE AXLE				
	B8800		REPLACES	
	2 - B667	Bronze Bushing	B8800	
	4 - B8607	Washer	B8800A	
	4 - B8609	Seal	Batco	08-140500
	2 - B8611	Washer		
	2 - B8632	Washer		
2 - B8691	Lock			
B8800A				
Wheel End Kit				

CAMSHAFT REPAIR KITS

FOR 15" DIAMETER BRAKES

BENDIX 15" x 4" STEER AXLE BRAKE

	B8795	REPLACES	
	2 - B380 Lock 4 - B667 Bronze Bushing 4 - B8612A Seal 4 - B8629 Washer 4 - B8630 Washer 2 - B8689 Lock 2 - B8719 Washer	B8795	B8795A
		Automann 110.2501 Batco 08-137800 BWP M-K96 Euclid E-7235 Haldex CQ67138 Leland Meritor R615016 Spicer 43-7064	08-137850 K-301 43-7064-1
	B8795A		
	Wheel End Kit		

DANA 15" "HA" SERIES FRONT AND LIFT AXLE

	B8801	REPLACES	
	2 - B794 Lock 2 - B8629 Washer 4 - B8750 Bushing 4 - B8751 Seal 2 - B8752 Washer	B8801	B8801A
		Batco 08-138100	08-138150
	B8801A		
	Wheel End Kit		

EATON 15" DRIVE AXLE "EB" AND "ES" SERIES

	B8742	REPLACES	
	2 - B8722 Lock 4 - B8750 Bushing 4 - B8751 Seal 2 - B8752 Washer 2 - B8753 Washer	B8742	B8742A
		Automann 110.2003 Batco 08-137500 BWP M-K78 Eaton 1008325 Euclid E-5140 Haldex CQ66918 Leland K-493 Meritor R615013 Spicer 43-7060	08-137550 E-5140-2 K-264 43-7060-1
	B8742A		
	Wheel End Kit		

CAMSHAFT REPAIR KITS

FOR 15", 16-1/4" AND 16-1/2" DIAMETER BRAKES

EATON 15" "REDUCED ENVELOPE" AND 16-1/2" "ES" SERIES BRAKES					
	B8746		REPLACES		
			B8746		
			B8746A		
B8746A		Wheel End Kit			
B8746Z		B8746Z		B8746ZA	
B8746ZA		Wheel End Kit			

MERITOR 15" "T" SERIES FRONT BRAKE WITH 1-1/4" CAMSHAFT					
	B8743		REPLACES		
			B8743		
			B8743A		
B8743A		Wheel End Kit			

MERITOR 15" AND 16-1/4" "T" SERIES FRONT BRAKE WITH 1-1/2" CAMSHAFT					
	RC-1		REPLACES		
			RC-1		
			RC-1A		
RC-1A		Wheel End Kit			
RC-1Z		RC-1Z		RC-1ZA	
RC-1ZA		Wheel End Kit			

CAMSHAFT REPAIR KITS

FOR 15" AND 16-1/2" DIAMETER BRAKES

MERITOR 15" "Q" SERIES FRONT BRAKE

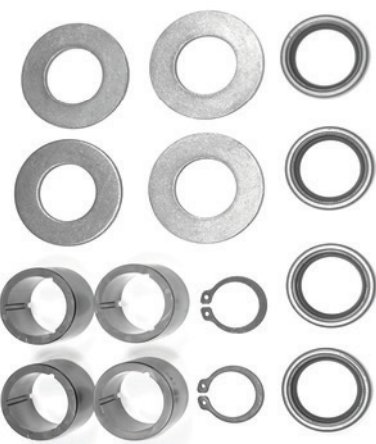
	B8744		REPLACES		
	2 - B794	Lock	B8744		
	4 - B8757	Washer	B8744A		
	4 - B8760	Bushing	Automann	110.2205	
	4 - B8761	Seal	Batco	08-136100	08-136150
			BWP	M-K87	
			Euclid	E-3876	E-3876-2
			Haldex	CQ62768	
			Leland	K-285	
			Meritor		KIT 8022
			Spicer	43-7059	43-7059-1
	B8744A				
	Wheel End Kit				

MERITOR 15" AND 16-1/2" DRIVE AXLES "Q" AND "Q-PLUS" SERIES

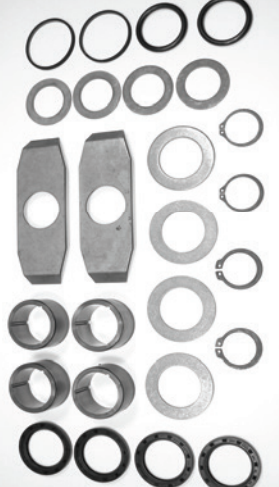
	B8707		REPLACES		
	2 - B793	Lock	B8707		
	4 - B988	Washer	B8707A		
	4 - B8600A	Bushing	Automann	110.2207	
	4 - B8609	Seal	Batco	08-131800	08-131850
	2 - B8621	O-Ring	BWP	M-K81	
	2 - B8689	Lock	Euclid	E-3993B	E-3993B-2
	2 - B8690	Gasket	Haldex	CQ67387	
	2 - B8718	Washer	Leland	K-81	K-48
	4 - B8719	Washer	Meritor	KIT 8042	
		Spicer	43-7048	43-7048-1	
	B8707A				
	Wheel End Kit				
	B8707Z		B8707Z		
	2 - B667	Replaces B8600A	Batco	08-131810	B8707ZA
	B8707ZA				
	Wheel End Kit				

BENDIX 16-1/2" DRIVE AXLE BRAKE

	B8796		REPLACES		
	2 - B380	Lock	B8796		
	4 - B667	Bronze Bushing	B8796A		
	4 - B8609	Seal	Automann	110.2502	
	4 - B8629	Washer	Batco	08-137900	08-137950
	2 - B8630	Washer	BWP	M-K97	
	2 - B8689	Lock	Euclid	E-7241	
	2 - B8718	Washer	Haldex	CQ67100	
	2 - B8719	Washer	Leland		K-302
			Meritor	R615017	
		Spicer	43-7065	43-7065-1	
	B8796A				
	Wheel End Kit				

CAMSHAFT REPAIR KITS

FOR 16-1/2" DIAMETER BRAKES

DANA 16-1/2" DRIVE AXLE - "XTRA-LIFE" SERIES

	B8802	REPLACES	
	2 - B380 Lock 4 - B8600A Bushing 4 - B8607 Washer 4 - B8609 Seal 2 - B8629 Washer	B8802	B8802A
		Batco 08-138200	08-138250
	B8802A		
	Wheel End Kit		

DANA 16-1/2" TRAILER AXLE - "FT", "FC" AND "XTRA-LIFE" SERIES

	B8652	REPLACES		
	2 - B793 Lock 4 - B988 Washer 2 - B8602 Bushing 4 - B8604 Lock 2 - B8606 Bushing 2 - B8607 Washer 2 - B8611 Washer 4 - B8612A Seal 2 - B8632 Washer 2 - B8689 Lock	B8652	B8652A	
		Automann 110.2302 Batco 08-132100 BWP M-K23 Euclid E-2287 Haldex CQ67332 Leland K-343 Meritor R615008 Spicer 43-7032 M16KY20	08-132150 E-2287-2 K-314 43-7032-1	
		B8652A		
	Wheel End Kit			
	B8652Z	B8652Z		
	2 - B807 Replaces B8602			

DANA 16-1/2" "FT", "FC" AND "XTRA-LIFE" WITH RIGID CAM SUPPORT

	B8651	REPLACES	
	2 - B8600 Bushing 2 - B8601 Bushing 4 - B8604 Lock 6 - B8607 Washer 2 - B8608 Washer 4 - B8609 Seal	B8651	B8651A
		Batco 08-132102 BWP M-K22	08-132152
	B8651A		
	Wheel End Kit		

CAMSHAFT REPAIR KITS

FOR 16-1/2" DIAMETER BRAKES

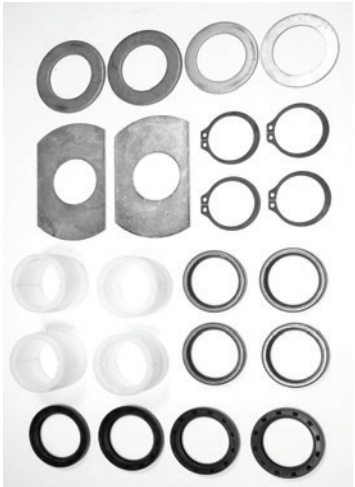
DANA 16-1/2" "FT" AND "FC" SERIES WITH RIGID SUPPORT WITH SEALS				
	B8656		REPLACES	
			B8656	B8656A
	2 - B8600 Bushing 2 - B8602 Bushing 4 - B8604 Lock 2 - B8607 Washer 2 - B8608 Washer 4 - B8609 Seal 4 - B8611 Washer 4 - B8612A Seal		Automann 110.2301 Batco 08-132103 BWP M-K27 Euclid E-2087 Haldex CQ67331 Leland K-346 Meritor R615009 Spicer 43-7029	08-132153 E-2087-2 K-146 43-7029-1
B8656A				
	Wheel End Kit			

DANA 16-1/2" WITH WELD-ON SPIDER				
	B8653		REPLACES	
			B8653	B8653A
	2 - B8600 Bushing 4 - B8604 Lock 2 - B8606 Bushing 6 - B8607 Washer 2 - B8608 Washer 4 - B8612A Seal		BWP M-K24	
B8653A				
	Wheel End Kit			

DANA 16-1/2" "XTRA-LIFE" SERIES WITH 1-1/2" CAMSHAFT				
	B8687		REPLACES	
			B8687	B8687A
	2 - B793 Lock 2 - B807 Bronze Bushing 2 - B988 Washer 4 - B8604 Lock 2 - B8605 Washer 2 - B8606 Bushing 2 - B8607 Washer 4 - B8612A Seal		Automann 110.2308 Batco 08-132110 BWP M-K101 Leland K-348	08-132160 K-327
B8687A				
	Wheel End Kit			

CAMSHAFT REPAIR KITS

FOR 16-1/2" DIAMETER BRAKES

DANA 16-1/2" "XTRA-LIFE II" SERIES TRAILER AXLE				
	B8792		REPLACES	
	2 - B793 Lock 2 - B800 Washer 2 - B801 Spacer 2 - B805 Bronze Bushing 4 - B988 Washer 2 - B8606A Bushing 2 - B8607 Washer 2 - B8622 Lock 4 - B8625 Seal		B8792	
			Automann 110.2303 Batco 08-132800 BWP M-K111 Euclid E-9790A Haldex CQ67111 Leland K-505 Meritor R615019	B8792A 08-132850 E-9790A-2 K-355
	B8792A			
Wheel End Kit				

DANA 16-1/2" "XTRA-LIFE II" SERIES WITH SUPPORT BRACKET				
	B8803		REPLACES	
	2 - B793 Lock 2 - B800 Washer 2 - B801 Spacer 2 - B805 Bronze Bushing 4 - B988 Washer 1 - B8150R Bracket 1 - B8150L Bracket 2 - B8607 Washer 2 - B8622 Lock 4 - B8625 Seal		B8803	
			Automann 110.2010 Batco 08-132803	
	B8803R			
Wheel End Kit		B8803R	B8803L	
		Batco 08-132801	08-132802	
B8803L				
Wheel End Kit				

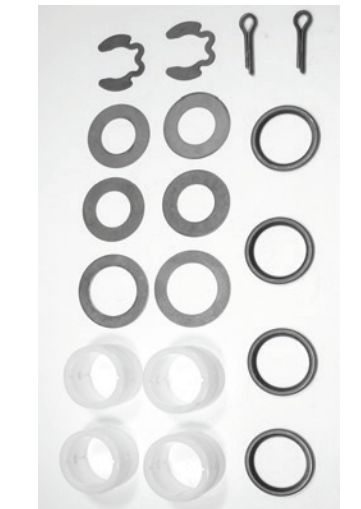
EATON 16-1/2" SELF-CONTAINED DRIVE AXLE BRAKE				
	B8648		REPLACES	
	2 - 5403 Cotter Pin 4 - B8600 Bushing 2 - B8607 Washer 4 - B8612 Seal 2 - B8629 Washer 2 - B8630 Washer 2 - B8722 Lock		B8648	
			Automann 110.2001 Batco 08-135100 BWP M-K19 Eaton 78500 Euclid E-2125 Haldex CQ67326 Leland K-357 Meritor R615002 Spicer 43-7041	B8648A 08-135150 E-2125-2 K-140 43-7041-1
	B8648A			
Wheel End Kit				

CAMSHAFT REPAIR KITS

FOR 16-1/2" DIAMETER BRAKES

EATON 16-1/2" "ES" SERIES DRIVE AXLE

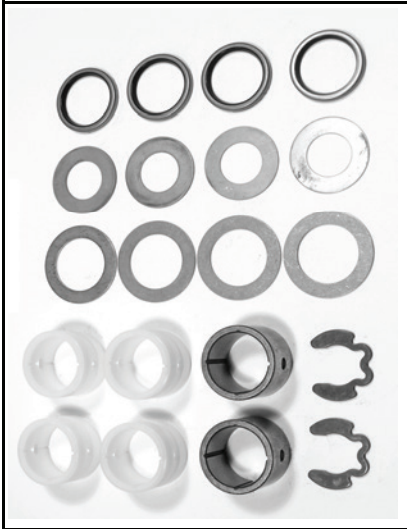
	B8793	REPLACES	
	2 - B667 Bronze Bushing 2 - B8600 Bushing 4 - B8607 Washer 4 - B8612 Seal 2 - B8629 Washer 2 - B8630 Washer 2 - B8722 Lock	B8793	B8793A
		Automann 110.2007 Batco 08-135110 BWP M-K116 Eaton 1008047 Euclid E-9053 Haldex CQ67412 Leland Meritor R615018 Spicer 43-7068	08-135160 K-312 43-7068-1
	B8793A		
	Wheel End Kit		

EATON 16-1/2" - 5" ROUND AXLE BOLT-ON SPIDER

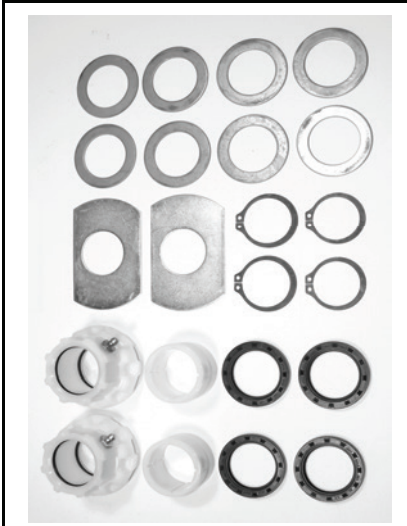
	B8657	REPLACES	
	2 - B8600 Bushing 2 - B8604 Lock 8 - B8607 Washer 2 - B8608 Washer 4 - B8609 Seal 2 - B8616 Bushing 2 - B8622 Lock	B8657	B8657A
		Automann 110.2008 Batco 08-130800 BWP M-K62 Euclid E-2089 Haldex CQ67384 Leland Spicer 43-7042	08-130850 K-138 43-7042-1
	B8657A		
	Wheel End Kit		

EATON 16-1/2" - 5" SQUARE AXLE WELD-ON SPIDER

	B8647	REPLACES	
	2 - B8600 Bushing 2 - B8604 Lock 8 - B8607 Washer 4 - B8612 Seal 2 - B8616 Bushing 2 - B8622 Lock	B8647	B8647A
		Automann 110.2009 Batco 08-130801 BWP M-K18 Euclid E-2123 Haldex CQ67325 Leland Meritor R615003	08-130851 K-139
	B8647A		
	Wheel End Kit		

CAMSHAFT REPAIR KITS

FOR 16-1/2" DIAMETER BRAKES

EATON 16-1/2" "EB" AND "ES" SERIES BRAKE

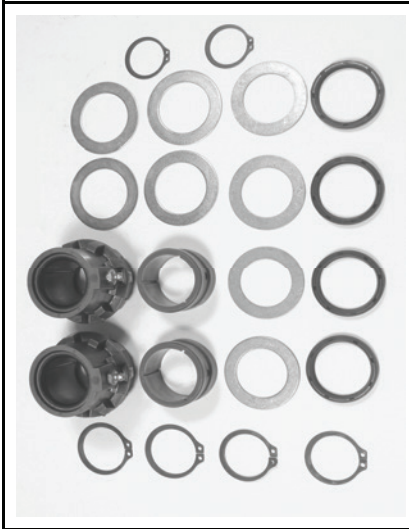
	B8684	REPLACES	
	2 - B793 Lock 2 - B8604 Lock 4 - B8607 Washer 4 - B8619 Washer 2 - B8622 Lock 4 - B8625 Seal 2 - B8688 Bushing 2 - B8698 Bushing	B8684	B8684A
		Automann 110.2002 Batco 08-136400 BWP M-K63 Eaton 1008347 Euclid E-2696A Haldex CQ67354 Leland K-360 Meritor R615004 Spicer 43-7043A	08-136450 E-2696A-2 K-141 43-7043A-1
	B8684A		
	Wheel End Kit		

FRUEHAUF 16-1/2" "PROPAR" "F" SERIES BRAKE

	B8650	REPLACES	
	2 - B8604 Lock 2 - B8607 Washer 6 - B8619 Washer 4 - B8620 Bushing 2 - B8622 Lock 2 - B8623 Bushing	B8650	B8650A
		Automann 110.2102 Batco 08-133101 BWP M-K21 Euclid E-2122 Fruehauf 305680-900 Haldex CQ66740 Leland Meritor R615006 Spicer 43-7038	08-133151 E-2122-2 K-52 43-7038-1
	B8650A		
	Wheel End Kit		

FRUEHAUF 16-1/2" "PROPAR" "XEM" AND "FQ" SERIES BRAKE

	B8649	REPLACES	
	2 - B8604 Lock 2 - B8607 Washer 6 - B8619 Washer 4 - B8620 Bushing 2 - B8622 Lock 2 - B8624 Bushing	B8649	B8649A
		Automann 110.2101 Batco 08-133100 BWP M-K20 Euclid E-2090 Fruehauf AXA0420-900 Haldex CQ67324 Leland K-88 Meritor R615005 Spicer 43-7039	08-133150 E-2090-2 K-108 43-7039-1
	B8649A		
	Wheel End Kit		

CAMSHAFT REPAIR KITS

FOR 16-1/2" DIAMETER BRAKES

HENDRICKSON 16-1/2" STANDARD "INTRAAX" SERIES BRAKE				
	B8790		REPLACES	
	2 - B795	Lock	B8790	
	2 - B807	Bronze Bushing	Batco	08-130301
	2 - B988	Washer	BWP	M-K107
	2 - B8608	Washer	Euclid	E-9791
	8 - B8610	Washer	Haldex	CQ67414
4 - B8611	Washer	Hendrickson	S-21181	
4 - B8612	Seal	Leland	K-506	
2 - B8691	Lock	Meritor	R615020	
2 - B8696	Bracket	Spicer	43-7090	
B8790A		B8790A		B8790A
Wheel End Kit				
B8790HD		B8790HD		B8790HDA
2 - B8696HD Replaces B8696		Euclid	E-9791HD	
B8790HDA		Meritor	R615022	
Wheel End Kit				

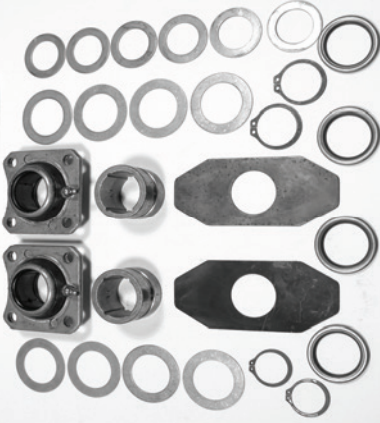
HENDRICKSON 16-1/2" "INTRAAX" "HXS" SERIES BRAKE				
	B8794		REPLACES	
	4 - B717	Seal	B8794	
	2 - B793	Lock	Automann	110.2220
	2 - B806	Bronze Bushing	Batco	08-130311
	6 - B988	Washer	Euclid	E-11450
	2 - B8604	Lock	Haldex	CQ67444
8 - B8607	Washer	Hendrickson	S-23974	
2 - B8696	Bracket	Leland	K-481	
2 - B8721	Washer	Meritor	R615023	
B8794A		Meritor	R615023	B8794A
Wheel End Kit				
B8794HD		B8794HD		B8794HDA
2 - B8696HD Replaces B8696		Euclid	E-11450HD	E-11450HD-2
B8794HDA		Meritor	R615024	
Wheel End Kit				

HENDRICKSON 16-1/2" "INTRAAX" SERIES BRAKE WITH CAM TUBE					
	B8805		REPLACES		
	Parts Not Sold Separately				
			Automann	110.2505	
			BWP	M-K134	
			Euclid	E-11897	
			Haldex	CQ67443	
		Hendrickson	S-26348		
		Leland	K-503		
		Meritor	R615025		

CAMSHAFT REPAIR KITS

FOR 16-1/2" AND 18" DIAMETER BRAKES

MACK 16-1/2" AND MERITOR 16-1/2" AND 18" "P" SERIES AXLES

	B8646	REPLACES	
	4 - B8600A Bushing 2 - B8604 Lock 2 - B8605 Washer 2 - B8607 Washer 2 - B8608 Washer 4 - B8609 Seal 2 - B8690 Gasket 2 - B8691 Lock	B8646	B8646A
	B8646A	Automann 110.2201 Batco 08-130200 BWP M-K17 Euclid E-2086B Haldex CQ67327 Meritor KIT 9078 Spicer 43-7047	08-130250 E-2086B-2 KIT 9078A 43-7047-1
	B8646A		
	Wheel End Kit		

MACK 16-1/2" "P" SERIES DRIVE AXLE

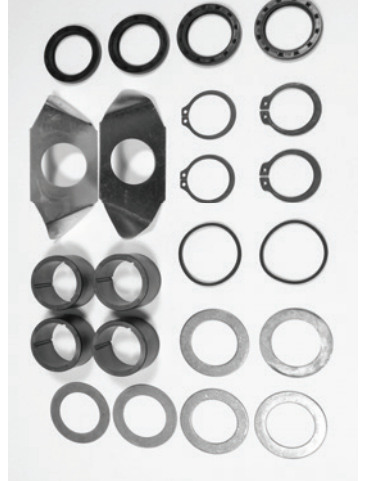
	B8804	REPLACES	
	4 - B8600A Bushing 2 - B8604 Lock 2 - B8605 Washer 4 - B8607 Washer 4 - B8609 Seal 2 - B8690 Seal 2 - B8691 Lock 2 - B8781 Washer	B8804	B8804A
	B8804A	Batco 08-137400	08-137450
	B8804A		
	Wheel End Kit		

MACK 16-1/2" WITH MERITOR 50,000# "Q" SERIES REAR AXLE

	B8745	REPLACES	
	2 - B793 Lock 4 - B988 Washer 4 - B8600A Bushing 4 - B8609 Seal 2 - B8689 Lock 2 - B8690 Gasket 2 - B8719 Washer 2 - B8781 Washer	B8745	B8745A
	B8745A	Automann 110.2504 Batco 08-137300 Euclid E-5094A Haldex CQ66939	08-137350
	B8745A		
	Wheel End Kit		

CAMSHAFT REPAIR KITS

FOR 16-1/2" DIAMETER BRAKES

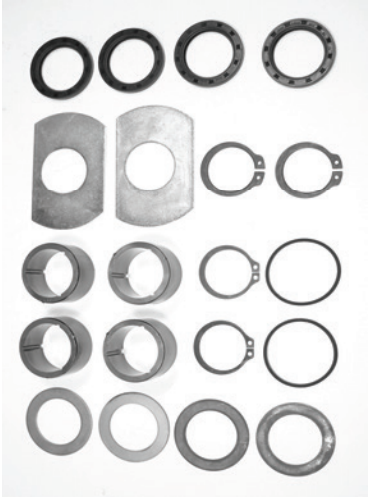
MERITOR 16-1/2" AND 18" "P" SERIES FRONT AND DRIVE AXLE			
	B8646	REPLACES	
	4 - B8600A Bushing 2 - B8604 Lock 2 - B8605 Washer 2 - B8607 Washer 2 - B8608 Washer 4 - B8609 Seal 2 - B8690 Gasket 2 - B8691 Lock	B8646	B8646A
	<div style="text-align: center; background-color: black; color: white; padding: 2px;">B8646A</div> Wheel End Kit	Automann 110.2201 Batco 08-130200 BWP M-K17 Euclid E-2086B Haldex CQ67327 Meritor KIT 9078 Spicer 43-7047	08-130250 E-2086B-2 KIT 9078A 43-7047-1

MERITOR 16-1/2" "P" SERIES TRAILER BRAKE (LESS BRACKET ASSEMBLY)			
	B8644	REPLACES	
	4 - B8604 Lock 8 - B8610 Washer 4 - B8621 O-Ring 2 - B8636 Bushing 2 - B8660 Assembly 2 - B8691 Lock	B8644	B8644A
	<div style="text-align: center; background-color: black; color: white; padding: 2px;">B8644A</div> Wheel End Kit	Batco 08-130100 BWP M-K15 Euclid E-2363 Haldex CQ67764 Leland Meritor KIT 969 Spicer 43-7044A	08-130150 K-149 43-7044A-1

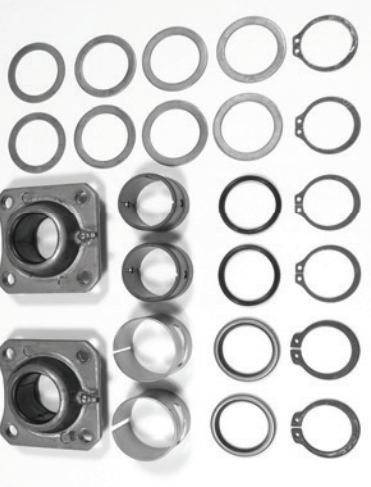
MERITOR 16-1/2" "P" SERIES TRAILER BRAKE WITH 1-1/2" CAMSHAFT			
	B8681	REPLACES	
	4 - B8604 Lock 8 - B8610 Washer 2 - B8660 Assembly 2 - B8696 Bracket 2 - B8691 Lock	B8681	B8681A
	<div style="text-align: center; background-color: black; color: white; padding: 2px;">B8681A</div> Wheel End Kit	Automann 110.2216 Batco 08-130101 BWP M-K14 Euclid E-2088A Haldex CQ67328 Leland K-368 Meritor KIT 8046 Spicer 43-7044	08-130151 K-268 43-7044-1
<div style="text-align: center; background-color: black; color: white; padding: 2px;">B8681HD</div> 2 - B8696HD Replaces B8696	Euclid E-2088AHD	B8681HDA E-2088AHD-2	
<div style="text-align: center; background-color: black; color: white; padding: 2px;">B8681HDA</div> Wheel End Kit			

CAMSHAFT REPAIR KITS

FOR 16-1/2" DIAMETER BRAKES

MERITOR 16-1/2" "P" SERIES TRAILER BRAKE WITH "TKL" SERIES AXLE					
	B8686		REPLACES		
			B8686	B8686A	
	4 - B8604	Lock	Batco	08-130111	08-130161 K-152 43-7046-1
	2 - B8609	Seal	BWP	M-K65	
	8 - B8610	Washer	Euclid	E-2679A	
	2 - B8613	Quad-Ring	Haldex	CQ67385	
2 - B8665	Bushing	Leland			
2 - B8691	Lock	Meritor	KIT 9035		
2 - B8696	Bracket	Spicer	43-7046		
B8686A					
Wheel End Kit					
B8686HD		B8686HD			
2 - B8696HD	Replaces B8696	Automann	110.2213		
		Euclid	E-2679AHD		

MERITOR 16-1/2" "P" SERIES TRAILER BRAKE					
	B8643		REPLACES		
			B8643	B8643A	
	2 - B8603	Bushing	Automann	110.2212	08-130172 K-51
	4 - B8604	Lock	Batco	08-130122	
	2 - B8605	Washer	BWP	M-K13	
	6 - B8607	Washer	Euclid	E-1357A	
2 - B8608	Washer	Haldex	CQ67329		
2 - B8635	Bushing	Leland			
2 - B8691	Lock				
B8643A					
Wheel End Kit					

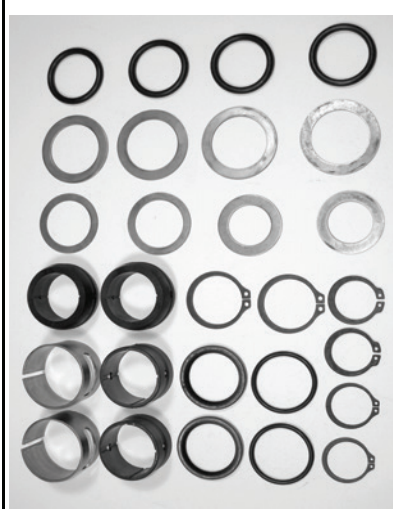
MERITOR 16-1/2" 4000-6000 TRAILER AXLE WITHOUT SUPPORT BRACKET					
	B8645		REPLACES		
			B8645	B8645A	
	2 - B793	Lock	Automann	110.2215	08-130650 K-53 43-7037-1
	4 - B960	Washer	Batco	08-130600	
	2 - B988	Washer	BWP	M-K16	
	2 - B8610	Washer	Euclid	E-2382	
4 - B8621	O-Ring	Haldex	CQ67334		
2 - B8622	Lock	Leland	K-97		
2 - B8636	Bushing	Meritor	KIT 970		
2 - B8661	Assembly	Spicer	43-7037		
2 - B8689	Lock				
B8645A					
Wheel End Kit					
B8645Z		B8645Z			
2 - B8661Z	Replaces B8661	Batco	08-130620	08-130670	
B8645ZA					
Wheel End Kit					

CAMSHAFT REPAIR KITS

FOR 16-1/2" DIAMETER BRAKES

MERITOR 16-1/2" 4000-6000 TRAILER AXLE WITH SUPPORT BRACKET				
	B8683		REPLACES	
	2 - B793	Lock	B8683	
	4 - B960	Washer	B8683A	
	2 - B988	Washer	Automann	110.2204
	2 - B8610	Washer	Batco	08-130601
	2 - B8622	Lock	BWP	M-K61
2 - B8661	Assembly	Euclid	E-3520A	
2 - B8689	Lock	Haldex	CQ67386	
2 - B8696	Bracket	Leland	K-270	
B8683A		Meritor	KIT 8048	
Wheel End Kit		Spicer	43-7037A	43-7037A-1
B8683HD		B8683HD		B8683HDA
2 - B8696HD Replaces B8696		Euclid	E-3520AHD	E-3520AHD-2
B8683HDA		Meritor	R003520AHD	
Wheel End Kit				

MERITOR 16-1/2" 4000-6000 TRAILER AXLE WITH BRONZE BUSHING				
	B8683Z		REPLACES	
	2 - B793	Lock	B8683Z	
	4 - B960	Washer	B8683ZA	
	2 - B988	Washer	Batco	08-130621
	2 - B8610	Washer	Leland	K-489
	2 - B8622	Lock		
2 - B8661Z	Bushing Assembly			
2 - B8689	Lock			
2 - B8696	Bracket			
B8683ZA				
Wheel End Kit				

MERITOR 16-1/2" 4000-6000 TRAILER AXLE (ALTERNATE FOR B8683)				
	B8747		REPLACES	
	2 - B793	Lock	B8747	
	4 - B960	Washer	B8747A	
	2 - B988	Washer	BWP	M-K85
	2 - B8610	Washer	Haldex	CQ65517
	2 - B8622	Lock	Spicer	43-7037B
2 - B8689	Lock			
2 - B8696	Bracket			
2 - B8698	Bushing			
4 - B8764	Seal			
B8747A				
Wheel End Kit				
B8747HD		B8747HD		B8747HDA
2 - B8696HD Replaces B8696		Automann	110.2206	
B8747HDA		Euclid	E-3989AHD	E-3989AHD-2
Wheel End Kit				

CAMSHAFT REPAIR KITS

FOR 16-1/2" DIAMETER BRAKES

MERITOR 16-1/2" "Q" AND "Q-PLUS" SERIES MINOR KIT

	B8766	REPLACES	
	4 - B8600A Bushing 4 - B8609 Seal	Automann 110.2208 Batco 02-2101 Euclid E-5513 Haldex CQ66940 Meritor KIT 8033 (2) Spicer 43-7048A	

MERITOR 16-1/2" "Q" SERIES DRIVE AXLE WITH OFFSET SPIDER

	B8771	REPLACES	
	4 - B8600A Bushing 4 - B8604 Lock 2 - B8605 Washer 2 - B8607 Washer 4 - B8609 Seal 2 - B8690 Gasket 2 - B8691 Lock 2 - B8781 Washer 2-1/2" Spider Offset	B8771	B8771A
	Automann 110.2211 Euclid E-9080 Haldex CQ67413 Leland	K-310	
	B8771A		
	Wheel End Kit		

MERITOR 16-1/2" "Q" AND "Q-PLUS" TRAILER AXLES WITH PRESS-IN BUSHING

	B8772M	REPLACES	
	2 - B793 Lock 4 - B960 Washer 2 - B961 Washer 4 - B988 Washer 2 - B8610 Washer 2 - B8622 Lock 4 - B8625 Seal 2 - B8634A Lock 2 - B8689 Lock 2 - B8696 Bracket 2 - B8782 Bronze Bushing 2 - B8786 Washer 2 - B8787 Washer	B8772M	B8772MA
	Automann 110.2209 Batco 08-130631 BWP M-K89 Euclid E-9078 Haldex CQ67128 Leland K-490 Meritor KIT 8058 Spicer 43-7071	08-130681 43-7071-1	
	B8772MA		
	Wheel End Kit		

CAMSHAFT REPAIR KITS

FOR 16-1/2" DIAMETER BRAKES

MERITOR 16-1/2" "Q" AND "Q-PLUS" TRAILER AXLES WITH PRESS-IN BUSHING

	B8772MHD		REPLACES	
	4 - B960 Washer		B8772MHD	
	2 - B961 Washer		Euclid	E-9078HD
	4 - B988 Washer			
	2 - B8610 Washer			B8772MHDA
	2 - B8622 Lock			E-9078HD-2
	4 - B8625 Seal			
	2 - B8634A Lock			
	2 - B8689 Lock			
	2 - B8696HD Bracket			
	2 - B8782 Bronze Bushing			
	2 - B8786 Washer			
	2 - B8787 Washer			
	B8772MHDA			
	Wheel End Kit			





MERITOR 16-1/2" "Q" AND "Q-PLUS" TRAILER AXLES MINOR KIT

	B8788		REPLACES	
	2 - B8625 Seal		Automann	110.2217
	1 - B8634A Lock		BWP	M-K90
	1 - B8783 Bracket		Euclid	E-6078
	1 - B8784 Washer		Haldex	CQ66941
			Leland	K-491
			Meritor	KIT 8289
			Spicer	43-7072A



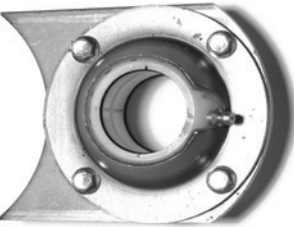
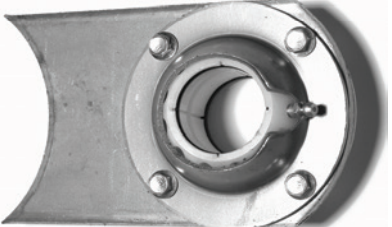
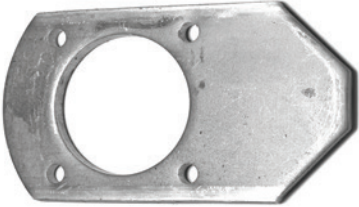

MERITOR 16-1/2" "Q" AND "Q-PLUS" TRAILER AXLES WITH BOLT-ON BUSHING

	B8773M		REPLACES	
	2 - B793 Lock		B8773M	
	2 - B988 Washer		Automann	110.2210
	2 - B8610 Washer		Batco	08-130611
	4 - B8625 Seal		BWP	M-K88
	2 - B8634A Lock		Euclid	E-9079
	2 - B8689 Lock		Haldex	CQ67416
	2 - B8696 Bracket		Leland	K-363
	2 - B8783 Bracket		Meritor	KIT 8091
	2 - B8784 Washer		Spicer	43-7072
	2 - B8785 Washer			
	B8773MA			
	Wheel End Kit			
	B8773MHD		B8773MHD	B8773MHDA
	2 - B8696HD Replaces B8696		Euclid	E-9079HD
	B8773MHDA			
	Wheel End Kit			





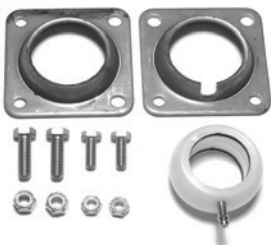
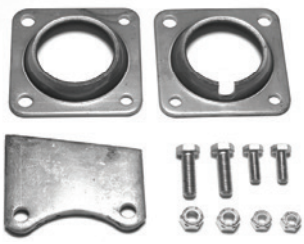

CAMSHAFT SUPPORT BRACKETS

PART NO.	NOTES	REPLACES
 B8733	For Spicer And Standard Forge 12-1/4" Brakes Includes B8606 Bushing	Batco 03-115 BWP M-1556 Euclid E-2103 Leland L-1718 Meritor R630002 Spicer M12WH112X Std Forge 209999-019
 B8714	For Spicer And Standard Forge 16-1/2" Brakes Includes B8606 Bushing	Automann 111.0006 Batco 03-114 BWP M-1554 Euclid E-2104 Leland L-1198 Meritor R630003 Spicer 30-1357 M16WH113X Std Forge 209999-018
 B8735	For Meritor 4" x 6" Axles Mounting Screws Not Included	Automann 110.0010 Batco 03-261 BWP M-1553 Euclid E-1319A Leland L-1649 Meritor KIT 1759 Spicer 30-1361
 B8736	For Meritor 5" Round Axles Plate Only, Bushing Assembly And Mounting Screws Not Included	Batco 03-260 BWP M-2627 Euclid E-2477B Leland L-1642 Meritor A3299T5844
 B8713	For Early Meritor Axles Use With B8603 Bushing	Batco 03-250 BWP M-1572 Euclid E-603 Leland L-242 Meritor 1205N430 Spicer 30-1362
 B8717	For Spicer And Standard Forge Used On B8733 And B8714 Brackets	Batco 03-119 BWP M-2645 Euclid E-2365 Leland L-2387 Meritor R630005 Spicer 30-1385 Std Forge 209108-001







CAMSHAFT SUPPORT BRACKETS

PART NO.	NOTES	REPLACES
 B8734	For Fruehauf	Batco 03-251 BWP M-1048 Fruehauf AXA0430-1 Leland L-899 Spicer 30-1363
 B8728	For Fruehauf 16-1/2" Axle Bracket	Automann 111.0002 Batco 03-273 BWP M-2595 Euclid E-4586 Fruehauf ACF4024-1 Leland L-2712 Meritor R630006 Spicer 30-1392
 B8727	For Fruehauf 12-1/4" And 16-1/2" Brakes	Automann 111.0003 Batco 03-272 Euclid E-4587 Fruehauf ACF4021-1 ACF4022-1 Leland L-2711 Meritor R630007
 B8727A	For Fruehauf 12-1/4" And 16-1/2" Brakes B8727 Assembly And B8624 Bushing	Batco 03-279 BWP M-2594 Spicer 30-1390
 B8725	For Fruehauf 16-1/2" Brakes Includes B8728 Bracket And B8727 Assembly	Batco 03-270 Leland L-2707
 B8725A	Same As Above Except Includes B8624 Bushing	Automann 111.0004 Batco 03-278 Euclid E-4594 Fruehauf ACF4024-900 Leland L-3040 Meritor R630009

CAMSHAFT BUSHINGS

PART NO.	NOTES	REPLACES
	For Meritor Trailer Axles	Automann 111.0001 Batco 03-209 BWP M-1521 Euclid E-1318A/HD Leland L-2854 Meritor A3105V282 Spicer 30-1358
B8696 or B8696HD		
	Retro-Fit Camshaft Support Bushing Assembly	Automann 111.0012 Batco 03-2082 Euclid E-11445 Leland L-3485 Meritor R0011445 Spicer 30-1341L M10WH150L
B8150L	Greasable	
	Retro-Fit Camshaft Support Bushing Assembly	Automann 111.0011 Batco 03-2081 Euclid E-11446 Leland L-3484 Meritor R0011446 Spicer 30-1341R M10WH150R
B8150R	Greasable	
	Outside Diameter 1-5/8" Inside Diameter 1-1/4" Length 1-3/16" Nylon For Meritor 15" "Q" Front Brakes	Automann 112.1082 Batco 02-244 BWP M-3237 Euclid E-3877 Leland L-2939 Meritor 1225R1136 Spicer 28-1265
B8760		
	Outside Diameter 1-7/8" Inside Diameter 1-1/2" Length 1-3/16" Greaseless Nylatron For Meritor Drive Axles	Automann 112.1161 Batco 02-210 Euclid E-5512 Leland L-3029 Meritor 1225L1208
B8600A		
	Outside Diameter 1-7/8" Inside Diameter 1-1/2" Length 1-1/4" Nylon	Automann 112.1162 Batco 02-202 BWP M-571 Euclid E-536 Leland L-166 Spicer 28-1233
B8600		







CAMSHAFT BUSHINGS

PART NO.	NOTES	REPLACES
 B667	Outside Diameter 1-7/8" Inside Diameter 1-1/2" Length 1-1/4" Bronze Replaces B8600	Automann 112.1163 Batco 02-211 BWP M-1551 Euclid E-667 Leland L-330 Meritor 1225R512 Std Forge 405106
 B8602	Outside Diameter 1-7/8" Inside Diameter 1-1/2" Length 1-1/2" Nylon For Standard Forge And Spicer	Automann 112.1164 Batco 02-203 BWP M-571B Euclid E-759 Leland L-1536 Meritor R617003 Spicer M10WJ109 Std Forge 405129
 B807	Outside Diameter 1-7/8" Inside Diameter 1-1/2" Length 1-1/2" Bronze Version Of B8602	Automann 112.1168 Batco 02-204 BWP M-2548 Euclid E-807 Leland L-402 Meritor R657001 Spicer 28-1231 M16HD100
 B8601	Outside Diameter 1-7/8" Inside Diameter 1-1/2" Length 2" Nylon For Standard Forge And Spicer	Automann 112.11615 Batco 03-201 BWP M-571A Euclid E-661 Leland L-266 Meritor R617001 Spicer 28-1257 M10WJ178 Std Forge 405109
 B806	Outside Diameter 2" Inside Diameter 1-1/2" Length 1-1/2" Bronze For Hendrickson "Intraax"	Batco 02-257 Euclid E-11449
 B8782	Outside Diameter 2" Inside Diameter 1-5/8" Length 1" Powdered Metal For Meritor Cast Spiders	Automann 112.1201 Batco 02-246 BWP M-3247 Euclid E-6080 Leland L-2942 Meritor 1225N1158







CAMSHAFT BUSHINGS

PART NO.	NOTES	REPLACES
 B8698	Outside Diameter 2" Inside Diameter 1-5/8" Length 1-3/16" Nylon For Eaton "501" Brake	Automann 112.1203 Batco 02-224 BWP M-2621 Eaton 1008412 Euclid E-2690A Leland L-2382 Meritor R617005 Spicer 28-1238
 B805	Outside Diameter 2" Inside Diameter 1-5/8" Length 1-1/2" Bronze For Spicer 16-1/2" Brakes With 1-5/8" Cam Journal	Automann 112.1204 Batco 02-256 BWP M-3747 Euclid E-9789 Leland L-3127 Meritor R627034 Spicer M16HD106
 B8636	Outside Diameter 2-1/8" Inside Diameter 1-1/2" Length 1" Nylon For Use In B8696	Automann 112.11610 Batco 03-212 BWP M-1550 Euclid E-2361 Leland L-1730 Meritor 1225R1058 Spicer 27-1197
 B8699	Outside Diameter 2-15/32" Inside Diameter 1-1/2" Length 1-1/2" Nylon For Spicer Late Model	Automann 112.11611 Batco 03-210 BWP M-2622 Euclid E-2517 Leland L-1711 Meritor R617008 Spicer 27-1191 M10WJ100
 B8606	Outside Diameter 2-15/32" Inside Diameter 1-1/2" Length 1-3/4" Nylon For Standard Forge And Spicer	Automann 112.1165 Batco 03-208 BWP M-582 Euclid E-2102 Meritor R617002 Spicer 27-1195 M10WJ107 Std Forge 405128
 B8606A	Outside Diameter 2-15/32" Inside Diameter 1-1/2" Length 1-3/4" Greaseless Nylatron Replaces B8606	Automann 112.1166 BWP M-3748 Euclid E-9792A Leland L-3146 Spicer M10WJ237X





CAMSHAFT BUSHINGS

PART NO.	NOTES	REPLACES
 B8624	Outside Diameter 2-1/2" Inside Diameter 1-19/32" Length 1-1/2" Nylon For Propar Late Model	Automann 112.1191 Batco 03-207 BWP M-1058 Euclid E-1577A Fruehauf ACD2285-900 Leland L-1191 Meritor R617009 Spicer 27-1194
 B8754	Outside Diameter 1-7/8" Inside Diameter 1-1/4" Length 1-5/32" Nylon For Meritor "T" Brakes	Automann 112.1081 Batco 02-233 BWP M-2618 Euclid E-3447 Leland L-1746 Meritor 1225M897 Spicer 28-1263
 B8750	Outside Diameter 1-7/8" Inside Diameter 1-1/4" Length 1-5/16" Nylon For Eaton 15" x 4" Front Brake	Automann 112.1083 Batco 02-225 BWP M-3351 Eaton 1008220 Euclid E-5127 Leland L-2831 Meritor R627029 Spicer 28-1264
 B8616	Outside Diameter 2-3/4" Inside Diameter 1-1/2" Length 2" Nylon For Eaton	Automann 112.11614 Batco 03-202 BWP M-999 Eaton B2028A Euclid E-1385 Leland L-1594 Meritor R627009 Spicer 27-1199
 B8603	Outside Diameter 2-3/4" Inside Diameter 1-1/2" Length 2-1/2" Nylon For Early Meritor	Automann 112.11616 Batco 03-200 BWP M-572 Euclid E-535 Leland L-167 Spicer 27-1200
 B8688	Outside Diameter 2-3/4" Inside Diameter 1-1/2" Length 2-1/2" Nylon For Eaton "501" Brake Includes Seals	Automann 112.1167 Batco 03-214 BWP M-2623 Eaton 1002262 Euclid E-2695 Leland L-1598 Meritor R617006 Spicer 27-1196







CAMSHAFT BUSHINGS

PART NO.	NOTES	REPLACES
 B8623	Outside Diameter 2-7/8" Inside Diameter 1-19/32" Length 2-1/2" Nylon For Fruehauf Propar	Automann 112.1192 Batco 03-206 BWP M-1047 Euclid E-1571 Fruehauf AXA0429-900 Leland L-898 Meritor R617007 Spicer 27-1198
 B8665	Outside Diameter 1-7/8" Inside Diameter 1-1/2" Length 1-23/32" Nylon For Meritor TKL Axles	Automann 112.11613 Batco 02-232 BWP M-1400 Euclid E-2551 Leland L-1641 Meritor 1225X804 Spicer 28-1260
 B8620	Outside Diameter 2" Inside Diameter 1-5/8" Length 7/8" Nylon - White Use (2) Per Spider	Automann 112.1206 Batco 02-220 BWP M-1049 Euclid E-1567 Fruehauf AXA0413-900 Leland L-896 Meritor R657003 Spicer 28-1237
 B8783	Inside Diameter 1-5/8" Length 1-13/16" Powdered Metal For Meritor Fabricated Spider Includes Mounting Screws	Automann 112.1205 Batco 02-2481 Euclid E-6076 Leland L-3033/43 Meritor KIT 1760 (1/2) A3105L1078
 B8635	Outside Diameter 1-7/8" Inside Diameter 1-1/2" Length 7/8" Nylon - Yellow/White For Meritor And Fruehauf	Automann 112.11612 Batco 02-200/1 BWP M-1520 Euclid E-943 Fruehauf ACA3265/6 Leland L-752 Meritor R000943 Spicer 28-1235
 B8660	Bushing Assy For 1-1/2" Camshaft For Meritor 5000 Series Axle Consists Of: 1 - B8615 Outer Bushing 1 - B8614 Inner Bushing 1 - B8613 Seal 1 - B8612 Seal	Automann 110.2219 Batco 02-218 BWP M-1407 Euclid E-2291 Leland L-891 Meritor KIT 9036 Spicer 28-1255

CAMSHAFT BUSHINGS

PART NO.	NOTES	REPLACES
 B8615	Outer Diameter 1-7/8" Inner Diameter 1-3/4" Length 1-5/16" Steel For Use In B8660 Assembly	Automann 112.1241 Batco 02-230 BWP M-847 Euclid E-2380 Leland L-1766 Meritor 1225A781 Spicer 28-1252
 B8614	Outer Diameter 1-3/4" Inner Diameter 1-1/2" Length 1-3/16" Nylon For Use In B8660 Assembly	Automann 112.1169 Batco 02-231 BWP M-826 Euclid E-1271 Leland L-1767 Meritor 1225J634 Spicer 28-1253
 B8661	Bushing Assy For 1-5/8" Camshaft For Meritor 4000-6000 Axles Consists Of: 1 - B8628 Outer Bushing 1 - B8627 Inner Bushing 1 - B8626 Seal 1 - B8625 Seal	Automann 110.2218 Batco 02-240 BWP M-1406 Euclid E-2670 Leland L-1305 Meritor KIT 9034 Spicer 28-1243
 B8628	Outer Diameter 2" Inner Diameter 1-7/8" Length 1-5/16" Steel For Use In B8661 Assembly	Automann 112.1281 Batco 02-241 BWP M-1405 Euclid E-2407 Leland L-1294 Meritor 1225A833 Spicer 28-1240
 B8627	Outer Diameter 1-7/8" Inner Diameter 1-5/8" Length 1-1/8" Nylon For Use In B8661 Assembly	Automann 112.1202 Batco 02-242 BWP M-1404 Euclid E-2408 Leland L-1296 Meritor 1225B834 Spicer 28-1241



CAMSHAFT SEALS

	PART NO.	O.D.	I.D.	THK	REPLACES
	B8613	1-3/4"	1-31/64"	1/8"	Automann 113.1242 Batco 02-306 BWP M-825 Euclid E-1272 Leland L-1768 Meritor 1205N924 Spicer 29-1267
	Inboard Seal In B8660 Assembly				
	B8626	1-7/8"	1-5/8"	1/8"	Automann 113.1283 Batco 02-309 BWP M-1403 Euclid E-2406 Leland L-1295 Meritor 1205V1452 Spicer 29-1275
	Inboard Seal In B8661 Assembly				
	B8621	1-29/32"	1-1/2"	1-3/64"	Automann 113.1291 Batco 03-213 BWP M-1093 Euclid E-1314 Leland L-1729 Meritor 1205X726 Spicer 27-1208
	Used In B8696 On 1-1/2" Diameter Camshafts				
	B8690	2-1/16"	1-7/8"	1/8"	Automann 113.2022 Batco 02-329 Euclid E-3859 Leland L-3056 Meritor 1205G761 Spicer 30-1375
	Gasket For Meritor Drive Axles				
	B8761	1-3/4"	1-3/16"	1/4"	Automann 113.1241 Batco 02-318 BWP M-3236 Euclid E-3878 Leland L-2938 Meritor A1205D2110
	For Meritor 15" x 4" "Q" Front Brakes				
	B8751	1-7/8"	1-1/4"	1/16"	Automann 113.1284 Batco 02-315 BWP M-3352 Eaton 1005846 Euclid E-5128 Leland L-2830 Meritor R627030
	For Eaton 15" x 4" Front Brakes				

CAMSHAFT SEALS

	PART NO.	O.D.	I.D.	THK	REPLACES
	B8612	1-7/8"	1-1/2"	3/16"	Automann 113.1281 Batco 02-312 BWP M-824 Euclid E-1416 Leland L-1770 Meritor 1205M1105 Spicer 29-1269 M16HH100
	For Meritor And Spicer 1-1/2" Diameter Camshafts				
	B8612A	1-7/8"	1-1/2"	1/4"	Automann 113.1282 Batco 02-304 BWP M-824A Eaton 79903 Euclid E-1416A Leland L-966 Meritor R627008 Spicer 29-1266
	For Eaton 1-1/2" Diameter Camshafts				
	B717	2"	1-1/2"	3/16"	Batco 02-317 BWP M-2632 Euclid E-2717 Leland L-1687 Meritor R627026
	For Hendrickson "Intraax"				
	B8764	2"	1-5/8"	3/16"	Automann 113.2002 BWP M-1401A Euclid E-3991
Use With B8698 In Meritor 4000-6000 Trailer Axles					
B8625	2"	1-5/8"	1/4"	Automann 113.2001 Batco 02-313 BWP M-1401 Eaton 1002279 Euclid E-2405 Leland L-2941 Meritor 1205Q2123 Spicer 29-1274	
For Eaton "501" Brake And In B8661 Assy					
B8755	2-1/16"	1-7/32"	1/4"	Automann 113.2021 Batco 02-316 BWP M-2630 Euclid E-3469 Leland L-1744 Meritor A1205P1602 Spicer 29-1283	
For Meritor 1-1/4" Diameter Front Camshafts					

CAMSHAFT SEALS/WASHERS

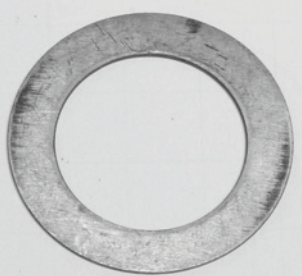
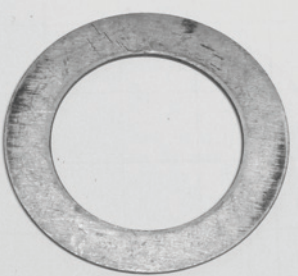
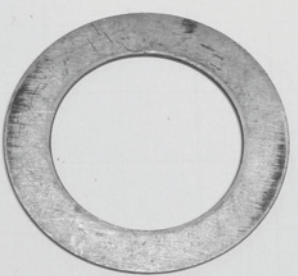
	PART NO.	O.D.	I.D.	THK	REPLACES
	B8609 For 1-1/2" Diameter Camshafts	2-1/16"	1-1/2"	1/4"	Automann 113.2023 Batco 02-300 BWP M-587A Eaton 82006 Euclid E-654 Leland L-329/L-1726 Meritor A1205V1556 Spicer 29-1270
	B8697 For Standard Forge 12-1/4" Diameter Brakes	3-1/2"	1-17/32"	.058"	Automann 114.1175 Batco 04-306 BWP M-1589 Euclid E-1408 Leland L-1719 Spicer 29-1318 Std Forge 403112
	B8759 For Meritor 15" x 4" "T" Brakes Nylon	1-7/8"	1-1/2"	9/32"	Automann 114.1165 Batco 04-346 BWP M-2635 Euclid E-3474 Leland L-1745 Meritor 1225C939 Spicer 29-1336
	B8762 For Mack 50,000# "Q" Brakes	1-7/8"	1-1/4"	1/32"	Automann 114.1083 Batco 04-377 Euclid E-5095 Meritor 1229J3130
	B988 For Meritor 4000-6000 Trailer Axles	1-7/8"	1-17/64"	.060"	Automann 107.1091 Batco 01-472 BWP M-748 Euclid E-1113 Haldex 65373 Leland L-889 Meritor 1229B1848 Spicer 35-1580
	B8610 Universal For 1-1/2" Diameter Camshafts	2"	1-17/32"	.050"	Automann 114.1173 BWP M-588 Euclid E-564 Leland L-120 Meritor 1229J868 Spicer 29-1309 M10HN139

CAMSHAFT WASHERS

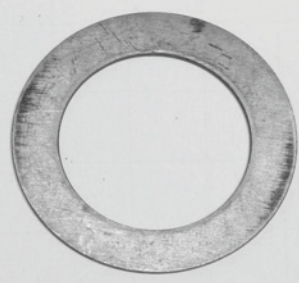
	PART NO.	O.D.	I.D.	THK	REPLACES
	B8630	2"	1-9/64"	.032"	Automann 114.1051 Batco 04-308 BWP M-1409 Eaton 23570 Euclid E-1781 Leland L-1608 Meritor R627006 Spicer 29-1320
	For Eaton Brakes				
	B8629	2"	1-9/64"	.060"	Automann 114.1052 Batco 04-307 BWP M-1408 Eaton 35428 Euclid E-1782 Leland L-1609 Meritor R627005 Spicer 29-1321
	For Eaton Brakes				
	B8786	2-1/4"	1-5/8"	1/32"	Automann 114.1202 Batco 04-361 Euclid E-9074 Leland L-3068 Meritor 1229B4136
	For Meritor 16-1/2" Diameter "Q-Plus" Brakes				
	B960	2-1/4"	1-5/8"	1/16"	Automann 114.1201 Batco 04-358 BWP M-1402A Euclid E-2411A Leland L-2947 Meritor 1229X3118 Spicer 29-1312
	For Meritor 4000-6000 Trailer Axle				
B8605	2-1/4"	1-17/32"	.032"	Automann 114.1172 Batco 04-301 BWP M-580 Euclid E-581 Leland L-192 Meritor 1229Q771 Spicer 29-1308	
Universal For 1-1/2" Diameter Camshafts					
B8632	2-1/4"	1-17/32"	3/32"	Automann 114.1171 Batco 04-328 BWP M-1413 Euclid E-2409 Leland L-1371 Meritor R627025 Spicer 29-1326 Std Forge 403149	
For Standard Forge 12-1/4" Brakes					



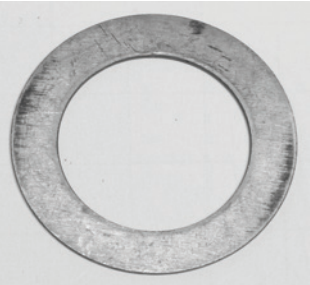

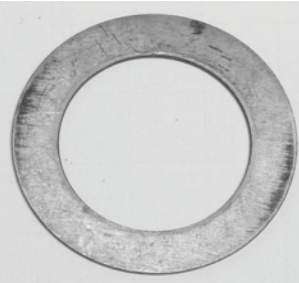

CAMSHAFT WASHERS

	PART NO.	O.D.	I.D.	THK	REPLACES
	B8607	2-1/4"	1-17/32"	.060"	Automann 114.1174 Batco 04-302 BWP M-583 Euclid E-580 Leland L-193 Meritor 1229R122 Spicer 29-1307
	Universal For 1-1/2" Diameter Camshafts				
	B8752	2-1/4"	1-1/4"	1/16"	Automann 114.1082 Batco 04-350 BWP M-3353 Eaton 1005202 Euclid E-5137 Leland L-2832 Meritor R627031 Spicer 29-1344
	For Eaton 15" x 4" Front Brakes				
	B8753	2-1/4"	1-1/4"	1/32"	Automann 114.1081 Batco 04-351 BWP M-3354 Eaton 1005203 Euclid E-5138 Leland L-2833 Meritor R627032 Spicer 29-1346
	For Eaton 15" x 4" Front Brakes				
	B8757	2-3/8"	1-9/32"	1/8"	Automann 114.1092 Batco 04-347 BWP M-2637 Euclid E-3476 Leland L-1747 Meritor 1229Q277 Spicer 29-1330
	For Meritor 15" x 4" "T" Brakes				
B8719	2-3/8"	1-1/2"	.111"	Automann 114.1163 Batco 04-322 BWP M-2638 Euclid E-3479 Leland L-2928 Meritor 1229S2697	
For Meritor "Q" Brakes					
B8785	2-3/8"	1-5/8"	3/32"	Automann 114.1205 Batco 04-333 Euclid E-9072 Leland L-3058 Meritor 1229S4101	
For Use With B8783 Bushing					

CAMSHAFT WASHERS

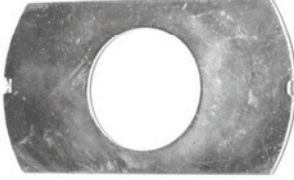
	PART NO.	O.D.	I.D.	THK	REPLACES
	B8619	2-3/8"	1-41/64"	.060"	Automann 114.1211 Batco 04-304 BWP M-1045 Euclid E-1565 Fruehauf AXA0417-1 Leland L-895 Meritor R627002 Spicer 29-1322
	For Fruehauf Propar Axles				
	B8611	2-7/16"	1-9/16"	.120"	Automann 114.1181 Batco 04-303 BWP M-719 Euclid E-719 Leland L-344 Meritor 1229M559 Spicer 29-1311 M10HS117 Std Forge 403105
	For Spicer, Standard Forge And Meritor Brakes				
	B8758	2-7/16"	1-9/32"	.032"	Automann 114.1091 Batco 04-345 BWP M-2639 Euclid E-3475 Leland L-1748 Meritor 1107D56 Spicer 29-1334
	For Meritor 15" x 4" "T" Brakes				
	B800	2-7/16"	1-11/16"	.120"	Automann 114.1221 Batco 04-329 BWP M-3985 Euclid E-10800 Leland L-3178 Meritor R627043 Spicer M10HS143
	Dana With 1-5/8" Cam Journal				
B8756	2-1/2"	1-5/16"	.062"	Automann 114.1101 Batco 04-340 BWP M-2640 Euclid E-3471 Leland L-1743 Meritor 1229B236 Spicer 29-1338	
For Meritor 15" x 4" "T" Brakes					
B230	2-3/4"	1-1/2"	.134"	Automann 114.1164 Batco 04-341 BWP M-2641 Euclid E-3472 Leland L-1753 Meritor 1229P302 Spicer 29-1333	
For Meritor 16-1/2" "T" Brakes					

CAMSHAFT WASHERS

	PART NO.	O.D.	I.D.	THK	REPLACES
	B811	3-1/8"	1-33/64"	.065"	Automann 114.1176 Batco 04-339 BWP M-2643 Euclid E-3473 Leland L-1724 Meritor 1229E811 Spicer 29-1337
	For Meritor 15" x 4" "T" Brakes				
	B8608	3-7/8"	1-1/2"	1/16"	Automann 114.1162 Batco 04-300 BWP M-584 Euclid E-656 Leland L-202 Meritor 1229G1463 Spicer 29-1310
	For 1-1/2" Diameter Camshafts				
	B8765	3-7/8"	1-1/2"	.063"	Automann 114.1167 Batco 04-335 Leland L-2926 Meritor 1229L844 Spicer 29-1340
	For Meritor "P" 1-1/2" Diameter Camshafts				
	B8631	3-7/8"	1-17/32"	1/16"	Automann 114.1177 Batco 04-327 BWP M-1412 Euclid E-2404 Leland L-1372 Meritor R627024 Spicer 29-1319 M10HS115 Std Forge 403150
	For Standard Forge 12-1/4" Brakes				
	B801	2-7/16"	1-11/16"	.060"	Automann 114.1222 Batco 04-376 BWP M-3986 Euclid E-10801 Meritor R627044 Spicer M10HS147
	Spicer With 1-5/8" Cam Journal				
	B961	3-7/8"	1-5/8"	1/16"	Automann 114.1204 Batco 04-359 Euclid E-9073 Leland L-2945 Meritor 1229A4135
	For Meritor 16-1/2" "Q-Plus" Brakes				





CAMSHAFT WASHERS

	PART NO.	O.D.	I.D.	THK	REPLACES
	B8721	5-3/4"	1-9/16"	.060"	Batco 04-360
	For Hendrickson "Intraax"				
	B8718	5-13/16"	1-1/2"	.060"	Automann 114.1166 Batco 04-334 BWP M-2634 Euclid E-3478 Leland L-2927 Meritor 1229N2250 Spicer 29-1339
	For Meritor "Q" Brakes				
	B8763	---	1-1/2"	.062"	Automann 114.1161 Batco 04-357 BWP M-3240 Eaton 806380 Euclid E-5482 Leland L-2963 Meritor R627033
	For Eaton 16-1/2" "ES" Brakes				
	B8781	---	1-41/64"	.060"	Automann 114.1213 Batco 04-338 Euclid E-9071 Leland L-3363 Meritor 1229E4685
	For Mack "Q" 50,000# Brakes				
	B8784	2-11/16"	1-5/8"	1/4" Cup	Automann 114.1203 Batco 04-321 Euclid E-6077 Leland L-3057 Meritor 1229R4100
	For Meritor "Q-Plus" Trailer Axles With Fabricated Spider				
	B8787	2-3/8"	1-41/64"	11/32"	Batco 04-362 BWP M-3248 Euclid E-9075 Leland L-2944 Meritor 1229C4137
	For Meritor "Q" Trailer Axles With 1-5/8" Camshafts				

CAMSHAFT LOCKS

	PART NO.	O.D.	I.D.	THK	REPLACES
	B794	---	31/32"	3/32"	Automann 115.0311 Batco 04-356 Euclid E-9076 Leland L-2940 Meritor 1229J4092
	For 15" x 4" "Q" And 16-1/2" "P" Brakes				
	B793	---	1-1/8"	1/16"	Automann 108.1041 Batco 01-482 BWP M-1523 Euclid E-801 Leland L-397 Meritor 1229X1116 Spicer 34-1525
	For Meritor 4000-6000 Trailer Axles				
	B8689	---	1-5/32"	3/32"	Automann 115.1051 Batco 01-492 BWP M-3349 Euclid E-5093 Leland L-331 Meritor 1229D2942 Spicer 34-1547
	For Meritor 15" x 4" "T" And 16-1/2" "Q" Brakes				
	B795	---	1-5/16"	1/16"	Automann 115.1101 BWP M-2648 Euclid E-2720 Meritor R627027 Spicer 29-1306
	For Hendrickson 16-1/2" "Intraax" Brakes				
B8691	---	1-3/8"	3/32"	Automann 115.1121 Batco 04-318 BWP M-3496 Euclid E-4736 Leland L-2900 Meritor 1229Q2851	
For Meritor Drive Axles					
B8604	---	1-31/64"	1/16"	Automann 115.1161 Batco 04-310 BWP M-579 Euclid E-526 Leland L-137 Meritor 1229Z1118 Spicer 29-1301	
Universal For 1-1/2" Diameter Camshafts					







CAMSHAFT LOCKS

	PART NO.	O.D.	I.D.	THK	REPLACES
	B8622	---	1-1/2"	1/16"	Automann 115.1162 Batco 04-315 BWP M-1046 Euclid E-1569 Fruehauf AXA0418-1 Leland L-897 Meritor R627017 Spicer 29-1302
	For Meritor 4000-6000 And "Propar" Axles				
	B8634	---	1-1/2"	1/16"	Batco 04-314 BWP M-1505 Euclid E-910 Leland L-467 Meritor R627014 Spicer 29-1315
	For 1-1/2" Diameter Camshafts				
	B8634A	---	1-5/8"	3/32"	Automann 115.1201 Batco 04-363 BWP M-3398 Euclid E-9077 Leland L-3364 Meritor 1229T4102 Spicer 29-1305
	For Meritor 16-1/2" "Q-Plus" Brakes				
	B8722	---	---	---	Automann 115.1011 Batco 04-319 BWP M-2649 Eaton 804017 Euclid E-3234 Leland L-1606 Meritor R627012 Spicer 29-1303
	For Eaton Camshafts				

INNER CAP NUTS





PART NO.	NOTES	THREAD		LG	REPLACES	
		OUTER	INNER			
 708AR/9AL	GRADE 8 Inner Thread Depth 1-1/4" Steel/Steel Available In Pails (325) Y - Suffix Yellow Zinc Z - Suffix Clear Zinc	1-1/8" - 16	3/4" - 16	2-7/32"	Automann 201.1001R/L Batco 13-3005R/L Budd 10708/9 BWP M-128/9 Euclid E-7895R/L GLP GL-1001/2 Leland W-11/2 Meritor R007895R/L Spicer 51-1005R/L	
 896R/L	GRADE 8 Inner Thread Depth 1-1/4" Steel/Steel Or Steel/Aluminum Available In Pails (275) Y - Suffix Yellow Zinc Z - Suffix Clear Zinc	1-1/8" - 16	3/4" - 16	2-9/16"	Automann 201.1002R/L Batco 13-3028R/L Budd 35336/7 BWP M-130/1 Euclid E-7896R/L GLP GL-1003/4 Leland W-620/1 Meritor R007896R/L Spicer 51-1006R/L	
 897R/L	GRADE 8 Inner Thread Depth 1-7/8" Steel/Steel Or Steel/Aluminum Available In Pails (200) Y - Suffix Yellow Zinc Z - Suffix Clear Zinc	1-1/8" - 16	3/4" - 16	3-1/16"	Automann 201.1003R/L Batco 13-3029R/L Budd 88013/4 BWP M-132/3 Euclid E-7897R/L GLP GL-1005/6 Leland W-616/7 Meritor R007897R/L Spicer 51-1007R/L	
 978R/L	GRADE 8 Inner Thread Depth 1-15/16" Full Inner Thread Aluminum/Aluminum Clear Zinc	1-1/8" - 16	3/4" - 16	3-1/16"	Alcoa 5956R/L Automann 201.1006R/L Batco 13-3034R/L Euclid E-5978R/L Leland W-766/7 Meritor R005978R/L Spicer 51-1011R/L	
 988R/L	GRADE 8 Inner Thread Depth 1-15/16" Aluminum/Aluminum Available In Pails (225) Y - Suffix Yellow Zinc Z - Suffix Clear Zinc	1-1/8" - 16	3/4" - 16	3-1/16"	Alcoa 5988R/L Automann 201.1007R/L Batco 13-3026R/L BWP M-2400/1 Euclid E-5988R/L GLP GL-1011/2 Leland W-486/7 Meritor R005988R/L Spicer 51-1003R/L	
 306R/L	METRIC Yellow Zinc	M 30 x 1.5	M 20 x 1.5	62 mm (2-7/16")	Automann 201.1004R/L Batco 13-3130R/L BWP M-3982/3 Euclid E-10253R/L GLP GL-1009/10 GMC 94039630/1 Hino 9004-23/24101 Isuzu 1-42335/6-005-0 Leland W-720/1 Meritor R003130R/L	

OUTER CAP NUTS

PART NO.	NOTES	THRD	HEX	HIGH	REPLACES
 891AR/2AL 891BR/2BL *	GRADE 8 Outer Dual Or 1-1/8" Single Mounting Available In Pails (525) Y - Suffix Yellow Zinc Z - Suffix Clear Zinc * Thru-Hardened	1-1/8" - 16	1-1/2"	7/8"	Automann 201.2003R/L Batco 13-3012R/L Budd 37891/2 BWP M-126/7 Euclid E-5977R/L * GLP GL-2001/2 GL-2003/4 * Leland W-13/4 Meritor R005977R/L * Spicer 51-1012R/L
 996R/L	Wide Base Aluminum Wheels Clear Zinc	1-1/8" - 16	1-1/2"	1"	Alcoa 5996R/L Automann 201.2004R/L Batco 13-3055R/L BWP M-3210/1 Euclid E-5996R/L GLP GL-2021/2 Leland W-508/9 Meritor R005996R/L
 912R/3L	Severe Service Outer Dual Or 1-1/8" Single Mounting Yellow Zinc	1-1/8" - 16	1-1/2"	1-3/32"	Automann 201.3019R/L Batco 13-3016R/L Budd 69912/3 BWP M-166/7 Euclid E-5579R/L GLP GL-2013/4 Leland W-115/6 Meritor R005579R/L Spicer 51-1018R/L
 888R/9L	Single Mounting Available In Pails (525) Clear Zinc	3/4" - 16	1-1/2"	7/8"	Automann 201.2001R/L Batco 13-3013R/L Budd 37888/9 BWP M-124/5 Euclid E-5652R/L GLP GL-2101/2 Leland W-15/6 Meritor R005652R/L Spicer 51-1013R/L
 995R/L	Wide Base Aluminum Wheels Clear Zinc	3/4" - 16	1-1/2"	1-3/8"	Alcoa 5995R/L Automann 201.2009R/L Batco 13-3054R/L BWP M-3208/9 Euclid E-5995R/L GLP GL-2103/4 Leland W-506/7 Meritor R005995R/L
 304R/L	METRIC Outer Dual Mounting Yellow Zinc	M 30 x 1.5	41 mm (1-5/8")	25 mm (1")	Automann 201.2006R/L Batco 13-3131R/L BWP M-3980/1 Euclid E-10254R/L GLP GL-2009/10 Hino 9004-21112 9004-22104 Isuzu 1-42333/4-023-0 Leland W-722/3 Meritor R0010254R/L

DISC WHEEL NUTS

FLANGED CAP NUTS

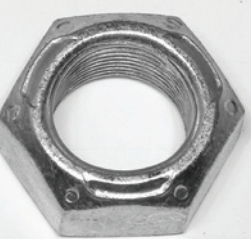
PART NO.	NOTES	THRD	HEX	HIGH	REPLACES
 333B	Metric 2-Piece Budd Unimount 10 Hub Piloted Wheels Teflon Coated Available In Pails (300)	M 22 x 1.5	33 mm (1-19/64")	31 mm (1-7/32")	Automann 201.3014 Batco 13-3052 Budd 106333 BWP M-3203 Euclid E-6000A GLP GL-2301 Leland W-498 Meritor R006000 NWRA X2156 Spicer 51-1033
 881M	Metric 2-Piece Motor Wheel WHD - 8 Hub Piloted Wheels Teflon Coated Available In Pails (250)	M 22 x 1.5	38 mm (1-1/2")	35 mm (1-3/8")	Automann 201.3015 Batco 13-3050 BWP M-3207 Euclid E-5991 GLP GL-2302 Leland W-492 Meritor R005991 Motor Wheel 88881 Spicer 51-1032
 920	Metric 2-Piece Alcoa Hub Piloted Wheels Teflon Coated	M 22 x 1.5	33 mm (1-9/32")	26 mm (1-1/32")	Alcoa 39691/39949 Automann 201.3013 Batco 13-3057 BWP M-3979 Euclid E-9020 Leland W-525 Meritor R009020 Spicer 51-1034
 919	Metric 2-Piece Teflon Coated	M 20 x 1.5	30 mm	32 mm (1-1/4")	BWP M-4115 Euclid E-10235 Ford E6HZ1120B GM 15642921 Leland W-619 Meritor R0010235 Volvo 947971-8
 921	2-Piece General Motors BUS Phosphate Coated	7/8" - 14	1-15/16"	7/8"	Batco 13-3058 Euclid E-9021 GM 2071619 Leland W-623 Meritor R009021
 073	Back Nut Top Lock Available In Pails (1250)	3/4" - 16	1-1/8"	---	Automann LN105 Batco SLN-105 BWP M-2459 Euclid E-4961A Leland W-451 Meritor R004961A Spicer 54-1661

SLEEVE NUTS

FLANGED CAP NUTS

- * Teflon coating
- * 240 HR Salt Spray
- * Protects and covers the threads from wear and the elements
- * Reduces vibration and wear and tear on wheel ends
- * Fills the gap between the stud and the stud hole and allows the rim to rest on the sleeve
- * Lengths designed for specific axle applications and wheel configurations

PART NO.	NOTES	THREAD	REPLACES
 333SN6	Steel Steers 6 mm Sleeve Length	M 22 x 1.5	Alcoa 4306.32 Automann 201.3031 BWP M-4214 GLP GL-2906 Haltec 430632
 333SN19	Aluminum Steers Designed for Steel/Steel-Drive Steel Outer/Alum. Inner-Drives 19 mm Sleeve Length	M 22 x 1.5	Alcoa 4307.32 Automann 201.3036 BWP M-4215 GLP GL-2919 Haltec 430732
 333SN28	Designed for H.D. Aluminum Super Single-Wide Base Alum. Outer/Steel Inner 28 mm Sleeve Length	M 22 x 1.5	Automann 201.3033 BWP M-4216 GLP GL-2928
 333SN39	Designed for Dual Aluminum-Drive Axle 39 mm Sleeve Length	M 22 x 1.5	Automann 201.3034 BWP M-4217 GLP GL-2939

WHEEL STUDS

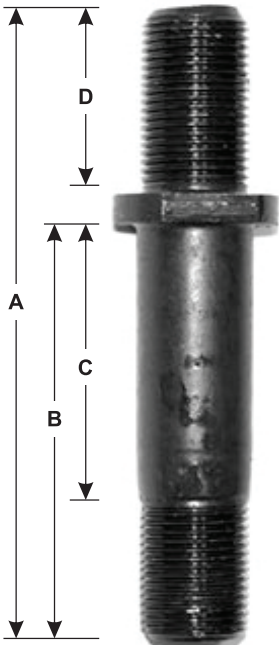
GRADE 8 3/4" - 16 Thread	PART NO.	A	B	C	D	REPLACES
	095/6	3-19/32"	2-1/16"	7/8"	1-11/32"	Automann 201.7002L/R Batco 13-1002L/R Budd 13096/7 BWP M-49/8 Euclid E-5556L/R Leland W-39/8 Meritor R005556L/R Spicer 50-1003L/R
	988/9	3-23/32"	2-3/16"	1-1/16"	1-11/32"	Automann 201.7003R/L Batco 13-1003R/L Budd 13988/9 BWP M-50/1 Euclid E-5559R/L Leland W-40/1 Meritor R005559R/L Spicer 50-1004R/L
	990/1	3-31/32"	2-7/16"	1-5/32"	1-11/32"	Automann 201.7004R/L Batco 13-1004R/L Budd 13990/1 BWP M-52/3 Euclid E-5561R/L Leland W-42/3 Meritor R005561R/L Spicer 50-1006R/L
	004/5	4-1/32"	2-1/2"	1-9/32"	1-11/32"	Automann 201.7005R/L Batco 13-1005R/L Budd 19004/5 BWP M-54/5 Euclid E-5560R/L Leland W-44/5 Meritor R005560R/L Spicer 50-1007R/L
	124/5	4-7/32"	2-11/16"	1-7/16"	1-11/32"	Automann 201.7006R/L Batco 13-1006R/L Budd 17123/4 BWP M-56/7 Euclid E-5551R/L Leland W-46/7 Meritor R005551R/L Spicer 50-1008R/L
	271/2	4-17/32"	3"	1-29/32"	1-11/32"	Automann 201.7010R/L Batco 13-1008R/L Budd 16271/2 BWP M-60/1 Euclid E-5553R/L Leland W-50/1 Meritor R005553R/L Spicer 50-1010R/L
	095/6	3-19/32"	2-1/16"	7/8"	1-11/32"	Automann 201.7002L/R Batco 13-1002L/R Budd 13096/7 BWP M-49/8 Euclid E-5556L/R Leland W-39/8 Meritor R005556L/R Spicer 50-1003L/R
	988/9	3-23/32"	2-3/16"	1-1/16"	1-11/32"	Automann 201.7003R/L Batco 13-1003R/L Budd 13988/9 BWP M-50/1 Euclid E-5559R/L Leland W-40/1 Meritor R005559R/L Spicer 50-1004R/L

Body Diameter .783/.786

WHEEL STUDS

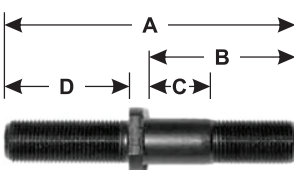
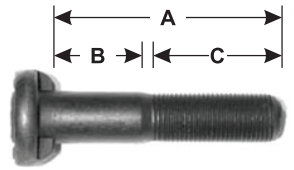
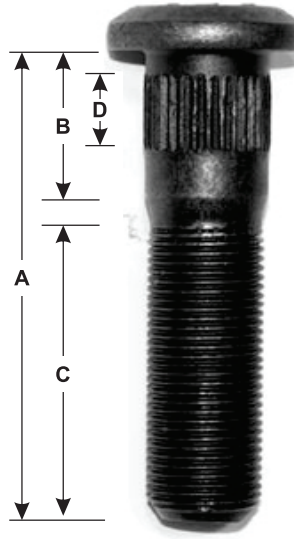
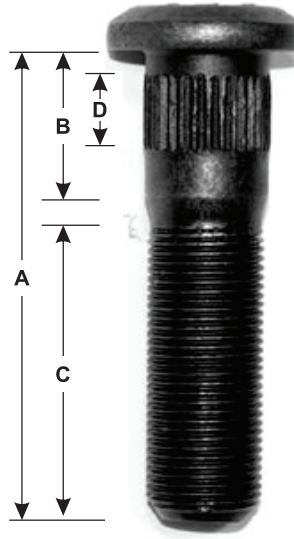
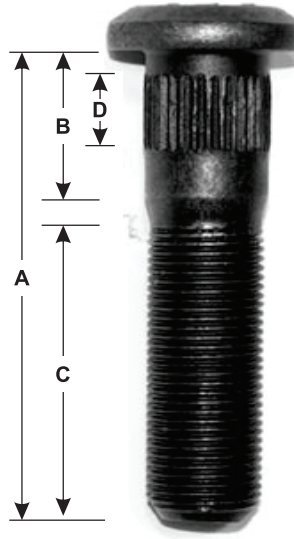
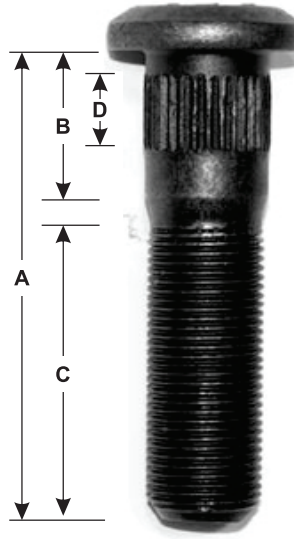
GRADE 8 3/4" - 16 Thread	PART NO.	A	B	C	D	REPLACES
 <p style="text-align: center;">Body Diameter .784</p>	011/2	4-1/2"	2-3/8"	1-1/32"	1-15/16"	Automann 201.7011L/R Batco 13-1037L/R BWP M-2405/4 Euclid E-5931L/R Freightliner 11-9714-12/1 Leland W-464/3 Meritor R005931L/R Spicer 50-1026L/R
 <p style="text-align: center;">Body Diameter .792</p>	204/5	3-13/32"	1-7/16"	1-5/8"	---	Automann 201.6086R/L Batco 13-2323R/L BWP M-2420/1 Euclid E-5924R/L Leland W-264/5 Meritor R005924R/L Spicer 50-1250R/L
 <p style="text-align: center;">Body Diameter .784</p>	426/7	2-11/16"	3/132"	1-13/32"	1/2"	Automann 201.6039R/L Batco 13-1133R/L Euclid E-8983R/L Gunite W1170R/L Leland W-680/1 Meritor R008983R/L
 <p style="text-align: center;">Body Diameter .784</p>	420/1	2-15/16"	1-5/16"	1-13/32"	1/2"	Automann 201.6043R/L Batco 13-1128R/L BWP M-3610/1 Euclid E-8969R/L Gunite W981R/L W1121R/L Leland W-608/9 Meritor R008969R/L
 <p style="text-align: center;">Body Diameter .784</p>	424/5	3-1/8"	1-11/32"	1-19/32"	1/2"	Automann 201.6049R/L Batco 13-1146R/L BWP M-3612/3 Euclid E-8982R/L Gunite W1166R/L Leland W-664/5 Meritor R008982R/L
 <p style="text-align: center;">Body Diameter .784</p>	418/9	3-3/16"	3/132"	1-5/8"	1/2"	Automann 201.6050R/L Batco 13-1135R/L BWP M-3614/5 Euclid E-8968R/L Gunite W980R/L Leland W-674/5 Meritor R008968R/L

WHEEL STUDS

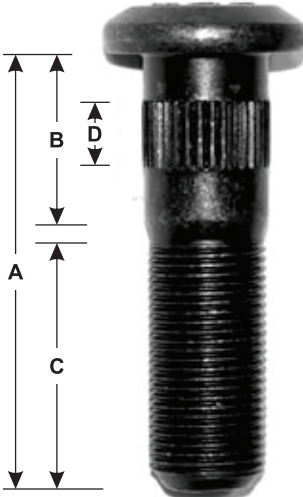
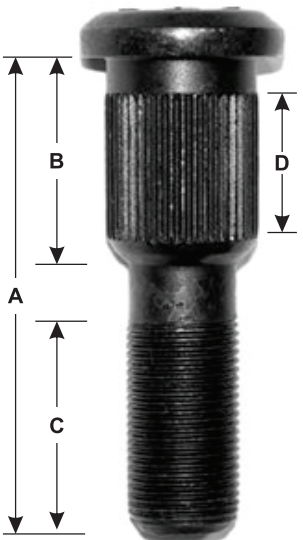
GRADE 8 3/4" - 16 Thread	PART NO.	A	B	C	D	REPLACES
 <p style="text-align: center;">Body Diameter .784</p>	133/4	3-11/32"	1-9/32"	1-27/32"	1/2"	Automann 201.6054R/L Batco 13-1129R/L BWP M-3241/2 Euclid E-8979R/L Gunite W992R/L W1133R/L Leland W-610/1 Meritor R008979R/L
	432/3	3-13/32"	1-7/16"	1-5/8"	1/2"	Automann 201.6057R/L Batco 13-1157R/L BWP M-3652/3 Conmet 102279/80 Euclid E-10208R/L Leland W-706/7 Meritor R0010208R/L
	434/5	3-25/32"	1-7/16"	2"	1/2"	Automann 201.6062R/L Batco 13-1158R/L BWP M-3654/5 Conmet 102281/2 Euclid E-10210R/L Leland W-730/1 Meritor R0010210R/L
 <p style="text-align: center;">Body Diameter .971/.976</p>	414/5	2-29/32"	1-3/16"	1-1/4"	1"	Automann 201.6107R/L Batco 13-1234R/L BWP M-1288/9 Euclid E-5987R/L Leland W-380/1 Meritor R005987R/L Motor Wheel 86797/8
	482/1	3-3/32"	1-3/8"	1-1/4"	1"	Automann 201.6109R/L Batco 13-1230R/L BWP M-1212/3 Euclid E-5871R/L Leland W-274/5 Meritor R005871R/L Paccar PAC3R/4L Spicer 50-1181R/L
	416/7	3-3/16"	1-3/16"	1-5/32"	1"	Automann 201.6111R/L Batco 13-1235R/L BWP M-3626/7 Euclid E-6057R/L Leland W-548/9 Meritor R006057R/L

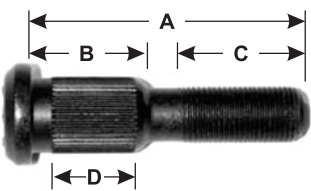
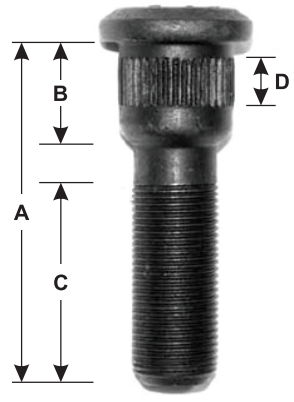
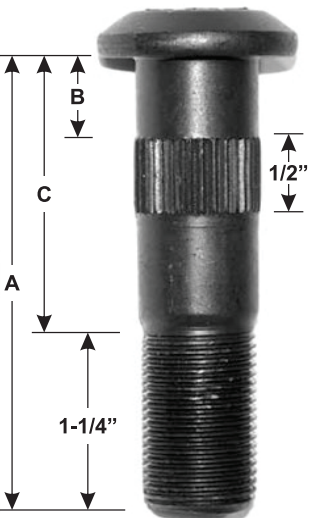

WHEEL STUDS

GRADE 8	PART NO.	A	B	C	D	REPLACES
<p style="text-align: center;">3/4" - 16 Thread</p>  <p style="text-align: center;">Body Diameter .971/.976</p>	287R/L	3-3/8"	1-3/8"	1-1/4"	1"	Automann 201.6114R/L Batco 13-1231R/L BWP M-2438/9 Euclid E-5896R/L Leland W-276/7 Meritor R005896R/L Paccar PAC1R/2L Spicer 50-1182R/L
<p style="text-align: center;">3/4" - 16 Thread</p>  <p style="text-align: center;">Body Diameter .974</p>	430/1	2-27/32"	13/16"	1-1/8"	1/2"	Automann 201.6106R/L Batco 13-1273R/L BWP M-3618/9 Euclid E-9010R/L Leland W-700/1 Meritor R009010R/L Webb 101172/3
	412/3	3-1/8"	13/16"	1-5/16"	7/16"	Automann 201.6108R/L Batco 13-1204R/L BWP M-2436/7 Euclid E-5910R/L Leland W-395/6 Meritor R005910R/L Spicer 50-1165R/L
<p style="text-align: center;">3/4" - 16 Thread</p>  <p style="text-align: center;">Body Diameter .784</p>	191/2	2-3/8"	1"	1/4"	---	Automann 201.6035R/L Batco 13-1102R/L Budd 59191/2 BWP M-74/5 Euclid E-4965R/L Leland W-64/5 Meritor R004965R/L Spicer 50-1122R/L
	263/4	2-5/8"	1-1/4"	5/16"	---	Automann 201.6037R/L Batco 13-1103R/L Budd 59263/4 BWP M-76/7 Euclid E-4966R/L Leland W-66/7 Meritor R004966R/L Spicer 50-1123R/L
	968/9	2-7/8"	1-1/2"	1/4"	---	Automann 201.6042R/L Batco 13-1107R/L Budd 61968/9 BWP M-78/9 Euclid E-4967R/L Leland W-68/9 Meritor R004967R/L Spicer 50-1127R/L

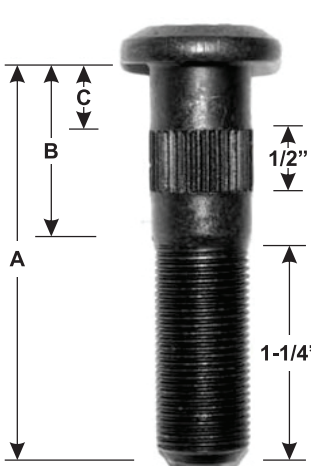
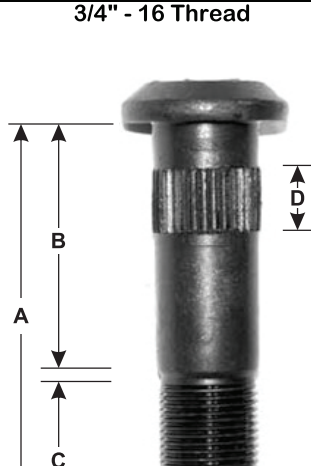
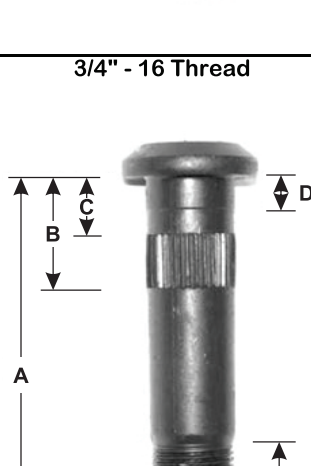
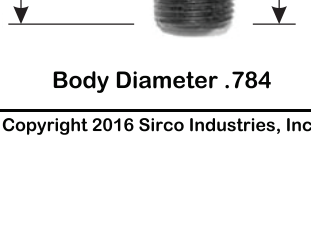
WHEEL STUDS

GRADE 8 3/4" - 16 Thread	PART NO.	A	B	C	D	REPLACES
 <p style="text-align: center;">Body Diameter .784</p>	851/2	2-7/8"	1-1/2"	1/2"	---	Automann 201.6067R/L Batco 13-1104R/L Budd 49851/2 BWP M-80/1 Euclid E-4968R/L Leland W-70/1 Meritor R004968R/L Spicer 50-1128R/L
 <p style="text-align: center;">Body Diameter .784</p>	183/4	3-1/8"	1-3/4"	9/16"	---	Automann 201.6069R/L Batco 13-1105R/L Budd 59183/4 BWP M-82/3 Euclid E-4969R/L Leland W-72/3 Meritor R004969R/L Spicer 50-1131R/L
 <p style="text-align: center;">Body Diameter .777/.784</p>	948/7	2-31/32"	1-13/32"	1-1/16"	1/2"	Automann 201.6045R/L Batco 13-1122R/L Budd 100145/6 BWP M-3608/9 Euclid E-8947R/L Leland W-575/6 Meritor R008947R/L
 <p style="text-align: center;">Body Diameter .786</p>	428/9	3-3/8"	1-13/32"	1-21/32"	1/2"	Automann 201.6151R/L Batco 13-1140R/L BWP M-3616/7 Euclid E-9008R/L Leland W-686/7 Meritor R009008R/L Webb 100164/3
<p style="text-align: center;">Body Diameter .784</p>	066/7	3-3/8"	2"	9/16"	5/16"	Automann 201.6072R/L Batco 13-1113R/L Budd 59066/7 BWP M-1110/1 Euclid E-5756R/L Leland W-372/3 Meritor R005756R/L Spicer 50-1134R/L
<p style="text-align: center;">Body Diameter .784</p>	097/8	3-3/8"	2"	3/8"	3/16"	Automann 201.6071R/L Batco 13-1108R/L Budd 84097/8 BWP M-1120/1 Euclid E-5765R/L Leland W-236/7 Meritor R005765R/L Spicer 50-1133R/L

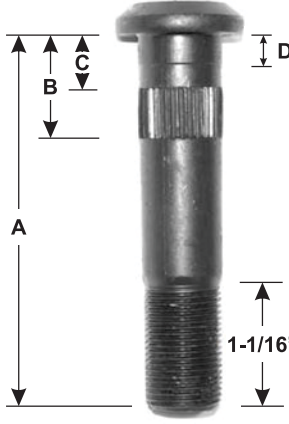
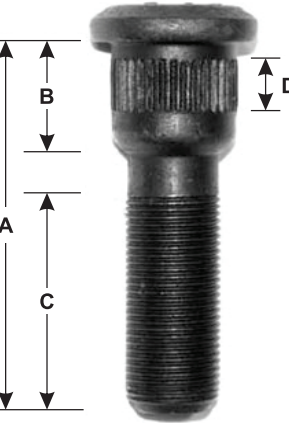
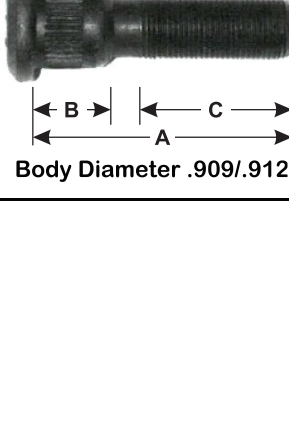
WHEEL STUDS

GRADE 8 3/4" - 16 Thread	PART NO.	A	B	C	D	REPLACES
 <p style="text-align: center;">Body Diameter .784</p>	375/6	3-5/8"	2-1/4"	9/16"	5/16"	Automann 201.6073R/L Batco 13-1106R/L Budd 59375/6 BWP M-1112/3 Euclid E-5757R/L Leland W-278/9 Meritor R005757R/L Spicer 50-1135R/L
 <p style="text-align: center;">Body Diameter .784</p>	373/4	3-7/8"	2-1/2"	9/16"	5/16"	Automann 201.6074R/L Batco 13-1110R/L Budd 59373/4 BWP M-1176/7 Euclid E-5766R/L Leland W-280/1 Meritor R005766R/L Spicer 50-1136R/L
 <p style="text-align: center;">Body Diameter .971/.975</p>	447/8	2-11/16"	1-1/32"	1-21/32"	7/16"	Automann 201.6103R/L Batco 13-1206R/L BWP M-2434/5 Euclid E-5900R/L Leland W-399/400 Meritor R005900R/L
 <p style="text-align: center;">Body Diameter .971/.975</p>	438/9	2-23/32"	1-9/16"	1-5/32"	7/16"	Automann 201.6104R/L Batco 13-1203R/L BWP M-88/9 Euclid E-5720R/L Leland W-166/7 Meritor R005720R/L
<p style="text-align: center;">Body Diameter .909/.912</p>	449/0	2-19/32"	1-9/32"	1-5/16"	31/32"	Automann 201.6097R/L Batco 13-1585R/L BWP M-3218/9 Euclid E-8949R/L Leland W-504/5 Meritor R008949R/L

METRIC STUDS

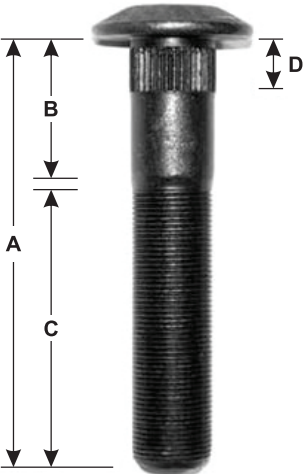
GRADE 8	PART NO.	A	B	C	D	REPLACES
<p>M 22 x 1.5 Thread</p>  <p>Body Diameter .910</p>	<p>436</p>	<p>4-15/32"</p>	<p>1-9/16"</p>	<p>2-9/16"</p>	<p>1/2"</p>	<p>Automann 201.6141 Batco 13-1550 BWP M-3659 Conmet 102290 Euclid E-10219 Leland W-708 Meritor R0010219</p>
	<p>437</p>	<p>5-11/32"</p>	<p>1-9/16"</p>	<p>3-7/16"</p>	<p>1/2"</p>	<p>Automann 201.6145 Batco 13-1552 BWP M-3663 Conmet 102292 Euclid E-10221 Leland W-702 Meritor R0010221</p>

METRIC STUDS

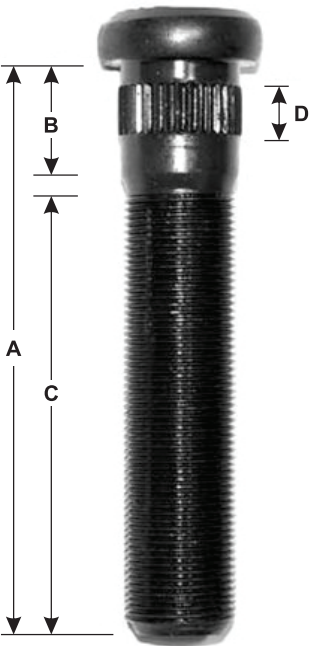
GRADE 8 M 22 x 1.5 Thread		PART NO.	A	B	C	D	REPLACES
							Automann 201.6149 Batco 13-1570 BWP M-3215 Euclid E-6036 Leland W-544 Meritor R006036 Spicer 50-1267 Webb 101164
	164	3-1/2"	23/32"	2-1/4"	3/8"		
	Available In Pails (150)						
							Automann 201.6151 Batco 13-1571 BWP M-3216 Euclid E-6035 Leland W-545 Meritor R006035 Spicer 50-1268 Webb 101162
	162	3-15/16"	23/32"	2-11/16"	3/8"		
	Available In Pails (150)						
							Automann 201.6152 Batco 13-1567 BWP M-3666 Euclid E-8981 Gunite W1164 Leland W-657 Meritor R008981
	423	4"	7/8"	2-29/32"	1/2"		
							Automann 201.6153 Batco 13-1577 BWP M-3667 Euclid E-10676 Gunite W1327 Leland W-669 Meritor R0010676
	676	4-1/4"	7/16"	3-1/4"	1/2"		
						Automann 201.6157 Batco 13-1572 BWP M-3217 Euclid E-6034 Leland W-546 Meritor R006034 Spicer 50-1269 Webb 101160	
160	4-25/32"	23/32"	3-17/32"	3/8"			
Available In Pails (125)							
						Automann 201.6158 Batco 13-1576 BWP M-3669 Euclid E-8980 Gunite W1160 Leland W-656 Meritor R008980	
422	5-3/32"	7/8"	3-3/4"	3/4"			

Body Diameter .975

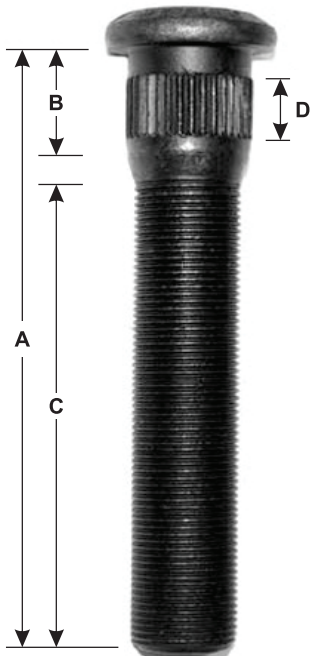
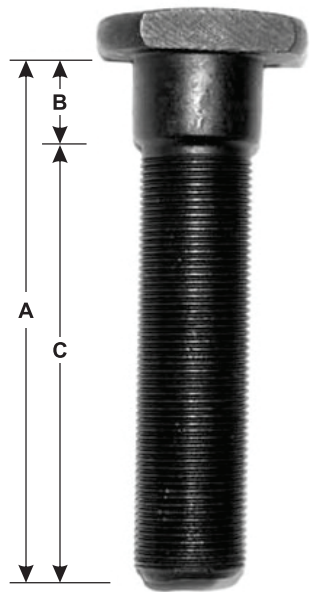

METRIC STUDS

GRADE 8	PART NO.	A	B	C	D	REPLACES
M 22 x 1.5 Thread 2-Piece Metric Nut 333B  Body Diameter .901						Batco 13-1580 Budd 106377 BWP M-3200 Euclid E-5998 Leland W-496 Meritor R005998 Spicer 50-1284
	334	3-15/64"	29/32"	2"	13/32"	
	335	3-21/32"	29/32"	2-29/64"	13/32"	
						Automann 201.6133 Batco 13-1582 Budd 106397 BWP M-3202 Euclid E-5999 Leland W-495 Meritor R005999 Spicer 50-1286
	336	4-41/64"	29/32"	3-47/64"	13/32"	
M 22 x 1.5 Thread 2-Piece Metric Nut 881M  Body Diameter .981						Batco 13-1561 BWP M-3204 Euclid E-5994 Leland W-490 Meritor R005994 Motor Wheel 88808 Spicer 50-1275
	882	3-1/4"	43/64"	2-1/4"	---	
	883	3-9/16"	23/32"	2-15/32"	---	
						Automann 201.6162 Batco 13-1560 BWP M-3206 Euclid E-5993 Leland W-489 Meritor R005993 Motor Wheel 88799 Spicer 50-1274
	884	4-1/8"	23/32"	3-1/16"	---	

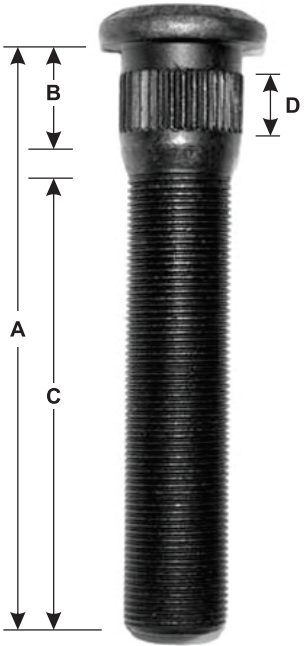
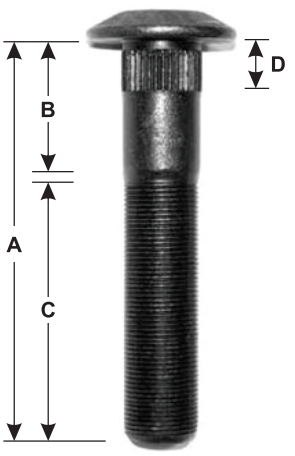
METRIC STUDS

GRADE 10.9 M 22 x 1.5 Thread 2-Piece Metric Nut 333B	PART NO.	A	B	C	D	REPLACES
	402	4-23/32"	1 1/16"	3-23/32"	1/2"	Dayton 13-1559 Gunite W1325/W1402
	Body Diameter .971/.975					
	367	4-7/8"	7/8"	3-27/32"	3/8"	Automann 201.6130 BWP M-3267 Dayton 13-1589 Euclid E-11715 Leland W-689/W-787
	Body Diameter .887/.890					
	366	3-23/32"	7/8"	2-9/16"	3/8"	Automann 201.6128 BWP M-3266 Dayton 13-1587 Euclid E-9837 Leland W-765
	Body Diameter .887/.890					
M22 x 1.5 	451	4-13/32"	1-3/16"	2-7/8"	3/4"	Automann 201.6172 Batco 13-1721 BWP M-3677 Euclid E-8986 Leland W-676 Meritor R008986
	452	4-31/32"	1-3/4"	3-7/32"	1/2"	Automann 201.6143 Batco 13-1546 BWP M-3661 Euclid E-10217 Leland W-718 Meritor R0010217
	453	5"	1-29/32"	3-7/64"	1/2"	Automann 201.6144 Batco 13-1551 BWP M-3662 Conmet 102291 Euclid E-10220 Leland W-719 Meritor R0010220
	Body Diameter 1.218/1.222					

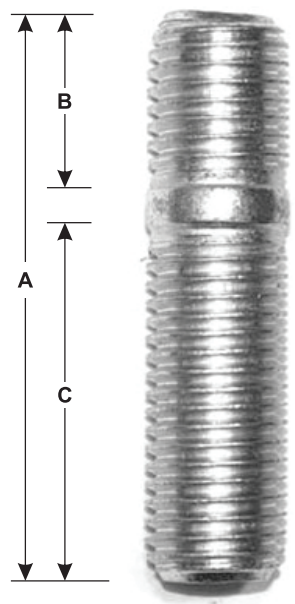
CAST SPOKE WHEEL PARTS

GRADE 8	PART NO.	THRD	A	B	C	REPLACES	
	654	5/8" - 11	2-3/4"	7/8"	1-11/16"	Automann 203.4002 Batco 13-6002 BWP M-38 Dayton 08-006654 Euclid E-4958 GLP GL-3001 Leland W-5 Meritor R004958 Spicer 53-1500 Webb 161127	
	715	3/4" - 10	3"	1-1/16"	1-3/4"	Automann 203.4005 Batco 13-6003 BWP M-39 Dayton 08-005715 Euclid E-4956A GLP GL-3003 Leland W-6 Meritor R004956A Spicer 53-1501 Webb 171027	
	Available In Pails (525)						
	411	3/4" - 10	3-1/8"	1-1/16"	1-7/8"	Automann 203.4006 Batco 13-6008 BWP M-1102 Dayton 08-204734 Euclid E-5706 Leland W-246 Meritor R005706 Spicer 53-1503	
	Clear Zinc						
	GRADE 5	PART NO.	THRD	HEX	HIGH	REPLACES	
		149	5/8" - 11	1-1/16"	19/32"	Automann 203.3001 Batco 13-8003 BWP M-43 Dayton 08-005149 Euclid E-4962 GLP GL-3004 Leland W-7 Meritor R004962 Spicer 53-1560 Webb 74611	
		Clear Zinc					Automann 203.3002 Batco 13-8004 BWP M-45 Dayton 08-005716 Euclid E-4963 GLP GL-3005 Gunite W854 Leland W-8 Meritor R004963 Spicer 53-1561 Webb 74710
		716	3/4" - 10	1-1/4"	23/32"		
Available In Pails (850)							
Black							
716S		3/4" - 10	1-1/4"	23/32"		Automann 203.3002B Batco 13-8006 Euclid E-7775 GLP GL-3006 Leland W-748 Meritor R007775	
ASTM A194 Grade 2H							

RIM CLAMPS

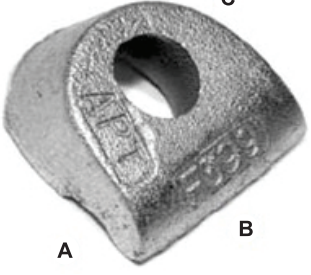
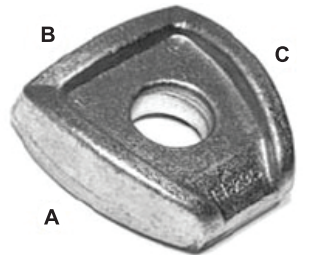
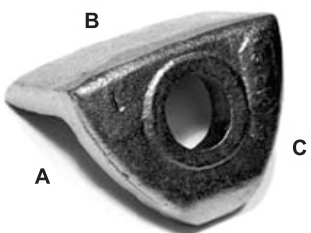
TYPE	PART NO.	STUD	A	B	C	REPLACES
Dayton 	399	5/8"	1/2"	2"	2"	Batco 13-5007 BWP M-27 Dayton 09-839910 Euclid E-5927 GLP GL-3083 Leland W-124 Meritor R005927G Spicer 52-1440
	853	3/4"	1/2"	2"	2"	Automann 203.1009 Batco 13-5012 BWP M-1122 Dayton 09-885310 Euclid E-5926 GLP GL-3085 Leland W-408 Meritor R005926G Spicer 52-1441
Dayton 	729	3/4"	3/16"	2-1/2"	2-5/8"	Batco 13-5020 BWP M-30B Dayton 09-007295 Euclid E-5838 GLP GL-3087 Leland W-407 Meritor R005838G Spicer 52-1436
Dayton 	123	3/4"	1-1/8"	2-7/8"	2-1/2"	Automann 203.2013 Batco 13-4002 BWP M-3 Dayton 09-612317 Euclid E-5571A GLP GL-3096 Leland W-3 Meritor R005571AG Spicer 52-1301 Webb 16123
	Available In Pails (100)					
	708	3/4"	1-3/8"	2-7/8"	2-1/2"	Automann 203.2014 Batco 13-4010 BWP M-1123 Dayton 09-870817 Erie E12 Euclid E-5784A GLP GL-3103 Leland W-405 Meritor R005784AG Spicer 52-1309
Dayton 	993	3/4"	1-1/2"	2-7/8"	2-1/2"	Automann 203.2015 Batco 13-4004 BWP M-8 Dayton 09-699317 Erie E3 Euclid E-5040A GLP GL-3098 Leland W-120 Meritor R005040AG Spicer 52-1304
	Available In Pails (75)					

RIM CLAMPS

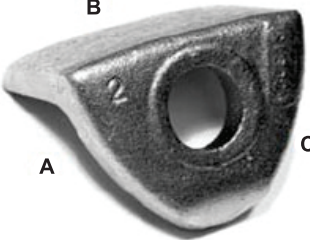
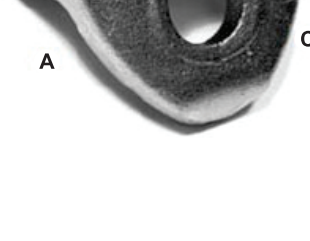
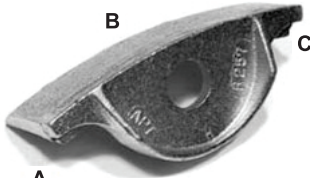
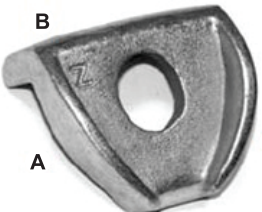
TYPE	PART NO.	STUD	A	B	C	REPLACES
Dayton 	235	3/4"	1-3/4"	2-7/8"	2-1/2"	Automann 203.2016 Batco 13-4006 BWP M-4 Dayton 09-623517 Euclid E-5572A GLP GL-3097 Leland W-4 Meritor R005572AG Spicer 52-1306
	Available In Pails (75)					
	053	3/4"	1-7/8"	2-7/8"	2-13/32"	Automann 203.2018 Batco 13-4011 BWP M-1124 Dayton 09-705317 Euclid E-5785A GLP GL-3099 Leland W-406 Meritor R005785G Spicer 52-1310
Dayton 	256	3/4"	1-1/8"	6"	2-7/16"	Automann 203.2020 Batco 13-4723 BWP M-1141 Dayton 09-006256 Euclid E-5827 GLP GL-3112 Leland W-536 Mack 15QJ16 Meritor R005827G Spicer 52-1392
	302	3/4"	1-7/16"	6-5/8"	2-7/16"	Automann 203.2022 Batco 13-4725 BWP M-1105 Dayton 09-006302 Euclid E-5829 GLP GL-3114 Leland W-184 Meritor R005829 Spicer 52-1395
	257	3/4"	1-13/16"	6"	2-7/16"	Automann 203.2023 Batco 13-4724 BWP M-1142 Dayton 09-006257 Euclid E-5828 GLP GL-3113 Leland W-450 Meritor R005828G Spicer 52-1394
Clear Zinc						
Goodyear 	008	3/4"	1-5/16"	2-1/2"	2-13/16"	Batco 13-4850 BWP M-1282 Euclid E-5885 GLP GL-3158 Goodyear CL1008 Leland W-456 Meritor R005885G Spicer 52-1385
	Yellow Zinc					

RIM CLAMPS

TYPE	PART NO.	STUD	A	B	C	REPLACES
Gunite 						Automann 203.1010 Batco 13-5014 BWP M-2460 Euclid E-5902 GLP GL-3243 Gunite WP722 Leland W-256 Meritor R005902G Spicer 52-1430
	722	3/4"	1/2"	2-1/2"	3-5/8"	
Gunite 						Batco 13-5015 BWP M-2461 Euclid E-9023 GLP GL-3244 Gunite WP725 Leland W-418 Meritor R009023G
	725	3/4"	5/8"	2-1/2"	3-5/8"	
Gunite 						Automann 203.1011 Batco 13-5009 BWP M-1173 Euclid E-5890 GLP GL-3246 Gunite WP544 Leland W-416 Meritor R005890 Spicer 52-1422
	544	3/4"	1/2"	2"	2-1/8"	
Gunite 						Batco 13-5008 BWP M-1188 Euclid E-5889 GLP GL-3245 Gunite WP515 Leland W-415 Meritor R005889 Spicer 52-1421
	515	3/4"	1/2"	2"	2-5/32"	
Gunite 						Automann 203.1013 Batco 13-5010 BWP M-1189 Euclid E-5891 GLP GL-3247 Gunite WP545 Leland W-417 Meritor R005891 Spicer 52-1423
	545	3/4"	3/4"	2"	2-5/32"	
Gunite 						Batco 13-4530 BWP M-1243 Euclid E-5905A GLP GL-3256 Gunite W1110 Leland W-258 Meritor R005905AG Spicer 52-1336
	110	3/4"	1-3/16"	2-7/8"	2-3/8"	

RIM CLAMPS

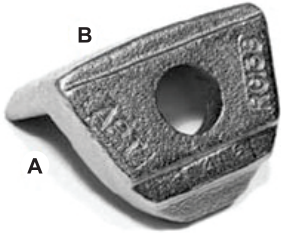
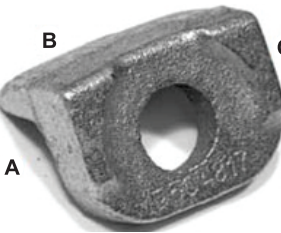
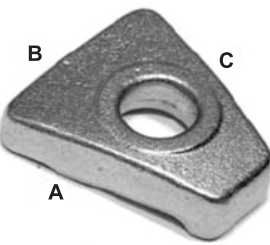
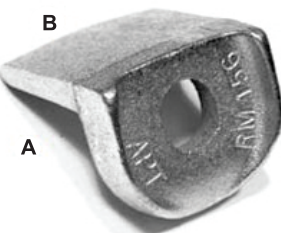
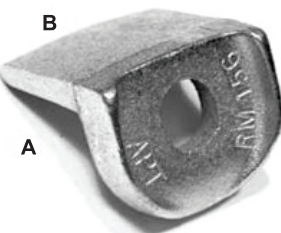
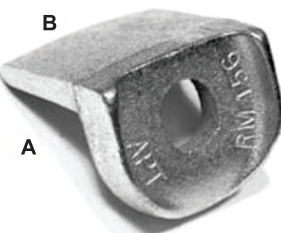
TYPE	PART NO.	STUD	A	B	C	REPLACES
Gunite 	138	3/4"	1-3/8"	2-7/8"	2-3/8"	Batco 13-4531 BWP M-1242 Euclid E-5904A GLP GL-3255 Gunite W1138 Leland W-257 Meritor R005904A Spicer 52-1337
Gunite 	267	3/4"	1-1/16"	2-3/8"	1-3/4"	Batco 13-4601 BWP M-1134 Euclid E-5747 GLP GL-3257 Gunite WP267 Leland W-135 Meritor R005747 Spicer 52-1370
Mack 	251	3/4"	5/16"	2-1/2"	2-5/8"	Automann 203.1015 Batco 13-5016 BWP M-3213 Euclid E-6053 GLP GL-3263 Leland W-565 Mack 15QJ251 Meritor R006053G Spicer 52-1403
Mack 	238	3/4"	1-7/8"	2-1/2"	2-7/16"	Batco 13-4702 BWP M-1175 Euclid E-5781 GLP GL-3271 Leland W-448 Mack 15QJ223BP8 Meritor R005781G Spicer 52-1380
Mack 	233	3/4"	2-1/8"	2-1/2"	2-7/16"	Automann 203.2041 Batco 13-4704 BWP M-1249 Euclid E-5821 GLP GL-3279 Leland W-467 Mack 15QJ223BP3 Meritor R005821G Spicer 52-1382
Rear 	236	3/4"	2-3/8"	2-1/2"	2-7/16"	Automann 203.2042 Batco 13-4703 BWP M-1127 Euclid E-5783 GLP GL-3270 Leland W-449 Mack 15QJ223BP6 Meritor R005783 Spicer 52-1381

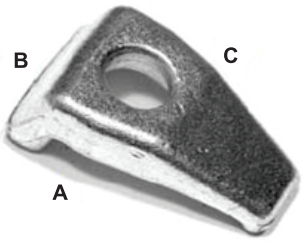
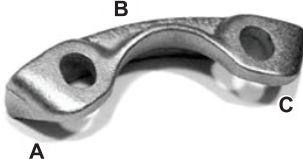

RIM CLAMPS

TYPE	PART NO.	STUD	A	B	C	REPLACES
Navistar 	201	3/4"	1-1/4"	2-1/16"	3-7/16"	Batco 13-5001 BWP M-3214 Euclid E-6054 GLP GL-3294 Leland W-494 Meritor R006054G Navistar 452010C1 Spicer 52-1368
Webb 	314	3/4"	1-1/4"	7-3/4"	1-13/16"	Batco 13-4807 BWP M-1183 Euclid E-5953 GLP GL-3298 Leland W-420 Meritor R005953G Spicer 52-1410 Webb 3314
3 Spoke Wheel						





TORQUE CHART

MOUNTING TYPE	NUT THREAD	TORQUE LEVEL
Hub Piloted Flange Nut	M 20 x 1.5 M 22 x 1.5	280 - 330 Ft. Lbs. * 450 - 500 Ft. Lbs. *
		* Oiled
Stud Piloted, Double Cap Nut - Standard	3/4" - 16 1-1/8" - 16 M 20 x 1.5 M 30 x 1.5	450 - 500 Ft. Lbs. 450 - 500 Ft. Lbs. 450 - 500 Ft. Lbs. 450 - 500 Ft. Lbs.
Cast Spoke Wheels	5/8" - 11 3/4" - 10	160 - 200 Ft. Lbs. 200 - 260 Ft. Lbs.
Light Truck	7/16", 1/2" - 20 9/16", 5/8" - 18	75 - 85 Ft. Lbs. 175 - 200 Ft. Lbs.







DRUM BOLT HARDWARE

GRADE 8	PART NO.	THREAD	LENGTH	REPLACES		
<p style="text-align: center;">Assembly Consisting Of:</p> <p>(1) Bolt (1) Washer (1) Nut</p>	807	5/8" - 18	2"	Batco Euclid Leland Meritor	13-6581 E-5970 W-562 R005970	
	Available In Pails (300)					
	808	3/4" - 10	2"	Batco Euclid Leland Meritor	13-6582 E-5971 W-563 R005971	
	Available In Pails (200)					
	809	3/4" - 16	2"	Batco Euclid Leland Meritor	13-6583 E-5972 W-564 R005972	
	<p style="text-align: center;">Bolt Only</p> 	800	5/8" - 18	2"	Batco BWP Euclid Spicer	13-6521 M-2454 E-5966 54-1650
		801	3/4" - 10	2"	Batco BWP	13-6522 M-2455
		802	3/4" - 16	2"	Batco BWP Euclid Spicer	13-6523 M-2456 E-5968 54-1651
		Available In Pails (200)				
<p style="text-align: center;">Washer Only</p> 		800W	O.D. 1-5/16"	I.D. 21/32"	Dayton Euclid Meritor	SUW-58 E-2547 R002547
		802W	1-15/32"	13/16"	Dayton Euclid Meritor	334-166 E-2545 R002545
<p style="text-align: center;">Lock Nut Only</p>  <p style="text-align: center;">Stover "C" Lock Nut Zinc/Waxed</p>	804	THREAD 5/8" - 18	HEX 15/16"	Automann BWP Dayton Euclid Spicer	LN104 M-2457 SLN-104/334-144 E-1943 54-1660	
	805	3/4" - 10	1-1/8"	Automann BWP Dayton Euclid Leland Meritor	LNC105 M-2458 SLNC-105 E-4347 LNC105 R002991	
	806	3/4" - 16	1-1/8"	Automann Batco BWP Euclid Leland Meritor Spicer	LN105 SLN-105 M-2459 E-4961A W-451 R004961A 54-1661	
	Available In Pails (200)					
	Available In Pails (200)					
	Available In Pails (200)					







AXLE NUTS

PART NO.	NOTES	A.F. THRD THK			REPLACES
 2296	Outer Nut Use Wrench 1920 FD 900/1, FE 900 And FF 901/931	2-1/4"	1-1/2" - 12	7/16"	Automann 209.1111 Batco 06-354 BWP M-1956 Euclid E-2296 Leland L-1331 Meritor R002296 1227B106
 2299	Inner Nut Use Wrench 1922 FD 900/1, FE 900 And FF 901/931	2-5/8"	1-1/2" - 12	3/8"	Automann 209.1110 Batco 06-358 BWP M-1959 Euclid E-2299 Leland L-1334 Meritor R002299 1227U541
 2297	Lock Washer FD 900/1, FE 900 And FF 901/931	O.D. 2-3/4"	I.D. 1-17/32"	THK .187"	Automann 209.2107 Batco 06-355 BWP M-1958 Euclid E-2297 Leland L-1333 Meritor R002297 1229G475
 2298	Lock FD 900/1, FE 900 And FF 901/931	3"	1-1/2"	.048"	Automann 209.2109 Batco 06-357 BWP M-1957 Euclid E-2298 Leland L-1332 Meritor R002298 1229F474
 3568	Inner Nut Use Wrench 1922 Eaton/Dana 10,12,13, 14,000#	A.F. 2-5/8"	THRD 1-1/2" - 18	THK 3/8"	Automann 209.2362 Batco 06-347 Eaton 815622 Leland L-3568
 3569	Outer Nut Use Wrench 1920 Eaton/Dana 10,12,13, 14,000#	2-1/4"	1-1/2" - 18	7/16"	Automann 209.2360 Batco 06-345 Eaton 815638 Leland L-3569



AXLE NUTS

PART NO.	NOTES	O.D.	I.D.	THK	REPLACES																																																		
 3570	Lock Eaton/Dana 10,12,13, 14,000#	3"	1-1/2"	.048"	Eaton Leland 817134 L-3570																																																		
 3571	Lock Washer Eaton/Dana 10,12,13, 14,000#	2-3/4"	1-1/2"	.187"	Eaton Leland 815623 L-3571																																																		
 5210	Inner Nut "Trade" Axles Use Wrench 1927	3-13/16"	2-5/8" - 16	3/8"	<table border="0"> <tr> <th style="text-align: left;">A.F.</th> <th style="text-align: left;">THRD</th> <th style="text-align: left;">THK</th> <th></th> <th></th> </tr> <tr> <td>Automann</td> <td></td> <td></td> <td>209.1307</td> <td></td> </tr> <tr> <td>Batco</td> <td></td> <td></td> <td>06-203</td> <td></td> </tr> <tr> <td>BWP</td> <td></td> <td></td> <td>M-682</td> <td></td> </tr> <tr> <td>Euclid</td> <td></td> <td></td> <td>E-540</td> <td></td> </tr> <tr> <td>Leland</td> <td></td> <td></td> <td>L-176</td> <td></td> </tr> <tr> <td>Meritor</td> <td></td> <td></td> <td>1227C549</td> <td></td> </tr> <tr> <td>Spicer</td> <td></td> <td></td> <td>12-391</td> <td></td> </tr> <tr> <td></td> <td></td> <td></td> <td>M10HN101</td> <td></td> </tr> <tr> <td>Std Forge</td> <td></td> <td></td> <td>103103-002</td> <td></td> </tr> </table>	A.F.	THRD	THK			Automann			209.1307		Batco			06-203		BWP			M-682		Euclid			E-540		Leland			L-176		Meritor			1227C549		Spicer			12-391					M10HN101		Std Forge			103103-002	
A.F.	THRD	THK																																																					
Automann			209.1307																																																				
Batco			06-203																																																				
BWP			M-682																																																				
Euclid			E-540																																																				
Leland			L-176																																																				
Meritor			1227C549																																																				
Spicer			12-391																																																				
			M10HN101																																																				
Std Forge			103103-002																																																				
 5200	Outer Nut "Trade" Axles Use Wrench 1909	3-1/4"	2-5/8" - 16	3/8"	<table border="0"> <tr> <td>Automann</td> <td>209.1308</td> </tr> <tr> <td>Batco</td> <td>06-201</td> </tr> <tr> <td>BWP</td> <td>M-684</td> </tr> <tr> <td>Euclid</td> <td>E-572</td> </tr> <tr> <td>Leland</td> <td>L-178</td> </tr> <tr> <td>Meritor</td> <td>1227B756</td> </tr> <tr> <td>Spicer</td> <td>12-393</td> </tr> <tr> <td></td> <td>M10HN102</td> </tr> <tr> <td>Std Forge</td> <td>103102-001</td> </tr> </table>	Automann	209.1308	Batco	06-201	BWP	M-684	Euclid	E-572	Leland	L-178	Meritor	1227B756	Spicer	12-393		M10HN102	Std Forge	103102-001																																
Automann	209.1308																																																						
Batco	06-201																																																						
BWP	M-684																																																						
Euclid	E-572																																																						
Leland	L-178																																																						
Meritor	1227B756																																																						
Spicer	12-393																																																						
	M10HN102																																																						
Std Forge	103102-001																																																						
 5660	Tab Lock Washer "Trade" Axles 5/32" Tab	4-1/32"	2-41/64"	1/16"	<table border="0"> <tr> <th style="text-align: left;">O.D.</th> <th style="text-align: left;">I.D.</th> <th style="text-align: left;">THK</th> <th></th> <th></th> </tr> <tr> <td>Automann</td> <td></td> <td></td> <td>209.2313</td> <td></td> </tr> <tr> <td>Batco</td> <td></td> <td></td> <td>06-230</td> <td></td> </tr> <tr> <td>BWP</td> <td></td> <td></td> <td>M-1068</td> <td></td> </tr> <tr> <td>Euclid</td> <td></td> <td></td> <td>E-2237</td> <td></td> </tr> <tr> <td>Leland</td> <td></td> <td></td> <td>L-1327</td> <td></td> </tr> <tr> <td>Meritor</td> <td></td> <td></td> <td>R002237</td> <td></td> </tr> <tr> <td>Spicer</td> <td></td> <td></td> <td>12-394</td> <td></td> </tr> <tr> <td></td> <td></td> <td></td> <td>M10HN151</td> <td></td> </tr> <tr> <td>Std Forge</td> <td></td> <td></td> <td>105106</td> <td></td> </tr> </table>	O.D.	I.D.	THK			Automann			209.2313		Batco			06-230		BWP			M-1068		Euclid			E-2237		Leland			L-1327		Meritor			R002237		Spicer			12-394					M10HN151		Std Forge			105106	
O.D.	I.D.	THK																																																					
Automann			209.2313																																																				
Batco			06-230																																																				
BWP			M-1068																																																				
Euclid			E-2237																																																				
Leland			L-1327																																																				
Meritor			R002237																																																				
Spicer			12-394																																																				
			M10HN151																																																				
Std Forge			105106																																																				
 5300	Lock Washer "Trade" Axles	3-15/16"	2-41/64"	1/4"	<table border="0"> <tr> <td>Automann</td> <td>209.2206</td> </tr> <tr> <td>Batco</td> <td>06-202</td> </tr> <tr> <td>BWP</td> <td>M-683</td> </tr> <tr> <td>Euclid</td> <td>E-573</td> </tr> <tr> <td>Leland</td> <td>L-177</td> </tr> <tr> <td>Meritor</td> <td>R000573</td> </tr> <tr> <td>Spicer</td> <td>12-392</td> </tr> <tr> <td></td> <td>M10HN100</td> </tr> <tr> <td>Std Forge</td> <td>105107</td> </tr> </table>	Automann	209.2206	Batco	06-202	BWP	M-683	Euclid	E-573	Leland	L-177	Meritor	R000573	Spicer	12-392		M10HN100	Std Forge	105107																																
Automann	209.2206																																																						
Batco	06-202																																																						
BWP	M-683																																																						
Euclid	E-573																																																						
Leland	L-177																																																						
Meritor	R000573																																																						
Spicer	12-392																																																						
	M10HN100																																																						
Std Forge	105107																																																						

AXLE NUTS

PART NO.	NOTES	O.D.	I.D.	THK	REPLACES
 5300S	Lock Washer Manual Adjustment Includes Set Screw Meritor "TN" And "TQ" Series Axles	3-7/8"	2-41/64"	1/4"	Batco 06-198 BWP M-2567 Euclid E-3008 Leland L-3213 Meritor A1229W2545
 2303	Inner Nut Use Wrench 1914 Rockwell "TP", "TR", "Q" And "R" Series Axles	4"	3-1/4" - 12	3/8"	Automann 209.1222 Batco 06-411 BWP M-1980 Euclid E-2303 Leland L-1355 Meritor R002303 Spicer 12-417
 2305	Outer Nut Use Wrench 1914 Rockwell "TP", "TR", "Q" And "R" Series Axles	4"	3-1/4" - 12	3/8"	Automann 209.1223 Batco 06-412 BWP M-1978 Euclid E-2305 Leland L-1353 Meritor R002305 Spicer 12-419
 2304	Lock Washer For Use With Above	4-3/8"	3-1/4"	3/16"	Automann 209.2214 Batco 06-413 BWP M-1979 Euclid E-2304 Leland L-1354 Meritor R002304 Spicer 12-418
 2301	Both Sides Ground For More Exact Adjustment Without The Expense Of Single Nut Systems Replaces 2304	4-5/16"	3-5/16"	5/32" (.160)	
 2302	Tab Lock For Use With 2303, 2305 And 2301	4"	3-5/16"	3/64" (.045)	

AXLE NUTS

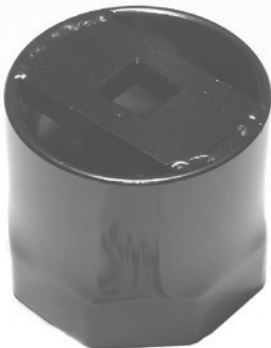

PART NO.	NOTES	A.F. THRD THK			REPLACES
 5403	Use With 5401 Axle Nut For "Propar" 1/4" x 1"				Automann CP14100 Batco 06-229 BWP M-1430 Euclid E-1559 Leland L-1762 Meritor R001559 Spicer 12-403
 5401	Fruehauf "Propar" Use Wrench 9012 Use With 5403 Cotter Pin (1/4" Dia. x 1" Lg.)	4-3/4"	3-1/2" - 12	1-1/8"	Automann M7568 Batco 06-226 BWP M-1050 Euclid E-2550 Fruehauf ACE8510-001 Leland L-1395 Meritor R002550 Spicer 12-400
 5402	Fruehauf "Propar" Use With 5401	O.D. 5-1/16"	I.D. 3-1/2"	THK 7/32"	Automann 209.2316 Batco 06-228 BWP M-1051 Euclid E-1561 Fruehauf AXA0408-1 Leland L-893 Meritor R001561 Spicer 12-402

AXLE NUT WRENCHES

	PART NO.	SIZE	REPLACES
	1920	2-1/4" 6 PT.	Automann 210.1920 Batco 11-1920 Euclid E-1920 Leland L-1920
	1921	2-1/2" 6 PT.	Automann 210.1921 Batco 11-1921 Euclid E-1921 Leland L-1921
	1904	2-9/16" 6 PT.	Automann 210.1904 Batco 11-1904 Euclid E-1904 Leland L-1904
	1922	2-5/8" 6 PT.	Automann 210.1922 Batco 11-1922 Euclid E-1922 Leland L-1922
	1923	2-3/4" 6 PT.	Automann 210.1923 Batco 11-1923 Euclid E-1923 Leland L-1923
	1908	3-1/4" 6 PT.	Automann 210.1908 Batco 11-1908 Euclid E-1908 Leland L-1908
	1909	3-1/4" 8 PT.	Automann 210.1909 Batco 11-1909 Euclid E-1909 Leland L-1909
	1910	3-1/2" 6 PT.	Automann 210.1910 Batco 11-1910 Euclid E-1910 Leland L-1910
	1925	3-3/4" 8 PT.	Automann 210.1925 Batco 11-1925 Euclid E-1925 Leland L-1925
	1927	3-13/16" 8 PT.	Automann 210.1927 Batco 11-1927 Euclid E-1927 Leland L-1927
	1912	3-7/8" 6 PT.	Automann 210.1912 Batco 11-1912 Euclid E-1912 Leland L-1912
	1913	3-7/8" 8 PT.	Automann 210.1913 Batco 11-1913 Euclid E-1913 Leland L-1913

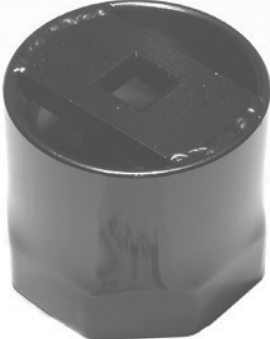

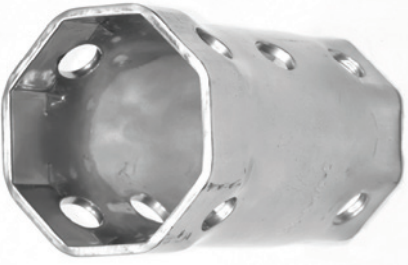

AXLE NUT WRENCHES

	PART NO.	SIZE	REPLACES
	1914	4" 6 PT.	Automann 210.1914 Batco 11-1914 Euclid E-1914 Leland L-1914
	1915	4-1/8" 6 PT.	Automann 210.1915 Batco 11-1915 Euclid E-1915 Leland L-1915
	1917	4-3/8" 8 PT.	Automann 210.1917 Batco 11-1917 Euclid E-1917 Leland L-1917
	1919	4-7/8" 8 PT.	Automann 210.1919 Batco 11-1919 Euclid E-1919 Leland L-1919





PART NO.	NOTES	REPLACES
	<p>8-Point Double End Wrench</p> <p>For All 3-3/8" And 3-7/8" Axle Nuts</p>	Batco 11-1954 BWP M-1940 Euclid E-844 Leland L-1940 Meritor 3256E5 Spicer 13-496
5000		
	<p>For 5401 "Propar" Spindle Nuts And 9013 Hub Caps</p>	Automann 210.1941 Batco 11-1941 BWP M-1941 Euclid E-1597A Meritor R001597A
9012		

HUB CAPS





For Fruehauf "Propar" Axle

PART NO.		THREAD SIZE	REPLACES
	Lexan	6-1/4" - 8	Automann 180.10618 Batco 11-0670 BWP M-1052 Euclid E-04075 Fruehauf ACC7538-900 Leland L-885 Meritor R004075 Spicer 8-295 Stemco 340-4975
	9013		
	Includes 9014 And 9015		
	Lexan	6-1/4" - 8	Batco 11-0670V Euclid E-04075V
	9013V		
Vented Version Includes 9014 And 9015V			
	Lexan	6-1/4" - 8	Batco 11-0671 BWP M-2764 Euclid E-04075H Fruehauf ACC6113-900 Spicer 8-295H Stemco 640-0003
	9016		
	Hubodometer Version Includes 9014		
	Die Cast	6-1/4" - 8	Leland L-3543 Meritor R64075A
	9013A		
	Includes 9014 And 9015		
	O-Ring Use With 9013, 9013A, 9013G And 9016 Hub Caps	6" O.D.	Automann 180.10618.1 Batco 11-0680 BWP M-1065 Euclid E-05500 Leland L-1700 Meritor R005500 Spicer 8-296 Stemco 330-3077
	9014	5-1/2" I.D.	
Buna N			

HUB CAPS



PART NO.		SIZE	REPLACES	
	Die Cast Use 9024-1 Gasket 9024	6 - Hole	Meritor Stemco	R64024 340-4024
	Die Cast Grease Version Use 9024-1 Gasket 9024G		Meritor Stemco	R64024G 342-4024
	Die Cast With Side Plug Use 9024-1 Gasket 9024P	4-1/2" B.C.	Automann Stemco	180.10622 343-4024
	Die Cast Use 9042-1 Gasket 9042	6 - Hole	Stemco	340-4042
	Die Cast With Side Plug Use 9042-1 Gasket 9042P		5-1/8" B.C.	Stemco
	Die Cast Use 9008-1 Gasket 9008	5 - Hole	Stemco	340-4013
	Die Cast Grease Version Use 9008-1 Gasket 9008G		Stemco	342-4013
	Die Cast With Side Plug Use 9008-1 Gasket 9008P		Automann Stemco	180.10624 343-4013
	Stamped Steel Use 9008-1 Gasket 9008S	5-1/2" B.C.		
	Die Cast Use 9018-1 Gasket 9098	6 - Hole	Stemco	340-4098
	Die Cast With Side Plug Use 9018-1 Gasket 9098P		5-1/2" B.C.	Stemco
	Die Cast Use 9018-1 Gasket 9095	6 - Hole	Stemco	340-4095
	Die Cast With Side Plug Use 9018-1 Gasket 9095P		5-1/2" B.C.	Stemco

HUB CAPS/WINDOW KITS

	PART NO.	SIZE	REPLACES
	Die Cast Use 9018-1 Gasket	6 - Hole	Automann 180.10619 Batco 11-0674 BWP M-2774 Leland L-2921 Stemco 340-4009
	9009		Automann 180.10616 Batco 11-0660 BWP M-767 Euclid E-975 Leland L-454 Stemco 340-5097
	Stamped Steel Grease Version Use 9018-1 Gasket		9009G
	Die Cast Hubodometer Version Use 9018-1 Gasket	5-1/2" B.C.	Stemco 347-4009
	9009H		Leland L-3602 Stemco 343-4009
	Die Cast With Side Plug Use 9018-1 Gasket		9009P
Stamped Steel Use 9018-1 Gasket	9009S		
	Die Cast	6 - Hole	Stemco 340-4249
	9249	5-9/16" B.C.	Stemco 343-4249
Die Cast With Side Plug	9249P		
	Die Cast With Side Plug	6 - Hole	Stemco 343-4195
	9195P	6-3/4" B.C.	
	9009W		Automann 180.10620 Batco 11-0675 Stemco 359-5995
	9024W		Stemco 359-5999
	9249W		Automann 180.10626 Stemco 359-5912

Window Kits

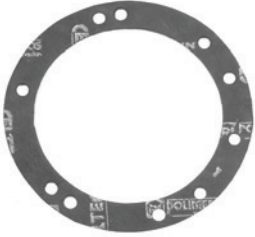
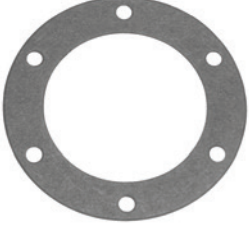
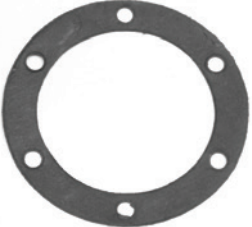
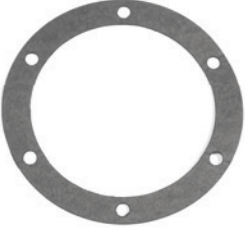
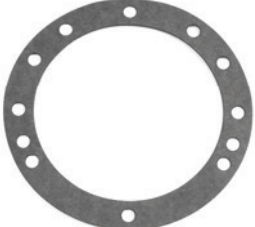



HUB CAP GASKETS AND PLUGS

	PART NO.	SIZE	REPLACES
	Use With 9008 Series Hub Caps 9008-1	5 - Hole 5-1/2" B.C.	BWP M-2772 Stemco 330-3013
	Use With 9024 Series Hub Caps 9024-1	6 - Hole 4-1/2" B.C.	Batco 13-7156 Stemco 330-3024
	Use With 9042 Series Hub Caps 9042-1	6 - Hole 4" I.D. 5-1/8" B.C.	Batco 13-7154 Stemco 330-3041
	Use With 9009, 9098, 9095 Series Hub Caps 9018-1	6 - Hole 6-13/16" O.D. 4-5/16" I.D. 5-1/2" B.C.	Automann 180.10619.1 Batco 13-7151 BWP M-2768 Leland L-453 Spicer 8-304 Stemco 330-3009
	Gasket Universal 9018-2	3, 5, 6 - Hole 6-3/8" O.D. 4-7/16" I.D. 5-1/2" B.C.	Batco 13-7150 BWP M-837 Euclid E-03009 Stemco 330-3067
	Universal Plug 9015/9015V Solid Or Vented Buna N	---	Automann 180.10617 Batco 11-0681 BWP M-1066 Euclid E-04000/V Leland L-1701 Spicer 8-297 Stemco 359-5990
	Black Vented Plug 9009V Use With 9009 And 9009P Hub Cap	---	





BRAKE BLOCK BOLTS

PART NO.		REPLACES
	Brass Bolt 1/4" - 28 x 1"	Automann 145.F014100BN Batco 01-601 BWP M-536 Euclid E-634X Leland L-264
	634X	
	Replaces No. 10 Rivet	
	Steel Bolt 1/4" - 28 x 1"	
999X		
Replaces No. 10 Rivet		
Brass Bolt 3/8" - 16 x 1-1/4"	Batco 01-605 BWP M-534J Euclid E-628X Leland L-144G	
628X		
Coarse Thread		
Brass Bolt 3/8" - 24 x 1-1/4"		Batco 01-604 BWP M-534H Euclid E-636X Leland L-144F
636X		
Fine Thread		
Brass Bolt 3/8" - 16 x 1-1/2"	Batco 01-603 BWP M-534G Euclid E-635X Leland L-144C	
635X		
Coarse Thread		
Brass Bolt 3/8" - 24 x 1-1/2"		Batco 01-602 BWP M-534F Euclid E-583X Leland L-144A
583X		
Fine Thread		
		



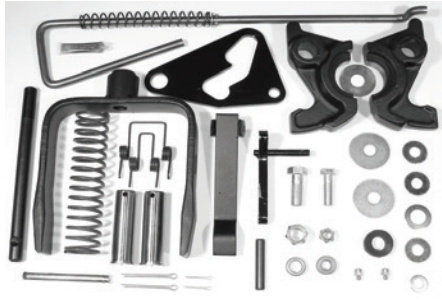

FASTENERS

PART NO.	NOTES	REPLACES
	<p>Cross-Member Bolt Kit</p> <p>Includes: (8) 3/8-16 x 1-1/4" Carriage Bolt (8) 3/8" Nylon Washer (8) 3/8" Flange Lock Nut</p> <p>Available In Pails (175)</p>	<p>Automann 537.1001 Fruehauf ZCF003435901 Great Dane GD 57118 New Life 1157015 Strick 36ZCF3435901 Trailmobile 700-50-16 Utility UTRFK</p>
CMBK		
	<p>Bottom Rail Bolt Kit</p> <p>Includes: (8) 3/8-24 x 1-1/4" Torx Drive Bolt (8) Nylon Insert Lock Nut</p> <p>Available In Pails (175)</p>	<p>New Life 1157013</p>
BRBK		
	<p>Mud Flap Bolt Kit</p> <p>Includes: (4) 3/8-16 x 1-1/4" Bolt (4) 3/8" Nut (8) 3/8" Flat Washer (4) 3/8" Lock Washer</p> <p>Available In Pails (300)</p>	
MFBK		
	<p>Landing Gear Bolt Kit</p> <p>Grade 5</p> <p>Includes: (10) 5/8-11 x 1-1/2" Bolt (10) 5/8-11 Nylon Insert Lock Nut</p> <p>Available In Pails (50)</p>	<p>Fruehauf FSP 005-05 KIT Great Dane GD 57121 New Life 1157014 Trailmobile 700-50-35</p>
LGBK		
	<p>Landing Gear Bolt Kit</p> <p>Grade 8</p> <p>Includes: (10) 5/8-11 x 1-1/2" Bolt (10) 5/8-11 Nylon Insert Lock Nut</p> <p>Available In Pails (50)</p>	
LGBK-8		



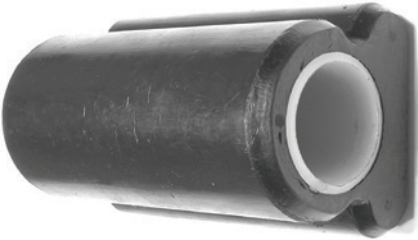

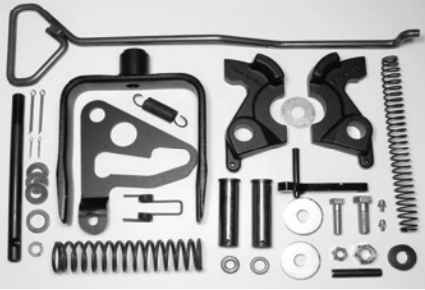
FIFTH WHEEL COMPONENTS

PART NO.	NOTES	REPLACES
 <p style="text-align: center;">63500R/63501L</p>	<p>Major Rebuild Kit For Holland XA-3501-A Top Plate</p> <p>Parts Not Available Individually</p>	<p>Automann KP63500 (Right) KP63501 (Left)</p> <p>Batco 11-0350R/L</p> <p>Holland RK-63500 (Right) RK-63501 (Left)</p>
 <p style="text-align: center;">63503A</p>	<p>Minor Rebuild Kit For Holland XA-3501-A Top Plate</p>	<p>Holland RK-63503A</p>
 <p style="text-align: center;">63503M</p>	<p>Jaw And Pin Kit For Holland XA-3501-A Top Plate</p>	<p>Automann KP63503</p> <p>Holland RK-63503</p>
 <p style="text-align: center;">44130/44130U</p>	<p>Cushion And Pin Kit For Holland XA-3501-A Top Plate</p> <p>44130U Contains Polyurethane Bushing</p> <p>Consists Of: (2) 44131 Pin (2) 44132/U Bushing (2) 44133 Spring Pin</p>	<p>Automann KP104/UB</p> <p>Batco 329-104UK *</p> <p>Euclid E-9569 *</p> <p>Holland RK-004413</p> <p>* For 44130U</p>
 <p style="text-align: center;">44131</p>	<p>Bracket Pin For Holland XA-3501-A Top Plate</p>	<p>Automann KP102</p> <p>Batco 11-0554</p> <p>Euclid E-9568</p> <p>Holland XA-2016</p>



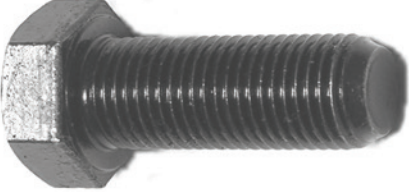

FIFTH WHEEL COMPONENTS

PART NO.	NOTES	REPLACES
	<p>Bushing For Holland XA-3501-A Top Plate</p> <p>Manufactured After 6/87</p> <p>44132U Contains Polyurethane Bushing</p>	<p>Automann KP101/UB BWP M-3824 * Dayton 329-104U * Euclid E-7450 * Holland XB-0011-2</p> <p>* For 44132U</p>
<p style="text-align: center;">44132/44132U</p>		
	<p>Roll Pin For Use With 44130</p>	<p>Automann KP103 Batco 11-0553 Holland XB-21-S-375-1750</p>
<p style="text-align: center;">44133</p>		
	<p>Major Rebuild Kit For Holland XA-351 And XA-331 Top Plates</p> <p>Parts Not Available Individually</p>	<p>Automann KP351A02R/L Batco 11-0351R/L Holland RK-351-A-02 (Right) RK-351-A-L-02 (Left)</p>
<p style="text-align: center;">35102R/35102L</p>		
	<p>Minor Rebuild Kit For Holland XA-351 Top Plate</p>	<p>Automann KP131</p>
<p style="text-align: center;">35102A</p>		
	<p>Jaw And Pin Kit For Holland XA-351 Top Plate</p>	<p>Automann KP35107296 Holland RK-351-07296</p>
<p style="text-align: center;">35102M</p>		

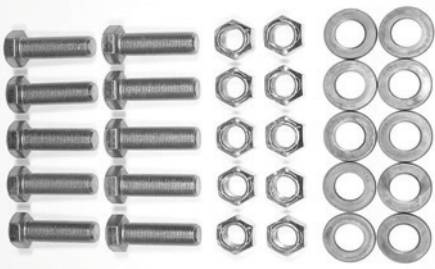

FIFTH WHEEL COMPONENTS

PART NO.	NOTES	REPLACES
 <p style="text-align: center;">44134/44134U</p>	<p>Cushion And Pin Kit For Holland XA-351 Top Plate</p> <p>44134U Contains Polyurethane Bushing</p> <p>Consists Of:</p> <ul style="list-style-type: none"> (2) 44132/U Bushing (2) 44135 Pin (2) 44136 Hex Cap Screw (2) 44137 Lock Nut 	<p>Automann KP130 Batco 11-0352/U Holland RK-06973-1</p>
 <p style="text-align: center;">44135</p>	<p>Bracket Pin For Holland XA-351 Top Plate</p>	<p>Automann KP128 Batco 11-0550 Holland XE-06356</p>
 <p style="text-align: center;">44136</p>	<p>Cap Screw For Holland XA-351 Top Plate</p> <p>(1/2" - 20 x 1-1/4")</p>	<p>Holland XB-C-95</p>
 <p style="text-align: center;">44137</p>	<p>Lock Nut For Use With 44136</p> <p>(1/2" - 20)</p>	<p>Automann PNF104 Holland XB-T-69-A</p>
 <p style="text-align: center;">25240</p>	<p>Fifth Wheel Air Cylinder</p> <p>Painted Steel</p>	<p>Automann KP2524P Holland XA-2524-R</p>



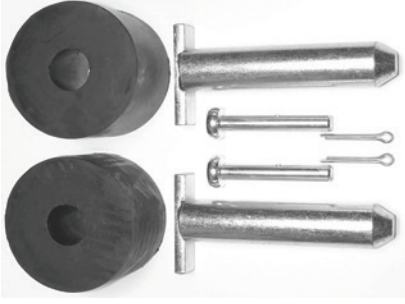
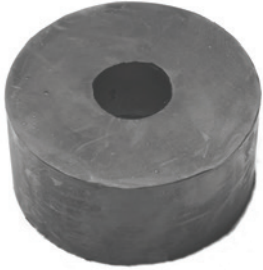
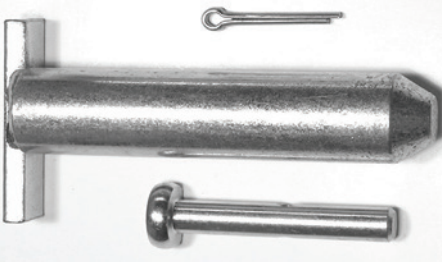

FIFTH WHEEL COMPONENTS

PART NO.	NOTES	REPLACES
	<p>Fifth Wheel Mounting Bolt Kit</p> <p>Consists Of: (10) 5/8" - 18 Grade 8 Bolt (10) Hardened Washer (10) Grade "C" Lock Nut</p>	<p>Holland PK-FAST-10</p>
<p>FWBK</p>		
	<p>Rebuild Kit For Fontaine 5092 Series Top Plate</p>	<p>Automann KP5092L/R Fontaine KIT-RPR-5092L KIT-RPR-5092R</p>
<p>50920L/50920R</p>		
	<p>Jaw And Wedge Spring Set For Fontaine 5092 Series Top Plate</p>	<p>Automann KP114 Fontaine SPR-137 SPR-138</p>
<p>50920JS</p>		
	<p>Bumper Spring Set For Fontaine 5092 And 6000 Series Top Plates</p>	<p>Automann KP115 Fontaine SPR-128</p>
<p>50920BS</p>		
	<p>Rebuild Kit For Fontaine 6000 And 7000 Series Top Plates</p>	<p>Automann KP6000L/R Fontaine KIT-RPR-6000L KIT-RPR-6000R</p>
<p>60000L/60000R</p>		





FIFTH WHEEL COMPONENTS

PART NO.	NOTES	REPLACES
 <p data-bbox="289 514 397 541">60000S</p>	<p data-bbox="589 346 914 373">Timer And Handle Spring Set</p>	<p data-bbox="1044 346 1336 399">Fontaine CD-SPR-236 SPR-338</p>
 <p data-bbox="245 871 446 898">13500/13500U</p>	<p data-bbox="589 594 954 674">Pin And Bushing Kit For Fontaine 5000, 5092 And 6000 Series Top Plates</p> <p data-bbox="589 705 933 758">13500U Contains Polyurethane Bushings</p> <p data-bbox="589 789 829 869">Consists Of: (2) 13501/U Bushing (2) 13502 Pin Kit</p>	<p data-bbox="1044 705 1357 814">Automann KP110/UB Fontaine KIT-PIN-UNVL KIT-PIN-135 KIT-PIN-6000</p>
 <p data-bbox="245 1228 446 1255">13501/13501U</p>	<p data-bbox="589 978 776 1005">Bracket Bushing</p> <p data-bbox="589 1146 933 1199">13501U Contains Polyurethane Bushings</p>	<p data-bbox="1044 1010 1312 1089">Automann KP109/UB Euclid E-7445 * Fontaine BSH-150</p> <p data-bbox="1044 1205 1192 1232">* For 13501U</p>
 <p data-bbox="302 1585 391 1612">13502</p>	<p data-bbox="589 1335 667 1362">Pin Kit</p> <p data-bbox="589 1451 721 1560">Consists of: (1) PIN-135 (1) PIN-124 (1) PIN-165</p>	<p data-bbox="1044 1419 1333 1472">Automann KP106K Fontaine KIT-PIN-191</p>
 <p data-bbox="293 1942 399 1969">73221L</p>	<p data-bbox="589 1692 911 1751">Jost Rebuild Kit For JSK 37H And JSK 37U Top Plates</p> <p data-bbox="589 1887 756 1915">Left Hand Only</p>	<p data-bbox="1044 1751 1349 1803">Automann KP73221-50Z Jost SK73221-50Z</p>



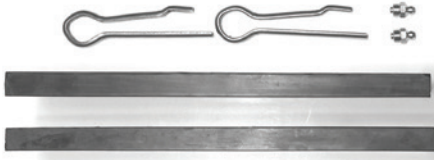

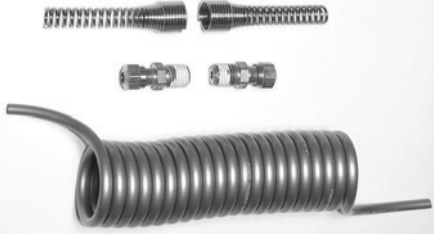
FIFTH WHEEL COMPONENTS

PART NO.	NOTES	REPLACES
 40135L	Simplex Left Hand Jaw/Pad Repair Kit Before 1988 (.578" Pads)	Automann KP40100135 Holland 4000501 Jaw Kit 4000529 Pad Kit
 40136R	Simplex Right Hand Jaw/Pad Repair Kit Before 1988 (.578" Pads)	Automann KP40100136 Holland 4000503 Jaw Kit 4000529 Pad Kit
 40254L	Simplex Left Hand Jaw/Pad Repair Kit (.38" Pads)	Automann KP40100254 Holland 4000501 Jaw Kit 4000528 Pad Kit
 40501L	Simplex Left Hand Jaw Repair Kit 4109939 Jaw 4109916 Pin 9900170 Clinch Pin	Automann KP4000501 Holland 4000501
 40528	Simplex Pad Repair Kit Use With 40501L 4100329 Pad (.38" Pads)	Automann KP4000528 Holland 4000528

FIFTH WHEEL COMPONENTS

PART NO.	NOTES	REPLACES
 <p style="text-align: center;">40503R</p>	<p>Simplex Right Hand Jaw Repair Kit</p> <p>4109940 Jaw 4109916 Pin 9900170 Clinch Pin</p>	<p>Automann KP4000503 Holland 4000503</p>
 <p style="text-align: center;">40529</p>	<p>Simplex Pad Repair Kit</p> <p>4100358 Pad</p> <p>(.578" Pads)</p>	<p>Automann KP4000529 Holland 4000529</p>
 <p style="text-align: center;">25001</p>	<p>Fifth Wheel Slider Coil Set With Bulkhead Fitting And 1/4" Elbow</p> <p>72" Working Length</p>	<p>Holland RK-2500-10 New Life 1010067</p>
 <p style="text-align: center;">A1054</p>	<p>Fifth Wheel Slider Coil Set</p> <p>1/4" O.D. Tubing</p> <p>54" Working Length</p>	
 <p style="text-align: center;">A1072</p>	<p>Fifth Wheel Slider Coil Set</p> <p>1/4" O.D. Tubing</p> <p>72" Working Length</p>	

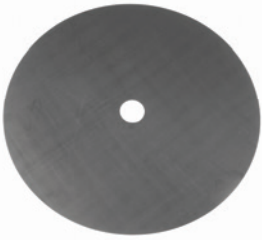

FIFTH WHEEL COMPONENTS

PART NO.	NOTES	REPLACES
 700	Trailer King Pin 2" King Pin For 3/8" Plate AISI 8630 H Alloy Steel Hardened To 302-363 BHN 100% Magna Fluxed	Automann KP100 Batco 11-0212 BWP M-698 Euclid E-700 Holland KP-T809F Leland L-345
 701	Trailer King Pin 2" King Pin For 1/2" Plate AISI 8630 H Alloy Steel Hardened To 302-363 BHN	
 702	King Pin Lock	Automann KPL002 Batco 11-0198 BWP M-770 Euclid E-702 Holland GL-030-3000 Leland L-3391
 710	32" Polyethylene Fifth Wheel Disk And Lock	Butler SD 003
 711	36" Polyethylene Fifth Wheel Disk And Lock	Buyers FWD36 Globetech GT-7101W/SNPRNG
 712	24" Polyethylene Fifth Wheel Disk And Lock	Butler SD 004



FIFTH WHEEL COMPONENTS

PART NO.	NOTES	REPLACES
 710-2	Lock For 710, 711 and 712	Butler SD 002





AIR SYSTEM COMPONENTS

PART NO.	NOTES	REPLACES
A1200	Type 12 Service Chamber	Automann 179.SC12 Euclid E-BC12S
	Without Clevis Assembly	
	Type 12 Service Chamber	
A1200S	Includes Clevis Assembly	
A1600	Type 16 Service Chamber	Automann 179.SC16
	Without Clevis Assembly	
	Type 16 Service Chamber	
A1600S	Includes Clevis Assembly	
A2000	Type 20 Service Chamber	Euclid E-BC20S
	Without Clevis Assembly	
	Type 20 Service Chamber	Automann 179.SC20
A2000S	Includes Clevis Assembly	



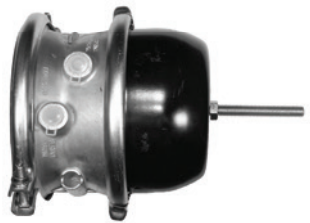
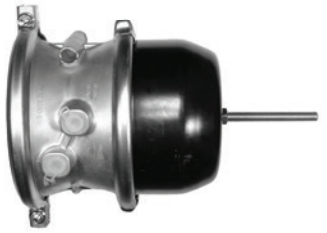

AIR SYSTEM COMPONENTS

PART NO.	NOTES	REPLACES										
A2400	Type 24 Service Chamber	<table style="width: 100%; border: none;"> <tr> <td style="width: 50%;">BWP</td> <td>M-458</td> </tr> <tr> <td>Euclid</td> <td>E-BC24S</td> </tr> <tr> <td>Haldex</td> <td>SC24</td> </tr> <tr> <td>Meritor</td> <td>R870024</td> </tr> <tr> <td>Tectran</td> <td>150-24</td> </tr> </table>	BWP	M-458	Euclid	E-BC24S	Haldex	SC24	Meritor	R870024	Tectran	150-24
BWP	M-458											
Euclid	E-BC24S											
Haldex	SC24											
Meritor	R870024											
Tectran	150-24											
	Without Clevis Assembly											
	Type 24 Service Chamber	<table style="width: 100%; border: none;"> <tr> <td style="width: 50%;">Automann</td> <td>179.SC24</td> </tr> <tr> <td>Batco</td> <td>05-124</td> </tr> <tr> <td>Velvac</td> <td>030019</td> </tr> </table>	Automann	179.SC24	Batco	05-124	Velvac	030019				
Automann	179.SC24											
Batco	05-124											
Velvac	030019											
A2400S	Includes Clevis Assembly											
A3000	Type 30 Service Chamber	<table style="width: 100%; border: none;"> <tr> <td style="width: 50%;">BWP</td> <td>M-459</td> </tr> <tr> <td>Euclid</td> <td>E-BC30S</td> </tr> <tr> <td>Haldex</td> <td>SC30</td> </tr> <tr> <td>Meritor</td> <td>R870030</td> </tr> <tr> <td>Tectran</td> <td>150-300</td> </tr> </table>	BWP	M-459	Euclid	E-BC30S	Haldex	SC30	Meritor	R870030	Tectran	150-300
BWP	M-459											
Euclid	E-BC30S											
Haldex	SC30											
Meritor	R870030											
Tectran	150-300											
	Without Clevis Assembly											
	Type 30 Service Chamber	<table style="width: 100%; border: none;"> <tr> <td style="width: 50%;">Automann</td> <td>179.SC30</td> </tr> <tr> <td>Batco</td> <td>05-130</td> </tr> <tr> <td>Velvac</td> <td>030021</td> </tr> </table>	Automann	179.SC30	Batco	05-130	Velvac	030021				
Automann	179.SC30											
Batco	05-130											
Velvac	030021											
A3000S	Includes Clevis Assembly											





AIR SYSTEM COMPONENTS

PART NO.	NOTES	REPLACES
 A2424S	Type 24/24 Sealed Spring Brake	Batco 2424C
 A2430S	Type 24/30 Sealed Spring Brake	Batco 2430C
 A3030LS	3030 Spring Brake Long Stroke	Automann 179.SB3030SL Batco 3030CL
 A3030PB	3030 Piggy Back Includes Diaphragm And Clamp	Automann 179.PB3030
 A3030PBL	3030 Piggy Back Long Stroke Includes Diaphragm And Clamp	Automann 179.PB3030SL
 A3030S	Type 3030 Sealed Spring Brake	Automann 179.SB3030S Batco 3030C

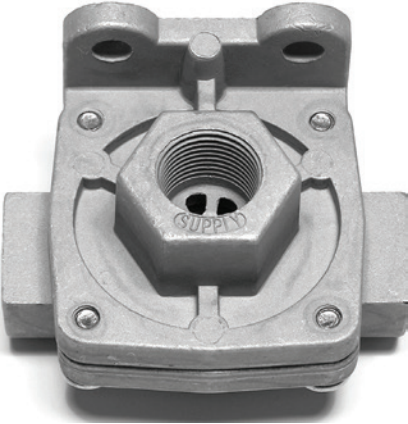

AIR SYSTEM COMPONENTS

PART NO.	NOTES	REPLACES
 DT20	Type 20 Diaphragm	Automann 179.DT20 Batco 12-40020 BWP M-463 Euclid E-12732
 DT24	Type 24 Diaphragm	Automann 179.DT24 Batco 12-40024 BWP M-464
 DT24LS	Type 24 Diaphragm Long Stroke	Automann 179.DT24L
 DT30	Type 30 Diaphragm	Automann 179.DT30 Batco 12-40030 BWP M-466 Euclid E-12733
 DT30LS	Type 30 Diaphragm Long Stroke	Automann 179.DT30L Euclid E-12773

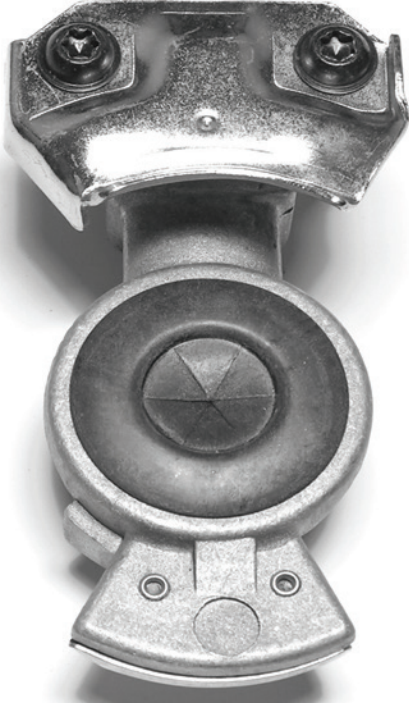
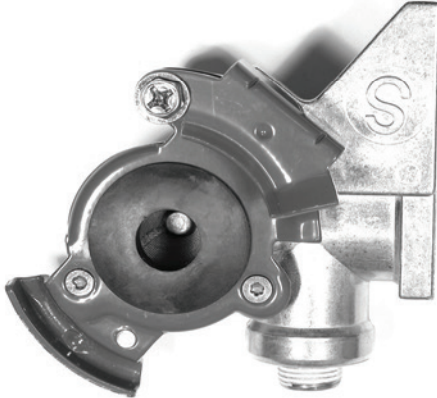

AIR SYSTEM COMPONENTS

PART NO.	NOTES	REPLACES
A9859	 <p>Quick Release Valve 3/8" Supply 3/8" Delivery Die Cast Aluminum Available In Pails (55)</p>	<p>Automann 170.229859 Euclid E-BN229859N Haldex KN32005 Phillips 12-800 Sloan 401143 Tectran 10-229859 Tramec 51102 Velvac 032015</p>
A9860	 <p>Quick Release Valve 1/2" Supply 3/8" Delivery Die Cast Aluminum Available In Pails (55)</p>	<p>Automann 170.229860 Euclid E-BN229860N Haldex KN32011 Phillips 12-801 Sloan 401144 Tectran 10-229860 Tramec 51103 Velvac 032018</p>
A5491	 <p>Brake Governor D-2 Style 105 - 120 PSI Includes Mounting Gasket And (4) 1/8" Socket Head Pipe Plugs</p>	<p>Automann 170.275491 Bendix 275491 Euclid E-BN275491N Haldex KN18530 Meritor R955275491 Sloan 401142</p>
A1030	 <p>Check Valve - One Way Brass Body Male And Female Threads 3/8" NPTF</p>	<p>Automann 170.227870 Haldex KN23010 Sloan 401008 (Brass) 401167 (Steel) Tectran 1030-6 Velvac 320014</p>





AIR SYSTEM COMPONENTS

PART NO.	NOTES	REPLACES
	Universal Glad Hand <hr style="border: 1px solid black;"/> A1450 1/2" Port Available In Pails (75)	Automann 179.1003 Batco 12-40416 BWP M-313A Euclid E-9109 Haldex 11450 Phillips 12-010 Sloan 441017 Tectran 1011 Tramec 36301 Velvac 035038
	Emergency Glad Hand <hr style="border: 1px solid black;"/> A1451 1/2" Port Available In Pails (75)	Automann 179.1002 Batco 12-40419 BWP M-313C Euclid E-9108 Haldex 11451 Phillips 12-008 Sloan 441016 Tectran 1011E Tramec 36201 Velvac 035042
	Service Glad Hand <hr style="border: 1px solid black;"/> A1452 1/2" Port Available In Pails (75)	Automann 179.1001 Batco 12-40418 BWP M-313B Euclid E-9107 Haldex 11452 Phillips 12-006 Sloan 441015 Tectran 10115 Tramec 36101 Velvac 035045
	38 Degree Bracket Style Service <hr style="border: 1px solid black;"/> A1440 3/8" Port	Automann 179.1005 Haldex 11440 Phillips 12-136 Sloan 441023 Tectran 9217 Tramec 36161/56161 Velvac 035092
	38 Degree Bracket Style Emergency <hr style="border: 1px solid black;"/> A1441 3/8" Port	Haldex 11441 Phillips 12-138 Sloan 441019 Tectran 9216 Tramec 36261/56261 Velvac 035093
	Glad Hand Lock <hr style="border: 1px solid black;"/> 703	Sloan 44752 Tramec 59001 Velvac 035150

AIR SYSTEM COMPONENTS

PART NO.	NOTES	REPLACES
	Shut Off Style Service (Blue)	Batco 12-40430 BWP M-3775 Phillips 12-306 Sloan 441001 Tectran 9211 Tramec 36153 Velvac 035094
	A1442	
	3/8" Tube	
	Shut Off Style Emergency (Red)	Batco 12-40431 BWP M-3776 Phillips 12-308 Sloan 441003 Tectran 9212 Tramec 36253 Velvac 035095
	A1443	
	3/8" Tube	
	Double Lip Glad Hand Seal Rubber	Automann 179.1010 Batco 12-40403 BWP M-312 Euclid E-9110 Haldex 10028 Phillips 12-012 Sloan 441749 Tectran 10111 Tramec 36001 Velvac 035005
	9004	
	Available In Pails (1200)	
	Protecta Seal Rubber	Automann 179.1013 Batco 12-40404 BWP M-3998 Euclid E-9111 Haldex 10024 Sloan 441736 Tectran 10113
	9004P	
	Keeps Out Dirt And Critters	
	Polyurethane Seal Service	Automann 179.1012 BWP M-3778 Euclid E-8658-B-BK Haldex DA9017B Phillips 12-0161 Sloan 441738 Tectran 101115B Tramec 36011 Velvac 035010
	9004B	
	Blue	
	Polyurethane Seal Emergency	Automann 179.1011 BWP M-3777 Euclid E-8658-R-BK Haldex DA9017R Phillips 12-0162 Sloan 441739 Tectran 101115R Tramec 36012 Velvac 035009
9004R		
Red		

AIR SYSTEM COMPONENTS

PART NO.	NOTES	REPLACES
	12' Set Red/Blue 6" Leads <hr/> A1012	Automann 179.3003.12 BWP M-498 Euclid E-10742 Haldex 11950 Phillips 11-3120 Sloan 451035N Tectran 17212 Velvac 022002
	15' Set Red/Blue 12" Leads <hr/> A1015	Automann 179.3003.15 BWP M-499 Euclid E-10744 Haldex 11952 Phillips 11-315 Sloan 451036N Tectran 17215 Velvac 022025
	15' Set Red/Blue 1 - 12" Lead 1 - 40" Lead <hr/> A1040	Euclid E-10746 Haldex 11954 Phillips 11-3400 Sloan 451039N Tectran 17215-040 Velvac 022001
	15' Single Red Coil 12" Leads <hr/> A1015R	
	15' Single Blue Coil 12" Leads <hr/> A1015B	
	15' Single Red Coil 1 - 12" Lead 1 - 40" Lead <hr/> A1040R	
	15' Single Blue Coil 1 - 12" Lead 1 - 40" Lead <hr/> A1040B	
	Glad Handles Red/Blue <hr/> A1453	Automann 179.3005 Sloan 44751 Tectran 10116 Velvac 035070

WHEEL BEARINGS

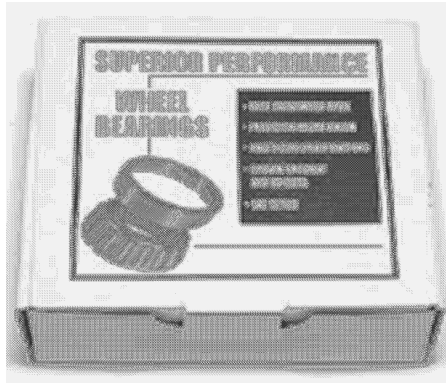

Bearings Are Packaged In Point-Of-Purchase Boxes

**Case Carburized Steel
Precision Micro Finish
Meets OEM Specifications
Crown Raceway And Rollers
SAE 52100**

SIRCO CUP	SIRCO CONE	SIRCO SET	REPLACES
N/A	555S	N/A	N/A
563	567	563/567	SET 425
572	580	572/580	SET 401
572	582	572/582	SET 402
592A	594A	592A/594A	SET 403
592A	598A	592A/598A	SET 404
653	663	653/663	SET 405
3720	3782	3720/3782	SET 406
N/A	6461A	N/A	N/A
47620	47686	47620/47686	SET 411
HM212011	HM212047	HM212011/47	SET 412
HM212011	HM212049	HM212011/49	SET 413
HM218210	HM218248	HM218210/48	SET 414
HM516410	HM516449A	HM516410/49A	SET 421
HM518410	HM518445	HM518410/45	SET 415

WHEEL SEALS



SIRCO	STYLE	REPLACES	
SS307-0743	Stemco	CR CR Plus National Stemco	46305 46300 370025A 372-7097
SS372-7097	Stemco	CR CR Plus National Stemco	46305 46300 370025A 372-7097
SS373-0143	Stemco	CR CR Plus National Stemco	46305 46300 370025A 372-7097
SS382-8036	Stemco	CR CR Plus National Stemco	35066 35058 370001A 382-8036
SS392-9131	Stemco	CR CR Plus National Stemco	47697 47692/47691 370003A 392-9131
SS35066	CR	CR CR Plus National Stemco	35066 35058 370001A 382-8036
SS38780	CR	CR National	38780 370023A
SS42623	CR	CR CR Plus National Stemco	42623 42627 370065A/376590A 372-7099
SS46300	CR Plus	CR CR Plus National Stemco	46305 46300 370025A 373-0143

WHEEL SEALS



SIRCO	STYLE	REPLACES
SS46305	CR	CR 46305 CR Plus 46300 National 370025A Stemco 372-7097
SS47692	CR Plus	CR 47697 CR Plus 47692 National 370003A Stemco 392-9131
SS47697	CR	CR 47697 CR Plus 47692 National 370003A Stemco 392-9131
SS370001	National	CR 35066 CR Plus 35058 National 370001A Stemco 382-8036
SS370003	National	CR 47697 CR Plus 47692/47691 National 370003A Stemco 392-9131
SS370025	National	CR 46305 CR Plus 46300 National 370025A Stemco 372-7097
SS370065	National	CR 42623 CR Plus 42627 National 370065A/376590A Stemco 372-7099
SS755400	Easy Seal	CR 46305 CR Plus 46300 National 370025A Stemco 372-7097
SS761400	Easy Seal	CR 47697 CR Plus 47692/47691 National 370003A Stemco 392-9131

BINKLEY "DURALITE" PARTS

PART NO.	NOTES	REPLACES
 <p>SB1000</p>	<p>Fabricated Equalizer</p> <p>SP 900 Duralite</p> <p>Includes SB1001 Bushing</p>	<p>Automann EQ042 Binkley SP0131 BWP M-4129 Dayton 338-1306 Euclid E-9305 Flagg BK1 Meritor R309305</p>
 <p>SB1013</p>	<p>Equalizer Bushing Assembly</p> <p>Includes: (1) SB1001 Bushing (1) SB1002 Bolt (1) SH1027 Lock Nut</p>	<p>Automann TRK5543</p>
 <p>SB1001</p>	<p>Equalizer Bushing</p> <p>Outside Diameter 3-1/8" Inside Diameter 1-1/32" Overall Length 4"</p>	<p>Automann TRB5543 Binkley PP0054-05 BWP M-1689 Dayton 321-268</p>
 <p>SB1015</p>	<p>Equalizer Bolt Assembly</p> <p>Includes: (1) SB1002 Bolt (1) SH1027 Lock Nut</p>	<p>Automann BKF100600 Dayton 334-825 Euclid E-9309 Meritor R309309</p>
 <p>SB1002</p>	<p>Equalizer Bolt</p> <p>Body Diameter 1" Thread 1" - 14 Length 6"</p>	<p>Automann M4884 Binkley PP0050-73 Flagg B1208-22</p>
 <p>SH1027</p>	<p>Lock Nut</p> <p>Thread 1" - 14 Hex 1-7/16" Height 7/8"</p>	<p>Automann FLN107 Binkley PP0012-37 BWP M-2161 Dayton 334-319 Euclid E-2892 Flagg H104 Meritor R302892</p>





BINKLEY "DURALITE" PARTS

PART NO.	NOTES	REPLACES														
 <p style="text-align: center;">SB1007</p>	<p>Adjustable Torque Arm</p> <p>Center To Center 18-1/2" To 20-3/4"</p> <p>Includes SB1004 Bushing</p>	<table border="0"> <tr><td>Automann</td><td>TR009</td></tr> <tr><td>Binkley</td><td>SP0123</td></tr> <tr><td>BWP</td><td>M-1695</td></tr> <tr><td>Dayton</td><td>345-157</td></tr> <tr><td>Euclid</td><td>E-4824</td></tr> <tr><td>Flagg</td><td>BK4</td></tr> <tr><td>Meritor</td><td>R304824</td></tr> </table>	Automann	TR009	Binkley	SP0123	BWP	M-1695	Dayton	345-157	Euclid	E-4824	Flagg	BK4	Meritor	R304824
Automann	TR009															
Binkley	SP0123															
BWP	M-1695															
Dayton	345-157															
Euclid	E-4824															
Flagg	BK4															
Meritor	R304824															
 <p style="text-align: center;">SB1008</p>	<p>Rigid Torque Arm</p> <p>Center To Center 19-1/4"</p> <p>Includes SB1004 Bushing</p>	<table border="0"> <tr><td>Automann</td><td>TR005B</td></tr> <tr><td>Binkley</td><td>SP0143</td></tr> <tr><td>Dayton</td><td>345-134</td></tr> <tr><td>Euclid</td><td>E-9307</td></tr> <tr><td>Flagg</td><td>BK5</td></tr> <tr><td>Meritor</td><td>R309307</td></tr> </table>	Automann	TR005B	Binkley	SP0143	Dayton	345-134	Euclid	E-9307	Flagg	BK5	Meritor	R309307		
Automann	TR005B															
Binkley	SP0143															
Dayton	345-134															
Euclid	E-9307															
Flagg	BK5															
Meritor	R309307															
 <p style="text-align: center;">SB1014/SB1014U</p>	<p>Torque Arm Bushing Assembly</p> <p>Includes: (1) SB1004 Bushing (1) SB1005 Bolt (1) SB1006 Nut</p> <p>SB1014U Contains SB1004U Bushing</p>	<table border="0"> <tr><td>Automann</td><td>TRK6004B/UB</td></tr> <tr><td>Dayton</td><td>334-826</td></tr> </table>	Automann	TRK6004B/UB	Dayton	334-826										
Automann	TRK6004B/UB															
Dayton	334-826															
 <p style="text-align: center;">SB1004/SB1004U</p>	<p>Torque Arm Bushing</p> <p>Outside Diameter 1-15/16" Inside Diameter 7/8" Overall Length 3"</p> <p>SB1004U Is Polyurethane</p>	<table border="0"> <tr><td>Binkley</td><td>PP0054-02</td></tr> <tr><td>BWP</td><td>M-1449</td></tr> <tr><td>Dayton</td><td>321-153/U</td></tr> <tr><td>Euclid</td><td>E-1980/E-7520</td></tr> <tr><td>Flagg</td><td>R129/UB</td></tr> <tr><td>Meritor</td><td>R301980/R307520</td></tr> </table>	Binkley	PP0054-02	BWP	M-1449	Dayton	321-153/U	Euclid	E-1980/E-7520	Flagg	R129/UB	Meritor	R301980/R307520		
Binkley	PP0054-02															
BWP	M-1449															
Dayton	321-153/U															
Euclid	E-1980/E-7520															
Flagg	R129/UB															
Meritor	R301980/R307520															
 <p style="text-align: center;">SB1016</p>	<p>Torque Arm Bolt Assembly</p> <p>Includes: (1) SB1005 Bolt (1) SB1006 Nut</p>	<table border="0"> <tr><td>Automann</td><td>BKF780512</td></tr> <tr><td>Dayton</td><td>334-827</td></tr> <tr><td>Euclid</td><td>E-9308</td></tr> <tr><td>Flagg</td><td>BK2</td></tr> <tr><td>Meritor</td><td>R309308</td></tr> </table>	Automann	BKF780512	Dayton	334-827	Euclid	E-9308	Flagg	BK2	Meritor	R309308				
Automann	BKF780512															
Dayton	334-827															
Euclid	E-9308															
Flagg	BK2															
Meritor	R309308															
 <p style="text-align: center;">SB1005</p>	<p>Torque Arm Bolt</p> <p>Body Diameter 7/8" Thread 7/8" - 14 Length 4-3/4"</p>	<table border="0"> <tr><td>Automann</td><td>F780512 GR5</td></tr> <tr><td>Binkley</td><td>PP0050-75</td></tr> </table>	Automann	F780512 GR5	Binkley	PP0050-75										
Automann	F780512 GR5															
Binkley	PP0050-75															



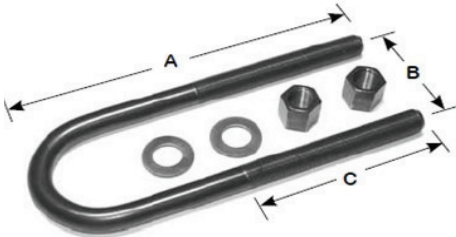

BINKLEY "DURALITE" PARTS

PART NO.	NOTES	REPLACES
 SB1006	<p>Torque Arm Nut</p> <p>Thread 7/8" - 14 Across Flats 1-5/16" Height 3/4"</p>	<p>Automann LN106 Binkley PP0012-36 Flagg FLN106</p>
 SB1009	<p>Front Hanger</p> <p>Straddle Mount</p>	<p>Automann M21072 Binkley SP0100 BWP M-4130 Dayton 338-1300 Euclid E-9302 Flagg BK6 Meritor R309302</p>
 SB1010	<p>Center Hanger</p> <p>Straddle Mount</p>	<p>Automann M21074 Binkley SP0110 BWP M-4131 Dayton 338-1302 Euclid E-9303 Flagg BK7 Meritor R309303</p>
 SB1011	<p>Rear Hanger</p> <p>Straddle Mount</p>	<p>Automann M21076 Binkley SP0120 BWP M-4132 Dayton 338-1304 Euclid E-9304 Flagg BK8 Meritor R309304</p>
 SH1057	<p>Spring Roller Assembly</p> <p>Includes: (1) SH1011 Nut (1) SH1045 Bolt (1) SH1046 Sleeve</p>	<p>Automann SRL01 BWP M-2973 Dayton 334-343 Euclid E-4835 Flagg H157 Meritor R304835</p>
 SH1030	<p>Top Plate</p> <p>Fabricated</p> <p>Width 3" Length 7-1/2"</p>	<p>Automann M852 Binkley SP0136 BWP M-2148 Dayton 338-1367 Euclid E-2907A Flagg E303 Meritor R302907A</p>







BINKLEY "DURALITE" PARTS

PART NO.	NOTES	REPLACES
 SH1032	Bottom Plate For 5" Round Axle	Automann M8286 Binkley SP0099 BWP M-2149 Dayton 338-415 Euclid E-2909 Flagg H115 Meritor R302909
 SH1023	Delrin Spring Liner Length 8" Width 2-7/8" Thickness .043"	Automann DL376 Binkley SP0049 BWP M-2872 Dayton GL-294 Euclid E-2842 Flagg DL294/DL295 Meritor R302842
 SH1063	U-Bolt Washer Heat Treated Outside Diameter 1-15/32" Inside Diameter 13/16" Thickness 1/8"	Automann MUBW174 Binkley PP0016-67 BWP M-2854 Dayton SUW-34 Euclid E-2545 Flagg UBW75 Meritor R302545
 SH1064	U-Bolt Hi-Nut Grade 8 Thread 3/4" - 16 Across Flats 1-1/16" Height 1"	Automann DN4 Binkley PP0011-44 BWP M-1193 Dayton DN-34 Flagg DN4 Meritor R303001
8R343123	Grade 8 U-Bolt Assembly Thread 3/4" - 16 A = 12" B = 3" C = 3"	Automann AUBK8151-12 Binkley SP0075-02/05 Dayton 361-469 Euclid E-UB8151-12 Flagg UBK104 Meritor R30U8151-12
 8R343186	Grade 8 U-Bolt Assembly Thread 3/4" - 16 A = 18" B = 3" C = 6"	Automann AUBK8151-185 Binkley SP0075-06/08 BWP M-1490 Dayton 361-262 Euclid E-UB8151-18 Flagg UBK114 Meritor R30U8151-18

FRUEHAUF F-2 PARTS

PART NO.	NOTES	REPLACES
 SF1000	Cast Equalizer Old Style F-2 And Current Style F-3 Suspensions Bushings Not Included Uses SF1002 Bushing Assembly	Automann EQ015 BWP M-2150 Dayton 338-715 Euclid E-2830 Flagg FR269/I Fruehauf UXA-000017 Meritor R302830
 SF1001	Cast Equalizer New Style F-2 Suspension Bushings Not Included Uses SF1002 Bushing Assembly	Automann EQ023 BWP M-2884 Dayton 338-1096 Euclid E-8931 Flagg FR260/I Fruehauf UCF-006963 Meritor R308931
 SF1002/SF1002U	"F" Series Bushing Assembly Includes: (1) SF1003 Bolt (2) SF1004 Bushing (1) SF1005 Washer (1) SF1006 Washer (1) SR1011 Nut SF1002U Contains SF1004U Bushing	Automann TRK5384/UB BWP M-1806 Dayton 334-452A Euclid E-1024/E-9361 Flagg FR264 Fruehauf UXA-0004-900 Meritor R301024/R309361
 SF1003	Equalizer Bolt (Solid) Body Diameter 2" Thread 1" - 14 Length 10-5/8"	Automann TRS4309HD BWP M-1807 Dayton 334-453A Euclid E-1019 Flagg FR267 Fruehauf UXA-00015-001 Meritor R301019
 SF1004/SF1004U	Equalizer Bushing SF1004U Is Polyurethane Outside Diameter 3-1/2" Inside Diameter 2" Overall Length 4-3/8"	Automann TRB5384/UB BWP M-1808 Dayton 321-190/U Euclid E-1020/E-7432 Flagg FR263/UB Fruehauf UXA-000004 Meritor R301020/R307432
 SR1011	Lock Nut Thread 1" - 14 Hex 1-7/16" Height 7/8"	Automann LN107 BWP M-2941 Dayton 334-153 Euclid E-1828 Flagg LN107 Fruehauf FSP-00602PK9 Meritor R30937







FRUEHAUF F-2 PARTS

PART NO.	NOTES	REPLACES
 SF1005	Compression Washer Outside Diameter 4" Inside Diameter 1-1/16" Thickness 1/4"	Automann WA03 BWP M-1809 Dayton 334-455 Euclid E-1021 Flagg FR262 Fruehauf UXA-000003 Meritor R301021
 SF1006	Outer Washer Outside Diameter 4" Inside Diameter 2" Thickness 1/16"	Automann WA04 BWP M-2869 Dayton 334-454 Euclid E-2832 Flagg FR293 Fruehauf UXA-000356-002 Meritor R302832
 SF1007	Adjustable Torque Arm 15-7/16" Center To Center Bushings Not Included Uses SF1009 Torque Arm Bushing Assembly	Automann TR006 BWP M-2151 Dayton 345-201 Euclid E-2515 Flagg FR254/I Fruehauf UCF-002640-001 Meritor R302515
 SF1008	Rigid Torque Arm 15-7/16" Center To Center Bushings Not Included Uses SF1009 Torque Arm Bushing Assembly	Automann TR021 BWP M-2152 Dayton 345-202 Euclid E-2514 Flagg FR271 Fruehauf UXA-000026-001 Meritor R302514
 SF1009/SF1009U	Torque Arm Bushing Assembly Includes: (1) SF1010 Bolt (2) SF1011 Bushing (1) SF1012 Washer (1) SF1013 Washer (1) SR1011 Nut	Automann TRK6300/UB BWP M-1803 Dayton 334-565 Euclid E-1023/E-9362 Flagg FR266 Fruehauf UXA-0011-900 Meritor R301023/R309362
 SF1010	Torque Arm Bolt (Solid) Body Diameter 1-1/4" Thread 1" - 14 Length 6"	Automann TRS3309 BWP M-1804 Dayton 334-566 Euclid E-1018 Flagg FR268 Fruehauf UXA-000016 Meritor R301018





FRUEHAUF F-2 PARTS

PART NO.	NOTES	REPLACES
	Torque Arm Bushing SF1011U Is Polyurethane Outside Diameter 2-3/16" Inside Diameter 1-1/4" Overall Length 2-3/8"	Automann TRB6300/UB BWP M-1818 Dayton 321-177/U Euclid E-927/E-7433 Flagg RBT200/UB Fruehauf UXA-000011 Meritor R30927/R307433
SF1011/SF1011U		
	Compression Washer Outside Diameter 2-1/2" Inside Diameter 1-1/16" Thickness 1/4"	Automann WA02 BWP M-1805 Dayton 334-568 Euclid E-1074 Flagg FR261 Fruehauf UXA-000002 Meritor R301074
SF1012		
	Outer Washer Outside Diameter 2-1/2" Inside Diameter 1-5/16" Thickness 1/16"	Automann WA01 BWP M-2870 Dayton SFW-125 Euclid E-2833 Flagg FR292 Fruehauf UXA-000356-001 Meritor R302833
SF1013		
	Lock Nut Thread 1" - 14 Hex 1-7/16" Height 7/8"	Automann LN107 BWP M-2941 Dayton 334-153 Euclid E-1828 Flagg LN107 Fruehauf FSP-00602PK9 Meritor R30937
SR1011		
	Spring Saddle For Multi-Leaf Springs Only	Automann M470 BWP M-4133 Dayton 338-1107 Euclid E-2840 Flagg E112 Fruehauf UCE-008801-001 Meritor R302840
SF1014		
	Spring Saddle For Single Leaf Springs Only	Automann M471 BWP M-4134 Dayton 338-1108 Euclid E-2839 Flagg FR209 Fruehauf UCC-005998-001 Meritor R302839
SF1015		

FRUEHAUF F-2 PARTS

PART NO.	NOTES	REPLACES
 SF1016	Spring Spacer Length 6-1/2" Width 3" Thickness 1-1/2"	Automann M8144 BWP M-4135 Dayton 338-1109 Euclid E-2838 Flagg FR276 Fruehauf UXA-000048 Meritor R302838
 SF1017	Spring Chair	Automann M8142 BWP M-4136 Dayton 338-1111 Euclid E-2837 Flagg FR204 Fruehauf AXA-000512-001 Meritor R302837
 SH1023	Delrin Spring Liner Length 8" Width 2-7/8" Thickness .043"	Automann DL376 BWP M-2872 Dayton GL-294 Euclid E-2842 Flagg DL294/DL295 Fruehauf UCD-006632-002 Meritor R302842
 SF1018	Axle Bracket	Automann M8140 BWP M-4137 Dayton 338-1113 Euclid E-2836 Flagg FR203/I Fruehauf UXA-000495-001 Meritor R302836
 SF1020	Front Standard Under Mount Hanger	Automann M6120 BWP M-4138 Dayton 338-1100 Euclid E-2826 Flagg FR246/I Fruehauf UCF-002467-001 Meritor R302826
 SF1021	Center Standard Under Mount Hanger	Automann M6122 BWP M-4139 Dayton 338-1101 Euclid E-2827 Flagg FR273/I Fruehauf UXA-000034 Meritor R302827

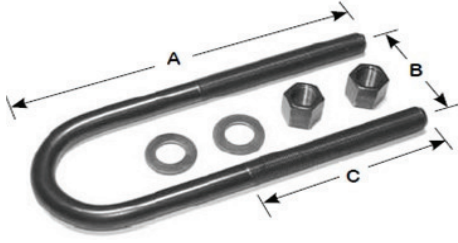
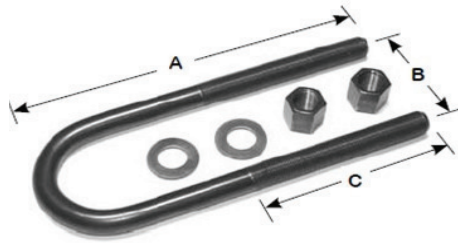





FRUEHAUF F-2 PARTS

PART NO.	NOTES	REPLACES
 SF1022	Rear Standard Under Mount Hanger	Automann M6124 BWP M-4140 Dayton 338-1102 Euclid E-2828 Flagg FR248 Fruehauf UCF-002470-001 Meritor R302828
 SF1019	Spacer Assembly For SF1022 Hanger Includes: (1) SH1011 Nut (1) SH1045 Bolt (1) SH1046 Sleeve	Automann SRL03 BWP M-4141 Dayton 334-672 Euclid E-2829 Flagg FR307 Meritor R302829
8R783123	Grade 8 U-Bolt Assembly Thread 7/8" - 14 A = 12" B = 3" C = 3"	Dayton 361-589 Euclid E-UB8161-12 Flagg UBK124 Meritor R30U8161-12
 8R783146	Grade 8 U-Bolt Assembly Thread 7/8" - 14 A = 14" B = 3" C = 6"	Dayton 361-374 Euclid E-UB8161-14 Flagg UBK122 Meritor R30U8161-14
8R783166	Grade 8 U-Bolt Assembly Thread 7/8" - 14 A = 16" B = 3" C = 6"	BWP M-4035 Dayton 361-168 Euclid E-UB8161-16 Flagg UBK126 Meritor R30U8161-16
 8R783186	Grade 8 U-Bolt Assembly Thread 7/8" - 14 A = 18" B = 3" C = 6"	BWP M-4037 Dayton 361-609 Euclid E-UB8161-18 Flagg UBK133 Meritor R30U8161-18
 SF693	Fruehauf Leaf Spring 3 Leaf 4-1/8" 10,000 lb. Capacity	Automann TRA693 Dayton TRA-693I Fruehauf UCD-000511-001 New Life UCD-0511-1-693







HUTCHENS REPLACEMENT PARTS

PART NO.	NOTES	REPLACES
 <p>SH1021/SH1021U</p>	<p>Fabricated Equalizer</p> <p>For H-7600/H-7700</p> <p>Includes SH1008 Bushing</p> <p>SH1021 Contains SH1008 Bushing SH1021U Contains SH1008U Bushing</p>	<p>Atro EQ53-35250 *</p> <p>Automann EQ013/UB</p> <p>BWP M-2146</p> <p>Dayton 338-419/I</p> <p>Euclid E-2781A/E-9570 E-7918</p> <p>Flagg H100/I</p> <p>Hutchens 750-03</p> <p>Meritor R302781A/R307918</p> <p>* Includes Bolt Kit</p>
 <p>SH1025</p>	<p>Cast Equalizer</p> <p>For H-7600/H-7700</p> <p>Includes SH1008 Bushing</p>	<p>Automann EQ014</p> <p>BWP M-2147</p> <p>Dayton 338-408</p> <p>Euclid E-2889</p> <p>Flagg H101/I</p> <p>Hutchens 704-01</p> <p>Meritor R302889</p>
 <p>SH1012/SH1012U</p>	<p>Equalizer Bushing Assembly</p> <p>For H-7600/H-7700/CH-7700/CH-7800</p> <p>Includes: (1) SH1008 Bushing (2) SH1009 Step Bolt (1) SH1010 Tab Lock (2) SH1011 Nut</p> <p>SH1012U Contains SH1008U Bushing</p>	<p>Automann TRK5541/UB</p> <p>BWP M-1451</p> <p>Dayton 334-341</p> <p>Euclid E-2003/E-9474</p> <p>Flagg H111</p> <p>Meritor R302003/R309474</p>
 <p>SH1044</p>	<p>Equalizer Bolt Kit</p> <p>For H-7600/H-7700/H-2200</p> <p>Includes: (2) SH1009 Step Bolt (1) SH1010 Tab Lock (4) SH1011 Nut (2) SH1045 Bolt (2) SH1046 Sleeve</p>	<p>Automann MH680</p> <p>BWP M-2975</p> <p>Dayton 334-639</p> <p>Euclid E-3414</p> <p>Flagg H217</p> <p>Hutchens 10287-01</p> <p>Meritor R303414</p>
 <p>SH1057</p>	<p>Spring Roller Assembly</p> <p>For H-7600/H-7700/CH-7600/CH-7700 And H-2200</p> <p>Includes: (1) SH1011 Nut (1) SH1045 Bolt (1) SH1046 Sleeve</p>	<p>Automann SRL01</p> <p>BWP M-2973</p> <p>Dayton 334-343</p> <p>Euclid E-4835</p> <p>Flagg H157</p> <p>Meritor R304835</p>
 <p>SH1008/SH1008U</p>	<p>Equalizer Bushing</p> <p>For H-7600/H-7700/CH-7700/CH-7800 And CH-7600</p> <p>SH1008U Is Polyurethane</p> <p>Outside Diameter 3-1/4" Length 3-7/8"</p>	<p>Automann TRB5541/UB</p> <p>BWP M-1452</p> <p>Dayton 321-176/U</p> <p>Euclid E-1999A/E-7452</p> <p>Flagg H102//UB</p> <p>Hutchens 7010-00</p> <p>Meritor R301999A/R307452</p>

HUTCHENS REPLACEMENT PARTS

PART NO.	NOTES	REPLACES
 <p style="text-align: center;">SH1009</p>	<p>Equalizer Step Bolt</p> <p>For H-2200/H-7600/H-7700/CH-7600 And CH-7700</p> <p>Diameter 3/4" Length 6" Thread 5/8" - 18</p>	<p>Automann TRS4413 BWP M-1453 Dayton 334-366 Euclid E-2000 Flagg H110 Hutchens 7016-01 Meritor R302000</p>
 <p style="text-align: center;">SH1010</p>	<p>Tab Lock</p>	<p>Automann MH456 BWP M-1454 Dayton 334-360 Euclid E-2001 Flagg H105 Hutchens 729-00 Meritor R302001</p>
 <p style="text-align: center;">SH1011</p>	<p>Nut</p> <p>Thread 5/8" - 18 Hex 15/16" Height 17/32"</p>	<p>Automann PNF106 BWP M-1455 Dayton SLN-104 Euclid E-2002 Flagg LN104 Hutchens 37-03 Meritor R302002</p>
 <p style="text-align: center;">SH1045</p>	<p>Rebound Bolt</p> <p>Thread 5/8" - 18 Length 4-1/2"</p>	<p>Automann F580412 GR5 Dayton 334-362 Euclid E-3415 Flagg B1324-43* Hutchens 759-00 Meritor R303415</p> <p>* Coarse Thread</p>
 <p style="text-align: center;">SH1046</p>	<p>Spacer Sleeve</p> <p>Outside Diameter 7/8" Inside Diameter 21/32" Length 3-7/32"</p>	<p>Automann MH558 Dayton 334-361 Euclid E-3416 Flagg H156 Hutchens 756-00 Meritor R303416</p>
 <p style="text-align: center;">SH1048/SH1048U</p>	<p>Fabricated Equalizer</p> <p>For H-9700</p> <p>SH1048 Contains SH1049 Bushing SH1048U Contains SH1049U Bushing</p>	<p>Atro EQ53-35158 * Automann EQ019/UB BWP M-3482 Dayton 338-886 Euclid E-7532/E-9567 Flagg H220/I Hutchens 16158-01 Meritor R307532/R309567</p> <p>* Includes Bolt Kit</p>

HUTCHENS REPLACEMENT PARTS

PART NO.	NOTES	REPLACES														
	<p>Cast Equalizer</p> <p>For CH-9600/CH-9700</p> <p>Includes SH1049 Bushing</p>	<table border="0"> <tr><td>Automann</td><td>EQ028</td></tr> <tr><td>BWP</td><td>M-3482C</td></tr> <tr><td>Dayton</td><td>338-887</td></tr> <tr><td>Euclid</td><td>E-9471</td></tr> <tr><td>Flagg</td><td>H225/I</td></tr> <tr><td>Hutchens</td><td>16290-01/17784-01</td></tr> <tr><td>Meritor</td><td>R309471</td></tr> </table>	Automann	EQ028	BWP	M-3482C	Dayton	338-887	Euclid	E-9471	Flagg	H225/I	Hutchens	16290-01/17784-01	Meritor	R309471
Automann	EQ028															
BWP	M-3482C															
Dayton	338-887															
Euclid	E-9471															
Flagg	H225/I															
Hutchens	16290-01/17784-01															
Meritor	R309471															
<p>SH1050</p>																
	<p>Equalizer Bolt Kit</p> <p>For H-9600/H-9700/CH-9600/CH-9700</p> <p>Includes: (2) SH1011 Nut (2) SH1045 Bolt (2) SH1046 Sleeve (1) SH1054 Bolt (1) SH1055 Nut (2) SH1062 Washer</p>	<table border="0"> <tr><td>Automann</td><td>TRK5544A</td></tr> <tr><td>Dayton</td><td>334-937</td></tr> <tr><td>Euclid</td><td>E-9475</td></tr> <tr><td>Flagg</td><td>H226</td></tr> <tr><td>Hutchens</td><td>16353-01</td></tr> <tr><td>Meritor</td><td>R309475</td></tr> </table>	Automann	TRK5544A	Dayton	334-937	Euclid	E-9475	Flagg	H226	Hutchens	16353-01	Meritor	R309475		
Automann	TRK5544A															
Dayton	334-937															
Euclid	E-9475															
Flagg	H226															
Hutchens	16353-01															
Meritor	R309475															
<p>SH1061</p>																
	<p>Equalizer Bushing Assembly</p> <p>For H-9600/H-9700/CH-9600/CH-9700</p> <p>Includes: (1) SH1049 Bushing (1) SH1054 Bolt (1) SH1055 Nut</p>	<table border="0"> <tr><td>Automann</td><td>TRK5542B</td></tr> <tr><td>Dayton</td><td>334-1272</td></tr> <tr><td>Euclid</td><td>E-9472/E-9473</td></tr> <tr><td>Flagg</td><td>H263</td></tr> <tr><td>Meritor</td><td>R309472/R309473</td></tr> </table>	Automann	TRK5542B	Dayton	334-1272	Euclid	E-9472/E-9473	Flagg	H263	Meritor	R309472/R309473				
Automann	TRK5542B															
Dayton	334-1272															
Euclid	E-9472/E-9473															
Flagg	H263															
Meritor	R309472/R309473															
<p>SH1053/SH1053U</p>	<p>SH1053U Contains SH1049U Bushing</p>															
	<p>Equalizer Bushing</p> <p>For H-9600/H-9700/CH-9600/CH-9700</p> <p>SH1049U Is Polyurethane</p> <p>Outside Diameter 3-1/2" Inside Diameter 1-1/8" Length 3-7/8"</p>	<table border="0"> <tr><td>Automann</td><td>TRB5542/UB</td></tr> <tr><td>BWP</td><td>M-3483</td></tr> <tr><td>Dayton</td><td>321-221/U</td></tr> <tr><td>Euclid</td><td>E-7621/E-8666</td></tr> <tr><td>Flagg</td><td>H227/II/UB</td></tr> <tr><td>Hutchens</td><td>16146-01</td></tr> <tr><td>Meritor</td><td>R307621/R308666</td></tr> </table>	Automann	TRB5542/UB	BWP	M-3483	Dayton	321-221/U	Euclid	E-7621/E-8666	Flagg	H227/II/UB	Hutchens	16146-01	Meritor	R307621/R308666
Automann	TRB5542/UB															
BWP	M-3483															
Dayton	321-221/U															
Euclid	E-7621/E-8666															
Flagg	H227/II/UB															
Hutchens	16146-01															
Meritor	R307621/R308666															
<p>SH1049/SH1049U</p>																
	<p>Equalizer Bolt</p> <p>For H-9600/H-9700/CH-9600/CH-9700</p> <p>Thread Length 1-1/8" - 7 6-7/8"</p>	<table border="0"> <tr><td>Automann</td><td>C118700 GR8</td></tr> <tr><td>BWP</td><td>M-3484</td></tr> <tr><td>Dayton</td><td>334-739</td></tr> <tr><td>Euclid</td><td>E-7533</td></tr> <tr><td>Flagg</td><td>H221</td></tr> <tr><td>Hutchens</td><td>16150-01</td></tr> <tr><td>Meritor</td><td>R307533</td></tr> </table>	Automann	C118700 GR8	BWP	M-3484	Dayton	334-739	Euclid	E-7533	Flagg	H221	Hutchens	16150-01	Meritor	R307533
Automann	C118700 GR8															
BWP	M-3484															
Dayton	334-739															
Euclid	E-7533															
Flagg	H221															
Hutchens	16150-01															
Meritor	R307533															
<p>SH1054</p>																
	<p>Nut</p> <p>Thread Hex Height 1-1/8" - 7 1-11/16" 15/16"</p>	<table border="0"> <tr><td>Automann</td><td>LNC107A</td></tr> <tr><td>BWP</td><td>M-2126</td></tr> <tr><td>Dayton</td><td>334-375</td></tr> <tr><td>Euclid</td><td>E-4358</td></tr> <tr><td>Flagg</td><td>LNC107A</td></tr> <tr><td>Hutchens</td><td>11154-00</td></tr> <tr><td>Meritor</td><td>R304358</td></tr> </table>	Automann	LNC107A	BWP	M-2126	Dayton	334-375	Euclid	E-4358	Flagg	LNC107A	Hutchens	11154-00	Meritor	R304358
Automann	LNC107A															
BWP	M-2126															
Dayton	334-375															
Euclid	E-4358															
Flagg	LNC107A															
Hutchens	11154-00															
Meritor	R304358															
<p>SH1055</p>																

HUTCHENS REPLACEMENT PARTS







TYPE 1









TYPE 2

PART NO.	NOTES	REPLACES
TYPE 1 SH1041	Adjustable Torque Arm For H-7700/H-9700/CH-7700/CH-9700 Length 16" Bushing Number SH1001/SH1001U Bushing Assembly SH1040/SH1040U	Automann TR019 BWP M-2141 Dayton 345-238 Euclid E-3276 Flagg H106/I Hutchens 16398-02/713-02 Meritor R303276
TYPE 1 SH1043	Adjustable Torque Arm For H-7700/H-9700/CH-7700/CH-9700 Length 17-1/4" Bushing Number SH1001/SH1001U Bushing Assembly SH1040/SH1040U	Automann TR007 BWP M-2142 Dayton 345-191 Euclid E-3390 Flagg H107 Hutchens 16398-17 Meritor R303390
TYPE 1 SH1042	Adjustable Torque Arm For H-7700/H-9700/CH-7700/CH-9700 Length 19-1/4" Bushing Number SH1001/SH1001U Bushing Assembly SH1040/SH1040U	Automann TR004 BWP M-2143 Dayton 345-164/I Euclid E-3277 Flagg H108/I Hutchens 16398-04/713-05 Meritor R303277
TYPE 2 SH1029	Rigid Torque Arm For H-7700/H-9700/CH-7700/CH-9700 Length 19-1/4" Bushing Number SH1001/SH1001U Bushing Assembly SH1040/SH1040U	Automann TR005 BWP M-2144 Dayton 345-167/I Euclid E-2899 Flagg H167 Hutchens 715-00 Meritor R302899
 SH1040/SH1040U	Torque Arm Bushing Assembly For H-7700/CH-7700 Includes: (1) SH1001 Bushing (1) SH1026 Bolt (1) SH1027 Nut SH1040U Contains SH1001U Bushing	Automann TRK6326/UB BWP M-2159 Dayton 334-344 Euclid E-3079 Flagg H112 Meritor R303079/R309486





HUTCHENS REPLACEMENT PARTS

PART NO.	NOTES	REPLACES
 <p>SH1001/SH1001U</p>	<p>Torque Arm Bushing</p> <p>For H-7700/CH-7700</p> <p>SH1001U Is Polyurethane</p> <p>Outside Diameter 1-29/32" Inside Diameter 1" Length 3"</p>	<p>Automann TRB6326/UB BWP M-1888 Dayton 321-175/U Euclid E-934/E-7453 Flagg RBT201/UB Hutchens 722-00 Meritor R30934/R307453</p>
 <p>SH1026</p>	<p>Torque Arm Bolt</p> <p>For H-7700/H-9700/CH-7700/CH-9700</p> <p>Thread 1" - 14 Length 5"</p>	<p>Automann F100500 GR5 BWP M-2160 Dayton 334-359 Euclid E-2891 Flagg H103 Hutchens 719-02 Meritor R302891</p>
 <p>SH1027</p>	<p>Flanged Nut</p> <p>For H-7700/H-9700/CH-7700/CH-9700</p> <p>Thread 1" - 14 Hex 1-7/16" Height 7/8"</p>	<p>Automann FLN107 BWP M-2161 Dayton 334-319 Euclid E-2892 Flagg H104 Hutchens 10562-00 Meritor R302892</p>
 <p>SH1030</p>	<p>Top Plate</p> <p>Fabricated</p> <p>Width 3" Length 7-1/2"</p>	<p>Automann M852 BWP M-2148 Dayton 338-1367 Euclid E-2907A Flagg E303 Hutchens 7029-00/16868-01 Meritor R302907A</p>
 <p>SH1032</p>	<p>Bottom Plate</p> <p>For 5" Round Axle</p>	<p>Automann M8286 BWP M-2149 Dayton 338-415 Euclid E-2909 Flagg H115 Hutchens 710-00 Meritor R302909</p>
 <p>SH1031</p>	<p>Spring Seat</p> <p>For 5" Round Axle</p> <p>For H-7700/H-9700/CH-7700/CH-9700</p> <p>Seat Height 3/4"</p>	<p>Automann M8284 BWP M-2868 Dayton 338-409 Euclid E-2908 Flagg H169/I Hutchens 705-01/19360-01 Meritor R302908</p>

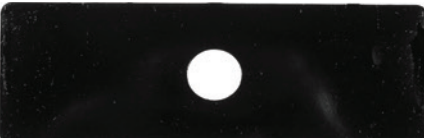

HUTCHENS REPLACEMENT PARTS

PART NO.	NOTES	REPLACES
	<p>Front Hanger Straddle Mount</p> <p>For H-7700/H-9700</p>	<p>Automann M8288 BWP M-4142 Dayton 338-451 Euclid E-2910A Flagg H161 Hutchens 7701-01 Meritor R302910A</p>
<p>SH1033</p>		
	<p>Center Hanger Straddle Mount</p> <p>For H-7700</p>	<p>Automann M8290 BWP M-4143 Dayton 338-453 Euclid E-2911 Flagg H163/I Hutchens 7702-01 Meritor R302911</p>
<p>SH1034</p>		
	<p>Center Hanger Straddle Mount</p> <p>For H-9700</p>	<p>Automann M8095 BWP M-4144 Dayton 338-884 Euclid E-7534 Flagg H222/I Hutchens 16169-01 Meritor R307534</p>
<p>SH1059</p>		
	<p>Rear Hanger Straddle Mount</p> <p>For H-7700/H-9700</p>	<p>Automann M8292 BWP M-4145 Dayton 338-455 Euclid E-2912A Flagg H165 Hutchens 7703-01 Meritor R302912A</p>
<p>SH1035</p>		
	<p>Front Hanger Under Mount</p> <p>For H-7700/CH-9700</p>	<p>Automann M8294 BWP M-3487 Dayton 338-452 Euclid E-2913A Flagg H162/I Hutchens 7701-02 Meritor R302913A</p>
<p>SH1036</p>		
	<p>Center Hanger Under Mount</p> <p>For H-7700</p>	<p>Automann M8296 BWP M-3488 Dayton 338-454 Euclid E-2914 Flagg H164/I Hutchens 7702-02 Meritor R302914</p>
<p>SH1037</p>		

HUTCHENS REPLACEMENT PARTS

PART NO.	NOTES	REPLACES
	<p>Center Hanger Under Mount</p> <p>For H-9700</p>	<p>Automann M8097 BWP M-4146 Dayton 338-885 Euclid E-9582 Hutchens 16171-01 Meritor R309582</p>
<p>SH1060</p>		
	<p>Rear Hanger Under Mount</p> <p>For H-7700/H-9700</p>	<p>Automann M8298 BWP M-3489 Dayton 338-456 Euclid E-2915A Flagg H166/I Hutchens 7703-02 Meritor R302915A</p>
<p>SH1038</p>		
	<p>Equalizer Bolt Washer</p> <p>Used In SH1061 Kit</p> <p>Outside Diameter 2" Inside Diameter 1-1/4" Thickness 1/8"</p>	<p>Automann MUBW200 Dayton 334-447 Euclid E-2548 Flagg H256 Hutchens 837-00 Meritor R302548</p>
<p>SH1062</p>		
	<p>Delrin Spring Liner</p> <p>Thickness .043" Width 2-7/8" Length 8"</p>	<p>Automann DL376 BWP M-2872 Dayton GL-294 Euclid E-2842 Flagg DL294/DL295 Hutchens 7052-02 Meritor R302842 Reyco T-5166</p>
<p>SH1023</p>		
	<p>U-Bolt Washer Heat Treated</p> <p>Outside Diameter 1-3/4" Inside Diameter 15/16" Thickness 1/8"</p>	<p>Automann MUBW184 BWP M-2136 Dayton 334-150 Euclid E-2546 Flagg UBW80 Hutchens 35-00 Meritor R302546 Reyco T-7292</p>
<p>SH1016</p>		
	<p>U-Bolt Hi-Nut Grade 8</p> <p>Thread 7/8" - 14 Across Flats 1-1/4" Height 1-5/32"</p>	<p>Automann DN5 BWP M-1194 Dayton DN-78 Euclid E-3002A Flagg DN5 Hutchens 34-00 Meritor R303002A Reyco 09352-01</p>
<p>SH1039</p>		

HUTCHENS REPLACEMENT PARTS

PART NO.	NOTES	REPLACES										
 <p data-bbox="300 451 414 483">SH2726</p>	<p data-bbox="609 220 812 252">Hutch Leaf Spring</p> <p data-bbox="609 304 755 367">3 Leaf High 6" Arch</p> <p data-bbox="609 420 812 451">22,400 lbs. GAWR</p>	<table data-bbox="1063 252 1372 399"> <tr> <td>Automann</td> <td>TRA2726</td> </tr> <tr> <td>Dayton</td> <td>TRA-2726E</td> </tr> <tr> <td>Flagg</td> <td>TRA2726</td> </tr> <tr> <td>Hutchens</td> <td>354-00</td> </tr> <tr> <td>New Life</td> <td>TRA-2726-SP</td> </tr> </table>	Automann	TRA2726	Dayton	TRA-2726E	Flagg	TRA2726	Hutchens	354-00	New Life	TRA-2726-SP
Automann	TRA2726											
Dayton	TRA-2726E											
Flagg	TRA2726											
Hutchens	354-00											
New Life	TRA-2726-SP											
 <p data-bbox="300 745 414 777">SH2727</p>	<p data-bbox="609 514 812 546">Hutch Leaf Spring</p> <p data-bbox="609 598 828 661">3 Leaf Medium 4-1/2" Arch</p> <p data-bbox="609 714 812 745">22,400 lbs. GAWR</p>	<table data-bbox="1063 546 1372 693"> <tr> <td>Automann</td> <td>TRA2727</td> </tr> <tr> <td>Dayton</td> <td>TRA-2727I</td> </tr> <tr> <td>Flagg</td> <td>TRA2727</td> </tr> <tr> <td>Hutchens</td> <td>355-00</td> </tr> <tr> <td>New Life</td> <td>TRA-2727-SP</td> </tr> </table>	Automann	TRA2727	Dayton	TRA-2727I	Flagg	TRA2727	Hutchens	355-00	New Life	TRA-2727-SP
Automann	TRA2727											
Dayton	TRA-2727I											
Flagg	TRA2727											
Hutchens	355-00											
New Life	TRA-2727-SP											
 <p data-bbox="300 1039 414 1071">SH2728</p>	<p data-bbox="609 808 812 840">Hutch Leaf Spring</p> <p data-bbox="609 892 787 955">3 Leaf Low 3-5/8" Arch</p> <p data-bbox="609 1008 812 1039">22,400 lbs. GAWR</p>	<table data-bbox="1063 840 1372 987"> <tr> <td>Automann</td> <td>TRA2728</td> </tr> <tr> <td>Dayton</td> <td>TRA-2728I</td> </tr> <tr> <td>Flagg</td> <td>TRA2728</td> </tr> <tr> <td>Hutchens</td> <td>356-00</td> </tr> <tr> <td>New Life</td> <td>TRA-2728-SP</td> </tr> </table>	Automann	TRA2728	Dayton	TRA-2728I	Flagg	TRA2728	Hutchens	356-00	New Life	TRA-2728-SP
Automann	TRA2728											
Dayton	TRA-2728I											
Flagg	TRA2728											
Hutchens	356-00											
New Life	TRA-2728-SP											



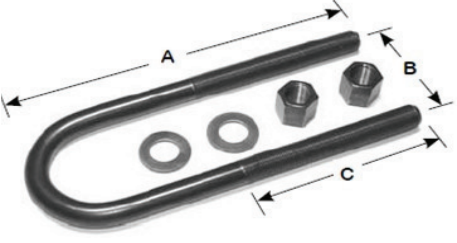
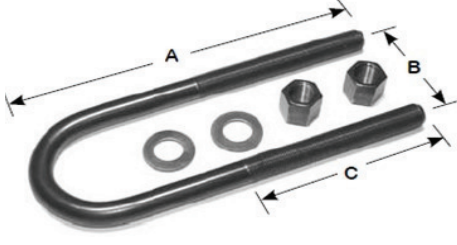
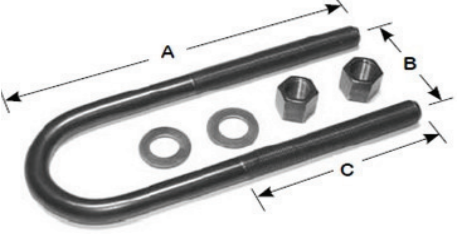

HUTCHENS REPLACEMENT PARTS

PART NO.	NOTES	REPLACES
<p>5R783123</p>	<p>Grade 5 U-Bolt Assembly</p> <p>Thread 7/8" - 14</p> <p>A = 12" B = 3" C = 3"</p>	<p>Automann AUBK5161-12 BWP M-1499 Dayton 361-248 Euclid E-UB5161-12 Flagg UBK1245 Hutchens 7040-06/10 Meritor R30U5161-12</p>
 <p>5R783136</p>	<p>Grade 5 U-Bolt Assembly</p> <p>Thread 7/8" - 14</p> <p>A = 13" B = 3" C = 6"</p>	<p>Automann AUBK5161-134 Dayton 361-577 Euclid E-UB5161-13 Hutchens 7040-11/12 Meritor R30U5161-13</p>
<p>5R783146</p>	<p>Grade 5 U-Bolt Assembly</p> <p>Thread 7/8" - 14</p> <p>A = 14" B = 3" C = 6"</p>	<p>Automann AUBK5161-144 BWP M-1492 Dayton 361-218 Euclid E-UB5161-14 Flagg UBK1225 Hutchens 7040-13/14 Meritor R30U5161-14</p>
 <p>5R783186</p>	<p>Grade 5 U-Bolt Assembly</p> <p>Thread 7/8" - 14</p> <p>A = 18" B = 3" C = 6"</p>	<p>Automann AUBK5161-18 BWP M-1493 Dayton 361-250 Euclid E-UB5161-18 Flagg UBK1335 Hutchens 7040-15/21 Meritor R30U5161-18</p>
<p>5R785146</p>	<p>Grade 5 U-Bolt Assembly</p> <p>Thread 7/8" - 14</p> <p>A = 14" B = 5" C = 6"</p>	<p>Automann AUBK5165-14 BWP M-1494 Dayton 361-252 Euclid E-UB5165-14 Flagg UBK1295 Hutchens 7816-05/14 Meritor R30U5165-14</p>
 <p>5R785186</p>	<p>Grade 5 U-Bolt Assembly</p> <p>Thread 7/8" - 14</p> <p>A = 18" B = 5" C = 6"</p>	<p>Automann AUBK5165-18 BWP M-2798 Dayton 361-587 Euclid E-UB5165-18 Flagg UBK2695 Hutchens 7816-13/18 Meritor R30U5165-18</p>

REYCO 21B PARTS

PART NO.	NOTES	REPLACES
	<p>Equalizer - Trailer</p> <p>Model 21B</p> <p>Bushings Not Included</p> <p>Uses SR1001 Bushing Assembly</p>	<p>Automann EQ001</p> <p>BWP M-1670</p> <p>Dayton 338-199</p> <p>Euclid E-2846A</p> <p>Flagg R103</p> <p>Meritor R302846A</p> <p>Reyco T-5427</p>
SR1000		
	<p>Equalizer Bushing Assembly</p> <p>Model 21B</p> <p>Includes: (2) SR1002 Bushing (1) SR1003 Shaft (2) SR1004 Washer (2) SR1005 Washer (2) SR1006 Bolt</p>	<p>Automann TRK5066</p> <p>BWP M-2936</p> <p>Dayton 334-211</p> <p>Euclid E-3976/E-9555</p> <p>Flagg R233</p> <p>Meritor R303976/R309555</p> <p>Reyco TK-12506 TK-18998</p>
SR1001/SR1001U	SR1001U Contains SR1002U Bushing	
	<p>Equalizer Bushing</p> <p>Model 21B</p> <p>SR1002U Is Polyurethane</p> <p>Outside Diameter 3-3/8" Inside Diameter 1-5/8" Length 4-13/32"</p>	<p>Automann TRB5066/UB</p> <p>BWP M-1719</p> <p>Dayton 321-146/U</p> <p>Euclid E-1159/E-8653</p> <p>Flagg R110/UB</p> <p>Meritor R301159/R308653</p> <p>Reyco T-5524</p>
SR1002/SR1002U		
	<p>Equalizer Shaft</p> <p>Model 21B</p> <p>Outside Diameter 1-5/8" Length 8-11/16" Bolt Holes 1" - 8</p>	<p>Automann TRS4003</p> <p>BWP M-3432</p> <p>Dayton 334-207</p> <p>Euclid E-3972</p> <p>Flagg R104</p> <p>Meritor R303972</p> <p>Reyco 14247-01</p>
SR1003		
	<p>Equalizer Washer</p> <p>Model 21B</p> <p>Outside Diameter 3-3/4" Inside Diameter 1-1/16" Thickness 1/2"</p>	<p>Automann WA06</p> <p>BWP M-2811</p> <p>Dayton 334-208</p> <p>Euclid E-1986A</p> <p>Flagg R109</p> <p>Meritor R301986A</p> <p>Reyco 14249-01</p>
SR1004		
	<p>Equalizer Shaft Lock Washer</p> <p>Model 21B</p> <p>Inside Diameter 1" Thickness 3/8"</p>	<p>Automann LW109</p> <p>BWP M-3434</p> <p>Dayton SLW-34</p> <p>Euclid E-3975</p> <p>Flagg HLW107</p> <p>Meritor R303975</p> <p>Reyco 14250-01</p>
SR1005		

REYCO 21B PARTS

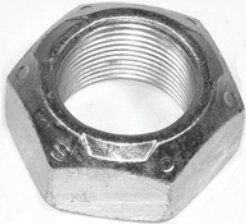
PART NO.	NOTES	REPLACES
 SR1006	Equalizer Shaft Lock Bolt Model 21B Thread 1" - 8 Length 2-1/2"	Automann C100212 GR5 BWP M-2808 Dayton 334-209 Euclid E-1987 Flagg R111 Meritor R301987 Reyco 14248-01
 SR1007/SR1007U	Torque Arm Bushing Assembly Model 21B Includes: (2) SR1008 Bushing (1) SR1009 Bolt (2) SR1010 Washer (1) SR1011 Nut SR1007U Contains SR1008U Bushing	Automann TRK6008/UB BWP M-1765 Dayton 334-252 Euclid E-1312A/E-9545 Flagg R003 Meritor R301312A/R309545 Reyco TK-18997
 SR1008/SR1008U	Torque Arm Bushing Model 21B SR1008U Is Polyurethane Small Outside Dia. 1-13/16" Large Outside Dia. 2-3/8" Inside Diameter 1" Length 3"	Automann TRB6008/UB BWP M-1718 Dayton 321-145/U Euclid E-1160/E-7523 Flagg R130/UB Meritor R301160/R307523 Reyco T-5493
 SR1009	Torque Arm Bolt Model 21B Thread 1" - 14 Length 7"	Automann M5288 BWP M-1766 Dayton 334-203 Euclid E-1166 Flagg R160 Meritor R301166 Reyco T-5492
 SR1010	Torque Arm Washer Model 21B Outside Diameter 2-3/4" Inside Diameter 1-1/16" Thickness 3/16"	Automann WA05 BWP M-1764 Dayton 334-205 Euclid E-907 Flagg R159 Meritor R30907 Reyco T-2224
 SR1011	Torque Arm Nut Model 21B Thread 1" - 14 Hex 1-7/16" Height 7/8"	Automann LN107 BWP M-2941 Dayton SLN-107 Euclid E-1828 Flagg LN107 Meritor R30937 Reyco T-5495

REYCO 21B PARTS



TYPE 1







TYPE 2



BUSHINGS NOT INCLUDED

PART NO.	NOTES	REPLACES
TYPE 1	Adjustable Torque Arm Model 21B Standard Front Length 15-1/2" - 17-1/2" Bushing Number SR1008 Bushing Assembly SR1007/SR1007U	Automann TR001 BWP M-3403 Dayton 345-199 Euclid E-3283A Flagg R101 Meritor R303283A Reyco 15172-01
SR1012		
TYPE 1	Adjustable Torque Arm Model 21B Standard Rear Length 17-1/2" - 19-1/2" Bushing Number SR1008 Bushing Assembly SR1007/SR1007U	Automann TR002 BWP M-3404 Dayton 345-105 Euclid E-3284A Flagg R102 Meritor R303284A Reyco 15173-01
SR1013		
TYPE 2	Rigid Torque Arm Model 21B Standard Front Length 16-1/4" Bushing Number SR1008 Bushing Assembly SR1007/SR1007U	Automann TR031 BWP M-3405 Dayton 345-110 Euclid E-2855 Flagg R276 Meritor R302855 Reyco 15178-01/T-7635
SR1014		
TYPE 2	Rigid Torque Arm Model 21B Standard Rear Length 18-7/8" Bushing Number SR1008 Bushing Assembly SR1007/SR1007U	Automann TR032 BWP M-3406 Dayton 345-112 Euclid E-2856 Flagg R277 Meritor R302856 Reyco 15179-01
SR1015		





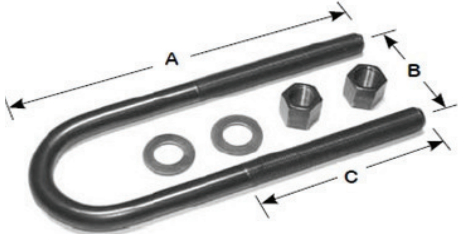

REYCO 21B PARTS

PART NO.	NOTES	REPLACES
	<p>Spring Roller Assembly</p> <p>Model 21B</p> <p>Includes: (1) SR1017 Bolt (1) SR1018 Roller (1) SR1019 Washer (1) SR1020 Nut</p>	<p>Automann SRL109 BWP M-2819 Dayton 334-201 Euclid E-1975 Flagg R231 Meritor R301975 Reyco TK-19011</p>
SR1016		
	<p>Spring Roller Bolt</p> <p>Model 21B</p> <p>Thread 1/2" - 20 Length 4-3/4"</p>	<p>Automann F120500 GR5 Euclid E-1972 Flagg R202 Meritor R301972 Reyco T-5544</p>
SR1017		
	<p>Spring Roller</p> <p>Model 21B</p> <p>Outside Diameter 27/32" Inside Diameter 5/8" Length 3-5/16"</p>	<p>Automann ST2106 Euclid E-1971 Flagg R139 Meritor R301971 Reyco T-2106</p>
SR1018		
	<p>Lock Washer</p> <p>Model 21B</p> <p>Outside Diameter 29/32" Inside Diameter 17/32" Thickness .061"</p>	<p>Dayton SLW-12 Euclid E-1974 Meritor R301974</p>
SR1019		
	<p>Nut</p> <p>Model 21B</p> <p>Thread 1/2" - 20</p>	<p>BWP M-215 Dayton CBN-385 Euclid E-5032 Flagg PNF104 Meritor R005032 Reyco T-1704</p>
SR1020		

REYCO 21B PARTS

PART NO.	NOTES	REPLACES
 SH1023	Delrin Spring Liner Length 8" Width 2-7/8" Thickness .043"	Automann DL376 BWP M-2872 Dayton GL-294 Euclid E-2842 Flagg DL294/DL295 Meritor R302842 Reyco T-5166
 SH1016	U-Bolt Washer Heat Treated Outside Diameter 1-3/4" Inside Diameter 15/16" Thickness 1/8"	Automann MUBW184 BWP M-2136 Dayton 334-150 Euclid E-2546 Flagg UBW80 Meritor R302546 Reyco T-7292
 SH1039	U-Bolt Hi-Nut Grade 8 Thread 7/8" - 14 Across Flats 1-1/4" Height 1-5/32"	Automann DN5 BWP M-1194 Dayton DN-78 Euclid E-3002A Flagg DN5 Meritor R303002A Reyco 09352-01
5R783146	Grade 5 U-Bolt Assembly Thread 7/8" - 14 A = 14" B = 3" C = 6"	Automann AUBK5161-144 BWP M-1492 Dayton 361-218 Euclid E-UB5161-14 Flagg UBK1225 Meritor R30U5161-14 Reyco 08490/08495-01
 5R783186	Grade 5 U-Bolt Assembly Thread 7/8" - 14 A = 18" B = 3" C = 6"	Automann AUBK5161-18 BWP M-1493 Dayton 361-250 Euclid E-UB5161-18 Flagg UBK1335 Meritor R30U5161-18 Reyco 08495/08504-01







TRANSPRO PARTS

PART NO.	NOTES	REPLACES
 ST1000	Fabricated Equalizer Includes ST1003 Bushing Super Heavy Duty Model 88	Automann EQ022 BWP M-1690 Dayton 338-378 Euclid E-4813 Flagg TP100 Meritor R304813 Transpro 0650-00
 ST1001	Cast Equalizer Includes ST1003 Bushing Super Heavy Duty Model 88	Automann EQ041 BWP M-3707 Dayton 338-871 Euclid E-10250 Flagg TP107 Meritor R3010250 Transpro 0850-00
 ST1002	Equalizer Bushing Assembly Transpro 86 And 88 Includes: (1) SH1027 Nut (1) ST1003 Bushing (1) ST1004 Bolt	Automann TRK5544 BWP M-1693 Dayton 334-628 Euclid E-4832 Flagg TP108 Meritor R304832 Transpro 0649-04K
 ST1003	Equalizer Bushing Super Heavy Duty Model 86 And 88 Outside Diameter 3-5/16" Inside Diameter 1-1/32" Length 4"	Automann TRB5544 BWP M-1694 Dayton 321-194 Euclid E-4827 Flagg TP110 Meritor R304827 Transpro 0649-02
 ST1004	Equalizer Bolt Heavyweight And Super Heavy Duty Model 88 Length 6-7/16" Thread 1" - 14	Automann F100612 GR5 BWP M-1691 Dayton 334-317 Euclid E-4830 Flagg TP109 Meritor R304830 Transpro 0001-14
 SH1027	Equalizer Nut Heavyweight And Super Heavy Duty Model 88 Thread 1" - 14 Hex 1-7/16" Height 7/8"	Automann FLN107 BWP M-2161 Dayton 334-319 Euclid E-2892 Flagg H104 Meritor R302892 Transpro 0274-01





TRANSPRO PARTS

PART NO.	NOTES	REPLACES
	<p>Adjustable Torque Arm</p> <p>Heavyweight And Super Heavy Duty Model 88</p> <p>Length 18-1/4" - 20-3/4"</p> <p>Bushing Number SB1004 Bushing Assembly ST1006</p>	<p>Automann TR009 BWP M-1695 Dayton 345-157 Euclid E-4824 Flagg BK4 Meritor R304824 Transpro 0030-20/1035-20</p>
<p>SB1007</p>		
	<p>Rigid Torque Arm</p> <p>Heavyweight And Super Heavy Duty Model 88</p> <p>Length 19-7/8"</p> <p>Bushing Number SB1004 Bushing Assembly ST1006</p>	<p>Automann TR010 BWP M-1696 Dayton 345-158 Euclid E-4825 Flagg TP116 Meritor R304825 Transpro 0075-20</p>
<p>ST1005</p>		
	<p>Torque Arm Bushing Assembly</p> <p>Heavyweight And Super Heavy Duty Model 88</p> <p>Includes: (1) SB1004 Bushing (1) ST1007 Bolt (1) ST1008 Nut</p>	<p>Automann TRK6004 BWP M-1697 Dayton 334-316 Euclid E-4834A Flagg TP111 Meritor R304834A Transpro 0022-01K</p>
<p>ST1006</p>		
	<p>Torque Arm Bushing</p> <p>Outside Diameter 1-15/16" Inside Diameter 7/8" Overall Length 3"</p> <p>SB1004U is Polyurethane</p>	<p>BWP M-1449 Dayton 321-153/U Euclid E-1980/E-7520 Flagg R129/UB Meritor R301980/R307520 Transpro 0022-00</p>
<p>SB1004/SB1004U</p>		
	<p>Torque Arm Bolt</p> <p>Heavyweight And Super Heavy Duty Model 88</p> <p>Thread 7/8" - 14 Length 5-1/2"</p>	<p>Automann C780512 GR5 BWP M-1698 Dayton 334-1026 Euclid E-4833 Flagg TP112 Meritor R304833 Transpro 0001-08</p>
<p>ST1007</p>		
	<p>Lock Nut</p> <p>Heavyweight And Super Heavy Duty Model 88</p> <p>Thread 7/8" - 14 Hex 1-5/16" Height 3/4"</p>	<p>Automann FLN106 BWP M-1699 Dayton 334-373 Euclid E-9607 Flagg LN106 Meritor R309607 Transpro 0002-12</p>
<p>ST1008</p>		



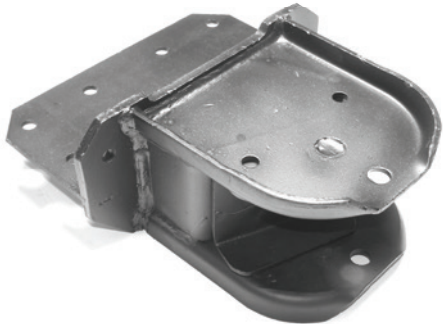
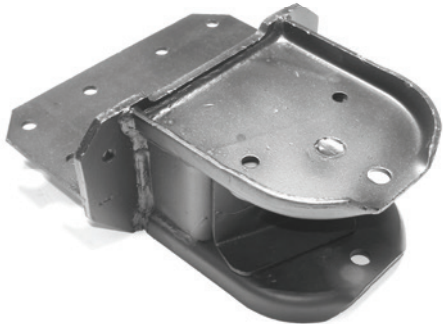

TRANSPRO PARTS

PART NO.	NOTES	REPLACES
	<p>Equalizer Roller Assembly</p> <p>Heavyweight And Super Heavy Duty Model 88</p> <p>Includes: (1) SH1011 Nut (1) SH1045 Bolt (1) SH1046 Sleeve</p>	<p>Automann SRL01 BWP M-2973 Dayton 334-343 Euclid E-4835 Flagg H157/TP101 Meritor R304835 Transpro 0741-00K</p>
SH1057		
	<p>Hanger Roller Assembly</p> <p>Super Heavy Duty Model 88</p>	<p>Automann SRL107 BWP M-1647 Dayton 334-312 Euclid E-4837 Flagg TP113 Meritor R304837 Transpro 0741-05K</p>
ST1009		
	<p>Wear Pad</p> <p>Heavyweight And Super Heavy Duty Model 88</p>	<p>Automann M83457 BWP M-1648 Dayton 338-376 Euclid E-4828 Flagg TP102 Meritor R304828 Transpro 0045-00</p>
ST1019		
	<p>Front Hanger Under Mount</p> <p>Heavyweight And Super Heavy Duty Model 88</p>	<p>Automann M12076 BWP M-3443 Dayton 338-373 Euclid E-4804 Flagg TP104 Meritor R304804 Transpro 0084-00</p>
ST1010		
	<p>Center Hanger Under Mount</p> <p>Heavyweight And Super Heavy Duty Model 88</p>	<p>Automann M12078 BWP M-3444 Dayton 338-374 Euclid E-4805 Flagg TP105 Meritor R304805 Transpro 0088-00</p>
ST1011		
	<p>Rear Hanger Under Mount</p> <p>Heavyweight And Super Heavy Duty Model 88</p>	<p>Automann M12080 BWP M-3445 Dayton 338-375 Euclid E-4806 Flagg TP106 Meritor R304806 Transpro 0086-00</p>
ST1012		

TRANSPRO PARTS

PART NO.	NOTES	REPLACES
ST1013L	Front Hanger Flange Mount Left Side Heavyweight And Super Heavy Duty Model 88	Automann M12082 BWP M-4147 Dayton 338-1409 Euclid E-4807 Flagg TP129 Meritor R304807 Transpro 0400-01
		
ST1013R	Front Hanger Flange Mount Right Side Heavyweight And Super Heavy Duty Model 88	Automann M12084 BWP M-4148 Dayton 338-1410 Euclid E-4808 Flagg TP130 Meritor R304808 Transpro 0400-02
		
ST1014	Center Hanger Flange Mount Heavyweight And Super Heavy Duty Model 88	Automann M12086 BWP M-3447 Dayton 338-1411 Euclid E-4809 Flagg TP131 Meritor R304809 Transpro 0401-00
		
ST1015L	Rear Hanger Flange Mount Left Side Heavyweight And Super Heavy Duty Model 88	Automann M12088 BWP M-4149 Dayton 338-1412 Euclid E-4810 Flagg TP133 Meritor R304810 Transpro 0402-01
		
ST1015R	Rear Hanger Flange Mount Right Side Heavyweight And Super Heavy Duty Model 88	Automann M12090 BWP M-4150 Dayton 338-1413 Euclid E-4811 Flagg TP132 Meritor R304811 Transpro 0402-02
		
SH1023	Delrin Spring Liner Width 2-7/8" Length 8" Thickness .043"	Automann DL376 BWP M-2872 Dayton GL-294 Euclid E-2842 Flagg DL294/DL295 Meritor R302842 Transpro 0375-00
		

TRANSPRO PARTS

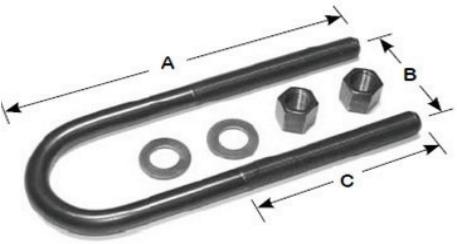
PART NO.	NOTES	REPLACES
 ST1017	Axle Seat 5" Round Axle Heavyweight And Super Heavy Duty Model 88 Height 1"	Automann M12096 BWP M-1692 Dayton 338-382 Euclid E-4814 Flagg TP119 Meritor R304814 Transpro 0636-01
 ST1018	Axle Seat 5" Square Axle Heavyweight And Super Heavy Duty Model 88 Height 2"	Automann M17728 BWP M-3440 Dayton 338-1817 Euclid E-4818 Meritor R304818 Transpro 0632-02
 SH1016	U-Bolt Washer Heat Treated Outside Diameter 1-3/4" Inside Diameter 15/16" Thickness 1/8"	Automann MUBW184 BWP M-2136 Dayton 334-150 Euclid E-2546 Flagg UBW80 Meritor R302546 Transpro T-7292
 SH1039	U-Bolt Hi-Nut Grade 8 Thread 7/8" - 14 Across Flats 1-1/4" Height 1-5/32"	Automann DN5 BWP M-1194 Dayton DN-78 Euclid E-3002A Flagg DN5 Meritor R303002A Transpro 09352-01
5R785146	Grade 5 U-Bolt Assembly Thread 7/8" - 14 A = 14" B = 5" C = 6"	Automann AUBK5165-14 BWP M-1494 Dayton 361-252 Euclid E-UB5165-14 Flagg UBK1295 Meritor R30U5165-14 Transpro 0102-10/14
 5R785186	Grade 5 U-Bolt Assembly Thread 7/8" - 14 A = 18" B = 5" C = 6"	Automann AUBK5165-18 BWP M-2798 Dayton 361-587 Euclid E-UB5165-18 Flagg UBK2695 Meritor R30U5165-18 Transpro 0102-13/18

U-BOLT ASSEMBLIES

Includes Nuts And Washers

PART NO.

5 R 7 8 3 12 3

GRADE

STYLE

THREAD

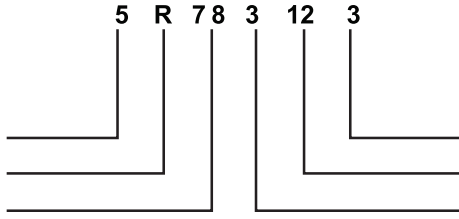

"C"

"A"

"B"

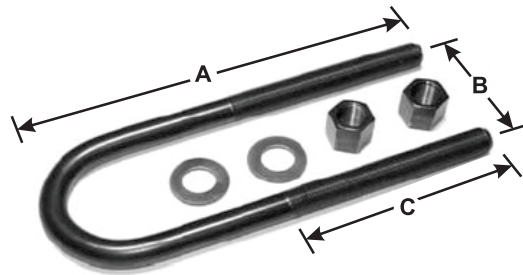

"R" = Round

"S" = Square

PART NO.	BWP	DAYTON	EUCLID	FLAGG	MERITOR
5R783123	M-1499	361-248	E-UB5161-12	UBK1245	R30U5161-12
5R783136		361-577	E-UB5161-13		R30U5161-13
5R783146	M-1492	361-218	E-UB5161-14	UBK1225	R30U5161-14
5R783156	M-4033	361-584	E-UB5161-15		R30U5161-15
5R783166	M-1497	361-492	E-UB5161-16	UBK2625	R30U5161-16
5R783176		361-585			
5R783186	M-1493	361-250	E-UB5161-18	UBK1335	R30U5161-18
5R7835146	M-2796	361-490	E-UB5163-14	UBK2655	R30U5163-14
5R7835186	M-2797	361-491	E-UB5163-18	UBK2665	R30U5163-18
5R785123			E-UB5165-12	UBK2675	R30U5165-12
5R785136					
5R785146	M-1494	361-252	E-UB5165-14	UBK1295	R30U5165-14
5R785156			E-UB5165-15		R30U5165-15
5R785166			E-UB5165-16	UBK2685	R30U5165-16
5R785176					
5R785186	M-2798	361-587	E-UB5165-18	UBK2695	R30U5165-18
8R343103					
8R343123		361-469	E-UB8151-12	UBK104	R30U8151-12
8R343186	M-1490	361-262	E-UB8151-18	UBK114	R30U8151-18
8S343123					
8S343146					
8R344186	M-1498	361-182	E-UB8154-18	UBK117	R30U8154-18
8R783123	M-4034	361-589	E-UB8161-12	UBK124	R30U8161-12
8R783136		361-566	E-UB8161-13	UBK125	R30U8161-13
8R783146		361-374	E-UB8161-14	UBK122	R30U8161-14
8R783156		361-350	E-UB8161-15	UBK266	R30U8161-15
8R783166	M-4035	361-168	E-UB8161-16	UBK126	R30U8161-16
8R783176	M-4036		E-UB8161-17	UBK265	R30U8161-17
8R783186	M-4037	361-609	E-UB8161-18	UBK133	R30U8161-18
8R785123		361-258	E-UB8165-12	UBK142	R30U8165-12
8R785136		361-559	E-UB8165-13	UBK143	R30U8165-13
8R785146		361-254	E-UB8165-14	UBK129	R30U8165-14
8R785156					
8R785166		361-558	E-UB8165-16	UBK144	R30U8165-16
8R785186		361-509	E-UB8165-18	UBK137	R30U8165-18

Copyright 2016 Sirco Industries, Inc.

Each Assembly Contains: (1) U-Bolt, (2) Grade 8 Hi-Nuts, And (2) Heat Treated Washers

Each Kit Contains: (2) U-Bolts, (4) Grade 8 Hi-Nuts, And (4) Heat Treated Washers

HI-NUTS

PART NO.	THREAD	A.F.	HEIGHT	AUTOMANN	BWP	DAYTON	EUCLID	FLAGG	MERITOR
SH1086	3/8" - 24	9/16"	1/2"	DN00	M-1195	DN-38		DN00	
SH1087	7/16" - 20	5/8"	39/64"	DN0	M-1196	DN-716		DN0	
SH1080	1/20" - 20	3/4"	11/16"	DN1	M-1197	DN-12	E-9605	DN1	R309605
SH1081	9/16" - 18	7/8"	49/64"	DN2	M-1198	DN-916	E-9606	DN2	R309606
SH1082	5/8" - 18	15/16"	27/32"	DN3	M-1192	DN-58	E-3000	DN3	R303000
SH1064	3/4" - 16	1-1/16"	1"	DN4	M-1193	DN-34		DN4	R303001
SH1064H	3/4" - 16	1-1/8"	1"	DN4H		DN-34A	E-3001		
SH1039	7/8" - 14	1-1/4"	1-5/32"	DN5	M-1194	DN-78	E-3002A	DN5	R303002A
SH1039H	7/8" - 14	1-5/16"	1-5/32"			DN-78A			
SH1083	1" - 14	1-7/16"	1-5/16"	DN6	M-1199	DN-100		DN6	R303003
SH1083H	1" - 14	1-1/2"	1-5/16"			DN-100A	E-3003		
SH1084	1-1/8" - 12	1-5/8"	1-15/32"	DN7	M-1191	DN-118	E-3004	DN7	R303004
SH1085	1-1/4" - 12	1-13/16"	1-5/8"	DN8		DN-125	E-3005	DN8	R303005

9/16" Thru 1-1/4" Hi-Nuts Are Grade 8

HARDENED WASHERS

PART NO.	I.D.	O.D.	THK	AUTOMANN	BWP	DAYTON	EUCLID	FLAGG	MERITOR
SH1090	3/8"	13/16"	9/64"	MUBW124				UBW50	
SH1091	7/16"	59/64"	9/64"	MUBW134		SUW-716		UBW55	
SH1092	1/2"	1-1/16"	1/8"	MUBW144		SUW-12	E-9603	UBW60	R309603
SH1093	9/16"	1-3/16"	1/8"	MUBW154		SUW-916	E-9604	UBW65	R309604
SH1094	5/8"	1-5/16"	1/8"	MUBW164		SUW-58	E-2547	UBW70	R302547
SH1063	3/4"	1-15/32"	1/8"	MUBW174	M-2854	SUW-34	E-2545	UBW75	R302545
SH1016	7/8"	1-3/4"	1/8"	MUBW184	M-2136	334-150	E-2546	UBW80	R302546
SH1095	1"	2"	5/32"	MUBW194	M-1681	SUW-100	E-2975	UBW85	R302975
SH1096	1-1/8"	2-1/4"	1/8"			SUW-118		UBW88	
SH1097	1-1/4"	2-1/4"	1/4"	MUBW204		SUW-125	E-2934	UBW90	

Copyright 2016 Sirco Industries, Inc.

AIR SPRINGS INFORMATION PAGE

SAMPLE OF CATALOG PAGE

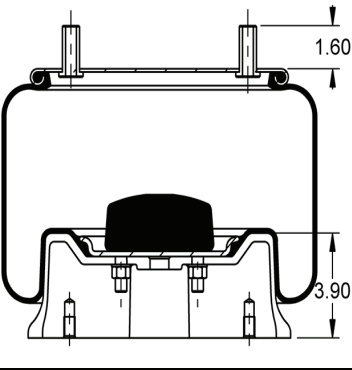
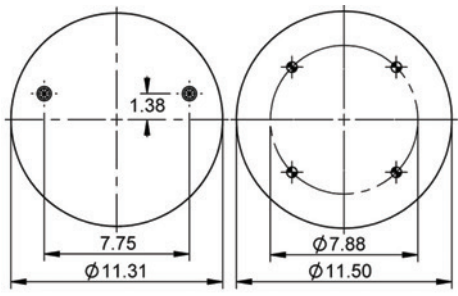
PART NO.	DIMENSIONS	REPLACES																										
 <p>AS8050</p> <p>CROSS SECTION</p>	 <p>11 - 10.5 - 16</p> <p>TOP AND BOTTOM VIEW</p>	<table border="0"> <tr><td>Automann</td><td>AB1DK28A-8050</td></tr> <tr><td>ContiTech</td><td>64254</td></tr> <tr><td>Dayton</td><td>1R14-039</td></tr> <tr><td>Euclid</td><td>FS8050</td></tr> <tr><td>Firestone</td><td>W01-358-8050</td></tr> <tr><td>Goodyear</td><td>1R14-039</td></tr> <tr><td>Hendrickson</td><td>S-4771</td></tr> <tr><td></td><td>S-12514-013</td></tr> <tr><td>Holland-Neway</td><td>570-08-050</td></tr> <tr><td>Navistar</td><td>1685174C1</td></tr> <tr><td>Reyco</td><td>23631-01</td></tr> <tr><td>Road Leveler</td><td>RL80500</td></tr> <tr><td>Triangle</td><td>8320</td></tr> </table> <p>INTERCHANGES</p>	Automann	AB1DK28A-8050	ContiTech	64254	Dayton	1R14-039	Euclid	FS8050	Firestone	W01-358-8050	Goodyear	1R14-039	Hendrickson	S-4771		S-12514-013	Holland-Neway	570-08-050	Navistar	1685174C1	Reyco	23631-01	Road Leveler	RL80500	Triangle	8320
Automann	AB1DK28A-8050																											
ContiTech	64254																											
Dayton	1R14-039																											
Euclid	FS8050																											
Firestone	W01-358-8050																											
Goodyear	1R14-039																											
Hendrickson	S-4771																											
	S-12514-013																											
Holland-Neway	570-08-050																											
Navistar	1685174C1																											
Reyco	23631-01																											
Road Leveler	RL80500																											
Triangle	8320																											

MEASURING AIR SPRINGS

Part # AS8050

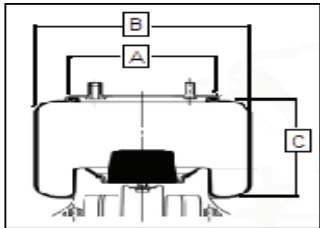

Rolling Lobe

- 1) Measure the diameter of the bead plate - dimension A
- 2) Measure the diameter of the molded rubber bellows - dimension B
- 3) Measure the height of the molded bellows - dimension C

The numbers in the lower right corner of the dimension area are those dimensions
A = 11" B = 10.5" C = 16"

Rolling lobe air springs consist of rubber bellows, top plate, piston and optional internal bumper. The bellows have a certain molded diameter that differs from the operational diameter. The operational diameter increases with increasing internal pressure until specified maximum operational pressure and therefore maximum operational diameter is reached. To assure that the bellows roll uniformly over the piston a minimum working pressure is required. Rolling lobe air springs provide the maximum ride comfort and therefore are the most popular air spring design for commercial vehicle suspensions.

Part # AS6910

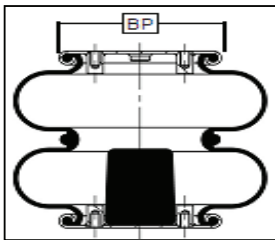

Double Convoluted

The number in the lower right corner of the dimension area is FD-200

- 1) The first part (FD) is the number of bellows
 FS = Single Convoluted
 FD = Double Convoluted
 FT = Triple Convoluted
- 2) The second part (200) is the dimension of the bead plate
 200 = 6.3"
 330 = 9"
 530 = 11"





FD 200-19

This is a Double Convoluted spring (FD) with a 6.3" Bead Plate (200)

Convoluted air springs consist of rubber bellows, top and bottom plate and optional internal bumper. There are bellows with 1, 2 and 3 convolutions. Most common for commercial vehicle applications are 2- and 3-convoluted bellows. The convoluted bellows are commonly used for applications with low working pressure, off-set mounting and large operational angles as required for lift and auxiliary axle suspensions. Convoluted air springs are also widely used for industrial applications as air actuators (pneumatic systems) or as vibration isolators (machine mounting).





ROLLING LOBE AIR SPRINGS

PART NO.	DIMENSIONS	REPLACES	
		Automann ContiTech Dayton Euclid Firestone Goodyear Hendrickson Holland-Neway Navistar Reyco Road Leveler Triangle	AB1DK28A-8050 64254 1R14-039 FS8050 W01-358-8050 1R14-039 S-4771 S-12514-013 570-08-050 1685174C1 23631-01 RL80500 8320
AS8050	11 - 10.5 - 16		
		Automann ContiTech Dayton Euclid Firestone Goodyear Hendrickson Road Leveler Triangle	AB1DK28E-8091 64421 1R14-171 FS8091 W01-358-8091 1R14-171 S-20901 S-21784 RL80910 8523
AS8091	11 - 10.5 - 16		
		Automann ContiTech Dayton Euclid Firestone Goodyear Holland-Neway Road Leveler Triangle	AB1DK23H-8204 64456 1R12-508 FS8204 W01-358-8204 1R12-508 1R12-522 905-57-173 905-57-223 RL82040 8484
AS8204	9 - 10 - 12		
		Automann ContiTech Dayton Euclid Firestone Goodyear Hendrickson Road Leveler Triangle	AB1DK25E-8708 64638 1R13-177 FS8708 W01-358-8708 1R13-177 S-21966 RL87080 8526
AS8708	10 - 10 - 16		

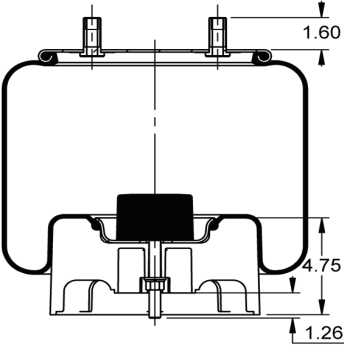
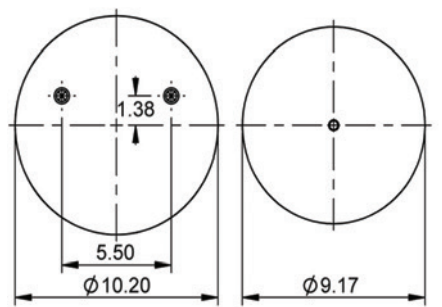
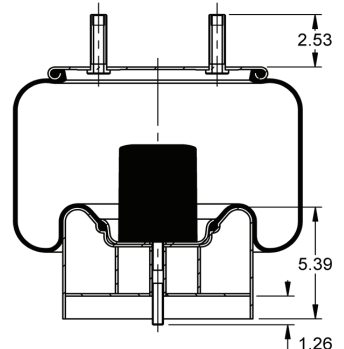
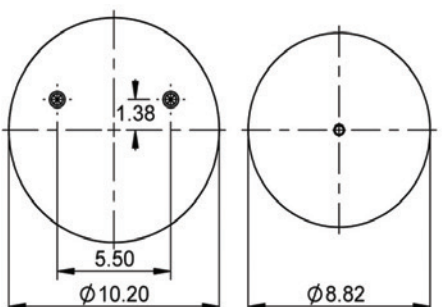
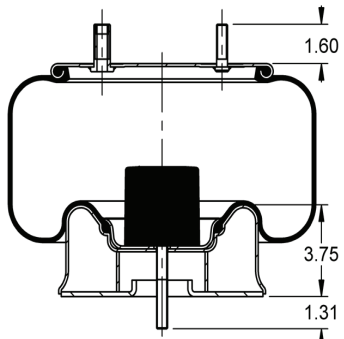
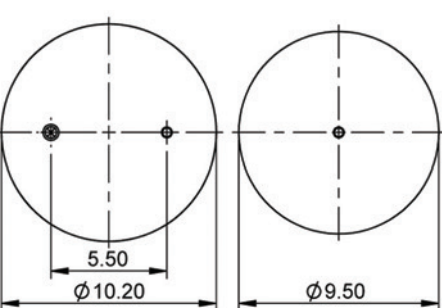
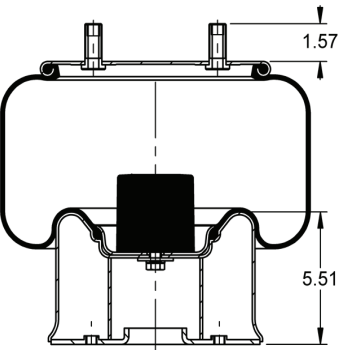
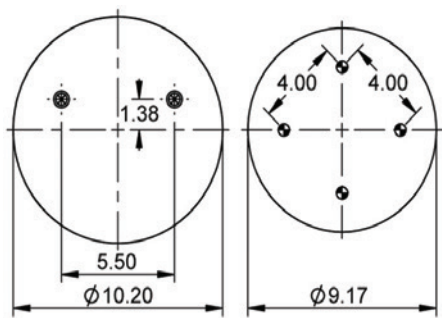
-  Combination air inlet & stud; stud outside thread 3/4"-16, stud inside thread for air inlet 1/4" - 18 N.P.T.
-  Exceptions noted in drawings for part variance
-  Blind nut for bead plates 3/8-16 UNC; for pistons 1/2"-13 UNC
-  Bolt or stud 1/2"-13 UNC
-  Air inlet 1/4" - 18 N.P.T.





ROLLING LOBE AIR SPRINGS

PART NO.	DIMENSIONS	REPLACES	
 <p>AS8709</p>	 <p>10 - 10.5 - 15</p>	Automann ContiTech Dayton Euclid Firestone Goodyear Hendrickson Road Leveler Triangle	AB1DK25A-8709 64645 1R13-159 FS8709 W01-358-8709 1R13-159 S-21800 RL87090 8460
 <p>AS8713</p>	 <p>10 - 10 - 16</p>	Automann ContiTech Dayton Euclid Firestone Goodyear Hendrickson Road Leveler Triangle	AB1DK25E-8713 64636 1R13-176 FS8713 W01-358-8713 1R13-140 1R13-176 S-22948 RL87130 8533
 <p>AS8729</p>	 <p>10 - 10 - 13</p>	Automann ContiTech Dayton Euclid Firestone Goodyear Meritor Road Leveler Triangle	AB1DK25D-8729 64420 1R13-130 FS8729 W01-358-8729 1R13-130 202796 RL87290 8513
 <p>AS8755</p>	 <p>10 - 10 - 15</p>	Automann ContiTech Dayton Euclid Firestone Goodyear Hendrickson Road Leveler Triangle	AB1DK25B-8755 64397 1R13-124 FS8755 W01-358-8755 1R13-124 S-21623 S-22045 RL87550 8522

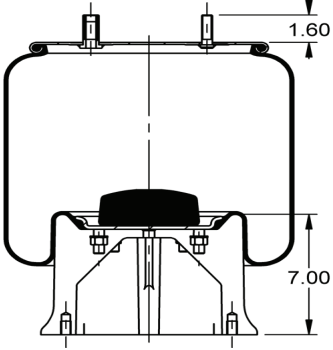
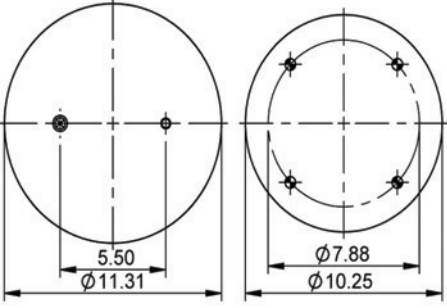
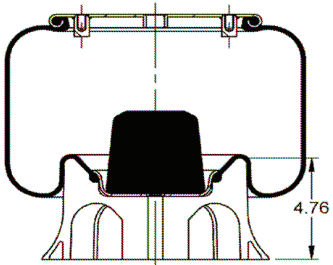
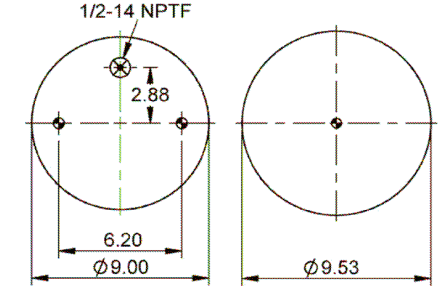
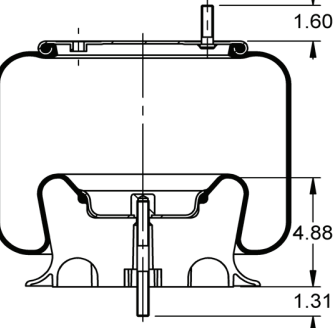
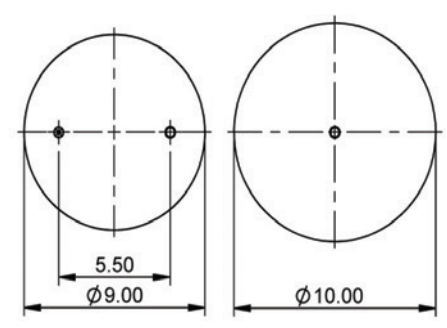
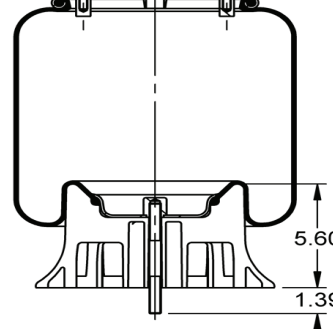
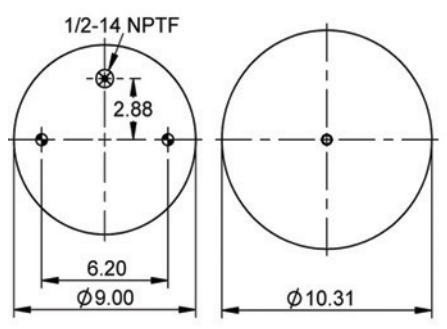
-  Combination air inlet & stud; stud outside thread 3/4"-16, stud inside thread for air inlet 1/4" - 18 N.P.T.
-  Exceptions noted in drawings for part variance
-  Blind nut for bead plates 3/8-16 UNC; for pistons 1/2"-13 UNC
-  Bolt or stud 1/2"-13 UNC
-  Air inlet 1/4" - 18 N.P.T.





ROLLING LOBE AIR SPRINGS

PART NO.	DIMENSIONS	REPLACES
 <p>AS8792</p>	 <p>11 - 10.5 - 21</p>	<p>Dayton 1R14-045 Euclid FS8792 Firestone W01-358-8792 Goodyear 1R14-045 Navistar 1681748C1 Road Leveler RL91220</p>
 <p>AS8813</p>	 <p>9 - 10 - 14</p>	<p>Automann AB1DK23I-8813 ContiTech 65990 Euclid FS8813 Firestone W01-358-8813 Peterbilt C81-6000 Road Leveler RL88130 Triangle 8577</p>
 <p>AS8829</p>	 <p>9 - 10 - 16</p>	<p>Automann AB1DK23K-8829 ContiTech 64312 Dayton 1R12-615 Euclid FS8829 Firestone W01-358-8829 Goodyear 1R12-405/615 1S12-002 Road Leveler RL88290 Triangle 8449 Volvo 3934699/8079902 8084296/8097092 20505399</p>
 <p>AS8852</p>	 <p>9 - 10 - 19</p>	<p>Automann AB1DK23L-8852 ContiTech 64339 Dayton 1R12-568 Euclid FS8852 Firestone W01-358-8852 Goodyear 1R12-568 Peterbilt 03-07887 Road Leveler RL88520 Triangle 8472</p>

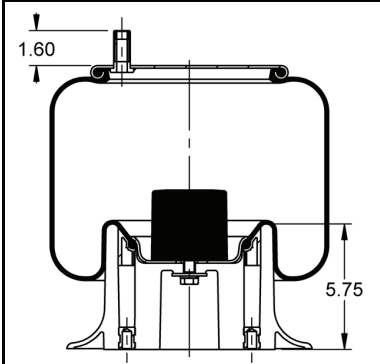
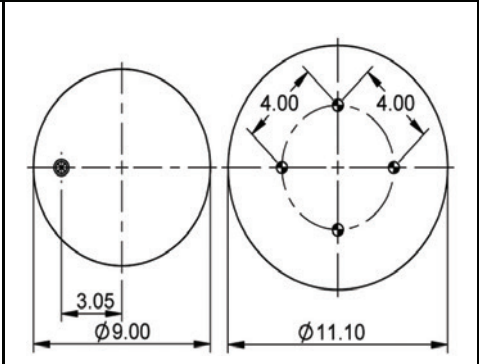
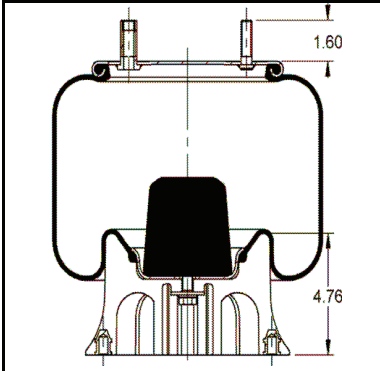
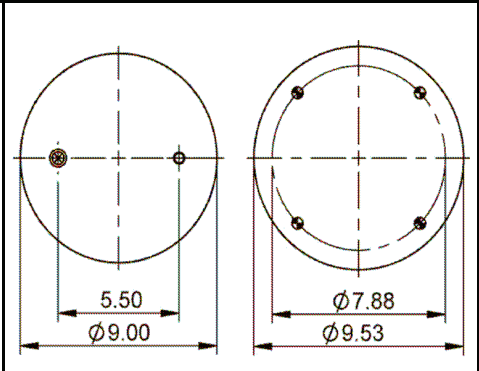
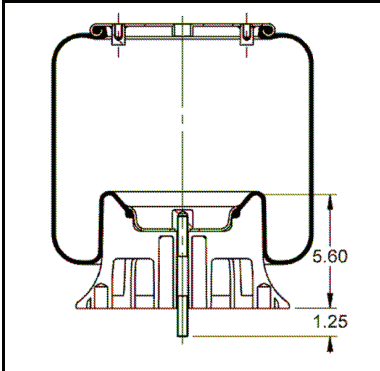
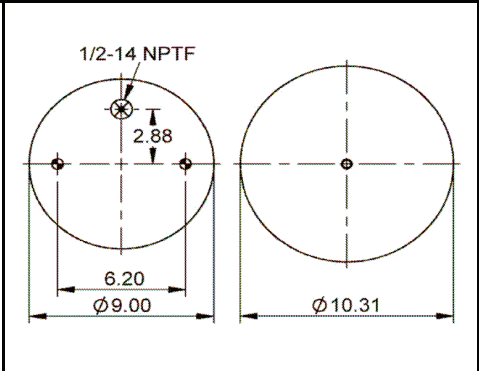
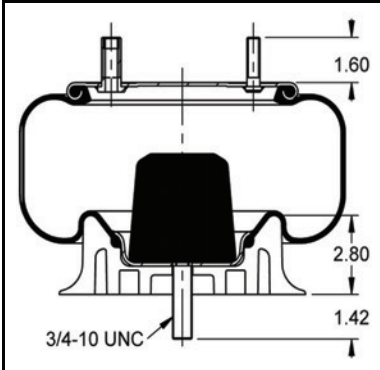
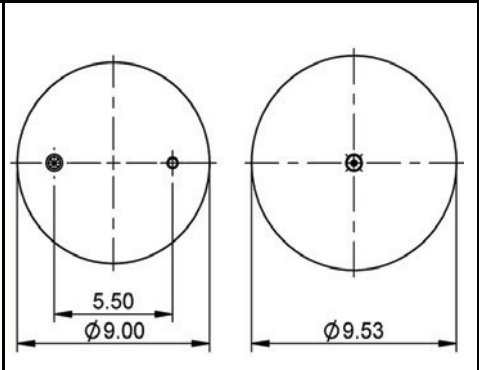
-  Combination air inlet & stud; stud outside thread 3/4"-16, stud inside thread for air inlet 1/4" - 18 N.P.T.
-  Exceptions noted in drawings for part variance
-  Blind nut for bead plates 3/8-16 UNC; for pistons 1/2"-13 UNC
-  Bolt or stud 1/2"-13 UNC
-  Air inlet 1/4" - 18 N.P.T.

ROLLING LOBE AIR SPRINGS

PART NO.	DIMENSIONS	REPLACES
 <p>AS8944</p>	 <p>9 - 10 - 17.5</p>	<p>Automann AB1DK23P-8944 ContiTech 64401 Dayton 1R12-366 Euclid FS8944 Firestone W01-358-8944 W01-358-9015 Goodyear 1R12-271 1R12-366 Hendrickson S-20217 Road Leveler RL89440 Triangle 8436</p>
 <p>AS9010</p>	 <p>9 - 10 - 14</p>	<p>Automann AB1DK23I-9010 ContiTech 64258 Euclid FS9010 Firestone W01-358-9010 Goodyear 1R12-421 1R12-352 Hendrickson S-2827 S-11566 Reyco 12928-01 Triangle 8345 Watson Chalin AS-0044</p>
 <p>AS9026</p>	 <p>9 - 10 - 16</p>	<p>Automann AB1DK23K-9026 ContiTech 64306 Dayton 1R12-567 Euclid FS9026 Firestone W01-358-9026 Goodyear 1R12-567 Triangle 8393</p>
 <p>AS9039</p>	 <p>9 - 10 - 10</p>	<p>Automann AB1DK23F-9039 ContiTech 64260 Dayton 1R12-095 Euclid FS9039 Firestone W01-358-9039 Goodyear 1R12-095 Hendrickson S-2064 S-11650 Holland-Neway 905-57-011/023/085 Navistar 554766C1 Road Leveler RL90390 Triangle 8311 Volvo 85101153</p>

-  Combination air inlet & stud; stud outside thread 3/4"-16, stud inside thread for air inlet 1/4" - 18 N.P.T.
-  Exceptions noted in drawings for part variance
-  Blind nut for bead plates 3/8-16 UNC; for pistons 1/2"-13 UNC
-  Bolt or stud 1/2"-13 UNC
-  Air inlet 1/4" - 18 N.P.T.





ROLLING LOBE AIR SPRINGS

PART NO.	DIMENSIONS	REPLACES	
		Automann AB1DK231-9069 ContiTech 64274 Dayton 1R12-069 Euclid FS9069 Firestone W01-358-9069 Goodyear 1R12-069/1R12-669 Hendrickson S-13031 Navistar 554764C1 Peterbilt 02456/04759/06746 Road Leveler RL90690 Triangle 8312 Volvo 85101145	
AS9069	9 - 10 - 14	Watson Chalin AS-0077	
		Automann AB1DK23K-9082 ContiTech 64269 Dayton 1R12-092 Euclid FS9082 Firestone W01-358-9082 Goodyear 1R12-092/1R12-509 Hendrickson S-2066/S-11651 Holland-Neway 905-57-006/027/033 Navistar 517559C9 Reyco 12882-01 Road Leveler RL90820 Triangle 8310	
AS9082	9 - 10 - 16	Watson Chalin AS-0011	
		Automann AB1DK23L-9101 ContiTech 64279 Dayton 1R12-103 Euclid FS9101 Firestone W01-358-9101 Goodyear 1R12-103 Holland-Neway 905-57-008/009 905-57-043/082 Navistar 554768C1 Reyco 12883-01 Road Leveler RL91010 Triangle 8315	
AS9101	9 - 10 - 19	Watson Chalin AS-0040	
		Automann AB1D28G-9121 ContiTech 64272 Dayton 1R13-039 Euclid FS9121 Firestone W01-358-9121 Goodyear 1R13-039 Hendrickson S-13160 Holland-Neway 905-570-019 905-570-052/078 Navistar 554773C1 Reyco 12882-02 Road Leveler RL91210 Triangle 8317	
AS9121	11 - 10.5 - 17		

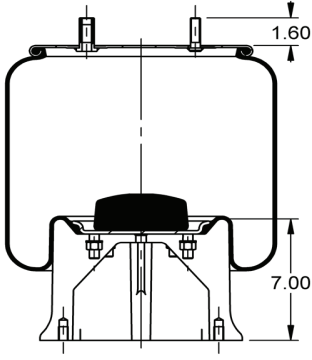
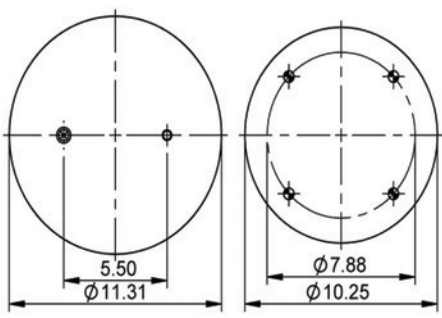
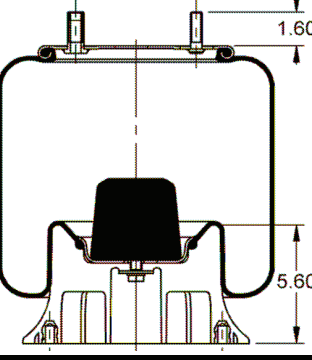
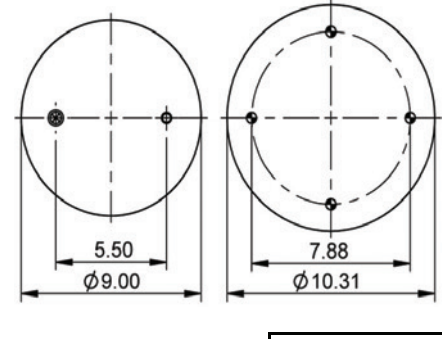
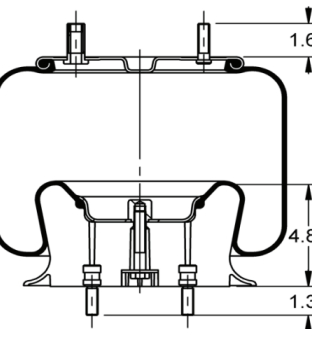
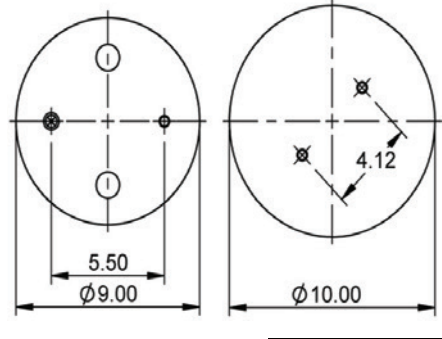
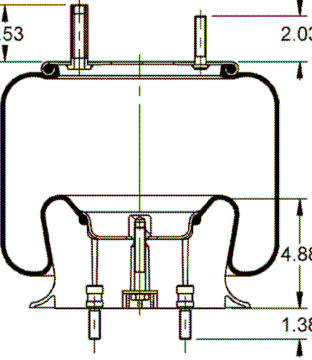
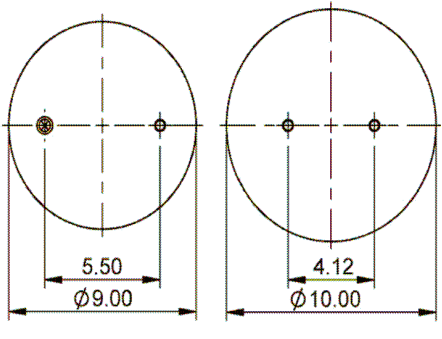
- Combination air inlet & stud; stud outside thread 3/4"-16, stud inside thread for air inlet 1/4" - 18 N.P.T.
- Exceptions noted in drawings for part variance
- Bolt or stud 1/2"-13 UNC
- Blind nut for bead plates 3/8-16 UNC; for pistons 1/2"-13 UNC
- Air inlet 1/4" - 18 N.P.T.

ROLLING LOBE AIR SPRINGS

PART NO.	DIMENSIONS	REPLACES
 <p>AS9122</p>	 <p>11 - 10.5 - 21</p>	<p>Automann AB1D28C-9122 ContiTech 64273 Firestone W01-358-9122 Goodyear 1R13-038 Hendrickson S-3467 S-12514-008 S-12514-010 Reyco 12883-02 Triangle 8313 Volvo 85101163</p>
 <p>AS9192</p>	 <p>9 - 10 - 19</p>	<p>Automann AB1DK23L-9192 ContiTech 64323 Dayton 1R12-167 Euclid FS9192 Firestone W01-358-9192 Goodyear 1R12-167 Hendrickson S-6195 Holland-Neway 905-57-086/108 905-57-135 Triangle 8326 Watson Chalin AS-0038/46</p>
 <p>AS9213</p>	 <p>9 - 10 - 16</p>	<p>Automann AB1DK23K-9213 ContiTech 64308 Dayton 1R12-090 Euclid FS9213 Firestone W01-358-9213 Goodyear 1R12-090 Navistar 501559C-1/2 1660581C-1 Road Leveler RL92130 Triangle 8407 8441</p>
 <p>AS9219</p>	 <p>9 - 10 - 16</p>	<p>Automann AB1DK23K-9219 ContiTech 64259 Dayton 1R12-182 Euclid FS9219 Firestone W01-358-9219 Goodyear 1R12-182 Holland-Neway 570-09-219 Navistar 1672401C1 Triangle 8408 Volvo 35003-3201/03 35003-3204/09</p>

-  Combination air inlet & stud; stud outside thread 3/4"-16, stud inside thread for air inlet 1/4" - 18 N.P.T.
-  Exceptions noted in drawings for part variance
-  Blind nut for bead plates 3/8-16 UNC; for pistons 1/2"-13 UNC
-  Bolt or stud 1/2"-13 UNC
-  Air inlet 1/4" - 18 N.P.T.

ROLLING LOBE AIR SPRINGS

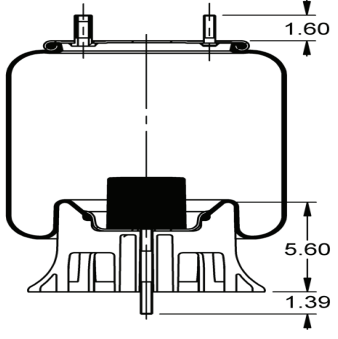
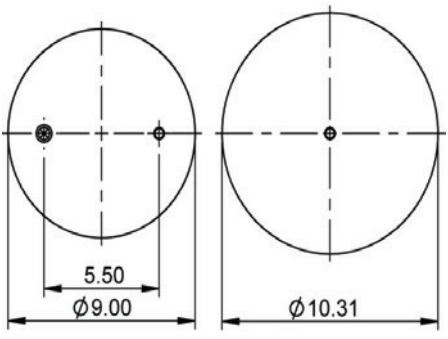
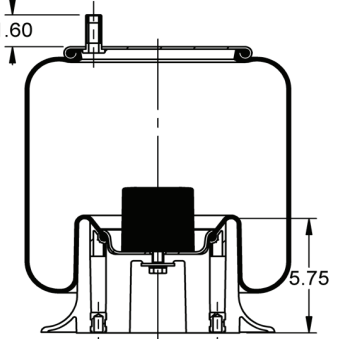
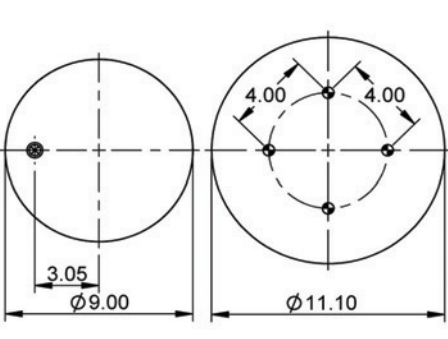
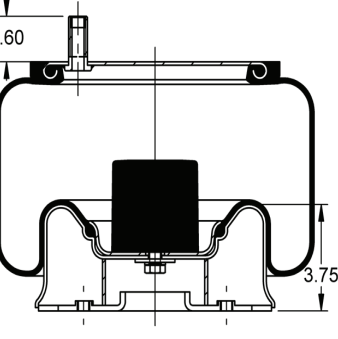
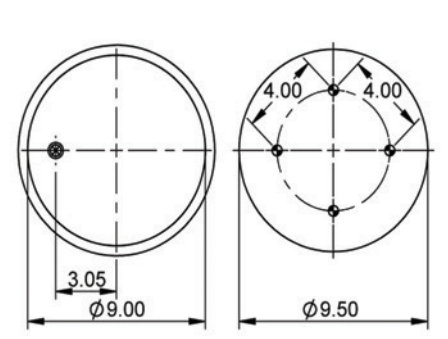
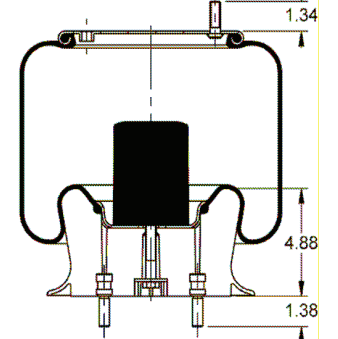
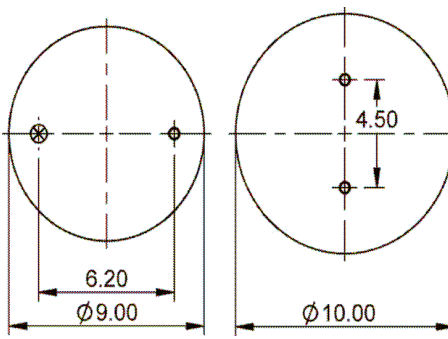
PART NO.	DIMENSIONS	REPLACES
 <p>AS9243</p>	 <p>9 - 10 - 19</p>	<p>Automann AB1DK23L-9243 ContiTech 64329 Dayton 1R12-480 Euclid FS9243 Firestone W01-358-9243 Goodyear 1R12-480 Holland-Neway 905-57-112 Road Leveler RL92430 Triangle 8384 Watson Chalin AS-0061</p>
 <p>AS9265</p>	 <p>9 - 10 - 19</p>	<p>Automann AB1DK23L-9265 ContiTech 64288 Dayton 1R12-375 Euclid FS9265 Firestone W01-358-9265 Goodyear 1R12-375 Hendrickson S-20124 S-20413 Road Leveler RL92650 Triangle 8435 Volvo 85101155</p>
 <p>AS9270</p>	 <p>9 - 10 - 13.5</p>	<p>Automann AB1DK23I-9270 ContiTech 64287 Dayton 1R13-119 Euclid FS9270 Firestone W01-358-9270 Goodyear 1R13-119 Hendrickson S-20010 S-25559 Road Leveler RL92700 Triangle 8433 Volvo 85101147</p>
 <p>AS9287</p>	 <p>9 - 10 - 17.5</p>	<p>Automann AB1DK23P-9287 ContiTech 64277 Euclid FS9287 Firestone W01-358-9287 Goodyear 1R12-424 1S12-027 Hendrickson S-50405-01/02 Loadguard SC2770 Navistar 1622372C1 Triangle 8406</p>

- ⊗ Combination air inlet & stud; stud outside thread 3/4"-16, stud inside thread for air inlet 1/4" - 18 N.P.T.
- ⊙ Exceptions noted in drawings for part variance
- ⊙ Bolt or stud 1/2"-13 UNC
- ⊙ Blind nut for bead plates 3/8-16 UNC; for pistons 1/2"-13 UNC
- ⊙ Air inlet 1/4" - 18 N.P.T.



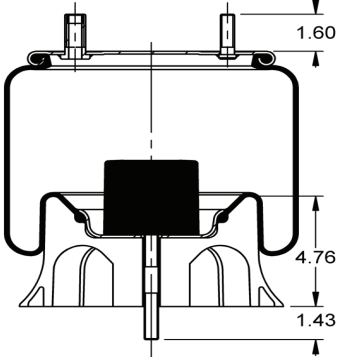
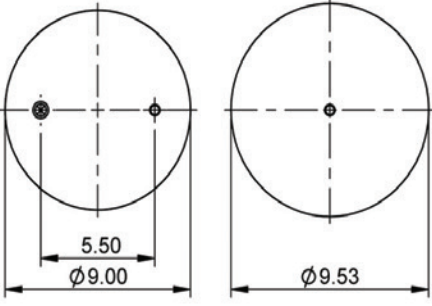
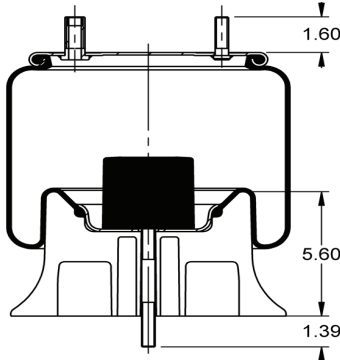
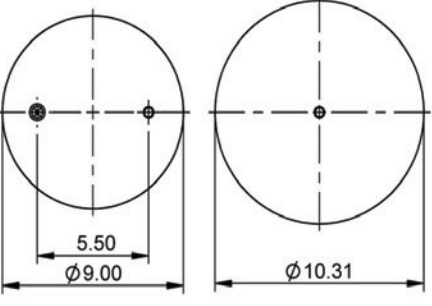
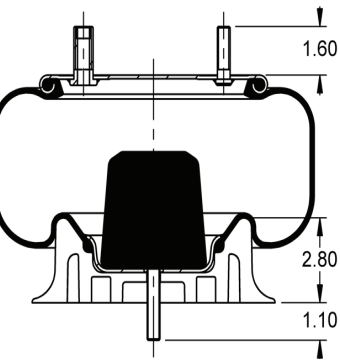
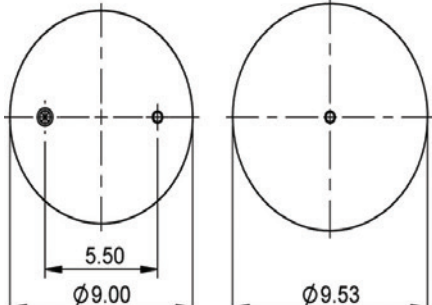
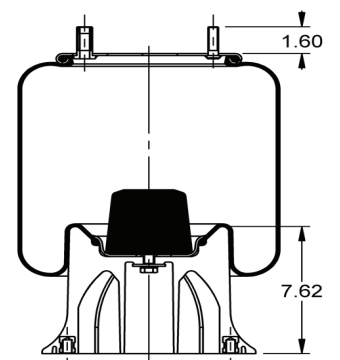
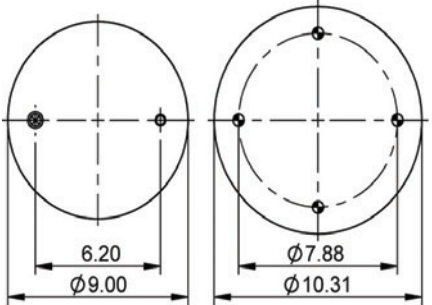

ROLLING LOBE AIR SPRINGS

PART NO.	DIMENSIONS	REPLACES
 <p>AS9293</p>	 <p>9 - 9 - 15</p>	<p>Automann AB1DK20F-9293 ContiTech 64388 Dayton 1R10-120 Euclid FS9293 Firestone W01-358-9293 Goodyear 1R10-120 Granning 8896 Holland-Neway 905-57-120 Road Leveler RL92930 Triangle 8424</p>
 <p>AS9295</p>	 <p>9 - 9 - 15</p>	<p>Automann AB1DK20F-9295 ContiTech 64386 Dayton 1R11-166 Euclid FS9295 Firestone W01-358-9295 Goodyear 1R11-166 Holland-Neway 905-57-121 Road Leveler RL92950 Triangle 8417</p>
 <p>AS9307</p>	 <p>9 - 10 - 10</p>	<p>Automann AB1DK20F-9307 ContiTech 64439 Dayton 1R12-435 Euclid FS9307 Firestone W01-358-9307 Goodyear 1R12-435 Holland-Neway 905-57-129 Road Leveler RL93070 Triangle 8471</p>
 <p>AS9321</p>	 <p>9 - 10 - 21</p>	<p>Automann AB1DK23N-9321 ContiTech 64291 Dayton 1R12-335 Euclid FS9321 Firestone W01-358-9321 Goodyear 1R12-335 Granning 7640 Holland-Neway 570-09-321 Road Leveler RL93210 Triangle 8361 Volvo 85101160 Watson Chalin AS-0036</p>

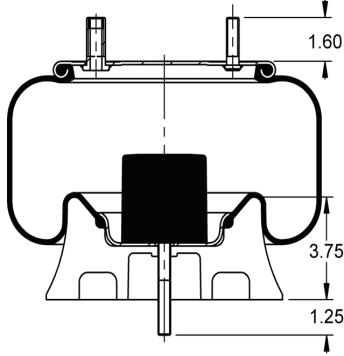
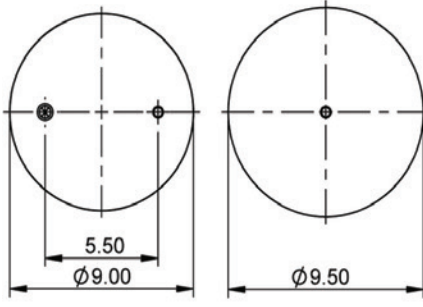
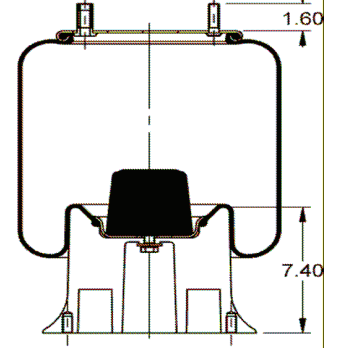
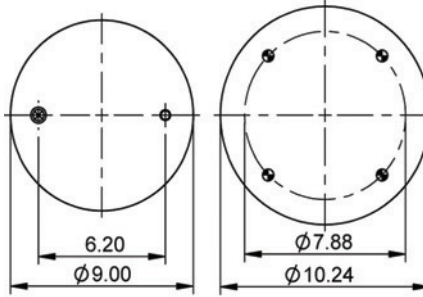
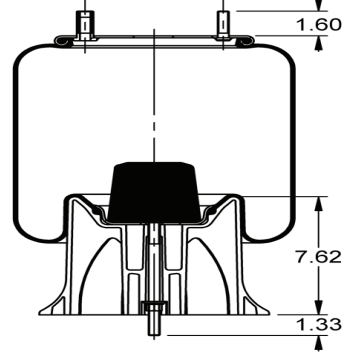
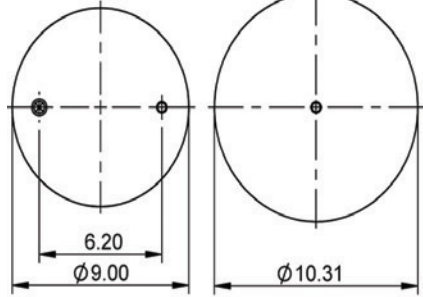
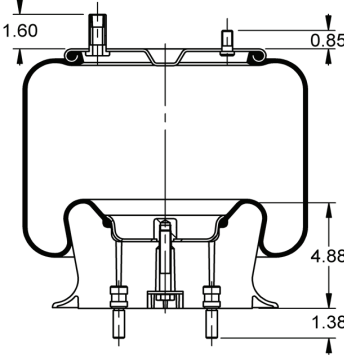
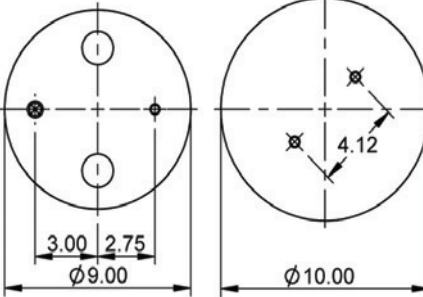
- ⊗ Combination air inlet & stud; stud outside thread 3/4"-16, stud inside thread for air inlet 1/4" - 18 N.P.T.
- ⊙ Exceptions noted in drawings for part variance
- ⊙ Bolt or stud 1/2"-13 UNC
- ⊙ Blind nut for bead plates 3/8-16 UNC; for pistons 1/2"-13 UNC
- ⊙ Air inlet 1/4" - 18 N.P.T.





ROLLING LOBE AIR SPRINGS

PART NO.	DIMENSIONS	REPLACES
 <p>AS9366</p>	 <p>9 - 10 - 12</p>	<p>Automann AB1DK23H-9366 ContiTech 64459 Dayton 1R12-487 Euclid FS9366 Firestone W01-358-9366 Goodyear 1R12-487 Holland-Neway 905-57-160/225 Road Leveler RL93660 Triangle 8488 Watson Chalin AS-0054</p>
 <p>AS9367</p>	 <p>9 - 10 - 21</p>	<p>Automann AB1DK23N-9367 ContiTech 64716 Dayton 1R12-256 Euclid FS9367 Firestone W01-358-9367 Goodyear 1R12-256 Hendrickson S-14249 Loadguard SC2120 Reyco 23521-01 Triangle 8505 Watson Chalin AS-0104</p>
 <p>AS9370</p>	 <p>9 - 10 - 21</p>	<p>Automann AB1DK23N-9370 ContiTech 64383 Dayton 1R12-503 1R12-580 Euclid FS9370 Firestone W01-358-9370 Goodyear 1R12-503 1R12-580 Road Leveler RL93700 Triangle 8448 Watson Chalin AS-0057</p>
 <p>AS9371</p>	 <p>9 - 10 - 17.5</p>	<p>Automann AB1DK23L-9371 ContiTech 64290 Dayton 1R12-401 Euclid FS9371 Firestone W01-358-9371 Goodyear 1R12-401 1S12-244 Navistar 1670043C1 1670073C-1 1686386C-1 2027911C-1 Road Leveler RL93710 Triangle 8521</p>

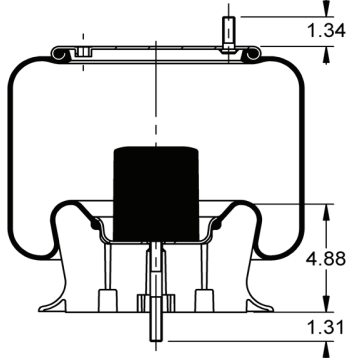
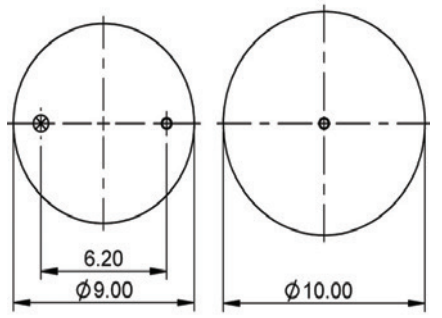
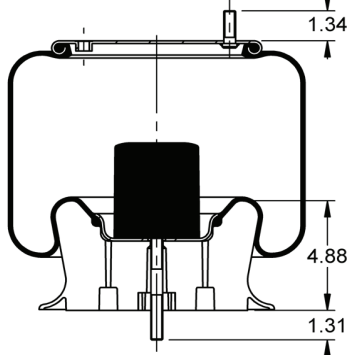
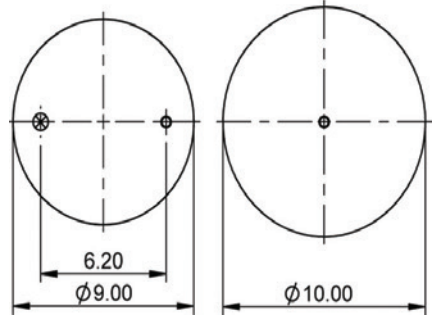
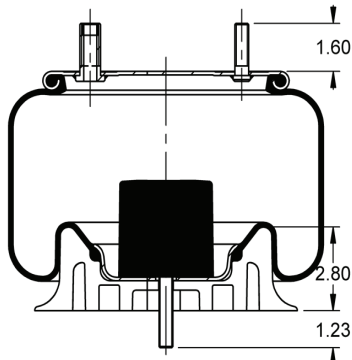
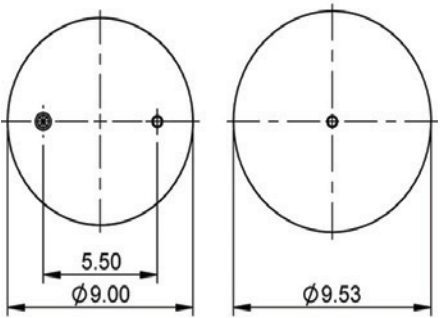
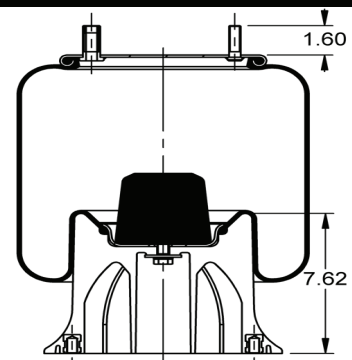
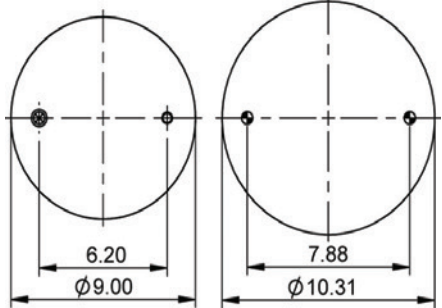
-  Combination air inlet & stud; stud outside thread 3/4"-16, stud inside thread for air inlet 1/4" - 18 N.P.T.
-  Exceptions noted in drawings for part variance
-  Blind nut for bead plates 3/8-16 UNC; for pistons 1/2"-13 UNC
-  Bolt or stud 1/2"-13 UNC
-  Air inlet 1/4" - 18 N.P.T.





ROLLING LOBE AIR SPRINGS

PART NO.	DIMENSIONS	REPLACES
 <p>AS9373</p>	 <p>9 - 10 - 17.5</p>	<p>Automann AB1DK23P-9373 ContiTech 64336 Dayton 1R12-403 Euclid FS9373 Firestone W01-358-9373 Goodyear 1R12-403 Hendrickson S-57122-1/2 Road Leveler RL93730 Triangle 8440 Watson Chalin AS-0127G</p>
 <p>AS9375</p>	 <p>Mounting Bracket Included 9 - 10 - 17.5</p>	<p>Automann AB1DK23M-9375 ContiTech 64264 Dayton 1R12-404 Euclid FS9375 Firestone W01-358-9375 Goodyear 1R12-404 1R12-488 1S12-031 Hendrickson S-50899-1/2 Mack 364QS27 57QL414M Road Leveler RL93750 Triangle 8451</p>
 <p>AS9387</p>	 <p>9 - 9 - 12</p>	<p>Automann AB1DK20D-9387 ContiTech 64367 Dayton 1R11-203 Euclid FS9387 Firestone W01-358-9387 Goodyear 1R11-159 1R11-203 Ridewell 1003589387C Road Leveler RL93870 Triangle 8479</p>
 <p>AS9394</p>	 <p>9 - 10 - 19</p>	<p>Automann AB1DK23L-9394 ContiTech 64281 Dayton 1R12-279 Euclid FS9394 Firestone W01-358-9394 Fruehauf UCE-9393-2 Goodyear 1R12-279 Hendrickson S-103522 Road Leveler RL93940 Triangle 8383</p>

-  Combination air inlet & stud; stud outside thread 3/4"-16, stud inside thread for air inlet 1/4" - 18 N.P.T.
-  Exceptions noted in drawings for part variance
-  Blind nut for bead plates 3/8-16 UNC; for pistons 1/2"-13 UNC
-  Bolt or stud 1/2"-13 UNC
-  Air inlet 1/4" - 18 N.P.T.





ROLLING LOBE AIR SPRINGS

PART NO.	DIMENSIONS	REPLACES	
		Automann ContiTech Dayton Euclid Firestone Goodyear Hendrickson Kenworth Navistar Road Leveler Triangle Volvo	AB1DK20D-9422 64255 1R11-028 FS9422 W01-358-9422 1R11-028 S-13032 K-303-6 K-303-14/K-303-15 554762C1 RL94220 8314 85101148
AS9422	9 - 9 - 12		
		Automann ContiTech Euclid Firestone Goodyear Hendrickson Mack Road Leveler Triangle	AB1DK23K-9466 64276 FS9466 W01-358-9466 1R12-197 1R12-365 S-49048 364QS28 RL94660 8410
AS9466	9 - 10 - 16		
		Automann ContiTech Euclid Firestone Kenworth	AB1DK20G-9547 66109 FS9547 W01-358-9547 C81-1004
AS9547	9 - 9 - 9		
		Automann ContiTech Dayton Euclid Firestone Goodyear Hendrickson Road Leveler Triangle	AB1DK25C-9580 64394 1R13-118 FS9580 W01-358-9262 W01-358-9580 1R13-081 1R13-118 S-20127 RL95800 8434
AS9580	10 - 10 - 21		

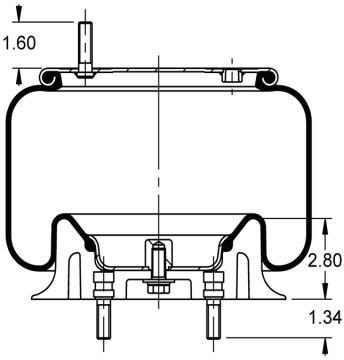
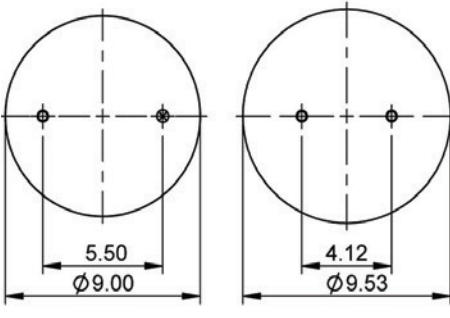
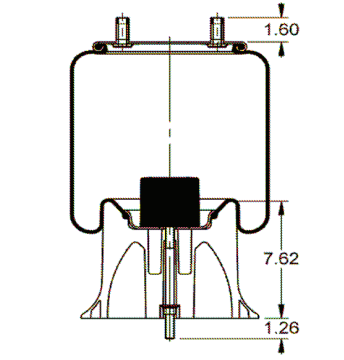
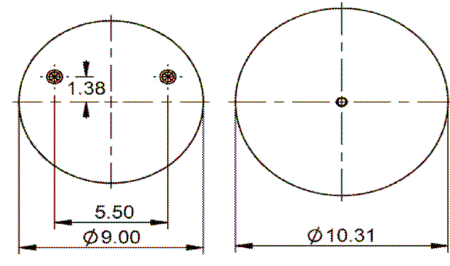
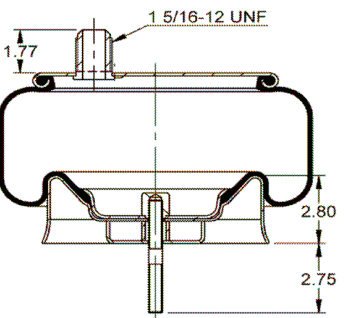
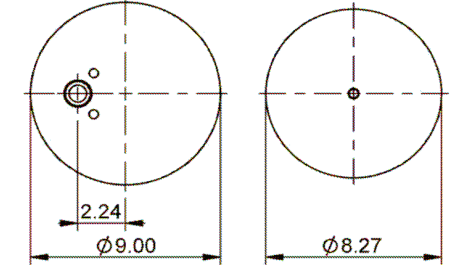
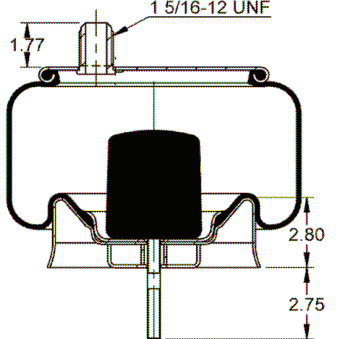
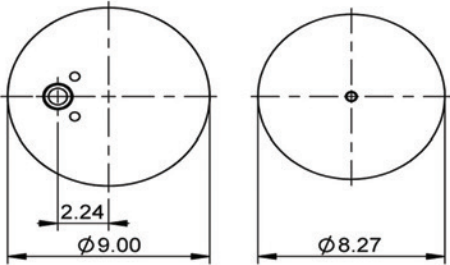
-  Combination air inlet & stud; stud outside thread 3/4"-16, stud inside thread for air inlet 1/4" - 18 N.P.T.
-  Exceptions noted in drawings for part variance
-  Blind nut for bead plates 3/8-16 UNC; for pistons 1/2"-13 UNC
-  Bolt or stud 1/2"-13 UNC
-  Air inlet 1/4" - 18 N.P.T.





ROLLING LOBE AIR SPRINGS

PART NO.	DIMENSIONS	REPLACES	
 <p>AS9616</p>	 <p>9 - 9 - 12</p>	Automann ContiTech Dayton Euclid Firestone Goodyear Kenworth Road Leveler Triangle	AB1DK20D-9616 64256 1R11-242 FS9616 W01-358-9616 1R11-242 K-303-16 RL96160 8515
 <p>AS9619</p>	 <p>9 - 9 - 22</p>	ContiTech Euclid Firestone Hendrickson Road Leveler Triangle	64697 FS9619 W01-358-9619 S-23614 RL96190 8567
 <p>AS9622</p>	 <p>9 - 9 - 9</p>	Automann ContiTech Euclid Firestone Kenworth Road Leveler Triangle	AB1DK20G-9622 65367 FS9622 W01-358-9622 K-303-22 RL96220 8537
 <p>AS9625</p>	 <p>9 - 9 - 10</p>	Automann ContiTech Dayton Euclid Firestone Goodyear Triangle	AB1DK20H-9625 65389 1R11-222 FS9625 W01-358-9625 1R11-222 8538

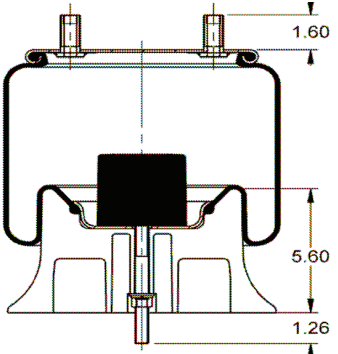
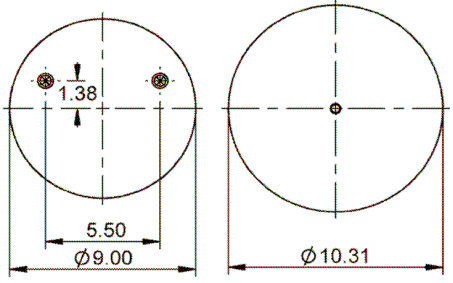
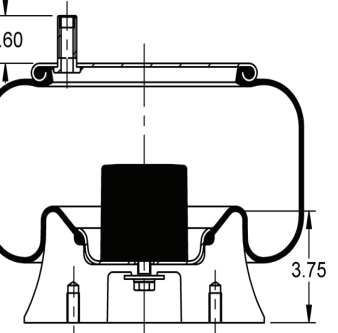
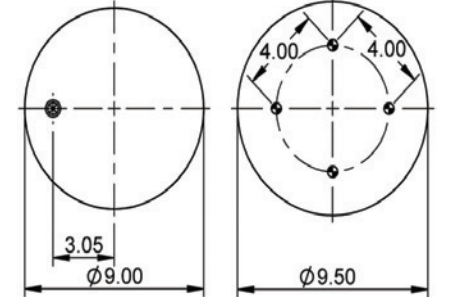
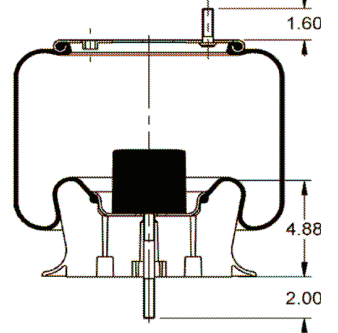
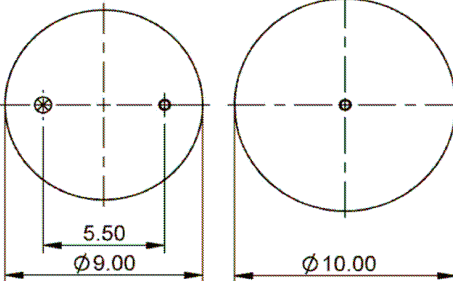
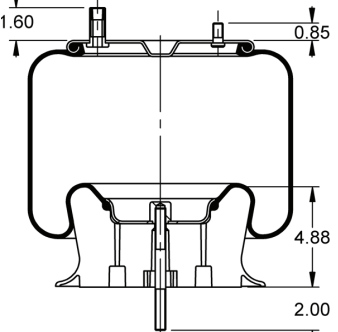
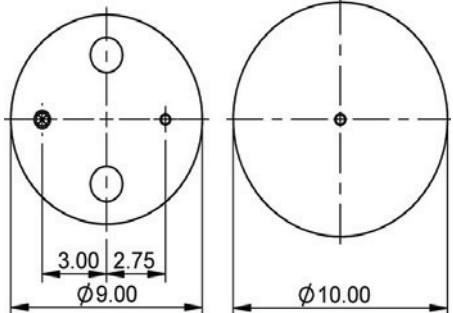
-  Combination air inlet & stud; stud outside thread 3/4"-16, stud inside thread for air inlet 1/4" - 18 N.P.T.
-  Exceptions noted in drawings for part variance
-  Blind nut for bead plates 3/8-16 UNC; for pistons 1/2"-13 UNC
-  Bolt or stud 1/2"-13 UNC
-  Air inlet 1/4" - 18 N.P.T.





ROLLING LOBE AIR SPRINGS

PART NO.	DIMENSIONS	REPLACES
 <p>AS9626</p>	 <p>9 - 9 - 16</p>	<p>Automann ContiTech Dayton Euclid Firestone Hendrickson Triangle</p> <p>AB1DK20J-9626 64692 S-23720 FS9626 W01-358-9626 S-23720/AA230L 8568</p>
 <p>AS9640</p>	 <p>9 - 10 - 12</p>	<p>Automann ContiTech Dayton Euclid Firestone</p> <p>AB1DK23H-9640 64395 1R12-367 FS9640 W01-358-9630 W01-358-9640</p> <p>Goodyear Hendrickson Road Leveler Triangle</p> <p>1R12-367 S-20223 RL96400 8427</p>
 <p>AS9647</p>	 <p>9 - 10 - 17.5</p>	<p>Automann ContiTech Dayton Euclid Firestone Hendrickson Triangle</p> <p>AB1DK23M-9647 64413 64917-002 FS9647 W01-358-9647 58786-2 8550</p>
 <p>AS9648</p>	 <p>9 - 10 - 17.5</p>	<p>Automann ContiTech Dayton Euclid Firestone Goodyear</p> <p>AB1DK23K-9648 64263 1R12-538 FS9648 W01-358-9648 1R12-398 1R12-538</p> <p>Navistar</p> <p>2027911C1 2027911C2 2027911C3</p> <p>Road Leveler Triangle</p> <p>RL96480 8456</p>

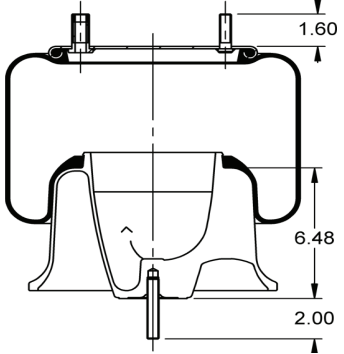
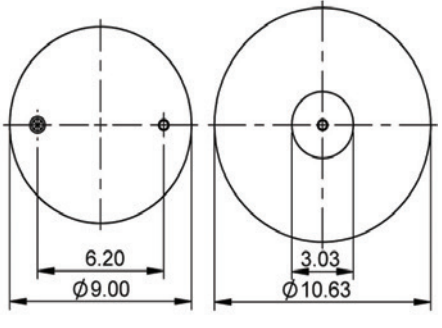
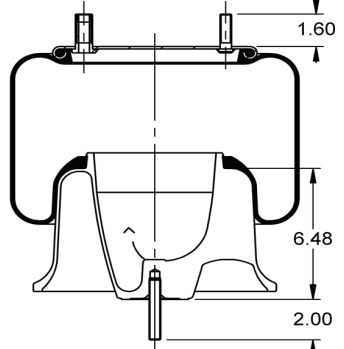
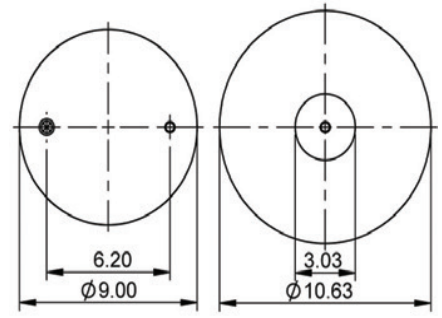
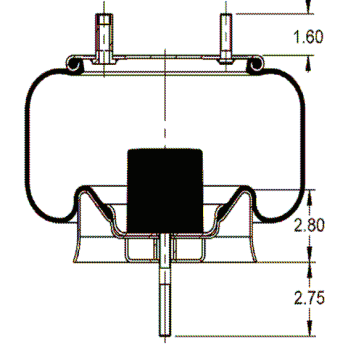
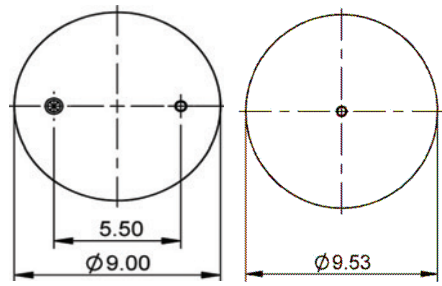
-  Combination air inlet & stud; stud outside thread 3/4"-16, stud inside thread for air inlet 1/4" - 18 N.P.T.
-  Exceptions noted in drawings for part variance
-  Blind nut for bead plates 3/8-16 UNC; for pistons 1/2"-13 UNC
-  Bolt or stud 1/2"-13 UNC
-  Air inlet 1/4" - 18 N.P.T.





ROLLING LOBE AIR SPRINGS

PART NO.	DIMENSIONS	REPLACES
 <p>AS9780</p>	 <p>(PI = Plastic) 9 - 10 - 16</p>	<p>Automann AB1DF23-9780 Dayton 1R12-303 (PI) Euclid FS9780 Firestone W01-358-9780 (PI) Freightliner 16-13810-000 16-15595-000 Goodyear 1R12-303 (PI) Road Leveler RL97800 Triangle 8382</p>
 <p>AS9781</p>	 <p>(Al = Aluminum) 9 - 10 - 16</p>	<p>Automann AB1DF23-9781 ContiTech 64266 Dayton 1R12-603 (Al) Euclid FS9781 Firestone W01-358-9781 (Al) Freightliner 16-13840-000 16-14004-000 Goodyear 1R12-603 (Al)</p>
 <p>AS9807</p>	 <p>9 - 9 - 10</p>	<p>Automann AB1DK231-9807 Firestone W01-358-9807 Holland-Neway 905-57-306</p>
<p>Picture Not Available</p> <p>AS9875</p>	<p>Picture Not Available</p> <p>9 - 10 - 20</p>	<p>Navistar 3541731C1</p>

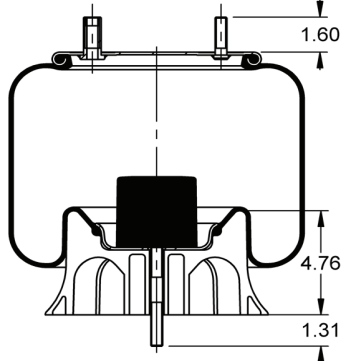
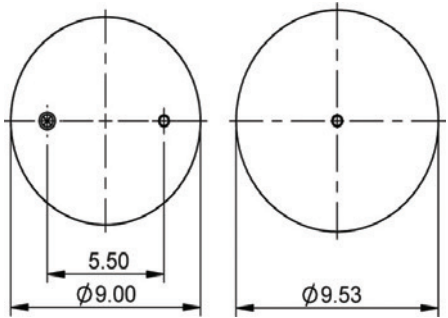
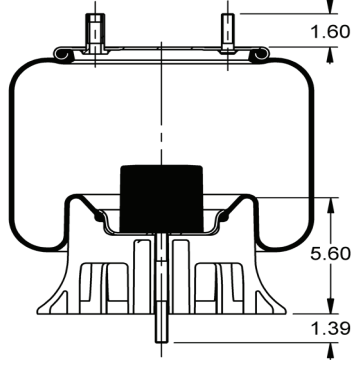
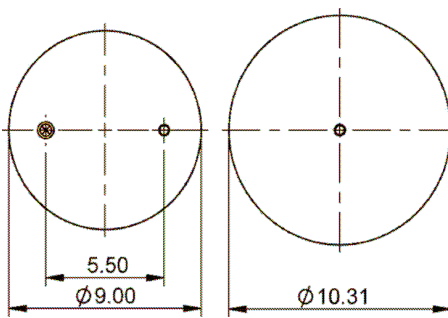
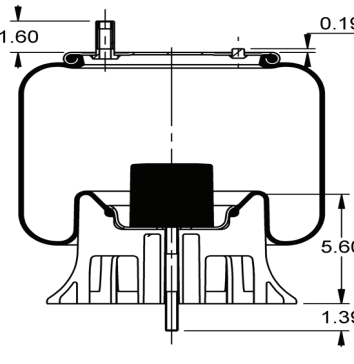
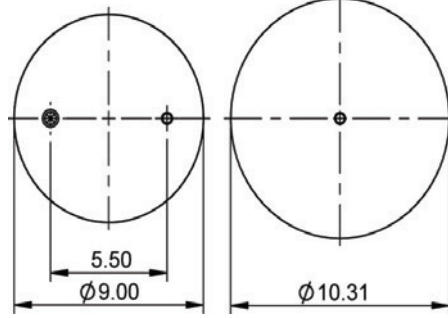
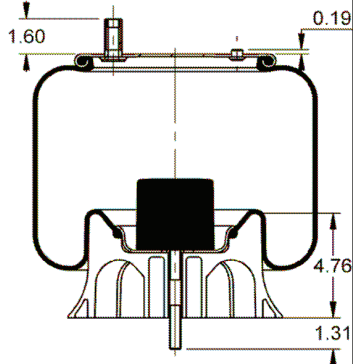
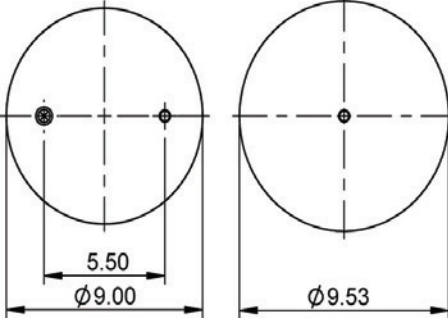
-  Combination air inlet & stud; stud outside thread 3/4"-16, stud inside thread for air inlet 1/4" - 18 N.P.T.
-  Exceptions noted in drawings for part variance
-  Blind nut for bead plates 3/8-16 UNC; for pistons 1/2"-13 UNC
-  Bolt or stud 1/2"-13 UNC
-  Air inlet 1/4" - 18 N.P.T.





ROLLING LOBE AIR SPRINGS

PART NO.	DIMENSIONS	REPLACES
 <p>AS9921</p>	 <p>9 - 10 - 17.5</p>	<p>Automann AB1DK23P-9921 ContiTech 64402 Dayton 1R12-502 Euclid FS9921 Firestone W01-358-9921 Goodyear 1R12-502 Holland-Neway 905-57-117 Road Leveler RL99210 Triangle 8443 Watson Chalin AS-0090</p>
 <p>AS9923</p>	 <p>9 - 10 - 17.5</p>	<p>Automann AB1DK23P-9923 ContiTech 64278 Dayton 1R12-481 Euclid FS9923 Firestone W01-358-9923 Goodyear 1R12-481 1R12-533 Holland-Neway 905-57-118 Triangle 8429</p>
 <p>AS9935</p>	 <p>9 - 10 - 17.5</p>	<p>Automann AB1DK23P-9935 ContiTech 64412 Dayton 1R12-532 Euclid FS9935 Firestone W01-358-9935 Goodyear 1R12-532 Holland-Neway 905-57-157 905-57-301 Road Leveler RL99350 Triangle 8548</p>
 <p>AS9936</p>	 <p>9 - 10 - 17.5</p>	<p>Automann AB1DK23P-9936 ContiTech 64405 Dayton 1R12-499 Euclid FS9936 Firestone W01-358-9936 Goodyear 1R12-499 Holland-Neway 905-57-156 905-57-300 Triangle 8454</p>

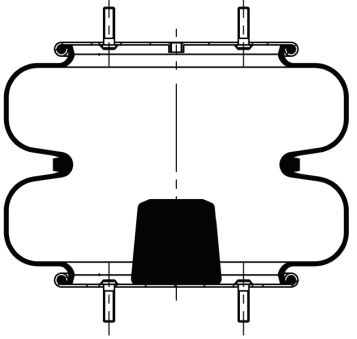
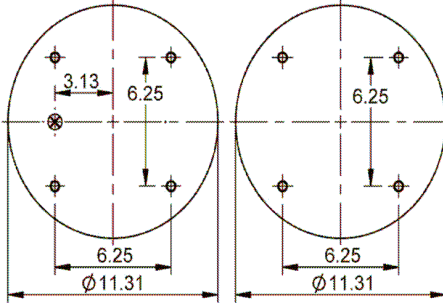
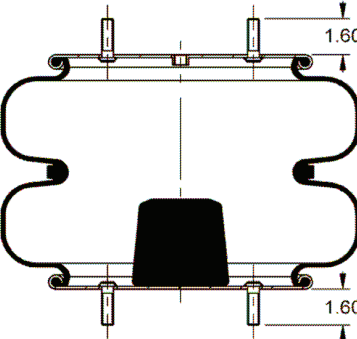
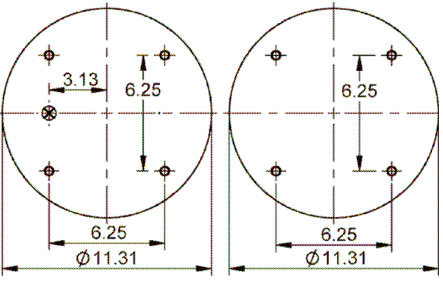
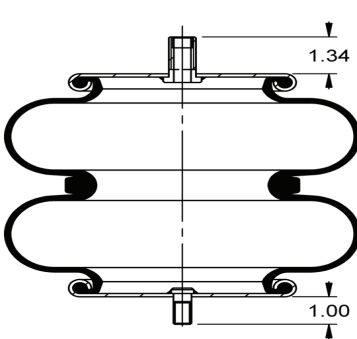
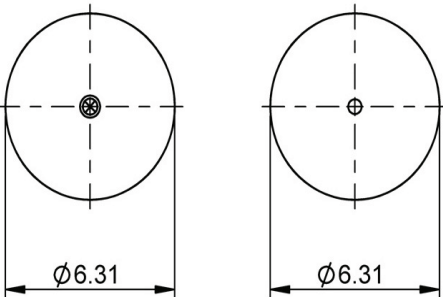
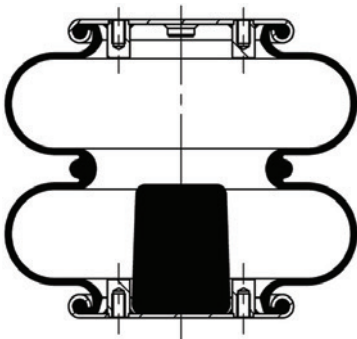
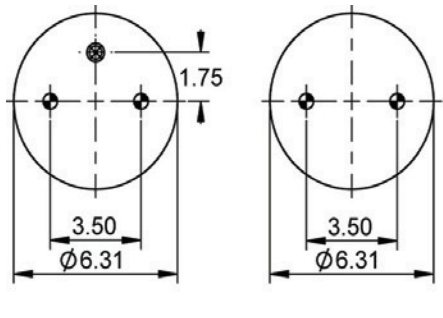
-  Combination air inlet & stud; stud outside thread 3/4"-16, stud inside thread for air inlet 1/4" - 18 N.P.T.
-  Exceptions noted in drawings for part variance
-  Blind nut for bead plates 3/8-16 UNC; for pistons 1/2"-13 UNC
-  Bolt or stud 1/2"-13 UNC
-  Air inlet 1/4" - 18 N.P.T.





DOUBLE CONVOLUTED AIR SPRINGS

PART NO.	DIMENSIONS	REPLACES																										
 <p data-bbox="203 569 310 596">AS6799</p>	 <p data-bbox="764 569 878 596">FD 530-35</p>	<table border="0"> <tr><td>ContiTech</td><td>64605</td></tr> <tr><td>Dayton</td><td>2B14-476</td></tr> <tr><td>Euclid</td><td>FS6799</td></tr> <tr><td>Firestone</td><td>W01-358-6799</td></tr> <tr><td>Goodyear</td><td>2B14-476</td></tr> <tr><td>Holland-Neway</td><td>905-57-203</td></tr> <tr><td>Triangle</td><td>4543</td></tr> </table>	ContiTech	64605	Dayton	2B14-476	Euclid	FS6799	Firestone	W01-358-6799	Goodyear	2B14-476	Holland-Neway	905-57-203	Triangle	4543												
ContiTech	64605																											
Dayton	2B14-476																											
Euclid	FS6799																											
Firestone	W01-358-6799																											
Goodyear	2B14-476																											
Holland-Neway	905-57-203																											
Triangle	4543																											
 <p data-bbox="203 972 310 999">AS6808</p>	 <p data-bbox="764 972 878 999">FD 530-30</p>	<table border="0"> <tr><td>ContiTech</td><td>64592</td></tr> <tr><td>Euclid</td><td>FS6808</td></tr> <tr><td>Firestone</td><td>W01-358-6808</td></tr> <tr><td>Triangle</td><td>4519</td></tr> <tr><td>Watson Chalin</td><td>AS-0034</td></tr> </table>	ContiTech	64592	Euclid	FS6808	Firestone	W01-358-6808	Triangle	4519	Watson Chalin	AS-0034																
ContiTech	64592																											
Euclid	FS6808																											
Firestone	W01-358-6808																											
Triangle	4519																											
Watson Chalin	AS-0034																											
 <p data-bbox="203 1375 310 1402">AS6897</p>	 <p data-bbox="764 1375 878 1402">FD 200-19</p>	<table border="0"> <tr><td>Automann</td><td>ABSP2B12R-6897</td></tr> <tr><td>ContiTech</td><td>64517</td></tr> <tr><td>Dayton</td><td>2B9-229</td></tr> <tr><td>Euclid</td><td>FS6897</td></tr> <tr><td>Firestone</td><td>W01-358-6897</td></tr> <tr><td>Goodyear</td><td>2B9-229</td></tr> <tr><td>Road Leveler</td><td>RL68970</td></tr> <tr><td>Triangle</td><td>4505</td></tr> <tr><td>Watson Chalin</td><td>AS-0058</td></tr> </table>	Automann	ABSP2B12R-6897	ContiTech	64517	Dayton	2B9-229	Euclid	FS6897	Firestone	W01-358-6897	Goodyear	2B9-229	Road Leveler	RL68970	Triangle	4505	Watson Chalin	AS-0058								
Automann	ABSP2B12R-6897																											
ContiTech	64517																											
Dayton	2B9-229																											
Euclid	FS6897																											
Firestone	W01-358-6897																											
Goodyear	2B9-229																											
Road Leveler	RL68970																											
Triangle	4505																											
Watson Chalin	AS-0058																											
 <p data-bbox="203 1778 310 1806">AS6902</p>	 <p data-bbox="764 1778 878 1806">FD 200-19</p>	<table border="0"> <tr><td>Automann</td><td>ABSP2B12R-6902</td></tr> <tr><td>ContiTech</td><td>64509</td></tr> <tr><td>Dayton</td><td>2B9-239</td></tr> <tr><td>Euclid</td><td>FS6902</td></tr> <tr><td>Firestone</td><td>W01-358-6902</td></tr> <tr><td>Goodyear</td><td>2B9-239</td></tr> <tr><td>Hendrickson</td><td>S-2630</td></tr> <tr><td>Holland-Neway</td><td>570-06-902</td></tr> <tr><td>Navistar</td><td>554784C1</td></tr> <tr><td>Ridewell</td><td>1003586902C</td></tr> <tr><td>Road Leveler</td><td>RL69020</td></tr> <tr><td>Triangle</td><td>4310</td></tr> <tr><td>Watson Chalin</td><td>AS-0002</td></tr> </table>	Automann	ABSP2B12R-6902	ContiTech	64509	Dayton	2B9-239	Euclid	FS6902	Firestone	W01-358-6902	Goodyear	2B9-239	Hendrickson	S-2630	Holland-Neway	570-06-902	Navistar	554784C1	Ridewell	1003586902C	Road Leveler	RL69020	Triangle	4310	Watson Chalin	AS-0002
Automann	ABSP2B12R-6902																											
ContiTech	64509																											
Dayton	2B9-239																											
Euclid	FS6902																											
Firestone	W01-358-6902																											
Goodyear	2B9-239																											
Hendrickson	S-2630																											
Holland-Neway	570-06-902																											
Navistar	554784C1																											
Ridewell	1003586902C																											
Road Leveler	RL69020																											
Triangle	4310																											
Watson Chalin	AS-0002																											

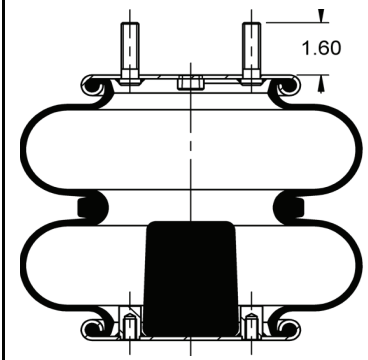
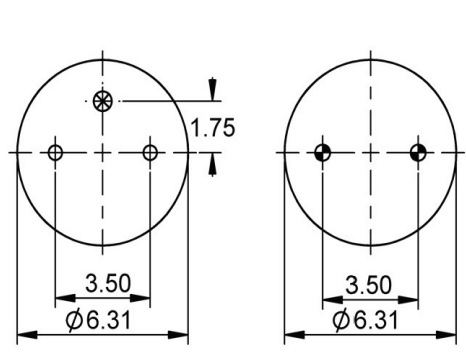
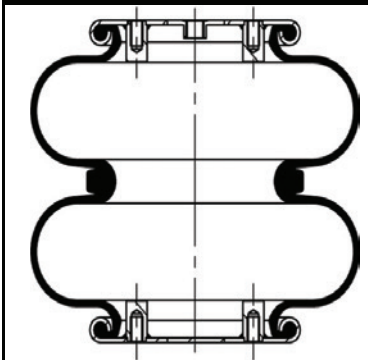
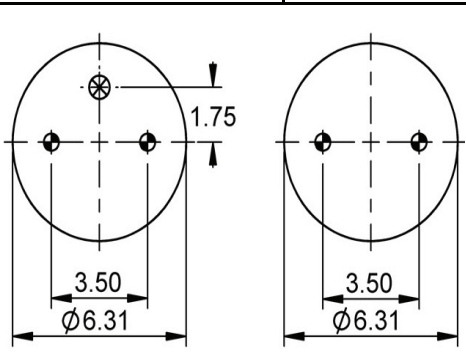
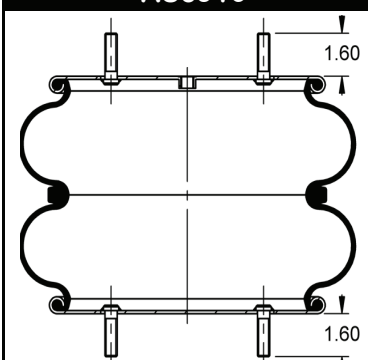
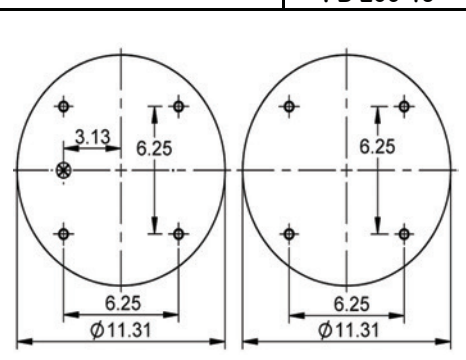
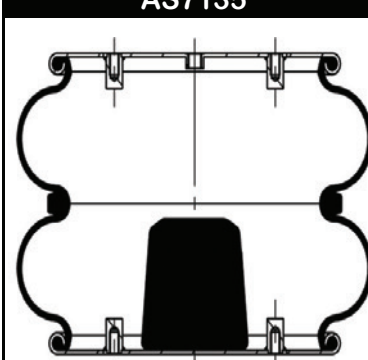
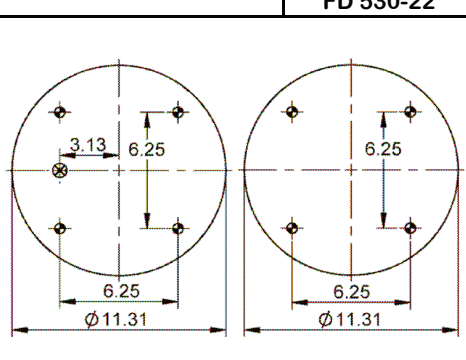
-  Combination air inlet & stud; stud outside thread 3/4"-16, stud inside thread for air inlet 1/4" - 18 N.P.T.
-  Exceptions noted in drawings for part variance
-  Blind nut for bead plates 3/8-16 UNC; for pistons 1/2"-13 UNC
-  Bolt or stud 1/2"-13 UNC
-  Air inlet 1/4" - 18 N.P.T.





DOUBLE CONVOLUTED AIR SPRINGS

PART NO.	DIMENSIONS	REPLACES	
 <p style="text-align: center;">AS6905</p>	 <p style="text-align: center;">FD 200-19</p>	Automann ContiTech Dayton Euclid Firestone Goodyear Hendrickson Navistar Ridewell Road Leveler Triangle Volvo	ABSP2B12R-6905 64510 2B9-206 FS6905 W01-358-6905 2B9-206 S-3518/S-5270 1685175C1 1003586905C RL69050 4315 85101146
 <p style="text-align: center;">AS6910</p>	 <p style="text-align: center;">FD 200-19</p>	Automann ContiTech Dayton Euclid Firestone Goodyear Hendrickson	ABSP2B12R-6910 64267 2B9-200 FS6910 W01-358-6910 2B9-200 S-8768 S-45843-3 570-06-910 554783C1 RL69100 4320 AS-0020
 <p style="text-align: center;">AS7135</p>	 <p style="text-align: center;">FD 530-22</p>	Automann ContiTech Dayton Euclid Firestone Goodyear Hendrickson Holland-Neway Navistar Ridewell Road Leveler Triangle	ABSP2B34R-7135 64543 2B14-360 FS7135 W01-358-7135 2B14-360 S-12514-014 905-57-001 554800C1 1003587135C RL71350 4311
 <p style="text-align: center;">AS7136</p>	 <p style="text-align: center;">FD 530-22</p>	Automann ContiTech Dayton Euclid Firestone Goodyear Hendrickson Holland-Neway Ridewell Triangle Watson Chalin	ABSP2B34R-7136 64545 2B14-356 FS7136 W01-358-7136 2B14-356 S-1080 570-07-136 1003587136C 4321 AS-0004

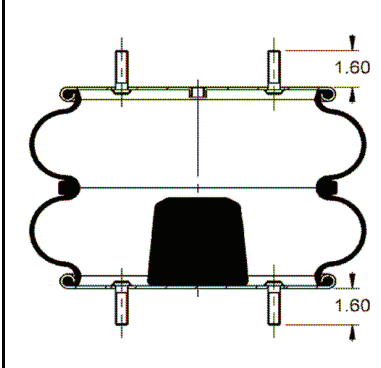
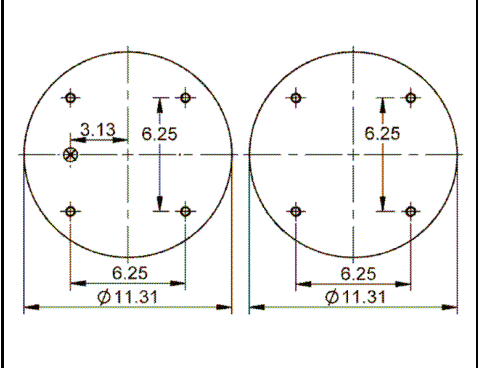
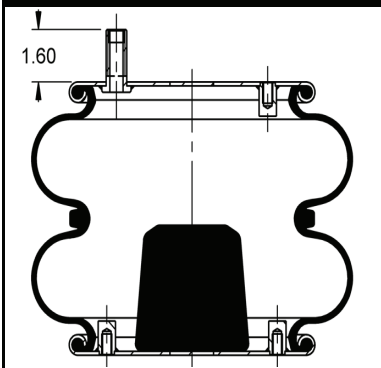
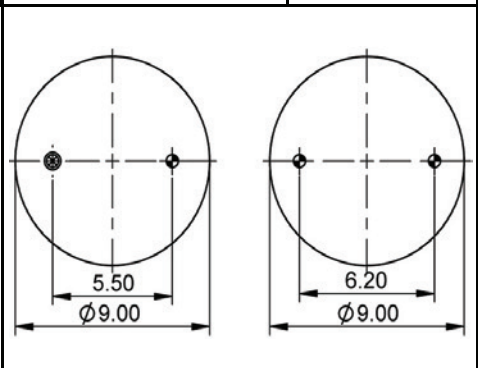
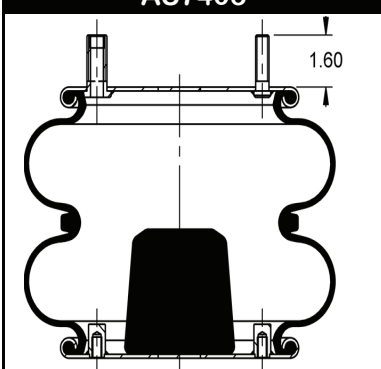
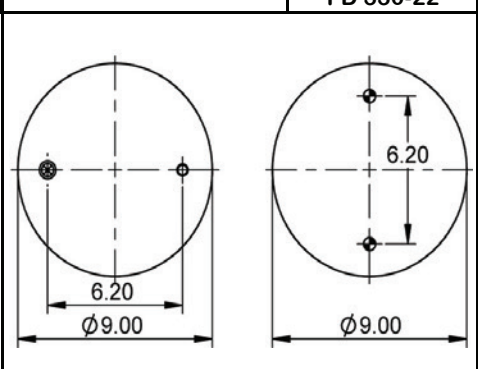
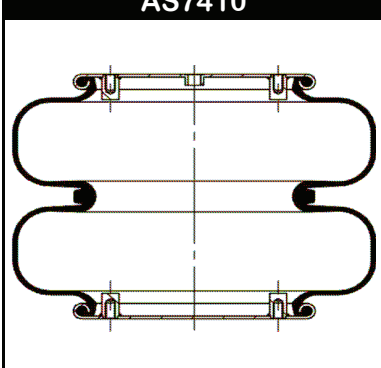
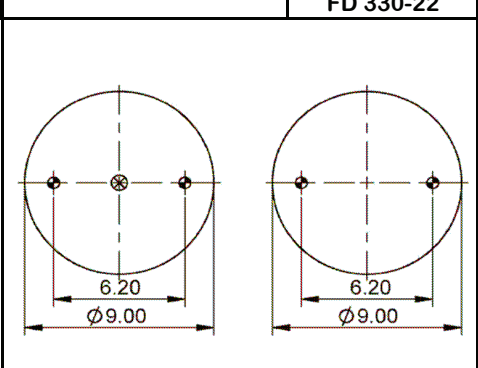
-  Combination air inlet & stud; stud outside thread 3/4"-16, stud inside thread for air inlet 1/4" - 18 N.P.T.
-  Exceptions noted in drawings for part variance
-  Blind nut for bead plates 3/8-16 UNC; for pistons 1/2"-13 UNC
-  Bolt or stud 1/2"-13 UNC
-  Air inlet 1/4" - 18 N.P.T.

DOUBLE CONVOLUTED AIR SPRINGS

PART NO.	DIMENSIONS	REPLACES
 <p data-bbox="203 569 310 596">AS7140</p>	 <p data-bbox="764 569 878 596">FD 530-22</p>	<p data-bbox="959 226 1406 533"> Automann ABSP2B34R-7140 ContiTech 64544 Euclid FS7140 Firestone W01-358-7140 Goodyear 2B14-359 Hendrickson S-3184 Holland-Neway 570-07-140 Road Leveler 905-57-257 Triangle RL71400 Triangle 4316 </p>
 <p data-bbox="203 974 310 1001">AS7403</p>	 <p data-bbox="764 974 878 1001">FD 330-22</p>	<p data-bbox="959 604 1406 1001"> Automann ABSP2B22R-7403 ContiTech 64488 Dayton 2B12-307 Euclid FS7403 Firestone W01-358-7403 Goodyear 2B12-307 Hendrickson S-1159/S-2883 S-12514-001 Navistar 554787C1 Ridewell 1003587403C S-4302C Road Leveler RL74030 Triangle 4318 </p>
 <p data-bbox="203 1379 310 1407">AS7410</p>	 <p data-bbox="764 1379 878 1407">FD 330-22</p>	<p data-bbox="959 1010 1406 1407"> Automann ABSP2B22R-7410 ContiTech 64268 Dayton 2B12-406 Euclid FS7410 Firestone W01-358-7410 Freightliner 16-11378-000 Goodyear 2B12-406 Hendrickson S-10170 Holland-Neway 570-07-410 Navistar 554792C1 Road Leveler RL74100 Triangle 4331 Volvo 85101158 </p>
 <p data-bbox="203 1787 310 1814">AS7443</p>	 <p data-bbox="764 1787 878 1814">FD 330-30</p>	<p data-bbox="959 1570 1308 1598">Hendrickson S-001503</p>

-  Combination air inlet & stud; stud outside thread 3/4"-16, stud inside thread for air inlet 1/4" - 18 N.P.T.
-  Exceptions noted in drawings for part variance
-  Blind nut for bead plates 3/8-16 UNC; for pistons 1/2"-13 UNC
-  Bolt or stud 1/2"-13 UNC
-  Air inlet 1/4" - 18 N.P.T.

DOUBLE CONVOLUTED AIR SPRINGS

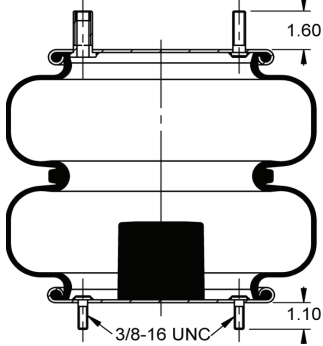
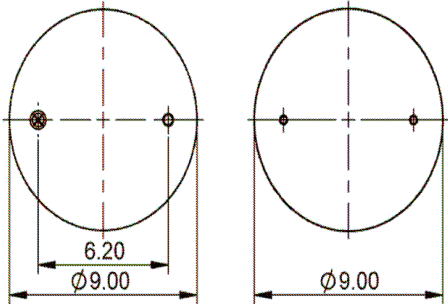
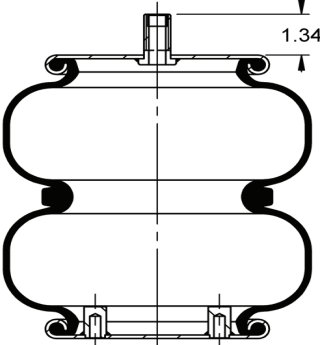
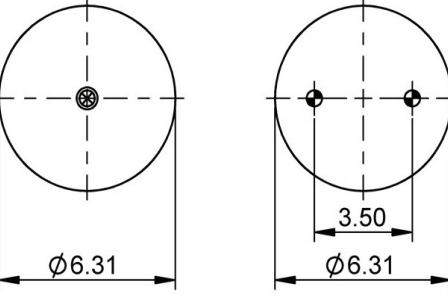
PART NO.	DIMENSIONS	REPLACES																						
 <p>AS755</p>	 <p>FD 331-26</p>	<table border="0"> <tr><td>Automann</td><td>ABSP2B22R-7550/7555</td></tr> <tr><td>Binkley</td><td>XB-SPN-053-37</td></tr> <tr><td>ContiTech</td><td>64284</td></tr> <tr><td>Dayton</td><td>2B12-440</td></tr> <tr><td>Euclid</td><td>FS7555</td></tr> <tr><td>Firestone</td><td>W01-358-7550/7555</td></tr> <tr><td>Goodyear</td><td>2B12-440</td></tr> <tr><td>Reyco</td><td>18813-01</td></tr> <tr><td>Road Leveler</td><td>20018-01</td></tr> <tr><td>Triangle</td><td>RL75550</td></tr> <tr><td></td><td>4480</td></tr> </table>	Automann	ABSP2B22R-7550/7555	Binkley	XB-SPN-053-37	ContiTech	64284	Dayton	2B12-440	Euclid	FS7555	Firestone	W01-358-7550/7555	Goodyear	2B12-440	Reyco	18813-01	Road Leveler	20018-01	Triangle	RL75550		4480
Automann	ABSP2B22R-7550/7555																							
Binkley	XB-SPN-053-37																							
ContiTech	64284																							
Dayton	2B12-440																							
Euclid	FS7555																							
Firestone	W01-358-7550/7555																							
Goodyear	2B12-440																							
Reyco	18813-01																							
Road Leveler	20018-01																							
Triangle	RL75550																							
	4480																							
 <p>AS7795</p>	 <p>FD 200-22</p>	<table border="0"> <tr><td>Automann</td><td>ABSP2B12R-7795</td></tr> <tr><td>ContiTech</td><td>64602</td></tr> <tr><td>Dayton</td><td>2B10-226</td></tr> <tr><td>Euclid</td><td>FS7795</td></tr> <tr><td>Firestone</td><td>W01-358-7795</td></tr> <tr><td>Goodyear</td><td>2B10-226</td></tr> <tr><td>Hendrickson</td><td>S-2878</td></tr> <tr><td></td><td>S-4486</td></tr> <tr><td></td><td>S-23114</td></tr> <tr><td>Road Leveler</td><td>RL77950</td></tr> <tr><td>Triangle</td><td>4524</td></tr> </table>	Automann	ABSP2B12R-7795	ContiTech	64602	Dayton	2B10-226	Euclid	FS7795	Firestone	W01-358-7795	Goodyear	2B10-226	Hendrickson	S-2878		S-4486		S-23114	Road Leveler	RL77950	Triangle	4524
Automann	ABSP2B12R-7795																							
ContiTech	64602																							
Dayton	2B10-226																							
Euclid	FS7795																							
Firestone	W01-358-7795																							
Goodyear	2B10-226																							
Hendrickson	S-2878																							
	S-4486																							
	S-23114																							
Road Leveler	RL77950																							
Triangle	4524																							



Combination air inlet & stud; stud outside thread 3/4"-16, stud inside thread for air inlet 1/4" - 18 N.P.T.



Exceptions noted in drawings for part variance



Blind nut for bead plates 3/8-16 UNC; for pistons 1/2"-13 UNC









Bolt or stud 1/2"-13 UNC

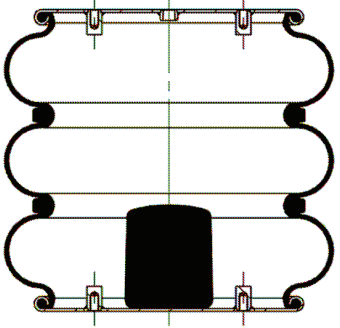
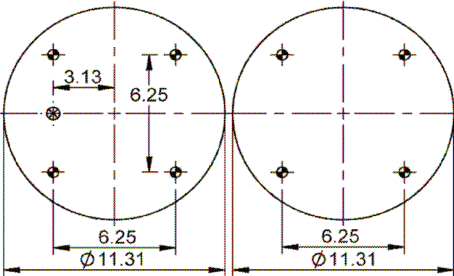
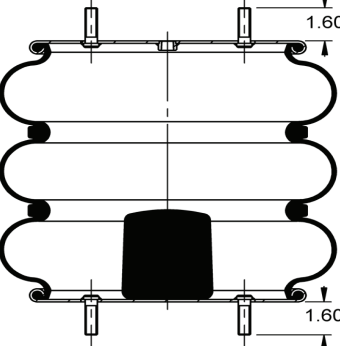
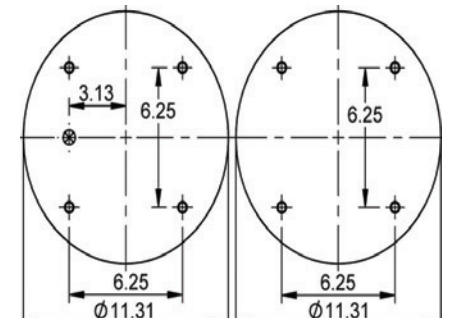
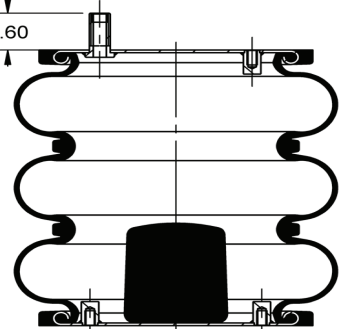
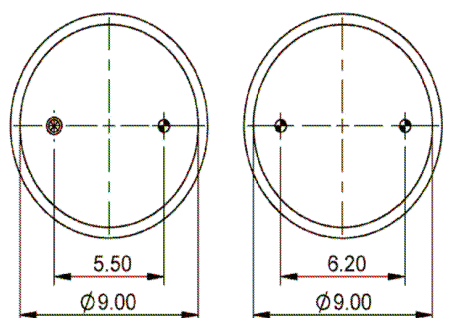
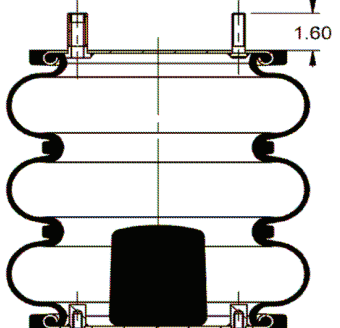
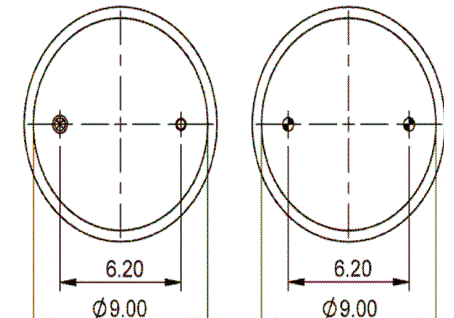

Air inlet 1/4" - 18 N.P.T.

TRIPLE CONVOLUTED AIR SPRINGS

PART NO.	DIMENSIONS	REPLACES	
 <p data-bbox="203 569 311 596">AS7798</p>	 <p data-bbox="764 569 878 596">FT 530-32</p>	<p data-bbox="959 289 1406 499"> Automann ABSP3B32R-7798 ContiTech 64504 Dayton 3B14-356 Euclid FS7798 Firestone W01-358-7798 Goodyear 3B14-356 Triangle 4329 </p>	
 <p data-bbox="203 974 311 1001">AS7818</p>	 <p data-bbox="764 974 878 1001">FT 530-32</p>	<p data-bbox="959 632 1406 968"> Automann ABSP3B32R-7818 ContiTech 64503 Dayton 3B14-359 Euclid FS7818 Firestone W01-358-7818 Goodyear 3B14-359 Hendrickson S-13041 Holland-Neway 570-07-818 Silent Drive AS-7818 Triangle 4325 Watson Chalin AS-0025 </p>	
 <p data-bbox="203 1379 311 1407">AS8008</p>	 <p data-bbox="764 1379 878 1407">FT 330-29</p>	<p data-bbox="959 1068 1406 1341"> Automann ABSP3B22R-8008 ContiTech 64562 Euclid FS8008 EZ Ride 8030155 Firestone W01-358-8008 Hendrickson S-11637 Holland-Neway 570-08-008 Ridewell 1003588008C Triangle 4431 </p>	
 <p data-bbox="203 1785 311 1812">AS8018</p>	 <p data-bbox="764 1785 878 1812">FT 330-29</p>	<p data-bbox="959 1442 1406 1747"> Automann ABSP3B22R-8018 ContiTech 64285 Dayton 3B12-303 Euclid FS8018 Firestone W01-358-8018 Goodyear 3B12-303 Loadguard SC2131 Reyco 93AR Triangle 4434 Watson Chalin AS-0075 </p>	

-  Combination air inlet & stud; stud outside thread 3/4"-16, stud inside thread for air inlet 1/4" - 18 N.P.T.
-  Exceptions noted in drawings for part variance
-  Blind nut for bead plates 3/8-16 UNC; for pistons 1/2"-13 UNC
-  Bolt or stud 1/2"-13 UNC
-  Air inlet 1/4" - 18 N.P.T.

TRIPLE CONVOLUTED AIR SPRINGS

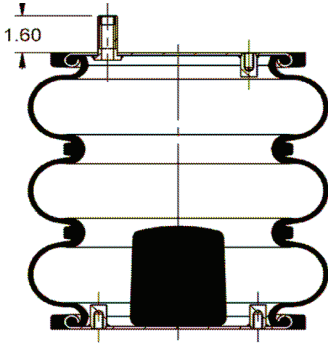
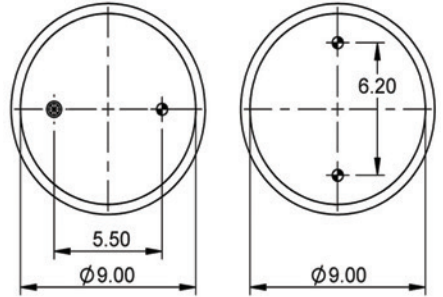
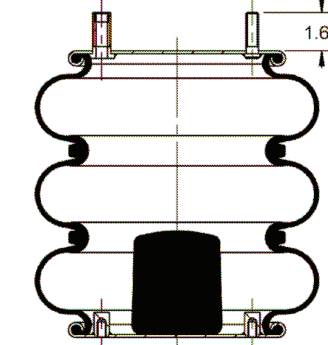
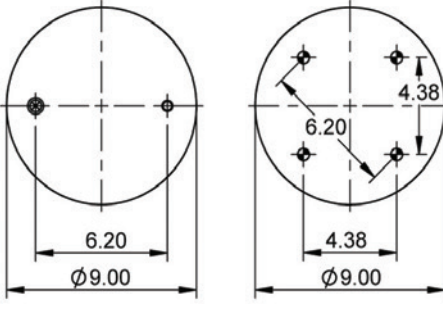
PART NO.	DIMENSIONS	REPLACES																		
		<table border="0"> <tr> <td>Automann</td> <td>ABSP3B22R-8032</td> </tr> <tr> <td>ContiTech</td> <td>64560</td> </tr> <tr> <td>Dayton</td> <td>3B12-319</td> </tr> <tr> <td>Euclid</td> <td>FS8032</td> </tr> <tr> <td>Firestone</td> <td>W01-358-8032</td> </tr> <tr> <td>Goodyear</td> <td>3B12-319</td> </tr> <tr> <td>Hendrickson</td> <td>S-12405</td> </tr> <tr> <td>Spring Valley</td> <td>AS-4413</td> </tr> <tr> <td>Triangle</td> <td>4413</td> </tr> </table>	Automann	ABSP3B22R-8032	ContiTech	64560	Dayton	3B12-319	Euclid	FS8032	Firestone	W01-358-8032	Goodyear	3B12-319	Hendrickson	S-12405	Spring Valley	AS-4413	Triangle	4413
Automann	ABSP3B22R-8032																			
ContiTech	64560																			
Dayton	3B12-319																			
Euclid	FS8032																			
Firestone	W01-358-8032																			
Goodyear	3B12-319																			
Hendrickson	S-12405																			
Spring Valley	AS-4413																			
Triangle	4413																			
AS8032	FT 330-29																			
		<table border="0"> <tr> <td>Automann</td> <td>ABSP3B22R-8033</td> </tr> <tr> <td>ContiTech</td> <td>64571</td> </tr> <tr> <td>Dayton</td> <td>3B12-312</td> </tr> <tr> <td>Euclid</td> <td>FS8033</td> </tr> <tr> <td>Firestone</td> <td>W01-358-8033</td> </tr> <tr> <td>Goodyear</td> <td>3B12-312</td> </tr> <tr> <td>Triangle</td> <td>4525</td> </tr> </table>	Automann	ABSP3B22R-8033	ContiTech	64571	Dayton	3B12-312	Euclid	FS8033	Firestone	W01-358-8033	Goodyear	3B12-312	Triangle	4525				
Automann	ABSP3B22R-8033																			
ContiTech	64571																			
Dayton	3B12-312																			
Euclid	FS8033																			
Firestone	W01-358-8033																			
Goodyear	3B12-312																			
Triangle	4525																			
AS8033	FT 330-29																			



Combination air inlet & stud; stud outside thread 3/4"-16, stud inside thread for air inlet 1/4" - 18 N.P.T.



Exceptions noted in drawings for part variance



Bolt or stud 1/2"-13 UNC



Blind nut for bead plates 3/8"-16 UNC; for pistons 1/2"-13 UNC



Air inlet 1/4" - 18 N.P.T.

CABIN AIR SPRINGS



PART NO.	APPLICATION	REPLACES	
AS7001	Link	ContiTech Firestone	SC29-O001 W02-358-7001
AS7012	Link	Firestone Goodyear	W02-358-7012 1S4-008
AS7031	Link, Mack	Firestone Goodyear	W02-358-7031 1S4-007
AS7036	Peterbilt	ContiTech Firestone	SC29-Y036 W02-358-7036
AS7046	Link	ContiTech Firestone	SC29-O046 W02-358-7046
AS7074	Freightliner, Link	Firestone	W02-358-7074
AS7081	Navistar, Link	Firestone Goodyear	W02-358-7081 1S5-038
AS7087	Freightliner (1988 Or Newer)	ContiTech Firestone Goodyear	SC29-W087 W02-358-7087 1S5-040
AS7108	Link, Milsco	ContiTech Firestone Goodyear	SC29-Y108 W02-358-7108 1S5-057
AS7110	Link, Kenworth	Firestone	W02-358-7110
AS7205	Freightliner	ContiTech Firestone	SC31-Y205 W02-358-7205
AS7206	Freightliner	ContiTech Firestone	SC31-W206 W02-358-7206
AS7215	Freightliner	ContiTech Firestone	SC31-Y215 W02-358-7215

AIR SPRINGS SIZE CHART

Part Number	Bead Plate Dia. (A)	Bellows Dia. (B)	Bellows Height (C)	Page	Part Number	Bead Plate Dia. (A)	Bellows Dia. (B)	Bellows Height (C)	Page
AS9547	9	9	9	261	AS8050	11	10.5	16	251
AS9622	9	9	9	262	AS8091	11	10.5	16	251
AS9625	9	9	10	262	AS9121	11	10.5	17	255
AS9807	9	9	10	264	AS8792	11	10.5	21	253
AS9387	9	9	12	260	AS9122	11	10.5	21	256
AS9422	9	9	12	261					
AS9616	9	9	12	262					
AS9293	9	9	15	258	AS6897	FD	200-19	6.3"	266
AS9295	9	9	15	258	AS6902	FD	200-19	6.3"	266
AS9626	9	9	16	263	AS6905	FD	200-19	6.3"	267
AS9619	9	9	22	262	AS6910	FD	200-19	6.3"	267
AS9039	9	10	10	254	AS7795	FD	200-22	6.3"	269
AS9307	9	10	10	258	AS7403	FD	330-22	9"	268
AS8204	9	10	12	251	AS7410	FD	330-22	9"	268
AS9366	9	10	12	259	AS7443	FD	330-30	9"	268
AS9640	9	10	12	263	AS7555	FD	331-26	9"	269
AS9270	9	10	13.5	257	AS7135	FD	530-22	11"	267
AS8813	9	10	14	253	AS7136	FD	530-22	11"	267
AS9010	9	10	14	254	AS7140	FD	530-22	11"	268
AS9069	9	10	14	255	AS6808	FD	530-30	11"	266
AS8829	9	10	16	253	AS6799	FD	530-35	11"	266
AS9026	9	10	16	254	AS8008	FT	330-29	9"	270
AS9082	9	10	16	255	AS8018	FT	330-29	9"	270
AS9213	9	10	16	256	AS8032	FT	330-29	9"	271
AS9219	9	10	16	256	AS8033	FT	330-29	9"	271
AS9466	9	10	16	261	AS7798	FT	530-32	11"	270
AS9780	9	10	16	264	AS7818	FT	530-32	11"	270
AS9781	9	10	16	264					
AS8944	9	10	17.5	254					
AS9287	9	10	17.5	257					
AS9371	9	10	17.5	259					
AS9373	9	10	17.5	260					
AS9375	9	10	17.5	260					
AS9647	9	10	17.5	263					
AS9648	9	10	17.5	263					
AS9921	9	10	17.5	265					
AS9923	9	10	17.5	265					
AS9935	9	10	17.5	265					
AS9936	9	10	17.5	265					
AS8852	9	10	19	253					
AS9101	9	10	19	255					
AS9192	9	10	19	256					
AS9243	9	10	19	257					
AS9265	9	10	19	257					
AS9394	9	10	19	260					
AS9875	9	10	20	264					
AS9321	9	10	21	258					
AS9367	9	10	21	259					
AS9370	9	10	21	259					
AS8729	10	10	13	252					
AS8755	10	10	15	252					
AS8708	10	10	16	251					
AS8713	10	10	16	252					
AS8749	10	10	21	N/C					
AS9580	10	10	21	261					
AS8709	10	10.5	15	252					

Part Number	Convolved Design	Bellows Dia.	Bead Plate Dia. (BP)	Page
-------------	------------------	--------------	----------------------	------

AS6897	FD	200-19	6.3"	266
AS6902	FD	200-19	6.3"	266
AS6905	FD	200-19	6.3"	267
AS6910	FD	200-19	6.3"	267
AS7795	FD	200-22	6.3"	269
AS7403	FD	330-22	9"	268
AS7410	FD	330-22	9"	268
AS7443	FD	330-30	9"	268
AS7555	FD	331-26	9"	269
AS7135	FD	530-22	11"	267
AS7136	FD	530-22	11"	267
AS7140	FD	530-22	11"	268
AS6808	FD	530-30	11"	266
AS6799	FD	530-35	11"	266
AS8008	FT	330-29	9"	270
AS8018	FT	330-29	9"	270
AS8032	FT	330-29	9"	271
AS8033	FT	330-29	9"	271
AS7798	FT	530-32	11"	270
AS7818	FT	530-32	11"	270

Part # AS8050

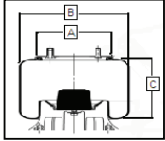

Rolling Lobe

- 1) Diameter of the bead plate = A
- 2) Diameter of the molded rubber bellows = B
- 3) Height of the molded bellows = C

Refer to the size chart opposite
AS8050 Dimensions are A = 11" B = 10.5" C = 16"

Part # AS6910

Convolved --->

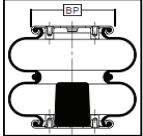

- 1) The first part (FD) is the number of bellows
 FS = Single Convolved
 FD = Double Convolved
 FT = Triple Convolved
- 2) The second part (200) is the diameter of the bead plate
 200 = 6.3"
 330 = 9"
 530 = 11"

AS6910 is a Double Convolved spring (FD)
with a 6.3" Bead Plate (200)

INTERCHANGES

ALCOA	SIRCO	ATRO	SIRCO	AUTOMANN	SIRCO
4306.32	333SN6	EQ53-35158	SH1048U	100.1308.10	RF-3
4307.32	333SN19	EQ53-35250	SH1021U	100.1308.12	RF-3A
				100.1308.20	RF-1ARK
				100.1308.21	ARK
				100.1308.22	RF-2ARK
				100.1308.30	EF-1
				100.4311.10	EK-1HD
				100.4311.12	EK-3
				100.4471.10	RK-1
				100.4515.10	TK-4HD
				100.4515.14	TK-1
				100.4515.16	TK-7HD
				100.4515.21	QK-1MP
				100.4515.22	QK-1HD
				100.4515.23	QK-1
				100.4515.25	QK-8
				100.4515.26	QK-8HD
				100.4515.31	XK-3
				100.4515.32	XK-3HD
				100.4515.34	XK-1HD
				100.4515.40	QK-2S
				100.4515.41	QK-2SHD
				100.4524.10	MF-1
				100.4524.11	MF-2
				100.4527.10	EK-2
				100.4591.20	LB-3D
				100.4591.30	LB-1
				100.4692.13	LB-2
				100.4692.14	LB-9
				100.4692.15	LB-10
				100.4692.16	LB-11
				100.4701.10	XL-1
				100.4702.10	RF-5
				100.4708.11	EQ-1
				100.4709.10	ES-1
				100.4709.11	ES-2
				100.4717.10	ES-4
				100.4719.10	EF-2
				100.4729.10	ES-5
				101.0251	B052
				101.0251.99	B152
				101.0251K	B942
				101.0252	B055
				101.1001	B500
				101.1001.99	B499
				101.1081	B053
				101.1081.99	B154
				101.1121	B725
				101.1122.99	B132
				101.1122K	B133
				101.1141.99	B134

INTERCHANGES

AUTOMANN	SIRCO	AUTOMANN	SIRCO	AUTOMANN	SIRCO
101.1141K	B135	105.2002	B358	110.2301	B8656
101.2051K	B430K	105.2003	B973	110.2302	B8652
101.2061	B923	105.2004	B423	110.2303	B8792
101.2072	B941	105.3003	B955	110.2304	B8685Z
101.2072K	B911	105.4001	B951	110.2305	B8655Z
101.2073	B611	106.1201	B901	110.2306	B8682
101.2074	B586	106.1241	B011	110.2307	B8655
102.2071	B120	106.1242	B501	110.2308	B8687
102.2122	B277	107.0251	B556	110.2501	B8795
102.2221	B950	107.0261	B954	110.2502	B8796
102.2241	B262	107.1001	B392	110.2504	B8745
102.2242	B216	107.1091	B988	110.2505	B8805
102.2243	B887	108.0241	B379	111.0001	B8696
102.2281	B251	108.0301	B380	111.0002	B8728
102.3241	B311	108.1041	B793	111.0003	B8727
103.1001	B362	109.6002	B429	111.0004	B8725A
103.1082	B211S	109.6003	B861	111.0006	B8714
103.1084	B888	109.6004	B428	111.0011	B8150R
103.1084S	B888S	109.6009	B829	111.0012	B8150L
103.1086	B495S	110.0010	B8735	112.1081	B8754
104.03181	B433	110.2001	B8648	112.1082	B8760
104.03281	B999	110.2002	B8684	112.1083	B8750
104.04171	B769	110.2003	B8742	112.1161	B8600A
104.04201	B770	110.2004	B8746	112.1162	B8600
104.05091	B953	110.2005	B8746Z	112.1163	B667
104.05161	B220	110.2006	B8712	112.1164	B8602
104.05162	B434	110.2007	B8793	112.1165	B8606
104.06002	B972	110.2008	B8657	112.1166	B8606A
104.06081	B256	110.2009	B8647	112.1167	B8688
104.06181	B307	110.2010	B8803	112.1168	B807
104.07041	B562	110.2101	B8649	112.1169	B8614
104.07061	B579	110.2102	B8650	112.1191	B8624
104.07221	B952	110.2201	B8646	112.1192	B8623
104.08001	B971	110.2202	B8743	112.1201	B8782
104.08001HD	B728	110.2203	RC-1	112.1202	B8627
104.08121	B302	110.2204	B8683	112.1203	B8698
104.08121HD	B349	110.2205	B8744	112.1204	B805
104.08123	B956	110.2206	B8747HD	112.1205	B8783
104.08131HD	B350	110.2207	B8707	112.1206	B8620
104.09021	B348	110.2208	B8766	112.1241	B8615
104.09041	B871	110.2209	B8772M	112.1281	B8628
104.10001	B983	110.2210	B8773M	112.11610	B8636
104.10042	B436	110.2211	B8771	112.11611	B8699
104.10241HD	B432A	110.2212	B8643	112.11612	B8635
104.10261HD	B981	110.2213	B8686HD	112.11613	B8665
104.11121	B982	110.2215	B8645	112.11614	B8616
105.1001	B868	110.2216	B8681	112.11615	B8601
105.1002	B498	110.2217	B8788	112.11616	B8603
105.1003	B151	110.2218	B8661	113.1241	B8761
105.1004	B431	110.2219	B8660	113.1242	B8613
105.1005	B161	110.2220	B8794	113.1281	B8612

INTERCHANGES

AUTOMANN	SIRCO	AUTOMANN	SIRCO	AUTOMANN	SIRCO
113.1282	B8612A	120.100820.01	C490L	122.100926.04	C762R
113.1283	B8626	120.100820.02	C491R	122.101116.01	C148CL
113.1284	B8751	120.101016.01	C886L	122.101116.02	C147CR
113.1291	B8621	120.101016.02	C887R	122.101124.01	C702BR
113.2001	B8625	120.101116.01	C776L	122.101124.02	C703BL
113.2002	B8764	120.101116.02	C775R	122.101404.01	C880L
113.2021	B8755	120.101118.01	C492L	122.101404.02	C881R
113.2022	B8690	120.101118.02	C493R	122.101524.01	C711L
113.2023	B8609	120.101214.01	C787L	122.101524.02	C710R
114.1051	B8630	120.101214.02	C786R	122.101710.01	C447L
114.1052	B8629	120.101216.01	C769L	122.101710.02	C448R
114.1081	B8753	120.101216.02	C770R	122.101710.03	C447AL
114.1082	B8752	120.101230.01	C888L	122.101710.04	C448AR
114.1083	B8762	120.101230.02	C889R	122.101724.01	C715L
114.1091	B8758	120.101500.01	C055L	122.101724.02	C714R
114.1092	B8757	120.101500.02	C056R	122.102013.01	C449L
114.1101	B8756	120.101916.01	C693L	122.102013.02	C450R
114.1161	B8763	120.101916.02	C694R	122.102013.03	C449AL
114.1162	B8608	120.101916.03	C494L	122.102013.04	C450AR
114.1163	B8719	120.101916.04	C495R	122.102212.01	C089L
114.1164	B230	120.102324.01	C721L	122.102212.02	C090R
114.1165	B8759	120.102324.02	C720R	122.102402.01	C451L
114.1166	B8718	120.102324.03	C496L	122.102402.02	C452R
114.1167	B8765	120.102324.04	C497R	122.102402.03	C451AL
114.1171	B8632	120.281916.01	C057L	122.102402.04	C452AR
114.1172	B8605	120.281916.02	C058R	122.102524.01	C719L
114.1173	B8610	120.282007.01	C723L	122.102524.02	C718R
114.1174	B8607	120.282007.02	C722R	122.208802.01	C499L
114.1175	B8697	120.282324.01	C059L	122.208802.02	C500R
114.1176	B811	120.282324.02	C060R	122.280723.01	C645L
114.1177	B8631	121.371604.01	C563L	122.280723.02	C646R
114.1181	B8611	121.371604.02	C564R	122.280802.03	C647L
114.1201	B960	121.372104.01	C101L	122.280802.04	C648R
114.1202	B8786	121.372104.02	C100R	122.280818.01	C896L
114.1203	B8784	121.372328.01	C861L	122.280818.02	C897R
114.1204	B961	121.372328.02	C862R	122.280818.03	C427L
114.1205	B8785	122.100721.03	C750L	122.280818.04	C426R
114.1211	B8619	122.100721.04	C751R	122.280902.01	C898L
114.1213	B8781	122.100728.01	C706BR	122.280902.02	C899R
114.1221	B800	122.100728.02	C707BL	122.280902.03	C651L
114.1222	B801	122.100730.03	C752L	122.280902.04	C652R
115.0311	B794	122.100730.04	C753R	122.280914.01	C649L
115.1011	B8722	122.100816.05	C754L	122.280914.02	C650R
115.1051	B8689	122.100816.06	C755R	122.280914.05	C653L
115.1101	B795	122.100818.03	C479BL	122.280914.06	C654R
115.1121	B8691	122.100818.04	C478BR	122.281006.01	C504L
115.1161	B8604	122.100908.03	C756L	122.281006.02	C505R
115.1162	B8622	122.100908.04	C757R	122.281013.01	C347L
115.1201	B8634A	122.100918.03	C763L	122.281013.02	C348R
120.100818.01	C800L	122.100918.04	C764R	122.281013.03	C655L
120.100818.02	C799R	122.100926.03	C761L	122.281013.04	C656R

INTERCHANGES

AUTOMANN	SIRCO	AUTOMANN	SIRCO	AUTOMANN	SIRCO
122.281030.01	C727L	122.281710.02	C442R	123.282014.01	C520L
122.281030.02	C726R	122.281710.03	C441BL	123.282014.02	C521R
122.281030.03	C657L	122.281710.03	C091L	123.282014.03	C933L
122.281030.04	C658R	122.281710.03	C867L	123.282014.04	C934R
122.281104.03	C524L	122.281710.04	C442BR	123.282112.01	C310L
122.281104.04	C522R	122.281710.04	C092R	123.282112.02	C311R
122.281107.01	C349L	122.281710.04	C866R	123.282228.01	C890L
122.281107.02	C350R	122.282013.01	C443L	123.282228.02	C891R
122.281118.01	C351L	122.282013.02	C444R	123.282230.01	C098L
122.281118.02	C352R	122.282013.03	C443BL	123.282230.02	C099R
122.281118.03	C537L	122.282013.03	C871L	123.282306.01	C759L
122.281118.04	C536R	122.282013.04	C444BR	123.282306.02	C760R
122.281122.01	C882L	122.282013.04	C870R	123.282306.03	C905L
122.281122.02	C883R	122.282402.01	C445L	123.282306.04	C906R
122.281122.03	C663L	122.282402.02	C446R	123.282314.01	C856L
122.281122.04	C664R	122.282402.03	C445BL	123.282314.02	C857R
122.281130.01	C665L	122.282402.03	C868L	123.282318.01	C526L
122.281130.02	C666R	122.282402.04	C446BR	123.282318.02	C527R
122.281214.01	C894L	122.282402.04	C869R	123.282318.03	C935L
122.281214.02	C895R	123.101512.01	C516L	123.282318.04	C936R
122.281214.03	C667L	123.101512.02	C517R	123.282402.01	C910L
122.281214.04	C668R	123.102012.01	C514L	123.282402.02	C911R
122.281230.01	C729L	123.102012.02	C515R	123.282402.03	C102L
122.281230.02	C728R	123.102104.01	C411L	123.282402.04	C103R
122.281230.03	C669L	123.102104.02	C410R	123.282608.01	C314L
122.281230.04	C670R	123.102228.01	C611L	123.282608.02	C315R
122.281307.01	C731L	123.102228.02	C612R	123.282630.01	C972L
122.281307.02	C730R	123.102308.01	C423L	123.282630.02	C973R
122.281307.03	C595L	123.102308.02	C422R	123.282630.03	C737L
122.281307.04	C594R	123.102316.01	C512L	123.282630.04	C738R
122.281314.01	C733L	123.102316.02	C513R	124.101616.01	C687L
122.281314.02	C732R	123.102328.01	C421L	124.101616.02	C686R
122.281314.03	C733AL	123.102328.02	C420R	124.101712.01	C795L
122.281314.04	C732AR	123.102400.01	C927L	124.101712.02	C794R
122.281403.01	C735L	123.102400.02	C928R	124.101820.01	C413L
122.281403.02	C734R	123.102608.01	C217L	124.101820.02	C412R
122.281403.03	C675L	123.102608.02	C218R	124.102014.01	C425L
122.281403.04	C676R	123.102608.03	C742L	124.102014.02	C424R
122.281419.01	C085L	123.102608.04	C743R	124.102103.01	C688L
122.281419.02	C086R	123.102616.01	C219L	124.102103.02	C689R
122.281419.03	C677L	123.102616.02	C220R	124.102228.01	C884L
122.281419.04	C678R	123.281706.01	C096L	124.102228.02	C885R
122.281424.01	C679L	123.281706.02	C097R	124.102314.01	C095L
122.281424.02	C680R	123.281712.01	C724L	124.102314.02	C094R
122.281506.01	C083L	123.281712.02	C725R	124.102400.01	C717L
122.281506.02	C084R	123.281714.01	C518L	124.102400.02	C716R
122.281506.03	C681L	123.281714.02	C519R	124.102412.01	C797L
122.281506.04	C682R	123.281714.03	C931L	124.102412.02	C796R
122.281523.03	C683L	123.281714.04	C932R	125.101100.01	C607L
122.281523.04	C684R	123.282012.01	C854L	125.101100.02	C606R
122.281710.01	C441L	123.282012.02	C855R	125.281102.01	C609L

INTERCHANGES

AUTOMANN	SIRCO	AUTOMANN	SIRCO	AUTOMANN	SIRCO
125.281102.01	C605L	139.2831	SA1073	179.SC20	A2000S
125.281102.02	C608R	143.130880.30	L1308E	179.SC24	A2400S
125.281102.02	C604R	143.130882.30	L1308Q	179.SC30	A3000S
125.281104.01	C603L	143.144380.30	L1443E	179.YK5005	S2009
125.281104.02	C602R	143.431180.30	L4311J	179.YK5812	S2000
133.1030	SA10102	143.451582.30	L4515X	179.YK5814	S2007
133.1031	SA10103	143.451584.30	L4515Q	180.10616	9009G
133.1040	SA10215	143.451584.40	L4515Q-20	180.10617	9015
133.1041	SA10216	143.470280.30	L4702Q	180.10618	9013
133.1042	SA10306	143.470780.30	L4707	180.10618.1	9014
133.2830	SA10100	143.470780.40	L4707Q-20	180.10619	9009
133.2831	SA10101	143.470980.30	L4709N	180.10619.1	9018-1
133.2832	SA10144	144.130880.3030	L1308E-EF1	180.10620	9009W
133.2840	SA10211	144.130882.3010	L1308Q-RF3	180.10622	9024P
133.2841	SA10212	144.144380.3030	L1443E-EF1	180.10624	9008P
133.2842	SA10305	144.431180.3030	L4311J-EK1HD	180.10626	9249W
133.3741	SA10214	144.451582.3032	L4515X-XK3HD	201.1001L	709AL
134.1010	S2026	144.451582.4022	L4515Q-20-QK1HD	201.1001R	708AR
134.1031	S2020A	144.451584.4022	L4515Q-QK1HD	201.1002L	896L
134.1040	S2021A	144.470280.3010	L4702Q-RF5	201.1002R	896R
134.1041	S2010A	144.470782.4022	L4707Q-20-QK1HD	201.1003L	897L
134.1042	S2025	144.470784.4022	L4707-QK1HD	201.1003R	897R
134.2410	S2024	144.470980.3011	L4709N-ES2	201.1004L	306L
134.2831	S2019A	145.F014100BN	634X	201.1004R	306R
134.2840	S2011A	145.F014100S	999X	201.1006L	978L
134.2841	S2022A	170.227870	A1030	201.1006R	978R
134.2842	S2023	170.229859	A9859	201.1007L	988L
134.3741	S2012A	170.229860	A9860	201.1007R	988R
136.1010	SA24100	170.275491	A5491	201.2001L	889L
136.1030	SA21103	179.1001	A1452	201.2001R	888R
136.1031	SA21102	179.1002	A1451	201.2003L	892AL
136.2410	SA25100	179.1003	A1450	201.2003R	891AR
136.2830	SA22103	179.1005	A1440	201.2004L	996L
136.2831	SA22102	179.1010	9004	201.2004R	996R
136.3741	SA23106	179.1011	9004R	201.2006L	304L
137.1010	SA2164	179.1012	9004B	201.2006R	304R
137.1011	SA2170	179.1013	9004P	201.2009L	995L
137.1030	SA2172	179.3003.12	A1012	201.2009R	995R
137.2410	SA2167	179.3003.15	A1015	201.3013	920
137.2810	SA2174	179.3005	A1453	201.3014	333B
137.2830	SA2175	179.DT20	DT20	201.3015	881M
138.1010	SA1136	179.DT24	DT24	201.3019L	913L
138.1011	SA1132	179.DT24L	DT24LS	201.3019R	912R
138.1030	SA1133	179.DT30	DT30	201.3031	333SN6
138.2410	SA1138	179.DT30L	DT30LS	201.3033	333SN28
138.2810	SA1140	179.PB3030	A3030PB	201.3034	333SN39
138.2830	SA1141	179.PB3030SL	A3030PBLs	201.3036	333SN19
138.3741	SA1144	179.SB3030S	A3030S	201.6035L	192
139.1030	SA1042	179.SB3030SL	A3030LS	201.6035R	191
139.1031	SA1041	179.SC12	A1200	201.6037L	264
139.2830	SA1074	179.SC16	A1600	201.6037R	263

INTERCHANGES

AUTOMANN	SIRCO	AUTOMANN	SIRCO	AUTOMANN	SIRCO
201.6039L	427	201.6130	367	203.4005	715
201.6039R	426	201.6132	335	203.4006	411
201.6042L	969	201.6133	336	209.1110	2299
201.6042R	968	201.6141	436	209.1111	2296
201.6043L	421	201.6143	452	209.1222	2303
201.6043R	420	201.6144	453	209.1223	2305
201.6045L	947	201.6145	437	209.1307	5210
201.6045R	948	201.6149	164	209.1308	5200
201.6049L	425	201.6151	162	209.2107	2297
201.6049R	424	201.6151L	429	209.2109	2298
201.6050L	419	201.6151R	428	209.2206	5300
201.6050R	418	201.6152	423	209.2214	2304
201.6054L	134	201.6153	676	209.2313	5660
201.6054R	133	201.6157	160	209.2316	5402
201.6057L	433	201.6158	422	209.2360	3569
201.6057R	432	201.6161	883	209.2362	3568
201.6062L	435	201.6162	884	210.1904	1904
201.6062R	434	201.6172	451	210.1908	1908
201.6067L	852	201.7002L	095	210.1909	1909
201.6067R	851	201.7002R	096	210.1910	1910
201.6069L	184	201.7003L	989	210.1912	1912
201.6069R	183	201.7003R	988	210.1913	1913
201.6071L	098	201.7004L	991	210.1914	1914
201.6071R	097	201.7004R	990	210.1915	1915
201.6072L	067	201.7005L	005	210.1917	1917
201.6072R	066	201.7005R	004	210.1919	1919
201.6073L	376	201.7006L	125	210.1920	1920
201.6073R	375	201.7006R	124	210.1921	1921
201.6074L	374	201.7010L	272	210.1922	1922
201.6074R	373	201.7010R	271	210.1923	1923
201.6086L	205	201.7011L	011	210.1925	1925
201.6086R	204	201.7011R	012	210.1927	1927
201.6097L	450	203.1009	853	210.1941	9012
201.6097R	449	203.1010	722	537.1001	CMBK
201.6103L	448	203.1011	544	AB1D28C-9122	AS9122
201.6103R	447	203.1013	545	AB1D28G-9121	AS9121
201.6104L	439	203.1015	251	AB1DF23-9780	AS9780
201.6104R	438	203.2013	123	AB1DF23-9781	AS9781
201.6106L	431	203.2014	708	AB1DK20D-9387	AS9387
201.6106R	430	203.2015	993	AB1DK20D-9422	AS9422
201.6107L	415	203.2016	235	AB1DK20D-9616	AS9616
201.6107R	414	203.2018	053	AB1DK20F-9293	AS9293
201.6108L	413	203.2020	256	AB1DK20F-9295	AS9295
201.6108R	412	203.2022	302	AB1DK20F-9307	AS9307
201.6109L	481	203.2023	257	AB1DK20G-9547	AS9547
201.6109R	482	203.2041	233	AB1DK20G-9622	AS9622
201.6111L	417	203.2042	236	AB1DK20H-9625	AS9625
201.6111R	416	203.3001	149	AB1DK20J-9626	AS9626
201.6114L	287L	203.3002	716	AB1DK23F-9039	AS9039
201.6114R	287R	203.3002B	716S	AB1DK23H-8204	AS8204
201.6128	366	203.4002	654	AB1DK23H-9366	AS9366

INTERCHANGES

AUTOMANN	SIRCO	AUTOMANN	SIRCO	AUTOMANN	SIRCO
AB1DK23H-9640	AS9640	ABSP2B34R-7136	AS7136	FLN106	ST1008
AB1DK23I-8813	AS8813	ABSP2B34R-7140	AS7140	FLN107	SH1027
AB1DK23I-9010	AS9010	ABSP3B22R-8008	AS8008	G1803	B8662
AB1DK23I-9069	AS9069	ABSP3B22R-8018	AS8018	G1815	B8664
AB1DK23I-9270	AS9270	ABSP3B22R-8032	AS8032	KP100	700
AB1DK23I-9807	AS9807	ABSP3B22R-8033	AS8033	KP101	44132
AB1DK23K-8829	AS8829	ABSP3B32R-7798	AS7798	KP101UB	44132U
AB1DK23K-9026	AS9026	ABSP3B32R-7818	AS7818	KP102	44131
AB1DK23K-9082	AS9082	AUBK5161-12	5R783123	KP103	44133
AB1DK23K-9213	AS9213	AUBK5161-18	5R783186	KP104	44130
AB1DK23K-9219	AS9219	AUBK5165-14	5R785146	KP104UB	44130U
AB1DK23K-9466	AS9466	AUBK5165-18	5R785186	KP106K	13502
AB1DK23K-9648	AS9648	AUBK5161-134	5R783136	KP109	13501
AB1DK23L-8852	AS8852	AUBK5161-144	5R783146	KP109UB	13501U
AB1DK23L-9101	AS9101	AUBK8151-12	8R343123	KP110	13500
AB1DK23L-9192	AS9192	AUBK8151-185	8R343186	KP110UB	13500U
AB1DK23L-9243	AS9243	BKF100600	SB1015	KP114	50920JS
AB1DK23L-9265	AS9265	BKF780512	SB1016	KP115	50920BS
AB1DK23L-9371	AS9371	C100212 GR5	SR1006	KP128	44135
AB1DK23L-9394	AS9394	C118700 GR8	SH1054	KP130	44134
AB1DK23M-9375	AS9375	C780512 GR5	ST1007	KP131	35102A
AB1DK23M-9647	AS9647	CP14100	5403	KP351A02L	35102L
AB1DK23N-9321	AS9321	DL376	SH1023	KP351A02R	35102R
AB1DK23N-9367	AS9367	DN0	SH1087	KP2524P	25240
AB1DK23N-9370	AS9370	DN1	SH1080	KP5092L	50920L
AB1DK23P-8944	AS8944	DN2	SH1081	KP5092R	50920R
AB1DK23P-9287	AS9287	DN3	SH1082	KP6000L	60000L
AB1DK23P-9373	AS9373	DN4	SH1064	KP6000R	60000R
AB1DK23P-9921	AS9921	DN4H	SH1064H	KP63500	63500R
AB1DK23P-9923	AS9923	DN5	SH1039	KP63501	63501L
AB1DK23P-9935	AS9935	DN6	SH1083	KP63503	63503M
AB1DK23P-9936	AS9936	DN7	SH1084	KP73221-50Z	73221L
AB1DK25A-8709	AS8709	DN8	SH1085	KP4000501	40501L
AB1DK25B-8755	AS8755	DN00	SH1086	KP4000503	40503R
AB1DK25C-8749	AS8749	EQ001	SR1000	KP4000528	40528
AB1DK25C-9580	AS9580	EQ013	SH1021	KP4000529	40529
AB1DK25D-8729	AS8729	EQ013UB	SH1021U	KP35107296	35102M
AB1DK25E-8708	AS8708	EQ014	SH1025	KP40100135	40135L
AB1DK25E-8713	AS8713	EQ015	SF1000	KP40100136	40136R
AB1DK28A-8050	AS8050	EQ019	SH1048	KP40100254	40254L
AB1DK28E-8091	AS8091	EQ019UB	SH1048U	KPL002	702
ABSP2B12R-6897	AS6897	EQ022	ST1000	LN104	804
ABSP2B12R-6902	AS6902	EQ023	SF1001	LN105	073
ABSP2B12R-6905	AS6905	EQ028	SH1050	LN105	806
ABSP2B12R-6910	AS6910	EQ041	ST1001	LN106	SB1006
ABSP2B12R-7795	AS7795	EQ042	SB1000	LN107	SR1011
ABSP2B22R-7403	AS7403	F100500 GR5	SH1026	LNC105	805
ABSP2B22R-7410	AS7410	F100612 GR5	ST1004	LNC107A	SH1055
ABSP2B22R-7550	AS7555	F120500 GR5	SR1017	LW109	SR1005
ABSP2B22R-7555	AS7555	F580412 GR5	SH1045	M470	SF1014
ABSP2B34R-7135	AS7135	F780512 GR5	SB1005	M471	SF1015

INTERCHANGES

AUTOMANN	SIRCO	AUTOMANN	SIRCO	AUTOMANN	SIRCO
M852	SH1030	SRL107	ST1009	TRK6300UB	SF1009U
M4884	SB1002	SRL109	SR1016	TRK6326	SH1040
M5288	SR1009	ST2106	SR1018	TRK6326UB	SH1040U
M6120	SF1020	TR001	SR1012	TRS3309	SF1010
M6122	SF1021	TR002	SR1013	TRS4003	SR1003
M6124	SF1022	TR004	SH1042	TRS4309HD	SF1003
M7568	5401	TR005	SH1029	TRS4413	SH1009
M8095	SH1059	TR005B	SB1008	WA01	SF1013
M8097	SH1060	TR006	SF1007	WA02	SF1012
M8140	SF1018	TR007	SH1043	WA03	SF1005
M8142	SF1017	TR009	SB1007	WA04	SF1006
M8144	SF1016	TR010	ST1005	WA05	SR1010
M8284	SH1031	TR019	SH1041	WA06	SR1004
M8286	SH1032	TR021	SF1008		
M8288	SH1033	TR031	SR1014		
M8290	SH1034	TR032	SR1015		
M8292	SH1035	TRA693	SF693		
M8294	SH1036	TRA2726	SH2726		
M8296	SH1037	TRA2727	SH2727		
M8298	SH1038	TRA2728	SH2728		
M12076	ST1010	TRB5066	SR1002		
M12078	ST1011	TRB5066UB	SR1002U		
M12080	ST1012	TRB5384	SF1004		
M12082	ST1013L	TRB5384UB	SF1004U		
M12084	ST1013R	TRB5541	SH1008		
M12086	ST1014	TRB5541UB	SH1008U		
M12088	ST1015L	TRB5542	SH1049		
M12090	ST1015R	TRB5542UB	SH1049U		
M12096	ST1017	TRB5543	SB1001		
M17728	ST1018	TRB5544	ST1003		
M21072	SB1009	TRB6008	SR1008		
M21074	SB1010	TRB6008UB	SR1008U		
M21076	SB1011	TRB6300	SF1011		
M83457	ST1019	TRB6300UB	SF1011U		
MH456	SH1010	TRB6326	SH1001		
MH558	SH1046	TRB6326UB	SH1001U		
MH680	SH1044	TRK5066	SR1001		
MUBW124	SH1090	TRK5384	SF1002		
MUBW134	SH1091	TRK5384UB	SF1002U		
MUBW144	SH1092	TRK5541	SH1012		
MUBW154	SH1093	TRK5541UB	SH1012U		
MUBW164	SH1094	TRK5542B	SH1053		
MUBW174	SH1063	TRK5543	SB1013		
MUBW184	SH1016	TRK5544	ST1002		
MUBW194	SH1095	TRK5544A	SH1061		
MUBW200	SH1062	TRK6004	ST1006		
MUBW204	SH1097	TRK6004B	SB1014		
PNF104	44137	TRK6004UB	SB1014U		
PNF106	SH1011	TRK6008	SR1007		
SRL01	SH1057	TRK6008UB	SR1007U		
SRL03	SF1019	TRK6300	SF1009		

INTERCHANGES

BATCO	SIRCO	BATCO	SIRCO	BATCO	SIRCO
01-200	B941	01-363	B952	01-603	635X
01-201	B611	01-369	B302	01-604	636X
01-202	B586	01-370	B220	01-605	628X
01-204	B924	01-371	B972	01-609	999X
01-205	B500	01-372	B347	01-2091	BP-105
01-215	B053	01-374	B579	01-2093	BP-109
01-217	B052	01-375	B871	01-3461	BP-106
01-218	B055	01-377	B870	01-3462	BP-100
01-223	B133	01-378	B308	01-3481	B434
01-225	B425	01-379	B349	01-3482	B434S
01-227	B054	01-380	B953	01-3696	B956
01-229	B922	01-381	B221	01-3697	B957
01-234	B911	01-382	B139	01-3751	B348
01-236	B923	01-383	B140	01-3862	B350
01-237	B725	01-384	B142	01-3864	B432A
01-238	B135	01-385	B143	01-4191	BP-110
01-247	B430K	01-390	ARK	01-4411	BP-104
01-248	B137	01-391	B955	01-21702	B942
01-250	B499	01-392	B829	02-200	B8635
01-262	B152	01-400	B832	02-201	B8635
01-263	B132	01-401	B887	02-202	B8600
01-264	B154	01-417	B216	02-203	B8602
01-271	B134	01-424	B311	02-204	B807
01-272	B136	01-432	B424	02-210	B8600A
01-294	B431	01-434	B120	02-211	B667
01-300	B151	01-435	B377	02-216	B495S
01-301	B379	01-437	B262	02-216S	B495
01-305	B218	01-440	B251	02-217	B595S
01-310	B868	01-446	B898	02-218	B8660
01-311	B498	01-447	B217	02-219	B888S
01-313	B161	01-448	B277	02-220	B8620
01-314	B973	01-451	B950	02-224	B8698
01-318	B358	01-452	B122	02-225	B8750
01-320	B423	01-454	B138	02-230	B8615
01-322	B728	01-455	B141	02-231	B8614
01-323	B974	01-460	B901	02-232	B8665
01-331	B307	01-462	B501	02-233	B8754
01-339	B256	01-470	B011	02-234	B144
01-340	B433	01-472	B988	02-235	B362
01-341	B426	01-473	B392	02-237	BP-108
01-345	B427	01-477	B954	02-240	B8661
01-347	B436	01-478	B951	02-241	B8628
01-348	B769	01-482	B793	02-242	B8627
01-349	B981	01-489	B380	02-244	B8760
01-350	B869	01-490	B861	02-246	B8782
01-354	B971	01-491	B932	02-256	B805
01-357	B999	01-492	B8689	02-257	B806
01-358	B562	01-499	B823	02-300	B8609
01-360	B982	01-509	B211S	02-304	B8612A
01-361	B770	01-601	634X	02-306	B8613
01-362	B983	01-602	583X	02-309	B8626

INTERCHANGES

BATCO	SIRCO	BATCO	SIRCO	BATCO	SIRCO
02-312	B8612	04-300	B8608	04-201002	C761L
02-313	B8625	04-301	B8605	04-370861	C799R
02-315	B8751	04-302	B8607	04-370862	C800L
02-316	B8755	04-303	B8611	04-371051	C887R
02-317	B717	04-304	B8619	04-371052	C886L
02-318	B8761	04-306	B8697	04-371151	C775R
02-329	B8690	04-307	B8629	04-371152	C776L
02-2101	B8766	04-308	B8630	04-371251	C786R
02-2481	B8783	04-310	B8604	04-371252	C787L
03-114	B8714	04-314	B8634	04-371311	C889R
03-115	B8733	04-315	B8622	04-371312	C888L
03-119	B8717	04-318	B8691	04-371511	C056R
03-146	CT332	04-319	B8722	04-371512	C055L
03-147	CT333	04-321	B8784	04-390861	C491R
03-149	CT336	04-322	B8719	04-390862	C490L
03-150	CT337	04-327	B8631	04-391161	C493R
03-151	CT338	04-328	B8632	04-391162	C492L
03-154	CT350	04-329	B800	04-391251	C770R
03-155	CT351	04-333	B8785	04-391252	C769L
03-160	CT356	04-334	B8718	04-391351	C741R
03-161	CT357	04-335	B8765	04-391352	C740L
03-168	CT334	04-338	B8781	04-450811	C706R
03-169	CT311	04-339	B811	04-450812	C707L
03-170	CT312	04-340	B8756	04-450861	C478R
03-180	CT359	04-341	B230	04-450862	C479L
03-181	CT360	04-345	B8758	04-451121	C773R
03-182	CT361	04-346	B8759	04-451122	C774L
03-184	CT370	04-347	B8757	04-451151	C147R
03-200	B8603	04-350	B8752	04-451152	C148L
03-201	B8601	04-351	B8753	04-451171	C702R
03-202	B8616	04-356	B794	04-451172	C703L
03-206	B8623	04-357	B8763	04-451251	C708R
03-207	B8624	04-358	B960	04-451252	C709L
03-208	B8606	04-359	B961	04-451421	C881R
03-209	B8696	04-360	B8721	04-451422	C880L
03-210	B8699	04-361	B8786	04-451561	C710R
03-212	B8636	04-362	B8787	04-451562	C711L
03-213	B8621	04-363	B8634A	04-460821	C500R
03-214	B8688	04-376	B801	04-460822	C499L
03-250	B8713	04-377	B8762	04-460851	C897R
03-251	B8734	04-200771	C751R	04-460852	C896L
03-260	B8736	04-200772	C750L	04-460921	C899R
03-261	B8735	04-200811	C753R	04-460922	C898L
03-270	B8725	04-200812	C752L	04-460951	C650R
03-272	B8727	04-200851	C755R	04-460952	C649L
03-273	B8728	04-200852	C754L	04-461051	C348R
03-278	B8725A	04-200931	C757R	04-461052	C347L
03-279	B8727A	04-200932	C756L	04-461101	C726R
03-1451	CT375	04-200961	C764R	04-461102	C727L
03-2081	B8150R	04-200962	C763L	04-461121	C350R
03-2082	B8150L	04-201001	C762R	04-461122	C349L

INTERCHANGES

BATCO	SIRCO	BATCO	SIRCO	BATCO	SIRCO
04-461151	C352R	04-481332	C595L	04-572241	C090R
04-461152	C351L	04-481351	C732AR	04-572242	C089L
04-461161	C883R	04-481352	C733AL	04-572301	C885R
04-461162	C882L	04-481421	C676R	04-572302	C884L
04-461251	C895R	04-481422	C675L	04-572351	C094R
04-461252	C894L	04-481461	C678R	04-572352	C095L
04-461311	C728R	04-481462	C677L	04-572411	C716R
04-461312	C729L	04-481471	C680R	04-572412	C717L
04-461331	C730R	04-481472	C679L	04-572441	C796R
04-461332	C731L	04-481531	C682R	04-572442	C797L
04-461351	C732R	04-481532	C681L	04-572571	C718R
04-461352	C733L	04-481561	C307R	04-572572	C719L
04-461421	C734R	04-481562	C306L	04-572631	C218R
04-461422	C735L	04-481571	C684R	04-572632	C217L
04-461461	C086R	04-481572	C683L	04-572651	C220R
04-461462	C085L	04-481601	C584R	04-572652	C219L
04-461531	C084R	04-481602	C585L	04-581741	C725R
04-461532	C083L	04-542321	C906R	04-581742	C724L
04-461571	C186R	04-542322	C905L	04-582041	C855R
04-461572	C185L	04-561741	C932R	04-582042	C854L
04-480771	C646R	04-561742	C931L	04-582271	C891R
04-480772	C645L	04-562041	C934R	04-582272	C890L
04-480821	C648R	04-562042	C933L	04-582351	C857R
04-480822	C647L	04-562141	C311R	04-582352	C856L
04-480861	C426R	04-562142	C310L	04-582411	C893R
04-480862	C427L	04-562301	C313R	04-582412	C892L
04-480921	C652R	04-562302	C312L	04-591741	C517R
04-480922	C651L	04-562351	C936R	04-591742	C516L
04-480951	C654R	04-562352	C935L	04-592041	C515R
04-480952	C653L	04-562411	C911R	04-592042	C514L
04-481031	C505R	04-562412	C910L	04-592301	C612R
04-481032	C504L	04-562631	C315R	04-592302	C611L
04-481041	C656R	04-562632	C314L	04-592351	C513R
04-481042	C655L	04-562701	C738R	04-592352	C512L
04-481051	C540R	04-562702	C737L	04-592411	C928R
04-481052	C541L	04-571651	C686R	04-592412	C927L
04-481111	C658R	04-571652	C687L	04-592631	C743R
04-481112	C657L	04-571741	C794R	04-592632	C742L
04-481121	C522R	04-571742	C795L	04-601721	C097R
04-481122	C524L	04-571761	C714R	04-601722	C096L
04-481151	C536R	04-571762	C715L	04-601741	C519R
04-481152	C537L	04-571841	C690R	04-601742	C518L
04-481171	C664R	04-571842	C691L	04-602041	C521R
04-481172	C663L	04-571861	C412R	04-602042	C520L
04-481211	C666R	04-571862	C413L	04-602301	C099R
04-481212	C665L	04-572041	C424R	04-602302	C098L
04-481251	C668R	04-572041	C424AR	04-602351	C527R
04-481252	C667L	04-572042	C425L	04-602352	C526L
04-481311	C670R	04-572042	C425AL	04-602401	C531R
04-481312	C669L	04-572111	C689R	04-602402	C530L
04-481331	C594R	04-572112	C688L	04-602411	C103R

INTERCHANGES

BATCO	SIRCO	BATCO	SIRCO	BATCO	SIRCO
04-602412	C102L	04-892421	C446R	05-651	SA10305
04-602631	C533R	04-892422	C445L	05-654	SA10102
04-602632	C532L	04-911731	C092R	05-655	SA10100
04-602701	C973R	04-911732	C091L	05-659	SA10144
04-602702	C972L	04-912041	C088R	05-660	SA10216
04-612121	C410R	04-912042	C087L	05-661	SA10103
04-612122	C411L	04-912421	C082R	05-662	SA10212
04-612321	C422R	04-912422	C081L	05-663	SA10101
04-612322	C423L	04-931731	C442BR	05-664	SA10214
04-612401	C420R	04-931731	C866R	05-667	SA10215
04-612402	C421L	04-931732	C441BL	05-668	SA10211
04-642321	C760R	04-931732	C867L	06-198	5300S
04-642322	C759L	04-932041	C444BR	06-201	5200
04-711951	C694R	04-932041	C870R	06-202	5300
04-711952	C693L	04-932042	C443BL	06-203	5210
04-712371	C720R	04-932042	C871L	06-226	5401
04-712372	C721L	04-932421	C446BR	06-228	5402
04-722021	C722R	04-932421	C869R	06-229	5403
04-722022	C723L	04-932422	C445BL	06-230	5660
04-731941	C495R	04-932422	C868L	06-345	3569
04-731942	C494L	05-124	A2400S	06-347	3568
04-732361	C497R	05-130	A3000S	06-354	2296
04-732362	C496L	05-201	S2020A	06-355	2297
04-741941	C058R	05-202	S2021A	06-357	2298
04-741942	C057L	05-203	S2010A	06-358	2299
04-742361	C060R	05-214	S2026	06-411	2303
04-742362	C059L	05-237	S2019A	06-412	2305
04-811621	C564R	05-238	S2022A	06-413	2304
04-811622	C563L	05-240	S2012A	08-100100	TK-1
04-812121	C100R	05-250	S2025	08-100105	TK-1
04-812122	C101L	05-251	S2023	08-100160	TK-1HD
04-812401	C862R	05-254	S2024	08-100165	TK-1HD
04-812402	C861L	05-460	SA2172	08-100300	TK-4MP
04-851121	C606R	05-461	SA2170	08-100305	TK-4MP
04-851122	C607L	05-462	SA2175	08-100360	TK-4MPHD
04-861121	C602R	05-463	SA2174	08-100365	TK-4MPHD
04-861122	C603L	05-464	SA2179	08-100600	FK-1
04-871121	C608R	05-465	SA2178	08-100601	FK-2
04-871121	C604R	05-470	SA2164	08-100604	FK-1
04-871122	C609L	05-472	SA2167	08-100605	FK-2
04-871122	C605L	05-550	SA21953	08-100660	FK-1HD
04-881731	C448R	05-552	SA22953	08-100661	FK-2HD
04-881732	C447L	05-560	SA21103	08-100664	FK-1HD
04-882041	C450R	05-561	SA21102	08-100665	FK-2HD
04-882042	C449L	05-562	SA22103	08-104200	EK-1HD
04-882421	C452R	05-563	SA22102	08-104220	EK-3
04-882422	C451L	05-564	SA23106	08-104300	ES-3
04-891731	C442R	05-570	SA24100	08-104330	ES-4
04-891732	C441L	05-572	SA25100	08-104400	ES-3R
04-892041	C444R	05-590	S2007	08-104430	ES-4R
04-892042	C443L	05-650	SA10306	08-104700	LB-3D

INTERCHANGES

BATCO	SIRCO	BATCO	SIRCO	BATCO	SIRCO
08-104800	LB-10D	08-111560	MK-2HD	08-130600	B8645
08-104900	LB-10R	08-111600	MF-1	08-130601	B8683
08-105000	LB-11R	08-111605	MF-1	08-130611	B8773M
08-105010	LB-12R	08-111630	MF-2	08-130620	B8645Z
08-105100	LB-7	08-111635	MF-2	08-130621	B8683Z
08-107400	LB-1	08-114000	FF-1	08-130631	B8772M
08-107600	LB-4	08-114002	FF-1A	08-130650	B8645A
08-107602	LB-4A	08-114052	FF-1S	08-130651	B8683A
08-107700	LB-5	08-114200	FR-1	08-130661	B8773MA
08-108200	TK-7	08-114212	FR-1A	08-130670	B8645ZA
08-108205	TK-7	08-114400	LB-9	08-130671	B8683ZA
08-108260	TK-7HD	08-114401	LB-2	08-130681	B8772MA
08-108265	TK-7HD	08-114600	LB-8	08-130800	B8657
08-108300	MK-1HD	08-114601	LB-6	08-130801	B8647
08-108800	QK-1	08-114700	ES-5	08-130850	B8657A
08-108804	QK-1MP	08-114800	ES-1	08-130851	B8647A
08-108810	QK-8	08-114900	ES-2	08-131800	B8707
08-108812	QK-2S	08-114920	EF-2	08-131810	B8707Z
08-108814	QK-8	08-114950	K-4	08-131850	B8707A
08-108816	QK-2S	08-115012	KK-1A	08-131860	B8707ZA
08-108830	QK-1HD	08-115400	EQ-1	08-132100	B8652
08-108834	QK-1MPHD	08-115405	EQ-1	08-132102	B8651
08-108839	QK-1HDO	08-115500	ET-1	08-132103	B8656
08-108840	QK-8HD	08-115505	ET-1	08-132110	B8687
08-108842	QK2SHD	08-115800	EX-1	08-132111	B8685Z
08-108844	QK-8HD	08-115805	EX-1	08-132150	B8652A
08-108846	QK2SHD	08-116000	RF-5	08-132152	B8651A
08-109001	XK-1	08-116004	RF-5	08-132153	B8656A
08-109005	XK-1	08-116030	RF-6	08-132160	B8687A
08-109031	XK-1HD	08-116040	RF-6	08-132161	B8685ZA
08-109035	XK-1HD	08-116260	XL-1	08-132300	B8655
08-109100	XK-3MP	08-116600	SF-1	08-132310	B8655Z
08-109101	XK-3	08-116700	MF-3	08-132350	B8655A
08-109104	XK-3MP	08-116705	MF-3	08-132360	B8655ZA
08-109105	XK-3	08-125100	BK-145F	08-132800	B8792
08-109130	XK-3MPHD	08-125102	BK-145FM	08-132801	B8803R
08-109131	XK-3HD	08-125300	BK-145R	08-132802	B8803L
08-109134	XK-3MPHD	08-130100	B8644	08-132803	B8803
08-109135	XK-3HD	08-130101	B8681	08-132850	B8792A
08-109300	LB-3	08-130111	B8686	08-132900	B8798
08-109600	EK-2	08-130122	B8643	08-132901	B8797R
08-109800	RK-2	08-130150	B8644A	08-132902	B8797L
08-109830	RK-1	08-130151	B8681A	08-132903	B8797
08-109900	WF-1	08-130161	B8686A	08-132950	B8798A
08-109902	WF-1A	08-130172	B8643A	08-133100	B8649
08-110700	RF-1ARK	08-130200	B8646	08-133101	B8650
08-110702	RF-2ARK	08-130250	B8646A	08-133150	B8649A
08-111100	RF-3	08-130301	B8790	08-133151	B8650A
08-111102	RF-3A	08-130311	B8794	08-134100	B8682
08-111300	EF-1	08-130351	B8790A	08-134110	B8682Z
08-111500	MK-2	08-130361	B8794A	08-134150	B8682A

INTERCHANGES

BATCO	SIRCO	BATCO	SIRCO	BATCO	SIRCO
08-134160	B8682ZA	11-0670	9013	13-1037R	012
08-135100	B8648	11-0670V	9013V	13-1102L	192
08-135101	B8746	11-0671	9016	13-1102R	191
08-135110	B8793	11-0674	9009	13-1103L	264
08-135111	B8746Z	11-0675	9009W	13-1103R	263
08-135150	B8648A	11-0680	9014	13-1104L	852
08-135151	B8746A	11-0681	9015	13-1104R	851
08-135160	B8793A	11-1830	B888T	13-1105L	184
08-135161	B8746ZA	11-1904	1904	13-1105R	183
08-136100	B8744	11-1908	1908	13-1106L	376
08-136150	B8744A	11-1909	1909	13-1106R	375
08-136400	B8684	11-1910	1910	13-1107L	969
08-136450	B8684A	11-1912	1912	13-1107R	968
08-136600	B8712	11-1913	1913	13-1108L	098
08-136610	B8712Z	11-1914	1914	13-1108R	097
08-136650	B8712A	11-1915	1915	13-1110L	374
08-136660	B8712ZA	11-1917	1917	13-1110R	373
08-136800	RC-1	11-1919	1919	13-1113L	067
08-136810	RC-1Z	11-1920	1920	13-1113R	066
08-136850	RC-1A	11-1921	1921	13-1122L	947
08-136860	RC-1ZA	11-1922	1922	13-1122R	948
08-136900	B8743	11-1923	1923	13-1128L	421
08-136950	B8743A	11-1925	1925	13-1128R	420
08-137300	B8745	11-1927	1927	13-1129L	134
08-137350	B8745A	11-1941	9012	13-1129R	133
08-137400	B8804	11-1954	5000	13-1133L	427
08-137450	B8804A	12-40020	DT20	13-1133R	426
08-137500	B8742	12-40024	DT24	13-1135L	419
08-137550	B8742A	12-40030	DT30	13-1135R	418
08-137800	B8795	12-40201	S2001	13-1140L	429
08-137850	B8795A	12-40202	S2000	13-1140R	428
08-137900	B8796	12-40403	9004	13-1146L	425
08-137950	B8796A	12-40404	9004P	13-1146R	424
08-138100	B8801	12-40416	A1450	13-1157L	433
08-138150	B8801A	12-40418	A1452	13-1157R	432
08-138200	B8802	12-40419	A1451	13-1158L	435
08-138250	B8802A	12-40430	A1442	13-1158R	434
08-140500	B8800	12-40431	A1443	13-1203L	439
08-140550	B8800A	13-1002L	095	13-1203R	438
11-0198	702	13-1002R	096	13-1204L	413
11-0212	700	13-1003L	989	13-1204R	412
11-0350L	63501L	13-1003R	988	13-1206L	448
11-0350R	63500R	13-1004L	991	13-1206R	447
11-0351L	35102L	13-1004R	990	13-1230L	481
11-0351R	35102R	13-1005L	005	13-1230R	482
11-0352	44134	13-1005R	004	13-1231L	287L
11-0352U	44134U	13-1006L	125	13-1231R	287R
11-0550	44135	13-1006R	124	13-1234L	415
11-0553	44133	13-1008L	272	13-1234R	414
11-0554	44131	13-1008R	271	13-1235L	417
11-0660	9009G	13-1037L	011	13-1235R	416

INTERCHANGES

BATCO	SIRCO	BATCO	SIRCO	BATCO	SIRCO
13-1273L	431	13-4002	123	1308QW00	L1308Q-RF3
13-1273R	430	13-4004	993	1443W	L1443E
13-1546	452	13-4006	235	1443W00	L1443E-EF1
13-1550	436	13-4010	708	2424C	A2424S
13-1551	453	13-4011	053	2430C	A2430S
13-1552	437	13-4530	110	3030C	A3030S
13-1560	884	13-4531	138	3030CL	A3030LS
13-1561	882	13-4601	267	4311W	L4311J
13-1562	883	13-4702	238	4311W00	L4311J-EK1HD
13-1567	423	13-4703	236	4515P00	TK-4
13-1570	164	13-4704	233	4515P60	TK-4HD
13-1571	162	13-4723	256	4515Q00	QK-1
13-1572	160	13-4724	257	4515Q10	QK-8
13-1576	422	13-4725	302	4515Q12	QK-2S
13-1577	676	13-4807	314	4515Q30	QK-1HD
13-1580	334	13-4850	008	4515Q40	QK-8HD
13-1581	335	13-5001	201	4515Q42	QK2SHD
13-1582	336	13-5007	399	4515QL00	L4515Q-20-QK1
13-1585L	450	13-5008	515	4515QM	L4515Q-20
13-1585R	449	13-5009	544	4515QM30	L4515Q-20-QK1HD
13-1721	451	13-5010	545	4515QM31	L4515Q-QK1HD
13-2323L	205	13-5012	853	4515QW	L4515Q
13-2323R	204	13-5014	722	4515X01	XK-3
13-3005L	709AL	13-5015	725	4515X31	XK-3HD
13-3005R	708AR	13-5016	251	4515XW	L4515X
13-3012L	892AL	13-5020	729	4515XW31	L4515X-XK3HD
13-3012R	891AR	13-6002	654	4524ML	L4524M
13-3013L	889L	13-6003	715	4524ML30	L4524M-MF2
13-3013R	888R	13-6008	411	4524QL	L4524Q
13-3016L	913L	13-6521	800	4524QL00	L4524Q-QK1HD
13-3016R	912R	13-6522	801	4702Q00	RF-5
13-3026L	988L	13-6523	802	4702W	L4702Q
13-3026R	988R	13-6581	807	4702W00	L4702Q-RF5
13-3028L	896L	13-6582	808	4707M	L4707Q-20
13-3028R	896R	13-6583	809	4707M30	L4707Q-20-QK1HD
13-3029L	897L	13-7150	9018-2	4707M31	L4707-QK1HD
13-3029R	897R	13-7151	9018-1	4707W	L4707
13-3034L	978L	13-7154	9042-1	47092W	L4709N
13-3034R	978R	13-7156	9024-1	47092W02	L4709N-ES2
13-3050	881M	13-8003	149	431101	EK-1HD
13-3052	333B	13-8004	716	470901	ES-1
13-3054L	995L	13-8006	716S	470902	ES-2
13-3054R	995R	329-104UK	44130U	470999	ES-12
13-3055L	996L	334-166	B556	SLN-105	073
13-3055R	996R	334-475	B8662	SLN-105	806
13-3057	920	1308E00	EF-1	SLN-107	B429
13-3058	921	1308EW	L1308E	SLW-100	B428
13-3130L	306L	1308EW00	L1308E-EF1		
13-3130R	306R	1308Q00	RF-3		
13-3131L	304L	1308Q02	RF-3A		
13-3131R	304R	1308QW	L1308Q		

INTERCHANGES

BENDIX	SIRCO	BINKLEY	SIRCO	BUDD	SIRCO
065164	SA2164	PP0011-44	SH1064	10708	708AR
065167	SA2167	PP0012-36	SB1006	10709	709AL
065170	SA2170	PP0012-37	SH1027	13096	095
065172	SA2172	PP0016-67	SH1063	13097	096
065174	SA2174	PP0050-73	SB1002	13988	988
065175	SA2175	PP0050-75	SB1005	13989	989
065176	SA2175	PP0054-02	SB1004	13990	990
065178	SA2178	PP0054-05	SB1001	13991	991
065179	SA2179	SP0049	SH1023	16271	271
104623	FF-1S	SP0075-02	8R343123	16272	272
104624	FR-1S	SP0075-05	8R343123	17123	124
104627	FF-1	SP0075-06	8R343186	17124	125
104628	FR-1	SP0075-08	8R343186	19004	004
107158	S2008	SP0099	SH1032	19005	005
228790	S2000	SP0100	SB1009	35336	896R
275491	A5491	SP0110	SB1010	35337	896L
278010	S2021A	SP0120	SB1011	37888	888R
278084	S2025	SP0123	SB1007	37889	889L
278302	S2026	SP0131	SB1000	37891	891AR
278321	S2020A	SP0136	SH1030	37892	892AL
278323	S2010A	SP0143	SB1008	49851	851
283411	S2012A	XB-SPN-053-37	AS7555	49852	852
286965	S2022A			59066	066
288753	S2019A			59067	067
2251254	B138			59183	183
2251797	B137			59184	184
2251804	B136			59191	191
2258191	B144			59192	192
2258196	B142			59263	263
2258199	B141			59264	264
2258200	B143			59373	373
2260285	B139			59374	374
2261362	B140			59375	375
				59376	376
				61968	968
				61969	969
				69912	912R
				69913	913L
				84097	097
				84098	098
				88013	897R
				88014	897L
				100145	948
				100146	947
				106216	335
				106333	333B
				106377	334
				106397	336

INTERCHANGES

BWP	SIRCO	BWP	SIRCO	BWP	SIRCO
M-3	123	M-452	S2021A	M-597	B586
M-4	235	M-457	S2020A	M-602	B500
M-8	993	M-458	A2400	M-612	B152
M-27	399	M-459	A3000	M-613	B499
M-30B	729	M-463	DT20	M-618	B311
M-38	654	M-464	DT24	M-620	B251
M-39	715	M-466	DT30	M-622	B832
M-43	149	M-474	S2012A	M-626	BP-104
M-45	716	M-475	S2025	M-638	S2011A
M-48	096	M-477L	C411L	M-641	B901
M-49	095	M-477R	C410R	M-641A	B501
M-50	988	M-478L	C423L	M-642	B011
M-51	989	M-478R	C422R	M-644	B151
M-52	990	M-479L	C421L	M-645	B379
M-53	991	M-479R	C420R	M-647	B932
M-54	004	M-498	A1012	M-648	B861
M-55	005	M-499	A1015	M-682	5210
M-56	124	M-534F	583X	M-683	5300
M-57	125	M-534G	635X	M-684	5200
M-60	271	M-534H	636X	M-698	700
M-61	272	M-534J	628X	M-719	B8611
M-74	191	M-536	634X	M-741	B495
M-75	192	M-538	B211	M-742	B595
M-76	263	M-548	B971	M-743L	C148L
M-77	264	M-549	B974	M-743R	C147R
M-78	968	M-561L	C687L	M-744L	C095L
M-79	969	M-561R	C686R	M-744R	C094R
M-80	851	M-562L	C425L	M-746L	C717L
M-81	852	M-562R	C424R	M-746R	C716R
M-82	183	M-563L	C563L	M-747	B888
M-83	184	M-563R	C564R	M-748	B988
M-88	438	M-566L	C101L	M-767	9009G
M-89	439	M-566R	C100R	M-770	702
M-124	888R	M-567L	C688L	M-771	B887
M-125	889L	M-567R	C689R	M-782	B424
M-126	891AR	M-571	B8600	M-787	B425
M-127	892AL	M-571A	B8601	M-790	B426
M-128	708AR	M-571B	B8602	M-791	B427
M-129	709AL	M-572	B8603	M-792	B728
M-130	896R	M-579	B8604	M-823	BP-100
M-131	896L	M-580	B8605	M-824	B8612
M-132	897R	M-582	B8606	M-824A	B8612A
M-133	897L	M-583	B8607	M-825	B8613
M-166	912R	M-584	B8608	M-826	B8614
M-167	913L	M-587A	B8609	M-837	9018-2
M-215	SR1020	M-588	B8610	M-843	B428
M-312	9004	M-592	B052	M-844	B769
M-313A	A1450	M-592A	B055	M-847	B8615
M-313B	A1452	M-594	B133	M-850	B955
M-313C	A1451	M-596	B941	M-989L	C707L
M-434	S2010A	M-596A	B611	M-989R	C706R

INTERCHANGES

BWP	SIRCO	BWP	SIRCO	BWP	SIRCO
M-990L	C441L	M-1121	098	M-1423	B220
M-990R	C442R	M-1122	853	M-1424	B302
M-991L	C443L	M-1123	708	M-1426	B377
M-991R	C444R	M-1124	053	M-1428	B498
M-992L	C445L	M-1127	236	M-1430	5403
M-992R	C446R	M-1134	267	M-1433	B161
M-993L	C447L	M-1141	256	M-1449	SB1004
M-993R	C448R	M-1142	257	M-1451	SH1012
M-994L	C449L	M-1173	544	M-1452	SH1008
M-994R	C450R	M-1175	238	M-1453	SH1009
M-995L	C451L	M-1176	373	M-1454	SH1010
M-995R	C452R	M-1177	374	M-1455	SH1011
M-996L	C479L	M-1183	314	M-1490	8R343186
M-996R	C478R	M-1188	515	M-1492	5R783146
M-997L	C774L	M-1189	545	M-1493	5R783186
M-997R	C773R	M-1191	SH1084	M-1494	5R785146
M-998L	C709L	M-1192	SH1082	M-1497	5R783166
M-998R	C708R	M-1193	SH1064	M-1498	8R344186
M-999	B8616	M-1194	SH1039	M-1499	5R783123
M-1003	B216	M-1195	SH1086	M-1500	B423
M-1005	B132	M-1196	SH1087	M-1505	B8634
M-1007	B392	M-1197	SH1080	M-1507	B256
M-1008	B380	M-1198	SH1081	M-1520	B8635
M-1009	B307	M-1199	SH1083	M-1521	B8696
M-1014	B981	M-1212	482	M-1523	B793
M-1015L	C795L	M-1213	481	M-1550	B8636
M-1015R	C794R	M-1242	138	M-1551	B667
M-1016	B362	M-1243	110	M-1553	B8735
M-1045	B8619	M-1249	233	M-1554	B8714
M-1046	B8622	M-1282	008	M-1556	B8733
M-1047	B8623	M-1288	414	M-1558	B358
M-1048	B8734	M-1289	415	M-1570L	C711L
M-1049	B8620	M-1382	S2000	M-1570R	C710R
M-1050	5401	M-1400	B8665	M-1571L	C776L
M-1051	5402	M-1401	B8625	M-1571R	C775R
M-1052	9013	M-1401A	B8764	M-1572	B8713
M-1054	B054	M-1402A	B960	M-1589	B8697
M-1055	B868	M-1403	B8626	M-1636	999X
M-1056	B869	M-1404	B8627	M-1647	ST1009
M-1058	B8624	M-1405	B8628	M-1648	ST1019
M-1065	9014	M-1406	B8661	M-1670	SR1000
M-1066	9015	M-1407	B8660	M-1681	SH1095
M-1068	5660	M-1408	B8629	M-1689	SB1001
M-1093	B8621	M-1409	B8630	M-1690	ST1000
M-1102	411	M-1412	B8631	M-1691	ST1004
M-1105	302	M-1413	B8632	M-1692	ST1017
M-1110	066	M-1414	B8662	M-1693	ST1002
M-1111	067	M-1415	B8663	M-1694	ST1003
M-1112	375	M-1416	B8664	M-1695	SB1007
M-1113	376	M-1421N	L4515Q	M-1695	SB1007
M-1120	097	M-1422	B120	M-1696	ST1005

INTERCHANGES

BWP	SIRCO	BWP	SIRCO	BWP	SIRCO
M-1697	ST1006	M-2435	448	M-2627	B8736
M-1698	ST1007	M-2436	412	M-2630	B8755
M-1699	ST1008	M-2437	413	M-2632	B717
M-1718	SR1008	M-2438	287R	M-2634	B8718
M-1719	SR1002	M-2439	287L	M-2635	B8759
M-1764	SR1010	M-2454	800	M-2637	B8757
M-1765	SR1007	M-2455	801	M-2638	B8719
M-1766	SR1009	M-2456	802	M-2639	B8758
M-1803	SF1009	M-2457	804	M-2640	B8756
M-1804	SF1010	M-2458	805	M-2641	B230
M-1805	SF1012	M-2459	073	M-2643	B811
M-1806	SF1002	M-2459	806	M-2645	B8717
M-1807	SF1003	M-2460	722	M-2648	B795
M-1808	SF1004	M-2461	725	M-2649	B8722
M-1809	SF1005	M-2548	B807	M-2686N	L4515X
M-1818	SF1011	M-2567	5300S	M-2706	B262
M-1888	SH1001	M-2577	S2019A	M-2712	B898
M-1889	B429	M-2594	B8727A	M-2713	B823
M-1940	5000	M-2595	B8728	M-2714	B556
M-1941	9012	M-2597L	C731L	M-2717	B154
M-1956	2296	M-2597R	C730R	M-2718	B134
M-1957	2298	M-2598L	C733L	M-2719	B923
M-1958	2297	M-2598R	C732R	M-2720	ARK
M-1959	2299	M-2599L	C735L	M-2721	B829
M-1978	2305	M-2599R	C734R	M-2722	B922
M-1979	2304	M-2600L	C693L	M-2724	B725
M-1980	2303	M-2600R	C694R	M-2725	B053
M-2126	SH1055	M-2601L	C797L	M-2727	B135
M-2136	SH1016	M-2601R	C796R	M-2728	B308
M-2141	SH1041	M-2604L	C721L	M-2729	B579
M-2142	SH1043	M-2604R	C720R	M-2732	B349
M-2143	SH1042	M-2605L	C896L	M-2733	B983
M-2144	SH1029	M-2605R	C897R	M-2737	B870
M-2146	SH1021	M-2606L	C894L	M-2738	B770
M-2147	SH1025	M-2606R	C895R	M-2739	B972
M-2148	SH1030	M-2607L	C729L	M-2740	B982
M-2149	SH1032	M-2607R	C728R	M-2742	B973
M-2150	SF1000	M-2612L	C727L	M-2746	B871
M-2151	SF1007	M-2612R	C726R	M-2748	B277
M-2152	SF1008	M-2613L	C349L	M-2764	9016
M-2159	SH1040	M-2613R	C350R	M-2768	9018-1
M-2160	SH1026	M-2614L	C351L	M-2772	9008-1
M-2161	SH1027	M-2614R	C352R	M-2774	9009
M-2204	B911	M-2615L	C800L	M-2796	5R7835146
M-2400	988R	M-2615R	C799R	M-2797	5R7835186
M-2401	988L	M-2616L	C787L	M-2798	5R785186
M-2404	012	M-2616R	C786R	M-2808	SR1006
M-2405	011	M-2618	B8754	M-2811	SR1004
M-2420	204	M-2621	B8698	M-2819	SR1016
M-2421	205	M-2622	B8699	M-2854	SH1063
M-2434	447	M-2623	B8688	M-2868	SH1031

INTERCHANGES

BWP	SIRCO	BWP	SIRCO	BWP	SIRCO
M-2869	SF1006	M-3134R	C513R	M-3180L	C861L
M-2870	SF1013	M-3135L	C927L	M-3180R	C862R
M-2872	SH1023	M-3135R	C928R	M-3181L	C703L
M-2884	SF1001	M-3136L	C724L	M-3181R	C702R
M-2936	SR1001	M-3136R	C725R	M-3183L	C719L
M-2941	SR1011	M-3137L	C890L	M-3183R	C718R
M-2973	SH1057	M-3137R	C891R	M-3184L	C888L
M-2975	SH1044	M-3138L	C972L	M-3184R	C889R
M-3108L	C645L	M-3138R	C973R	M-3186L	C856L
M-3108R	C646R	M-3140L	C520L	M-3186R	C857R
M-3109L	C427L	M-3140R	C521R	M-3187L	C518L
M-3109R	C426R	M-3141L	C737L	M-3187R	C519R
M-3111L	C524L	M-3141R	C738R	M-3188L	C098L
M-3111R	C522R	M-3142L	C526L	M-3188R	C099R
M-3112L	C537L	M-3142R	C527R	M-3200	334
M-3112R	C536R	M-3143L	C494L	M-3201	335
M-3113L	C665L	M-3143R	C495R	M-3202	336
M-3113R	C666R	M-3144L	C496L	M-3203	333B
M-3114L	C595L	M-3144R	C497R	M-3204	882
M-3114R	C594R	M-3145L	C514L	M-3205	883
M-3115L	C085L	M-3145R	C515R	M-3206	884
M-3115R	C086R	M-3147L	C935L	M-3207	881M
M-3116L	C083L	M-3147R	C936R	M-3208	995R
M-3116R	C084R	M-3148L	C742L	M-3209	995L
M-3117L	C185L	M-3148R	C743R	M-3210	996R
M-3117R	C186R	M-3169L	C102L	M-3211	996L
M-3121L	C898L	M-3169R	C103R	M-3213	251
M-3121R	C899R	M-3170L	C441BL	M-3214	201
M-3122L	C750L	M-3170L	C867L	M-3215	164
M-3122R	C751R	M-3170R	C442BR	M-3216	162
M-3123L	C752L	M-3170R	C866R	M-3217	160
M-3123R	C753R	M-3171L	C443BL	M-3218	449
M-3124L	C754L	M-3171L	C871L	M-3219	450
M-3124R	C755R	M-3171R	C444BR	M-3236	B8761
M-3125L	C763L	M-3171R	C870R	M-3237	B8760
M-3125R	C764R	M-3172L	C445BL	M-3238	B217
M-3127L	C769L	M-3172L	C868L	M-3239	B218
M-3127R	C770R	M-3172R	C446BR	M-3240	B8763
M-3128L	C492L	M-3172R	C869R	M-3241	133
M-3128R	C493R	M-3173L	C884L	M-3242	134
M-3129L	C490L	M-3173R	C885R	M-3243	B924
M-3129R	C491R	M-3174L	C723L	M-3245	B221
M-3130L	C057L	M-3174R	C722R	M-3246	B122
M-3130R	C058R	M-3175L	C854L	M-3247	B8782
M-3131L	C059L	M-3175R	C855R	M-3248	B8787
M-3131R	C060R	M-3176L	C886L	M-3249	B139
M-3132L	C516L	M-3176R	C887R	M-3250	B140
M-3132R	C517R	M-3178L	C413L	M-3251	B142
M-3133L	C611L	M-3178R	C412R	M-3252	B143
M-3133R	C612R	M-3179L	C347L	M-3253	B138
M-3134L	C512L	M-3179R	C348R	M-3254	B136

INTERCHANGES

BWP	SIRCO	BWP	SIRCO	BWP	SIRCO
M-3255	B137	M-3489	SH1038	M-3776	A1443
M-3256	B141	M-3491	B434	M-3777	9004R
M-3257	B144	M-3492	SA22953	M-3778	9004B
M-3260	B956	M-3493	SA21953	M-3789L	C759L
M-3261	B942	M-3496	B8691	M-3789R	C760R
M-3266	366	M-3497	B348	M-3796L	C905L
M-3267	367	M-3498	B433	M-3796R	C906R
M-3345	B999	M-3608	948	M-3798L	C603L
M-3346	B562	M-3609	947	M-3798R	C602R
M-3349	B8689	M-3610	420	M-3799L	C605L
M-3351	B8750	M-3611	421	M-3799R	C604R
M-3352	B8751	M-3612	424	M-3824	44132U
M-3353	B8752	M-3613	425	M-3979	920
M-3354	B8753	M-3614	418	M-3980	304R
M-3355	B950	M-3615	419	M-3981	304L
M-3356	B952	M-3616	428	M-3982	306R
M-3357	B953	M-3617	429	M-3983	306L
M-3358	B951	M-3618	430	M-3984	S2024
M-3359	B954	M-3619	431	M-3985	B800
M-3360	B430K	M-3626	416	M-3986	B801
M-3361	B431	M-3627	417	M-3987	B436
M-3362	B432A	M-3652	432	M-3998	9004P
M-3363	SA24100	M-3653	433	M-4000L	C653L
M-3365	SA25100	M-3654	434	M-4000R	C654R
M-3367	SA21103	M-3655	435	M-4001L	C655L
M-3368	SA22103	M-3659	436	M-4001R	C656R
M-3369	SA21102	M-3661	452	M-4002L	C657L
M-3370	SA22102	M-3662	453	M-4002R	C658R
M-3371	SA23106	M-3663	437	M-4003L	C663L
M-3373	S2022A	M-3666	423	M-4003R	C664R
M-3374	S2023	M-3667	676	M-4004L	C667L
M-3375	S2026	M-3669	422	M-4004R	C668R
M-3386	S2002	M-3677	451	M-4005L	C669L
M-3398	B8634A	M-3683L	C675L	M-4005R	C670R
M-3403	SR1012	M-3683R	C676R	M-4006L	C569L
M-3404	SR1013	M-3684L	C679L	M-4006R	C568R
M-3405	SR1014	M-3684R	C680R	M-4007L	C677L
M-3406	SR1015	M-3685L	C681L	M-4007R	C678R
M-3432	SR1003	M-3685R	C682R	M-4008L	C683L
M-3434	SR1005	M-3696L	C931L	M-4008R	C684R
M-3440	ST1018	M-3696R	C932R	M-4009L	C609L
M-3443	ST1010	M-3697L	C933L	M-4009R	C608R
M-3444	ST1011	M-3697R	C934R	M-4010L	C441BL
M-3445	ST1012	M-3698L	C312L	M-4010R	C442BR
M-3447	ST1014	M-3698R	C313R	M-4011L	C443BL
M-3482	SH1048	M-3699L	C910L	M-4011R	C444BR
M-3482C	SH1050	M-3699R	C911R	M-4012L	C445BL
M-3483	SH1049	M-3707	ST1001	M-4012R	C446BR
M-3484	SH1054	M-3747	B805	M-4013L	C310L
M-3487	SH1036	M-3748	B8606A	M-4013R	C311R
M-3488	SH1037	M-3775	A1442	M-4014L	C314L

INTERCHANGES

BWP	SIRCO	BWP	SIRCO	BWP	SIRCO
M-4014R	C315R	M-4073R	C757R	M-4114	B434S
M-4015L	C528L	M-4074L	C761L	M-4115	919
M-4015R	C529R	M-4074R	C762R	M-4129	SB1000
M-4016L	C530L	M-4075L	C703BL	M-4130	SB1009
M-4016R	C531R	M-4075R	C702BR	M-4131	SB1010
M-4017L	C055L	M-4076L	C709BL	M-4132	SB1011
M-4017R	C056R	M-4076R	C708BR	M-4133	SF1014
M-4018L	C707BL	M-4077L	C880L	M-4134	SF1015
M-4018R	C706BR	M-4077R	C881R	M-4135	SF1016
M-4019L	C479BL	M-4078L	C711BL	M-4136	SF1017
M-4019R	C478BR	M-4078R	C710BR	M-4137	SF1018
M-4020L	C774CL	M-4079L	C715AL	M-4138	SF1020
M-4020R	C773CR	M-4079R	C714AR	M-4139	SF1021
M-4021L	C148CL	M-4080L	C413AL	M-4140	SF1022
M-4021R	C147CR	M-4080R	C412AR	M-4141	SF1019
M-4022L	C217L	M-4081L	C499L	M-4142	SH1033
M-4022R	C218R	M-4081R	C500R	M-4143	SH1034
M-4023L	C219L	M-4082L	C647L	M-4144	SH1059
M-4023R	C220R	M-4082R	C648R	M-4145	SH1035
M-4025L	C425AL	M-4083L	C651L	M-4146	SH1060
M-4025R	C424AR	M-4083R	C652R	M-4147	ST1013L
M-4026L	C882L	M-4084L	C504L	M-4148	ST1013R
M-4026R	C883R	M-4084R	C505R	M-4149	ST1015L
M-4027L	C892L	M-4090L	C691L	M-4150	ST1015R
M-4027R	C893R	M-4090R	C690R	M-4171	CT375
M-4031L	C607L	M-4091L	C089L	M-4172	CT332
M-4031R	C606R	M-4091R	C090R	M-4173	CT333
M-4032L	C451AL	M-4092L	C447AL	M-4175	CT370
M-4032R	C452AR	M-4092R	C448AR	M-4176	CT360
M-4033	5R783156	M-4093L	C449AL	M-4177	CT334
M-4034	8R783123	M-4093R	C450AR	M-4178	CT312
M-4035	8R783166	M-4094L	C091L	M-4214	333SN6
M-4036	8R783176	M-4094R	C092R	M-4215	333SN19
M-4037	8R783186	M-4095L	C087L	M-4216	333SN28
M-4043	SA1041	M-4095R	C088R	M-4217	333SN39
M-4044	SA1042	M-4096L	C081L	M-K2	TK-4HD
M-4046	SA1073	M-4096R	C082R	M-K3	TK-1HD
M-4047	SA1074	M-4097L	C096L	M-K4	TK-1HD
M-4056	SA10144	M-4097R	C097R	M-K5	FK-2HD
M-4057	SA10102	M-4099L	C532L	M-K6	EK-3
M-4058	SA10103	M-4099R	C533R	M-K7	TK-4HD
M-4059	SA10100	M-4101L	C740L	M-K8	FK-1HD
M-4060	SA10101	M-4101R	C741R	M-K10	EK-1HD
M-4061	SA10306	M-4106	B595S	M-K12	LB-1
M-4062	SA10305	M-4107	B495S	M-K13	B8643
M-4063	SA10215	M-4108	B888S	M-K14	B8681
M-4064	SA10216	M-4109	B888D	M-K15	B8644
M-4065	SA10211	M-4110	BP-106	M-K16	B8645
M-4066	SA10212	M-4111	B350	M-K17	B8646
M-4067	SA10214	M-4112	B347	M-K18	B8647
M-4073L	C756L	M-4113	B957	M-K19	B8648

INTERCHANGES

BWP	SIRCO	BWP	SIRCO	CONTITECH	SIRCO
M-K20	B8649	M-K98	RF-5	64254	AS8050
M-K21	B8650	M-K99	EK-1HD	64255	AS9422
M-K22	B8651	M-K101	B8687	64256	AS9616
M-K23	B8652	M-K102	B8655Z	64258	AS9010
M-K24	B8653	M-K104	LB-7	64259	AS9219
M-K25	B8682	M-K105	ES-2	64260	AS9039
M-K26	B8655	M-K106	MF-2	64263	AS9648
M-K27	B8656	M-K107	B8790	64264	AS9375
M-K39	QK-1HD	M-K108	LB-10	64266	AS9781
M-K41	XK-1HD	M-K109	LB-11	64267	AS6910
M-K42	XK-3HD	M-K111	B8792	64268	AS7410
M-K42XHD	XK-3HD	M-K112	LB-3D	64269	AS9082
M-K45	LB-3	M-K113	EF-2	64272	AS9121
M-K46	LB-4	M-K114	ES-3	64273	AS9122
M-K47	LB-5	M-K115	ES-4	64274	AS9069
M-K50	WF-1	M-K116	B8793	64276	AS9466
M-K52	RF-1ARK	M-K117	LB-12	64277	AS9287
M-K54	MK-1HD	M-K118	LB-10D	64278	AS9923
M-K56	TK-7HD	M-K119	FF-1S	64279	AS9101
M-K58	EK-2	M-K120	SF-1	64281	AS9394
M-K59	RK-1	M-K121	FR-1S	64284	AS7555
M-K60	B8712	M-K122	ES-5	64285	AS8018
M-K61	B8683	M-K123	K-2	64287	AS9270
M-K62	B8657	M-K124	ES-12	64288	AS9265
M-K63	B8684	M-K125	K-1	64290	AS9371
M-K64	B8685Z	M-K130	EX-1	64291	AS9321
M-K65	B8686	M-K131	EQ-1	64306	AS9026
M-K68	B8743	M-K132	ET-1	64308	AS9213
M-K69	RC-1	M-K133	TK-4MPHD	64312	AS8829
M-K72	QK-1HD	M-K134	B8805	64323	AS9192
M-K77	EF-1	ZE9133	S2007	64329	AS9243
M-K78	B8742			64336	AS9373
M-K79	RF-3			64339	AS8852
M-K79B	RF-3A			64367	AS9387
M-K80	LB-2			64383	AS9370
M-K81	B8707			64386	AS9295
M-K83	LB-6			64388	AS9293
M-K84	ES-1			64394	AS9580
M-K85	B8747			64395	AS9640
M-K86	B8746			64397	AS8755
M-K87	B8744			64401	AS8944
M-K88	B8773M			64402	AS9921
M-K89	B8772M			64405	AS9936
M-K90	B8788			64412	AS9935
M-K91	XL-1			64413	AS9647
M-K92	MF-1			64419	AS8749
M-K93	MK-2HD			64420	AS8729
M-K94	FF-1			64421	AS8091
M-K95	FR-1			64439	AS9307
M-K96	B8795			64456	AS8204
M-K97	B8796			64459	AS9366

INTERCHANGES

CONTITECH	SIRCO	CONTITECH	SIRCO	CR	SIRCO
64488	AS7403	9 10-17.5 P 548	AS9935	35066	SS382-8036
64503	AS7818	9 10-19 P 315	AS9101	35066	SS35066
64504	AS7798	9 10-19 P 383	AS9394	35066	SS370001
64509	AS6902	9 10-19 P 384	AS9243	38780	SS38780
64510	AS6905	9 10-19 P 435	AS9265	42623	SS42623
64517	AS6897	9 10-19 P 472	AS8852	42623	SS370065
64543	AS7135	9 10-21 P 361	AS9321	46305	SS307-0743
64544	AS7140	9 10-21 P 448	AS9370	46305	SS372-7097
64545	AS7136	10 10B-13 S 513	AS8729	46305	SS373-0143
64560	AS8032	10 10-15 S 522	AS8755	46305	SS46300
64562	AS8008	10 10.5-15 P 460	AS8709	46305	SS46305
64571	AS8033	10 10-16 S 526	AS8708	46305	SS370025
64592	AS6808	10 10-16 S 533	AS8713	46305	SS755400
64602	AS7795	10 10-21 P 434	AS9580	47697	SS392-9131
64605	AS6799	11 10.5A-16 P 523	AS8091	47697	SS47692
64636	AS8713	11 10.5C-16 A 320	AS8050	47697	SS47697
64638	AS8708	11 10.5-17 A 317	AS9121	47697	SS370003
64645	AS8709	11 10.5-21 A 313	AS8792	47697	SS761400
64692	AS9626	FD 200-19 310	AS6902		
64697	AS9619	FD 200-19 315	AS6905		
64716	AS9367	FD 200-19 320	AS6910		
65367	AS9622	FD 200-19 505	AS6897		
65389	AS9625	FD 200-22 524	AS7795		
65990	AS8813	FD 330-22 318	AS7403		
66109	AS9547	FD 330-22 331	AS7410		
9 9-9 S 537	AS9622	FD 331-26 480	AS7555		
9 9-12 P 314	AS9422	FD 530-22 311	AS7135		
9 9-12 P 479	AS9387	FD 530-22 316	AS7140		
9 9-12 P 515	AS9616	SC29-O001	AS7001		
9 9K-15 P 417	AS9295	SC29-O046	AS7074		
9 9K-15 P 424	AS9293	SC29-W087	AS7087		
9 9B-22 P 741	AS9619	SC29-Y036	AS7036		
9 10-10 P 311	AS9039	SC29-Y108	AS7108		
9 10-10 P 471	AS9307	SC31-W206	AS7206		
9 10-12 A 427	AS9640	SC31-Y205	AS7205		
9 10-12 A 488	AS9366	SC31-Y215	AS7215		
9 10-12 P 484	AS8204				
9 10-13.5 S 433	AS9270				
9 10-14 P 312	AS9069				
9 10-14 P 577	AS8813				
9 10S-16 A 382	AS9780				
9 10-16 P 310	AS9082				
9 10-16 P 410	AS9466				
9 10-16 P 441	AS9213				
9 10-16 P 449	AS8829				
9 10-17.5 P 436	AS8944				
9 10-17.5 P 440	AS9373				
9 10-17.5 P 443	AS9921				
9 10-17.5 P 451	AS9375				
9 10-17.5 P 456	AS9648				
9 10-17.5 P 521	AS9371				

INTERCHANGES

CR PLUS	SIRCO	DAYTON	SIRCO	DAYTON	SIRCO
35058	SS382-8036	08-005149	149	334-316	ST1006
35058	SS35066	08-005715	715	334-317	ST1004
35058	SS370001	08-005716	716	334-319	SH1027
42627	SS42623	08-006654	654	334-341	SH1012
42627	SS370065	08-204734	411	334-343	SH1057
46300	SS307-0743	09-006256	256	334-344	SH1040
46300	SS372-7097	09-006257	257	334-359	SH1026
46300	SS373-0143	09-006302	302	334-360	SH1010
46300	SS46300	09-007295	729	334-361	SH1046
46300	SS46305	09-612317	123	334-362	SH1045
46300	SS370025	09-623517	235	334-366	SH1009
46300	SS755400	09-699317	993	334-373	ST1008
47691	SS392-9131	09-705317	053	334-375	SH1055
47691	SS370003	09-839910	399	334-447	SH1062
47691	SS761400	09-870817	708	334-452A	SF1002
47692	SS392-9131	09-885310	853	334-453A	SF1003
47692	SS47692	13-1559	402	334-454	SF1006
47692	SS47697	13-1587	366	334-455	SF1005
47692	SS370003	13-1589	367	334-565	SF1009
47692	SS761400	321-145	SR1008	334-566	SF1010
		321-145U	SR1008U	334-568	SF1012
		321-146	SR1002	334-628	ST1002
		321-146U	SR1002U	334-639	SH1044
		321-153	SB1004	334-672	SF1019
		321-153U	SB1004U	334-739	SH1054
		321-175	SH1001	334-825	SB1015
		321-175U	SH1001U	334-826	SB1014
		321-176	SH1008	334-827	SB1016
		321-176U	SH1008U	334-937	SH1061
		321-177	SF1011	334-1026	ST1007
		321-177U	SF1011U	334-1272	SH1053
		321-190	SF1004	338-199	SR1000
		321-190U	SF1004U	338-373	ST1010
		321-194	ST1003	338-374	ST1011
		321-221	SH1049	338-375	ST1012
		321-221U	SH1049U	338-376	ST1019
		321-268	SB1001	338-378	ST1000
		329-104U	44132U	338-382	ST1017
		334-144	804	338-408	SH1025
		334-150	SH1016	338-409	SH1031
		334-153	SR1011	338-415	SH1032
		334-166	802W	338-419	SH1021
		334-201	SR1016	338-419I	SH1021
		334-203	SR1009	338-451	SH1033
		334-205	SR1010	338-452	SH1036
		334-207	SR1003	338-453	SH1034
		334-208	SR1004	338-454	SH1037
		334-209	SR1006	338-455	SH1035
		334-211	SR1001	338-456	SH1038
		334-252	SR1007	338-715	SF1000
		334-312	ST1009	338-871	ST1001

INTERCHANGES

DAYTON	SIRCO	DAYTON	SIRCO	DAYTON	SIRCO
338-884	SH1059	361-490	5R7835146	1R12-615	AS8829
338-885	SH1060	361-491	5R7835186	1R13-039	AS9121
338-886	SH1048	361-492	5R783166	1R13-118	AS9580
338-887	SH1050	361-509	8R785186	1R13-119	AS9270
338-1096	SF1001	361-558	8R785166	1R13-124	AS8755
338-1100	SF1020	361-559	8R785136	1R13-130	AS8729
338-1101	SF1021	361-566	8R783136	1R13-153	AS8749
338-1102	SF1022	361-577	5R783136	1R13-159	AS8709
338-1107	SF1014	361-584	5R783156	1R13-176	AS8713
338-1108	SF1015	361-585	5R783176	1R13-177	AS8708
338-1109	SF1016	361-587	5R785186	1R14-039	AS8050
338-1111	SF1017	361-589	8R783123	1R14-045	AS8792
338-1113	SF1018	361-609	8R783186	1R14-171	AS8091
338-1300	SB1009	64917-002	AS9647	2B9-200	AS6910
338-1302	SB1010	1R10-120	AS9293	2B9-206	AS6905
338-1304	SB1011	1R11-028	AS9422	2B9-229	AS6897
338-1306	SB1000	1R11-166	AS9295	2B9-239	AS6902
338-1367	SH1030	1R11-203	AS9387	2B10-226	AS7795
338-1409	ST1013L	1R11-222	AS9625	2B12-307	AS7403
338-1410	ST1013R	1R11-242	AS9616	2B12-406	AS7410
338-1411	ST1014	1R12-069	AS9069	2B12-440	AS7555
338-1412	ST1015L	1R12-090	AS9213	2B14-356	AS7136
338-1413	ST1015R	1R12-092	AS9082	2B14-360	AS7135
338-1817	ST1018	1R12-095	AS9039	2B14-476	AS6799
345-105	SR1013	1R12-103	AS9101	3B12-303	AS8018
345-110	SR1014	1R12-167	AS9192	3B12-312	AS8033
345-112	SR1015	1R12-182	AS9219	3B12-319	AS8032
345-134	SB1008	1R12-256	AS9367	3B14-356	AS7798
345-157	SB1007	1R12-279	AS9394	3B14-359	AS7818
345-158	ST1005	1R12-303 (PI)	AS9780	CBN-385	SR1020
345-164	SH1042	1R12-335	AS9321	DN-12	SH1080
345-164I	SH1042	1R12-366	AS8944	DN-34	SH1064
345-167	SH1029	1R12-367	AS9640	DN-34A	SH1064H
345-167I	SH1029	1R12-375	AS9265	DN-38	SH1086
345-191	SH1043	1R12-401	AS9371	DN-58	SH1082
345-199	SR1012	1R12-403	AS9373	DN-78	SH1039
345-201	SF1007	1R12-404	AS9375	DN-78A	SH1039H
345-202	SF1008	1R12-435	AS9307	DN-100	SH1083
345-238	SH1041	1R12-480	AS9243	DN-100A	SH1083H
361-168	8R783166	1R12-481	AS9923	DN-118	SH1084
361-182	8R344186	1R12-487	AS9366	DN-125	SH1085
361-218	5R783146	1R12-499	AS9936	DN-716	SH1087
361-248	5R783123	1R12-502	AS9921	DN-916	SH1081
361-250	5R783186	1R12-503	AS9370	GL-294	SH1023
361-252	5R785146	1R12-508	AS8204	S-23720	AS9626
361-254	8R785146	1R12-532	AS9935	SFW-125	SF1013
361-258	8R785123	1R12-538	AS9648	SLN-104	804
361-262	8R343186	1R12-567	AS9026	SLN-104	SH1011
361-350	8R783156	1R12-568	AS8852	SLN-107	SR1011
361-374	8R783146	1R12-580	AS9370	SLNC-105	805
361-469	8R343123	1R12-603 (AI)	AS9781	SLW-12	SR1019

INTERCHANGES

DAYTON	SIRCO	DEXTER	SIRCO	EATON	SIRCO
SLW-34	SR1005	K71-98	LB-1	23570	B8630
SUW-12	SH1092	K71-460-00	LB-3D	35428	B8629
SUW-34	SH1063			35430	C055L
SUW-58	800W			35431	C056R
SUW-58	SH1094			39074	B052
SUW-100	SH1095			39075	B152
SUW-118	SH1096			70306	C776L
SUW-125	SH1097			70307	C775R
SUW-716	SH1091			70308	C886L
SUW-916	SH1093			70309	C887R
TRA-693I	SF693			70326	B769
TRA-2726E	SH2726			71306	C787L
TRA-2727I	SH2727			71307	C786R
TRA-2728I	SH2728			78500	B8648
				78580	B981
				79903	B8612A
				82006	B8609
				125042	C723L
				125043	C722R
				127808	B8746
				314146	EF-2
				314147	ES-2
				804017	B8722
				806234	B430K
				806380	B8763
				806526	C492L
				806527	C493R
				806654	C496L
				806655	C497R
				807286	C693L
				807287	C694R
				807304	C721L
				807305	C720R
				808058	B431
				808068	C740L
				808069	C741R
				808078	C494L
				808079	C495R
				808290	C769L
				808291	C770R
				808330	ES-1
				808708	C490L
				808709	C491R
				810025	C059L
				810026	C060R
				810292	B350
				810538	C057L
				810539	C058R
				812992	B436
				815626	ES-4
				817017	B433

INTERCHANGES

EATON	SIRCO	EUCLID	SIRCO	EUCLID	SIRCO
818278	B432A	KIT 4S	TK-1	E-688A	C690R
819725	B434	KIT 4SHD	TK-1HD	E-689A	C691L
820165	B425	KIT 5	FK-2	E-700	700
820276	B426	E-03009	9018-2	E-702	702
821231	B428	E-04000	9015	E-719	B8611
821616	B429	E-04000V	9015V	E-747	B423
823141	ES-3	E-04075	9013	E-757	B256
1000087	C800L	E-04075H	9016	E-759	B8602
1000088	C799R	E-04075V	9013V	E-781	B611
1000091	B982	E-05500	9014	E-795	B055
1000092	B770	E-500	B500	E-801	B793
1000406	B983	E-501	B499	E-807	B807
1000839	C888L	E-502	B311	E-844	5000
1000840	C889R	E-512	B251	E-907	SR1010
1001238	EK-1HD	E-523	B941	E-910	B8634
1002262	B8688	E-526	B8604	E-919	B595S
1002279	B8625	E-527	B379	E-920	B495
1003831	B053	E-535	B8603	E-920S	B495S
1003832	B154	E-536	B8600	E-927	SF1011
1003999	B999	E-537	B901	E-934	SH1001
1005006	EK-2	E-539	B151	E-937	B429
1005202	B8752	E-540	5210	E-940BK	S2020A
1005203	B8753	E-543	B974	E-943	B8635
1005846	B8751	E-545A	B971	E-975	9009G
1006562	B562	E-563	B011	E-999X	999X
1008047	B8793	E-564	B8610	E-1018	SF1010
1008220	B8750	E-572	5200	E-1019	SF1003
1008306	EF-1	E-573	5300	E-1020	SF1004
1008325	B8742	E-579A	B861	E-1021	SF1005
1008347	B8684	E-580	B8607	E-1023	SF1009
1008412	B8698	E-581	B8605	E-1024	SF1002
B1705	B424	E-583X	583X	E-1063HD	S2021A
B2010	B427	E-586	B586	E-1074	SF1012
B2028A	B8616	E-595	B052	E-1094	C094R
		E-596A	B152	E-1095	C095L
		E-603	B8713	E-1112A	B887
		E-609	B832	E-1113	B988
		E-612S	S2010A	E-1147B	C147R
		E-626	B932	E-1147C	C147CR
		E-628X	628X	E-1148B	C148L
		E-634X	634X	E-1148C	C148CL
		E-635X	635X	E-1159	SR1002
		E-636X	636X	E-1160	SR1008
		E-654	B8609	E-1166	SR1009
		E-656	B8608	E-1269	B501
		E-661	B8601	E-1271	B8614
		E-667	B667	E-1272	B8613
		E-684	C689R	E-1307	B8662
		E-685	C688L	E-1308	B8663
		E-686	C686R	E-1308E	EF-1
		E-687	C687L	E-1308Q	RF-3

INTERCHANGES

EUCLID	SIRCO	EUCLID	SIRCO	EUCLID	SIRCO
E-1308QMA	RF-3A	E-1782	B8629	E-2102	B8606
E-1308T	RF-1ARK	E-1816HD	TK-4MPHD	E-2103	B8733
E-1312A	SR1007	E-1816S	TK-4	E-2104	B8714
E-1314	B8621	E-1816SHD	TK-4HD	E-2121S	FK-1
E-1318A	B8696	E-1828	SR1011	E-2121SHD	FK-1HD
E-1318AHD	B8696HD	E-1880B	B728	E-2122	B8650
E-1319A	B8735	E-1887SHD	EK-1HD	E-2122-2	B8650A
E-1357A	B8643	E-1893	B888S	E-2123	B8647
E-1362	B888T	E-1893S	B888	E-2125	B8648
E-1385	B8616	E-1904	1904	E-2125-2	B8648A
E-1400	B427	E-1908	1908	E-2126	LB-4
E-1402	B426	E-1909	1909	E-2177	B911
E-1403	B424	E-1910	1910	E-2217A	B942
E-1406	B425	E-1912	1912	E-2218	B211S
E-1408	B8697	E-1913	1913	E-2237	5660
E-1410	C410R	E-1914	1914	E-2286	LB-5
E-1411	C411L	E-1915	1915	E-2287	B8652
E-1416	B8612	E-1917	1917	E-2287-2	B8652A
E-1416A	B8612A	E-1919	1919	E-2291	B8660
E-1418	B769	E-1920	1920	E-2296	2296
E-1420	C420R	E-1921	1921	E-2297	2297
E-1421	C421L	E-1922	1922	E-2298	2298
E-1422	C422R	E-1923	1923	E-2299	2299
E-1423	C423L	E-1925	1925	E-2303	2303
E-1424	C424R	E-1927	1927	E-2304	2304
E-1424A	C424AR	E-1943	804	E-2305	2305
E-1425	C425L	E-1971	SR1018	E-2361	B8636
E-1425A	C425AL	E-1972	SR1017	E-2363	B8644
E-1428A	B981	E-1974	SR1019	E-2365	B8717
E-1559	5403	E-1975	SR1016	E-2380	B8615
E-1561	5402	E-1980	SB1004	E-2382	B8645
E-1563	C563L	E-1986A	SR1004	E-2389	B362
E-1564	C564R	E-1987	SR1006	E-2390	B216
E-1565	B8619	E-1999A	SH1008	E-2391	B392
E-1567	B8620	E-2000	SH1009	E-2392	B380
E-1569	B8622	E-2001	SH1010	E-2395	B133
E-1571	B8623	E-2002	SH1011	E-2396	B132
E-1574S	S2012A	E-2003	SH1012	E-2398	B307
E-1577A	B8624	E-2086B	B8646	E-2399	B358
E-1581	B868	E-2086B-2	B8646A	E-2402HD	LB-1
E-1582	B054	E-2087	B8656	E-2404	B8631
E-1583	B869	E-2087-2	B8656A	E-2405	B8625
E-1597A	9012	E-2088A	B8681	E-2406	B8626
E-1607HD	TK-7HD	E-2088AHD	B8681HD	E-2407	B8628
E-1773B	C773R	E-2088AHD-2	B8681HDA	E-2408	B8627
E-1773C	C773CR	E-2089	B8657	E-2409	B8632
E-1774B	C774L	E-2090	B8649	E-2411A	B960
E-1774C	C774CL	E-2090-2	B8649A	E-2412	C412R
E-1775	C775R	E-2091	S2025	E-2412A	C412AR
E-1776	C776L	E-2099	C101L	E-2413	C413L
E-1781	B8630	E-2100	C100R	E-2413A	C413AL

INTERCHANGES

EUCLID	SIRCO	EUCLID	SIRCO	EUCLID	SIRCO
E-2441A	C441L	E-2679AHD	B8686HD	E-2840	SF1014
E-2441B	C441BL	E-2680	B8685Z	E-2842	SH1023
E-2442A	C442R	E-2680-2	B8685ZA	E-2846A	SR1000
E-2442B	C442BR	E-2690A	B8698	E-2855	SR1014
E-2443A	C443L	E-2693	C693L	E-2856	SR1015
E-2443B	C443BL	E-2694	C694R	E-2889	SH1025
E-2444A	C444R	E-2695	B8688	E-2891	SH1026
E-2444B	C444BR	E-2696A	B8684	E-2892	SH1027
E-2445A	C445L	E-2696A-2	B8684A	E-2899	SH1029
E-2445B	C445BL	E-2717	B717	E-2907A	SH1030
E-2446A	C446R	E-2720	B795	E-2908	SH1031
E-2446B	C446BR	E-2723	B823	E-2909	SH1032
E-2447	C447L	E-2724	B829	E-2910A	SH1033
E-2447A	C447AL	E-2725	B829	E-2911	SH1034
E-2448	C448R	E-2726	B829	E-2912A	SH1035
E-2448A	C448AR	E-2766	B120	E-2913A	SH1036
E-2449	C449L	E-2767	B220	E-2914	SH1037
E-2449A	C449AL	E-2768	B302	E-2915A	SH1038
E-2450	C450R	E-2769HD	QK-1MPHD	E-2934	SH1097
E-2450A	C450AR	E-2769S	QK-1	E-2975	SH1095
E-2451	C451L	E-2769SHD	QK-1HD	E-3000	SH1082
E-2451A	C451AL	E-2770	B870	E-3001	SH1064H
E-2452	C452R	E-2773	B377	E-3002A	SH1039
E-2452A	C452AR	E-2778-55	L4515Q-20	E-3003	SH1083H
E-2458S	S2022A	E-2778-78	L4515Q	E-3004	SH1084
E-2459S	S2019A	E-2781A	SH1021	E-3005	SH1085
E-2469	B8655	E-2786	C786R	E-3007A	B161
E-2469-2	B8655A	E-2787	C787L	E-3008	5300S
E-2475	B983	E-2794	C794R	E-3079	SH1040
E-2477B	B8736	E-2795	C795L	E-3227	B498
E-2478A	C478R	E-2796	C796R	E-3228	B302
E-2478B	C478BR	E-2797	C797L	E-3234	B8722
E-2479A	C479L	E-2798	B898	E-3276	SH1041
E-2479B	C479BL	E-2799	C799R	E-3277	SH1042
E-2494	B8712	E-2800	C800L	E-3283A	SR1012
E-2514	SF1008	E-2802	B053	E-3284A	SR1013
E-2515	SF1007	E-2803	B154	E-3291	WF-1
E-2517	B8699	E-2804	B982	E-3347	C347L
E-2526	B8682	E-2805	B770	E-3348	C348R
E-2545	802W	E-2821	EK-2	E-3349	C349L
E-2545	SH1063	E-2826	SF1020	E-3350	C350R
E-2546	SH1016	E-2827	SF1021	E-3351	C351L
E-2547	800W	E-2828	SF1022	E-3352	C352R
E-2547	SH1094	E-2829	SF1019	E-3373HD	LB-2
E-2548	SH1062	E-2830	SF1000	E-3390	SH1043
E-2550	5401	E-2832	SF1006	E-3414	SH1044
E-2551	B8665	E-2833	SF1013	E-3415	SH1045
E-2670	B8661	E-2836	SF1018	E-3416	SH1046
E-2672	B922	E-2837	SF1017	E-3424	B262
E-2675HD	MK-1HD	E-2838	SF1016	E-3427	B556
E-2679A	B8686	E-2839	SF1015	E-3437	B579

INTERCHANGES

EUCLID	SIRCO	EUCLID	SIRCO	EUCLID	SIRCO
E-3446	B8743	E-3878	B8761	E-4714A	C714AR
E-3446-2	B8743A	E-3895S	QK-2S	E-4715	C715L
E-3447	B8754	E-3895SHD	QK-2SHD	E-4715A	C715AL
E-3468A	RC-1	E-3920-78	L4515X	E-4716	C716R
E-3469	B8755	E-3972	SR1003	E-4717	C717L
E-3471	B8756	E-3975	B428	E-4718	C718R
E-3472	B230	E-3975	SR1005	E-4719	C719L
E-3473	B811	E-3976	SR1001	E-4720	C720R
E-3474	B8759	E-3989AHD	B8747HD	E-4721	C721L
E-3475	B8758	E-3989AHD-2	B8747HDA	E-4722	C722R
E-3476	B8757	E-3991	B8764	E-4723	C723L
E-3478	B8718	E-3992	RK-2	E-4724	C650R
E-3479	B8719	E-3993B	B8707	E-4725	C649L
E-3481A	B308	E-3993B-2	B8707A	E-4726	C726R
E-3482	B134	E-4311EHD	EK-1HD	E-4727	C727L
E-3483	B135	E-4347	805	E-4728R	C728R
E-3484	LB-3	E-4358	SH1055	E-4729L	C729L
E-3490B	B349	E-4515P	TK-4	E-4730	C730R
E-3490S	B349	E-4515PHD	TK-4HD	E-4731	C731L
E-3511	B923	E-4515Q	QK-1	E-4732	C732R
E-3512	B972	E-4515QHD	QK-1HD	E-4732A	C732AR
E-3513	B973	E-4515QMB	QK-8	E-4733	C733L
E-3518	RK-1	E-4515QMBHD	QK-8HD	E-4733A	C733AL
E-3520A	B8683	E-4515U	QK-2S	E-4734	C734R
E-3520A-2	B8683A	E-4515UHD	QK-2SHD	E-4735	C735L
E-3520AHD	B8683HD	E-4515X	XK-3	E-4736	B8691
E-3520AHD-2	B8683HDA	E-4515XHD	XK-3HD	E-4737A	CT332
E-3710HD	XK-3MPHD	E-4586	B8728	E-4738A	CT333
E-3710S	XK-3	E-4587	B8727	E-4739	CT334
E-3710SHD	XK-3HD	E-4594	B8725A	E-4800	ARK
E-3711	B277	E-4691	RF-1ARK	E-4804	ST1010
E-3782	LB-6	E-4702	RF-5	E-4805	ST1011
E-3801	EK-3	E-4702A	C702R	E-4806	ST1012
E-3824	B871	E-4702B	C702BR	E-4807	ST1013L
E-3854	C854L	E-4703A	C703L	E-4808	ST1013R
E-3855	C855R	E-4703B	C703BL	E-4809	ST1014
E-3856	C856L	E-4706A	C706R	E-4810	ST1015L
E-3857	C857R	E-4706B	C706BR	E-4811	ST1015R
E-3858	MF-1	E-4707A	C707L	E-4813	ST1000
E-3859	B8690	E-4707B	C707BL	E-4814	ST1017
E-3861	C861L	E-4708A	C708R	E-4818	ST1018
E-3862	C862R	E-4708B	C708BR	E-4824	SB1007
E-3869	RF-3	E-4709A	C709L	E-4825	ST1005
E-3870	B950	E-4709B	C709BL	E-4827	ST1003
E-3871	B951	E-4709ES	ES-1	E-4828	ST1019
E-3872	B952	E-4709ES2	ES-2	E-4830	ST1004
E-3873	B953	E-4710A	C710R	E-4832	ST1002
E-3874	B954	E-4710B	C710BR	E-4833	ST1007
E-3876	B8744	E-4711A	C711L	E-4834A	ST1006
E-3876-2	B8744A	E-4711B	C711BL	E-4835	SH1057
E-3877	B8760	E-4714	C714R	E-4837	ST1009

INTERCHANGES

EUCLID	SIRCO	EUCLID	SIRCO	EUCLID	SIRCO
E-4880S	XK-1	E-5140	B8742	E-5522	C518L
E-4880SHD	XK-1HD	E-5140-2	B8742A	E-5523	C519R
E-4884	C884L	E-5241A	CT357	E-5524	C520L
E-4885	C885R	E-5242A	CT361	E-5525	C521R
E-4886	C886L	E-5243A	CT359	E-5526	C526L
E-4887	C887R	E-5244A	CT360	E-5527	C527R
E-4888	C888L	E-5304	B217	E-5551L	125
E-4889	C889R	E-5305	B218	E-5551R	124
E-4894	C894L	E-5306	LB-7	E-5553L	272
E-4895	C895R	E-5307	B8655Z	E-5553R	271
E-4896	C896L	E-5307-2	B8655ZA	E-5556L	095
E-4897	C897R	E-5477	B430K	E-5556R	096
E-4898	C898L	E-5478	B431	E-5559L	989
E-4899	C899R	E-5481A	ES-1	E-5559R	988
E-4904	S2026	E-5482	B8763	E-5560L	005
E-4934A	CT356	E-5490	C490L	E-5560R	004
E-4935	CT311	E-5491	C491R	E-5561L	991
E-4956A	715	E-5492	C492L	E-5561R	990
E-4958	654	E-5493	C493R	E-5571A	123
E-4961A	073	E-5494	C494L	E-5572A	235
E-4961A	806	E-5495	C495R	E-5579L	913L
E-4962	149	E-5496	C496L	E-5579R	912R
E-4963	716	E-5497	C497R	E-5652L	889L
E-4965L	192	E-5498	S2023	E-5652R	888R
E-4965R	191	E-5501	B8746	E-5706	411
E-4966L	264	E-5501-2	B8746A	E-5720L	439
E-4966R	263	E-5503-77	L4707Q-20	E-5720R	438
E-4967L	969	E-5503-78	L4707	E-5747	267
E-4967R	968	E-5504A	C504L	E-5756L	067
E-4968L	852	E-5505A	C505R	E-5756R	066
E-4968R	851	E-5506	C441BL	E-5757L	376
E-4969L	184	E-5506	C867L	E-5757R	375
E-4969R	183	E-5507	C442BR	E-5765L	098
E-4999	C499L	E-5507	C866R	E-5765R	097
E-5000	C500R	E-5508	C443BL	E-5766L	374
E-5032	SR1020	E-5508	C871L	E-5766R	373
E-5040A	993	E-5509	C444BR	E-5781	238
E-5086	MK-2HD	E-5509	C870R	E-5783	236
E-5087	B122	E-5510	C445BL	E-5784A	708
E-5088	B221	E-5510	C868L	E-5785A	053
E-5089	B924	E-5511	C446BR	E-5821	233
E-5093	B8689	E-5511	C869R	E-5827	256
E-5094A	B8745	E-5512	B8600A	E-5828	257
E-5095	B8762	E-5513	B8766	E-5829	302
E-5122	B999	E-5515	XL-1	E-5838	729
E-5123	B562	E-5516	C516L	E-5871L	481
E-5127	B8750	E-5517	C517R	E-5871R	482
E-5128	B8751	E-5518	C514L	E-5885	008
E-5137	B8752	E-5519	C515R	E-5889	515
E-5138	B8753	E-5520	C512L	E-5890	544
E-5139	EF-1	E-5521	C513R	E-5891	545

INTERCHANGES

EUCLID	SIRCO	EUCLID	SIRCO	EUCLID	SIRCO
E-5896L	287L	E-6080	B8782	E-7532	SH1048
E-5896R	287R	E-6081L	C081L	E-7533	SH1054
E-5900L	448	E-6082R	C082R	E-7534	SH1059
E-5900R	447	E-6101	C611L	E-7621	SH1049
E-5902	722	E-6102	C612R	E-7775	716S
E-5904A	138	E-6879	RF-2ARK	E-7895L	709AL
E-5905A	110	E-6880	C880L	E-7895R	708AR
E-5910L	413	E-6881	C881R	E-7896L	896L
E-5910R	412	E-6882	C882L	E-7896R	896R
E-5924L	205	E-6883	C883R	E-7897L	897L
E-5924R	204	E-6884	C890L	E-7897R	897R
E-5926	853	E-6885	C891R	E-7899	RF-3A
E-5927	399	E-6918A	SA10144	E-7918	SH1021U
E-5931L	011	E-6923B	SA10102	E-8653	SR1002U
E-5931R	012	E-6924B	SA10103	E-8658-B-BK	9004B
E-5953	314	E-6925B	SA10100	E-8658-R-BK	9004R
E-5966	800	E-6927B	SA10101	E-8666	SH1049U
E-5968	802	E-6928	SA10306	E-8896	S2001
E-5970	807	E-6933	SA10305	E-8897	S2000
E-5971	808	E-6936	SA10216	E-8906	CT312
E-5972	809	E-6940	SA10215	E-8907	B350
E-5977L	892BL	E-6942	SA10212	E-8923	EX-1
E-5977R	891BR	E-6944	SA10211	E-8925	EQ-1
E-5978L	978L	E-6946	SA10214	E-8925SHD	EQ-1
E-5978R	978R	E-6987A	SA24100	E-8931	SF1001
E-5987L	415	E-6989A	SA25100	E-8938	B888D
E-5987R	414	E-6991A	SA21103	E-8947L	947
E-5988L	988L	E-6992A	SA21102	E-8947R	948
E-5988R	988R	E-6993A	SA22103	E-8949L	450
E-5991	881M	E-6994A	SA22102	E-8949R	449
E-5992A	883	E-6995A	SA23106	E-8968L	419
E-5993	884	E-6999S	QK-8	E-8968R	418
E-5994	882	E-6999SHD	QK-8HD	E-8969L	421
E-5995L	995L	E-7217	C217L	E-8969R	420
E-5995R	995R	E-7218	C218R	E-8979L	134
E-5996L	996L	E-7219	C219L	E-8979R	133
E-5996R	996R	E-7220	C220R	E-8980	422
E-5997	335	E-7231	FF-1	E-8981	423
E-5998	334	E-7232	FF-1S	E-8982L	425
E-5999	336	E-7235	B8795	E-8982R	424
E-6000A	333B	E-7237	FR-1	E-8983L	427
E-6034	160	E-7238	FR-1S	E-8983R	426
E-6035	162	E-7241	B8796	E-8986	451
E-6036	164	E-7432	SF1004U	E-9008L	429
E-6053	251	E-7433	SF1011U	E-9008R	428
E-6054	201	E-7445	13501U	E-9010L	431
E-6057L	417	E-7450	44132U	E-9010R	430
E-6057R	416	E-7452	SH1008U	E-9020	920
E-6076	B8783	E-7453	SH1001U	E-9021	921
E-6077	B8784	E-7520	SB1004U	E-9023	725
E-6078	B8788	E-7523	SR1008U	E-9027-78	L4311J

INTERCHANGES

EUCLID	SIRCO	EUCLID	SIRCO	EUCLID	SIRCO
E-9037	B433	E-9111	9004P	E-9656	C656R
E-9038	B436	E-9133	S2002	E-9657	C657L
E-9039	ES-4	E-9141	ES-3	E-9658	C658R
E-9053	B8793	E-9281	LB-9	E-9659	C524L
E-9055	C055L	E-9283	LB-8	E-9660	C522R
E-9056	C056R	E-9302	SB1009	E-9661	C537L
E-9057	C057L	E-9303	SB1010	E-9662	C536R
E-9058	C058R	E-9304	SB1011	E-9663	C663L
E-9059	C059L	E-9305	SB1000	E-9664	C664R
E-9060	C060R	E-9307	SB1008	E-9665	C665L
E-9063	B956	E-9308	SB1016	E-9666	C666R
E-9064	RF-5	E-9309	SB1015	E-9667	C667L
E-9069	B347	E-9361	SF1002U	E-9668	C668R
E-9070	MF-3	E-9362	SF1009U	E-9669	C669L
E-9071	B8781	E-9471	SH1050	E-9670	C670R
E-9072	B8785	E-9472	SH1053	E-9671	C595L
E-9073	B961	E-9473	SH1053U	E-9672	C594R
E-9074	B8786	E-9474	SH1012U	E-9675	C675L
E-9075	B8787	E-9475	SH1061	E-9676	C676R
E-9076	B794	E-9545	SR1007U	E-9677	C677L
E-9077	B8634A	E-9555	SR1001U	E-9678	C678R
E-9078	B8772M	E-9567	SH1048U	E-9679	C679L
E-9078HD	B8772MHD	E-9568	44131	E-9680	C680R
E-9078HD-2	B8772MHDA	E-9569	44130U	E-9681	C681L
E-9079	B8773M	E-9570	SH1021	E-9682	C682R
E-9079HD	B8773MHD	E-9582	SH1060	E-9683	C683L
E-9079HD-2	B8773MHDA	E-9591	CT336	E-9684	C684R
E-9080	B8771	E-9592	CT337	E-9693	C750L
E-9081	C085L	E-9593	CT338	E-9694	C751R
E-9082	C086R	E-9596	CT350	E-9695	C752L
E-9083	C083L	E-9597	CT351	E-9696	C753R
E-9084	C084R	E-9601	CT369	E-9697	C754L
E-9085	C185L	E-9602	CT370	E-9698	C755R
E-9086	C186R	E-9603	SH1092	E-9699	C756L
E-9089	C089L	E-9604	SH1093	E-9700	C757R
E-9090	C090R	E-9605	SH1080	E-9701	C763L
E-9091	C091L	E-9606	SH1081	E-9702	C764R
E-9092	C092R	E-9607	ST1008	E-9703	C761L
E-9093	C087L	E-9643	B348	E-9704	C762R
E-9094	C088R	E-9644	MF-2	E-9725	C724L
E-9096	C096L	E-9645	C645L	E-9726	C725R
E-9097	C097R	E-9646	C646R	E-9727	C927L
E-9098	C098L	E-9647	C647L	E-9728	C928R
E-9099	C099R	E-9648	C648R	E-9729	C972L
E-9100	C102L	E-9649	C427L	E-9730	C973R
E-9101	C103R	E-9650	C426R	E-9731	C931L
E-9102	S2024	E-9651	C651L	E-9732	C932R
E-9107	A1452	E-9652	C652R	E-9733	C933L
E-9108	A1451	E-9653	C653L	E-9734	C934R
E-9109	A1450	E-9654	C654R	E-9735	C935L
E-9110	9004	E-9655	C655L	E-9736	C936R

INTERCHANGES

EUCLID	SIRCO	EUCLID	SIRCO	EUCLID	SIRCO
E-9737	C737L	E-10836	BP-108	E-11867	C608R
E-9738	C738R	E-10838	BP-109	E-11897	B8805
E-9741	C742L	E-10841	BK-145F	E-11910	B8797
E-9742	C743R	E-10866	BK-145FM	E-11974	RK-3
E-9759	C759L	E-10870	BK-145R	E-11981	ES-5
E-9760	C760R	E-10875	LB-3D	E-12732	DT20
E-9769	C769L	E-10897	B8746Z	E-12733	DT30
E-9770	C770R	E-10899	C603L	E-12773	DT30LS
E-9789	B805	E-10900	C602R	E-15016	SA1132
E-9790A	B8792	E-10905	C905L	E-15017	SA1133
E-9790A-2	B8792A	E-10906	C906R	E-15020	SA1136
E-9791	B8790	E-10909	C910L	E-15022	SA1138
E-9791HD	B8790HD	E-10910	C911R	E-15024	SA1140
E-9792A	B8606A	E-10911	C740L	E-15025	SA1141
E-9837	366	E-10912	C741R	E-15028	SA1144
E-10197	B432A	E-10946	CT331	E-15061	S2007
E-10198	B434	E-10947	CT313	E-15069	S2006
E-10208L	433	E-10949A	SA22953	E-BC12S	A1200
E-10208R	432	E-10950A	SA21953	E-BC20S	A2000
E-10210L	435	E-11318	K-3	E-BC24S	A2400
E-10210R	434	E-11319	K-4	E-BC30S	A3000
E-10217	452	E-11398	SA1041	E-BN229859N	A9859
E-10219	436	E-11399	SA1042	E-BN229860N	A9860
E-10220	453	E-11401	SA1073	E-BN275491N	A5491
E-10221	437	E-11402	SA1074	EK5404515QHD	L4515Q-20-QK1HD
E-10235	919	E-11430	S2009	EK5404707QPHD	L4707Q-20-QK1HD
E-10244	ES-2	E-11430A	S2009	EK5504515QHD	L4515Q-QK1HD
E-10244S	ES-2	E-11433	C605L	EK5504702QP	L4702Q-RF5
E-10250	ST1001	E-11434	C604R	EK5504707QPHD	L4707-QK1HD
E-10253L	306L	E-11445	B8150L	EK5551443EM	L4311J-EK1HD
E-10253R	306R	E-11446	B8150R	EK5554515F3HD	L4515X-XK3HD
E-10254L	304L	E-11449	B806	EK5554709E2	L4709N-ES2
E-10254R	304R	E-11450	B8794	EK5571308Q	L1308Q-RF3
E-10272-78	L4709N	E-11450HD	B8794HD	E-UB5161-12	5R783123
E-10306A	C306L	E-11450HD-2	B8794HDA	E-UB5161-13	5R783136
E-10307A	C307R	E-11493	SF-1	E-UB5161-14	5R783146
E-10676	676	E-11497	CT375	E-UB5161-15	5R783156
E-10742	A1012	E-11540	C540R	E-UB5161-16	5R783166
E-10744	A1015	E-11541	C541L	E-UB5161-18	5R783186
E-10746	A1040	E-11568	C568R	E-UB5163-14	5R7835146
E-10756	LB-10	E-11569	C569L	E-UB5163-18	5R7835186
E-10757	LB-11	E-11584	C584R	E-UB5165-12	5R785123
E-10760	EF-2	E-11585	C585L	E-UB5165-14	5R785146
E-10800	B800	E-11715	367	E-UB5165-15	5R785156
E-10801	B801	E-11858	C312L	E-UB5165-16	5R785166
E-10812	BP-105	E-11859	C313R	E-UB5165-18	5R785186
E-10814	BP-104	E-11860	C314L	E-UB8151-12	8R343123
E-10818	BP-100	E-11861	C315R	E-UB8151-18	8R343186
E-10826	BP-106	E-11864	C607L	E-UB8154-18	8R344186
E-10834	BP-107	E-11865	C606R	E-UB8161-12	8R783123
E-10835	BP-110	E-11866	C609L	E-UB8161-13	8R783136

INTERCHANGES

EUCLID	SIRCO	EUCLID	SIRCO	EZ RIDE	SIRCO
E-UB8161-14	8R783146	FS9213	AS9213	8030155	AS8008
E-UB8161-15	8R783156	FS9219	AS9219		
E-UB8161-16	8R783166	FS9243	AS9243		
E-UB8161-17	8R783176	FS9265	AS9265		
E-UB8161-18	8R783186	FS9270	AS9270		
E-UB8165-12	8R785123	FS9287	AS9287		
E-UB8165-13	8R785136	FS9293	AS9293		
E-UB8165-14	8R785146	FS9295	AS9295		
E-UB8165-16	8R785166	FS9307	AS9307		
E-UB8165-18	8R785186	FS9321	AS9321		
FS6799	AS6799	FS9366	AS9366		
FS6808	AS6808	FS9367	AS9367		
FS6897	AS6897	FS9370	AS9370		
FS6902	AS6902	FS9371	AS9371		
FS6905	AS6905	FS9373	AS9373		
FS6910	AS6910	FS9375	AS9375		
FS7135	AS7135	FS9387	AS9387		
FS7136	AS7136	FS9394	AS9394		
FS7140	AS7140	FS9422	AS9422		
FS7403	AS7403	FS9466	AS9466		
FS7410	AS7410	FS9547	AS9547		
FS7555	AS7555	FS9580	AS9580		
FS7795	AS7795	FS9616	AS9616		
FS7798	AS7798	FS9619	AS9619		
FS7818	AS7818	FS9622	AS9622		
FS8008	AS8008	FS9625	AS9625		
FS8018	AS8018	FS9626	AS9626		
FS8032	AS8032	FS9640	AS9640		
FS8033	AS8033	FS9647	AS9647		
FS8050	AS8050	FS9648	AS9648		
FS8091	AS8091	FS9780	AS9780		
FS8204	AS8204	FS9781	AS9781		
FS8708	AS8708	FS9921	AS9921		
FS8709	AS8709	FS9923	AS9923		
FS8713	AS8713	FS9935	AS9935		
FS8729	AS8729	FS9936	AS9936		
FS8749	AS8749	L5571308Q	L1308Q		
FS8755	AS8755	SF5551308	L1308E		
FS8792	AS8792	SF5504702QP	L4702Q		
FS8813	AS8813				
FS8829	AS8829				
FS8852	AS8852				
FS8944	AS8944				
FS9010	AS9010				
FS9026	AS9026				
FS9039	AS9039				
FS9069	AS9069				
FS9082	AS9082				
FS9101	AS9101				
FS9121	AS9121				
FS9192	AS9192				

INTERCHANGES

FIRESTONE	SIRCO	FIRESTONE	SIRCO	FLAGG	SIRCO
W01-358-6799	AS6799	W01-358-9293	AS9293	B1208-22	SB1002
W01-358-6808	AS6808	W01-358-9295	AS9295	B1324-43	SH1045
W01-358-6897	AS6897	W01-358-9307	AS9307	BK1	SB1000
W01-358-6902	AS6902	W01-358-9321	AS9321	BK2	SB1016
W01-358-6905	AS6905	W01-358-9366	AS9366	BK4	SB1007
W01-358-6910	AS6910	W01-358-9367	AS9367	BK5	SB1008
W01-358-7135	AS7135	W01-358-9370	AS9370	BK6	SB1009
W01-358-7136	AS7136	W01-358-9371	AS9371	BK7	SB1010
W01-358-7140	AS7140	W01-358-9373	AS9373	BK8	SB1011
W01-358-7403	AS7403	W01-358-9375	AS9375	DL294	SH1023
W01-358-7410	AS7410	W01-358-9387	AS9387	DL295	SH1023
W01-358-7550	AS7555	W01-358-9394	AS9394	DN0	SH1087
W01-358-7555	AS7555	W01-358-9422	AS9422	DN1	SH1080
W01-358-7795	AS7795	W01-358-9466	AS9466	DN2	SH1081
W01-358-7798	AS7798	W01-358-9547	AS9547	DN3	SH1082
W01-358-7818	AS7818	W01-358-9580	AS9580	DN4	SH1064
W01-358-8008	AS8008	W01-358-9616	AS9616	DN5	SH1039
W01-358-8018	AS8018	W01-358-9619	AS9619	DN6	SH1083
W01-358-8032	AS8032	W01-358-9622	AS9622	DN7	SH1084
W01-358-8033	AS8033	W01-358-9625	AS9625	DN8	SH1085
W01-358-8050	AS8050	W01-358-9626	AS9626	DN00	SH1086
W01-358-8091	AS8091	W01-358-9630	AS9640	E112	SF1014
W01-358-8204	AS8204	W01-358-9640	AS9640	E303	SH1030
W01-358-8708	AS8708	W01-358-9647	AS9647	FLN106	SB1006
W01-358-8709	AS8709	W01-358-9648	AS9648	FR203	SF1018
W01-358-8713	AS8713	W01-358-9780 (PI)	AS9780	FR203I	SF1018
W01-358-8729	AS8729	W01-358-9781 (AI)	AS9781	FR204	SF1017
W01-358-8749	AS8749	W01-358-9807	AS9807	FR209	SF1015
W01-358-8755	AS8755	W01-358-9921	AS9921	FR246	SF1020
W01-358-8792	AS8792	W01-358-9923	AS9923	FR246I	SF1020
W01-358-8813	AS8813	W01-358-9935	AS9935	FR248	SF1022
W01-358-8829	AS8829	W01-358-9936	AS9936	FR254	SF1007
W01-358-8852	AS8852	W02-358-7001	AS7001	FR254I	SF1007
W01-358-8944	AS8944	W02-358-7012	AS7012	FR260	SF1001
W01-358-9010	AS9010	W02-358-7031	AS7031	FR260I	SF1001
W01-358-9015	AS8944	W02-358-7036	AS7036	FR261	SF1012
W01-358-9026	AS9026	W02-358-7046	AS7046	FR262	SF1005
W01-358-9039	AS9039	W02-358-7074	AS7074	FR263	SF1004
W01-358-9069	AS9069	W02-358-7081	AS7081	FR263UB	SF1004U
W01-358-9082	AS9082	W02-358-7087	AS7087	FR264	SF1002
W01-358-9101	AS9101	W02-358-7108	AS7108	FR266	SF1009
W01-358-9121	AS9121	W02-358-7110	AS7110	FR267	SF1003
W01-358-9122	AS9122	W02-358-7205	AS7205	FR268	SF1010
W01-358-9192	AS9192	W02-358-7206	AS7206	FR269	SF1000
W01-358-9213	AS9213	W02-358-7215	AS7215	FR269I	SF1000
W01-358-9219	AS9219			FR271	SF1008
W01-358-9243	AS9243			FR273	SF1021
W01-358-9262	AS9580			FR273I	SF1021
W01-358-9265	AS9265			FR276	SF1016
W01-358-9270	AS9270			FR292	SF1013
W01-358-9287	AS9287			FR293	SF1006

INTERCHANGES

FLAGG	SIRCO	FLAGG	SIRCO	FLAGG	SIRCO
FR307	SF1019	LN106	ST1008	TRA2728	SH2728
H100	SH1021	LN107	SR1011	UBK104	8R343123
H100I	SH1021	LNC107A	SH1055	UBK114	8R343186
H101	SH1025	PNF104	SR1020	UBK117	8R344186
H101I	SH1025	R003	SR1007	UBK122	8R783146
H102	SH1008	R101	SR1012	UBK124	8R783123
H102I	SH1008	R102	SR1013	UBK125	8R783136
H102UB	SH1008U	R103	SR1000	UBK126	8R783166
H103	SH1026	R104	SR1003	UBK129	8R785146
H104	SH1027	R109	SR1004	UBK133	8R783186
H105	SH1010	R110	SR1002	UBK137	8R785186
H106	SH1041	R110UB	SR1002U	UBK142	8R785123
H106I	SH1041	R111	SR1006	UBK143	8R785136
H107	SH1043	R129	SB1004	UBK144	8R785166
H108	SH1042	R129UB	SB1004U	UBK265	8R783176
H108I	SH1042	R130	SR1008	UBK266	8R783156
H110	SH1009	R130UB	SR1008U	UBK1225	5R783146
H111	SH1012	R139	SR1018	UBK1245	5R783123
H112	SH1040	R159	SR1010	UBK1295	5R785146
H115	SH1032	R160	SR1009	UBK1335	5R783186
H156	SH1046	R202	SR1017	UBK2625	5R783166
H157	SH1057	R231	SR1016	UBK2655	5R7835146
H161	SH1033	R233	SR1001	UBK2665	5R7835186
H162	SH1036	R276	SR1014	UBK2675	5R785123
H162I	SH1036	R277	SR1015	UBK2685	5R785166
H163	SH1034	RBT200	SF1011	UBK2695	5R785186
H163I	SH1034	RBT200UB	SF1011U	UBW50	SH1090
H164	SH1037	RBT201	SH1001	UBW55	SH1091
H164I	SH1037	RBT201UB	SH1001U	UBW60	SH1092
H165	SH1035	TP100	ST1000	UBW65	SH1093
H166	SH1038	TP101	SH1057	UBW70	SH1094
H166I	SH1038	TP102	ST1019	UBW75	SH1063
H167	SH1029	TP104	ST1010	UBW80	SH1016
H169	SH1031	TP105	ST1011	UBW85	SH1095
H169I	SH1031	TP106	ST1012	UBW88	SH1096
H217	SH1044	TP107	ST1001	UBW90	SH1097
H220	SH1048	TP108	ST1002		
H220I	SH1048	TP109	ST1004		
H221	SH1054	TP110	ST1003		
H222	SH1059	TP111	ST1006		
H222I	SH1059	TP112	ST1007		
H225	SH1050	TP113	ST1009		
H225I	SH1050	TP116	ST1005		
H226	SH1061	TP119	ST1017		
H227	SH1049	TP129	ST1013L		
H227I	SH1049	TP130	ST1013R		
H227UB	SH1049U	TP131	ST1014		
H256	SH1062	TP132	ST1015R		
H263	SH1053	TP133	ST1015L		
HLW107	SR1005	TRA2726	SH2726		
LN104	SH1011	TRA2727	SH2727		

INTERCHANGES

FONTAINE	SIRCO	FREIGHTLINER	SIRCO	FRUEHAUF	SIRCO
BSH-150	13501	16-11378-000	AS7410	305680-900	B8650
CD-SPR-236	60000S	16-13810-000	AS9780	ACA3265	B8635
KIT-PIN-135	13500	16-13840-000	AS9781	ACA3266	B8635
KIT-PIN-191	13502	16-14004-000	AS9781	ACC001996-902	FK-1HD
KIT-PIN-6000	13500	16-15595-000	AS9780	ACC6113-900	9016
KIT-PIN-UNVL	13500			ACC7538-900	9013
KIT-RPR-5092L	50920L			ACD2233-1	B868
KIT-RPR-5092R	50920R			ACD2285-900	B8624
KIT-RPR-6000L	60000L			ACD2287-1	B869
KIT-RPR-6000R	60000R			ACE009911	B302
SPR-128	50920BS			ACE8510-001	5401
SPR-137	50920JS			ACE9909-001	B377
SPR-138	50920JS			ACF1328-001	B498
SPR-338	60000S			ACF3378-001	B277
				ACF4021-1	B8727
				ACF4022-1	B8727
				ACF4024-1	B8728
				ACF4024-900	B8725A
				AXA-000512-001	SF1017
				AXA0068	B495S
				AXA0408-1	5402
				AXA0413-900	B8620
				AXA0417-1	B8619
				AXA0418-1	B8622
				AXA0420-1	C563L
				AXA0420-2	C564R
				AXA0420-3	C101L
				AXA0420-4	C100R
				AXA0420-5	C862R
				AXA0420-6	C861L
				AXA0420-900	B8649
				AXA0429-900	B8623
				AXA0430-1	B8734
				FSP 005-05 KIT	LGBK
				FSP-00602PK9	SR1011
				MBCBK0013	FK-1
				MBCBK0014	FK-2HD
				UCC-005998-001	SF1015
				UCD-000511-001	SF693
				UCD-006632-002	SH1023
				UCE-008801-001	SF1014
				UCE-9393-2	AS9394
				UCF-002467-001	SF1020
				UCF-002470-001	SF1022
				UCF-002640-001	SF1007
				UCF-006963	SF1001
				UXA-000002	SF1012
				UXA-000003	SF1005
				UXA-000004	SF1004
				UXA-000011	SF1011
				UXA-000016	SF1010

INTERCHANGES

FRUEHAUF	SIRCO	GLP	SIRCO	GLP	SIRCO
UXA-000017	SF1000	GL-1001	708AR	GL-3247	545
UXA-000026-001	SF1008	GL-1002	709AL	GL-3255	138
UXA-000034	SF1021	GL-1003	896R	GL-3256	110
UXA-000048	SF1016	GL-1004	896L	GL-3257	267
UXA-0004-900	SF1002	GL-1005	897R	GL-3263	251
UXA-00015-001	SF1003	GL-1006	897L	GL-3270	236
UXA-000356-001	SF1013	GL-1009	306R	GL-3271	238
UXA-000356-002	SF1006	GL-1010	306L	GL-3279	233
UXA-000495-001	SF1018	GL-1011	988R	GL-3294	201
UXA-0011-900	SF1009	GL-1012	988L	GL-3298	314
ZCF003435901	CMBK	GL-2001	891AR		
		GL-2002	892AL		
		GL-2003	891BR		
		GL-2004	892BL		
		GL-2009	304R		
		GL-2010	304L		
		GL-2013	912R		
		GL-2014	913L		
		GL-2021	996R		
		GL-2022	996L		
		GL-2101	888R		
		GL-2102	889L		
		GL-2103	995R		
		GL-2104	995L		
		GL-2301	333B		
		GL-2302	881M		
		GL-2906	333SN6		
		GL-2919	333SN19		
		GL-2928	333SN28		
		GL-2939	333SN39		
		GL-3001	654		
		GL-3003	715		
		GL-3004	149		
		GL-3005	716		
		GL-3006	716S		
		GL-3083	399		
		GL-3085	853		
		GL-3087	729		
		GL-3096	123		
		GL-3097	235		
		GL-3098	993		
		GL-3099	053		
		GL-3103	708		
		GL-3112	256		
		GL-3113	257		
		GL-3114	302		
		GL-3158	008		
		GL-3243	722		
		GL-3244	725		
		GL-3245	515		
		GL-3246	544		

INTERCHANGES

GOODYEAR	SIRCO	GOODYEAR	SIRCO	GRANNING	SIRCO
1R10-120	AS9293	1R12-669	AS9069	7640	AS9321
1R11-028	AS9422	1R13-038	AS9122	8896	AS9293
1R11-159	AS9387	1R13-039	AS9121		
1R11-166	AS9295	1R13-081	AS9580		
1R11-203	AS9387	1R13-118	AS9580		
1R11-222	AS9625	1R13-119	AS9270		
1R11-242	AS9616	1R13-124	AS8755		
1R12-069	AS9069	1R13-130	AS8729		
1R12-090	AS9213	1R13-140	AS8713		
1R12-092	AS9082	1R13-153	AS8749		
1R12-095	AS9039	1R13-159	AS8709		
1R12-103	AS9101	1R13-176	AS8713		
1R12-167	AS9192	1R13-177	AS8708		
1R12-182	AS9219	1R14-039	AS8050		
1R12-197	AS9466	1R14-045	AS8792		
1R12-256	AS9367	1R14-171	AS8091		
1R12-271	AS8944	1S4-007	AS7031		
1R12-279	AS9394	1S4-008	AS7012		
1R12-303 (PI)	AS9780	1S5-038	AS7081		
1R12-335	AS9321	1S5-040	AS7087		
1R12-352	AS9010	1S5-057	AS7108		
1R12-365	AS9466	1S12-002	AS8829		
1R12-366	AS8944	1S12-027	AS9287		
1R12-367	AS9640	1S12-031	AS9375		
1R12-375	AS9265	1S12-244	AS9371		
1R12-398	AS9648	2B9-200	AS6910		
1R12-401	AS9371	2B9-206	AS6905		
1R12-403	AS9373	2B9-229	AS6897		
1R12-404	AS9375	2B9-239	AS6902		
1R12-405	AS8829	2B10-226	AS7795		
1R12-421	AS9010	2B12-307	AS7403		
1R12-424	AS9287	2B12-406	AS7410		
1R12-435	AS9307	2B12-440	AS7555		
1R12-480	AS9243	2B14-356	AS7136		
1R12-481	AS9923	2B14-359	AS7140		
1R12-487	AS9366	2B14-360	AS7135		
1R12-488	AS9375	2B14-476	AS6799		
1R12-499	AS9936	3B12-303	AS8018		
1R12-502	AS9921	3B12-312	AS8033		
1R12-503	AS9370	3B12-319	AS8032		
1R12-508	AS8204	3B14-356	AS7798		
1R12-509	AS9082	3B14-359	AS7818		
1R12-522	AS8204				
1R12-532	AS9935				
1R12-533	AS9923				
1R12-538	AS9648				
1R12-567	AS9026				
1R12-568	AS8852				
1R12-580	AS9370				
1R12-603 (AI)	AS9781				
1R12-615	AS8829				

INTERCHANGES

GUNITE	SIRCO	HALDEX	SIRCO	HALDEX	SIRCO
AS1132	SA1132	10024	9004P	C65366	B495
AS1133	SA1133	10028	9004	C65369	B887
AS1136	SA1136	11440	A1440	C65372	B888
AS1138	SA1138	11441	A1441	C65373	B988
AS1140	SA1140	11450	A1450	C65376	B498
AS1141	SA1141	11451	A1451	C65431	B152
AS1144	SA1144	11452	A1452	C65448	B595
AS1146	SA1132	11950	A1012	C65450	B981
AS1147	SA1133	11952	A1015	C65565	B871
AS1149	SA1140	11954	A1040	C66565	B349
AS1151	SA1141	65373	B988	C66606	B770
AS1152	SA1136	67357	B151	C66607	B982
AS1154	SA1138	40010073	SA2167	C66608	B053
AS3000	S2007	40010140	SA10100	C66609	B154
AS3016	S2006	40010141	SA10101	C66610	B923
W854	716	40010142	SA10102	C66611	B973
W980L	419	40010143	SA10103	C66612	B972
W980R	418	40010144	SA10144	C66649	B424
W981L	421	40010211	SA10211	C66650	B425
W981R	420	40010212	SA10212	C66651	B429
W992L	134	40010214	SA10214	C66652	B426
W992R	133	40010215	SA10215	C66653	B427
W1110	110	40010216	SA10216	C66654	B428
W1121L	421	40010305	SA10305	C66686	B120
W1121R	420	40010306	SA10306	C66834	B725
W1133L	134	40020212	SA2179	C66835	B999
W1133R	133	40020213	SA2178	C66836	B562
W1138	138	40020230	SA2174	C66841	B262
W1160	422	40020233	SA2172	C66842	B579
W1164	423	40020234	SA2175	C66843	B556
W1166L	425	40020235	SA2164	C66849	B256
W1166R	424	40020239	SA2170	C66853	B952
W1170L	427	C63005	B434	C66854	B953
W1170R	426	C63043	B956	C66862	B377
W1325	402	C63045	B347	C66863	B220
W1327	676	C63051	B436	C66864	B302
W1402	402	C63054	B433	C66879	B898
WP267	267	C63060	B432A	C66880	B870
WP515	515	C64534	B611	C66894	B823
WP544	544	C65302	B501	C66895	B829
WP545	545	C65306	B211	C66901	B911
WP722	722	C65307	B311	C66902	B052
WP725	725	C65310	B971	C66903	B161
		C65311	B379	C66910	B251
		C65320	B769	C66915	B277
		C65331	B861	C67366	B922
		C65337	B728	C67446	B869
		C65344	B832	C67447	B054
		C65345	B932	C67448	B868
		C65351	B423	C67465	B308
		C65358	B793	C67466	B135

INTERCHANGES

HALDEX	SIRCO	HALDEX	SIRCO	HALDEX	SIRCO
C67467	B134	CQ66939	B8745	CQ67436	LB-11
C67471	B358	CQ66940	B8766	CQ67437	LB-10
C67473	B216	CQ66941	B8788	CQ67443	B8805
C67474	B392	CQ66947	ES-3	CQ67444	B8794
C67475	B380	CQ66948	ES-4	CQ67764	B8644
C67476	B362	CQ67100	B8796	CQ67899	RF-3A
C67487	B132	CQ67111	B8792	CQ69001	RF-3
C67488	B218	CQ67128	B8772M	CQ69002	LB-6
C67489	B217	CQ67138	B8795	CQ69003	RF-2ARK
C67490	B133	CQ67315	TK-1	CQ69004	EK-3
C67492	B307	CQ67316	FK-1	CQ69005	MF-1
C67786	B983	CQ67317	TK-4	CQ69006	LB-8
CQ6861	QK-2S	CQ67319	EK-1HD	CQ69007	ES-5
CQ6867	QK-2SHD	CQ67324	B8649	CQ69008	SF-1
CQ36543	S2002	CQ67325	B8647	CQ69010	K-1A
CQ36544	S2006	CQ67326	B8648	CQ69012	BK-145FM
CQ62767	MK-2HD	CQ67327	B8646	CS40102	C756L
CQ62768	B8744	CQ67328	B8681	CS40103	C757R
CQ65416	K-4	CQ67329	B8643	CS40106	C752L
CQ65428	WF-1A	CQ67331	B8656	CS40107	C753R
CQ65446	EF-2	CQ67332	B8652	CS40108	C754L
CQ65477	ES-2	CQ67334	B8645	CS40109	C755R
CQ65478	EX-1	CQ67353	B8685Z	CS40110	C763L
CQ65479	EQ-1	CQ67354	B8684	CS40111	C764R
CQ65481	ES-1	CQ67356	MK-1HD	CS40142	C880L
CQ65495	ET-1	CQ67357	TK-7HD	CS40143	C881R
CQ65501	B8746	CQ67382	B8655	CS40152	C882L
CQ65515	XL-1	CQ67383	B8655Z	CS40153	C883R
CQ65517	B8747	CQ67384	B8657	CS40160	C085L
CQ65519	FF-1	CQ67385	B8686	CS40161	C086R
CQ65520	FR-1	CQ67386	B8683	CS40164	C083L
CQ65620	LB-3D	CQ67387	B8707	CS40165	C084R
CQ65642	RF-5	CQ67388	LB-4	CS40172	C645L
CQ66735	TK-4MPHD	CQ67390	TK-1HD	CS40173	C646R
CQ66740	B8650	CQ67394	LB-5	CS40174	C427L
CQ66759	ARK	CQ67395	LB-3	CS40175	C426R
CQ66861	QK-1	CQ67396	LB-7	CS40176	C504L
CQ66867	QK-1HD	CQ67398	LB-1	CS40177	C505R
CQ66875	XK-1HD	CQ67399	FK-1HD	CS40178	C655L
CQ66878	QK-8	CQ67401	XK-1	CS40179	C656R
CQ66882	QK-8HD	CQ67403	LB-2	CS40182	C524L
CQ66887	MF-2	CQ67405	LB-9	CS40183	C522R
CQ66889	MF-3	CQ67406	EK-2	CS40184	C537L
CQ66913	XK-3	CQ67407	RK-1	CS40185	C536R
CQ66914	XK-3HD	CQ67408	RK-2	CS40186	C595L
CQ66917	EF-1	CQ67410	B8712	CS40187	C594R
CQ66918	B8742	CQ67411	B8682	CS40188	C733AL
CQ66919	RF-1ARK	CQ67412	B8793	CS40189	C732AR
CQ66920	RC-1	CQ67413	B8771	CS40192	C675L
CQ66922	B8743	CQ67414	B8790	CS40193	C676R
CQ66926	WF-1	CQ67416	B8773M	CS40194	C679L

INTERCHANGES

HALDEX	SIRCO	HALDEX	SIRCO	HALDEX	SIRCO
CS40195	C680R	CS41154	C667L	CS41409	C103R
CS40196	C677L	CS41155	C668R	CS41414	C931L
CS40197	C678R	CS41156	C669L	CS41415	C932R
CS40198	C681L	CS41157	C670R	CS41416	C933L
CS40199	C682R	CS41158	C651L	CS41417	C934R
CS40200	C306L	CS41159	C652R	CS41420	C935L
CS40201	C307R	CS41160	C657L	CS41421	C936R
CS40202	C585L	CS41161	C658R	CS41422	C910L
CS40203	C584R	CS41162	C413L	CS41423	C911R
CS41014	C774L	CS41163	C412R	CS41430	C312L
CS41015	C773R	CS41164	C856L	CS41431	C313R
CS41016	C148L	CS41165	C857R	CS41434	C314L
CS41017	C147R	CS41168	C219L	CS41435	C315R
CS41024	C707L	CS41169	C220R	CS41436	C737L
CS41025	C706R	CS41172	C647L	CS41437	C738R
CS41026	C800L	CS41173	C648R	CS41448	C055L
CS41027	C799R	CS41174	C603L	CS41449	C056R
CS41028	C479L	CS41175	C602R	CS41450	C490L
CS41029	C478R	CS41182	C905L	CS41451	C491R
CS41032	C886L	CS41183	C906R	CS41458	C492L
CS41033	C887R	CS41260	C711L	CS41459	C493R
CS41036	C703L	CS41261	C710R	CS41460	C769L
CS41037	C702R	CS41264	C687L	CS41461	C770R
CS41042	C787L	CS41265	C686R	CS41476	C494L
CS41043	C786R	CS41266	C795L	CS41477	C495R
CS41044	C709L	CS41267	C794R	CS41478	C496L
CS41045	C708R	CS41276	C447L	CS41479	C497R
CS41046	C888L	CS41277	C448R	CS41480	C057L
CS41047	C889R	CS41278	C715L	CS41481	C058R
CS41048	C740L	CS41279	C714R	CS41482	C059L
CS41049	C741R	CS41292	C693L	CS41483	C060R
CS41052	C855R	CS41293	C694R	CS41492	C861L
CS41053	C854L	CS41328	C514L	CS41493	C862R
CS41054	C724L	CS41329	C515R	CS41504	C441L
CS41055	C725R	CS41362	C759L	CS41504	C091L
CS41110	C441BL	CS41363	C760R	CS41505	C442R
CS41110	C867L	CS41390	C512L	CS41505	C092R
CS41111	C442BR	CS41391	C513R	CS41506	C425AL
CS41111	C866R	CS41394	C742L	CS41507	C424AR
CS41112	C443BL	CS41395	C743R	CS41512	C101L
CS41112	C871L	CS41396	C096L	CS41513	C100R
CS41113	C444BR	CS41397	C097R	CS41514	C688L
CS41113	C870R	CS41398	C518L	CS41515	C689R
CS41114	C445BL	CS41399	C519R	CS41518	C089L
CS41114	C868L	CS41400	C520L	CS41519	C090R
CS41115	C446BR	CS41401	C521R	CS41522	C095L
CS41115	C869R	CS41402	C098L	CS41523	C094R
CS41150	C653L	CS41403	C099R	CS41524	C717L
CS41151	C654R	CS41404	C526L	CS41525	C716R
CS41152	C663L	CS41405	C527R	CS41526	C443L
CS41153	C664R	CS41408	C102L	CS41526	C087L

INTERCHANGES

HALDEX	SIRCO	HALDEX	SIRCO	HALTEC	SIRCO
CS41527	C444R	CS41771	C732R	430632	333SN6
CS41527	C088R	CS41772	C735L	430732	333SN19
CS41528	C563L	CS41773	C734R		
CS41529	C564R	CS52315	SA21103		
CS41532	C449L	CS52316	SA21102		
CS41533	C450R	CS52320	SA22102		
CS41542	C884L	CS52321	SA22103		
CS41543	C885R	CS52325	SA23106		
CS41544	C721L	CS52331	SA24100		
CS41545	C720R	CS52336	SA25100		
CS41548	C722R	CS52338	SA21953		
CS41549	C723L	CS52341	SA22953		
CS41550	C896L	CS56036	SA1136		
CS41551	C897R	CS56038	SA1138		
CS41552	C898L	CS56041	SA1141		
CS41553	C899R	CS56044	SA1144		
CS41554	C649L	DA9017B	9004B		
CS41555	C650R	DA9017R	9004R		
CS41558	C727L	KN18530	A5491		
CS41559	C726R	KN23010	A1030		
CS41560	C349L	KN32005	A9859		
CS41561	C350R	KN32011	A9860		
CS41562	C351L	KN36470	S2000		
CS41563	C352R	KN44041	S2012A		
CS41564	C894L	KN44051	S2011A		
CS41565	C895R	KN44061	S2019A		
CS41566	C729L	KN44071	S2022A		
CS41567	C728R	KN47001	S2010A		
CS41568	C731L	KN47011	S2020A		
CS41569	C730R	KN47081	S2021A		
CS41718	C423L	KN48031	S2026		
CS41719	C422R	KN51000	S2025		
CS41722	C421L	KN51010	S2023		
CS41723	C420R	KN55001	S2024		
CS41752	C451L	SC24	A2400		
CS41753	C452R	SC30	A3000		
CS41754	C797L				
CS41755	C796R				
CS41756	C719L				
CS41757	C718R				
CS41758	C445L				
CS41758	C081L				
CS41759	C446R				
CS41759	C082R				
CS41760	C776L				
CS41761	C775R				
CS41762	C411L				
CS41763	C410R				
CS41764	C609L				
CS41765	C608R				
CS41770	C733L				

INTERCHANGES

HENDRICKSON	SIRCO	HENDRICKSON	SIRCO	HOLLAND	SIRCO
58786-2	AS9647	S-22045	AS8755	4000501	40501L
AA230L	AS9626	S-22948	AS8713	4000503	40503R
S-001503	AS7443	S-23114	AS7795	4000528	40528
S-1080	AS7136	S-23347-1L	C605L	4000529	40529
S-1159	AS7403	S-23347-1R	C604R	4000501/4000528	40254L
S-2064	AS9039	S-23614	AS9619	4000501/4000529	40135L
S-2066	AS9082	S-23720	AS9626	4000503/4000529	40136R
S-2630	AS6902	S-23857-1L	C607L	GL-030-3000	702
S-2827	AS9010	S-23857-1R	C606R	KP-T809F	700
S-2878	AS7795	S-23974	B8794	PK-FAST-10	FWBK
S-2883	AS7403	S-24636-1L	C609L	RK-004413	44130
S-3184	AS7140	S-24636-1R	C608R	RK-06973-1	44134
S-3467	AS9122	S-25559	AS9270	RK-351-07296	35102M
S-3518	AS6905	S-26348	B8805	RK-351-A-02	35102R
S-4771	AS8050	S-45843-3	AS6910	RK-351-A-L-02	35102L
S-5270	AS6905	S-49048	AS9466	RK-2500-10	25001
S-6195	AS9192	S-50405-01	AS9287	RK-63500	63500R
S-8768	AS6910	S-50405-02	AS9287	RK-63501	63501L
S-10170	AS7410	S-50899-1	AS9375	RK-63503	63503M
S-11566	AS9010	S-50899-2	AS9375	RK-63503A	63503A
S-11637	AS8008	S-57122-1	AS9373	XA-2016	44131
S-11650	AS9039	S-57122-2	AS9373	XA-2524-R	25240
S-11651	AS9082	S-103522	AS9394	XB-0011-2	44132
S-12405	AS8032			XB-21-S-375-1750	44133
S-12514-001	AS7403			XB-C-95	44136
S-12514-008	AS9122			XB-T-69-A	44137
S-12514-010	AS9122			XE-06356	44135
S-12514-013	AS8050				
S-12514-014	AS7135				
S-13031	AS9069				
S-13032	AS9422				
S-13041	AS7818				
S-13160	AS9121				
S-14249	AS9367				
S-14486	AS7795				
S-20010	AS9270				
S-20124	AS9265				
S-20127	AS9580				
S-20217	AS8944				
S-20223	AS9640				
S-20413	AS9265				
S-20806-1L	C603L				
S-20806-1R	C602R				
S-20901	AS8091				
S-21181	B8790				
S-21623	AS8755				
S-21717-1L	C601L				
S-21717-1R	C600R				
S-21784	AS8091				
S-21800	AS8709				
S-21966	AS8708				

INTERCHANGES

HOLLAND-NEWAY	SIRCO	HUTCHENS	SIRCO	HUTCHENS	SIRCO
570-06-902	AS6902	34-00	SH1039	16398-02	SH1041
570-06-910	AS6910	35-00	SH1016	16398-04	SH1042
570-07-136	AS7136	37-03	SH1011	16398-17	SH1043
570-07-140	AS7140	354-00	SH2726	16868-01	SH1030
570-07-410	AS7410	355-00	SH2727	17784-01	SH1050
570-07-818	AS7818	356-00	SH2728	19360-01	SH1031
570-08-008	AS8008	704-01	SH1025	H-9424-01	AS9039
570-08-050	AS8050	705-01	SH1031	H-9424-03	AS9039
570-09-219	AS9219	710-00	SH1032	H-9630-01	AS9082
570-09-321	AS9321	713-02	SH1041		
905-57-001	AS7135	713-05	SH1042		
905-57-006	AS9082	715-00	SH1029		
905-57-008	AS9101	719-02	SH1026		
905-57-009	AS9101	722-00	SH1001		
905-57-011	AS9039	729-00	SH1010		
905-57-023	AS9039	750-03	SH1021		
905-57-027	AS9082	756-00	SH1046		
905-57-033	AS9082	759-00	SH1045		
905-57-043	AS9101	837-00	SH1062		
905-57-082	AS9101	7010-00	SH1008		
905-57-085	AS9039	7016-01	SH1009		
905-57-086	AS9192	7029-00	SH1030		
905-57-108	AS9192	7040-06	5R783123		
905-57-112	AS9243	7040-10	5R783123		
905-57-117	AS9921	7040-11	5R783136		
905-57-118	AS9923	7040-12	5R783136		
905-57-120	AS9293	7040-13	5R783146		
905-57-121	AS9295	7040-14	5R783146		
905-57-129	AS9307	7040-15	5R783186		
905-57-135	AS9192	7040-21	5R783186		
905-57-156	AS9936	7052-02	SH1023		
905-57-157	AS9935	7701-01	SH1033		
905-57-160	AS9366	7701-02	SH1036		
905-57-173	AS8204	7702-01	SH1034		
905-57-203	AS6799	7702-02	SH1037		
905-57-223	AS8204	7703-01	SH1035		
905-57-225	AS9366	7703-02	SH1038		
905-57-257	AS7140	7816-05	5R785146		
905-57-300	AS9936	7816-13	5R785186		
905-57-301	AS9935	7816-14	5R785146		
905-57-306	AS9807	7816-18	5R785186		
905-570-019	AS9121	10287-01	SH1044		
905-570-052	AS9121	10562-00	SH1027		
905-570-078	AS9121	11154-00	SH1055		
		16146-01	SH1049		
		16150-01	SH1054		
		16158-01	SH1048		
		16169-01	SH1059		
		16171-01	SH1060		
		16290-01	SH1050		
		16353-01	SH1061		

INTERCHANGES

JOST	SIRCO	KENWORTH	SIRCO	LELAND	SIRCO
R9000B	KK-1A	C81-1004	AS9547	1308E	EF-1
		K-303-6	AS9422	1308Q	RF-3A
		K-303-14	AS9422	4515AQ	QK-1
		K-303-15	AS9422	4515AQHD	QK-1HD
		K-303-16	AS9616	4515AQM	QK-8
		K-303-22	AS9622	4515AQMHD	QK-8HD
				4515QMMHD	QK-2SHD
				4515X	XK-3
				4524MQ	MF-2
				4709ES1	ES-1
				4709ES2	ES-2
				K-42	EK-1HD
				K-43	FK-1
				K-44A	TK-1
				K-45	TK-4HD
				K-46	TK-7HD
				K-48	B8707A
				K-51	B8643A
				K-52	B8650A
				K-53	B8645A
				K-58	FK-2
				K-70	QK-1MP
				K-70A	QK-8
				K-77	MK-1HD
				K-81	B8707
				K-87	B8682
				K-88	B8649
				K-97	B8645
				K-105	LB-5
				K-106	LB-4A
				K-108	B8649A
				K-115	TK-1HD
				K-116	TK-4HD
				K-117	QK-1MP
				K-119	EK-1HD
				K-127	XK-1
				K-128	QK-1MPHD
				K-128A	QK-8HD
				K-128K	QK-1MPHD
				K-134	WF-1A
				K-136	XK-3MPHD
				K-137	LB-7
				K-138	B8657A
				K-139	B8647A
				K-140	B8648A
				K-141	B8684A
				K-144	B8682A
				K-145	B8655A
				K-146	B8656A
				K-147	B8712A
				K-149	B8644A

INTERCHANGES

LELAND	SIRCO	LELAND	SIRCO	LELAND	SIRCO
K-151	B8685ZA	K-329	QK-1HD	K4515Q20	L4515Q-20-QK1HD
K-152	B8686A	K-330	XK-3HD	K4515Q23	L4515Q-QK1HD
K-154	LB-3	K-332	QK-1HD	K4524MQ20	L4524M-MF2
K-259(2)	ARK	K-334	MF-2	K4524Q20	L4524Q-QK1HD
K-260	RF-1ARK	K-334K	MF-2	K4702Q20	L4702Q-RF5
K-263	EF-1	K-335	LB-9	K4707Q20	L4707Q-20-QK1HD
K-264	B8742A	K-336	LB-8	K4707Q23	L4707-QK1HD
K-265	RF-2ARK	K-337	B8655ZA	K4709E23	L4709N-ES2
K-268	B8681A	K-343	B8652	L-100	B500
K-269	B8683A	K-345	B8655	L-101	B499
K-270	B8683	K-346	B8656	L-103	BP-104
K-272	RC-1A	K-347	B8655Z	L-105	B501
K-273	B8743A	K-348	B8687	L-109	B901
K-274	RK-1	K-352	LB-1	L-110	B011
K-275	EK-2	K-353	LB-10D	L-112	B211
K-277	LB-2	K-355	B8792A	L-113	B311
K-279	LB-6	K-356	ES-3	L-115	B974
K-281	RK-2	K-357	B8648	L-118	B379
K-282	RF-3A	K-358	ES-4	L-120	B8610
K-283	RF-3	K-360	B8684	L-137	B8604
K-284	B955	K-361	B8790A	L-144A	583X
K-285	B8744	K-363	B8773M	L-144C	635X
K-289	B8683ZA	K-364	ET-1	L-144F	636X
K-292	MF-1	K-366	MF-3	L-144G	628X
K-293M	MK-2HD	K-368	B8681	L-149	B941
K-295	ES-1	K-369	LB-3D	L-151	B151
K-296	B8746A	K-372	XK-3MPHD	L-152	B251
K-297	FF-1	K-373	LB-10	L-158	B586
K-298	FF-1A	K-374	SF-1	L-166	B8600
K-299	FR-1	K-375	ES-2	L-167	B8603
K-300	FR-1A	K-376	EF-2	L-168	B861
K-301	B8795A	K-377	LB-11	L-179	B971
K-302	B8796A	K-379	KK-1A	L-173	C424R
K-303	QK-2S	K-481	B8794	L-174	C425L
K-303K	QK-2S	K-482	B8797R	L-176	5210
K-304	QK-2SHD	K-483	B8797L	L-177	5300
K-304K	QK-2SHD	K-489	B8683Z	L-178	5200
K-305	XL-1	K-490	B8772M	L-192	B8605
K-306	QK-1	K-491	B8788	L-193	B8607
K-310	B8771A	K-493	B8742	L-196EC	S2010A
K-312	B8793A	K-494	B8797	L-202	B8608
K-313	B8773MA	K-495	ES-12	L-224	C689R
K-314	B8652A	K-499	B8746	L-225	C688L
K-315	XK-3	K-501	LB-10R	L-234	C686R
K-316	EK-3	K-503	B8805	L-235	C687L
K-318	RF-5	K-504K	RF-6	L-238	B832
K-318K	RF-5	K-505	B8792	L-239	B932
K-320	K-1A	K-506	B8790	L-242	B8713
K-320(2)	K-1	K1308E20	L1308E-EF1	L-250	B052
K-322	EQ-1	K1308QL	L1308Q-RF3	L-251	B152
K-327	B8687A	K4515FX323	L4515X-XK3HD	L-260	BP-105

INTERCHANGES

LELAND	SIRCO	LELAND	SIRCO	LELAND	SIRCO
L-261	C412R	L-897	B8622	L-1418	B302
L-262	C413L	L-898	B8623	L-1475	B922
L-264	634X	L-899	B8734	L-1476	C444R
L-266	B8601	L-902	C716R	L-1477	C443L
L-294	B611	L-903	C717L	L-1496	B377
L-324	B423	L-966	B8612A	L-1498	B888S
L-326	B055	L-967	B769	L-1533	B911
L-329	B8609	L-1023	C100R	L-1534	B942
L-330	B667	L-1024	C101L	L-1535	B358
L-331	B8689	L-1034	B426	L-1536	B8602
L-344	B8611	L-1035	B427	L-1537	B161
L-345	700	L-1074	C410R	L-1594	B8616
L-385	B256	L-1075	C411L	L-1598	B8688
L-397	B793	L-1191	B8624	L-1600	B425
L-402	B807	L-1198	B8714	L-1603	B983
L-430	BP-109	L-1202	C775R	L-1606	B8722
L-453	9018-1	L-1203	C776L	L-1608	B8630
L-454	9009G	L-1204	C773R	L-1609	B8629
L-467	B8634	L-1205	C774L	L-1617	C694R
L-470	BP-110	L-1209	B424	L-1618	C693L
L-507	C147R	L-1275	S2025	L-1619	C786R
L-508	C148L	L-1280	B133	L-1620	C787L
L-515	999X	L-1281	B132	L-1622	B053
L-562	S2021A	L-1294	B8628	L-1623	B154
L-566	BP-108	L-1295	B8626	L-1624	B982
L-573	BP-100	L-1296	B8627	L-1625	B770
L-574	BP-106	L-1298	C442R	L-1631	C799R
L-580	C095L	L-1299	C441L	L-1632	C800L
L-581	C094R	L-1305	B8661	L-1641	B8665
L-594	B495	L1308E20	L1308E	L-1642	B8736
L-595	B595	L-1308EC	S2022A	L-1646	B923
L-733	C422R	L1308QL	L1308Q	L-1648EC	S2019A
L-734	C423L	L-1327	5660	L-1649	B8735
L-735	C420R	L-1331	2296	L-1651	C448R
L-736	C421L	L-1332	2298	L-1652	C447L
L-752	B8635	L-1333	2297	L-1653	C452R
L-788	B887	L-1334	2299	L-1654	C451L
L-827	B728	L-1353	2305	L-1655	C450R
L-835	B981	L-1354	2304	L-1656	C449L
L-838	C563L	L-1355	2303	L-1657	C446R
L-839	C564R	L-1368	B216	L-1658	C445L
L-841EC	S2012A	L-1369	B392	L-1670	B823
L-845EC	S2020A	L-1370	B380	L-1671	B829
L-885	9013	L-1371	B8632	L-1673	B829
L-888	B888	L-1372	B8631	L-1674	B829
L-889	B988	L-1373	B362	L-1687	B717
L-891	B8660	L-1395	5401	L-1693	B870
L-893	5402	L-1412	C478R	L-1695	B869
L-894	B498	L-1413	C479L	L-1696	B054
L-895	B8619	L-1416	B120	L-1697	B868
L-896	B8620	L-1417	B220	L-1700	9014

INTERCHANGES

LELAND	SIRCO	LELAND	SIRCO	LELAND	SIRCO
L-1701	9015	L-2353	B134	L-2881	C894L
L-1711	B8699	L-2356	C090R	L-2882	C728R
L-1718	B8733	L-2357	C089L	L-2883	C729L
L-1719	B8697	L-2364	B277	L-2884	C730R
L-1724	B811	L-2367	B218	L-2885	C731L
L-1726	B8609	L-2368	B217	L-2888	C732R
L-1729	B8621	L-2370	B349	L-2889	C733L
L-1730	B8636	L-2382	B8698	L-2890	C086R
L-1734	B579	L-2387	B8717	L-2891	C085L
L-1736	B262	L-2401	C881R	L-2897	C855R
L-1743	B8756	L-2402	C880L	L-2898	C854L
L-1744	B8755	L-2438	C714R	L-2900	B8691
L-1745	B8759	L-2439	C715L	L-2921	9009
L-1746	B8754	L-2440	C794R	L-2926	B8765
L-1747	B8757	L-2441	C795L	L-2927	B8718
L-1748	B8758	L-2450	C708R	L-2928	B8719
L-1751	B556	L-2451	C709L	L-2930	B950
L-1753	B230	L-2452	C702R	L-2931	B952
L-1762	5403	L-2453	C703L	L-2932	B953
L-1766	B8615	L-2456	C706R	L-2933	B954
L-1767	B8614	L-2457	C707L	L-2934	B951
L-1768	B8613	L-2466	C720R	L-2938	B8761
L-1770	B8612	L-2467	C721L	L-2939	B8760
L-1904	1904	L-2482	C889R	L-2940	B794
L-1908	1908	L-2483	C888L	L-2941	B8625
L-1909	1909	L-2494	S2026	L-2942	B8782
L-1910	1910	L-2707	B8725	L-2944	B8787
L-1912	1912	L-2711	B8727	L-2945	B961
L-1913	1913	L-2712	B8728	L-2947	B960
L-1914	1914	L-2811	B725	L-2948	C885R
L-1915	1915	L-2825	B999	L-2949	C884L
L-1917	1917	L-2829	B562	L-2952	B122
L-1919	1919	L-2830	B8751	L-2953	B221
L-1920	1920	L-2831	B8750	L-2954	B924
L-1921	1921	L-2832	B8752	L-2960	B430K
L-1922	1922	L-2833	B8753	L-2961	B431
L-1923	1923	L-2843	B871	L-2963	B8763
L-1925	1925	L-2854	B8696	L-2966	C495R
L-1927	1927	L-2858	B972	L-2967	C494L
L-1940	5000	L-2859	B973	L-2968	C497R
L-2089	C796R	L-2868	C500R	L-2969	C496L
L-2090	C797L	L-2869	C499L	L-2970	C491R
L-2338	C352R	L-2870	C897R	L-2971	C490L
L-2339	C351L	L-2871	C896L	L-2974	C493R
L-2340	C350R	L-2872	C348R	L-2975	C492L
L-2341	C349L	L-2873	C347L	L-2976	C770R
L-2342	C734R	L-2874	C650R	L-2977	C769L
L-2343	C735L	L-2875	C649L	L-2983	B137
L-2349	S2023	L-2876	C726R	L-2984	B136
L-2351	B308	L-2877	C727L	L-2985	B139
L-2352	B135	L-2880	C895R	L-2987	B138

INTERCHANGES

LELAND	SIRCO	LELAND	SIRCO	LELAND	SIRCO
L-2993	B142	L-3106	C676R	L-3289	C935L
L-2994	B143	L-3107	C675L	L-3290	C513R
L-2995	B144	L-3108	C680R	L-3291	C512L
L-2996	B141	L-3109	C679L	L-3292	C517R
L-3003	SA21103	L-3110	C682R	L-3293	C516L
L-3004	SA21102	L-3111	C681L	L-3306	C928R
L-3005	SA22103	L-3112	C442BR	L-3307	C927L
L-3006	SA22102	L-3112	C866R	L-3308	C531R
L-3007	SA23106	L-3113	C441BL	L-3309	C530L
L-3009	SA24100	L-3113	C867L	L-3310	C103R
L-3010	SA25100	L-3114	C444BR	L-3311	C102L
L-3026	C722R	L-3114	C870R	L-3318	C862R
L-3027	C723L	L-3115	C443BL	L-3319	C861L
L-3029	B8600A	L-3115	C871L	L-3320	C911R
L-3030	C519R	L-3116	C446BR	L-3321	C910L
L-3031	C518L	L-3116	C869R	L-3322	C753R
L-3033	B8783	L-3117	C445BL	L-3323	C752L
L-3034	C883R	L-3117	C868L	L-3324	C764R
L-3035	C882L	L-3118	B350	L-3325	C763L
L-3038	C646R	L-3124	C743R	L-3326	C755R
L-3039	C645L	L-3125	C742L	L-3327	C754L
L-3040	B8725A	L-3126	B348	L-3330	C186R
L-3043	B8783	L-3127	B805	L-3331	C185L
L-3044	C527R	L-3144	C056R	L-3334	C084R
L-3045	C526L	L-3145	C055L	L-3335	C083L
L-3046	C099R	L-3146	B8606A	L-3338	C678R
L-3047	C098L	L-3148	B307	L-3339	C677L
L-3056	B8690	L-3161	SA22953	L-3350	C426R
L-3057	B8784	L-3170	C760R	L-3351	C427L
L-3058	B8785	L-3171	C759L	L-3352	SA21953
L-3063	S2002	L-3173	B433	L-3358	C220R
L-3068	B8786	L-3175	B436	L-3359	C219L
L-3069	B956	L-3178	B800	L-3363	B8781
L-3072	C521R	L-3183	B347	L-3364	B8634A
L-3073	C520L	L-3200	C058R	L-3369	B434
L-3076	C887R	L-3201	C057L	L-3370	B432A
L-3077	C886L	L-3202	C060R	L-3376	C973R
L-3078	C741R	L-3203	C059L	L-3377	C972L
L-3079	C740L	L-3213	5300S	L-3378	C315R
L-3090	C505R	L-3225	S2024	L-3379	C314L
L-3091	C504L	L-3240	C097R	L-3380	C515R
L-3092	C656R	L-3241	C096L	L-3381	C514L
L-3093	C655L	L-3276	C906R	L-3391	702
L-3096	C522R	L-3277	C905L	L-3398	C652R
L-3097	C524L	L-3282	C932R	L-3399	C651L
L-3098	C536R	L-3283	C931L	L-3402	C670R
L-3099	C537L	L-3284	C313R	L-3403	C669L
L-3100	C594R	L-3285	C312L	L-3406	C738R
L-3101	C595L	L-3286	C934R	L-3407	C737L
L-3104	C732AR	L-3287	C933L	L-3414	C658R
L-3105	C733AL	L-3288	C936R	L-3415	C657L

INTERCHANGES

LELAND	SIRCO	LELAND	SIRCO	LELAND	SIRCO
L-3416	C654R	L4524Q20	L4524Q	W-237	098
L-3417	C653L	L4702Q20	L4702Q	W-246	411
L-3418	C666R	L4707Q20	L4707Q-20	W-256	722
L-3419	C665L	L4707Q23	L4707	W-257	138
L-3424	C311R	L4709E23	L4709N	W-258	110
L-3425	C310L	LBW1308Q	RF-3	W-264	204
L-3436	C648R	LNC105	805	W-265	205
L-3437	C647L	SA1201	B429	W-274	482
L-3444	C608R	W-3	123	W-275	481
L-3445	C609L	W-4	235	W-276	287R
L-3482	C668R	W-5	654	W-277	287L
L-3483	C667L	W-6	715	W-278	375
L-3484	B8150R	W-7	149	W-279	376
L-3485	B8150L	W-8	716	W-280	373
L-3501	B434S	W-11	708AR	W-281	374
L-3506	C684R	W-12	709AL	W-372	066
L-3507	C683L	W-13	891AR	W-373	067
L-3543	9013A	W-14	892AL	W-380	414
L-3556	C533R	W-15	888R	W-381	415
L-3557	C532L	W-16	889L	W-395	412
L-3568	3568	W-38	096	W-396	413
L-3569	3569	W-39	095	W-399	447
L-3570	3570	W-40	988	W-400	448
L-3571	3571	W-41	989	W-405	708
L-3574	C664R	W-42	990	W-406	053
L-3575	C663L	W-43	991	W-407	729
L-3576	C757R	W-44	004	W-408	853
L-3577	C756L	W-45	005	W-415	515
L-3578	C751R	W-46	124	W-416	544
L-3579	C750L	W-47	125	W-417	545
L-3580	C762R	W-50	271	W-418	725
L-3581	C761L	W-51	272	W-420	314
L-3598	C612R	W-64	191	W-448	238
L-3599	C611L	W-65	192	W-449	236
L-3602	9009P	W-66	263	W-450	257
L-3604	SA10100	W-67	264	W-451	073
L-3605	SA10101	W-68	968	W-451	806
L-3606	SA10102	W-69	969	W-456	008
L-3607	SA10103	W-70	851	W-463	012
L-3608	SA10144	W-71	852	W-464	011
L-3610	SA10212	W-72	183	W-467	233
L-3611	SA10214	W-73	184	W-486	988R
L-3612	SA10215	W-115	912R	W-487	988L
L-3613	SA10216	W-116	913L	W-489	884
L-3614	SA10305	W-120	993	W-490	882
L-3615	SA10306	W-124	399	W-491	883
L-3618	SA10211	W-135	267	W-492	881M
L4515FX323	L4515X	W-166	438	W-494	201
L4515Q20	L4515Q-20	W-167	439	W-495	336
L4515Q23	L4515Q	W-184	302	W-496	334
L4524MQ20	L4524M	W-236	097	W-497	335

INTERCHANGES

LELAND	SIRCO	LELAND	SIRCO	LOADGUARD	SIRCO
W-498	333B	W-720	306R	SC2120	AS9367
W-504	449	W-721	306L	SC2131	AS8018
W-505	450	W-722	304R	SC2770	AS9287
W-506	995R	W-723	304L		
W-507	995L	W-730	434		
W-508	996R	W-731	435		
W-509	996L	W-748	716S		
W-525	920	W-765	366		
W-536	256	W-766	978R		
W-544	164	W-767	978L		
W-545	162	W-787	367		
W-546	160				
W-548	416				
W-549	417				
W-562	807				
W-563	808				
W-564	809				
W-565	251				
W-575	948				
W-576	947				
W-608	420				
W-609	421				
W-610	133				
W-611	134				
W-616	897R				
W-617	897L				
W-619	919				
W-620	896R				
W-621	896L				
W-623	921				
W-656	422				
W-657	423				
W-664	424				
W-665	425				
W-669	676				
W-674	418				
W-675	419				
W-676	451				
W-680	426				
W-681	427				
W-686	428				
W-687	429				
W-689	367				
W-700	430				
W-701	431				
W-702	437				
W-706	432				
W-707	433				
W-708	436				
W-718	452				
W-719	453				

INTERCHANGES

MACK	SIRCO	MERITOR	SIRCO	MERITOR	SIRCO
364QS27	AS9375	5X640	B901	1229Z1118	B8604
364QS28	AS9466	1107D56	B8758	1229G1463	B8608
57QL414M	AS9375	1199A625	B500	1229V1504	B954
		1199E1695	B932	1229V1556	B556
		1199A3719	B922	1229B1848	B988
		1199G3725	B725	1229N2250	B8718
		1199U3765	B923	1229S2697	B8719
		1205K193	B011	1229Q2851	B8691
		1205N430	B8713	1229D2942	B8689
		1205X726	B8621	1229X3118	B960
		1205G761	B8690	1229J3130	B8762
		1205N924	B8613	1229T3166	B379
		1205M1105	B8612	1229J4092	B794
		1205V1452	B8626	1229R4100	B8784
		1205Q2123	B8625	1229S4101	B8785
		1218Z52	BP-107	1229T4102	B8634A
		1218G85	B423	1229A4135	B961
		1218C107	B973	1229B4136	B8786
		1225F266	B211S	1229C4137	B8787
		1225X440	BP-108	1229E4685	B8781
		1225G449	B595S	1245C185	S2000
		1225B496	B888S	1246G475	B499
		1225R512	B667	1246F1020	B134
		1225J634	B8614	1259X76	BP-104
		1225A781	B8615	1259N170	B832
		1225X804	B8665	1259L194	BP-110
		1225A833	B8628	1259J218	B887
		1225B834	B8627	1259Q251	B251
		1225M897	B8754	1259R252	B311
		1225C939	B8759	1259B262	B262
		1225R1058	B8636	1259N274	B120
		1225R1136	B8760	1259V308	B122
		1225N1158	B8782	1259X1012	B950
		1225L1208	B8600A	1718Y103	B151
		1225S1267	B495S	1779C81	B611
		1227B106	2296	1779D82	B586
		1227U541	2299	1779J114	BP-105
		1227C549	5210	1779L116	BP-109
		1227B756	5200	2205P1004	B951
		1229R122	B8607	2210H2946	C090R
		1229B236	B8756	2210J2948	C089L
		1229Q277	B8757	2210R4178	C448R
		1229P302	B230	2210S4179	C447L
		1229F474	2298	2210T4180	C452R
		1229G475	2297	2210U4181	C451L
		1229M559	B8611	2210V4182	C450R
		1229Q771	B8605	2210W4183	C449L
		1229E811	B811	2210L4328	C442R
		1229L844	B8765	2210M4329	C441L
		1229J868	B8610	2210N4330	C446R
		1229X1116	B793	2210P4332	C445L

INTERCHANGES

MERITOR	SIRCO	MERITOR	SIRCO	MERITOR	SIRCO
2210Q4333	C444R	2210Z5720	C703L	2210D7492	C656R
2210R4334	C443L	2210K5783	C084R	2210E7493	C655L
2210U5325	C350R	2210L5784	C083L	2210K7499	C540R
2210V5326	C349L	2210Z6318	C689R	2210L7500	C541L
2210W5327	C895R	2210A6319	C688L	2210Z7514	C658R
2210X5328	C894L	2210Z6344	C885R	2210A7515	C657L
2210A5331	C352R	2210A6345	C884L	2210H7522	C522R
2210B5332	C351L	2210U6573	C092R	2210J7524	C524L
2210C5333	C730R	2210V6574	C091L	2210V7536	C536R
2210D5334	C731L	2210W6575	C082R	2210W7537	C537L
2210G5337	C500R	2210X6576	C081L	2210B7542	C664R
2210H5338	C499L	2210N6592	C088R	2210C7543	C663L
2210K5341	C728R	2210P6594	C087L	2210K7551	C666R
2210L5342	C729L	2210H6820	C505R	2210L7552	C665L
2210W5353	C773R	2210J6822	C504L	2210B7568	C668R
2210X5354	C774L	2210D6842	C750L	2210C7569	C667L
2210A5357	C708R	2210E6843	C751R	2210T7586	C670R
2210B5358	C709L	2210F6844	C752L	2210U7587	C669L
2210C5359	C147R	2210G6845	C753R	2210B7594	C594R
2210D5360	C148L	2210M6851	C754L	2210C7595	C595L
2210E5361	C348R	2210N6852	C755R	2210P7608	C568R
2210F5362	C347L	2210R6856	C756L	2210Q7609	C569L
2210M5369	C734R	2210S6857	C757R	2210H7626	C676R
2210N5370	C735L	2210V6860	C763L	2210J7628	C675L
2210G5389	C881R	2210W6861	C764R	2210Z7644	C678R
2210H5390	C880L	2210X6862	C761L	2210A7645	C677L
2210K5393	C186R	2210Y6863	C762R	2210H7652	C680R
2210L5394	C185L	2210B6866	C442BR	2210J7654	C679L
2210M5395	C732R	2210B6866	C866R	2210Z7670	C682R
2210N5396	C733L	2210C6867	C441BL	2210A7671	C681L
2210E5413	C424R	2210C6867	C867L	2210M7683	C307R
2210F5414	C425L	2210D6868	C446BR	2210N7684	C306L
2210G5415	C883R	2210D6868	C869R	2210R7688	C684R
2210H5416	C882L	2210E6869	C445BL	2210S7689	C683L
2210S5427	C650R	2210E6869	C868L	2210V7692	C584R
2210T5428	C649L	2210F6870	C444BR	2210W7693	C585L
2210Y5433	C726R	2210F6870	C870R	2210K7837	C732AR
2210Z5434	C727L	2210G6871	C443BL	2210L7838	C733AL
2210E5439	C897R	2210G6871	C871L	2210Q8155	C442BR
2210F5440	C896L	2210K7395	C646R	2210R8156	C441BL
2210K5445	C086R	2210L7396	C645L	2210S8157	C444BR
2210L5446	C085L	2210X7408	C648R	2210T8158	C443BL
2210U5455	C899R	2210Y7409	C647L	2210U8159	C446BR
2210V5456	C898L	2210P7426	C426R	2210V8160	C445BL
2210W5639	C478R	2210Q7427	C427L	2247X128	B924
2210X5640	C479L	2210F7442	C652R	2257T1060	B955
2210Q5711	C714R	2210G7443	C651L	2258V256	B256
2210R5712	C715L	2210T7456	C654R	2258K349	B974
2210W5717	C706R	2210U7457	C653L	2258P354	B971
2210X5718	C707L	2210T7482	C505R	2258J400	BP-106
2210Y5719	C702R	2210U7483	C504L	2258Z416	B728

INTERCHANGES

MERITOR	SIRCO	MERITOR	SIRCO	MERITOR	SIRCO
2258G579	B579	KIT 8061	RF-3A	R001561	5402
2258R590	B972	KIT 8078A	B8773MA	R001597A	9012
2258Q615	B220	KIT 8081	MF-2	R002091	S2025
2258U619	B302	KIT 8091	B8773M	R002237	5660
2258S643	B347	KIT 8289	B8788	R002296	2296
2258B704	B308	KIT 8824HD	RF-5	R002297	2297
2258W803	B349	KIT 9017N	TK-1	R002298	2298
2258X804	B221	KIT 9034	B8661	R002299	2299
2258E1123	B953	KIT 9035	B8686	R002303	2303
2258K1181	B952	KIT 9036	B8660	R002304	2304
2258L1234	B956	KIT 9078	B8646	R002305	2305
2258Y1273	B348	KIT 9078A	B8646A	R002545	802W
2258J1440	BP-100	KIT 9081	RK-3	R002547	800W
2297C5021	B135	KIT 9094	RF-1ARK	R002550	5401
3105B210	B161	KIT 9179	RK-1	R002991	805
3256E5	5000	KIT 9300	B8743	R003130L	306L
202796	AS8729	KIT 9304	RC-1	R003130R	306R
A1205V1556	B8609	KIT 9425	ARK	R003520AHD	B8683HD
A1205P1602	B8755	KSF5234524Q	L4524Q-QK1HD	R004075	9013
A1205S1943	B501	KSF5404515Q	L4515Q-20-QK1HD	R004956A	715
A1205D2110	B8761	KSF5404707QP	L4707Q-20-QK1HD	R004958	654
A1229W2545	5300S	KSF5504515Q	L4515Q-QK1HD	R004961A	073
A3105V282	B8696	KSF5504707QP	L4707-QK1HD	R004961A	806
A3105L1078	B8783	KSF5554515F3	L4515X-XK3HD	R004962	149
A3275J686	S2023	KSF5554702QP	L4702Q-RF5	R004963	716
A3299T5844	B8736	KSF5554709E2	L4709N-ES2	R004965L	192
KIT 969	B8644	KSF5571308E	L1308E-EF1	R004965R	191
KIT 970	B8645	KSF5571308Q	L1308Q-RF3	R004966L	264
KIT 1125	RF-2ARK	KSMA2121443E	L1443E-EF1	R004966R	263
KIT 1759	B8735	KSMA2121443EQ	L4311J-EK1HD	R004967L	969
KIT 1760 (1/2)	B8783	MKT1308E	EF-1	R004967R	968
KIT 6003	BK-145R	MKT1308Q	RF-3	R004968L	852
KIT 6004	BK-145F	MKT1308T	RF-1ARK	R004968R	851
KIT 8000	QK-1	MKT4311EHDK	EK-1HD	R004969L	184
KIT 8000HD	QK-1HD	MKT4515PHDK	TK-4HD	R004969R	183
KIT 8000MB	QK-8	MKT4515PK	TK-4	R005032	SR1020
KIT 8000MBHD	QK-8HD	MKT4515QHDK	QK-1HD	R005040AG	993
KIT 8002HD	K-1A	MKT4515QK	QK-1	R005500	9014
KIT 8002HD(2)	K-1	MKT4515QMBHDK	QK-8HD	R005551L	125
KIT 8004	LB-3	MKT4515QMBK	QK-8	R005551R	124
KIT 8014	QK-2S	MKT4515UHDK	QK-2SHD	R005553L	272
KIT 8014HD	QK-2SHD	MKT4515UK	QK-2S	R005553R	271
KIT 8022	B8744A	MKT4515XHDK	XK-3HD	R005556L	095
KIT 8026HD	MK-2HD	MKT4515XK	XK-3	R005556R	096
KIT 8029	RF-3	MKT4702KTK	RF-5	R005559L	989
KIT 8033 (2)	B8766	MKT4709ES	ES-1	R005559R	988
KIT 8037	MF-3	MKT4709ES2	ES-2	R005560L	005
KIT 8042	B8707	N-112-1	073	R005560R	004
KIT 8046	B8681	R000573	5300	R005561L	991
KIT 8048	B8683	R000943	B8635	R005561R	990
KIT 8058	B8772M	R001559	5403	R005571AG	123

INTERCHANGES

MERITOR	SIRCO	MERITOR	SIRCO	MERITOR	SIRCO
R005572AG	235	R005977L	892BL	R009008L	429
R005579L	913L	R005977R	891BR	R009008R	428
R005579R	912R	R005978L	978L	R009010L	431
R005652L	889L	R005978R	978R	R009010R	430
R005652R	888R	R005987L	415	R009020	920
R005706	411	R005987R	414	R009021	921
R005720L	439	R005988L	988L	R009023G	725
R005720R	438	R005988R	988R	R0010208L	433
R005747	267	R005991	881M	R0010208R	432
R005756L	067	R005992A	883	R0010210L	435
R005756R	066	R005993	884	R0010210R	434
R005757L	376	R005994	882	R0010217	452
R005757R	375	R005995L	995L	R0010219	436
R005765L	098	R005995R	995R	R0010220	453
R005765R	097	R005996L	996L	R0010221	437
R005766L	374	R005996R	996R	R0010235	919
R005766R	373	R005997	335	R0010254L	304L
R005781G	238	R005998	334	R0010254R	304R
R005783	236	R005999	336	R0010676	676
R005784AG	708	R006000	333B	R0011445	B8150L
R005785G	053	R006034	160	R0011446	B8150R
R005821G	233	R006035	162	R30907	SR1010
R005827G	256	R006036	164	R30927	SF1011
R005828G	257	R006053G	251	R30934	SH1001
R005829	302	R006054G	201	R30937	SR1011
R005838G	729	R006057L	417	R64024	9024
R005871L	481	R006057R	416	R64024G	9024G
R005871R	482	R007775	716S	R64075A	9013A
R005885G	008	R007895L	709AL	R301018	SF1010
R005889	515	R007895R	708AR	R301019	SF1003
R005890	544	R007896L	896L	R301020	SF1004
R005891	545	R007896R	896R	R301021	SF1005
R005896L	287L	R007897L	897L	R301023	SF1009
R005896R	287R	R007897R	897R	R301024	SF1002
R005900L	448	R008947L	947	R301074	SF1012
R005900R	447	R008947R	948	R301159	SR1002
R005902G	722	R008949L	450	R301160	SR1008
R005904A	138	R008949R	449	R301166	SR1009
R005905AG	110	R008968L	419	R301307	B8662
R005910L	413	R008968R	418	R301312A	SR1007
R005910R	412	R008969L	421	R301971	SR1018
R005924L	205	R008969R	420	R301972	SR1017
R005924R	204	R008979L	134	R301974	SR1019
R005926G	853	R008979R	133	R301975	SR1016
R005927G	399	R008980	422	R301980	SB1004
R005931L	011	R008981	423	R301986A	SR1004
R005931R	012	R008982L	425	R301987	SR1006
R005953G	314	R008982R	424	R301999A	SH1008
R005970	807	R008983L	427	R302000	SH1009
R005971	808	R008983R	426	R302001	SH1010
R005972	809	R008986	451	R302002	SH1011

INTERCHANGES

MERITOR	SIRCO	MERITOR	SIRCO	MERITOR	SIRCO
R302003	SH1012	R303415	SH1045	R309471	SH1050
R302514	SF1008	R303416	SH1046	R309472	SH1053
R302515	SF1007	R303972	SR1003	R309473	SH1053U
R302545	SH1063	R303975	B428	R309474	SH1012U
R302546	SH1016	R303975	SR1005	R309475	SH1061
R302547	SH1094	R303976	SR1001	R309486	SH1040U
R302548	SH1062	R304358	SH1055	R309545	SR1007U
R302781A	SH1021	R304804	ST1010	R309555	SR1001U
R302826	SF1020	R304805	ST1011	R309567	SH1048U
R302827	SF1021	R304806	ST1012	R309582	SH1060
R302828	SF1022	R304807	ST1013L	R309603	SH1092
R302829	SF1019	R304808	ST1013R	R309604	SH1093
R302830	SF1000	R304809	ST1014	R309605	SH1080
R302832	SF1006	R304810	ST1015L	R309606	SH1081
R302833	SF1013	R304811	ST1015R	R309607	ST1008
R302836	SF1018	R304813	ST1000	R3010250	ST1001
R302837	SF1017	R304814	ST1017	R30U5161-12	5R783123
R302838	SF1016	R304818	ST1018	R30U5161-13	5R783136
R302839	SF1015	R304824	SB1007	R30U5161-14	5R783146
R302840	SF1014	R304825	ST1005	R30U5161-15	5R783156
R302842	SH1023	R304827	ST1003	R30U5161-16	5R783166
R302846A	SR1000	R304828	ST1019	R30U5161-18	5R783186
R302855	SR1014	R304830	ST1004	R30U5163-14	5R7835146
R302856	SR1015	R304832	ST1002	R30U5163-18	5R7835186
R302889	SH1025	R304833	ST1007	R30U5165-12	5R785123
R302891	SH1026	R304834A	ST1006	R30U5165-14	5R785146
R302892	SH1027	R304835	SH1057	R30U5165-15	5R785156
R302899	SH1029	R304837	ST1009	R30U5165-16	5R785166
R302907A	SH1030	R307432	SF1004U	R30U5165-18	5R785186
R302908	SH1031	R307433	SF1011U	R30U8151-12	8R343123
R302909	SH1032	R307452	SH1008U	R30U8151-18	8R343186
R302910A	SH1033	R307453	SH1001U	R30U8154-18	8R344186
R302911	SH1034	R307520	SB1004U	R30U8161-12	8R783123
R302912A	SH1035	R307523	SR1008U	R30U8161-13	8R783136
R302913A	SH1036	R307532	SH1048	R30U8161-14	8R783146
R302914	SH1037	R307533	SH1054	R30U8161-15	8R783156
R302915A	SH1038	R307534	SH1059	R30U8161-16	8R783166
R302975	SH1095	R307621	SH1049	R30U8161-17	8R783176
R303000	SH1082	R307918	SH1021U	R30U8161-18	8R783186
R303001	SH1064	R308653	SR1002U	R30U8165-12	8R785123
R303002A	SH1039	R308666	SH1049U	R30U8165-13	8R785136
R303003	SH1083	R308931	SF1001	R30U8165-14	8R785146
R303004	SH1084	R309302	SB1009	R30U8165-16	8R785166
R303005	SH1085	R309303	SB1010	R30U8165-18	8R785186
R303079	SH1040	R309304	SB1011	R507000	LB-4
R303276	SH1041	R309305	SB1000	R507002	EK-1HD
R303277	SH1042	R309307	SB1008	R507004	EF-1
R303283A	SR1012	R309308	SB1016	R507005	LB-5
R303284A	SR1013	R309309	SB1015	R507006	XK-1
R303390	SH1043	R309361	SF1002U	R507007	XK-1HD
R303414	SH1044	R309362	SF1009U	R507008	XK-3

INTERCHANGES

MERITOR	SIRCO	MERITOR	SIRCO	MERITOR	SIRCO
R507010	XK-3HD	R547004	B380	R607042	C717L
R507011	FK-1	R547008	B888	R607043	C718R
R507012	FK-1HD	R547010	B217	R607044	C719L
R507013	FK-2	R547011	B218	R607045	C720R
R507015	LB-1	R547019	B823	R607046	C721L
R507057	ES-1	R547022	B898	R607047	C722R
R507061	EX-1	R557001	B362	R607048	C723L
R507062	EQ-1	R567001	B983	R607063	C690R
R507063	XL-1	R567002	B869	R607064	C691L
R507064	ES-2	R567003	B427	R607065	C448AR
R507072	EK-2	R567004	B426	R607066	C447AL
R507073	WF-1	R567005	B307	R607067	C452AR
R507074	LB-2	R567006	B981	R607068	C451AL
R507076	LB-6	R567009	B562	R607069	C450AR
R507077	EK-3	R567012	B433	R607070	C449AL
R507078	LB-7	R567013	B436	R607071	C773CR
R507080	FF-1	R567015	B870	R607072	C774CL
R507081	FR-1	R567022	B350	R607073	C708BR
R507082	FR-1S	R567027	B982	R607074	C709BL
R507083	ES-4	R567028	B770	R607075	C147CR
R507086	ES-3	R567501	B999	R607076	C148CL
R507088	LB-9	R567502	B769	R607081	C424AR
R507090	LB-8	R567503	B432A	R607082	C425AL
R507092	LB-10	R567505	B434	R607083	C412AR
R507093	LB-11	R577001	B358	R607084	C413AL
R507094	EF-2	R587001	B429	R607089	C710BR
R507095	LB-3D	R607001	C094R	R607090	C711BL
R507096	SF-1	R607002	C095L	R607091	C478BR
R509000	TK-4	R607005	C410R	R607092	C479BL
R509001	TK-4HD	R607006	C411L	R607093	C714AR
R509002	TK-1HD	R607007	C420R	R607094	C715AL
R509004	TK-7	R607008	C421L	R607095	C706BR
R509406	MK-1HD	R607009	C422R	R607096	C707BL
R509408	RK-2	R607010	C423L	R607097	C702BR
R509409	TK-7HD	R607011	C563L	R607098	C703BL
R517002	B054	R607012	C564R	R607103	C055L
R517003	B133	R607015	C775R	R607104	C056R
R517005	B425	R607016	C776L	R607105	C492L
R517006	B052	R607019	C100R	R607106	C493R
R517016	B053	R607020	C101L	R607107	C496L
R517017	B154	R607025	C694R	R607108	C497R
R517506	B132	R607026	C693L	R607109	C494L
R517509	B152	R607029	C786R	R607110	C495R
R517510	B430K	R607030	C787L	R607111	C490L
R527001	B868	R607031	C794R	R607112	C491R
R527002	B498	R607032	C795L	R607113	C059L
R537001	B216	R607033	C796R	R607114	C060R
R537003	B424	R607034	C797L	R607115	C057L
R537004	B377	R607035	C799R	R607116	C058R
R537005	B277	R607036	C800L	R607125	C888L
R547003	B392	R607041	C716R	R607126	C889R

INTERCHANGES

MERITOR	SIRCO	MERITOR	SIRCO	MERITOR	SIRCO
R607153	C769L	R607254	C760R	R627002	B8619
R607154	C770R	R607261	C886L	R627005	B8629
R607161	C862R	R607262	C887R	R627006	B8630
R607162	C861L	R607267	C603L	R627008	B8612A
R607169	C854L	R607268	C602R	R627009	B8616
R607170	C855R	R607273	C905L	R627012	B8722
R607171	C856L	R607274	C906R	R627014	B8634
R607172	C857R	R607277	C910L	R627017	B8622
R607173	C516L	R607278	C911R	R627024	B8631
R607174	C517R	R607279	C740L	R627025	B8632
R607175	C514L	R607280	C741R	R627026	B717
R607176	C515R	R607317	C312L	R627027	B795
R607177	C512L	R607318	C313R	R627029	B8750
R607178	C513R	R607319	C314L	R627030	B8751
R607179	C518L	R607320	C315R	R627031	B8752
R607180	C519R	R607323	C607L	R627032	B8753
R607181	C520L	R607324	C606R	R627033	B8763
R607182	C521R	R607325	C609L	R627034	B805
R607183	C526L	R607326	C608R	R627043	B800
R607184	C527R	R615000	B8712	R627044	B801
R607185	C611L	R615001	B8682	R630002	B8733
R607186	C612R	R615002	B8648	R630003	B8714
R607189	C890L	R615003	B8647	R630005	B8717
R607190	C891R	R615004	B8684	R630006	B8728
R607191	C217L	R615005	B8649	R630007	B8727
R607192	C218R	R615006	B8650	R630009	B8725A
R607193	C219L	R615007	B8685Z	R657001	B807
R607194	C220R	R615008	B8652	R657003	B8620
R607195	C096L	R615009	B8656	R801041	SA1041
R607196	C097R	R615010	B8655	R801042	SA1042
R607197	C098L	R615013	B8742	R801073	SA1073
R607198	C099R	R615014	B8655Z	R801074	SA1074
R607199	C102L	R615015	B8746	R806004	SA10101
R607200	C103R	R615016	B8795	R806006	SA10305
R607221	C724L	R615017	B8796	R806007	SA10306
R607222	C725R	R615018	B8793	R806013	SA10212
R607223	C927L	R615019	B8792	R806014	SA10214
R607224	C928R	R615020	B8790	R806015	SA10216
R607225	C972L	R615021	B8746Z	R806016	SA10144
R607226	C973R	R615022	B8790HD	R806019	SA10211
R607227	C931L	R615023	B8794	R806021	SA10215
R607228	C932R	R615024	B8794HD	R806022	SA10103
R607229	C933L	R615025	B8805	R806023	SA10102
R607230	C934R	R617001	B8601	R806024	SA10100
R607231	C935L	R617002	B8606	R806026	SA10101
R607232	C936R	R617003	B8602	R810009	S2009
R607233	C737L	R617005	B8698	R810019	S2009
R607234	C738R	R617006	B8688	R822009	S2026
R607237	C742L	R617007	B8623	R823000	S2021A
R607238	C743R	R617008	B8699	R824000	S2010A
R607253	C759L	R617009	B8624	R824001	S2020A

INTERCHANGES

MERITOR	SIRCO	NATIONAL	SIRCO	NAVISTAR	SIRCO
R824003	S2022A	370001A	SS382-8036	1622372C1	AS9287
R824004	S2019A	370001A	SS35066	1660581C-1	AS9213
R824007	S2012A	370001A	SS370001	1670043C1	AS9371
R825020	S2024	370003A	SS392-9131	1670073C-1	AS9371
R870024	A2400	370003A	SS47692	1672401C1	AS9219
R870030	A3000	370003A	SS47697	1681748C1	AS8792
R955275491	A5491	370003A	SS370003	1685174C1	AS8050
S265D	B861	370003A	SS761400	1685175C1	AS6905
SF5234524Q	L4524Q	370023A	SS38780	1686386C-1	AS9371
SF5504515Q	L4515Q-20	370025A	SS307-0743	2027911C1	AS9648
SF5504707QP	L4707Q-20	370025A	SS372-7097	2027911C-1	AS9371
SF5554515F3	L4515X	370025A	SS373-0143	2027911C2	AS9648
SF5554515Q	L4515Q	370025A	SS46300	2027911C3	AS9648
SF5554702QP	L4702Q	370025A	SS46305	3541731C1	AS9875
SF5554707QP	L4707	370025A	SS370025	501559C-1	AS9213
SF5554709E2	L4709N	370025A	SS755400	501559C-2	AS9213
SF5571308E	L1308E	370065A	SS370065	517559C9	AS9082
SF5571308Q	L1308Q	370065A	SS42623	554762C1	AS9422
SMA2121443E	L1443E	376590A	SS376590	554764C1	AS9069
SMA2124311J	L4311J	376590A	SS42623	554766C1	AS9039
				554768C1	AS9101
				554773C1	AS9121
				554783C1	AS6910
				554784C1	AS6902
				554787C1	AS7403
				554792C1	AS7410
				554800C1	AS7135

INTERCHANGES

NEW LIFE	SIRCO	NORFORGE	SIRCO	PETERBILT	SIRCO
TRA-2726-SP	SH2726	A-7022	S2021A	02456	AS9069
TRA-2727-SP	SH2727	A-7044	S2020A	04759	AS9069
TRA-2728-SP	SH2728	A-7076	S2010A	06746	AS9069
UCD-0511-1-693	SF693	A-7085	S2022A	03-07887	AS8852
		A-7094	S2019A	C81-6000	AS8813
		A-7100	S2012A		
		A-7134	S2026		
		A-7225	S2025		
		A-7228	S2023		
		A-7531	S2000		

INTERCHANGES

PHILLIPS	SIRCO	REYCO	SIRCO	RIDEWELL	SIRCO
11-315	A1015	08490/08495-01	5R783146	1003586902C	AS6902
11-3120	A1012	08495/08504-01	5R783186	1003586905C	AS6905
11-3400	A1040	09352-01	SH1039	1003587135C	AS7135
12-006	A1452	93AR	AS8018	1003587136C	AS7136
12-008	A1451	12882-01	AS9082	1003587403C	AS7403
12-010	A1450	12882-02	AS9121	1003588008C	AS8008
12-012	9004	12883-01	AS9101	1003589387C	AS9387
12-0161	9004B	12883-02	AS9122	S-4302C	AS7403
12-0162	9004R	12928-01	AS9010		
12-136	A1440	14247-01	SR1003		
12-138	A1441	14248-01	SR1006		
12-306	A1442	14249-01	SR1004		
12-308	A1443	14250-01	SR1005		
12-800	A9859	15172-01	SR1012		
12-801	A9860	15173-01	SR1013		
		15178-01	SR1014		
		15179-01	SR1015		
		18813-01	AS7555		
		20018-01	AS7555		
		23521-01	AS9367		
		23631-01	AS8050		
		T-1704	SR1020		
		T-2106	SR1018		
		T-2224	SR1010		
		T-5166	SH1023		
		T-5427	SR1000		
		T-5492	SR1009		
		T-5493	SR1008		
		T-5495	SR1011		
		T-5524	SR1002		
		T-5544	SR1017		
		T-7292	SH1016		
		T-7635	SR1014		
		TK-12506	SR1001		
		TK-18997	SR1007		
		TK-18998	SR1001		
		TK-19011	SR1016		

INTERCHANGES

ROAD LEVELER	SIRCO	ROAD LEVELER	SIRCO	SILENT DRIVE	SIRCO
RL68970	AS6897	RL97800	AS9780	AS-7818	AS7818
RL69020	AS6902	RL99210	AS9921		
RL69050	AS6905	RL99350	AS9935		
RL69100	AS6910				
RL71350	AS7135				
RL71400	AS7140				
RL74030	AS7403				
RL74100	AS7410				
RL75550	AS7555				
RL77950	AS7795				
RL80500	AS8050				
RL80910	AS8091				
RL82040	AS8204				
RL87080	AS8708				
RL87090	AS8709				
RL87130	AS8713				
RL87290	AS8729				
RL87550	AS8755				
RL88130	AS8813				
RL88290	AS8829				
RL88520	AS8852				
RL89440	AS8944				
RL90390	AS9039				
RL90690	AS9069				
RL90820	AS9082				
RL91010	AS9101				
RL91210	AS9121				
RL91220	AS8792				
RL92130	AS9213				
RL92430	AS9243				
RL92650	AS9265				
RL92700	AS9270				
RL92930	AS9293				
RL92950	AS9295				
RL93070	AS9307				
RL93210	AS9321				
RL93660	AS9366				
RL93700	AS9370				
RL93710	AS9371				
RL93730	AS9373				
RL93750	AS9375				
RL93870	AS9387				
RL93940	AS9394				
RL94220	AS9422				
RL94660	AS9466				
RL95800	AS9580				
RL96160	AS9616				
RL96190	AS9619				
RL96220	AS9622				
RL96400	AS9640				
RL96480	AS9648				

INTERCHANGES

SLOAN	SIRCO	SPICER	SIRCO	SPICER	SIRCO
44751	A1453	8-295	9013	17-461	C494L
44752	703	8-295H	9016	17-462	C497R
401008	A1030	8-296	9014	17-463	C496L
401142	A5491	8-297	9015	17-472	C060R
401143	A9859	8-304	9018-1	17-473	C059L
401144	A9860	10-131	S2000	17-478	C725R
401167	A1030	10-354	S2020A	17-479	C724L
441001	A1442	10-355	S2022A	17-480	C855R
441003	A1443	10-367	S2012A	17-481	C854L
441015	A1452	10-368	S2019A	17-482	C857R
441016	A1451	10-399	S2026	17-483	C856L
441017	A1450	12-391	5210	17-490	C530L
441019	A1441	12-392	5300	17-491	C531R
441023	A1440	12-393	5200	17-500	C521R
441736	9004P	12-394	5660	17-501	C520L
441738	9004B	12-400	5401	17-502	C527R
441739	9004R	12-402	5402	17-503	C526L
441749	9004	12-403	5403	17-504	C515R
451035N	A1012	12-417	2303	17-505	C514L
451036N	A1015	12-418	2304	17-506	C928R
451039N	A1040	12-419	2305	17-507	C927L
		13-496	5000	17-508	C513R
		15-526	B251	17-509	C512L
		15-527	B887	17-510	C099R
		15-529	B832	17-511	C098L
		15-532	B311	17-512	C519R
		15-536	B277	17-513	C518L
		15-537	B216	17-514	C103R
		15-540	B424	17-515	C102L
		15-542	B120	17-516	C517R
		15-543	B377	17-517	C516L
		15-545	B217	17-518	C612R
		15-550	B262	17-519	C611L
		15-557	B898	17-520	C528L
		15-562	B950	17-521	C529R
		15-563	B138	17-524	C891R
		15-564	B141	17-525	C890L
		15-565	B122	17-526	C532L
		15-600	BP-104	17-527	C533R
		15-601	BP-110	17-530	C097R
		16-561	B495	17-531	C096L
		16-562	B595	17-556	C743R
		16-563	B888S	17-557	C742L
		16-564	B362	17-566	C690R
		16-565	B888	17-567	C691L
		16-566	B144	17-568	C794R
		16-700	B888D	17-569	C795L
		16-702	BP-108	17-572	C714R
		17-416	C906R	17-573	C715L
		17-417	C905L	17-574	C094R
		17-460	C495R	17-575	C095L

INTERCHANGES

SPICER	SIRCO	SPICER	SIRCO	SPICER	SIRCO
17-576	C686R	17-661	C081L	18-514	C658R
17-577	C687L	17-684	C410R	18-515	C657L
17-578	C412R	17-685	C411L	18-516	C522R
17-579	C413L	17-690	C422R	18-517	C524L
17-580	C424R	17-691	C423L	18-518	C536R
17-581	C425L	17-694	C420R	18-519	C537L
17-582	C689R	17-695	C421L	18-520	C664R
17-583	C688L	17-720	C442BR	18-521	C663L
17-584	C090R	17-720	C866R	18-522	C666R
17-585	C089L	17-721	C441BL	18-523	C665L
17-586	C716R	17-721	C867L	18-524	C668R
17-587	C717L	17-722	C444BR	18-525	C667L
17-588	C796R	17-722	C870R	18-526	C670R
17-589	C797L	17-723	C443BL	18-527	C669L
17-590	C218R	17-723	C871L	18-528	C594R
17-591	C217L	17-724	C446BR	18-529	C595L
17-592	C220R	17-724	C869R	18-534	C676R
17-593	C219L	17-725	C445BL	18-535	C675L
17-594	C885R	17-725	C868L	18-536	C678R
17-595	C884L	17-782	C760R	18-537	C677L
17-596	C718R	17-783	C759L	18-538	C680R
17-597	C719L	17-914	C932R	18-539	C679L
17-616	C862R	17-915	C931L	18-540	C682R
17-617	C861L	17-920	C934R	18-541	C681L
17-620	C564R	17-921	C933L	18-542	C684R
17-621	C563L	17-922	C311R	18-543	C683L
17-622	C100R	17-923	C310L	18-712	C084R
17-623	C101L	17-926	C312L	18-713	C083L
17-626	C442R	17-927	C313R	18-726	C799R
17-627	C441L	17-928	C936R	18-727	C800L
17-628	C444R	17-929	C935L	18-734	C887R
17-629	C443L	17-930	C911R	18-735	C886L
17-630	C446R	17-931	C910L	18-738	C775R
17-631	C445L	17-936	C315R	18-739	C776L
17-632	C450R	17-937	C314L	18-740	C786R
17-633	C449L	17-940	C738R	18-741	C787L
17-634	C694R	17-941	C737L	18-744	C056R
17-635	C693L	17-11055	C603L	18-745	C055L
17-636	C720R	17-11056	C602R	18-748	C889R
17-637	C721L	18-500	C646R	18-749	C888L
17-638	C722R	18-501	C645L	18-780	C086R
17-639	C723L	18-502	C648R	18-781	C085L
17-640	C448R	18-503	C647L	18-786	C702R
17-641	C447L	18-504	C426R	18-787	C703L
17-642	C452R	18-505	C427L	18-802	C706R
17-643	C451L	18-506	C652R	18-803	C707L
17-656	C092R	18-507	C651L	18-804	C478R
17-657	C091L	18-508	C654R	18-805	C479L
17-658	C088R	18-509	C653L	18-808	C773R
17-659	C087L	18-510	C656R	18-809	C774L
17-660	C082R	18-511	C655L	18-810	C147R

INTERCHANGES

SPICER	SIRCO	SPICER	SIRCO	SPICER	SIRCO
18-811	C148L	18-958	C764R	23-1026	B211
18-812	C708R	18-959	C763L	27-1191	B8699
18-813	C709L	18-984	C770R	27-1194	B8624
18-816	C881R	18-985	C769L	27-1195	B8606
18-817	C880L	18-994	C741R	27-1196	B8688
18-818	C710R	18-995	C740L	27-1197	B8636
18-819	C711L	19-851	B971	27-1198	B8623
18-820	C730R	19-853	B728	27-1199	B8616
18-821	C731L	19-853A	B349	27-1200	B8603
18-822	C732R	19-854	B981	27-1208	B8621
18-823	C733L	19-856	B956	28-1231	B807
18-824	C897R	19-856A	B302	28-1233	B8600
18-825	C896L	19-859	B769	28-1235	B8635
18-826	C348R	19-860	B220	28-1237	B8620
18-827	C347L	19-862	B307	28-1238	B8698
18-828	C726R	19-863	B869	28-1240	B8628
18-829	C727L	19-864	B426	28-1241	B8627
18-830	C350R	19-865	B972	28-1243	B8661
18-831	C349L	19-866	B427	28-1252	B8615
18-832	C352R	19-874	B983	28-1253	B8614
18-833	C351L	19-876	B982	28-1255	B8660
18-834	C734R	19-877	B770	28-1257	B8601
18-835	C735L	19-878	B974	28-1260	B8665
18-836	C728R	19-882	B308	28-1263	B8754
18-837	C729L	19-891	B870	28-1264	B8750
18-850	C899R	19-892A	B829	28-1265	B8760
18-851	C898L	19-896	B579	29-1266	B8612A
18-860	C500R	19-900	B221	29-1267	B8613
18-861	C499L	19-902	B952	29-1269	B8612
18-864	C650R	19-903	B953	29-1270	B8609
18-865	C649L	19-904	B139	29-1274	B8625
18-866	C883R	19-905	B140	29-1275	B8626
18-867	C882L	19-906	B142	29-1283	B8755
18-868	C895R	19-907	B143	29-1301	B8604
18-869	C894L	19-910	B871	29-1302	B8622
18-930	C505R	19-913	B347	29-1303	B8722
18-931	C504L	19-915	B432A	29-1305	B8634A
18-940	C491R	19-920	B955	29-1306	B795
18-941	C490L	19-921	ARK	29-1307	B8607
18-942	C493R	19-922	B999	29-1308	B8605
18-943	C492L	19-923	B562	29-1309	B8610
18-948	C762R	19-924	B433	29-1310	B8608
18-949	C761L	19-925	B436	29-1311	B8611
18-950	C753R	19-930	B350	29-1312	B960
18-951	C752L	19-938	B434S	29-1315	B8634
18-952	C755R	19-940	B434	29-1318	B8697
18-953	C754L	19-950	B348	29-1319	B8631
18-954	C751R	19-952	BP-100	29-1320	B8630
18-955	C750L	19-953	BP-106	29-1321	B8629
18-956	C757R	20-881	B423	29-1322	B8619
18-957	C756L	20-882	B358	29-1326	B8632

INTERCHANGES

SPICER	SIRCO	SPICER	SIRCO	SPICER	SIRCO
29-1330	B8757	32-1441	B052	43-7033-1	B8655A
29-1333	B230	32-1441A	B942	43-7037	B8645
29-1334	B8758	32-1442A	B152	43-7037-1	B8645A
29-1336	B8759	32-1443	B053	43-7037A	B8683
29-1337	B811	32-1444	B154	43-7037A-1	B8683A
29-1338	B8756	32-1445	B133	43-7037B	B8747
29-1339	B8718	32-1446	B132	43-7037B-1	B8747A
29-1340	B8765	32-1458	B923	43-7038	B8650
29-1344	B8752	32-1464	B725	43-7038-1	B8650A
29-1346	B8753	32-1467	B135	43-7039	B8649
30-1341L	B8150L	32-1468	B134	43-7039-1	B8649A
30-1341R	B8150R	32-1471	B430K	43-7040	B8712
30-1357	B8714	32-1475	B924	43-7040-1	B8712A
30-1358	B8696	32-1479	B137	43-7041	B8648
30-1361	B8735	32-1480	B136	43-7041-1	B8648A
30-1362	B8713	32-1560	BP-105	43-7042	B8657
30-1363	B8734	32-1562	BP-109	43-7042-1	B8657A
30-1375	B8690	34-1525	B793	43-7043A	B8684
30-1385	B8717	34-1526	B379	43-7043A-1	B8684A
30-1390	B8727A	34-1527	B380	43-7044	B8681
30-1392	B8728	34-1529	B151	43-7044-1	B8681A
31-1400	CT336	34-1530	B498	43-7044A	B8644
31-1401	CT332	34-1531	B868	43-7044A-1	B8644A
31-1402	CT333	34-1532	B161	43-7046	B8686
31-1403	CT338	34-1533	B932	43-7046-1	B8686A
31-1405	CT334	34-1539	B861	43-7047	B8646
31-1406	CT310	34-1541	B8662	43-7047-1	B8646A
31-1412	CT350	34-1542	B8663	43-7048	B8707
31-1413	CT351	34-1545	B429	43-7048-1	B8707A
31-1415-1	CT331	34-1546	B428	43-7048A	B8766
31-1415-2	CT313	34-1547	B8689	43-7050	RC-1
31-1420	CT337	34-1550	B823	43-7050-1	RC-1A
31-1430	CT356	34-1551	073	43-7051	B8743
31-1431	CT357	34-1552	B556	43-7051-1	B8743A
31-1439	CT361	34-1561	B951	43-7059	B8744
31-1440	CT359	34-1562	B954	43-7059-1	B8744A
31-1441	CT360	34-1563	B218	43-7060	B8742
31-1442	CT369	34-1565	B973	43-7060-1	B8742A
31-1443	CT370	34-1570	B431	43-7062	B8655Z
31-1466	CT375	35-1580	B988	43-7062-1	B8655ZA
31-1467	CT311	35-1581	B392	43-7064	B8795
31-1468	CT312	35-1582	B501	43-7064-1	B8795A
32-1425	B941	43-7029	B8656	43-7065	B8796
32-1426	B611	43-7029-1	B8656A	43-7065-1	B8796A
32-1427	B586	43-7030	B8685Z	43-7068	B8793
32-1428	B911	43-7030-1	B8685ZA	43-7068-1	B8793A
32-1429	B425	43-7031	B8682	43-7069	B8746
32-1430	B054	43-7031-1	B8682A	43-7069-1	B8746A
32-1431	B922	43-7032	B8652	43-7071	B8772M
32-1435	B500	43-7032-1	B8652A	43-7071-1	B8772MA
32-1440	B499	43-7033	B8655	43-7072	B8773M

INTERCHANGES

SPICER	SIRCO	SPICER	SIRCO	SPICER	SIRCO
43-7072-1	B8773MA	50-1284	334	53-1561	716
43-7072A	B8788	50-1285	335	54-1650	800
43-7090	B8790	50-1286	336	54-1651	802
43-7090-1	B8790A	51-1003L	988L	54-1660	804
43-7118	B8797	51-1003R	988R	54-1661	073
50-1003L	095	51-1005L	709AL	54-1661	806
50-1003R	096	51-1005R	708AR	1308ERED	L1308E
50-1004L	989	51-1006L	896L	1308QRED	L1308Q
50-1004R	988	51-1006R	896R	1443ERED	L1443E
50-1006L	991	51-1007L	897L	4311EBLU	L4311J
50-1006R	990	51-1007R	897R	4515QBLU	L4515Q-20
50-1007L	005	51-1011L	978L	4515QRED	L4515Q
50-1007R	004	51-1011R	978R	4515X3RED	L4515X
50-1008L	125	51-1012L	892AL	4524QBLU	L4524Q
50-1008R	124	51-1012R	891AR	4524QMBLU	L4524M
50-1010L	272	51-1013L	889L	4702RRED	L4702Q
50-1010R	271	51-1013R	888R	4707RBLU	L4707Q-20
50-1026L	011	51-1018L	913L	4707RRED	L4707
50-1026R	012	51-1018R	912R	4709EIIRED	L4709N
50-1122L	192	51-1032	881M	HK14SD	TK-4HD
50-1122R	191	51-1033	333B	HK14XLS	TK-4
50-1123L	264	51-1034	920	HK16	TK-1
50-1123R	263	52-1301	123	HK16XLS	TK-1HD
50-1127L	969	52-1304	993	HK17XLS	FK-1
50-1127R	968	52-1306	235	HK19SD	MK-1HD
50-1128L	852	52-1309	708	HK24SDLM	EK-1HD
50-1128R	851	52-1310	053	HK24SLM	EK-1HD
50-1131L	184	52-1336	110	HK24XLSHM	EK-3
50-1131R	183	52-1337	138	HK26	EK-2
50-1133L	098	52-1368	201	HK29	QK-1
50-1133R	097	52-1370	267	HK29SD	QK-1MPHD
50-1134L	067	52-1380	238	HK29XLS	QK-1HD
50-1134R	066	52-1381	236	HK31XLS	XK-1HD
50-1135L	376	52-1382	233	HK32SD	XL-1
50-1135R	375	52-1385	008	HK34SD	XK-3HD
50-1136L	374	52-1392	256	HK34XLS	XK-3
50-1136R	373	52-1394	257	HK38	QK-2S
50-1165L	413	52-1395	302	HK40	LB-4
50-1165R	412	52-1403	251	HK41	LB-5
50-1181L	481	52-1410	314	HK43XLS	LB-1
50-1181R	482	52-1421	515	HK44XLS	LB-3
50-1182L	287L	52-1422	544	HK47XLS-125	LB-6
50-1182R	287R	52-1423	545	HK47XLS-150	LB-8
50-1250L	205	52-1430	722	HK48XLS-125	LB-2
50-1250R	204	52-1436	729	HK48XLS-150	LB-9
50-1267	164	52-1440	399	HK49-150	LB-10S
50-1268	162	52-1441	853	HK50	RF-2ARK
50-1269	160	53-1500	654	HK51	RF-1ARK
50-1274	884	53-1501	715	HK53	WF-1
50-1275	882	53-1503	411	HK54	EF-1
50-1276	883	53-1560	149	HK55	RF-3

INTERCHANGES

SPICER	SIRCO	SPICER	SIRCO	SPICER	SIRCO
HK58XLS	LB-3D	M12WK100-19	C420R	M16WKL10-264	C742L
HK61	ES-2	M12WK101-17	C423L	M16WKL10-266	C219L
HK61SD	ES-2	M12WK101-19	C421L	M16WKL20-166	C528L
HK61XLS	ES-2	M12WK106-6	C410R	M16WKL20-173	C096L
HK62	EF-2	M12WK107-6	C411L	M16WKL20-175	C518L
HK63	ES-1	M12WKL20-233	C759L	M16WKL20-205	C520L
HK65SD	EX-1	M12WKL25-233	C905L	M16WKL20-231	C098L
HK66XLS	RF-5	M12WKR20-233	C760R	M16WKL20-236	C526L
HK67XLS	EQ-1	M12WKR25-233	C906R	M16WKL20-241	C530L
HK68	RK-1	M12WR101	S2025	M16WKL20-242	C102L
HK69XLS	ET-1	M16HD100	B807	M16WKL20-264	C532L
HK70	FF-1	M16HD106	B805	M16WKL20-271	C972L
HK71	FR-1	M16HH100	B8612	M16WKL25-175	C931L
HK74XLS	MF-2	M16KY20	B8652	M16WKL25-205	C933L
HK75SD	TK-7HD	M16WH113X	B8714	M16WKL25-215	C310L
HK76	RK-2	M16WK102-9	C686R	M16WKL25-231	C312L
HK77	RF-3A	M16WK102-17	C424R	M16WKL25-236	C935L
HK80XLS	MF-3	M16WK102-19	C689R	M16WKL25-242	C910L
HK81XLS	MF-1	M16WK102-23	C884L	M16WKL25-264	C314L
HK82SD	MK-2HD	M16WK102-25	C094R	M16WKL25-271	C737L
HK84	BK-145R	M16WK102-26	C716R	M16WKR10-175	C517R
HK86	BK-145FM	M16WK102-83	C797L	M16WKR10-205	C515R
HK87	BK-145F	M16WK102-88	C719L	M16WKR10-231	C612R
HK90XLS	ES-3	M16WK103-9	C687L	M16WKR10-236	C513R
HK91XLS	ES-4	M16WK103-17	C425L	M16WKR10-242	C928R
HK95XLS	SF-1	M16WK103-19	C688L	M16WKR10-264	C218R
HK97XLS	ES-5	M16WK103-23	C885R	M16WKR10-264	C743R
M10HN100	5300	M16WK103-25	C095L	M16WKR10-266	C220R
M10HN101	5210	M16WK103-26	C717L	M16WKR20-166	C529R
M10HN102	5200	M16WK103-83	C796R	M16WKR20-173	C097R
M10HN139	B8610	M16WK103-88	C718R	M16WKR20-175	C519R
M10HN151	5660	M16WK104-10	C724L	M16WKR20-205	C521R
M10HS115	B8631	M16WK104-17	C855R	M16WKR20-231	C099R
M10HS117	B8611	M16WK104-23	C890L	M16WKR20-236	C527R
M10HS143	B800	M16WK104-25	C856L	M16WKR20-241	C531R
M10HS147	B801	M16WK104-26	C892L	M16WKR20-242	C103R
M10KY105	B8797	M16WK105-10	C725R	M16WKR20-264	C533R
M10WH150L	B8150L	M16WK105-17	C854L	M16WKR20-271	C973R
M10WH150R	B8150R	M16WK105-23	C891R	M16WKR25-175	C932R
M10WJ100	B8699	M16WK105-25	C857R	M16WKR25-205	C934R
M10WJ107	B8606	M16WK105-26	C893R	M16WKR25-215	C311R
M10WJ109	B8602	M16WK110-4	C412R	M16WKR25-231	C313R
M10WJ178	B8601	M16WK111-4	C413L	M16WKR25-236	C936R
M10WJ237X	B8606A	M16WK116	C794R	M16WKR25-242	C911R
M10WR119	S2010A	M16WK117	C795L	M16WKR25-264	C315R
M12KBH10	LB-11	M16WKL10-175	C516L	M16WKR25-271	C738R
M12KY100	B8682	M16WKL10-205	C514L	M16WR105	S2021A
M12KY101	B8655	M16WKL10-231	C611L	SB1308ERED	L1308E-EF1
M12LK101X	LB-1	M16WKL10-236	C512L	SB1308QRED	L1308Q-RF3
M12WH112X	B8733	M16WKL10-242	C927L	SB1443ERED	L1443E-EF1
M12WK100-17	C422R	M16WKL10-264	C217L	SB4311EBLU	L4311J-EK1HD

INTERCHANGES

SPICER	SIRCO	SPRING VALLEY	SIRCO	STD FORGE	SIRCO
SB4515QBLU	L4515Q-20-QK1HD	AS-4413	AS8032	203108-001	B216
SB4515QRED	L4515Q-QK1HD			203113-001	B217
SB4515X3RED	L4515X-XK3HD			204108-001	B133
SB4524QBLU	L4524Q-QK1HD			205107-001	B132
SB4524QMBLU	L4524M-MF2			207100	B358
SB4702RRED	L4702Q-RF5			208106	B307
SB4707RBLU	L4707Q-20-QK1HD			209108-001	B8717
SB4707RRED	L4707-QK1HD			209999-018	B8714
SB4709EIRED	L4709N-ES2			209999-019	B8733
				214107	B380
				403105	B8611
				403112	B8697
				403147	B392
				403149	B8632
				403150	B8631
				405106	B667
				405109	B8601
				405128	B8606
				405129	B8602
				405131	B362

INTERCHANGES

STEMCO	SIRCO	TECTRAN	SIRCO	TOP SPEC	SIRCO
330-3009	9018-1	10-229859	A9859	5-3319	EQ-1
330-3013	9008-1	10-229860	A9860	5-3320	ET-1
330-3024	9024-1	150-24	A2400	5-3321	EX-1
330-3041	9042-1	150-300	A3000		
330-3067	9018-2	1011	A1450		
330-3077	9014	1011E	A1451		
340-4009	9009	1030-6	A1030		
340-4013	9008	9211	A1442		
340-4024	9024	9212	A1443		
340-4042	9042	9216	A1441		
340-4095	9095	9217	A1440		
340-4098	9098	10111	9004		
340-4249	9249	10113	9004P		
340-4975	9013	10115	A1452		
340-5097	9009G	10116	A1453		
342-4013	9008G	17212	A1012		
342-4024	9024G	17215	A1015		
343-4009	9009P	17215-040	A1040		
343-4013	9008P	101115B	9004B		
343-4024	9024P	101115R	9004R		
343-4042	9042P				
343-4095	9095P				
343-4098	9098P				
343-4195	9195P				
343-4249	9249P				
347-4009	9009H				
359-5912	9249W				
359-5990	9015				
359-5995	9009W				
359-5999	9024W				
372-7097	SS307-0743				
372-7097	SS372-7097				
372-7097	SS373-0143				
372-7097	SS46305				
372-7097	SS370025				
372-7097	SS755400				
372-7099	SS42623				
372-7099	SS370065				
373-0143	SS46300				
382-8036	SS382-8036				
382-8036	SS35066				
382-8036	SS370001				
392-9131	SS392-9131				
392-9131	SS47692				
392-9131	SS47697				
392-9131	SS370003				
392-9131	SS761400				
640-0003	9016				

INTERCHANGES

TRAMEC	SIRCO	TRANSPRO	SIRCO	TRIANGLE	SIRCO
36001	9004	0001-08	ST1007	4310	AS6902
36011	9004B	0001-14	ST1004	4311	AS7135
36012	9004R	0002-12	ST1008	4315	AS6905
36101	A1452	0022-00	SB1004	4316	AS7140
36153	A1442	0022-01K	ST1006	4318	AS7403
36161	A1440	0030-20	SB1007	4320	AS6910
36201	A1451	0045-00	ST1019	4321	AS7136
36253	A1443	0075-20	ST1005	4325	AS7818
36261	A1441	0084-00	ST1010	4329	AS7798
36301	A1450	0086-00	ST1012	4331	AS7410
51102	A9859	0088-00	ST1011	4413	AS8032
51103	A9860	0102-10	5R785146	4431	AS8008
56161	A1440	0102-13	5R785186	4434	AS8018
56261	A1441	0102-14	5R785146	4480	AS7555
59001	703	0102-18	5R785186	4505	AS6897
		0274-01	SH1027	4519	AS6808
		0375-00	SH1023	4524	AS7795
		0400-01	ST1013L	4525	AS8033
		0400-02	ST1013R	4543	AS6799
		0401-00	ST1014	8310	AS9082
		0402-01	ST1015L	8311	AS9039
		0402-02	ST1015R	8312	AS9069
		0632-02	ST1018	8313	AS9122
		0636-01	ST1017	8314	AS9422
		0649-02	ST1003	8315	AS9101
		0649-04K	ST1002	8317	AS9121
		0650-00	ST1000	8320	AS8050
		0741-00K	SH1057	8326	AS9192
		0741-05K	ST1009	8345	AS9010
		0850-00	ST1001	8361	AS9321
		09352-01	SH1039	8382	AS9780
		1035-20	SB1007	8383	AS9394
		T-7292	SH1016	8384	AS9243
				8393	AS9026
				8406	AS9287
				8407	AS9213
				8408	AS9219
				8410	AS9466
				8417	AS9295
				8424	AS9293
				8427	AS9640
				8429	AS9923
				8433	AS9270
				8434	AS9580
				8435	AS9265
				8436	AS8944
				8440	AS9373
				8441	AS9213
				8443	AS9921
				8448	AS9370
				8449	AS8829

INTERCHANGES

TRIANGLE	SIRCO	VELVAC	SIRCO	VOLVO	SIRCO
8451	AS9375	022001	A1040	35003-3201	AS9219
8454	AS9936	022002	A1012	35003-3203	AS9219
8456	AS9648	022025	A1015	35003-3204	AS9219
8460	AS8709	030019	A2400S	35003-3209	AS9219
8471	AS9307	030021	A3000S	3934699	AS8829
8472	AS8852	032015	A9859	8079902	AS8829
8479	AS9387	032018	A9860	8084296	AS8829
8484	AS8204	035005	9004	8097092	AS8829
8486	AS8749	035009	9004R	20505399	AS8829
8488	AS9366	035010	9004B	85101145	AS9069
8505	AS9367	035038	A1450	85101146	AS6905
8513	AS8729	035042	A1451	85101147	AS9270
8515	AS9616	035045	A1452	85101148	AS9422
8521	AS9371	035070	A1453	85101153	AS9039
8522	AS8755	035092	A1440	85101155	AS9265
8523	AS8091	035093	A1441	85101158	AS7410
8526	AS8708	035094	A1442	85101160	AS9321
8533	AS8713	035095	A1443	85101163	AS9122
8537	AS9622	035150	703		
8538	AS9625	320014	A1030		
8548	AS9935				
8550	AS9647				
8567	AS9619				
8568	AS9626				
8577	AS8813				

INTERCHANGES

WAGNER	SIRCO	WATSON-CHALIN	SIRCO	WEBB	SIRCO
80414	B898	AS-0001	AS6910	3314	314
80433	B725	AS-0002	AS6902	16123	123
F97506	WF-1A	AS-0004	AS7136	74611	149
FC31926	B823	AS-0007	AS7403	74710	716
FC89177	B870	AS-0011	AS9082	100163	429
FC89178	B870	AS-0012	AS9039	100164	428
		AS-0017	AS9422	101160	160
		AS-0020	AS6905	101162	162
		AS-0023	AS8792	101164	164
		AS-0025	AS7818	101172	430
		AS-0034	AS6808	101173	431
		AS-0036	AS9321	161127	654
		AS-0038	AS9192	171027	715
		AS-0039	AS8050		
		AS-0040	AS9101		
		AS-0044	AS9010		
		AS-0046	AS9192		
		AS-0054	AS9366		
		AS-0057	AS9370		
		AS-0058	AS6897		
		AS-0061	AS9243		
		AS-0075	AS8018		
		AS-0077	AS9069		
		AS-0090	AS9921		
		AS-0104	AS9367		
		AS-0127G	AS9373		

INDEX

PART NO.	PAGE	PART NO.	PAGE	PART NO.	PAGE	PART NO.	PAGE
004.....	171	302.....	183	439.....	176	P715.....	181
005.....	171	304L.....	168	447.....	176	716.....	181
008.....	183	304R.....	168	448.....	176	P716.....	181
011.....	172	306L.....	167	449.....	176	716S.....	181
012.....	172	306R.....	167	450.....	176	722.....	184
053.....	183	314.....	186	451.....	180	725.....	184
066.....	175	333B.....	169	452.....	180	729.....	182
067.....	175	P333B.....	169	453.....	180	800.....	187
073.....	50, 169	333SN6.....	170	481.....	173	800W.....	187
P073.....	50, 169	333SN19.....	170	482.....	173	801.....	187
095.....	171	333SN28.....	170	515.....	184	802.....	187
096.....	171	333SN39.....	170	544.....	184	802W.....	187
097.....	175	334.....	179	545.....	184	804.....	187
098.....	175	335.....	179	555S.....	217	805.....	187
110.....	184	336.....	179	563.....	217	806.....	187
123.....	182	366.....	180	563/567.....	217	807.....	187
P123.....	182	367.....	180	567.....	217	P807.....	187
124.....	171	373.....	176	572.....	217	808.....	187
125.....	171	374.....	176	572/580.....	217	809.....	187
133.....	173	375.....	176	572/582.....	217	P809.....	187
134.....	173	376.....	176	580.....	217	851.....	175
138.....	185	399.....	182	582.....	217	852.....	175
149.....	181	402.....	180	583X.....	198	853.....	182
160.....	178	411.....	181	592A.....	217	881M.....	169
P160.....	178	412.....	174	592A/594A.....	217	P881M.....	169
162.....	178	413.....	174	592A/598A.....	217	882.....	179
P162.....	178	414.....	173	594A.....	217	883.....	179
164.....	178	415.....	173	598A.....	217	884.....	179
P164.....	178	416.....	173	628X.....	198	888RZ.....	168
183.....	175	417.....	173	634X.....	198	P888RZ.....	168
184.....	175	418.....	172	635X.....	198	889LZ.....	168
191.....	174	419.....	172	636X.....	198	P889LZ.....	168
192.....	174	420.....	172	653.....	217	891AR.....	168
201.....	186	421.....	172	653/663.....	217	P891AR.....	168
204.....	172	422.....	178	654.....	181	891BR.....	168
205.....	172	423.....	178	663.....	217	P891BR.....	168
233.....	185	424.....	172	676.....	178	892AL.....	168
235.....	183	425.....	172	700.....	207	P892AL.....	168
P235.....	183	426.....	172	701.....	207	892BL.....	168
236.....	185	427.....	172	702.....	207	P892BL.....	168
238.....	185	428.....	175	703.....	214	896L.....	167
251.....	185	429.....	175	708.....	182	P896L.....	167
256.....	183	430.....	174	708AR.....	167	896R.....	167
257.....	183	431.....	174	P708AR.....	167	P896R.....	167
263.....	174	432.....	173	709AL.....	167	897L.....	167
264.....	174	433.....	173	P709AL.....	167	P897L.....	167
267.....	185	434.....	173	710.....	207	897R.....	167
271.....	171	435.....	173	710-2.....	208	P897R.....	167
272.....	171	436.....	177	711.....	207	912R.....	168
287L.....	174	437.....	177	712.....	207	913L.....	168
287R.....	174	438.....	176	715.....	181	919.....	169

Copyright 2016 Sirco Industries, Inc.

INDEX

PART NO.	PAGE	PART NO.	PAGE	PART NO.	PAGE	PART NO.	PAGE
920.....	169	3571.....	189	9098.....	195	5R783136.....	237, 248
921.....	169	3720.....	217	9098P.....	195	5R783146.....	237, 242
947.....	175	3720/3782.....	217	9195P.....	196	248
948.....	175	3782.....	217	9249.....	196	5R783156.....	248
968.....	174	5000.....	193	9249P.....	196	5R783166.....	248
969.....	174	5200.....	189	9249W.....	196	5R783176.....	248
978L.....	167	5210.....	189	13500.....	204	5R783186.....	237, 242
978R.....	167	5300.....	189	13500U.....	204	248
988.....	171	5300S.....	190	13501.....	204	5R7835146.....	248
988L.....	167	5401.....	191	13501U.....	204	5R7835186.....	248
P988L.....	167	5402.....	191	13502.....	204	5R785123.....	248
988R.....	167	5403.....	191	25001.....	206	5R785136.....	248
P988R.....	167	5660.....	189	25240.....	202	5R785146.....	237, 247
989.....	171	6461A.....	217	35102A.....	201	248
990.....	171	9004.....	215	35102L.....	201	5R785156.....	248
991.....	171	P9004.....	215	35102M.....	201	5R785166.....	248
993.....	182	9004B.....	215	35102R.....	201	5R785176.....	248
P993.....	182	9004P.....	215	40135L.....	205	5R785186.....	237, 247
995L.....	168	9004R.....	215	40136R.....	205	248
995R.....	168	9008.....	195	40254L.....	205	8R343103.....	248
996L.....	168	9008-1.....	197	40501L.....	205	8R343123.....	223, 248
996R.....	168	9008G.....	195	40503R.....	206	8R343186.....	223, 248
999X.....	198	9008P.....	195	40528.....	205	8R344186.....	248
1904.....	192	9008S.....	195	40529.....	206	8R783123.....	228, 248
1908.....	192	9009.....	196	44130.....	200	8R783136.....	248
1909.....	192	9009G.....	196	44130U.....	200	8R783146.....	228, 248
1910.....	192	9009H.....	196	44131.....	200	8R783156.....	248
1912.....	192	9009P.....	196	44132.....	201	8R783166.....	228, 248
1913.....	192	9009S.....	196	44132U.....	201	8R783176.....	248
1914.....	193	9009V.....	197	44133.....	201	8R783186.....	228, 248
1915.....	193	9009W.....	196	44134.....	202	8R785123.....	248
1917.....	193	9012.....	193	44134U.....	202	8R785136.....	248
1919.....	193	9013.....	194	44135.....	202	8R785146.....	248
1920.....	192	9013A.....	194	44136.....	202	8R785156.....	248
1921.....	192	9013V.....	194	44137.....	202	8R785166.....	248
1922.....	192	9014.....	194	47620.....	217	8R785186.....	248
1923.....	192	9015.....	197	47620/47686.....	217	8S343123.....	248
1925.....	192	9015V.....	197	47686.....	217	8S343146.....	248
1927.....	192	9016.....	194	50920BS.....	203	A1012.....	216
2296.....	188	9018-1.....	197	50920JS.....	203	A1015.....	216
2297.....	188	9018-2.....	197	50920L.....	203	A1015B.....	216
2298.....	188	9024.....	195	50920R.....	203	A1015R.....	216
2299.....	188	9024-1.....	197	60000L.....	203	A1030.....	213
2301.....	190	9024G.....	195	60000R.....	203	A1040.....	216
2302.....	190	9024P.....	195	60000S.....	204	A1040B.....	216
2303.....	190	9024W.....	196	63500R.....	200	A1040R.....	216
2304.....	190	9042.....	195	63503A.....	200	A1054.....	206
2305.....	190	9042-1.....	197	63503M.....	200	A1072.....	206
3568.....	188	9042P.....	195	65301L.....	200	A1200.....	209
3569.....	188	9095.....	195	73221L.....	204	A1200S.....	209
3570.....	189	9095P.....	195	5R783123.....	237, 248	A1440.....	214

Copyright 2016 Sirco Industries, Inc.

INDEX

PART NO.	PAGE	PART NO.	PAGE	PART NO.	PAGE	PART NO.	PAGE
A1441.....	214	AS7215.....	272	AS9394.....	260	B218.....	60
A1442.....	215	AS7403.....	268	AS9422.....	261	B220.....	59
A1443.....	215	AS7410.....	268	AS9466.....	261	B221.....	60
A1450.....	214	AS7443.....	268	AS9547.....	261	B230.....	162
PA1450.....	214	AS7555.....	269	AS9580.....	261	B251.....	42
A1451.....	214	AS7795.....	269	AS9616.....	262	B256.....	53, 55
PA1451.....	214	AS7798.....	270	AS9619.....	262	B262.....	44
A1452.....	214	AS7818.....	270	AS9622.....	262	B277.....	43
PA1452.....	214	AS8008.....	270	AS9625.....	262	B302.....	56
A1453.....	216	AS8018.....	270	AS9626.....	263	B307.....	53
A1600.....	209	AS8032.....	271	AS9640.....	263	B308.....	53
A1600S.....	209	AS8033.....	271	AS9647.....	263	B311.....	42
A2000.....	209	AS8050.....	251	AS9648.....	263	B347.....	56
A2000S.....	209	AS8091.....	251	AS9780.....	264	B348.....	57
A2400.....	210	AS8204.....	251	AS9781.....	264	B349.....	56
A2400S.....	210	AS8708.....	251	AS9807.....	264	B350.....	56
A2424S.....	211	AS8709.....	252	AS9875.....	264	B358.....	61
A2430S.....	211	AS8713.....	252	AS9921.....	265	B362.....	50
A3000.....	210	AS8729.....	252	AS9923.....	265	B377.....	43
A3000S.....	210	AS8755.....	252	AS9935.....	265	B379.....	46
A3030LS.....	211	AS8792.....	253	AS9936.....	265	B380.....	46
A3030PB.....	211	AS8813.....	253	B011.....	47	B392.....	48
A3030PBLs.....	211	AS8829.....	253	B052.....	41	B423.....	60
A3030S.....	211	AS8852.....	253	B053.....	41	B424.....	45
A5491.....	213	AS8944.....	254	B054.....	38	B425.....	39
A9859.....	213	AS9010.....	254	B055.....	41	B426.....	53
PA9859.....	213	AS9026.....	254	B120.....	44	B427.....	54
A9860.....	213	AS9039.....	254	B122.....	44	B428.....	45
PA9860.....	213	AS9069.....	255	B132.....	42	B429.....	49
ARK.....	19	AS9082.....	255	B133.....	40	B430K.....	38
AS6799.....	266	AS9101.....	255	B134.....	42	B431.....	47
AS6808.....	266	AS9121.....	255	B135.....	40	B432A.....	58
AS6897.....	266	AS9122.....	256	B136.....	38	B433.....	55
AS6902.....	266	AS9192.....	256	B137.....	40	B434.....	60
AS6905.....	267	AS9213.....	256	B138.....	43	B434S.....	60
AS6910.....	267	AS9219.....	256	B139.....	57	B436.....	55
AS7001.....	272	AS9243.....	257	B140.....	59	B495.....	51
AS7012.....	272	AS9265.....	257	B141.....	43	B495S.....	51
AS7031.....	272	AS9270.....	257	B142.....	56	B498.....	47
AS7036.....	272	AS9287.....	257	B143.....	59	B499.....	41
AS7046.....	272	AS9293.....	258	B144.....	50	B500.....	40
AS7074.....	272	AS9295.....	258	B145.....	N/C	B501.....	48
AS7081.....	272	AS9307.....	258	B148.....	N/C	B556.....	48
AS7087.....	272	AS9321.....	258	B151.....	46	B562.....	54
AS7108.....	272	AS9366.....	259	B152.....	41	B579.....	54
AS7110.....	272	AS9367.....	259	B154.....	42	B586.....	39
AS7135.....	267	AS9370.....	259	B161.....	47	B595.....	51
AS7136.....	267	AS9371.....	259	B211.....	50	B595S.....	51
AS7140.....	268	AS9373.....	260	B211S.....	50	B611.....	38
AS7205.....	272	AS9375.....	260	B216.....	43	B667.....	152
AS7206.....	272	AS9387.....	260	B217.....	44	B717.....	158

Copyright 2016 Sirco Industries, Inc.

INDEX

PART NO.	PAGE	PART NO.	PAGE	PART NO.	PAGE	PART NO.	PAGE
B725.....	40	B981.....	58	B8645Z.....	132, 145	B8686A.....	145
B728.....	56, 58	B982.....	58	B8645ZA.....	132, 145	B8686HD.....	145
B769.....	59	B983.....	57	B8646.....	143, 144	B8687.....	138
B770.....	60	B988.....	48, 159	B8646A.....	143, 144	B8687A.....	138
B793.....	45, 165	B999.....	59	B8647.....	140	B8688.....	154
B794.....	165	B8150L.....	151	B8647A.....	140	B8689.....	165
B795.....	165	B8150R.....	151	B8648.....	139	B8690.....	157
B800.....	162	B8600.....	151	B8648A.....	139	B8691.....	165
B801.....	163	B8600A.....	151	B8649.....	132, 141	B8696.....	151
B805.....	153	B8601.....	152	B8649A.....	132, 141	B8696HD.....	151
B806.....	152	B8602.....	152	B8650.....	141	B8697.....	159
B807.....	152	B8603.....	154	B8650A.....	141	B8698.....	153
B811.....	163	B8604.....	165	B8651.....	137	B8699.....	153
B823.....	46	B8605.....	160	B8651A.....	137	B8707.....	136
B829.....	50	B8606.....	153	B8652.....	137	B8707A.....	136
B832.....	42	B8606A.....	153	B8652A.....	137	B8707Z.....	136
B861.....	45	B8607.....	161	B8652Z.....	137	B8707ZA.....	136
B868.....	47	B8608.....	163	B8653.....	138	B8712.....	132
B869.....	53	B8609.....	159	B8655.....	130	B8712A.....	132
B870.....	55	B8610.....	159	B8655A.....	130	B8712Z.....	132
B871.....	57	B8611.....	162	B8655Z.....	131	B8712ZA.....	132
B887.....	43	B8612.....	158	B8655ZA.....	131	B8713.....	149
B888.....	51	B8612A.....	158	B8656.....	138	B8714.....	149
B888D.....	52	B8613.....	157	B8656A.....	138	B8717.....	149
B888S.....	51	B8614.....	156	B8657.....	140	B8718.....	164
B888T.....	52	B8615.....	156	B8657A.....	140	B8719.....	161
B898.....	44	B8616.....	154	B8660.....	155	B8721.....	164
B901.....	47	B8619.....	162	B8661.....	156	B8722.....	166
B911.....	38	B8620.....	155	B8662.....	52	B8725.....	150
B922.....	40	B8621.....	157	B8663.....	52	B8725A.....	150
B923.....	39	B8622.....	166	B8664.....	52	B8727.....	150
B924.....	39	B8623.....	155	B8665.....	155	B8727A.....	150
B932.....	46	B8624.....	154	B8681.....	144	B8728.....	150
B941.....	38	B8625.....	158	B8681A.....	144	B8733.....	149
B942.....	41	B8626.....	157	B8681HD.....	144	B8734.....	150
B950.....	44	B8627.....	156	B8681HDA.....	144	B8735.....	149
B951.....	48	B8628.....	156	B8682.....	130	B8736.....	149
B952.....	54	B8629.....	160	B8682A.....	130	B8742.....	134
B953.....	59	B8630.....	160	B8682Z.....	130	B8742A.....	134
B954.....	48	B8631.....	163	B8682ZA.....	130	B8743.....	135
B955.....	49	B8632.....	160	B8683.....	133, 146	B8743A.....	135
B956.....	55	B8634.....	166	B8683A.....	133, 146	B8744.....	136
B957.....	57	B8634A.....	166	B8683HD.....	133, 146	B8744A.....	136
B960.....	160	B8635.....	155	B8683HDA.....	133, 146	B8745.....	143
B961.....	163	B8636.....	153	B8683Z.....	133, 146	B8745A.....	143
B962.....	N/C	B8643.....	145	B8683ZA.....	133, 146	B8746.....	135
B963.....	N/C	B8643A.....	145	B8684.....	141	B8746A.....	135
B971.....	55	B8644.....	144	B8684A.....	141	B8746Z.....	135
B972.....	58	B8644A.....	144	B8685Z.....	130	B8746ZA.....	135
B973.....	61	B8645.....	132, 145	B8685ZA.....	130	B8747.....	146
B974.....	57, 58	B8645A.....	132, 145	B8686.....	145	B8747A.....	146

Copyright 2016 Sirco Industries, Inc.

INDEX

PART NO.	PAGE	PART NO.	PAGE	PART NO.	PAGE	PART NO.	PAGE
B8747HD.....	146	B8796.....	136	C094R.....	99	C441L.....	104
B8747HDA.....	146	B8796A.....	136	C095L.....	99	C442BR.....	104
B8750.....	154	B8797.....	131	C096L.....	115	C442R.....	104
B8751.....	157	B8797L.....	131	C097R.....	115	C443BL.....	105
B8752.....	161	B8797R.....	131	C098L.....	115	C443L.....	105
B8753.....	161	B8798.....	131	C099R.....	115	C444BR.....	105
B8754.....	154	B8798A.....	131	C100R.....	103	C444R.....	105
B8755.....	158	B8800.....	133	C101L.....	103	C445BL.....	106
B8756.....	162	B8800A.....	133	C102L.....	116	C445L.....	106
B8757.....	161	B8801.....	134	C103R.....	116	C446BR.....	106
B8758.....	162	B8801A.....	134	C147CR.....	85	C446R.....	106
B8759.....	159	B8802.....	137	C147R.....	85	C447AL.....	104
B8760.....	151	B8802A.....	137	C148CL.....	85	C447L.....	104
B8761.....	157	B8803.....	139	C148L.....	85	C448AR.....	104
B8762.....	159	B8803L.....	139	C185L.....	95	C448R.....	104
B8763.....	164	B8803R.....	139	C186R.....	95	C449AL.....	105
B8764.....	158	B8804.....	143	C217L.....	111	C449L.....	104
B8765.....	163	B8804A.....	143	C218R.....	111	C450AR.....	105
B8766.....	147	B8805.....	142	C219L.....	111	C450R.....	104
B8771.....	147	BCP2174.....	66	C220R.....	111	C451AL.....	105
B8771A.....	147	BK-145F.....	15	C306L.....	95	C451L.....	105
B8772M.....	147	BK-145FM.....	15	C307R.....	95	C452AR.....	105
B8772MA.....	147	BK-145R.....	15	C310L.....	117	C452R.....	105
B8772MHD.....	148	BP-100.....	54	C311R.....	117	C478BR.....	83
B8772MHDA.....	148	BP-104.....	45	C312L.....	117	C478R.....	83
B8773M.....	148	BP-105.....	39	C313R.....	117	C479BL.....	83
B8773MA.....	148	BP-106.....	54	C314L.....	118	C479L.....	83
B8773MHD.....	148	BP-107.....	46	C315R.....	118	C490L.....	81
B8773MHDA.....	148	BP-108.....	52	C347L.....	90	C491R.....	81
B8781.....	164	BP-109.....	39	C348R.....	90	C492L.....	81
B8782.....	152	BP-110.....	45	C349L.....	91	C493R.....	81
B8783.....	155	BRBK.....	199	C350R.....	91	C494L.....	102
B8784.....	164	PBRBK.....	199	C351L.....	91	C495R.....	102
B8785.....	161	C055L.....	82	C352R.....	91	C496L.....	102
B8786.....	160	C056R.....	82	C410R.....	109	C497R.....	102
B8787.....	164	C057L.....	102	C411L.....	109	C499L.....	88
B8788.....	148	C058R.....	102	C412AR.....	87	C500R.....	88
B8790.....	142	C059L.....	102	C412R.....	87	C504L.....	89
B8790A.....	142	C060R.....	102	C413AL.....	87	C505R.....	89
B8790HD.....	142	C081L.....	107	C413L.....	87	C512L.....	113
B8790HDA.....	142	C082R.....	107	C420R.....	109	C513R.....	113
B8792.....	139	C083L.....	95	C421L.....	109	C514L.....	113
B8792A.....	139	C084R.....	95	C422R.....	109	C515R.....	113
B8793.....	140	C085L.....	94	C423L.....	109	C516L.....	113
B8793A.....	140	C086R.....	94	C424AR.....	98	C517R.....	113
B8794.....	142	C087L.....	107	C424R.....	98	C518L.....	115
B8794A.....	142	C088R.....	107	C425AL.....	98	C519R.....	115
B8794HD.....	142	C089L.....	99	C425L.....	98	C520L.....	115
B8794HDA.....	142	C090R.....	99	C426R.....	88	C521R.....	115
B8795.....	134	C091L.....	107	C427L.....	88	C522R.....	91
B8795A.....	134	C092R.....	107	C441BL.....	104	C524L.....	91

Copyright 2016 Sirco Industries, Inc.

INDEX

PART NO.	PAGE	PART NO.	PAGE	PART NO.	PAGE	PART NO.	PAGE
C526L.....	116	C668R.....	92	C726R.....	90	C857R.....	112
C527R.....	116	C669L.....	93	C727L.....	90	C861L.....	103
C528L.....	115	C670R.....	93	C728R.....	92	C862R.....	103
C529R.....	115	C675L.....	94	C729L.....	92	C866R.....	107
C530L.....	116	C676R.....	94	C730R.....	93	C867L.....	107
C531R.....	116	C677L.....	94	C731L.....	93	C868L.....	108
C532L.....	116	C678R.....	94	C732AR.....	93	C869R.....	108
C533R.....	116	C679L.....	95	C732R.....	93	C870R.....	107
C536R.....	91	C680R.....	95	C733AL.....	93	C871L.....	107
C537L.....	91	C681L.....	95	C733L.....	93	C880L.....	86
C540R.....	90	C682R.....	95	C734R.....	94	C881R.....	86
C541L.....	90	C683L.....	96	C735L.....	94	C882L.....	91
C563L.....	103	C684R.....	96	C737L.....	118	C883R.....	91
C564R.....	103	C686R.....	98	C738R.....	118	C884L.....	99
C568R.....	94	C687L.....	98	C740L.....	82	C885R.....	99
C569L.....	94	C688L.....	99	C741R.....	82	C886L.....	81
C584R.....	96	C689R.....	99	C742L.....	114	C887R.....	81
C585L.....	96	C690R.....	98	C743R.....	114	C888L.....	82
C594R.....	93	C691L.....	98	C750L.....	79	C889R.....	82
C595L.....	93	C693L.....	101	C751R.....	79	C890L.....	112
C600R.....	97	C694R.....	101	C752L.....	79	C891R.....	112
C601L.....	97	C702BR.....	85	C753R.....	79	C892L.....	112
C602R.....	97	C702R.....	85	C754L.....	79	C893R.....	112
C603L.....	97	C703BL.....	85	C755R.....	79	C894L.....	92
C604R.....	97	C703L.....	85	C756L.....	79	C895R.....	92
C605L.....	97	C706BR.....	83	C757R.....	79	C896L.....	88
C606R.....	97	C706R.....	83	C759L.....	110	C897R.....	88
C607L.....	97	C707BL.....	83	C760R.....	110	C898L.....	89
C608R.....	97	C707L.....	83	C761L.....	80	C899R.....	89
C609L.....	97	C708BR.....	86	C762R.....	80	C905L.....	110
C611L.....	113	C708R.....	85	C763L.....	79	C906R.....	110
C612R.....	113	C709BL.....	86	C764R.....	79	C910L.....	118
C645L.....	88	C709L.....	85	C769L.....	82	C911R.....	118
C646R.....	88	C710BR.....	86	C770R.....	82	C927L.....	113
C647L.....	88	C710R.....	86	C773CR.....	84	C928R.....	113
C648R.....	88	C711BL.....	86	C773R.....	83	C931L.....	117
C649L.....	89	C711L.....	86	C774CL.....	84	C932R.....	117
C650R.....	89	C714AR.....	87	C774L.....	83	C933L.....	117
C651L.....	89	C714R.....	86	C775R.....	81	C934R.....	117
C652R.....	89	C715AL.....	87	C776L.....	81	C935L.....	117
C653L.....	89	C715L.....	86	C786R.....	82	C936R.....	117
C654R.....	89	C716R.....	99	C787L.....	82	C972L.....	116
C655L.....	90	C717L.....	99	C794R.....	98	C973R.....	116
C656R.....	90	C718R.....	100	C795L.....	98	CMBK.....	199
C657L.....	90	C719L.....	100	C796R.....	100	PCMBK.....	199
C658R.....	90	C720R.....	101	C797L.....	100	CT310.....	121
C663L.....	92	C721L.....	101	C799R.....	81	CT311.....	121
C664R.....	92	C722R.....	101	C800L.....	81	CT312.....	121
C665L.....	92	C723L.....	101	C854L.....	112	CT313.....	121
C666R.....	92	C724L.....	112	C855R.....	112	CT331.....	121
C667L.....	92	C725R.....	112	C856L.....	112	CT332.....	120

Copyright 2016 Sirco Industries, Inc.

INDEX

PART NO.	PAGE	PART NO.	PAGE	PART NO.	PAGE	PART NO.	PAGE
CT333.....	120	HM212049.....	217	LB-6.....	10	S2008.....	66
CT334.....	121	HM218210.....	217	LB-7.....	10	S2009.....	74
CT336.....	120	HM218210/48.....	217	LB-8.....	10	S2010A.....	62
CT337.....	120	HM218248.....	217	LB-9.....	11	S2011A.....	63
CT338.....	120	HM516410.....	217	LB-10.....	11	S2012A.....	63
CT350.....	120	HM516410/49A... 217		LB-10D.....	13	S2019A.....	63
CT351.....	120	HM516449A.....	217	LB-10R.....	11	S2020A.....	62
CT356.....	121	HM518410.....	217	LB-10S.....	12	S2021A.....	62
CT357.....	121	HM518410/45.....	217	LB-11.....	11	S2022A.....	63
CT359.....	121	HM518445.....	217	LB-11R.....	11	S2023.....	63
CT360.....	121	K-1.....	32	LB-12.....	12	S2024.....	62
CT361.....	120	K-1A.....	32	LB-12R.....	12	S2025.....	62
CT369.....	120	K-2.....	22	LGBK.....	199	S2026.....	62
CT370.....	121	K-3.....	23	PLGBK.....	199	SA1041.....	74
CT375.....	120	K-4.....	24	LGBK-8.....	199	SA1042.....	74
DT20.....	212	KK-1A.....	33	MF-1.....	28	SA1073.....	74
DT24.....	212	L1308E.....	35	MF-2.....	28	SA1074.....	74
DT24LS.....	212	L1308E-EF1.....	35	MF-3.....	28	SA1132.....	69
DT30.....	212	L1308Q.....	35	MFBK.....	199	SA1133.....	69
DT30LS.....	212	L1308Q-RF3.....	35	PMFBK.....	199	SA1136.....	69
EF-1.....	17	L1443E.....	35	MK-1HD.....	29	SA1138.....	69
EF-2.....	23	L1443E-EF1.....	35	MK-2.....	29	SA1140.....	70
EK-1HD.....	22	L4311J.....	36	MK-2HD.....	29	SA1141.....	70
EK-2.....	33	L4311J-EK1HD... 36		QK-1.....	31	SA1144.....	70
EK-3.....	23	L4515Q.....	37	QK-1HD.....	31	SA2164.....	65
EQ-1.....	25	L4515Q-20.....	37	QK-1HDO.....	31	SA2167.....	65
ES-1.....	23	L4515Q-20-QK1 ... 37		QK-1MP.....	30	SA2170.....	65
ES-2.....	24	L4515Q-20-QK1HD..... 37		QK-1MPHD.....	30	SA2172.....	65
ES-3.....	17	L4515Q-QK1HD... 37		QK-2S.....	31	SA2174.....	66
ES-3R.....	17	L4515X.....	36	QK-2SHD.....	31	SA2175.....	66
ES-4.....	18	L4515X-XK3HD... 36		QK-8.....	31	SA2178.....	66
ES-4R.....	18	L4524M.....	36	QK-8HD.....	31	SA2179.....	66
ES-5.....	17	L4524M-MF2.....	36	RC-1.....	135	SA10100.....	71
ES-12.....	24	L4524Q.....	36	RC-1A.....	135	SA10101.....	72
ET-1.....	25	L4524Q-QK1HD.. 36		RC-1Z.....	135	SA10102.....	71
EX-1.....	25	L4702Q.....	36	RC-1ZA.....	135	SA10103.....	71
FF-1.....	16	L4702Q-RF5.....	36	RF-1ARK.....	20	SA10144.....	71
FF-1A.....	16	L4707.....	37	RF-2ARK.....	20	SA10211.....	72
FF-1S.....	16	L4707Q-20.....	37	RF-3.....	19	SA10212.....	73
FK-1.....	26	L4707Q-20-QK1... 37		RF-3A.....	19	SA10214.....	73
FK-1HD.....	26	L4707Q-20-QK1HD..... 37		RF-5.....	19	SA10215.....	72
FK-2.....	26	L4707-QK1HD... 37		RF-6.....	18	SA10216.....	72
FK-2HD.....	26	L4709N.....	36	RK-1.....	33	SA10305.....	72
FR-1.....	21	L4709N-ES2.....	36	RK-2.....	33	SA10306.....	72
FR-1A.....	21	LB-1.....	10, 13	RK-3.....	34	SA21102.....	68
FR-1S.....	21	LB-2.....	11	S2000.....	63	SA21103.....	68
FWBK.....	203	LB-3.....	14	PS2000.....	63	SA21953.....	67
HM212011.....	217	LB-3D.....	13	S2001.....	64	SA22102.....	68
HM212011/47.....	217	LB-4.....	14	S2002.....	68	SA22103.....	68
HM212011/49.....	217	LB-4A.....	14	S2006.....	70	SA22953.....	67
HM212047.....	217	LB-5.....	14	S2007.....	70	SA23106.....	68

Copyright 2016 Sirco Industries, Inc.

INDEX

PART NO.	PAGE	PART NO.	PAGE	PART NO.	PAGE	PART NO.	PAGE
SA24100.....	67	SF1013.....	226	SH1048.....	230	SR1009.....	239
SA25100.....	67	SF1014.....	226	SH1048U.....	230	SR1010.....	239
SB1000.....	220	SF1015.....	226	SH1049.....	231	SR1011.....	224, 226
SB1001.....	220	SF1016.....	227	SH1049U.....	231	239
SB1002.....	220	SF1017.....	227	SH1050.....	231	SR1012.....	240
SB1004.....	221, 244	SF1018.....	227	SH1053.....	231	SR1013.....	240
SB1004U.....	221, 244	SF1019.....	228	SH1053U.....	231	SR1014.....	240
SB1005.....	221	SF1020.....	227	SH1054.....	231	SR1015.....	240
SB1006.....	222	SF1021.....	227	SH1055.....	231	SR1016.....	241
SB1007.....	221, 244	SF1022.....	228	SH1057.....	222, 229	SR1017.....	241
SB1008.....	221	SH1001.....	233	245	SR1018.....	241
SB1009.....	222	SH1001U.....	233	SH1059.....	234	SR1019.....	241
SB1010.....	222	SH1008.....	229	SH1060.....	235	SR1020.....	241
SB1011.....	222	SH1008U.....	229	SH1061.....	231	SS307-0743.....	218
SB1013.....	220	SH1009.....	230	SH1062.....	235	SS372-7097.....	218
SB1014.....	221	SH1010.....	230	SH1063.....	223, 249	SS373-0143.....	218
SB1014U.....	221	SH1011.....	230	SH1064.....	223, 249	SS382-8036.....	218
SB1015.....	220	SH1012.....	229	SH1064H.....	249	SS392-9131.....	218
SB1016.....	221	SH1012U.....	229	SH1080.....	249	SS35066.....	218
SET 401.....	217	SH1016.....	235, 242	SH1081.....	249	SS38780.....	218
SET 402.....	217	247, 249	SH1082.....	249	SS42623.....	218
SET 403.....	217	SH1021.....	229	SH1083.....	249	SS46300.....	218
SET 404.....	217	SH1021U.....	229	SH1083H.....	249	SS46305.....	219
SET 405.....	217	SH1023.....	223, 237	SH1084.....	249	SS47692.....	219
SET 406.....	217	235, 242	SH1085.....	249	SS47697.....	219
SET 411.....	217	246	SH1086.....	249	SS370001.....	219
SET 412.....	217	SH1025.....	229	SH1087.....	249	SS370003.....	219
SET 413.....	217	SH1026.....	233	SH1090.....	249	SS370025.....	219
SET 414.....	217	SH1027.....	220, 233	SH1091.....	249	SS370065.....	219
SET 415.....	217	243	SH1092.....	249	SS755400.....	219
SET 421.....	217	SH1029.....	232	SH1093.....	249	SS761400.....	219
SET 425.....	217	SH1030.....	222, 233	SH1094.....	249	ST1000.....	243
SF-1.....	16	SH1031.....	233	SH1095.....	249	ST1001.....	243
SF693.....	228	SH1032.....	223, 233	SH1096.....	249	ST1002.....	243
SF1000.....	224	SH1033.....	234	SH1097.....	249	ST1003.....	243
SF1001.....	224	SH1034.....	234	SH2726.....	236	ST1004.....	243
SF1002.....	224	SH1035.....	234	SH2727.....	236	ST1005.....	244
SF1002U.....	224	SH1036.....	234	SH2728.....	236	ST1006.....	244
SF1003.....	224	SH1037.....	234	SR1000.....	238	ST1007.....	244
SF1004.....	224	SH1038.....	235	SR1001.....	238	ST1008.....	244
SF1004U.....	224	SH1039.....	235, 242	SR1001U.....	238	ST1009.....	245
SF1005.....	225	247, 249	SR1002.....	238	ST1010.....	245
SF1006.....	225	SH1039H.....	249	SR1002U.....	238	ST1011.....	245
SF1007.....	225	SH1040.....	232	SR1003.....	238	ST1012.....	245
SF1008.....	225	SH1040U.....	232	SR1004.....	238	ST1013L.....	246
SF1009.....	225	SH1041.....	232	SR1005.....	238	ST1013R.....	246
SF1009U.....	225	SH1042.....	232	SR1006.....	239	ST1014.....	246
SF1010.....	225	SH1043.....	232	SR1007.....	239	ST1015L.....	246
SF1011.....	226	SH1044.....	229	SR1007U.....	239	ST1015R.....	246
SF1011U.....	226	SH1045.....	230	SR1008.....	239	ST1017.....	247
SF1012.....	226	SH1046.....	230	SR1008U.....	239	ST1018.....	247

Copyright 2016 Sirco Industries, Inc.

INDEX

PART NO.	PAGE			
ST1019.....	245			
TK-1.....	30			
TK-1HD.....	30			
TK-4.....	32			
TK-4HD.....	32			
TK-4MP.....	32			
TK-4MPHD.....	32			
TK-7.....	29, 30			
TK-7HD.....	29, 30			
WF-1.....	20			
WF-1A.....	20			
XK-1.....	26			
XK-1HD.....	26			
XK-3.....	27			
XK-3HD.....	27			
XK-3MP.....	27			
XK-3MPHD.....	27			
XL-1.....	22			



LIGHT AND MEDIUM TRAILER COMPONENTS



TABLE of CONTENTS

	<u>PAGE</u>
AXLES	
Tube Axle Beams.....	2
Spring Axles and Torsion Axles.....	3
Axle Specification Sheet.....	4-5
AXLE COMPONENTS	
Spring Seats, Spindles and Spindle Fasteners.....	6
Spindle Nut Kits, Grease Caps and Grease Cap Kits.....	7
Oil Caps, O-Rings and Plug.....	8
Bearings and Bearing Kits.....	9
Seals and Seal Kits.....	10
Bearing and Seal Kits.....	11
Bearing, Hubcap and Seal Kits and Bearing Protectors.....	12
Wheel Fasteners and Wheel Fastener Kits.....	13
BRAKES AND BRAKE COMPONENTS	
Idler Hubs, Idler Hub Assemblies and Hubs / Drums.....	14
Hub / Drum Assemblies, Brake Drum Only and Hub Only.....	15
Electric Brake Assemblies.....	16
Magnet Kits, Brake Shoe and Lining Kits and Hydraulic Brake Assemblies.....	17
SUSPENSION	
Suspension Diagrams.....	18
Double Eye Leaf Springs, Slipper Leaf Springs and Bushings.....	19
Equalizers, Double Eye Spring Hangers and Slipper Spring Hangers.....	20
Double Eye Hanger Kits and Slipper Hanger Kits.....	21
U-Bolts and U-Bolts with Nuts.....	22
U-Bolt Kits with Tie Plates, Tie Plates and Flange Nuts.....	23
Shackle Links, Shackle Link Kits and Shackle Link Assemblies.....	24
Suspension Bolts, Suspension Nuts and Suspension Bolt and Nut Kits.....	25
Equalizer Kits.....	26-27
JACKS AND COUPLERS	
Electric A-Frame, A-Frame, Weld-On, Bolt-On and Tube-Pipe Mount Jacks.....	28
Direct Weld, Drop Leg and Marine Jacks and Jack Accessories.....	29
A-Frame Couplers, Adjustable Couplers, Frame Couplers.....	30
TOWING ACCESSORIES	
Pintle Hooks, Draw Bars, Pintle Mounts and Adjustable Brackets.....	31
Trailer Hitch Balls, Ball Mounts and Ball Mounts with Balls and Pins.....	32
Receiver Tubes and Receiver Hitch Pins.....	33
BRAKE ACTUATION	
Brake Controllers.....	34
Brake Control Harnesses, Breakaway Kits, Replacement Battery and Switches.....	35
ELECTRICAL AND LIGHTING	
Trailer Cable Wire.....	36
STT / Back-Up Lights and Light Plugs.....	37
ACCESSORIES	
Conspicuity Tape, D-Rings and Floor Screws.....	38
Tarp Straps, Wheel Chocks and Steel Underbody Toolboxes.....	39
Geocel Sealants and Adhesives.....	40
INTERCHANGES	41-48
INDEX	49-51

Manufacturers' and replacement parts suppliers' names and numbers are used for reference purposes only, and, it is not implied any part listed is a product of these manufacturers or suppliers.

AXLES

2K TUBE AXLE BEAMS

1-3/4" TUBE WITH 1-1/16" STRAIGHT SPINDLES



PART #	TRACK	HUB FACE	TIP-TO-TIP	SPRING CENTER	DEXTER
AB2SF-54	54"	55"	59-1/2"	39-43"	2SF-54
AB2SF-58	58"	59"	63-1/2"	43-47"	2SF-58
AB2SF-70	70"	71"	75-1/2"	55-59"	2SF-70
AB2SF-73	73"	74"	78-1/2"	58-62"	2SF-73

3.5K TUBE AXLE BEAMS

2-3/8" TUBE WITH 1-3/8" x 1-1/16" STEP SPINDLES



PART #	TRACK	HUB FACE	TIP-TO-TIP	SPRING CENTER	DEXTER
AB3SF-84	84"	85"	89-1/2"	67-72"	3SF-84
AB3SF-86	86"	87"	91-1/2"	69-74"	3SF-86
AB3SF-88	88"	89"	93-1/2"	71-76"	3SF-88
AB3SF-94	94"	95"	99-1/2"	77-82"	3SF-94
AB3DF-88	88"	89"	93-1/2"	71-76"	3DF-88
AB3DF-93	93"	94"	98-1/2"	76-81"	3DF-93

6K TUBE AXLE BEAMS

3" TUBE WITH 1-3/4" x 1-1/4" STEP SPINDLES



PART #	TRACK	HUB FACE	TIP-TO-TIP	SPRING CENTER	DEXTER
AB6SF-73	73"	74"	80"	55-59"	6SF-73
AB6SF-79.5	79-1/2"	80-1/2"	86-1/2"	61-1/2" - 65-1/2"	6SF-79.5
AB6SF-81.25	81-1/4"	82-1/4"	88-1/4"	63-1/4" - 67-1/4"	6SF-81.25
AB6SF-86	86"	87"	93"	68-72"	6SF-86
AB6SF-88	88"	89"	95"	70-74"	6SF-88
AB6SF-94	94"	95"	101"	76-80"	6SF-94
AB6DF-94	94"	95"	101"	76-80"	6DF-94

AXLES

SPRING AXLES



DESCRIPTION	DIAMETER	THK	GA	MISC
500-2,200 lbs	1.75"	.180"	7	ASTM A-500 Grade B ERW material
2,500-3,500 lbs	2.375"	.180"	7	ASTM A-500 Grade B ERW material
5,200-6,000 lbs	3"	.180"	7	ASTM A-500 Grade B ERW material
7,000 lbs	3"	.250"	4	ASTM A-500 Grade B ERW material
8,000 lbs	3.5"	.500"		DOM Tubing

*All axles are powder coated black

*Safe-T-Lube spindles are supplied on all axles, **except** 2,000 lb axles

TORSION AXLES



DESCRIPTION	DIAMETER	THK	MISC
500- 2,200 lbs	2.173"	.149"	A-500 Grade B ERW material
2,500-3,700 lbs	2.625"	.187"	A-500 Grade B ERW material
5,200-6,000 lbs	3.031"	.203"	A-500 Grade B ERW material
7,000 lbs	3.5"	.250"	A-500 Grade B ERW material
8,000 lbs	3.875"	.250"	DOM Tubing

*All axles are powder coated black

*All axles have standard low-profile brackets

*All axles are round corner square

*Safe-T-Lube spindles are quoted on all axles

*Standard wall thickness tubing is used on all axles

*Excludes attaching parts kits (AP or Side Mount Kit)

AXLE COMPONENTS

SPRING SEATS



PART #	DESCRIPTION	TUBE DIAMETER	DEXTER	REDNECK	NUERA	QUALITY
SS-238	Spring Seat	2-3/8" Round Axle	003-064-00	3-43	27-251	SP-2-375
SS-300	Spring Seat	3" Round Axle	003-070-00	3-42	27-252	SP-3

SPINDLES

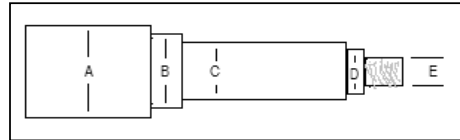

Measurement Chart
1" - 14 Thread

PART #	DESCRIPTION	A	B	C	D	E	REDNECK	QUALITY
S-42	2,500# #42 6" Shank	2.25"	2.24"	1.75"	1.25"	1"	R50642	R50642
S-84	1,750# #84 4" Shank	2.00"	1.72"	1.376"	1.06"	1"	R40484	R40484

SPINDLE FASTENERS



PART #	DESCRIPTION	O.D.	I.D.	THK	DEXTER	REDNECK	NUERA	QUALITY
5-23	"D" Washer	1.67"	1"	.13"	005-023-00	5-23	27-058	5-23
5-27	Round Washer	1.67"	1"	.13"	005-027-00	SW1000	27-058-3	4753
5-57	"D" Washer - Heat Treated	1.67"	1"	.13"	005-057-00	5-57	27-059	
5-101	Tang Washer	1.57"	1"	.048"	005-101-00	5-101	27-058-1	93001
6-1	Castle Nut - 1" - 14	1.46"	1"	.55"	006-001-00	165686	27-057	4754
6-191	Spindle Nut - 1" - 14	--	1.75"	--	006-191-00	6-191	27-057-3	
6-190	Spindle Nut Retainer	--	--	--	006-190-00	6-190	27-061	
5-59	Tang Washer	--	1.75"	--	005-059-00	5-59	27-065	
5-60	Spindle Washer	--	1.75"	--	005-060-00	5-60	27-063	
6-84	Spindle Nut	--	1.75"	--	006-084-00	6-84	27-064	
19-2	Cotter Pin - 1/8" x 1-3/4"	--	--	--	019-002-00	165649	27-027	4755
15-2	Rim Clamp	--	--	--	015-012-00	15-12	27-024	

AXLE COMPONENTS

SPINDLE NUT KITS



PART #	DESCRIPTION	INCLUDES	DEXTER	REDNECK
K71-321	Spindle Nut Kit	(2) 5-57 "D" Washer (2) 6-1 Castle Nut (2) 19-2 Cotter Pin	K71-321-00	RG05-080
K71-322	Spindle Nut Kit	(2) 5-23 "D" Washer (2) 6-1 Castle Nut (2) 19-2 Cotter Pin	K71-322-00	RG05-040
K71-335	Spindle Nut Kit	(2) 5-23 "D" Washer (2) 5-101 Tang Washer (2) 6-1 Castle Nut	K71-335-00	RG05-060
K71-341	Spindle Nut Kit	(1) 5-59 Tang Washer (1) 5-60 Spindle Washer (2) 6-84 Spindle Nut	K71-341-00	

GREASE CAPS



PART #	DESCRIPTION	O.D.	SPECS	DEXTER	REDNECK	NUERA	QUALITY
21-1	Grease Cap	2.44"	Fits 12" x 2" Hub 4, 5 & 6 Bolt	021-001-00	45896	27-371	21-1
21-3	Grease Cap	1.99"	Fits 7", 10" x 1-1/2", 10" x 2-1/4" Hub	021-003-00	46749	27-370	21-3
21-39	Grease Cap	2.72"	Fits 12" x 2" Hub 8 Bolt	021-039-00	38605	27-372	1605
21-41	Lube Grease Cap	1.99"	Fits 7", 10" x 1-1/2", 10" x 2-1/4" Hub	021-041-00	21-3-1	27-370-2	21-3-AL
21-42	Lube Grease Cap	2.44"	Fits 12" x 2" Hub 5 & 6 Bolt	021-042-00	21-1-1	27-371-2	21-1-AL
21-43	Lube Grease Cap	2.72"	Fits 12" x 2" Hub 8 Bolt	021-043-00	21-43-1	27-372-2	1605-AL
85-1	Lube Plug	1.18"	Lube Plug for Lube Grease Caps	085-001-00	85-1	27-379	RP-100

GREASE CAP KITS



PART #	DESCRIPTION	INCLUDES	DEXTER	REDNECK
K71-314	Grease Cap Kit	(2) 21-3 Cap	K71-314-00	RG04-020
K71-315	Lube Grease Cap Kit	(2) 21-41 Cap (2) 85-1 Plug	K71-315-00	RG04-040
K71-316	Grease Cap Kit	(2) 21-1 Cap	K71-316-00	RG04-060
K71-317	Lube Grease Cap Kit	(2) 21-42 Cap (2) 85-1 Plug	K71-317-00	RG04-080
K71-318	Grease Cap Kit	(2) 21-39 Cap	K71-318-00	RG04-100
K71-319	Lube Grease Cap Kit	(2) 21-43 Cap (2) 85-1 Plug	K71-319-00	RG04-120
K71-320	Lube Plug Kit	(2) 85-1 Plug	K71-320-00	RG04-010

AXLE COMPONENTS

OIL CAPS



PART #	DESCRIPTION	SPECS	DEXTER	REDNECK	NUERA	QUALITY
21-35	Screw In Plastic (6K - 8K)	2.875" O D Includes O-Ring & Plug	021-035-00	21-35	27-373	21-35
21-38	Screw In Plastic (7K - 8K new style)	3.180" O D Includes O-Ring & Plug	021-217-00 K71-845-00 K363587	1531095 RG04-280		
21-88	Screw In Plastic (9K, 10K GD)	3.895" O D Includes O-Ring & Plug	021-088-00	21-88 RG04-300	27-373-5	D01C
21-36	Screw In Plastic (9K, 10K GD, 10K - 15K DX)	4.00" O. Includes O-Ring & Plug	021-036-00	21-36	27-374-1	22-07
21-37	Screw In Plastic (10K - 16K)	4.00" O. Includes O-Ring & Plug	021-219-00 K71-859-00 K568220	92125		12011-1

O-RINGS

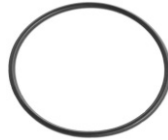

PART #	DESCRIPTION	SPECS	DEXTER	REDNECK	NUERA	QUALITY
10-45	O-Ring	For 21-35 Oil Cap	010-045-00	10-45	27-375	10-45
10-50	O-Ring	For 21-36 Oil Cap	010-050-00	10-50	27-376	10-50
568222	O-Ring	For 21-37 Oil Cap	010-258-00	92127		V75340
10-163	O-Ring	For 21-88 Oil Cap	010-163-00	10-163	27-376-1	

PLUG



PART #	DESCRIPTION	SPECS	DEXTER	REDNECK	NUERA	QUALITY
46-32	Plug	For 21-35, 21-36, 21-88 Oil Cap	046-032-00	46-32	27-377	RP-200

AXLE COMPONENTS

BEARINGS

PART #	BEARING #	DESCRIPTION	I.D.	O.D.	DEXTER	REDNECK	NUERA	QUALITY
31-17-1	14276	Cup		2.72"	031-017-01	14276	27-331	
31-17-2	14125A	Cone	1.25"		031-017-02	14125A	27-330	
31-19-1	382A	Cup		3.813"	031-019-01	382A	27-339	
31-19-2	387A	Cone	2.25"		031-019-02	387A	27-338	
31-28-1	02420	Cup		2.6875"	031-028-01	02420	27-333	02420
31-28-2	02475	Cone	1.25"		031-028-02	02475	27-332	02475
31-29-1	15245	Cup		2.44"	031-029-01	15245	27-341	15245
31-29-2	15123	Cone	1.25"		031-029-02	15123	27-340	15123
31-30-1	25520	Cup		3.27"	031-030-01	25520	27-327	25520
31-30-2	25580	Cone	1.75"		031-030-02	25580	27-326	25580
31-31-1	L44610	Cup		1.98"	031-031-01	L44610	27-321	L44610
31-31-2	L44649	Cone	1.062"		031-031-02	L44649	27-320	L44649
31-32-1	LM67010	Cup		2.33"	031-032-01	LM67010	27-329	LM67010
31-32-2	LM67048	Cone	1.25"		031-032-02	LM67048	27-328	LM67048
31-33-1	L68111	Cup		2.36"	031-033-01	L68111	27-325	L68111
31-33-2	L68149	Cone	1.377"		031-033-02	L68149	27-324	L68149
31-31-3	L44643	Cone	1"		031-031-03	L44643	27-346	L44643



BEARING KITS

PART #	DESCRIPTION	INCLUDES	DEXTER	QUALITY
K71-306	Bearing Kit	(1) 31-31-1 Cup (L44610) (1) 31-31-2 Cone (L44649)	K71-306-00	PP2K-BT16BR
K71-307	Bearing Kit	(1) 31-32-1 Cup (LM67010) (1) 31-32-2 Cone (LM67048)	K71-307-00	
K71-308	Bearing Kit	(1) 31-30-1 Cup (25520) (1) 31-30-2 Cone (25580)	K71-308-00	
K71-309	Bearing Kit	(1) 31-29-1 Cup (15245) (1) 31-29-2 Cone (15123)	K71-309-00	
K71-310	Bearing Kit	(1) 31-17-1 Cup (14276) (1) 31-17-2 Cone (14125A)	K71-310-00	
K71-390	Bearing Kit	(1) 31-33-1 Cup (L68111) (1) 31-33-2 Cone (L68149)	K71-390-00	
K71-415	Bearing Kit	(1) 31-28-1 Cup (02420) (1) 31-28-2 Cone (02475)	K71-415-00	



AXLE COMPONENTS

SEALS



PART #	DESCRIPTION	I.D.	O.D.	DEXTER	REDNECK	NUERA	QUALITY
10-10	Double Lip Seal	2.12"	3.37"	010-010-00	10-10	27-352-1	10-10
10-19	Double Lip Seal	1.72"	2.56"	010-019-00	10-19	27-351-1	171255TB
10-36	Double Lip Seal	2.25"	3.37"	010-036-00	10-36	27-352-2	22333TBN
10-60	Double Lip Seal	1.50"	1.99"	010-060-00	10-60		15-192TB
10-51	Unitized Oil Seal	2.855"	3.88"	010-051-00	10-51	27-359-1	10-51
10-56	Unitized Oil Seal	3.125"	4.50"	010-056-00 K71-388-00	10-56	27-358	10-56
10-63	Unitized Oil Seal	2.25"	3.376"	010-063-00	10-63	27-360-N	370219A

SEAL KITS



PART #	DESCRIPTION	INCLUDES	DEXTER	REDNECK
K71-301	Seal Kit	(2) 10-60 Seal	K71-301-00	RG06-020
K71-303	Seal Kit	(2) 10-19 Seal	K71-303-00	RG06-050
K71-304	Seal Kit	(2) 10-10 Seal	K71-304-00	RG06-090
K71-305	Seal Kit	(2) 10-36 Seal	K71-305-00	RG06-070
K71-386	Seal Kit	(2) 10-63 Seal	K71-386-00	

AXLE COMPONENTS

BEARING AND SEAL KITS

PART #	DESCRIPTION	INCLUDES	REDNECK
BK1-150	Bearing & Seal Kit	(2) 31-31-1 Cup (L44610) (2) 31-31-2 Cone (L44649) (1) 10-60 Seal (1) 19-2 Pin	BK1-150
BK2-100	Bearing & Seal Kit	(1) 31-31-1 Cup (L44610) (1) 31-31-2 Cone (L44649) (1) 31-33-1 Cup (L68111) (1) 31-33-2 Cone (L68149) (1) 10-19 Seal (1) 19-2 Pin	BK2-100
BK3-100	Bearing & Seal Kit	(1) 31-29-1 Cup (15245) (1) 31-29-2 Cone (15123) (1) 31-30-1 Cup (25520) (1) 31-30-2 Cone (25580) (1) 10-36 Seal (1) 19-2 Pin	BK3-100
BK3-110	Bearing & Seal Kit	(1) 31-29-1 Cup (15245) (1) 31-29-2 Cone (15123) (1) 31-30-1 Cup (25520) (1) 31-30-2 Cone (25580) (1) 10-10 Seal (1) 19-2 Pin	BK3-110
BK3-200	Bearing & Seal Kit	(1) 31-17-1 Cup (14276) (1) 31-17-2 Cone (14125A) (1) 31-30-1 Cup (25520) (1) 31-30-2 Cone (25580) (1) 10-36 Seal (1) 19-2 Pin	BK3-200
BK3-210	Bearing & Seal Kit	(1) 31-17-1 Cup (14276) (1) 31-17-2 Cone (14125A) (1) 31-30-1 Cup (25520) (1) 31-30-2 Cone (25580) (1) 10-10 Seal (1) 19-2 Pin	BK3-210
BK3-300	Bearing & Seal Kit	(1) 31-32-1 Cup (LM67010) (1) 31-32-2 Cone (LM67048) (1) 31-30-1 Cup (25520) (1) 31-30-2 Cone (25580) (1) 10-36 Seal (1) 19-2 Pin	BK3-300
BK3-310	Bearing & Seal Kit	(1) 31-32-1 Cup (LM67010) (1) 31-32-2 Cone (LM67048) (1) 31-30-1 Cup (25520) (1) 31-30-2 Cone (25580) (1) 10-10 Seal (1) 19-2 Pin	BK3-310



AXLE COMPONENTS

BEARING, HUBCAP AND SEAL KITS



PART #	DESCRIPTION	INCLUDES
BHSK-100	Bearing, Hubcap & Seal Kit Includes 1/2"-20 Wheel Nuts	(1) 31-31-2 Cone (L44649) (1) 31-33-2 Cone (L68149) (1) 21-3 Dust Cap (1) 10-19 Seal (5) 6-80 Wheel Nut
BHSK-200	Bearing, Hubcap & Seal Kit Includes 1/2"-20 Wheel Nuts	(1) 31-31-2 Cone (L44649) (1) 31-33-2 Cone (L68149) (1) 21-3 Dust Cap (1) 10-19 Seal (6) 6-80 Wheel Nut
BHSK-300	Bearing, Hubcap & Seal Kit Includes 1/2"-20 Wheel Nuts	(1) 31-29-2 Cone (15123) (1) 31-30-2 Cone (25580) (1) 21-1 Dust Cap (1) 10-36 Seal (6) 6-80 Wheel Nut
BHSK-400	Bearing, Hubcap & Seal Kit Includes 1/2"-20 Wheel Nuts	(1) 31-17-2 Cone (14125A) (1) 31-30-2 Cone (25580) (1) 21-39 Dust Cap (1) 10-36 Seal (8) 6-80 Wheel Nut

BEARING PROTECTORS



PART #	DESCRIPTION	MISC	REDNECK	NUERA	QUALITY	BEARING BUDDY
BP-1980	Bearing Protector	Steel Chrome Plated Hub Bore 50.29mm	RG07-040	27-369-A	BP198	1980
BP-244	Bearing Protector	Steel Chrome Plated Hub Bore 62.00mm		27-369-1A	BP244	244

AXLE COMPONENTS

WHEEL FASTENERS



PART #	DESCRIPTION	SPECS	DEXTER	REDNECK	NUERA	QUALITY
6-80	Wheel Nut	1/2"-20 Thread 13/16" AF 60° Cone	006-080-00	X1023R	27-008	4756
6-53	Wheel Nut	9/16"-18 Thread 7/8" AF 60° Cone	006-053-00	6-53	27-032	
6-109	Wheel Nut	5/8"-18 Thread 1" AF 90° Cone	006-109-00	6-109	27-032-2	
6-98	Wheel Nut Stainless Capped	1/2"-20 Thread 13/16" AF 60° Cone	006-098-00		27-008-1	
7-40	Wheel Bolt Hex Head	1/2"-20 Thread 7/8" Long 60° Cone	007-040-00	X1064	27-007	7-40
7-122	Wheel Stud Grade 8	1/2"-20 Thread 1-13/16" Long Knurl O.D.	007-122-00	7-122	27-383	
7-246	Wheel Stud Grade 8	1/2"-20 Thread 1-7/8" Long Knurl O.D.	007-246-00	09251510	27-383-1	
7-262	Wheel Stud Grade 8	1/2"-20 Thread 2-1/2" Long Knurl O.D.	007-262-00	165995	27-372-BB	

WHEEL FASTENER KITS

PART #	DESCRIPTION	INCLUDES	DEXTER	REDNECK
K71-295	Wheel Stud Packaged	(6) 7-122 Stud	K71-295-00	RG03-040
K71-296	Wheel Bolt Packaged	(5) 7-40 Bolt	K71-296-00	RG02-020
K71-299	Wheel Nut Packaged	(6) 6-80 Nut	K71-299-00	RG01-060
K71-300	Wheel Nut Packaged	(6) 6-98 Nut	K71-300-00	
K71-471	Wheel Stud Packaged	(5) 7-246 Stud	K71-471-00	RG03-060
RG03-080	Wheel Stud Packaged	(5) 7-262 Stud		RG03-080

BRAKES AND BRAKE COMPONENTS

IDLER HUBS

(CUPPED AND STUDED ONLY)



PART #	CAP	BOLT		INNER		OUTER		MISC	DEXTER	REDNECK	NUERA	QUALITY
		CIRCLE	RACE	RACE	RACE	SEAL	RACE					
8-91-5	2K	4 x 4	31-31-1 L44610	31-31-1 L44	1.50"				008-091-05	34	27 282-1	8844 1
8-258-5	2K	5 x 4.5	31-33 1 L68111	31-31-1 L44	1.50"	6.5 HF 13"-15" Wheels			008-258-05	8-25 5	27-281-1	8854 1
8-259-5	2K	5 x 4.5	31-31 1 L44610	31-31-1 L44	1.50"	5.5 HF 8"-12" Wheels			008-259-05	34822545	27-284-1	
8-248-5	3.5K	5 x 4.5	31-33 1 L68111	31-31-1 L44	1.718"				008-248-05	84	27-290-I-ALB	84545-1
84550	3.5K	5 x 5	31-33-1 L68111	31-31-1 L44	1.718				008-256-7	845		84550-1

IDLER HUB ASSEMBLIES

Idler Hub Assemblies Contain: Hub Seal Bearing Cones Dust Caps
Wheel Nuts



PART #	CAP	BOLT		INNER		OUTER		MISC	DEXTER	REDNECK
		CIRCLE	BEARING	BEARING	SEAL	SEAL				
K8-91-91	2K	4 x 4	31-31-2 L44649	31-31-2 L44649	1.50"				K08-091-91	8-91-5UC1
K8-258-91	2K	5 x 4.5	31-31-2 L44649	31-31 2 L44649	1.50"	6.5 HF 13"-15" Wheels			K08-258-91	8-258-5UC1
K8-259-91	2K	5 x 4.5	31-31-2 L44649	31-31-2 L44649	1.50"	5.5 HF 8"-12" Wheels			K08-259-91	8-259-5UC1
K8-248-9	3.5K	5 x 4.5	31-33-2 L68149	31-31-2 L44649	1.718"				K08-248-90	84545UC1
84550UC1	3.5K	5 x 5	31-33-2 L68149	31-31-2 L44649	1.718					84550UC1

HUBS / DRUMS

(CUPPED AND STUDED ONLY)



PART #	CAP	BOLT		INN R		OUTER		MISC	DEXTER	REDNECK	NUERA	QUALITY
		CIRCLE	RACE	RACE	RACE	SEAL	RACE					
8-257-5	2K	5 x 4.5	31-31 1 L44610	31-31-1 L446	1.50"	7" Brake			00 257-05	HD700A	27 281-B	
8-247-5	3.5K	5 x 4.5	31-33 1 L68111	31-31-1 L446	1.718"	10" Brake			00 247-05	845	27-290-B-ALB	94545-1
8-247-12	3.5K	5 x 4.75	31-33-1 L68111	31-31-1 L44610	1.71	10" Brake			00 247-12	845	27-295-B	9454 1
8-249-7	3.5K	5 x 5	31-33-1 L68111	31-31-1 L446	1.718"	10" Brake			00 249-07	845	27-294-B-ALB	94550-1
8-249-5	3.5K	5 x 5.5	31-33 1 L68111	31-31-1 L446	1.718"	10" Brake			00 249-05	845	27 291-B	9455 1
8-250-5	3.5K	6 x 5.5	31-33 1 L68111	31-31-1 L446	1.718"	10" Brake			00 250-05	846	27 292-B	9465 1
8-201-5	5.2K	6 x 5.5	31-30 1 25220	31-31-1 LM67010	2.125"	12" Brake			00 201-05	8-201 5	27-300 B-ALB	
8-201-9	6K	6 x 5.5	31-30 1 25220	31-29-1 1424	2.12	12" Brake			00 201-90	426	27-305-B-ALB	92655-1
8-219-4	7K	8 x 6.5	31-30 1 25220	31-17-1 1427	2.12	12" Brake			00 219-04	428	27-301-B-ALB	92865A-1
8-219-13	7K	8 x 6.5	31-30 1 25220	31-17-1 1427	2.12	12" Brake			00 219-13	8-219-13		
8-288-5	9-10K	8 x 6.5	-- 382A	31-30-1 25520	2.87	12-1/4" Brake			008-288-05	8-288-3 9-44-1	27 314-1-1 27 315-3 27-314-1-B	

BRAKES AND BRAKE COMPONENTS

HUB / DRUM ASSEMBLIES

Hub / Drum Assemblies Contain: Hub Seal Bearing Cones Wheel Nuts Dust Caps



PART #	CAP	BOLT CIRCLE	INNER BEARING	OUTER BEARING	SEAL	MISC	DEXTER	REDNECK
K8-257-91	2K	5 x 4.5	31-31-2 L44649	31-31-2 L44649	1.50"	7" Brake	K08-257-91	HD701BUC3
K8-247-9	3.5K	5 x 4.5	31-33-2 L68149	31-31-2 L44649	1.718"	10" Brake	K08-247-90	84546UC3
K8-247-93	3.5K	5 x 4.75	31-33-2 L68149	31-31-2 L44649	1.718"	10" Brake	K08-247-93	
K8-249-91	3.5K	5 x 5	31-33-2 L68149	31-31-2 L44649	1.715"	10" Brake	K08-249-91	84557UCE
K8-250-90	3.5K	6 x 5.5	31-33-2 L68149	31-31-2 L44649	1.718"	10" Brake	K08-250-90	84656UC3
K8-201-9	5.2K	6 x 5.5	31-30-2 25580	31-32-2 LM67048	2.125"	12" Brake	K08-201-90	8-201-5UC3
K8-201-97	5.2K	6 x 5.5	31-30-2 25580	31-32-2 LM67048	2.25"	12" Brake	K08-201-97	
K8-201-9A	6K	6 x 5.5	31-30-2 25580	31-29-2 15123	2.25"	12" Brake	K08-201-9A	42656UC3
K8-201-91	6K	6 x 5.5	31-30-2 25580	31-29-2 15123	2.125"	12" Brake	K08-201-91	8-201-9UC3
K8-219-90	7K	8 x 6.5	31-30-2 25580	31-17-2 14125A	2.125"	12" Brake	K08-219-90	8-219-4UC3
K8-219-91	7K	8 x 6.5	31-30-2 25580	31-17-2 14125A	2.125"	12" Brake	K08-219-91	8-219-13UC3
K8-219-9D	7K	8 x 6.5	31-30-2 25580	31-17-2 14125A	2.25"	12" Brake	K8-219-9D	42866UC3
K8-288-9	9-10K	8 x 6.5	31-30-2	31-19-2	2.855"	12-1/4" Brake	K08-288-90	8-288-3UC1

BRAKE DRUM ONLY



PART #	CAP	MISC	DEXTER	REDNECK	NUERA
568699	10-12K	For 12-1/4" x 3-1/2" Brake Non ABS	009-132-01 56869 090904		
9-27-1	10K HD	For 12-1/4" x 4" Brake Drum Use with 8-214-5 Oil Hub Non ABS	009-027-01	9-27-1	27-315
9-28-1	12-15K	For 12-1/4" x 5" Brake Non ABS	009-028-01	9-28-1	27-315-2

HUB ONLY



PART #	CAP	MISC	DEXTER	REDNECK	NUERA
8-214-5	10K	For 12-1/4" x 4" Brake Non ABS	008-214-05	8-214-5	27-314-1

BRAKES AND BRAKE COMPONENTS

ELECTRIC BRAKE ASSEMBLIES



PART #	L/R	CAP	SIZE	DEXTER	REDNECK	NUERA	QUALITY
K23-47	L	2K	7" x 1-1/4"	K23-047-00	23-47	27-438	4740-L
K23-48	R			K23-048-00	EB01-070 23-48 EB01-075	27-439	4740-R
K23-26	L	3.5K	10" x 2-1/4"	K23-026-00	23-26	27-440-ALB	4701-L
K23-27	R			K23-027-00	EB01-100 BE10-35L K363383.2 23-27 EB01-105 BE10-35R K363383.1	27-441-ALB	4701-R
K23-105	L	6K	12" x 2"	K23-105-00	23-105	27-442-ALB	
K23-106	R			K23-106-00	23-106	27-443-ALB	
K23-180	L	7K	12" x 2"	K23-180-00	23-180	27-450-ALB	4704-L
K23-181	R			K23-181-00	EB01-120 BE12-70L K568106.2 23-181 EB01-125 BE12-70R K568106.1	27-451-ALB	4704-R
K23-532	L	8K	12" x 3-3/8"	K23-532-00 K363601	K363601		363601
K23-533	R			K23-533-00 K363602	K363602		363602
K23-432	L	8K	12-1/4" x 3-3/8"	K23-432-00			
K23-433	R			K23-433-00			
K23-434	L	8K	12-1/4" x 3-3/8"	K23-434-00	23-434 EB01-130	27-444-1	23-97
K23-435	R			K23-435-00	23-435 EB01-135	27-445-1	23-98
K23-450	L	9-10K	12-1/4" x 3-3/8"	K23-450-00	23-450 EB01-140	27-448-2	23-195
K23-451	R			K23-451-00	23-451 EB01-145	27-449-2	23-196
K23-256	L	10-12K	12-1/4" x 3-1/2"	K23-528-00	K568255.2		568255.2
K23-255	R			K568255.2 K23-529-00 K568255.1	K568255.1		568255.1
K23-438	L	10K HD	12-1/4" x 4"	K23-438-00	23-438	27-448-3	
K23-439	R			K23-439-00	23-439	27-449-3	
K23-442	L	12K	12-1/4" x 5"	K23-442-00	23-442	27-452-1	
K23-443	R			K23-443-00	EB01-160 23-443 EB01-165	27-453-1	
K23-446	L	15K	12-1/4" x 5"	K23-446-00	23-446	27-454-1	4741-L
K23-447	R			K23-447-00	23-447	27-455-1	4741-R

BRAKES AND BRAKE COMPONENTS

MAGNET KITS



PART #	CAP	DESCRIPTION	DEXTER	REDNECK	NUERA	QUALITY
K71-104	3.5K	10" Brake Magnet Kit Green Wire	K71-104-00	BP01-115	27-420	BM10E
K71-105	6K	12" Brake Magnet Kit White Wire	K71-105-00	BP01-185	27-421	BM12E
K71-125	7K	12" Brake Magnet Kit Black Wire	K71-125-00	BP01-225	27-425	
K71-375	8K	12-1/4" Brake Magnet Kit White Wire	K71-375-00		27-423-1	
K71-376	9-10K	12-1/4" Brake Magnet Kit Yellow Wire	K71-376-00	BP01-301	27-424-1	

BRAKE SHOE AND LINING KITS

PART #	CAP	SIZE	DEXTER	REDNECK	NUERA
K71-047	3.5K	10" x 2-1/4"	K71-047-00	K71-047-00 BP04-095	27-400
K71-048	5.2K	12" x 2"	K71-048-00	K71-048-00 BP04-165	27-401
K71-127	7K	12" x 2"	K71-127-00	K71-127-00	27-416



HYDRAULIC BRAKE ASSEMBLIES

PART #	L/R	CAP	SIZE	DEXTER	REDNECK	NUERA	QUALITY
K23-312	L	3.5K	10" x 2-1/4"	K23-312-00	23-312	27-460-2	4710-L
K23-313	R		Single Servo	K23-313-00	23-313	27-461-2	4710-R
K23-344	L	3.5K	10" x 2-1/4"	K23-344-00	23-344	27-460-1	40716
K23-345	R		Free Backing	K23-345-00	23-345	27-461-1	40715
K23-338	L	7K	12" x 2"	K23-338-00	23-338	27-462-3	4711-L
K23-339	R		Single Servo	K23-339-00	23-339	27-463-3	4711-R
K23-402	L	8K	12-1/4" x 3-3/8"	K23-402-00	23-402 HB01-130	27-466-F	
K23-403	R		Duo Servo	K23-403-00	23-403 HB01-135	27-467-F	



SUSPENSION

SINGLES



Single with Double Eye Spring



Single with Slipper Spring

TANDEM

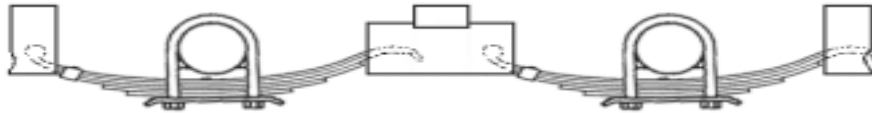

Tandem with Slipper Springs

Tandem Axles come with both Double Eye Springs and Slipper Springs
Above is a Slipper application

TRIPLES

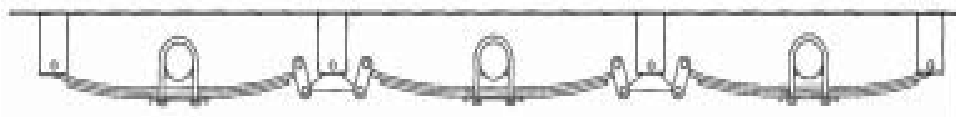

Triple with Double Eye Spring

Triple Axles come with both Double Eye Springs and Slipper Springs
Above is a Double Eye application

OEM AND REPLACEMENT PARTS

All components meet or exceed OEM specifications

SUSPENSION

DOUBLE EYE LEAF SPRINGS



PART #	DESCRIPTION	CAP	WIDTH	LENGTH	LEAFS	DEXTER	REDNECK	NUERA	QUALITY
72-17	Double Eye	1K	1-3/4"	20-1/4"	3	072-017-00	1020		72-17
72-42	Double Eye	1.75K	1-3/4"	25-1/4"	4	072-042-00	PR4B	27-202-1	72-42
72-210	Double Eye	2.1K	1-3/4"	27"	4	PR427	PR427		
72-27-1	Double Eye	2.25K	1-3/4"	26"	6		PR626		
72-25	Double Eye	2.4K	1-3/4"	25-1/4"	4	072-025-00	PR4	27-202	72-25
72-26	Double Eye	3K	1-3/4"	25-1/4"	5	072-026-00	PR5		72-26
72-27	Double Eye	3.5K	1-3/4"	24-7/8"	6	072-027-00	PR6	27-203	72-27

SLIPPER LEAF SPRINGS



PART #	DESCRIPTION	CAP	WIDTH	LENGTH	LEAFS	DEXTER	REDNECK	NUERA	QUALITY
72-30	Slipper Spring	2K	2"	26-1/8"	4	072-030-00	803T3	27-210	72-30
72-31	Slipper Spring	2.5K	2"	26-1/8"	4	072-031-00	1003T3		72-31
72-32	Slipper Spring	3.5K	2"	26-1/8"	5	072-032-00	1203T3	27-211	72-32

BUSHINGS



PART #	DESCRIPTION	I.D.	O.D.	LENGTH	DEXTER	REDNECK	QUALITY
722-106	Nylon Bushing for Leaf Spring / Equalizer	9/16"	11/16"	1-3/4"		722106	4370
722-107	Nylon Bushing for Leaf Spring / Equalizer	9/16"	11/16"	2"		722107	4375
K05-020	Nylon Bushing Kit Includes: (8) 722-106	9/16"	11/16"	1-3/4"		SP05-020	
K05-040	Nylon Bushing Kit Includes: (8) 722-107	9/16"	11/16"	2"		SP05-040	
14-77	Bronze Bushing for Leaf Spring / Equalizer	9/16"	11/16"	1-3/4"	014-077-00		
K71-291	Bronze Bushing Kit Includes: (4) 14-77	9/16"	11/16"	1-3/4"	K71-291-00		

SU PENSION EQUALIZERS



PART #	DESCR PTION	LENGTH	HEIGHT	HOLES	DEXTER	REDNECK	NUERA	QUALITY
13-4	2" Slipper	12"	3-1/2"	7/8" 9/16"	013-004-00	E4541	27-017-1	13-4
13-10	1-3/4" Double Eye	6"	4"	9/16"	013-010-04	13-10		EQ-310
13-44-	2" Slipper	13-1/8"	3-1/2"	3/8", 7/8" 9/16"	013-044-01	13-44	27-018	EB-90
13-104-2	1-3/4" Double Eye	5-3/4"	2"	9/16"	013-104-02	13-104-02	27 010-2	
13-105-2	1-3/4" Double Eye	6-3/4"	2"	9/16"	013-105-02		27-010-1	
13-122	1-3/4" Double Eye	7-3/4"	2-7/8"	9/16"	013-122-04	A2252CB		4101-1

DOUBLE EYE SPRING HANGERS



TOP TO HOLE						
PART #	DESCR PTION	CENTER	DEXTER	REDNECK	NUERA	QUALITY
30-20	Double Eye Rear	29/32"	030-020- 0	30-20	27-002	
28-6	Double Ey Front	1-7/16"	028-006-00		27-001-1	4105-1
29-8	Double Ey Front	2-1/16"	029-008-00		27-001	
28-9	Double Ey Front	2-1/4"	028-009-00			
28-5	Double Ey Front Cen er & R ar	3-1/4"	028-005-00	28-5	27-009	101-4
29-31	Double Eye Cent r	3-5/8"	029-031-00	29-31		
28-49	Double Ey Front Cen er & R ar	4-1/4"	028-049-00	E4139		101-4L
28-10-1	Double Ey Front Cen er & R ar	5"	028-010-01			

SLIPPER SPRING HANGERS



TOP TO HOLE					
PART #	DESCR PTION	CENTER	DEXTER	REDNECK	NUERA
29-1	Slipper Center	3-1/2"	029-001-00	29-1	27-013
30-28	Slippe Rea	5-1/4"	030-028- 0	30-28	27-014
28-1	Slipper F ont	4-1/4"	028-001-00	28-1	27-012
S-HR27F	Slipper Center	3-3/8"	029-005-01	721586-3	27-029
S-HR26W	Slippe Rea	5-1/16"	030-006- 1	721585-3	27-031
S-HR2 F	Slipper F ont	3-9/16"	028-009-01	721584-3	27-028

SUSPENSION

DOUBLE EYE HANGER KITS



PART #	DESCRIPTION	CONSISTS OF	DEXTER	REDNECK
HGR104	Double Eye Single	(2) 28-5 (2) 30-20	HGR-104-00	
HGR105	Double Eye Single	(2) 28-6 (2) 30-20	HGR-105-00	
HGR212	Double Eye Tandem	(6) 28-5	HGR-212-00	
HGR248	Double Eye Tandem	(4) 28-5 (4) 29-31	HGR-248-00	H248
HGR249	Double Eye Tandem	(2) 28-5 (4) 29-8	HGR-249-00	
HGR252	Double Eye Tandem	(6) 28-49	HGR-252-00	
HGR274	Double Eye Tandem	(6) 28-10-1	HGR-274-00	
HGR348	Double Eye Tandem	(4) 28-5 (4) 29-31	HGR-348-00	
HGR312	Double Eye Triple	(8) 28-5	HGR-312-00	
APS1	Single Axle Hanger Kit for Double Eye Springs	(2) 30-20 (6) 6-7 (6) 7-3 (4) 18-12		APS1
APT3	Tandem Axle Hanger Kit for Double Eye Springs (3.5K)	(2) 28-5 (4) 28-6 (2) 13-122 (14) 6-7 (14) 7-3 (8) 18-13		APT3
APT5	Tandem Axle Hanger Kit for Double Eye Springs (5.2K)	(4) 28-9 (2) 13-122 (14) 6-7 (14) 7-3 (8) 18-13		APT5

SLIPPER HANGER KITS



PART #	DESCRIPTION	CONSISTS OF	DEXTER	REDNECK
HGR110	Slipper Single	(2) 28-1 (2) 30-28	HGR-110-00	
HGR202	Slipper Tandem	(2) 28-1 (2) 29-1 (2) 30-28	HGR-202-00	H202
HGR302	Slipper Triple	(2) 28-1 (4) 29-1 (2) 30-28	HGR-302-00	H302
APT288	Tandem Axle Hanger Kit for 2" Slipper Springs	(2) PS-HR25F (2) PS-HR26W (2) PS-HR27F (2) 13-4 (8) 6-7 (8) 7-17 (2) 6-111 (2) 7-1-1		APT6SE-GS3

SUSPENSION

U-BOLTS



PART #	DESCRIPTION	THREAD	I.D.	LENGTH	DEXTER	REDNECK	NUERA
11-54	U-Bolt - 1-3/4" Axle	3/8" - 24	1-3/4"	4-3/8"	011-054-00	175643LN	27-230
11-21	U-Bolt - 2-3/8" Axle	1/2" - 20	2-3/8"	5-1/2"	011-021-00	176400LN	
11-17	U-Bolt - 3" Axle	1/2" - 20	3"	7"	011-017-00	1755892LN	27-232
176500LN	U-Bolt - 3" Axle	9/16" - 18	3"	7"			

U-BOLTS WITH NUTS



PART #	DESCRIPTION	CONSISTS OF	DEXTER	REDNECK
11-17N	U-Bolt with Nuts	(2) 6-169 Nut (1) 11-17 U-Bolt		1755892
11-21N	U-Bolt with Nuts	(2) 6-169 Nut (1) 11-21 U-Bolt		176400
11-54N	U-Bolt with Nuts	(2) 6-130 Nut (1) 11-54 U-Bolt		175643
176500	U-Bolt with Nuts	(2) 916 Washer (2) SH1081 Hi-Nut (1) 176500LN U-Bolt		176500
K71-294	U-Bolt with Nuts	(4) 6-169 Nut (2) 11-17 U-Bolt	K71-294-00	SP01-060
K71-391	U-Bolt with Nuts	(4) 6-130 Nut (2) 11-54 U-Bolt	K71-391-00	SP01-020
SP01-040	U-Bolt with Nuts	(4) 6-169 Nut (2) 11-21 U-Bolt		SP01-040
SP01-080	U-Bolt with Nuts	(4) 916 Washer (4) SH1081 Hi-Nut (2) 176500LN U-Bolt		SP01-080

SUSPENSION

U-BOLT KITS WITH TIE PLATES



PART #	DESCRIPTION	CONSISTS OF	REDNECK	NUERA	QUALITY
APUBR-10	Kit for 1-3/4" Axle	(8) 6-130 (4) 11-54 (2) 12-40	APUBR-10	27-230-K11	4205
APUBR-1	Kit for 2-3/8" Axle	(8) 6-169 (4) 11-21 (2) 12-3	APUBR-1	27-231-K11	4202
APUBR-8	Kit for 3" Axle	(8) 6-169 (4) 11-17 (2) 12-1	APUBR-8	27-232-K11	
APUBR-3	Kit for 3" Axle	(8) 916 (2) 12-2 (4) 176500 (8) SH1081	APUBR-9		

TIE PLATES



PART #	DESCRIPTION	NOTES	DEXTER	REDNECK	NUERA	QUALITY
12-40	Tie Plate - 1-3/4" Axle	1-3/4" Spring Width 3/8" U-Bolt	012-040-00	117535	27-220	4205-3
12-3	Tie Plate - 2-3/8" Axle	1-3/4" Spring Width 1/2" U-Bolt	012-003-00	117595		4202-3
12-1	Tie Plate - 3" Axle	1-3/4" Spring Width 1/2" or 9/16" U-Bolt	012-001-00	117521	27-223	
12-2	Tie Plate - 3" Axle	1-3/4" or 2" Spring Width 1/2" or 9/16" U-Bolt			27-224	4201-3

FLANGE NUTS



PART #	DESCRIPTION	THREAD	DEXTER	REDNECK	QUALITY
6-130	For use on 11-54	3/8" - 24	006-130-00	38N	
6-169	For use on 11-17 & 11-21	1/2" - 20	006-169-00	12N	4201-2FL

SUSPENSION



SHACKLE LINKS

PART #	DESCRIPTION	OVERALL	HOLE TO	HOLE	DEXTER	REDNECK	NUERA	QUALITY
		LENGTH	HOLE	I.D.				
18-11	Shackle Link	3-1/2"	2-1/4"	9/16"	018-011-00	18-11	27-006	4101-2A
18-12	Shackle Link	4-3/8"	3-1/8"	9/16"	018-012-00	115208	27-005	4101-2
18-13	Shackle Link	4-1/8"	2-5/8"	9/16"	018-013-00	115052		

SHACKLE LINK KITS

PART #	DESCRIPTION	CONSISTS OF	DEXTER	REDNECK	NUERA	QUALITY
K71-287	Shackle Kit	(4) 18-13 Link		SP03-040	55-27235	
K71-288	Shackle Kit	(4) 18-11 Link	K71-288-00	SP03-020	27-710 55-27230	
K71-289	Shackle Kit	(4) 18-12 Link	K71-289-00	SP03-060	27-711 55-27225	

SHACKLE LINK ASSEMBLIES

PART #	DESCRIPTION	CONSISTS OF	DEXTER
18-20	Shackle Assembly Step Down Bolt	(2) 7-126 Bolt (1) 18-11 Link	018-020-00
18-20A	Shackle Assembly Straight Bolt	(2) 7-3 Bolt (1) 18-11 Link	
18-21	Shackle Assembly Step Down Bolt	(2) 7-126 Bolt (1) 18-12 Link	018-021-00
18-21A	Shackle Assembly Straight Bolt	(2) 7-3 Bolt (1) 18-12 Link	
18-22	Shackle Assembly Step Down Bolt	(2) 7-126 Bolt (1) 18-13 Link	
18-22A	Shackle Assembly Straight Bolt	(2) 7-3 Bolt (1) 18-13 Link	

SUSPENSION



SUSPENSION BOLTS

PART #	DESCRIPTION	THREAD	LENGTH	DEXTER	REDNECK	NUERA	QUALITY
7-7	Keeper Bolt Slipper Equalizer	5/16" - 18	3-1/4"	007-007-00	7-7	27-022	516314
7-3	Shackle Bolt Standard	9/16" - 18	3"	007-003-00	9163B	27-003	4101-5
7-17	Shackle Bolt Standard	9/16" - 18	3-1/2"	007-017-00	91635B	27-015	4113-7
7-126	Shackle Bolt Step Down	7/16" - 20	2-7/8"	007-126-00	7-126		
7-1-1	Equalizer Bolt with Zerk	7/8" - 9	4-5/8"	007-001-01	7-1-1	27-019	4113-5W

SUSPENSION NUTS

PART #	DESCRIPTION	THREAD	DEXTER	REDNECK	NUERA	QUALITY
6-11	Lock Nut for Keeper Bolt	5/16" - 18 Top Lock	006-011-00	6-11	27-023	516LN
6-92	Lock Nut for Step Down Bolt	7/16" - 20 Flanged	006-092-00	6-92		
6-7	Lock Nut for Shackle Bolt	9/16" - 18 Top Lock	006-007-00	916DLN	27-004	4101-6
6-111	Lock Nut for Equalizer Bolt	7/8" - 9 Top Lock	006-111-00	6-111	27-020	78LN

SUSPENSION BOLT AND NUT KITS

PART #	DESCRIPTION	CONSISTS OF	DEXTER	REDNECK	NUERA
K71-290	Bolt & Nut Kit Step Down Bolt	(2) 6-92 Nut (2) 7-126 Bolt	K71-290-00		27-712
7-3N	Bolt & Nut Kit Standard	(1) 6-7 Nut (1) 7-3 Bolt		166081	
SP04-020	Bolt & Nut Kit Standard	(4) 6-7 Nut (4) 7-3 Bolt		SP04-020	
7-17N	Bolt & Nut Kit Standard	(1) 6-7 Nut (1) 7-17 Bolt		166079	
SP04-040	Bolt & Nut Kit Standard	(4) 6-7 Nut (4) 7-17 Bolt		SP04-040	
7-1-1N	Equalizer Bolt & Nut with Zerk	(1) 6-111 Nut (1) 7-1-1 Bolt		166074	
SP04-060	Equalizer Bolt & Nut with Zerk & Cotter Pin	(2) 6-111 Nut (2) 7-1-1 Bolt (2) 19-2 Pin		SP04-060	

SUSPENSION

EQUALIZER KITS

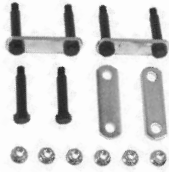

PART #	DESCRIPTION	CONSISTS OF	DEXTER	REDNECK
AP122	Single Double Eye	(6) 6-92 Nut (2) 7-126 Bolt (2) 18-12 Link (2) 18-21 Assembly	K71-403-00 A/P-122	
AP115	Single Slipper	(2) 6-92 Nut (2) 7-126 Bolt	A/P-115	
AP103	Single Slipper	(2) 6-7 Nut (2) 6-11 Nut (2) 7-7 Bolt (2) 7-17 Bolt	A/P-103	
AP247	Tandem Double Eye 4" High Equalizer	(14) 6-92 Nut (6) 7-126 Bolt (2) 13-10 Equalizer (4) 18-11 Link (4) 18-20 Assembly	A/P-247	
AP233	Tandem Double Eye 33" Spacing	(14) 6-92 Nut (6) 7-126 Bolt (2) 13-104-2 Equalizer (4) 18-11 Link (4) 18-20 Assembly	K71-401-00 A/P-233	AP233
AP264	Tandem Double Eye 35" Spacing	(14) 6-92 Nut (6) 7-126 Bolt (2) 13-122 Equalizer (4) 18-11 Link (4) 18-20 Assembly	A/P-264	
AP202	Tandem Slipper 33-1/2" Spacing	(4) 6-7 Nut (4) 6-11 Nut (2) 6-111 Nut (2) 13-4 Equalizer (2) 7-1-1 Bolt (4) 7-7 Bolt (4) 7-17 Bolt	K71-365-00 A/P-202	AP202
AP216	Tandem Slipper 36" Spacing	(4) 6-7 Nut (4) 6-11 Nut (2) 6-111 Nut (2) 13-4-1 Equalizer (2) 7-1-1 Bolt (4) 7-7 Bolt (4) 7-17 Bolt	K71-366-00 A/P-216	AP216

SUSPENSION

EQUALIZER KITS



PART #	DESCRIPTION	CONSISTS OF	DEXTER	REDNECK
AP335	Triple Double Eye 33" Spacing	(22) 6-92 Nut (10) 7-126 Bolt (2) 13-104-2 Equalizer (2) 13-105-2 Equalizer (6) 18-11 Link (6) 18-20 Assembly	K71-402-00 A/P-335	
AP364	Triple Double Eye 35" Spacing	(22) 6-92 Nut (10) 7-126 Bolt (2) 13-105-2 Equalizer (2) 13-122 Equalizer (6) 18-11 Link (6) 18-20 Assembly	A/P-364	
AP302	Triple Slipper 33-1/2" Spacing	(6) 6-7 Nut (6) 6-11 Nut (4) 6-111 Nut (4) 7-1-1 Bolt (6) 7-7 Bolt (6) 7-17 Bolt (4) 13-4 Equalizer	A/P-302	AP302
AP316	Triple Slipper 36" Spacing	(6) 6-7 Nut (6) 6-11 Nut (4) 6-111 Nut (4) 7-1-1 Bolt (6) 7-7 Bolt (6) 7-17 Bolt (4) 13-44-1 Equalizer	A/P-316	AP316

JACKS AND COUPLERS

ELECTRIC A-FRAME JACK

(BLACK POWDER COAT)



PART #	CAP	LIFT	DROP LEG	REDNECK	NUERA	QUALITY	BUYERS
JE-3520-BBX	3.5K	18"	7.5"	EJ-3520-BBX 80718	18-279-I	EJ-3520-BBX	0093500

A-FRAME JACKS

(BLACK POWDER COAT)



PART #	CAP	WIND	LIFT	BRK HGT	RET HGT	REDNECK	NUERA	QUALITY	BUYERS
JA-2000-B	2K	Top	14"	8"	20"	155022	18-307-B	JAT02-14NP	0091261
JA-5000-B	5K	Top	14"	10.5"	20"	175020	18-309	JAT05-14NP	0091266

WELD-ON AND BOLT-ON JACKS

(BLACK POWDER COAT)



PART #	CAP	WIND	LIFT	BRK HGT	RET HGT	REDNECK	NUERA	QUALITY	BUYERS
JB-2001-B	2K	Top	10"	11.25"	15.25"	151401	18-440-B	JWT02-10XP	0091210
JB-2001S-B	2K	Side	10"	11.25"	17.5"	151101		TJB-20015-B	
JB-2002-B	2K	Top	15"	15"	20.25"	151421		JWF02-15XP	0091225

TUBE - PIPE MOUNT JACKS

(BLACK POWDER COAT)



PART #	CAP	WIND	LIFT	BRK HGT	RET HGT	REDNECK	NUERA	QUALITY	BUYERS
JP-2001-B	2K	Top	10"	11.25"	15.25"	158451	18-440-5I	JPT02-10XP	0091205
JP-2001S-B	2K	Side	10"	11.25"	17.5"	158109	18-440-8I	JPS02-10XP	
JP-2002-B	2K	Top	15"	15"	20.25"	158452	18-440-3I	JPT02-15XP	0091215
JP-2002S-B	2K	Side	15"	16.25"	23.25"	158151	18-440-2I	JPS02-15XP	
JP-5001-B	5K	Top	10"	11.25"	15.25"	178101	18-450-2I	JPT05-10XP	
JP-5001S-B	5K	Side	10"	11.25"	17.5"	178201	18-450-I	JPS05-10XP	0091220
JP-5002-B	5K	Top	15"	15"	20.25"	178151		JPT05-15XP	
JP-5002S-B	5K	Side	15"	16.25"	23.25"	178203		JPS05-15XP	

JACKS AND COUPLERS

DIRECT WELD JACKS

(BLACK POWDER COAT)



PART #	CAP	WIND	LIFT	BRK HGT	RET HGT	REDNECK	NUERA	QUALITY	BUYERS
JD-7000	7K	Top	15"	N/A	23.5"	190500 TJD7000	19-907-I		0091310
JD-7000-S	7K	Side	15"	N/A	25.5"	190510 TJD7000S	19-906-I	TJDP-7000S	0091340

DROP LEG JACKS

(DROP LEG 4" - SPRING LOADED)



PART #	CAP	WIND	LIFT	BRK HGT	RET HGT	REDNECK	NUERA	QUALITY	BUYERS
JD-12K-FNH No Handle Front Spring	12K	Side	12.5"	25.5"	28.5"	182817	19-570	JDS10-26FNH	0091415
JD-12K-RNH No Handle Side Spring	12K	Side	12.5"	25.5"	28.5"	182800	19-570-SP	JDS10-26SP2	0091410

MARINE JACKS

(BOLT-ON ZINC CASTER)



PART #	CAP	WIND	LIFT	BRK HGT	RET HGT	REDNECK	NUERA	QUALITY	BUYERS
JM-1001-B 6" Caster	1K	Side	10"	12.7"	23.25"	EJ1000 XP10	18-299-15	JBS01-10C2	0091610
JM-1500-B 8" Caster	1.5K	Side	10"	12.7"	25.25"	MJ1500B 5874A8	18-299-I	MJ-1500B	

JACK ACCESSORIES



PART #	NOTES	DESCRIPTION	REDNECK	NUERA	BUYERS
JF-99	2" Tube	Foot Plate with Hardware	140070		
JF-100-Z	2" Tube	Foot Plate with Hardware - 1.7" Tall	82650	18-309-S	
JF-101	2" Tube	Foot Plate with Hardware - 8.5" Tall	82660	18-309-L	
JD-7000-HD	N/A	7K Topwind Handle	TJD-7000-HD		
JD-12K-HD	N/A	12K Jack Handle with Bolt & Nut	LG-0083-01		0091405H

JACKS AND COUPLERS

A-FRAME COUPLERS



PART #	CAP	BALL SIZE	FINISH	REDNECK	NUERA	QUALITY
CA-2000-B	5K	2"	Steel Black Powder	5172 80071	18-100	80072
CA-2000-BC	7K	2"	Cast Black Powder	3B8	1-409	3B8L
CA-2516-B	10K	2-5/16"	Steel Black Powder	81911	18-101	81911
CA-2516-BC	12.5K	2-5/16"	Cast Black Powder	4B8 4B8L	18-410	4B8L
CA-2516-B14	14K	2-5/16"	Steel Black Powder	5113		81912

ADJUSTABLE COUPLERS



PART #	CAP	BALL SIZE	FINISH	REDNECK	NUERA	QUALITY
CADJ-2000C	7K	2"	Cast Black Powder	3B6M	21-302-4	
CADJ-2516C	12K	2-5/16"	Cast Black Powder	4B6M	21-302-3	
CADJ-2516S	14K	2-5/16"	Steel Black Powder	2425160	21-302-1	18820
CADJ-2516CHD	15K	2-5/16"	Cast Black Powder		21-302-6	

FRAME COUPLERS



PART #	CAP	BALL SIZE	FINISH / CHANNEL SIZE	REDNECK	NUERA	QUALITY
CT-17820-Z	2K	1-7/8"	Zinc 2" Channel	CP01-010	18-520-1	5143
CT-17825-Z	2K	1-7/8"	Zinc 2.5" Channel	CP01-020	18-525-1	5141
CT-17830-Z	2K	1-7/8"	Zinc 3" Channel	CP01-030	18-530-1	5144
CT-20020-Z	3.5K	2"	Zinc 2" Channel	CP01-040	18-610-1	5145
CT-20025-Z	3.5K	2"	Zinc 2.5" Channel	CP01-050	18-600-1	5142
CT-20030-Z	3.5K	2"	Zinc 3" Channel	CP01-060	18-630-1	5146

TOWING ACCESSORIES

PINTLE HOOKS



PART #	DESCRIPTION	BALL PINTLE		REDNECK	BUYERS
		CAP	CAP		
PH-1780	Pintle Hook with 1-7/8" Ball	6K	16K		BH81780
PH-2000	Pintle Hook with 2" Ball	10K	16K	DPH2000	BH82000
PH-2516	Pintle Hook with 2-5/16" Ball	12K	16K	DPH2516	BH82516
PH-3000	Pintle Hook Rigid Type	8K	30K	R15T	PH15
PH-6000	Pintle Hook Rigid Type	10K	60K		PH30

DRAW BARS



PART #	DESCRIPTION	GTW	REDNECK	WALLACE FORGE	
				NUERA	FORGE
DB-2120	Forged 2-1/2" Eye - 4 Bolt Mount	35K	1250-15	17-111	R49A
DB-3000	Forged 3" Eye - 4 Bolt Mount	60K	1385	17-111-1	R51A
DBA-3000	Forged 3" Eye - Adjustable Forged Lunettei	12K	16137	21-301	
DBF-3000	Forged 3" Eye - Flat	22K	1238		052D
DBN-2120	Forged 2-1/2" Eye Single Bolt With Nut	15K	1250-3	17-110	050A
DBN-3000	Forged 3" Eye Single Bolt With Nut	45K	1249-2H	17-112	051B
DBA-3001	Forged 3" Eye - Adjustable Forged Lunettei	24K			

PINTLE MOUNTS AND ADJUSTABLE BRACKETS



PART #	DESCRIPTION	GTW	SHANK		REDNECK	NUERA	BUYERS
			LENGTH				
PHM-4	Pintle Mount - 4 Hole Draw Bar Mount	20K	8-1/2"			28-110-1	PM-84
PHM-8	Pintle Mount - 8 Hole Draw Bar Mount	10K	10-1/2"		PM6990S	28-110	PM-87
DBA-3	Bracket - 3 Position Adjustable Mount	10K	8-1/2"		8978	21-304	B8978
DBA-5	Bracket - 5 Position Adjustable Mount	10K	10-1/2"			21-430	B8979

TOWING ACCESSORIES

TRAILER HITCH BALLS



PART #	DESCRIPTION	SHANK		CAPACITY	REDNECK	NUERA	BUYERS
		DIA.	LENGTH				
HB-1780-34	1-7/8" Chrome Hitch Ball	3/4"	1-5/8"	2K	17834CLS		1802015
HB-1780-10	1-7/8" Chrome Hitch Ball	1"	2-1/8"	3.5K	1781CLS	15-101	1802020
HB-2000-34	2" Chrome Hitch Ball	3/4"	1-3/4"	3.5K	234CLS	15-1802010	1802010
HB-2000-10	2" Chrome Hitch Ball	1"	2-1/8"	6K	21CLS	15-202	1802005
HB-2516-10	2-5/16" Chrome Hitch Ball	1"	2-1/8"	7.5K	2516CLS	15-304	1802027

TRAILER HITCH BALL MOUNTS



PART #	DESCRIPTION	HOLE		GTW/TW	REDNECK	NUERA	BUYERS
		SIZE	RISE				
BM-20	2" Drop Ball Mount 2" Receiver Gloss Black	1"	3/4"	7,500/750lbs	BM01-285	28-106	1803007
BM-40	4" Drop Ball Mount 2" Receiver Gloss Black	1"	2"	7,500/750lbs	BM01-485	28-107	1803013
BM-60	6" Drop Ball Mount 2" Receiver Gloss Black	1"	4"	7,500/750lbs	BM01-595		1803015

TRAILER HITCH BALL MOUNTS WITH BALLS AND PIN



PART #	DESCRIPTION	BALL		GTW/TW	REDNECK	BUYERS
		SIZE	LENGTH			
BM-2-1780	2" Drop Ball Mount 2" Receiver w/Balls & Pin	1-7/8"	8-1/4"	3,500/350lbs	45034	1803304
BM-2-2000	2" Drop Ball Mount 2" Receiver w/Balls & Pin	2"	8-1/4"	7,500/750lbs	45036	1803307
BM-2-2516	2" Drop Ball Mount 2" Receiver w/Balls & Pin	2-5/16"	8-1/4"	7,500/750lbs	45041	1803308
BM-4-1780	4" Drop Ball Mount 2" Receiver w/Balls & Pin	1-7/8"	8-1/4"	3,500/350lbs		1803312
BM-4-2000	4" Drop Ball Mount 2" Receiver w/Balls & Pin	2"	8-1/4"	7,500/750lbs	45056	1803313
BM-4-2516	4" Drop Ball Mount 2" Receiver w/Balls & Pin	2-5/16"	8-1/4"	7,500/750lbs	45042	1803314

TOWING ACCESSORIES

RECEIVER TUBES



PART #	DESCRIPTION	FINISH	REDNECK	NUERA	BUYERS
RT-226	2" x 2" x 6" Receiver Tube	Raw	RB06UP	28-100-2	RT25806
RT-229	2" x 2" x 9" Receiver Tube	Raw			
RT-2212	2" x 2" x 12" Receiver Tube	Raw	RB12	28-100-1	RT25812



RECEIVER HITCH PINS



PART #	DESCRIPTION	FINISH	REDNECK	NUERA	BUYERS
HP-12	1/2" x 3" Hitch Pin & Clip	Zinc	RHPP2	28-108-1C	HP545WC
HP-58	5/8" x 3" Hitch Pin & Clip	Zinc	RHPP1	28-108-C	HP653WC

BRAKE ACTUATION

BRAKE CONTROLLERS

PART #	DESCRIPTION
<p>51130</p>  <p>REFLEX BRAKE CONTROLLER ADVANCED DUAL-AXIS ACCELEROMETER</p>	<p>REFLEX</p> <ul style="list-style-type: none"> • Uses an advanced accelerometer mechanism to sense when the vehicle slows down and responds with the right amount of trailer brake pressure to provide a smooth, seamless stop • Self leveling – no setup required • Digital display provides brake force details and other diagnostic information • Simple push-button calibration • Mounts in a variety of angles above or below your dash • Adjustable power output • Manual control activates brake lights • Compatible with anti-lock brakes and cruise control • Operates 2-8 brakes (1-4 axles) • Mounting bracket, hardware and instructions included • Limited lifetime warranty
<p>51120</p>  <p>DISCOVERY BRAKE CONTROLLER TIMED ELECTRIC DIGITAL DISPLAY</p>	<p>DISCOVERY</p> <ul style="list-style-type: none"> • Digital display provides detailed brake force information and diagnostics • Mount anywhere in your vehicle. Dependable solid state electronics require no leveling • Electronic activation ensures smooth stops • No internal moving parts • Fully adjustable power and ramp time • Manual control activates brake lights • Compatible with anti-lock brakes and cruise control • Operates 2-8 brakes (1-4 axles) • Mounting bracket, hardware and instructions included • Limited lifetime warranty
<p>51110</p>  <p>VENTURER BRAKE CONTROLLER TIMED ELECTRIC LED DISPLAY</p>	<p>VENTURER</p> <ul style="list-style-type: none"> • LED indicator lengthens as controller applies force to the trailer brakes • Mount anywhere in your vehicle. Dependable solid state electronics require no leveling • No internal moving parts • Adjustable power and ramp time • Manual control activates brake lights • Compatible with anti-lock brakes and cruise control • Operates 2-6 brakes (1-3 axles) • Mounting bracket, hardware and instructions included • Limited lifetime warranty

BRAKE ACTUATION BRAKE CONTROL HARNESSSES

FORD	NOTES	YEARS	PART #	CHEVROLET	NOTES	YEARS	PART #
Bronco		94-96	BCH-51323	Avalanche		03-06	BCH-51353
Econoline Van		92-09	BCH-51323			02	BCH-51353
Excursion		00-05	BCH-51323			07	BCH-51353
Expedition		97-08	BCH-51323	Silverado	Classic Body Only	03-06	BCH-51353
F-150		97-08	BCH-51323			99-02	BCH-51343
F-150 & F-250	Light Duty Heritage	97-03 04	BCH-51323 BCH-51323	Suburban	Amber Turn Signals	03-06 01-02	BCH-51353 BCH-51343
F-250 & F-350	Super Duty	08-10 05-07 99-04	BCH-51433 BCH-51373 BCH-51323	Tahoe	Amber Turn Signals	03-06 00-02	BCH-51353 BCH-51343
F-250 & F-350	Heavy Duty	97	BCH-51323	GMC			
F-450 & F-550	Super Duty	08-10 05-07	BCH-51433 BCH-51373	Sierra	Classic Body Only	07 03-06 99-02	BCH-51353 BCH-51353 BCH-51343
Windstar		95-03	BCH-51323	Yukon	Amber Turn Signals	03-06 00-02	BCH-51353 BCH-51343
DODGE				NOTES			
Dakota		97-08	BCH-51333	Yukon Denali	Amber Turn Signals	03-06 01-02	BCH-51353 BCH-51343
Durango		98-09	BCH-51333				
RAM Pickup		95-09	BCH-51333	Yukon XL		03-06 00-02	BCH-51353 BCH-51343
TOYOTA				NOTES			
4Runner		03-08	BCH-51363	Yukon XL Denali		03-06 01-02	BCH-51353 BCH-51343
Sequoia		03-08	BCH-51363				
Tacoma		07-09	BCH-51363	HUMMER			
Tundra		03-09	BCH-51363	H2		03-07	BCH-51353

BREAKAWAY KITS



PART #	DESCRIPTION
42906	Side Load Kit w/LED Display Charger, UB1250 Battery, 2010 Switch Completely Wired Application For 1-3 Axles
42905	Top Load Kit w/LED Display Charger, UB1250 Battery, 2010 Switch Completely Wired Application For 1-3 Axles

REPLACEMENT BREAKAWAY BATTERY



PART #	DESCRIPTION
UB1250	Sealed Lead Acid Battery 12 Volt, 5 Amp/Hour Application For 1-3 Axle Trailers

BREAKAWAY SWITCHES



PART #	DESCRIPTION
2010	Breakaway Switch, Nylon Case Weldable Bracket, Silver Contact Points, Nylon Pull Pin 4' Wires & Cable
2010A	Breakaway Switch Pin Cable Only

ELECTRICAL AND LIGHTING

TRAILER CABLE WIRE

General-purpose primary wires covered in a high quality, PVC jacket. Especially designed for reliability as an integral part of the brake and safety system. Heavy-duty compact cable protects insulated conductors against weathering, chemicals, and abrasion. Color-coded conductors enable easy identification.

Voltage: Rated at 60 Volts or less

Temperature: Rated -67°F to 176°F

Specifications: Inner wires meet SAE J1128



TRAILER CABLE WIRE 4/14 GAUGE



PART #	DESCRIPTION	ROTATION
TC10-4	Trailer Cable Wire for 4/14GA 10'	Black/Red/Brown/White
TC25-4	Trailer Cable Wire for 4/14GA 25'	Black/Red/Brown/White
TC50-4	Trailer Cable Wire for 4/14GA 50'	Black/Red/Brown/White
TC100-4	Trailer Cable Wire for 4/14GA 100'	Black/Red/Brown/White
TC500-4	Trailer Cable Wire for 4/14GA 500'	Black/Red/Brown/White
14871	Trailer Cable Wire for 4/14GA 2500'	Black/Red/Brown/White

TRAILER CABLE WIRE 6/14 GAUGE



PART #	DESCRIPTION	ROTATION
TC10-6	Trailer Cable Wire for 6/14GA 10'	Red/Green/Brown/White/Black/Yellow
TC25-6	Trailer Cable Wire for 6/14GA 25'	Red/Green/Brown/White/Black/Yellow
TC50-6	Trailer Cable Wire for 6/14GA 50'	Red/Green/Brown/White/Black/Yellow
TC100-6	Trailer Cable Wire for 6/14GA 100'	Red/Green/Brown/White/Black/Yellow
TC500-6	Trailer Cable Wire for 6/14GA 500'	Red/Green/Brown/White/Black/Yellow
14872	Trailer Cable Wire for 6/14GA 2000'	Red/Green/Brown/White/Black/Yellow

TRAILER CABLE WIRE 6/12-1/10 GAUGE



PART #	DESCRIPTION	ROTATION
TC10-7	Trailer Cable Wire for 6/12-1/10GA 10'	White/Black/Yellow/Red/Green/Brown/Blue
TC25-7	Trailer Cable Wire for 6/12-1/10GA 25'	White/Black/Yellow/Red/Green/Brown/Blue
TC50-7	Trailer Cable Wire for 6/12-1/10GA 50'	White/Black/Yellow/Red/Green/Brown/Blue
TC100-7	Trailer Cable Wire for 6/12-1/10GA 100'	White/Black/Yellow/Red/Green/Brown/Blue
TC250-7	Trailer Cable Wire for 6/12-1/10GA 250'	White/Black/Yellow/Red/Green/Brown/Blue
TC500-7	Trailer Cable Wire for 6/12-1/10GA 500'	White/Black/Yellow/Red/Green/Brown/Blue
TC1000-7	Trailer Cable Wire for 6/12-1/10GA 1000'	White/Black/Yellow/Red/Green/Brown/Blue

ELECTRICAL AND LIGHTING

4" STT / BACK-UP



PART #	DESCRIPTION	OPTRONICS
SL4GB	4" Black Flush Mount Grommet	A45GB
SL4R7100	4" Red Round Stop, Turn, Tail w/7 Diodes & PL-3 Connection	STL13RB
SL4R7200	4" Clear Round Back-Up LED Light w/7 Diodes & PL-2 Connection	

6" OVAL STT / BACK-UP



PART #	DESCRIPTION	OPTRONICS
SL6GB	6" Black Flush Mount Grommet	A70GB
SL6O6125	6" Red Oval Stop, Turn, Tail w/6 Diodes & PL-3 Connection	STL12RB
SL6O6225	6" Clear Oval Back-Up LED Light w/6 Diodes & PL-2 Connection	BUL12CB

LIGHT PLUGS



PART #	DESCRIPTION	OPTRONICS
SLPL2	2-Pin In-Line Male PL-10 Plug w/Stripped Power Wire & #10 Ring On Ground	
SLPL3R	3-Pin Right Angle Male PL-3 Plug w/Stripped Leads & #10 Ring On Ground	A47PB
SLPL3S	3-Wire, 3-Pin Straight Male PL-3 Plug w/Stripped Leads & #10 Ring On Ground	A45PB

ACCESSORIES

CONSPICUITY TAPE

- * Meets all Federal & State Certifications
- * Microprismatic Technology
- * Thin & Flexible
- * Comprehensive Warranty



PART #	DESCRIPTION
CT11R7W2150	2" x 150' (11" Red, 7" White)
CT6R6W2150	2" x 150' (6" Red, 6" White)
CTR2150	2" x 150' Solid Red
CTW2150	2" x 150' Solid White

D-RINGS

(FORGED D-RINGS WITH WELD-ON MOUNTING BRACKET)



PART #	DESCRIPTION	TYPE	REDNECK	NUERA	BUYERS
DR-12B	1/2" D-Ring 2-1/2" x 2-3/8" 11780 MBS	Bolt-On	DRB12-25	08-411	B38
DR-12W	1/2" D-Ring 2-1/2" x 2-3/8" 11780 MBS	Weld-On			B38W
DR-58W	5/8" D-Ring 3" x 3" 18390 MBS	Weld-On	DR58-3	08-410	B40
DR-34W	3/4" D-Ring 3" x 3" 26500 MBS	Weld-On		08-409	B46
DR-100W	1" D-Ring 3" x 4" 45760 MBS	Weld-On	DR10-3-4	08-412	B50

FLOOR SCREWS



PART #	DESCRIPTION	NUERA
FS14150	1/4" x 1-1/2" Type F, Torx Head	14-115
FS14200	1/4" x 2" Type F, Torx Head	14-100
FS14250	1/4" x 2-1/2" Type F, Torx Head	14-110
FS56200	5/16" x 2"	
FS56250	5/16" x 2-1/2"	

ACCESSORIES

TARP STRAPS



PART #	DESCRIPTION	STD PKG QTY
TS-10	10" Tarp Strap	50
TS-15	15" Tarp Strap	50
TS-21	21" Tarp Strap	50
TS-31	31" Tarp Strap	50
TS-41	41" Tarp Strap	50
TSHOOK	Tarp Strap Hook	10

- * 100% EPDM
- * ASTM D412 for tensile strength & elongation
- * ASTM D2240 standard for durometer
- * ASTM D2137 for low temperature

WHEEL CHOCKS

PART #	DESCRIPTION
WC1000	10" x 8" x 6"
WC1001	10-1/2" x 8-1/2" x 6-3/4"



STEEL UNDERBODY TOOLBOXES



PART #	SIZE	LATCHES	BUYERS	NUERA
TB1824	18"H x 18"D x 24"W	1	1702300	38-001
TB1830	18"H x 18"D x 30"W	1	1702303	
TB1836	18"H x 18"D x 36"W	1	1702305	38-002
TB1848	18"H x 18"D x 48"W	2	1702310	38-003
TB1860	18"H x 18"D x 60"W	2	1702315	

ACCESSORIES

GEOCEL SEALANTS AND ADHESIVES



PART #	DESCRIPTION	COLOR	SIZE	STD PKG QTY	STD CASE QTY**
70200E	Geobond Roof Repair	Clear	Gallon	1	4
70201E	Geobond Roof Repair	White	Gallon	1	4
70202E	Geobond Roof Repair	Aluminum	Gallon	1	4
70800E	Geobond Roof Repair Kit	Clear	Kit	1	6
70801E	Geobond Roof Repair Kit	White	Kit	1	6
70802E	Geobond Roof Repair Kit	Aluminum	Kit	1	6
12004E	1200 Polymesh Fabric	White	4" x 50'	1	4
12006E	1200 Polymesh Fabric	White	6" x 50'	1	3
60700E	Geocel 2010 Brushable Grade Sealant	Clear	Gallon	1	4
60701E	Geocel 2010 Brushable Grade Sealant	White	Gallon	1	4
60702E	Geocel 2010 Brushable Grade Sealant	Aluminum	Gallon	1	4
59102E	8125 RTV Silicone 100%	Aluminum Gray	10.3 oz. cart	1	12
68111E	8125 RTV Silicone 100%	Clear	10.3 oz. cart	1	12
68112E	8125 RTV Silicone 100%	White	10.3 oz. cart	1	12
68113E	8125 RTV Silicone 100%	Black	10.3 oz. cart	1	12
71101E	PUR50 Polyurethane Sealant/Adhesive	White	10.3 oz. cart	1	24
71102E	PUR50 Polyurethane Sealant/Adhesive	Gray	10.3 oz. cart	1	24
63100E	2300 MHRV Vehicle Body Sealant	Clear	10.3 oz. cart	1	24
63101E	2300 MHRV Vehicle Body Sealant	White	10.3 oz. cart	1	24
63102E	2300 MHRV Vehicle Body Sealant	Aluminum Gray	10.3 oz. cart	1	24
63127E	2300 MHRV Vehicle Body Sealant	Bright White	10.3 oz. cart	1	24

** ITEMS CAN BE SOLD AS INDIVIDUAL UNITS OR BY THE STANDARD CASE QUANTITY

INTERCHANGES

BUYERS	OUR #	BEARING BUDDY	OUR #	DEXTER	OUR #
0091205	JP-2001-B	1980	BP-1980	003-064-00	SS-238
0091210	JB-2001-B	2441	BP-2441	003-070-00	SS-300
0091215	JP-2002-B			005-023-00	5-23
0091220	JP-5001S-B			005-027-00	5-27
0091225	JB-2002-B			005-057-00	5-57
0091261	JA-2000-B			005-059-00	5-59
0091266	JA-5000-B			005-060-00	5-60
0091310	JD-7000			005-101-00	5-101
0091340	JD-7000-S			006-001-00	6-61
0091405H	JD-12K-HD			006-007-00	6-7
0091410	JD-12K-RNH			006-011-00	6-11
0091415	JD-12K-FNH			006-053-00	6-53
0091610	JM-1001-B			006-080-00	6-80
0093500	JE-3520-BBX			006-084-00	6-84
1702300	TB1824			006-092-00	6-92
1702303	TB1830			006-098-00	6-98
1702305	TB1836			006-109-00	6-109
1702310	TB1848			006-111-00	6-111
1702315	TB1860			006-130-00	6-130
1802005	HB-2000-10			006-169-00	6-169
1802010	HB-2000-34			006-190-00	6-190
1802015	HB-1780-34			006-191-00	6-191
1802020	HB-1780-10			007-001-01	7-1-1
1802027	HB-2516-10			007-003-00	7-3
1803007	BM-20			007-007-00	7-7
1803013	BM-40			007-017-00	7-17
1803015	BM-60			007-040-00	7-40
1803304	BM-2-1780			007-122-00	7-122
1803307	BM-2-2000			007-126-00	7-126
1803308	BM-2-2516			007-246-00	7-246
1803312	BM-4-1780			007-262-00	7-262
1803313	BM-4-2000			008-091-05	8-91-5
1803314	BM-4-2516			008-201-05	8-201-5
B38	DR-12B			008-201-90	8-201-9
B38W	DR-12W			008-214-05	8-214-5
B40	DR-58W			008-219-04	8-219-4
B46	DR-34W			008-219-13	8-219-13
B50	DR-100W			008-247-05	8-247-5
B8978	DBA-3			008-247-12	8-247-12
B8979	DBA-5			008-248-05	8-248-5
HP545WC	HP-12			008-249-05	8-249-5
HP653WC	HP-58			008-249-07	8-249-7
PM-84	PHM-4			008-250-05	8-250-5
PM-87	PHM-8			008-256-7	84550
RT25806	RT-226			008-257-05	8-257-5
RT25812	RT-2212			008-258-05	8-258-5
				008-259-05	8-259-5
				008-288-05	8-288-5
				009-027-01	9-27-1
				009-028-01	9-28-1
				009-132-01	568699
				010-010-00	10-10
				010-019-00	10-19
				010-036-00	10-36
				010-045-00	10-45
				010-050-00	10-50
				010-051-00	10-51

INTERCHANGES

DEXTER	OUR #	DEXTER	OUR #	DEXTER	OUR #
010-056-00	10-56	031-029-02	31-29-2	HGR-110-00	HGR110
010-060-00	10-60	031-030-01	31-30-1	HGR-202-00	HGR202
010-063-00	10-63	031-030-02	31-30-2	HGR-212-00	HGR212
010-163-00	10-163	031-031-01	31-31-1	HGR-248-00	HGR248
010-258-00	568222	031-031-02	31-31-2	HGR-249-00	HGR249
011-017-00	11-17	031-031-03	31-31-3	HGR-252-00	HGR252
011-021-00	11-21	031-032-01	31-32-1	HGR-274-00	HGR274
011-054-00	11-54	031-032-02	31-32-2	HGR-302-00	HGR302
012-001-00	12-1	031-033-01	31-33-1	HGR-312-00	HGR312
012-003-00	12-3	031-033-02	31-33-2	HGR-348-00	HGR348
012-040-00	12-40	046-032-00	46-32	K08-091-91	K8-91-91
013-004-00	13-4	072-017-00	72-17	K08-201-9A	K8-201-9A
013-010-04	13-10	072-025-00	72-25	K08-201-90	K8-201-9
013-044-01	13-44-1	072-026-00	72-26	K08-201-91	K8-201-91
013-104-02	13-104-2	072-027-00	72-27	K08-201-97	K8-201-97
013-105-02	13-105-2	072-030-00	72-30	K08-219-90	K8-219-90
013-122-04	13-122	072-031-00	72-31	K08-219-91	K8-219-91
014-077-00	14-77	072-032-00	72-32	K08-247-90	K8-247-9
015-012-00	15-2	072-042-00	72-42	K08-247-93	K8-247-93
018-011-00	18-11	085-001-00	85-1	K08-248-90	K8-248-9
018-012-00	18-12	56869	568699	K08-249-91	K8-249-91
018-013-00	18-13	090904	568699	K08-250-90	K8-250-90
018-020-00	18-20	2SF-54	AB2SF-54	K08-257-91	K8-257-91
018-021-00	18-21	2SF-58	AB2SF-58	K08-258-91	K8-258-91
019-002-00	19-2	2SF-70	AB2SF-70	K08-259-91	K8-259-91
021-001-00	21-1	2SF-73	AB2SF-73	K08-288-90	K8-288-9
021-003-00	21-3	3DF-88	AB3DF-88	K8-219-9D	K8-219-9D
021-035-00	21-35	3DF-93	AB3DF-93	K23-026-00	K23-26
021-036-00	21-36	3SF-84	AB3SF-84	K23-027-00	K23-27
021-039-00	21-39	3SF-86	AB3SF-86	K23-047-00	K23-47
021-041-00	21-41	3SF-88	AB3SF-88	K23-048-00	K23-48
021-042-00	21-42	3SF-94	AB3SF-94	K23-105-00	K23-105
021-043-00	21-43	6DF-94	AB6DF-94	K23-106-00	K23-106
021-088-00	21-88	6SF-73	AB6SF-73	K23-180-00	K23-180
021-217-00	21-38	6SF-79.5	AB6SF-79.5	K23-181-00	K23-181
021-219-00	21-37	6SF-81.25	AB6SF-81.25	K23-312-00	K23-312
028-001-00	28-1	6SF-86	AB6SF-86	K23-313-00	K23-313
028-005-00	28-5	6SF-88	AB6SF-88	K23-338-00	K23-338
028-006-00	28-6	6SF-94	AB6SF-94	K23-339-00	K23-339
028-009-00	28-9	A/P-103	AP103	K23-344-00	K23-344
028-009-01	PS-HR25F	A/P-115	AP115	K23-345-00	K23-345
028-010-01	28-10-1	A/P-122	AP122	K23-402-00	K23-402
028-049-00	28-49	A/P-202	AP202	K23-403-00	K23-403
029-001-00	29-1	A/P-216	AP216	K23-432-00	K23-432
029-005-01	PS-HR27F	A/P-233	AP233	K23-433-00	K23-433
029-008-00	29-8	A/P-247	AP247	K23-434-00	K23-434
029-031-00	29-31	A/P-264	AP264	K23-435-00	K23-435
030-006-01	PS-HR26W	A/P-302	AP302	K23-438-00	K23-438
030-020-00	30-20	A/P-316	AP316	K23-439-00	K23-439
030-028-00	30-28	A/P-335	AP335	K23-442-00	K23-442
031-017-01	31-17-1	A/P-364	AP364	K23-443-00	K23-443
031-017-02	31-17-2	APUBR-1	APUBR-1	K23-446-00	K23-446
031-019-01	31-19-1	APUBR-8	APUBR-8	K23-447-00	K23-447
031-019-02	31-19-2	APUBR-9	APUBR-3	K23-450-00	K23-450
031-028-01	31-28-1	APUBR-10	APUBR-10	K23-451-00	K23-451
031-028-02	31-28-2	HGR-104-00	HGR104	K23-528-00	K23-256
031-029-01	31-29-1	HGR-105-00	HGR105	K23-529-00	K23-255

INTERCHANGES

DEXTER	OUR #	DEXTER	OUR #	NUERA	OUR #
K23-532-00	K23-532	K568255.2	K23-256	08-409	DR-34W
K23-533-00	K23-533	PR427	72-210	08-410	DR-58W
K71-047-00	K71-047			08-411	DR-12B
K71-048-00	K71-048			08-412	DR-100W
K71-104-00	K71-104			1-409	CA-2000-BC
K71-105-00	K71-105			14-100	FS14200
K71-125-00	K71-125			14-110	FS14250
K71-127-00	K71-127			14-115	FS14150
K71-288-00	K71-288			15-101	HB-1780-10
K71-289-00	K71-289			15-202	HB-2000-10
K71-290-00	K71-290			15-304	HB-2516-10
K71-291-00	K71-291			15-1802010	HB-2000-34
K71-294-00	K71-294			17-110	DBN-2120
K71-295-00	K71-295			17-111	DB-2120
K71-296-00	K71-296			17-111-1	DB-3000
K71-299-00	K71-299			17-112	DBN-3000
K71-300-00	K71-300			18-100	CA-2000-B
K71-301-00	K71-301			18-101	CA-2516-B
K71-303-00	K71-303			18-279-I	JE-3520-BBX
K71-304-00	K71-304			18-299-I	JM-1500-B
K71-305-00	K71-305			18-299-15	JM-1001-B
K71-306-00	K71-306			18-307-B	JA-2000-B
K71-307-00	K71-307			18-309	JA-5000-B
K71-308-00	K71-308			18-309-L	JF-101
K71-309-00	K71-309			18-309-S	JF-100-Z
K71-310-00	K71-310			18-410	CA-2516-BC
K71-314-00	K71-314			18-440-B	JB-2001-B
K71-315-00	K71-315			18-440-2I	JP-2002S-B
K71-316-00	K71-316			18-440-3I	JP-2002-B
K71-317-00	K71-317			18-440-5I	JP-2001-B
K71-318-00	K71-318			18-440-8I	JP-2001S-B
K71-319-00	K71-319			18-450-I	JP-5001S-B
K71-320-00	K71-320			18-450-2I	JP-5001-B
K71-321-00	K71-321			18-520-1	CT-17820-Z
K71-322-00	K71-322			18-525-1	CT-17825-Z
K71-335-00	K71-335			18-530-1	CT-17830-Z
K71-341-00	K71-341			18-600-1	CT-20025-Z
K71-365-00	AP202			18-610-1	CT-20020-Z
K71-366-00	AP216			18-630-1	CT-20030-Z
K71-375-00	K71-375			19-570	JD-12K-FNH
K71-376-00	K71-376			19-570-SP	JD-12K-RNH
K71-386-00	K71-386			19-906-I	JD-7000-S
K71-388-00	10-56			19-907-I	JD-7000
K71-390-00	K71-390			21-301	DBA-3000
K71-391-00	K71-391			21-302-1	CADJ-2516S
K71-401-00	AP233			21-302-3	CADJ-2516C
K71-402-00	AP335			21-302-4	CADJ-2000C
K71-403-00	AP122			21-302-6	CADJ-2516CHD
K71-415-00	K71-415			21-304	DBA-3
K71-471-00	K71-471			21-430	DBA-5
K71-845-00	21-38			27-001	29-8
K71-859-00	21-37			27-001-1	28-6
K363587	21-38			27-002	30-20
K363601	K23-532			27-003	7-3
K363602	K23-533			27-004	6-7
K568220	21-37			27-005	18-12
K568255.1	K23-255			27-006	18-11

INTERCHANGES

NUERA	OUR #	NUERA	OUR #	NUERA	OUR #
27-007	7-40	27-305-B-ALB	8-201-9	27-438	K23-47
27-008	6-80	27-314-1	8-214-5	27-439	K23-48
27-008-1	6-98	27-314-1-B	8-288-5	27-440-ALB	K23-26
27-009	28-5	27-314-1-1	8-288-5	27-441-ALB	K23-27
27-010-1	13-105-2	27-315	9-27-1	27-442-ALB	K23-105
27-010-2	13-104-2	27-315-2	9-28-1	27-443-ALB	K23-106
27-012	28-1	27-315-3	8-288-5	27-444-1	K23-434
27-013	29-1	27-320	31-31-2	27-445-1	K23-435
27-014	30-28	27-321	31-31-1	27-448-2	K23-450
27-015	7-17	27-324	31-33-2	27-448-3	K23-438
27-017-1	13-4	27-325	31-33-1	27-449-2	K23-451
27-018	13-44-1	27-326	31-30-2	27-449-3	K23-439
27-019	7-1-1	27-327	31-30-1	27-450-ALB	K23-180
27-020	6-111	27-328	31-32-2	27-451-ALB	K23-181
27-022	7-7	27-329	31-32-1	27-452-1	K23-442
27-023	6-11	27-330	31-17-2	27-453-1	K23-443
27-024	15-2	27-331	31-17-1	27-454-1	K23-446
27-027	19-2	27-332	31-28-2	27-455-1	K23-447
27-028	PS-HR25F	27-333	31-28-1	27-460-1	K23-344
27-029	PS-HR27F	27-338	31-19-2	27-460-2	K23-312
27-031	PS-HR26W	27-339	31-19-1	27-461-1	K23-345
27-032	6-53	27-340	31-29-2	27-461-2	K23-313
27-032-2	6-109	27-341	31-29-1	27-462-3	K23-338
27-057	6-1	27-346	31-31-3	27-463-3	K23-339
27-057-3	6-191	27-351-1	10-19	27-466-F	K23-402
27-058	5-23	27-352-1	10-10	27-467-F	K23-403
27-058-1	5-101	27-352-2	10-36	27-710	K71-288
27-058-3	5-27	27-358	10-56	27-711	K71-289
27-059	5-57	27-359-1	10-51	27-712	K71-290
27-061	6-190	27-360-N	10-63	28-100-1	RT-2212
27-063	5-60	27-369-A	BP-1980	28-100-2	RT-226
27-064	6-84	27-369-1A	BP-2441	28-106	BM-20
27-065	5-59	27-370	21-3	28-107	BM-40
27-202	72-25	27-370-2	21-41	28-108-C	HP-58
27-202-1	72-42	27-371	21-1	28-108-1C	HP-12
27-203	72-27	27-371-2	21-42	28-110	PHM-8
27-210	72-30	27-372	21-39	28-110-1	PHM-4
27-211	72-32	27-372-BB	7-262	38-001	TB1824
27-220	12-40	27-372-2	21-43	38-002	TB1836
27-223	12-1	27-373	21-35	38-003	TB1848
27-224	12-2	27-373-5	21-88	55-27225	K71-289
27-230	11-54	27-374-1	21-36	55-27230	K71-288
27-232	11-17	27-375	10-45	55-27235	K71-287
27-251	SS-238	27-376	10-50	4202	APUBR-1
27-252	SS-300	27-376-1	10-163	4205	APUBR-10
27-281-B	8-257-5	27-377	46-32		
27-281-1	8-258-5	27-379	85-1		
27-282-1	8-91-5	27-383	7-122		
27-284-1	8-259-5	27-383-1	7-246		
27-290-B-ALB	8-247-5	27-400	K71-047		
27-290-I-ALB	8-248-5	27-401	K71-048		
27-291-B	8-249-5	27-416	K71-127		
27-292-B	8-250-5	27-420	K71-104		
27-294-B-ALB	8-249-7	27-421	K71-105		
27-295-B	8-247-12	27-423-1	K71-375		
27-300-B-ALB	8-201-5	27-424-1	K71-376		
27-301-B-ALB	8-219-4	27-425	K71-125		

INTERCHANGES

OPTRONICS	OUR #	QUALITY	OUR #	QUALITY	OUR #
A45GB	SL4GB	02420	31-28-1	4711-L	K23-338
A45PB	SLPL3S	02475	31-28-2	4711-R	K23-339
A47PB	SLPL3R	3B8L	CA-2000-BC	4740-L	K23-47
A70GB	SL6GB	4B8L	CA-2516-BC	4740-R	K23-48
BUL12CB	SL6O6225	5-23	5-23	4741-L	K23-446
STL12RB	SL6O6125	7-40	7-40	4741-R	K23-447
STL13RB	SL4R7100	10-10	10-10	4753	5-27
		10-45	10-45	4754	6-1
		10-50	10-50	4755	19-2
		10-51	10-51	4756	6-80
		10-56	10-56	5141	CT-17825-Z
		13-4	13-4	5142	CT-20025-Z
		15-192TB	10-60	5143	CT-17820-Z
		21-1	21-1	5144	CT-17830-Z
		21-1-AL	21-42	5145	CT-20020-Z
		21-3	21-3	5146	CT-20030-Z
		21-3-AL	21-41	12011-1	21-37
		21-35	21-35	15123	31-29-2
		22-07	21-36	15245	31-29-1
		23-195	K23-450	18820	CADJ-2516S
		23-196	K23-451	22333TBN	10-36
		23-97	K23-434	25520	31-30-1
		23-98	K23-435	25580	31-30-2
		72-17	72-17	40715	K23-345
		72-25	72-25	40716	K23-344
		72-26	72-26	80072	CA-2000-B
		72-27	72-27	81911	CA-2516-B
		72-30	72-30	81912	CA-2516-B14
		72-31	72-31	84545-1	8-248-5
		72-32	72-32	84550-1	84550
		72-42	72-42	88440-1	8-91-5
		78LN	6-111	88545-1	8-258-5
		516LN	6-11	92655-1	8-201-9
		1605	21-39	92865A-1	8-219-4
		1605-AL	21-43	93001	5-101
		4101-1	13-122	94545-1	8-247-5
		4101-2	18-12	94550-1	8-249-7
		4101-2A	18-11	94655-1	8-250-5
		4101-4	28-5	171255TB	10-19
		4101-4L	28-49	363601	K23-532
		4101-5	7-3	363602	K23-533
		4101-6	6-7	370219A	10-63
		4105-1	28-6	516314	7-7
		4113-5W	7-1-1	568255.1	K23-255
		4113-7	7-17	568255.2	K23-256
		4201-2FL	-169	945475-1	8-247-12
		4201-3	12-2	945555-1	8-249-5
		4202-3	12-3	BH81780	PH-1780
		4205-3	12-40	BH82000	PH-2000
		4370	722-106	BH82516	PH-2516
		4375	722-107	BM10E	K71-104
		4701-L	K23-26	BM12E	K71-105
		4701-R	K23-27	BP198	BP-1980
		4704-L	K23-180	BP244	BP-2441
		4704-R	K23-181	D01C	21-88
		4710-L	K23-312	EB-90	13-44-1
		4710-R	K23-313	EJ-3520-BBX	JE-3520-BBX

INTERCHANGES

QUALITY	OUR #	REDNECK	OUR #	REDNECK	OUR #
EQ-310	13-10	02420	31-28-1	15-12	15-2
JAT02-14NP	JA-2000-B	02475	31-28-2	18-11	18-11
JAT05-14NP	JA-5000-B	09251510	7-246	21-1-1	21-42
JBS01-10C2	JM-1001-B	3-42	SS-300	21-3-1	21-41
JDS10-26FNH	JD-12K-FNH	3-43	SS-238	21-35	21-35
JDS10-26SP2	JD-12K-RNH	3B6M	CADJ-2000C	21-36	21-36
JPS02-10XP	JP-2001S-B	3B8	CA-2000-BC	21-43-1	21-43
JPS02-15XP	JP-2002S-B	4B6M	CADJ-2516C	21-88	21-88
JPS05-10XP	JP-5001S-B	4B8	CA-2516-BC	21CLS	HB-2000-10
JPS05-15XP	JP-5002S-B	4B8L	CA-2516-BC	23-26	K23-26
JPT02-10XP	JP-2001-B	5-23	5-23	23-27	K23-27
JPT02-15XP	JP-2002-B	5-57	5-57	23-47	K23-47
JPT05-10XP	JP-5001-B	5-59	5-59	23-48	K23-48
JPT05-15XP	JP-5002-B	5-60	5-60	23-105	K23-105
JWF02-15XP	JB-2002-B	5-101	5-101	23-106	K23-106
JWT02-10XP	JB-2001-B	6-11	6-11	23-180	K23-180
L44610	31-31-1	6-53	6-53	23-181	K23-181
L44643	31-31-3	6-84	6-84	23-312	K23-312
L44649	31-31-2	6-92	6-92	23-313	K23-313
L68111	31-33-1	6-109	6-109	23-338	K23-338
L68149	31-33-2	6-111	6-111	23-339	K23-339
LM67010	31-32-1	6-190	6-190	23-344	K23-344
LM67048	31-32-2	6-191	6-191	23-345	K23-345
MJ-1500B	JM-1500-B	7-1-1	7-1-1	23-402	K23-402
PH15	PH-3000	7-7	7-7	23-403	K23-403
PH30	PH-6000	7-122	7-122	23-434	K23-434
PP2K-BT16BR	K71-306	7-126	7-126	23-435	K23-435
R40484	S-84	8-91-5UC1	K8-91-91	23-438	K23-438
R50642	S-42	8-201-5	8-201-5	23-439	K23-439
RP-100	85-1	8-201-5UC3	K8-201-9	23-442	K23-442
RP-200	46-32	8-201-9UC3	K8-201-91	23-443	K23-443
SP-2-375	SS-238	8-214-5	8-214-5	23-446	K23-446
SP-3	SS-300	8-219-4UC3	K8-219-90	23-447	K23-447
TJB-20015-B	JB-2001S-B	8-219-13	8-219-13	23-450	K23-450
TJDP-7000S	JD-7000-S	8-219-13UC3	K8-219-91	23-451	K23-451
V75340	568222	8-258-5	8-258-5	27-230-K11	APUBR-10
		8-258-5UC1	K8-258-91	27-231-K11	APUBR-1
		8-259-5UC1	K8-259-91	27-232-K11	APUBR-8
		8-288-3	8-288-5	28-1	28-1
		8-288-3UC1	K8-288-9	28-5	28-5
		9-27-1	9-27-1	29-1	29-1
		9-28-1	9-28-1	29-31	29-31
		9-44-1	8-288-5	30-20	30-20
		10-10	10-10	30-28	30-28
		10-19	10-19	38N	6-130
		10-36	10-36	46-32	46-32
		10-45	10-45	85-1	85-1
		10-50	10-50	234CLS	HB-2000-34
		10-51	10-51	382A	31-19-1
		10-56	10-56	387A	31-19-2
		10-60	10-60	803T3	72-30
		10-63	10-63	916DLN	6-7
		10-163	10-163	1003T3	72-31
		12N	6-169	1020	72-17
		13-10	13-10	1203T3	72-32
		13-44	13-44-1	1238	DBF-3000
		13-104-02	13-104-2	1249-2H	DBN-3000

INTERCHANGES

REDNECK	OUR #	REDNECK	OUR #	REDNECK	OUR #
1250-3	DBN-2120	151401	JB-2001-B	BK3-210	BK3-210
1250-15	DB-2120	151421	JB-2002-B	BK3-300	BK3-300
1385	DB-3000	155022	JA-2000-B	BK3-310	BK3-310
1781CLS	HB-1780-10	158109	JP-2001S-B	BM01-285	BM-20
2516CLS	HB-2516-10	158151	JP-2002S-B	BM01-485	BM-40
5113	CA-2516-B14	158451	JP-2001-B	BM01-595	BM-60
5172	CA-2000-B	158452	JP-2002-B	BP01-115	K71-104
5874A8	JM-1500-B	165649	19-2	BP01-185	K71-105
8978	DBA-3	165686	6-1	BP01-225	K71-125
9163B	7-3	165995	7-262	BP01-301	K71-376
14125A	31-17-2	166074	7-1-1N	BP04-095	K71-047
14276	31-17-1	166079	7-17N	BP04-165	K71-048
15123	31-29-2	166081	7-3N	CP01-010	CT-17820-Z
15245	31-29-1	175020	JA-5000-B	CP01-020	CT-17825-Z
16137	DBA-3000	175643	11-54N	CP01-030	CT-17830-Z
17834CLS	HB-1780-34	175643LN	11-54	CP01-040	CT-20020-Z
25520	31-30-1	176400	11-21N	CP01-050	CT-20025-Z
25580	31-30-2	176400LN	11-21	CP01-060	CT-20030-Z
34822	8-91-5	176500	176500	DPH2000	PH-2000
38605	21-39	178101	JP-5001-B	DPH2516	PH-2516
42656	8-201-9	178151	JP-5002-B	DR10-3-4	DR-100W
42656UC3	K8-201-9A	178201	JP-5001S-B	DR12-25	DR-12W
42866	8-219-4	178203	JP-5002S-B	DR58-3	DR-58W
42866UC3	K8-219-9D	182800	JD-12K-RNH	DRB12-25	DR-12B
45034	BM-2-1780	182817	JD-12K-FNH	E4139	28-49
45036	BM-2-2000	190500	JD-7000	E4541	13-4
45041	BM-2-2516	190510	JD-7000-S	EB01-070	K23-47
45042	BM-4-2516	721584-3	PS-HR25F	EB01-075	K23-48
45056	BM-4-2000	721585-3	PS-HR26W	EB01-100	K23-26
45896	21-1	721586-3	PS-HR27F	EB01-105	K23-27
46749	21-3	722106	722-106	EB01-120	K23-180
80071	CA-2000-B	722107	722-107	EB01-125	K23-181
80718	JE-3520-BBX	845476	8-247-12	EB01-130	K23-434
81911	CA-2516-B	1531095	21-38	EB01-135	K23-435
82650	JF-100-Z	1755892	11-17N	EB01-140	K23-450
82660	JF-101	1755892LN	11-17	EB01-145	K23-451
84545	8-248-5	2425160	CADJ-2516S	EB01-160	K23-442
84545UC1	K8-248-9	34822545	8-259-5	EB01-165	K23-443
84546	8-247-5	A2252CB	13-122	EJ1000	JM-1001-B
84546UC3	K8-247-9	AP202	AP202	EJ-3520-BBX	JE-3520-BBX
84550	84550	AP216	AP216	H202	HGR202
84550UC1	84550UC1	AP233	AP233	H248	HGR248
84556	8-249-7	AP302	AP302	H302	HGR302
84557	8-249-5	AP316	AP316	HB01-130	K23-402
84557UCE	K8-249-91	APS1	APS1	HB01-135	K23-403
84656	8-250-5	APT3	APT3	HD700A	8-257-5
84656UC3	K8-250-90	APT5	APT5	HD701BUC3	K8-257-91
91635B	7-17	APT6SE-GS3	APT288	K363383.1	K23-27
92125	21-37	BE10-35L	K23-26	K363383.2	K23-26
92127	568222	BE10-35R	K23-27	K363601	K23-532
115052	18-13	BE12-70L	K23-180	K363602	K23-533
115208	18-12	BE12-70R	K23-181	K568106.1	K23-181
117521	12-1	BK1-150	BK1-150	K568106.2	K23-180
117535	12-40	BK2-100	BK2-100	K568255.1	K23-255
117595	12-3	BK3-100	BK3-100	K568255.2	K23-256
140070	JF-99	BK3-110	BK3-110	K71-047-00	K71-047
151101	JB-2001S-B	BK3-200	BK3-200	K71-048-00	K71-048

INTERCHANGES

REDNECK	OUR #	REDNECK	OUR #	WALLACE FORGE	OUR #
K71-127-00	K71-127	SP05-040	K05-040	050A	DBN-2120
L44610	31-31-1	SW1000	5-27	051B	DBN-3000
L44643	31-31-3	TJD7000	JD-7000	052D	DBF-3000
L44649	31-31-2	TJD-7000-HD	JD-7000-HD	R49A	DB-2120
L68111	31-33-1	TJD7000S	JD-7000-S	R51A	DB-3000
L68149	31-33-2	X1023R	6-80		
LG-0083-01	JD-12K-HD	X1064	7-40		
LM67010	31-32-1	XP10	JM-1001-B		
LM67048	31-32-2				
MJ1500B	JM-1500-B				
PM6990S	PHM-8				
PR4	72-25				
PR4B	72-42				
PR5	72-26				
PR6	72-27				
PR427	72-210				
PR626	72-27-1				
R15T	PH-3000				
R40484	S-84				
R50642	S-42				
RB06UP	RT-226				
RB12	RT-2212				
RG01-060	K71-299				
RG02-020	K71-296				
RG03-040	K71-295				
RG03-060	K71-471				
RG03-080	RG03-080				
RG04-010	K71-320				
RG04-020	K71-314				
RG04-040	K71-315				
RG04-060	K71-316				
RG04-080	K71-317				
RG04-100	K71-318				
RG04-120	K71-319				
RG04-280	21-38				
RG04-300	21-88				
RG05-040	K71-322				
RG05-060	K71-335				
RG05-080	K71-321				
RG06-020	K71-301				
RG06-050	K71-303				
RG06-070	K71-305				
RG06-090	K71-304				
RG07-040	BP-1980				
RHPP1	HP-58				
RHPP2	HP-12				
SP01-020	K71-391				
SP01-040	SP01-040				
SP01-060	K71-294				
SP01-080	SP01-080				
SP03-020	K71-288				
SP03-040	K71-287				
SP03-060	K71-289				
SP04-020	SP04-020				
SP04-040	SP04-040				
SP04-060	SP04-060				
SP05-020	K05-020				

NEW PRODUCTS

from



“A partner you can count on”

A PARTNER YOU CAN COUNT ON

SIRCO

Sirco Industries, Inc.



ELECTRIC

A-FRAME JACK

For use with trailers with A-frame couplers.

- *Setup for 12-volt battery use*
- ***Includes a 27" single wire***
battery hookup
- ***18" travel height***
- ***7-1/2" drop leg***
- *Exterior grade black powder coat finish on outer tube*
- *Zinc finish on inner tube with removable sand foot.*
- *Crank Handle for manual override in case of power loss*



Features Bright LED Light for night time hook up

Sirco Part No.	Capacity	Description
JE-3520-BBX	3500 lb.	Electric A-Frame Jack



Universal Joints

NEW

SIRCO	SERIES	AUTOMANN	SKF	MERITOR	NEAPCO	SPICER
S5-103X	1000	752.5103X		CP103X	1-0605	5-103X
S5-153X	1310	752.5153X	UJ369	CP153X	1-0153	5-153X
S5-155X	1550	752.5155X	UJ358	CP155X	3-0155	5-155X
S5-170X	1000	752.5170X	UJ338	CP170X	1-0170	5-170X
S5-1704X	SPL170 Metric			US170X		SPL170-4X
S5-20RPLSX	RPL 20R			CP20RPLS		
S5-25RPLSX	RPL 25R			CP25RPLS		
S5-2503X	SPL250 Metric			US250X		SPL250-3X
S5-279X	1610	752.5279X	UJ333	R279X	4-0279	5-279X
S5-280X	1710	752.5280X	UJ334	R280X	5-0280	5-280X
S5-281X	1810	752.5281X	UJ381	R281X	6-0281	5-281X
S5-407X	1760	752.5407X	UJ376	R407X	6-0407	5-407X
S5-674X	1610 ½ RD	752.5674X	UJ475	R674X	6-0674	5-674X
S5-675X	1710 ½ RD	752.5675X	UJ477	R675X	6-0675	5-675X
S5-676X	1810 ½ RD	752.5676X	UJ478	R676X	6-0676	5-676X
S5-677X	1760 ½ RD	752.5677X	UJ476	R677X	6-0677	5-677X



Center Bearings

SIRCO	SERIES	AUTOMANN	MERITOR	NEAPCO	SPICER
CB084	1550	751.120084-2X	CB210084-2X	CN210084-2X	210084-2X
CB121	1700-1710	750.210121-1X	CB210121-1XSA	CN210121-1X	210121-1X
CB661	1800-1810	750.210661-1X	CB210661-1X	CN210661-1X	210661-1X



Yokes

NEW

SIRCO	DESCRIPTION	MERITOR	NEAPCO	SPICER
Y104123	1000 Series Round End Yoke - 2.5" X 2"	10N-4-123	10-4123	10-4-123
Y104930	1000 Series Round End Yoke - 2.5" X 1.63"	10N-4-93	10-0493	10-4-93

Manufacturers' and replacement parts suppliers' names and numbers are used for reference purposes only, and it is not implied any part listed is a product of these manufacturers or suppliers.

Sensor Cable Kit for Truck, Tractor and Bus Air Brake Systems

Includes: Cable, clip and grease packet.

PART NO.	DESCRIPTION	REPLACES
SC5335	1' – 90 Degree Right Angle	Globetech GTA-R955335, Meritor R955335
SC5336	3' – 90 Degree Right Angle	Globetech GTA-R955336, Meritor R955336
SC5338	5.8' – Straight	Globetech GTA-R955338, Meritor R955338
SC5341	5.8' – 90 Degree Right Angle	Globetech GTA-R955341, Meritor R955341
SC5342	6.8' – 90 Degree Right Angle	Globetech GTA-R955342, Meritor R955342
SC5458	Sensor Clip and Grease Packet	Tectran AC034W, Meritor R955458,
SE0180	6' Sensor Cable Extension	Automann 577.A7130180 Meritor Wabco S449-713-0180
SE0300	10' Sensor Cable Extension	Automann 577.A7130180 Meritor Wabco S449-713-0300



Manufacturers' and replacement parts suppliers' names and numbers are used for reference purposes only, and, it is not implied any part listed is a product of these manufacturers or suppliers



AIR DISC BRAKES

INCLUDING CHAMBERS, SPRING BRAKES AND BRAKE KITS

"A PARTNER YOU CAN COUNT ON"



AIR DISC BRAKES SERVICE CHAMBERS

SIRCO	REPLACES	DESCRIPTION
A1600D	K028226	TYPE 16 AIR DISC BRAKE
A1800D	K028022	TYPE 18 AIR DISC BRAKE
A2000D	K028225	TYPE 20 AIR DISC BRAKE
A2000LD	20SCLDH3H	TYPE 20 LONG STROKE ADB
A2400D	K028252	TYPE 24 AIR DISC BRAKE



AIR DISC BRAKES SPRING BRAKES

SIRCO	OE	SERVICE	UNIVERSAL
A1624D	K042457	K042457	K042457
A1824D	5020489	803154	K043329/K026451
	K026129	K026338	K043329/K026451
	K026127	K026336	K043329/K026451
	K026128	K026337	K043329/K026451
A2024D	K041960	K041960	K041960
A2430D	K043270	K043270	K043270

Manufacturers' and replacement parts suppliers' names and numbers are used for reference purposes only, and, it is not implied any part listed is a product of these manufacturers or suppliers.



NEW AIR DISC BRAKE KITS

INCLUDES 4 PADS AND INSTALLATION KIT

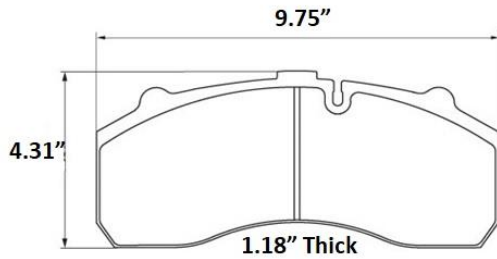

Sirco Part No. ADBK1203 **WVA# 29106**

Caliper: Knorr SB7™/SN7™
Application: Prevost, Nova, Setra, Temsa, ZF, Van Hool

Replaces: BENDIX K006060
 KNORR 5013257
 MERITOR MMD1203AF

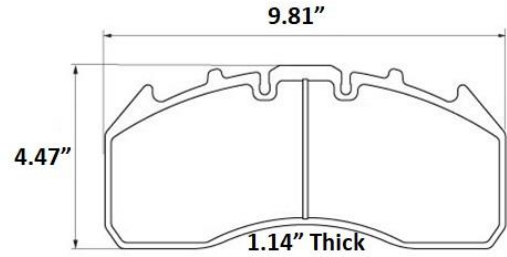

Sirco Part No. ADBK1311 **WVA# 29187**

Caliper: Meritor EX225 H2
Application: MCI, Nabi

Replaces: MERITOR KIT2252H2BA
 KIT2252H2CD
 KIT2252H2CE
 KIT2252H2DA

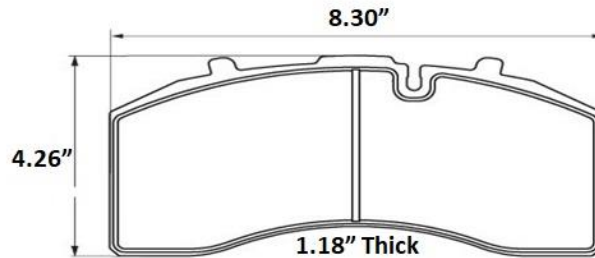

Sirco Part No. ADBK1369 **WVA# 29158**

Caliper: Knorr SK7™ / Bendix ADB22X™
Application: Truck, Trailer, MCI

Replaces: BENDIX K070796
 KNORR 802078
 MERITOR MMD1369AF

Dynamometer Performance Test - FMVSS 121

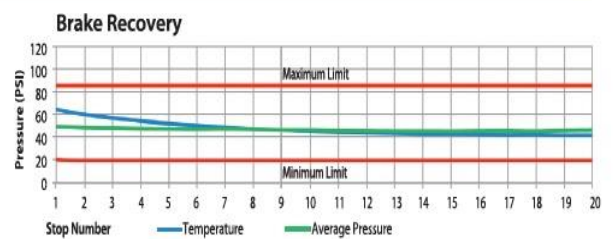
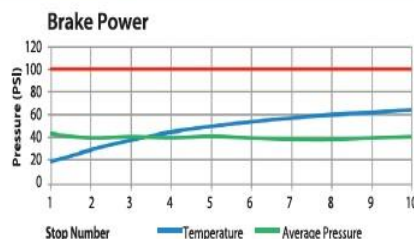
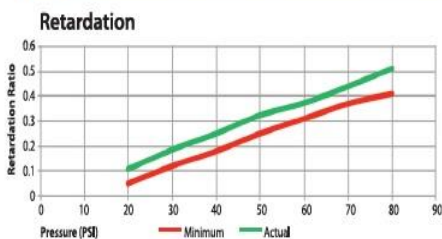

FMVSS-121 Test Parameters: Caliper: Knorr SB7™ • Axle Rating: 23,000 lbs • Rolling Radius: 20.5 inches • Air Chamber: Type 24 • Rotor: Knorr (OEM)

HOLLAND STYLE LANDING GEAR



LG50K-H	REPLACEMENT PARTS																				
<p>Product Features</p> <ul style="list-style-type: none"> • High quality and durability • 50,000 lb. capacity • Precision forged 2 speed gearbox • UNIVERSAL mount • Crank handle and connecting shaft included • Meets or exceeds TTMA and AAR certification and recommendations • Jack screw and bevel gear ratio interchangeable with other like models 	<table border="0"> <tr> <td>LG-AB</td> <td>2 pc adjustable brace</td> </tr> <tr> <td>LG-CS</td> <td>Connection shaft</td> </tr> <tr> <td>LG-WB</td> <td>"W" Mounting bracket</td> </tr> <tr> <td>LG50K-B</td> <td>Bushing</td> </tr> <tr> <td>LG50K-DG</td> <td>Drive gear</td> </tr> <tr> <td>LG50K-HD</td> <td>Landing gear handle</td> </tr> <tr> <td>LG50K-HG</td> <td>50K Gear leg</td> </tr> <tr> <td>LG50K-HNG</td> <td>50K Non-gear leg</td> </tr> <tr> <td>LG50K-SG</td> <td>Speed gear</td> </tr> <tr> <td>LG50K-SS</td> <td>Sand shoe</td> </tr> </table>	LG-AB	2 pc adjustable brace	LG-CS	Connection shaft	LG-WB	"W" Mounting bracket	LG50K-B	Bushing	LG50K-DG	Drive gear	LG50K-HD	Landing gear handle	LG50K-HG	50K Gear leg	LG50K-HNG	50K Non-gear leg	LG50K-SG	Speed gear	LG50K-SS	Sand shoe
LG-AB	2 pc adjustable brace																				
LG-CS	Connection shaft																				
LG-WB	"W" Mounting bracket																				
LG50K-B	Bushing																				
LG50K-DG	Drive gear																				
LG50K-HD	Landing gear handle																				
LG50K-HG	50K Gear leg																				
LG50K-HNG	50K Non-gear leg																				
LG50K-SG	Speed gear																				
LG50K-SS	Sand shoe																				



LG66K-H	REPLACEMENT PARTS										
<p>Product Features</p> <ul style="list-style-type: none"> • High quality and durability • 66,000 lb. capacity • Precision forged 2 speed gearbox • UNIVERSAL mount • Crank handle and connecting shaft included • Meets or exceeds TTMA and AAR certification and recommendations • Mounting plates interchangeable with other like models 	<table border="0"> <tr> <td>LG66-CS</td> <td>Connection shaft</td> </tr> <tr> <td>LG66-WB</td> <td>"W" Mounting bracket</td> </tr> <tr> <td>LG66K-HD</td> <td>Landing gear handle</td> </tr> <tr> <td>LG66K-HG</td> <td>66K Gear leg</td> </tr> <tr> <td>LG66K-HNG</td> <td>66K Non-gear leg</td> </tr> </table>	LG66-CS	Connection shaft	LG66-WB	"W" Mounting bracket	LG66K-HD	Landing gear handle	LG66K-HG	66K Gear leg	LG66K-HNG	66K Non-gear leg
LG66-CS	Connection shaft										
LG66-WB	"W" Mounting bracket										
LG66K-HD	Landing gear handle										
LG66K-HG	66K Gear leg										
LG66K-HNG	66K Non-gear leg										

“A partner you can count on”

BPW - BERGISCHE ACHSEN 16.53" CHASSIS BRAKE HARDWARE KIT

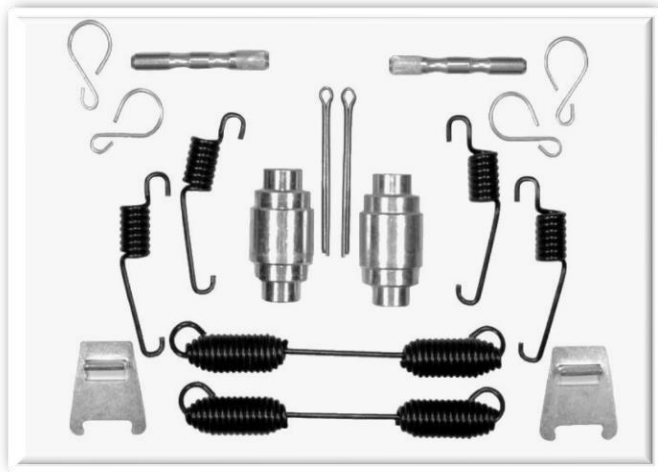

PART #	REPLACES
KK-1A	BATCO 08-115012 EUCLID E-7242 JOST R9000B LELAND K-379

CAM KIT FOR 16.53" x 7.09" BREMSBELAG (BRAKE)



PART #	REPLACES
B5130	LELAND K-513

HENDRICKSON TRAILER REPLACEMENT PARTS

PIVOT BOLT KITS	PART No.	DESCRIPTION	REPLACES
 <p>SH2001</p> <p>SH2002</p> <p>SH2003</p>	SH2001	Wide Bushing	Automann - MHS203 Dayton - 334-1579 Euclid - E-10730A Hendrickson - S-24679
	SH2002	Narrow Bushing	Automann - MHS205 Dayton - 334-1637 Euclid - E-14635 Hendrickson - S-24705
	SH2003	Welded Alignment, Wide Bushing	Automann - BKF118934GR5 Dayton - 334-837 Euclid - E-3768 Hendrickson - S-3646





PIVOT BOLT KITS WITH BUSHINGS	PART No.	DESCRIPTION	REPLACES
 <p>SH2006</p> <p>SH2007</p> <p>SH2008</p>	SH2006	Wide Bushing White 7" x 2-3/8" x 3/8"	Automann - MHS736 Dayton - 334-1576 Euclid - E-10729A Hendrickson - S-24691
	SH2007	Narrow Bushing Gray 7" x 2-3/8" x 3/32"	Automann - MHS745 Dayton - 334-1628 Euclid - E-14377 Hendrickson - S-26321
	SH2008	Welded Alignment, Wide Bushing White 7" x 2-3/8" x 3/8"	Automann - TRK5912 Dayton - 334-658 Euclid - E-6121 Hendrickson - S-6914





PIVOT CONNECTION HARDWARE	PART No.	DESCRIPTION	REPLACES
 <p>SH2012</p> <p>SH2013</p> <p>SH2014</p> <p>SH2015</p> <p>SH2016</p>	SH2012	Alignment Washer (Inner)	Automann - MHS97 Dayton - 334-1574 Euclid - E-10755 Hendrickson - S-20924
	SH2013	Alignment Washer (Outer)	Automann - MHS99 Dayton - 334-1573 Euclid - E-10754 Hendrickson - S-20925
	SH2014	Bushing Wear Pad Wide Pivot Connection 7" x 2-3/8" x 3/8"	Automann - M14713 Dayton - 334-1810 Euclid - E-6122 Hendrickson - S-21099
	SH2015	Bushing Wear Pad Narrow Pivot Connection 7" x 2-5/16" x 3/16"	Automann - M14718 Hendrickson - S-26807
	SH2016	Alignment Collar	Automann - M10010 Dayton - 334-822 Euclid - E-3771 Hendrickson - S-2770

HENDRICKSON REPLACEMENT TOOL





BUSHING TOOL	PART No.	DESCRIPTION	REPLACES
	SH2034	Bushing Tool - Wide Bushing	Automann - TRB5912-T Dayton - 334-936 Euclid - E-9575 Hendrickson - S-21307



HENDRICKSON TRUCK REPLACEMENT PARTS



BEAM END ADAPTER ASSEMBLIES	PART No.	DESCRIPTION	REPLACES
 SH2100	SH2100	R440 Adapter Assembly 340/380/400/440/460 Series	Automann - HAK100 Dayton - 334-109 Euclid - E-2374 Hendrickson - 45000-007L
 SH2101	SH2101	R520 Adapter Assembly 340/380/400/440/460 Series	Automann - HAK112 Dayton - 334-467 Euclid - E-9420 Hendrickson - 21140-034L
 SH2102	SH2102	R340 Adapter Assembly Use with SH2120 340 Series	Automann - HAK34 Dayton - 334-108 Euclid - E-2372 Hendrickson - 45000-013L
 SH2104	SH2104	R650 Adapter Assembly 1-7/8"-12TPI, OD=2", L= 12-3/4" RS-RT 500, 650 Series	Automann - HAK124 Dayton - 334-138 Euclid - E-2555 Hendrickson - 21140-007

CENTER BUSHINGS	PART No.	DESCRIPTION	REPLACES
 SH2108	SH2108	R340, Welded Plug; Small OD = 2-3/4" Large OD = 3-5/8", L = 12" R340 Series	Automann - M1974HE Dayton - 321-117 Euclid E-1338 Hendrickson - 06664-000L
 SH2109	SH2109	R340, Loose Plugs Included Small OD = 2-3/4", Large OD = 3-5/8" L = 12" 340 Series	Automann - M1978 Dayton - 321-118 Euclid - E-1594 Hendrickson - 22279-000L
 SH2110	SH2110	R380, Welded Plug; Small OD = 3-1/2" Large OD = 4-3/4", L = 12" 380/400/440/460 Series	Automann - M1972 Dayton - 321-122 Euclid - E-1339 Hendrickson - 05919-000L
 SH2111	SH2111	R380, Loose Plug, Small OD = 3-1/2" Large OD = 4-3/4", L = 12" 380/400 Series	Automann - M1980 Dayton - 321-123 Euclid - E-1595 Hendrickson - 22282-000L

HENDRICKSON TRUCK REPLACEMENT PARTS



CENTER BUSHINGS	PART No.	DESCRIPTION	REPLACES
 SH2112	SH2112	R400 Center Bushing	Automann - C2020 Dayton - 321-243 Euclid - E-6979 Hendrickson - 49400-000L
 SH2113	SH2113	R400, Loose Plugs Included; Small OD = 3-1/2", Large OD = 4-3/4" L = 12" 400/460 Series	Automann - C2022 Dayton - 321-244 Euclid - E-6980 Hendrickson - 49600-000L
 SH2114	SH2114	R650, Welded Plug; Small OD = 4" Large OD = 5-1/2", L = 14-5/8" RT-RS 650 Series	Automann - M1992HE Dayton - 321-128 Euclid - E2553 Hendrickson - 10366-000L
 SH2115	SH2115	E4; OD= 2-3/4", ID = 1" L = 4-5/8" E4-360/HFS360	Automann - TRB5168 Dayton - 321-225 Euclid - E-5269 Hendrickson - 47420-000
 SH2116	SH2116	Center Bushing Kit R520 Bronze 400 Series	Automann - HBK100 Dayton - 322-102 Euclid - E-1546 Hendrickson - 30437-000L



END BUSHINGS	PART No.	DESCRIPTION	REPLACES
 SH2120	SH2120	R340, OD - 4-3/8", ID = 2-1/2" L = 5-1/4" 340 Series	Automann - M1976 Dayton - 321-120 Euclid - E-1340 Hendrickson - 06969-000L
 SH2121	SH2121	R460, OD - 4-3/8", ID = 2-1/2" L = 5-3/4" 400/460 Series	Automann - M1970 Dayton - 321-126 Euclid - E-1341A Hendrickson - 45900-000L

LOAD CUSHION	PART No.	DESCRIPTION	REPLACES
 SH2126	SH2126	Center / RS Series	Automann - MLC10 Dayton - 325-100 Euclid - 2232 Hendrickson - 24209-000
 SH2127	SH2127	RS 400 Series L = 12", W = 6-3/4", H = 4"	Automann - MLC8 Dayton - 325-104 Euclid - E-1960 Hendrickson - 26953-000L

HENDRICKSON TRUCK REPLACEMENT PARTS

ADAPTER KITS	PART No.	DESCRIPTION	REPLACES
 <p>SH2131</p>	SH2131	340 Series Includes (1) SH2102 Adapter Assembly and (1) SH2120 End Bushing	Automann - BA120 Dayton - 334-380 Euclid - E-5308 Hendrickson - 34013-048L
	SH2132	340/400/460 Series Includes (1) SH2100 Adapter Assembly and (1) SH2121 End Bushing	Automann - BA122 Dayton - 334-381 Euclid - E-5309 Hendrickson - 34013-049L

SPRING EYE BUSHINGS	PART No.	DESCRIPTION	REPLACES
 <p>SH2136</p>  <p>SH2137</p>	SH2136	RT/RU 340 OD = 1-1/2", ID = 1-1/4", L = 3-15/16"	Automann - OGB-RNK Dayton - 322-100 Euclid - E-1876 Hendrickson - 30057-007L
	SH2137	RT400 OD = 1-5/8", ID = 1-3/8", L = 3-15/16"	Automann - OGB-TPK Dayton - 322-101 Euclid - E-1877 Hendrickson - 30057-008L

BOLSTER SPRING KITS	PART No.	DESCRIPTION	REPLACES
 <p>SH2141</p>  <p>SH2142</p>  <p>SH2143</p>	SH2141	HMX Bolster Spring Kit	Automann - MLC3 Dayton - 334-1727 Euclid - E-14374 Hendrickson - 64179-002
	SH2142	HMX 460 Tie Bar Bolster Kit	Automann - MLC5 Dayton - 334-1845 Euclid - E-14044 Hendrickson - 64179-037
	SH2143	HN 522 Bolster Spring, 1 Pair, 2 Piece	Automann - MLC1 Dayton - 334-852A Euclid - E-11496 Hendrickson - 60879-000L

HENDRICKSON TRUCK REPLACEMENT PARTS







TIE ROD TUBE ENDS	PART No.	DESCRIPTION	REPLACES
 SH2148	SH2148	Straddle Mount Kit 340/400/460 Series	Automann - TMRN610 Dayton - 345-610 Euclid - E-10310 Hendrickson - 66610-000H
 SH2149	SH2149	Straddle Mount Offset Kit Navistar	Automann - TMRN640 Dayton - 345-640 Euclid - E-10313 Hendrickson - 66640-0004
 SH2150	SH2150	Straddle Mount Rod Kit 340/400/460 Series	Automann - TMRU661 Dayton - 345-661 Euclid - E-10315 Hendrickson - 66661-000H
 SH2151	SH2151	Inner Sleeve Rod, 27"-35", 5/8" Bolt Kit	Automann - TMR660 Dayton - 345-660 Hendrickson - 66660-000H
 SH2152	SH2152	Tapered Stud Kit 340 Series	Automann - TMRN620 Dayton - 345-620 Euclid - E-10311 Hendrickson - 66620-000H
 SH2153	SH2153	Tapered Stud Kit 400/460 Series	Automann - TMRN630 Dayton - 345-630 Euclid - E-10312 Hendrickson - 66630-000H
 SH2154	SH2154	Inner Sleeve Kit Navistar	Automann - TMRN650 Dayton - 345-650 Euclid - E-10314 Hendrickson - 6665-000H
 SH2155	SH2155	Straddle Mount 3/4" Bolt Kit	Automann - TMRN767 Dayton - 345-613 Euclid - E-11748 Hendrickson - 66767-000H
 SH2156	SH2156	Spacer End, Taper Pin, 27" Kit 400/460 Series	Automann - TMRN681 Dayton - 345-681 Euclid - E-10317 Hendrickson - 66681-000H
 SH2157	SH2157	Spacer End, Taper Pin, 27" Kit Mack	Automann - TMRN691 Dayton - 345-691 Euclid - E-10318 Hendrickson - 66691-000H
 SH2158	SH2158	Spacer End, Taper Pin, 27" Kit 340 Series	Automann - TMRN671 Dayton - 345-671 Euclid - E-10316 Hendrickson - 66671-000H
SH2159	SH2159	Spacer End, Taper Pin, 35" Kit	Automann - TMRN680 Dayton - 345-680 Hendrickson - 66680-000H

HENDRICKSON TRUCK REPLACEMENT PARTS

TIE ROD TUBE ENDS continued	PART No.	DESCRIPTION	REPLACES
 <p>SH2160</p>	SH2160	Spacer End, Taper Pin, 35" Kit	Automann - TMRN690 Dayton - 345-690 Hendrickson - 66690-000H
	SH2161	Inner Sleeve Rod Kit Navistar	Automann - TMRN701 Dayton - 345-701 Euclid - E-10319 Hendrickson - 66701-000H

TORQUE ROD BUSHINGS	PART No.	DESCRIPTION	REPLACES
 <p>SH2165</p>	SH2165	Torque Rod Bushing	Automann - TRB6175 Dayton - 321-366 Euclid - E-10322 Hendrickson - 69210-000H
	SH2166	Tapered Stud Cartridge 1-1/4" 12TPI, OD = 2-3/4" Stud Shoulder = 3" 400/460 Series	Automann - TRB6112 Dayton - 321-133 Euclid - E-2228 Hendrickson - 44697-000L
 <p>SH2166</p>	SH2167	Straddle Mount Cartridge OD 2-17/32", Hole Dia = 5/8" C to C = 4-3/8" 340 Series	Automann - TRB6164 Dayton - 321-131 Euclid - E-2225 Hendrickson - 44694-000L
	SH2168	Straddle Mount Cartridge OD = 2-3/4", Hole Dia = 5/8" C to C = 4-3/8" 400/460 Series	Automann - TRB6164 Dayton - 321-132 Euclid - E-2226 Hendrickson - 44695-000L
 <p>SH2168</p>	SH2169	Straddle Mount Cartridge OD = 2-3/4", Hole Dia = 3/4" C to C = 4-3/8" 400/460 Series	Automann - TRB6822 Dayton - 321-265 Euclid - E-3868 Hendrickson - 49210-000
	SH2170	Straddle Mount Cartridge OD = 2-3/4", Hole Dia = 5/8" C to C = 4-3/8" 400/460 Series	Automann - TRB6165 Dayton - 321-279 Euclid - E-9395 Hendrickson - 57256-000
 <p>SH2172</p>	SH2171	Straddle Mount Cartridge OD = 2", C to C = 4-3/8" 400/460 Series	Automann - TRB5035 Hendrickson - 48304-000
	SH2172	Straddle Mount Cartridge OD = 2", C to C = 4-3/8" 4 Spring Suspension	Automann - TRB6185 Dayton - 321-223 Euclid - E-5275 Hendrickson - 47691-000L
 <p>SH2174</p>	SH2173	Hollow Sleeve Cartridge OD = 3", ID = 1-1/8", L = 3-1/4" Navistar	Automann - TRB6186 Dayton - 321-141 Euclid - E-2238 Hendrickson - 45477-000L
	SH2174	Ultra Rods 400/460 Series	Automann - TRB6179 Dayton - 321-360 Euclid - E-10309 Hendrickson - 64697-000H



HENDRICKSON TRUCK REPLACEMENT PARTS

HARDWARE	PART No.	DESCRIPTION	REPLACES
      	SH2178	Cross Tube 44.88"	Automann - MCT6 Dayton - 334-113 Euclid - E- 1824 Hendrickson - 44643-009L
	SH2179	Saddle Cap Stud 7/8"-14TPI L = 4-3/16" 380/440 Series	Automann - MSK640 Euclid - E- 1830 Hendrickson - 06696-000
	SH2180	RT Top Pad 401 Series	Automann - M978 Dayton - 338-108 Euclid - E- 1869 Hendrickson - 35064-000
	SH2185	Spherical Washer	Automann - WA51 Euclid - E- 3738 Hendrickson - 48574-000
	SH2189	Top Pad Bolt 1"-14 x 9.5" Grade 8	Automann - M4812 Dayton - 327-113 Hendrickson - 30550-004
	SH2191	Top Pad Bolt 1"-14 x 10" Grade 8	Automann - M5102 Dayton - 327-114 Euclid - E- 1856 Hendrickson - 30550-006
	SH2193	Top Pad Bolt 1"-14 x 10.50" Grade 8	Dayton - 327-115 Hendrickson - 30550-008
	SH2195	Top Pad Bolt 1"-14 x 11" Grade 8	Automann - M5304 Dayton - 327-116 Hendrickson - 30550-010
	SH2197	Vertical Drive Bushing OD = 4-1/8", ID = 2", L = 4" RS340/520 Series	Automann - TRB5170 Dayton - 321-125 Euclid - E-1940 Hendrickson - 19279-000L
	SH2198	Bolt Retainer C to C = 5" E4/340/380/360/400 Series	Automann - MHS60 Dayton - 334-525 Euclid - E5274 Hendrickson - 47459-000
	SH2199	Bar Pin Bushing Assembly Non-Shim Type Kit	Automann - BP198 Dayton - 334-830 Euclid - E-9325 Hendrickson - 34013-087L
	SH2200	Bar Pin Bushing Assembly Shim Type Kit	Automann - BP200 Dayton - 334-831 Euclid - E-9326 Hendrickson - 34013-088L
	SH2201	Spring Eye Pin OD = 1-3/8", L = 6-7/8" 340/400/460 Series	Automann - M5240 Dayton - 327-437 Euclid - E-3761 Hendrickson - 43146-000L



A PARTNER YOU CAN COUNT ON

HENDRICKSON TRUCK REPLACEMENT PARTS

HARDWARE continued	PART No.	DESCRIPTION	REPLACES
 <p style="text-align: right;">SH2202</p>	SH2202	Spring Eye Drawkey Kit RT 400/RU 340 Series	Automann - MLP458 Dayton - 334-112 Euclid - E-1819 Hendrickson - 00062-001L
	SH2203	Rebound Bolt Assembly Kit	Automann - MHS80 Dayton - 334-100 Euclid - E-9428 Hendrickson - 29828-023
<p>SH2204</p> 	SH2204	Torque Rod Bracket	Automann - M919 Dayton - 338-181 Euclid - E-2634 Hendrickson - 22186-000



NEW FASTENERS

PART No.	DESCRIPTION	PART No.	DESCRIPTION
SF16100	1/4-20x1/2 HHCS GR8 ZY PACKAGED IN 50	SF34422	#8-32x1 PHIL PAN HD MACH SCR ZP PACKAGED IN 50
SF16102	1/4-20x3/4 HHCS GR8 ZY PACKAGED IN 50	SF34437	#10-24x1 PHIL PAN HD MACH SCR ZP PACKAGED IN 50
SF16104	1/4-20x1 HHCS GR8 ZY PACKAGED IN 50	SF34451	#10-32x1 PHIL PAN HD MACH SCR ZP PACKAGED IN 50
SF16106	1/4-20x1-1/2 HHCS GR8 ZY PACKAGED IN 50	SF34469	1/4-20x1 PHIL PAN HD MACH SCR ZP PACKAGED IN 50
SF16108	1/4-20x2 HHCS GR8 ZY PACKAGED IN 50	SF40150	1/4-20 FIN HX NUT GR8 ZY PACKAGED IN 50
SF16121	5/16-18x1/2 HHCS GR8 ZY PACKAGED IN 50	SF40152	5/16-18 FIN HX NUT GR8 ZY PACKAGED IN 50
SF16123	5/16-18x3/4 HHCS GR8 ZY PACKAGED IN 50	SF40154	3/8-16 FIN HEX NUT GR8 ZY PACKAGED IN 50
SF16125	5/16-18x1 HHCS GR8 ZY PACKAGED IN 50	SF40156	7/16-14 FIN HEX NUT GR8 ZY PACKAGED IN 50
SF16127	5/16-18x1-1/2 HHCS GR8 ZY PACKAGED IN 50	SF40158	1/2-13 FIN HEX NUT GR8 ZY PACKAGED IN 50
SF16129	5/16-18x2 HHCS GR8 ZY PACKAGED IN 50	SF40362	3/4-10 FIN HEX NUT GR8 PLAIN PACKAGED IN 25
SF16131	5/16-18x2-1/2 HHCS GR8 ZY PACKAGED IN 50	SF40918	5-8-11 HEX SERRATED FLANGE NUT CASE HARD ZP PACKAGED IN 50
SF16146	3/8-16x3/4 HHCS GR8 ZY PACKAGED IN 25	SF41163	3/4-16 FIN HEX NUT GR8 PACKAGED IN 25
SF16148	3/8-16x1 HHCS GR8 ZY PACKAGED IN 25	SF42319	3/4-10 NE NYLON INSERT LOCK NUT GrC ZY PACKAGED IN 25
SF16150	3/8-16x1-1/2 HHCS GR8 ZY PACKAGED IN 25	SF43121	3/4-16 NE NYLON INSERT LOCK NUT GrC ZY PACKAGED IN 25
SF16152	3/8-16x2 HHCS GR8 ZY PACKAGED IN 25	SF53102	#8-32 HEX MACHINE SCREW NUT GR2 ZP PACKAGED IN 100
SF16154	3/8-16x2-1/2 HHCS GR8 ZY PACKAGED IN 25	SF53103	#10-32 HEX MACHINE SCREW NUT GR2 ZP PACKAGED IN 100
SF16171	7/16-14x3/4 HHCS GR8 ZY PACKAGED IN 25	SF53104	#10-24 HEX MACHINE SCREW NUT GR2 ZP PACKAGED IN 100
SF16172	7/16-14x1 HHCS GR8 ZY PACKAGED IN 25	SF53106	1/4-20 HEX MACHINE SCREW NUT GR2 ZP PACKAGED IN 100
SF16174	7/16-14x1-1/2 HHCS GR8 ZY PACKAGED IN 25	SF61376	#8-15x1 PHIL PAN HD TAPPING SCR TYPE A ZP PACKAGED IN 50
SF16176	7/16-14x2 HHCS GR8 ZY PACKAGED IN 25	SF61387	#10-12x1 PHIL PAN HD TAPPING SCR TYPE A ZP PACKAGED IN 50
SF16195	1/2-13x3/4 HHCS GR8 ZY PACKAGED IN 25	SF61399	#12-11x1 PHIL PAN HD TAPPING SCR TYPE A ZP PACKAGED IN 50
SF16196	1/2-13x1 HHCS GR8 ZY PACKAGED IN 25	SF61411	#14-10x1 PHIL PAN HD TAPPING SCR TYPE A ZP PACKAGED IN 50
SF16198	1/2-13x1-1/2 HHCS GR8 ZY PACKAGED IN 25	SF69157	#10x1 UNSLOT IND HWH SELF DRILL SCR No3 BSD ZP PACKAGED IN 50
SF16200	1/2-13x2 HHCS GR8 ZY PACKAGED IN 25	SF69160	#12x1 UNSLOT IND HWH SELF DRILL SCR No3 BSD ZP PACKAGED IN 50
SF16202	1/2-13x2-1/2 HHCS GR8 ZY PACKAGED IN 25	SF69162	#14x1 UNSLOT IND HWH SELF DRILL SCR No3 BSD ZP PACKAGED IN 50
SF16275	3/4-10x6 HHCS GR8 PLAIN PACKAGED IN 25		



MUD FLAP HANGER KITS

A Partner You Can Count On

MFB25K



INCLUDES TWO HANGERS, TWO BRACKETS, AND MOUNTING HARDWARE

REPLACES BETTS B25

INDIVIDUAL HANGERS ALSO
SOLD SEPERATELY
MFB25

MFB35K

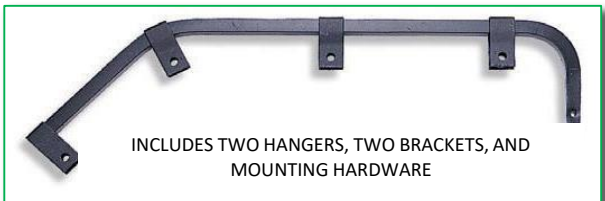

INCLUDES TWO HANGERS, TWO BRACKETS, AND MOUNTING HARDWARE

REPLACES BETTS B35

INDIVIDUAL HANGERS ALSO
SOLD SEPERATELY
MFB35

MFMB711

BRACKET ONLY



INCLUDES TWO BRACKETS
AND MOUNTING HARDWARE

REPLACES BETTS B711

MFMB711K

REPLACES BETTS K711

Manufactures' and replacement parts suppliers' names and numbers are used for reference purposes only, and, it is not implied any part listed is a product of these manufacturers or suppliers



A Partner You Can Count On

CONSPICUITY MUD FLAP PLATES NOW AVAILABLE

Part# MFCP25-2



CONTAINS 2 STRAIGHT PLATES

REPLACES:

BETTS RT25

FLEET ENGINEERS 033-04259 (1 PLATE)

GLOBETECH GT-27RT25

Part# MFCP35-2



CONTAINS 2 ANGLED PLATES

REPLACES:

BETTS RT35

FLEET ENGINEERS 033-04263 (1 PLATE)

GLOBETECH GT-27RT35

Manufacturers' and replacement parts suppliers' names and numbers are used for reference purposes only, and it is not implied any part listed is a product of these manufacturers or suppliers.

Rubber Air Lines



A3015

**15' Rubber Air Lines w/
Red and Blue Grips**

Replaces:

Phillips 11-8115
Sloan 455168R/B
Tectran 16915R/B





Additional Products Added to Our Flags and Banners

A partner you can count on.

1318

NEW FLAGS AND BANNERS



WF1009RK



Heavy Duty 18" x 18" Mesh Flag



Stainless Steel Mounting Bracket and Spring



Included Mounting Kit allows installation at 40° and 90°

Sirco Part No.	Description
WB1004	18" x 84" Reflective "Oversize Load" banner w/ bungee
WF1009RK	18" x 18" Red safety flag with quick mount kit
WF1010OK	18" x 18" Orange safety flag with quick mount kit
WF1011RR	Replacement (flag only) for WF1009RK
WF1012OR	Replacement (flag only) for WF1010OK

Manufacturers' and replacement parts suppliers' names and numbers are used for reference purposes only, and, it is not implied any part listed is a product of these manufacturers or suppliers.



A Partner You Can Count On

BANNERS AND FLAGS

122017



PART DESCRIPTION	PART NUMBER
18" x 84" Mesh Oversize Load Banner w/Grommets & Rope	WB1000
18" x 84" Solid Vinyl Oversize Load/Wide Load Banner w/6 Grommets & Rope	WB1001
18" x 84" Mesh Oversize Load Banner w/Bungee	WB1002
18" x 18" Red Jersey Flag with 3/4" X 30" Dowel	WF1000DR
18" x 18" Orange Jersey Flag with 3/4" X 30" Dowel	WF1001DO
18" x 18" Red Jersey Flag w/Grommets	WF1002GR
18" x 18" Orange Jersey Flag w/Grommets	WF1003GO
18" x 18" Red Jersey Flag w/Wire Loop	WF1004WR
Magnet Flag Holder (90#)	WF1005MG
18" x 18" Orange Jersey Flag w/Wire Loop	WF1006WO
18" x 18" Red Jersey Flag w/Bungee	WF1007BR
18" x 18" Orange Jersey Flag w/Bungee	WF1008BO
3' x 5' U.S. Flag (Poly) With Grommets	USFLAG



NEW RUBBER MUD FLAPS NOW AVAILABLE

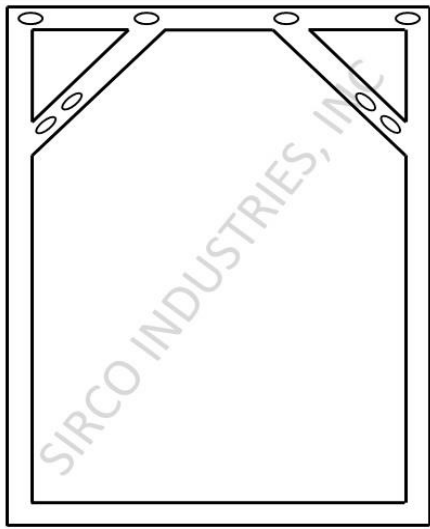

3/8" RUBBER MUD FLAP

SIRCO	DESCRIPTION
MF2424RHD	24" X 24" RUBBER MUD FLAP
MF2430RHD	24" X 30" RUBBER MUD FLAP
MF2436RHD	24" X 36" RUBBER MUD FLAP

WIRE NYLON MESH MOLDED INTO FLAP

ORDER YOURS TODAY!

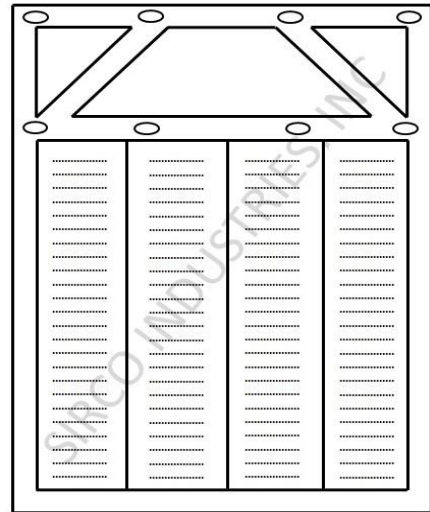

1/2" RUBBER MUD FLAP – ANTI SPRAY

SIRCO	DESCRIPTION
MF2424RXHD	24" X 24" RUBBER MUD FLAP
MF2430RXHD	24" X 30" RUBBER MUD FLAP
MF2436RXHD	24" X 36" RUBBER MUD FLAP
MF2440RXHD	24" X 40" RUBBER MUD FLAP
MF2442RXHD	24" X 42" RUBBER MUD FLAP

RAISED RUBBER KNOBS ON BACK FOR ANTI-SPRAY

COMPOSITE RUBBER MUD FLAPS

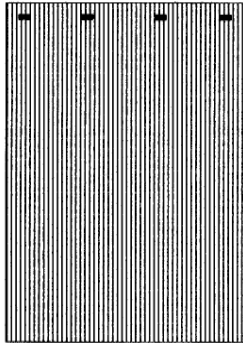

DEEP GROOVE "COMPOSITE RUBBER" ANTI-SPRAY 1/2" THICK	
SIRCO	DESCRIPTION
MF2424R12	24 x 24 COMPOSITE RUBBER
MF2430R12	24 x 30 COMPOSITE RUBBER
MF2436R12	24 x 36 COMPOSITE RUBBER
MF2440R12	24 x 40 COMPOSITE RUBBER
MF2442R12	24 x 42 COMPOSITE RUBBER
MF2444R12	24 x 44 COMPOSITE RUBBER

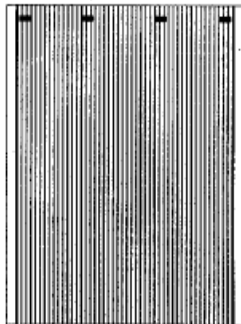

RIBBED "COMPOSITE RUBBER" ANTI-SPRAY 3/8" THICK	
SIRCO	DESCRIPTION
MF2424R38	24 x 24 COMPOSITE RUBBER
MF2430R38	24 x 30 COMPOSITE RUBBER
MF2436R38	24 x 36 COMPOSITE RUBBER

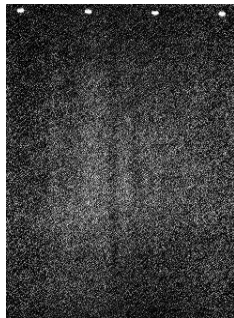

TEXTURED "COMPOSITE RUBBER" 3/16" THICK	
SIRCO	DESCRIPTION
MF2424R316	24 x 24 COMPOSITE RUBBER
MF2430R316	24 X 30 COMPOSITE RUBBER
MF2436R316	24 X 36 COMPOSITE RUBBER



"A PARTNER YOU CAN COUNT ON"

122017

Mud Flaps



POLY HEAVY DUTY BLACK .320 THICKNESS	
SIRCO	DESCRIPTION
MF2424PHDB	24 x 24 Poly Heavy Duty Black
MF2430PHDB	24 x 30 Poly Heavy Duty Black
MF2436PHDB	24 x 36 Poly Heavy Duty Black

POLY MUD FLAPS .170 THICKNESS	
SIRCO	DESCRIPTION
MF2424PSB	24 x 24 Poly Black
MF2424PSW	24 x 24 Poly White
MF2430PSB	24 x 30 Poly Black
MF2430PSW	24 x 30 Poly White
MF2436PSB	24 x 36 Poly Black
MF2436PSW	24 x 36 Poly White

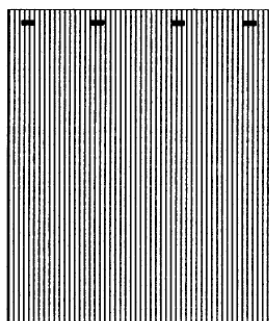

ANTI-SPRAY POLY MUD FLAPS .25 THICKNESS	
SIRCO	DESCRIPTION
MF2424PASB	24 x 24 Poly Anti-Spray Black
MF2424PASW	24 x 24 Poly Anti-Spray White
MF2430PASB	24 x 30 Poly Anti-Spray Black
MF2430PASW	24 x 30 Poly Anti-Spray White
MF2436PASB	24 x 36 Poly Anti-Spray Black
MF2436PASW	24 x 36 Poly Anti-Spray White

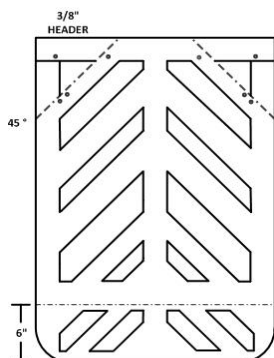

CHEVRON "RUBBER" MUD FLAPS .215 THICKNESS	
SIRCO	DESCRIPTION
MF2424RC	24 x 24 Chevron Black
MF2430RC	24 x 30 Chevron Black
MF2436RC	24 x 36 Chevron Black



"A PARTNER YOU CAN COUNT ON"

CAUTION WIDE TURNS MUD FLAP



SIRCO	DESCRIPTION
MF2430PCWT	24" X 30" X .150" YELLOW POLY MUD FLAP