

Monarc Canopy™

9' x 16' / 2,7 x 4,9 m

#25866

TEMPORARY STRUCTURE

 = Helpful information

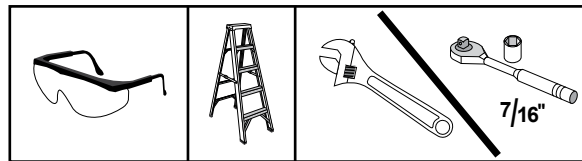
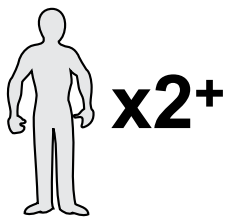
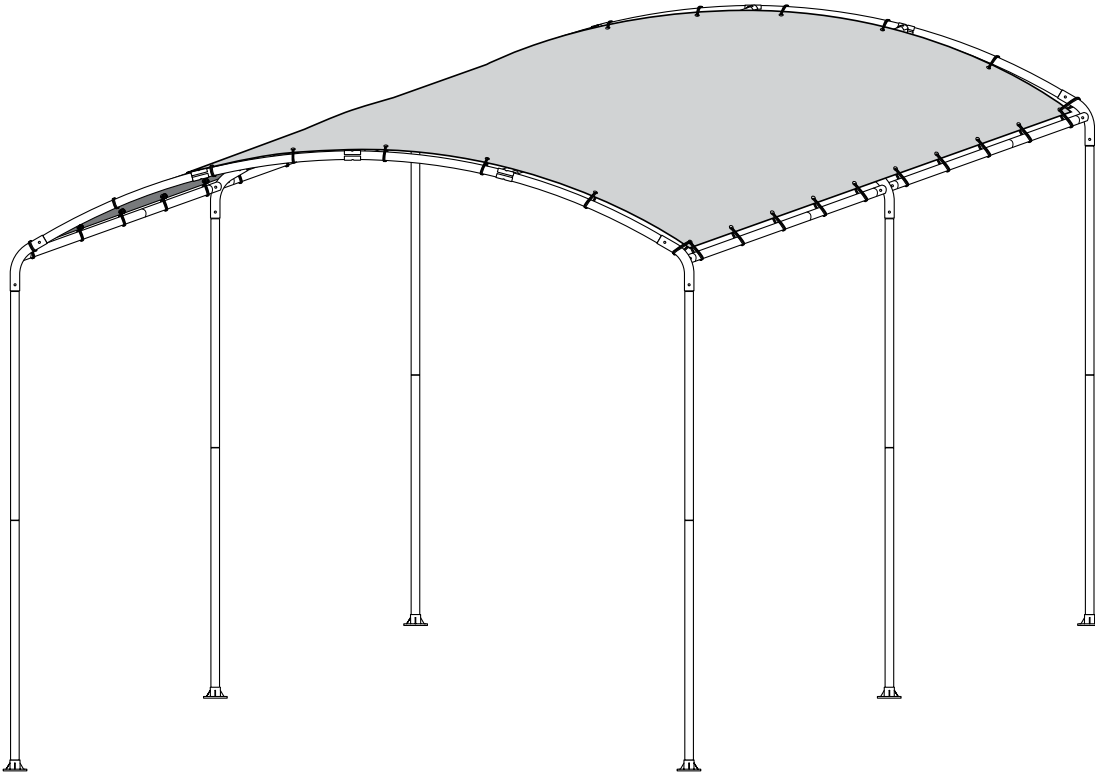

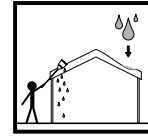

ATTENTION: This shelter product is manufactured with quality materials. It is designed to fit the **ShelterLogic®** Corp. custom fabric cover included. **ShelterLogic® Corp.** Shelters offer storage and protection from damage caused by sun, light rain, tree sap, animal - bird excrement and light snow. Please anchor this **ShelterLogic® Corp.** structure properly. See manual for more anchoring details. Proper anchoring, keeping cover tight and free of snow and debris is the responsibility of the consumer. Please read and understand the installation detail, warnings and cautions prior to beginning installation. If you have any questions call the customer service number listed below. Please refer to the warranty card inside this package.

DANGER: Prior to installation, consult with all local municipal codes regarding installation of temporary shelters. Choose the location of your shelter carefully. ***DANGER: Keep away from electrical wires.*** Check for overhead utility lines, tree branches or other structures. Check for underground pipes or wires before you dig. **DO NOT** install near roof lines or other structures that could shed snow, ice or excessive run off onto your shelter. **DO NOT** hang objects from the roof or support cables.

WARNING: Risk of fire. **DO NOT** smoke or use open flame devices (including grills, fire pits, deep fryers, smokers or lanterns, etc.) in or around the shelter. **DO NOT** store flammable liquids (gasoline, kerosene, propane, etc.) in or around your shelter. Do not expose top or sides of the shelter to open fire or other flame source.

CAUTION: Use **CAUTION** when erecting the frame. Use safety goggles during installation. Secure and bolt together overhead poles during assembly. Be aware of pole ends.

PROPER ANCHORING AND INSTALLATION OF FRAME: PROPER ANCHORING OF THE FRAME IS THE RESPONSIBILITY OF THE CONSUMER.

ShelterLogic® Corp. is not responsible for damage to the unit or the contents from acts of nature. Any shelter that is not anchored securely has the potential to fly away causing damage, and is not covered under the warranty. Periodically check the anchors to ensure stability of shelter. **ShelterLogic® Corp.** cannot be responsible for any shelter that blows away. **NOTE:** Your shelter's cover can be quickly removed and stored prior to severe weather conditions. If strong winds or severe weather is forecast in your area, we recommend removal of cover.

REPLACEMENT PARTS, ASSEMBLY, SPECIAL ORDERS: **Genuine ShelterLogic® Corp.** replacement parts and accessories are available from the factory, including anchoring kits for nearly any application, replacement covers, wall and enclosure kits, vent and light kits, frame parts, zippered doors and other accessories. All items are shipped factory direct to your door.

CARE AND CLEANING: A tight cover ensures longer life and performance. Always maintain a tight cover. Loose fabric can accelerate deterioration of cover fabric. Immediately remove any accumulated snow or ice from the roof structure with a broom, mop or other soft-sided instrument. Use extreme caution when removing snow from cover- always remove from outside the structure. **DO NOT** use hard-edged tools or instruments like rakes or shovels to remove snow. This could result in punctures to the cover. **DO NOT** use bleach or harsh abrasive products to clean the fabric cover. Cover is easily cleaned with mild soap and water.

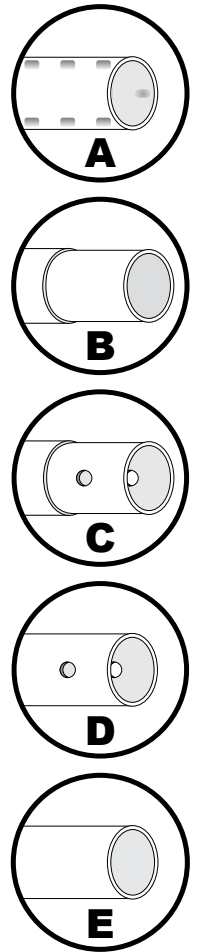
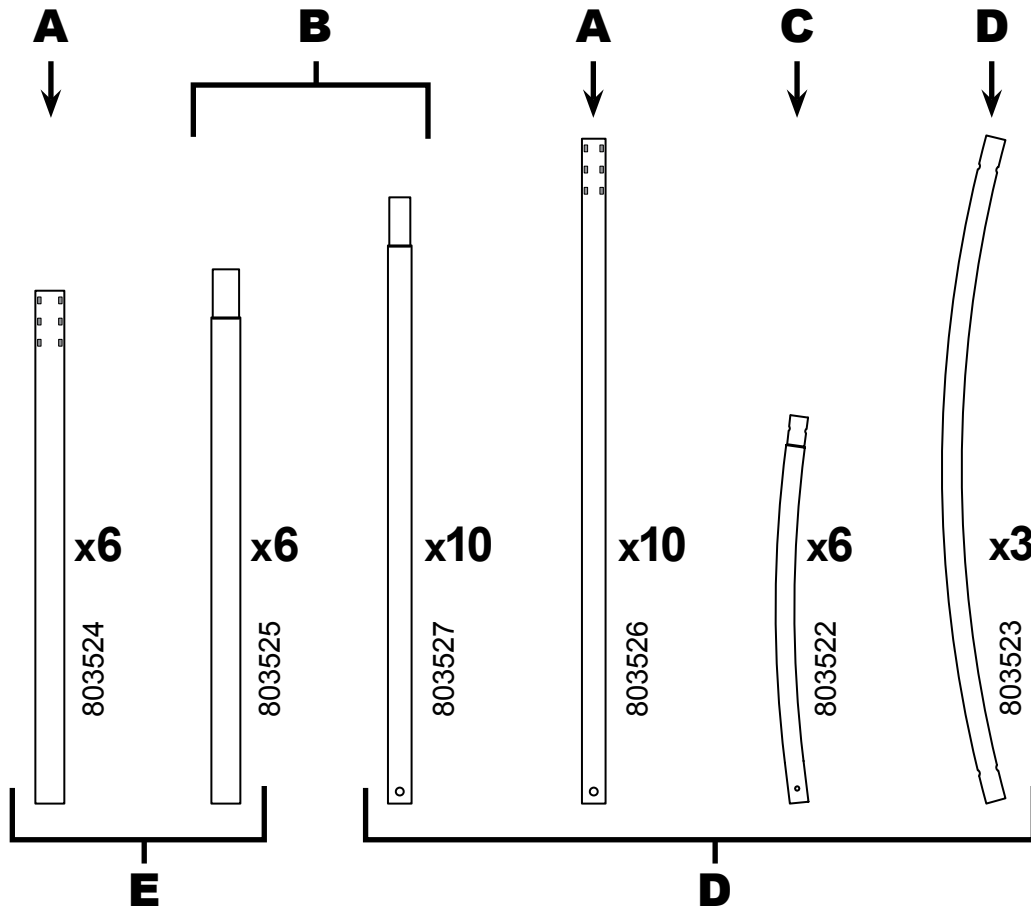
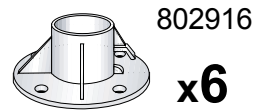
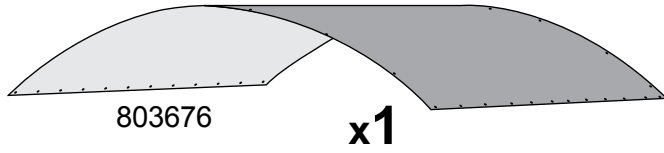
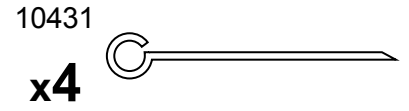
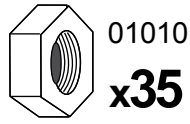
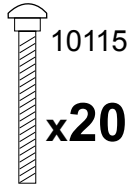
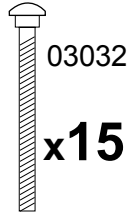
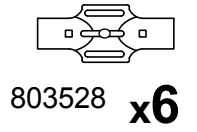
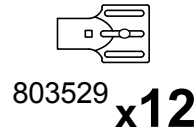
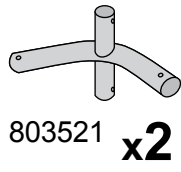
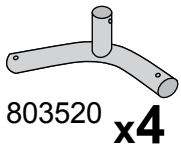

1.

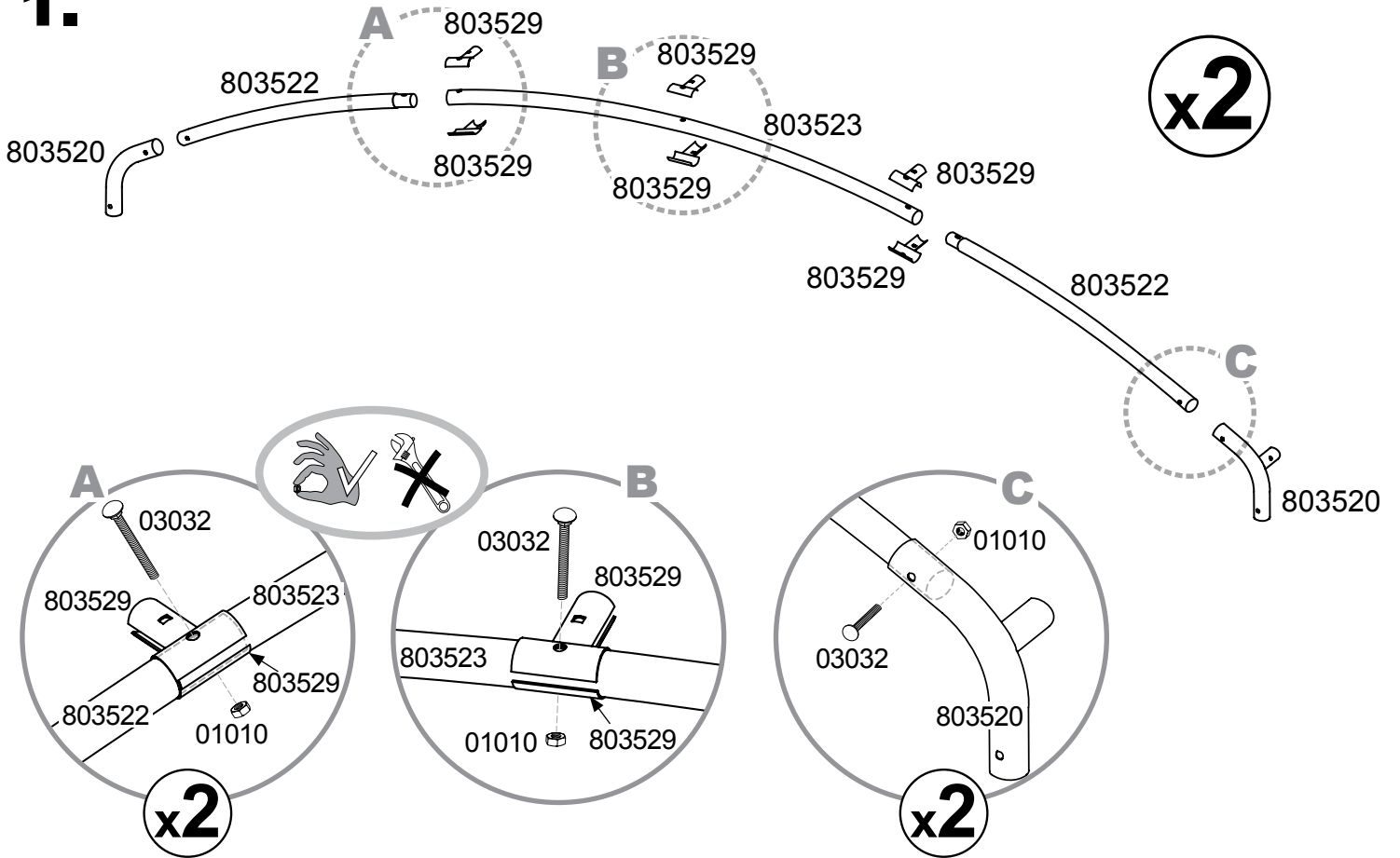

2.

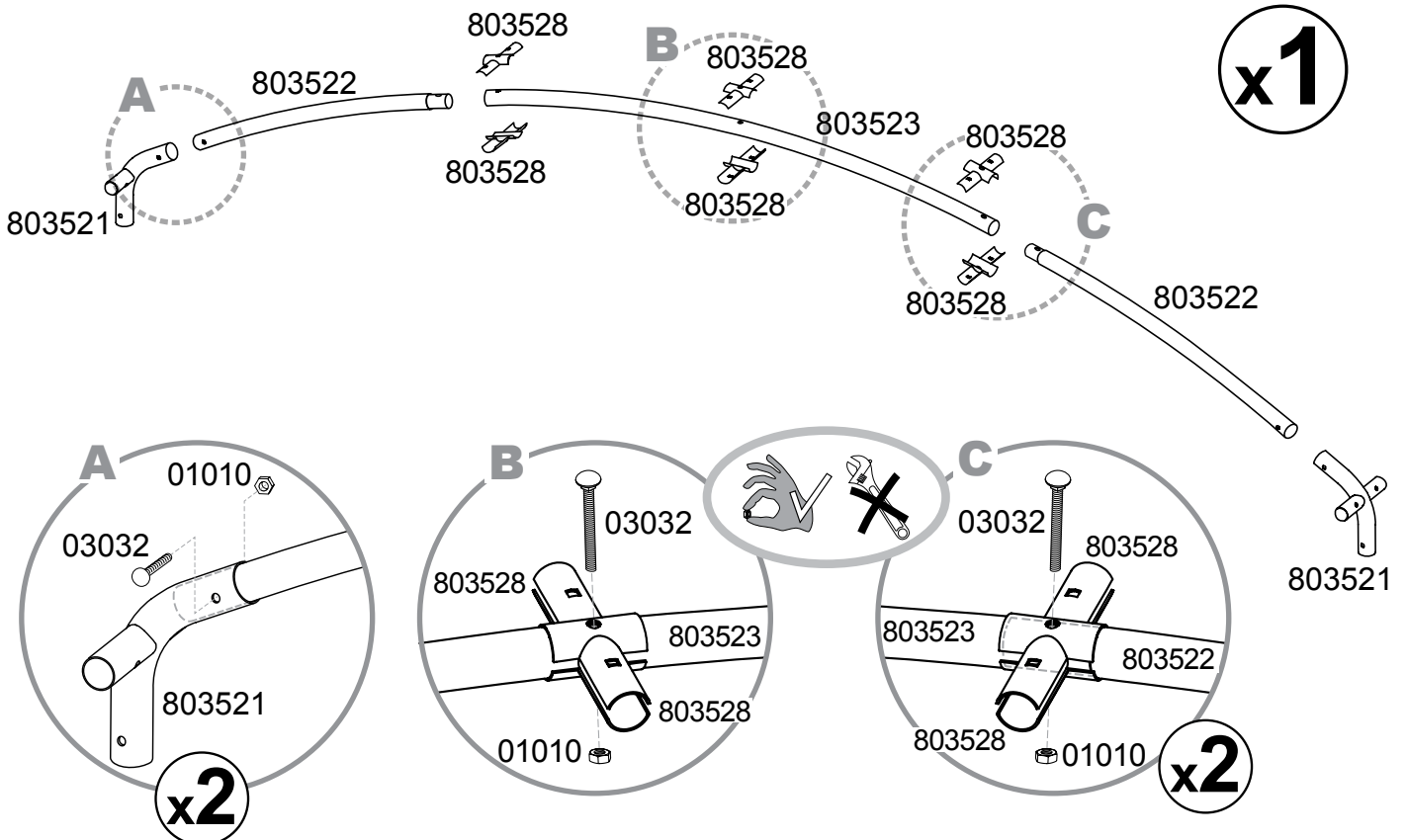

3.

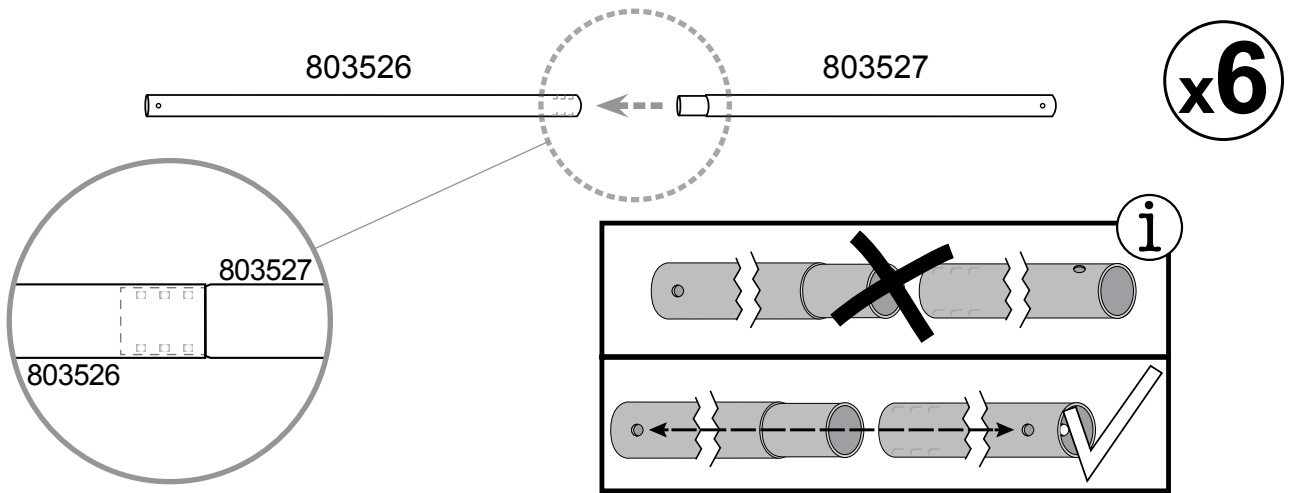

4.

a.

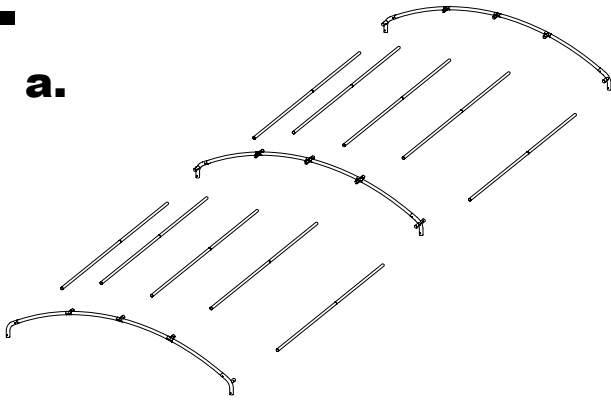

b.

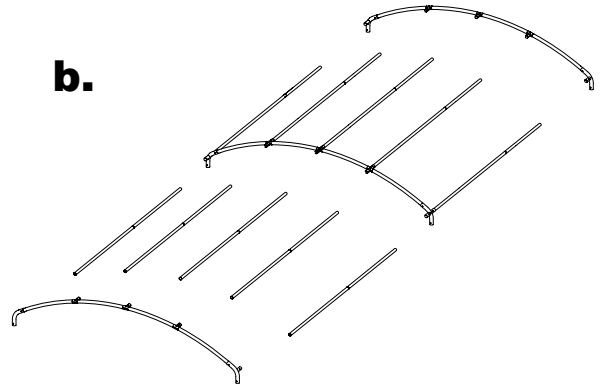

c.

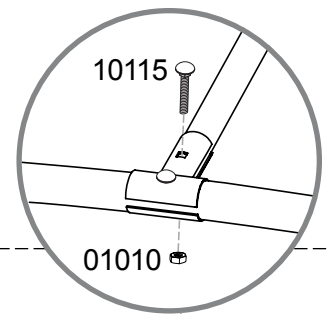
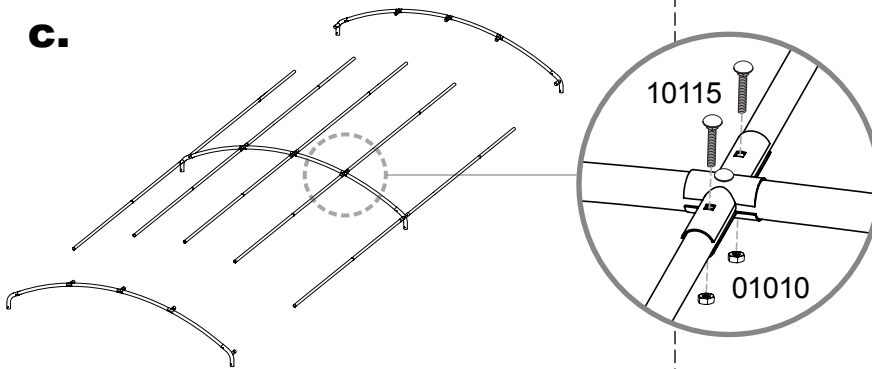

d.

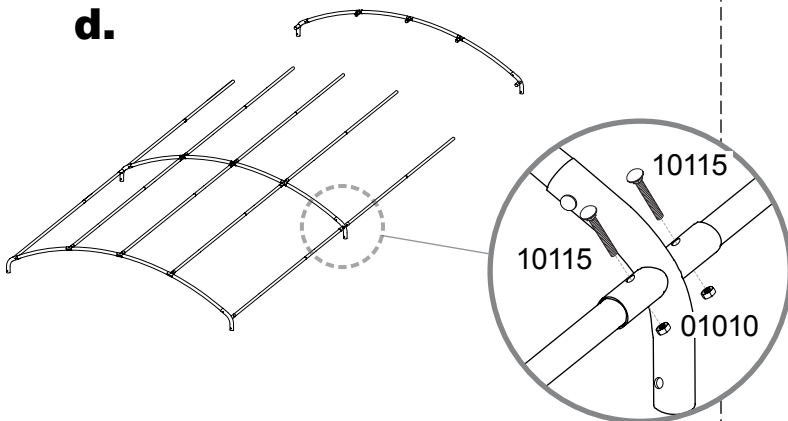

e.

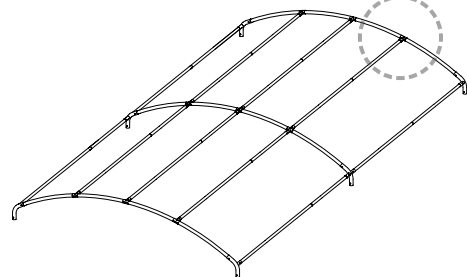

5.

a.

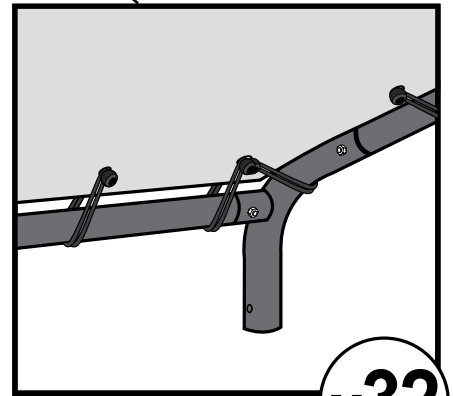
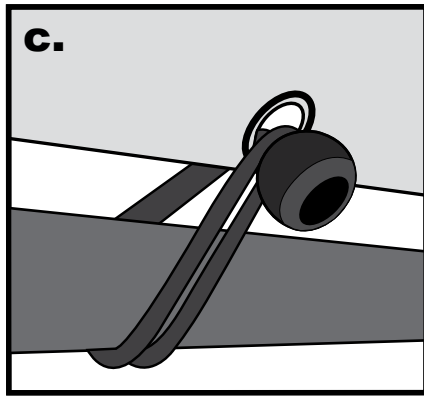
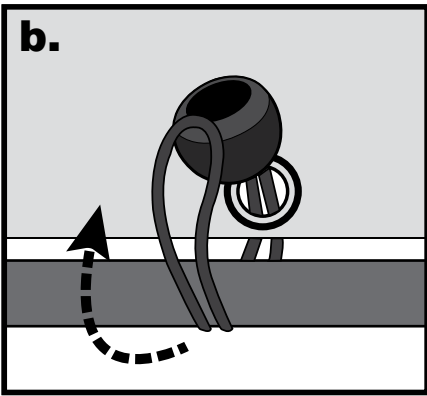
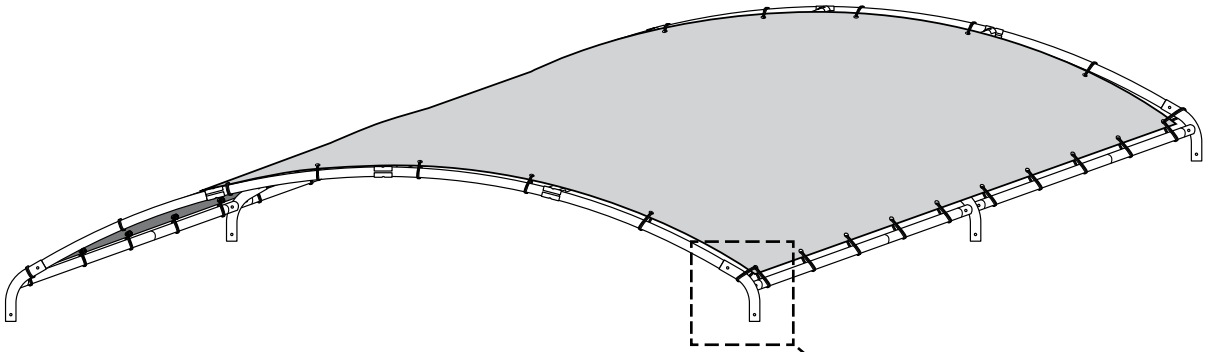
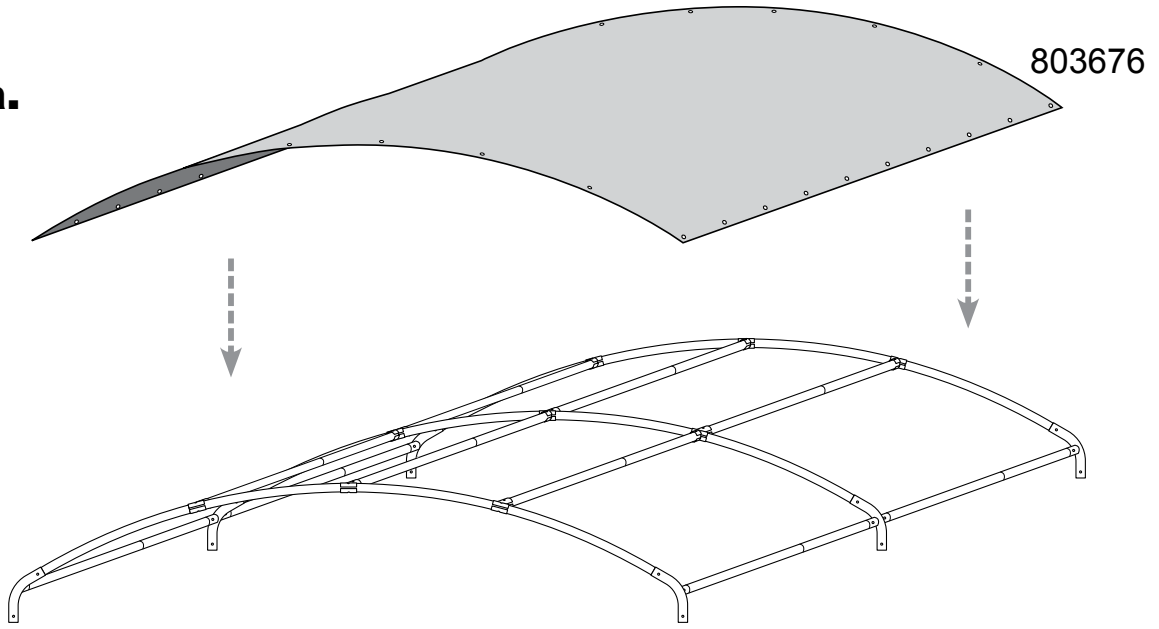

6.

a.

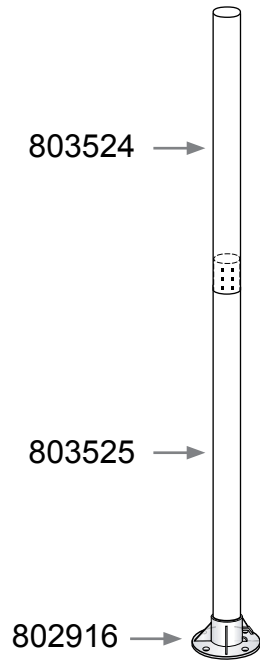

x6

b.

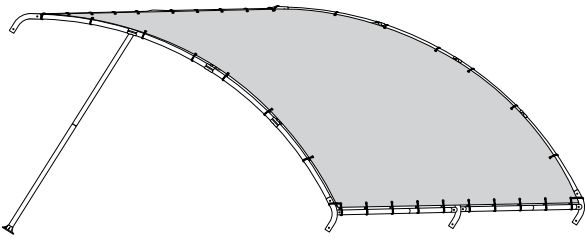

c.

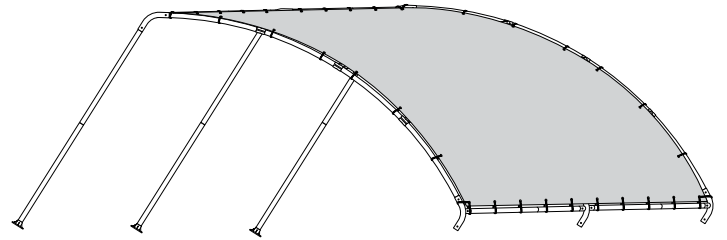

d.

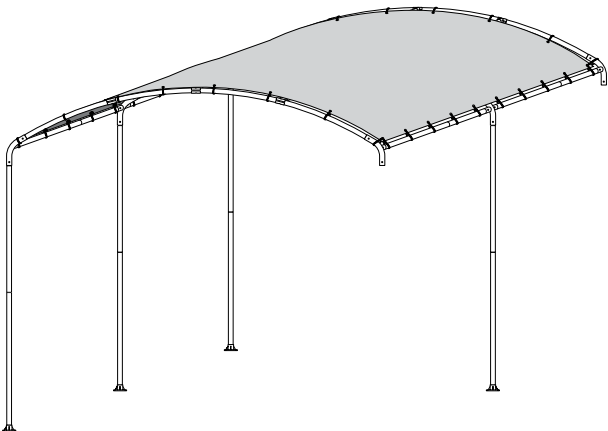

e.

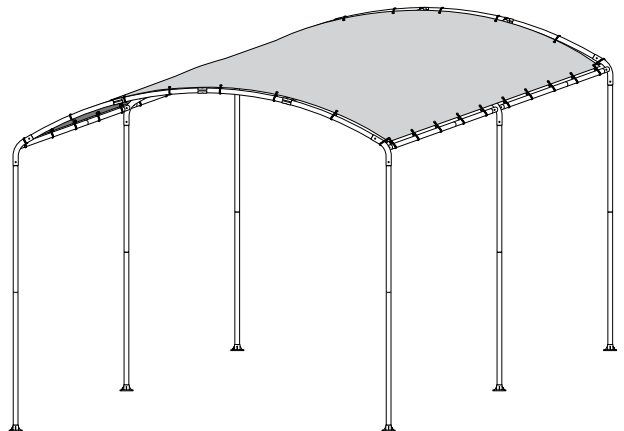

ANCHOR GUIDE

ShelterLogic shelters, canopies and garages come with a basic “install” end rib anchor kit to secure and square-up the frame during installation. In most situations, additional anchors are recommended. ShelterLogic suggests one anchor per leg.

SHEDS, GARAGES, GREENHOUSES, STORAGE SHELTERS

CANOPIES, POP-UP CANOPIES



Anchors not shown to scale.

| | A | B | C | D | E | C | F | G |
|-----------------------------------|---|---|---|---|---|---|---|---|
| PACKED SOIL | ✓ | ✓ | ✓ | | | ✓ | ✓ | ✓ |
| SAND | ✓ | ✓ | ✓ | | | ✓ | | ✓ |
| GRAVEL | ✓ | ✓ | | | | | ✓ | ✓ |
| CLAY | ✓ | ✓ | ✓ | | | ✓ | ✓ | ✓ |
| ASPHALT Drill hole in asphalt | ✓ | ✓ | | | | | ✓ | ✓ |
| CONCRETE Embed in wet concrete | | | ✓ | ✓ | | ✓ | | ✓ |
| WOOD | | | | | ✓ | | | ✓ |



A EasyHook™



B Ratchet Tite™



C ShelterAuger™



D Concrete Anchors



E Lag Bolts



F Stake Anchors



G Pop-Up Canopy Anchor Bag

04012015

7.

